



SIEMENS



Industrial  
Communication











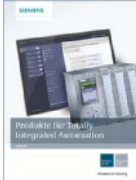

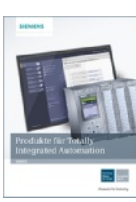

SIMATIC NET

Catalog  
IK PI

Edition  
2015

Answers for industry.

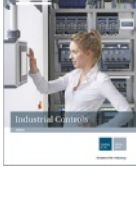
## Related catalogs

<p><b>SIMATIC</b> Products for Totally Integrated Automation</p> <p>E86060-K4670-A101-B4-7600</p>	<p>ST 70</p> 	<p><b>Motion Control</b> SIMOTION, SINAMICS S120 &amp; SIMOTICS Equipment for Production Machines</p> <p>E86060-K4921-A101-A3-7600</p>	<p>PM 21</p> 
<p><b>SIMATIC</b> Products for Totally Integrated Automation</p> <p>E86060-K4670-A151-A7-7600</p>	<p>ST 70 N</p> 	<p><b>Motion Control</b> SINUMERIK &amp; SINAMICS Equipment for Machine Tools</p> <p>E86060-K4461-A101-A3-7600</p>	<p>NC 61</p> 
<p><b>SIMATIC HMI / PC-based Automation</b> Human Machine Interface Systems PC-based Automation</p> <p>E86060-K4680-A101-C2-7600</p>	<p>ST 80/ST PC</p> 	<p><b>Motion Control Drives</b> SINAMICS Inverters for Single-Axis Drives and SIMOTICS Motors</p> <p>E86060-K5531-A101-A1-7600 E86060-E5531-A101-A1-7600 (News)</p>	<p>D 31</p> 
<p><b>SIMATIC</b> SIMATIC PCS 7 Process Control System</p> <p>E86060-K4678-A111-B9-7600</p>	<p>ST PCS 7</p> 	<p><b>SIMOTICS Low-Voltage Motors</b> Type series 1LE1, 1MB1 and 1PC1 Frame sizes 80 to 315 Power range 0.3 to 250 kW</p> <p>E86060-K5581-A111-A6-7600</p>	<p>D 81.1</p> 
<p><b>SITOP</b> Power supply SITOP</p> <p>E86060-K2410-A111-A9-7600</p>	<p>KT 10.1</p> 	<p><b>Low-Voltage Power Distribution and Electrical Installation Technology</b> SENTRON • SIVACON • ALPHA Protection, Switching, Measuring and Monitoring Devices, Switchboards and Distribution Systems</p> <p>E86060-K8280-A101-A1-7600</p>	<p>LV 10</p> 
<p><b>SIMATIC Ident</b> Industrial Identification Systems</p> <p>E86060-K8310-A101-A9-7600</p>	<p>ID 10</p> 	<p><b>SITRAIN</b> Training for Industry</p> <p>Only available in German</p> <p>E86060-K6850-A101-C4</p>	<p>ITC</p> 
<p><b>Industrial Controls</b> SIRIUS</p> <p>E86060-K1010-A101-A4-7600</p>	<p>IC 10</p> 	<p><b>Products for Automation and Drives</b> Interactive Catalog, DVD</p> <p>E86060-D4001-A510-D4-7600</p>	<p>CA 01</p> 
<p><b>Industry Mall</b> Information and Ordering Platform in the Internet:</p> <p><a href="http://www.siemens.com/industrymall">www.siemens.com/industrymall</a></p>			

# Industrial Communication

## SIMATIC NET

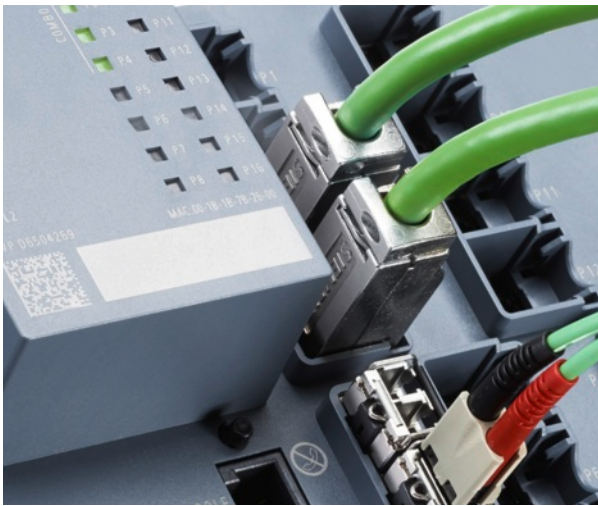

### Catalog IK PI · 2015

Supersedes:  
Catalog IK PI · 2012

Refer to the Industry Mall for current updates of  
this catalog:

[www.siemens.com/industrymall](http://www.siemens.com/industrymall)

The products contained in this catalog can also be found  
in the Interactive Catalog CA 01.

Article No.: E86060-D4001-A510-D3-7600

Please contact your local Siemens branch.

© Siemens AG 2014



Printed on paper from  
sustainably managed forests and  
controlled sources.

[www.pefc.org](http://www.pefc.org)



The products and systems described in  
this catalog are manufactured/distributed  
under application of a certified quality  
management system in accordance with  
DIN EN ISO 9001 (Certified Registration  
Numbers are shown on page 9/19). The cer-  
tificate is recognized by all IQNet countries.

Introduction	1
PROFINET / Industrial Ethernet	2
PROFIBUS	3
AS-Interface	4
IO-Link	5
Industrial Wireless Communication	6
Industrial Remote Communication	7
Industrial Security	8
Appendix	9

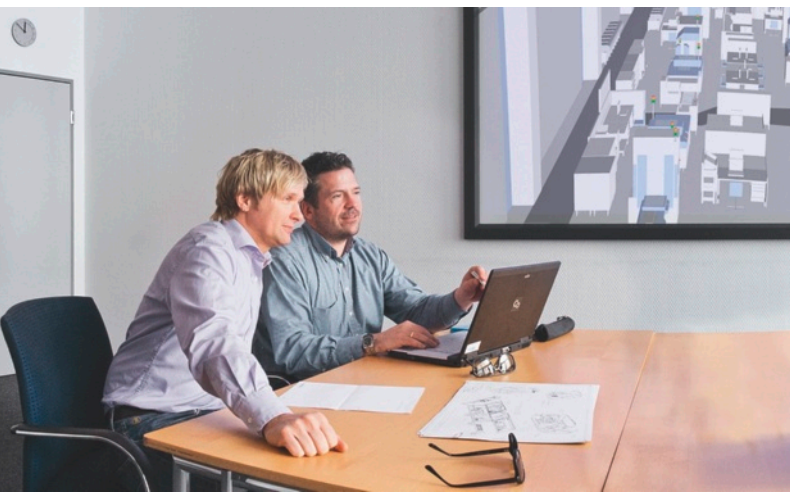



## Answers for industry.

Integrated technologies, vertical market expertise and services for greater productivity, energy efficiency, and flexibility.

The Siemens Industry Sector is the world's leading supplier of innovative and environmentally friendly products and solutions for industrial companies. End-to-end automation technology and industrial software, solid market expertise, and technology-based services are the levers we use to increase our customers' productivity, efficiency and flexibility. With a global workforce of more than 100 000 employees, the Industry Sector comprises the Industry Automation, Drive Technologies, and Customer Services divisions, as well as the Metals Technologies Business Unit.

We consistently rely on integrated technologies and, thanks to our bundled portfolio, we can respond more quickly and flexibly to our customers' wishes. With our globally unmatched range of automation technology, industrial control and drive technology as well as industrial software, we equip companies with exactly what they need over their entire value chain – from product design and development to production, sales and service. Our industrial customers benefit from our comprehensive portfolio, which is tailored to their market and their needs.

Market launch times can be reduced by up to 50% due to the combination of powerful automation technology and industrial software from Siemens Industry. At the same time, the costs for energy or waste water for a manufacturing company can be reduced significantly. In this way, we increase our customers' competitive strength and make an important contribution to environmental protection with our energy-efficient products and solutions.

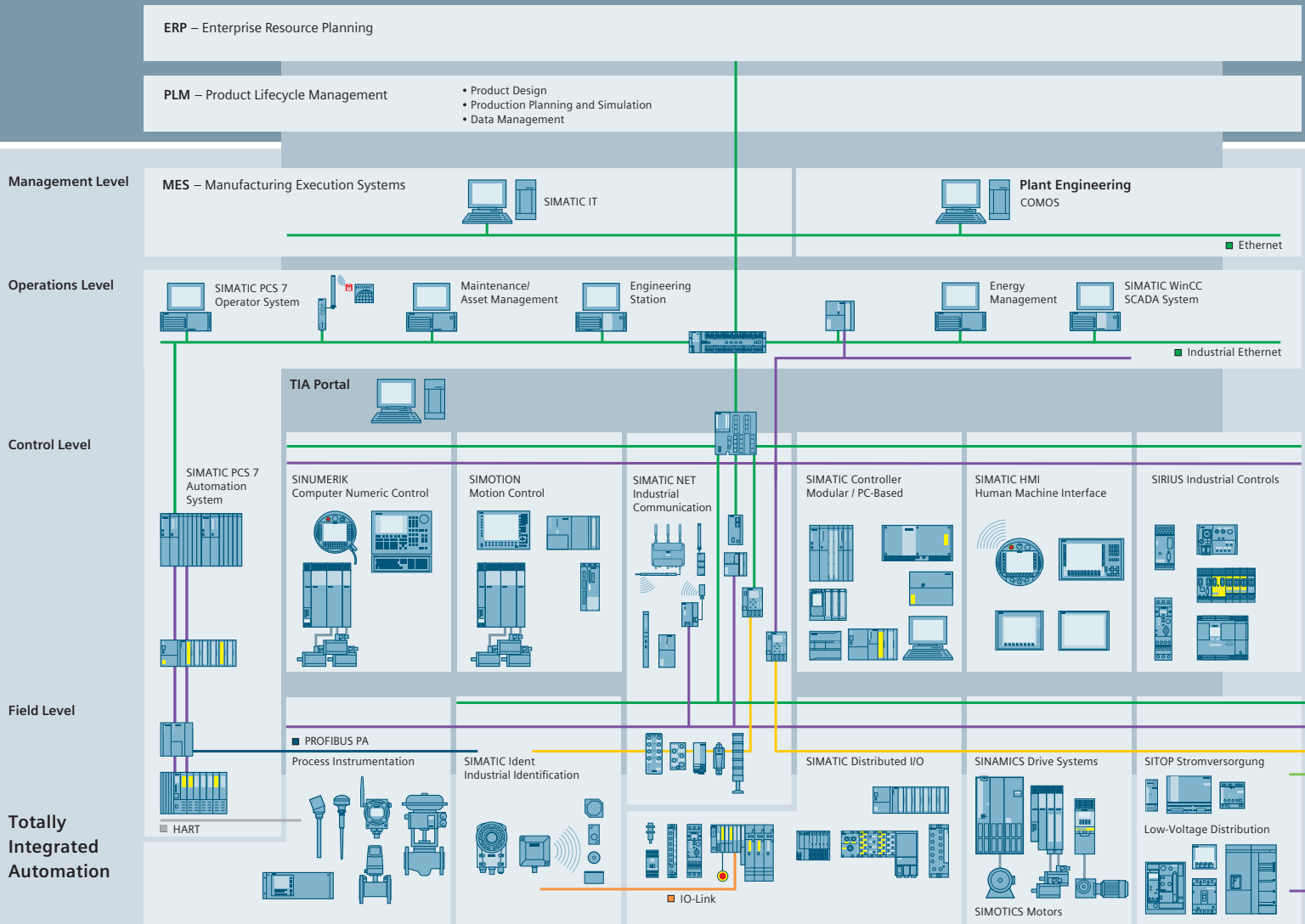

## Efficient automation starts with efficient engineering.

**Totally Integrated Automation: Efficiency driving productivity.**

Efficient engineering is the first step toward better production that is faster, more flexible, and more intelligent. With all components interacting efficiently, Totally Integrated Automation (TIA) delivers enormous time savings right from the engineering phase. The result is lower costs, faster time-to-market, and greater flexibility.

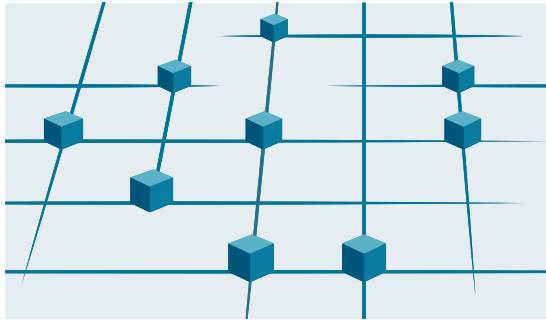

Totally Integrated Automation  
Efficient interoperability of all automation components



■ PROFINET  
■ Industrial Ethernet  
■ PROFIBUS  
■ AS-Interface  
■ KNX GAMMA instabus

Totally  
 Integrated  
 Power

## A unique complete approach for all industries

As one of the world's leading automation suppliers, Siemens provides an integrated, comprehensive portfolio for all requirements in process and manufacturing industries. All components are mutually compatible and system-tested. This ensures that they reliably perform their tasks in industrial use and interact efficiently, and that each automation solution can be implemented with little time and effort based on standard products. The integration of many separate individual engineering tasks into a single engineering environment, for example, provides enormous time and cost savings.

With its comprehensive technology and industry-specific expertise, Siemens is continuously driving progress in manufacturing industries – and Totally Integrated Automation plays a key role.

Totally Integrated Automation creates real value added in all automation tasks, especially for:

- **Integrated engineering**  
Consistent, comprehensive engineering throughout the entire product development and production process
- **Industrial data management**  
Access to all important data occurring in productive operation – along the entire value chain and across all levels
- **Industrial communication**  
Integrated communication based on international cross-vendor standards that are mutually compatible
- **Industrial security**  
Systematic minimization of the risk of an internal or external attack on plants and networks
- **Safety Integrated**  
Reliable protection of personnel, machinery, and the environment thanks to seamless integration of safety technologies into the standard automation

## Making things right with Totally Integrated Automation

Totally Integrated Automation, industrial automation from Siemens, stands for the efficient interoperability of all automation components. The open system architecture covers the entire production process and is based on end-to-end shared characteristics: consistent data management, global standards, and uniform hardware and software interfaces.

Totally Integrated Automation lays the foundation for comprehensive optimization of the production process:

- Time and cost savings due to efficient engineering
- Minimized downtime due to integrated diagnostic functions
- Simplified implementation of automation solutions due to global standards
- Better performance due to interoperability of system-tested components



## Totally Integrated Power We bring power to the point – safely and reliably.



Comprehensive answers for power distribution in complex energy systems – from Siemens

Efficient, reliable, safe: These are the demands placed on electrification and especially power distribution. And our answer – for all application areas of the energy system – is Totally Integrated Power (TIP). It's based on our comprehensive range of products, systems, and solutions for low and medium voltage, rounded out by our support throughout the entire lifecycle – from planning with our own software tools to installation, operation, and services.

Smart interfaces allow linking to industrial or building automation, making it possible to fully exploit all the optimization potential of an integrated solution. This is how we provide our customers around the world with answers to their challenges. With highly efficient, reliable, and safe power distribution, we lay the foundation for sustainable infrastructure and cities, buildings, and industrial plants. We bring power to the point – wherever and whenever it is needed.

More information: [www.siemens.com/tip](http://www.siemens.com/tip)



# Totally Integrated Power offers more:

- **Consistency:**  
For simplified plant engineering and commissioning as well as smooth integration into automation solutions for building or production processes
- **One-stop-shop:**  
A reliable partner with a complete portfolio for the entire process and lifecycle – from the initial idea to after-sales service
- **Safety:**  
A comprehensive range of protection components for personnel safety and line and fire protection, safety by means of type testing
- **Reliability:**  
A reliable partner who works with customers to develop long-lasting solutions that meet the highest quality standards
- **Efficiency:**  
Bringing power to the point means greater plant availability and maximum energy efficiency in power distribution
- **Flexibility:**  
End-to-end consistency and modular design of Totally Integrated Power for any desired expansions and adaptation to future requirements
- **Advanced technology:**  
Reliable power distribution especially for applications in which supply is critical, continuous refinement of the technology

## Challenges are our speciality

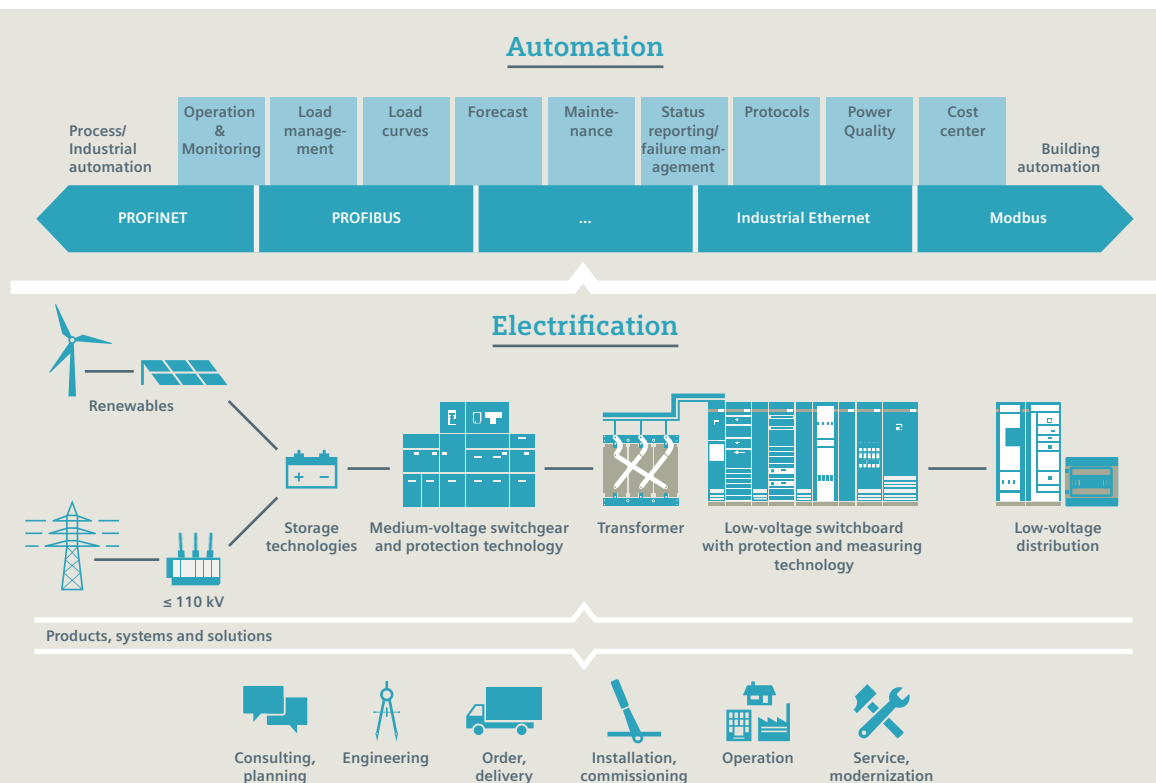



## Introduction



<b>1/2</b>	<b>Industrial communication</b>
<b>1/6</b>	<b>Industrial bus systems</b>
1/8	Industrial Ethernet
1/10	PROFINET
1/12	PROFIBUS
1/14	AS-Interface
1/16	IO-Link
1/18	Industrial Wireless Communication
1/20	Industrial Remote Communication
<b>1/23</b>	<b>Industrial communication</b>
1/23	Data for practical applications

## Introduction

### Industrial communication

1

SIMATIC NET offers all the components necessary for an integrated complete solution and supports the following bus systems:

#### PROFINET/Industrial Ethernet

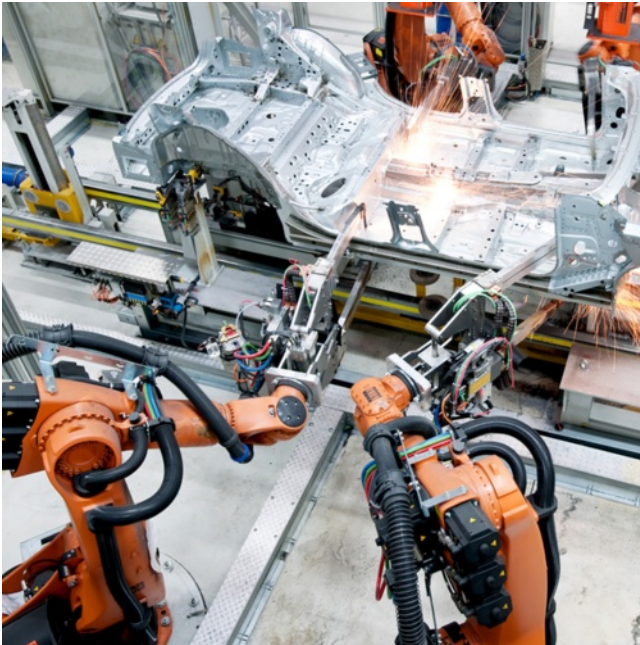

Industrial Ethernet (IEEE 802.3)	- the industrial standard based on the international Ethernet standard
PROFINET (IEC 61158/61784)	- the leading Industrial Ethernet standard for automation
Industrial Wireless LAN (IEEE 802.11)	- the industrial standard for wireless communication based on the international standard

#### **Industrial Ethernet** (IEEE 802.3) –

the international standard for area networking is the number one network in the LAN environment. Industrial Ethernet enables powerful communication networks to be constructed over wide areas.

#### **PROFINET** (IEC 61158/61784) –

the international standard is based on Industrial Ethernet and allows real-time communication all the way to the field level, but also integrates the enterprise level. With the full utilization of existing IT standards, PROFINET allows isochronous motion control applications, efficient cross-manufacturer engineering and high availability of machines and systems on the Industrial Ethernet. PROFINET supports distributed automation (and controller-controller communication) and it allows fail-safe applications.

#### PROFIBUS



PROFIBUS (IEC 61158/61784)	- the international standard for the field level is the global market leader among fieldbus systems
----------------------------	---

#### **PROFIBUS** (IEC 61158/61784) –

the international standard for the field level is the global market leader among fieldbus systems. It allows communication both in manufacturing applications and in process-oriented applications.

AS-Interface



AS-Interface  
(IEC 62026-2/EN 50295)

- the international standard, which, as an economical alternative to the cable harness, links sensors and actuators by means of a two-wire line.

### **AS-Interface** (EN 50295/IEC 62026) –

the international standard which, as an alternative to the cable harness, links especially cost-effective sensors and actuators by means of a two-wire line.

IO-Link



IO-Link

- the standard for intelligently connecting sensors and actuators from the field level to the MES level

### **IO-Link** –

the standard for intelligently connecting sensors and actuators from the field level to the MES level.

**Network transitions** are implemented via controllers or links. Configuration and diagnostics can be performed from any point in the plant.

## Introduction

### Industrial communication

1

#### Overview

##### Your requirements

Do you want to bring new products quickly onto the market? And at the same time be flexible and in a position to change your product range at short notice and shorten your time-to market? Do you want to be able to manufacture efficiently at low costs? And at the same time optimize the capacity of your plant/machine and minimize possible downtimes?

Then all the machines in your plant should work together perfectly. Therefore, you rely upon open, integrated automation communication not just within the whole company but also for external communication. Avoid isolated automation and information technology solutions by assuring:

- Continuous flow of information from the actuator/sensor level through to the corporate management level
- Availability of information at any location
- High-speed data exchange between the different plant sections
- Easy, plant-wide configuration and efficient diagnostics
- Integrated security functions that block unauthorized access
- Fail-safe and standard communication via the same connection

##### Our range

Communication networks are of utmost importance for automation solutions. SIMATIC NET – Networking for Industry – stands for a diverse range of modular blocks – Designed for Industry – which contribute to efficiently solving your communications tasks:

- In the different automation areas
- Across the entire workflow
- For the complete plant life cycle
- For all industries

SIMATIC NET offers solutions which both maximize the benefits of Ethernet and simply integrate fieldbus systems. Noticeable examples are:

- The development of the field level for the use of Industrial Ethernet
- Complete integration from the field level to the corporate management level
- Implementation of state-of-the-art solutions with mobile and wireless communication
- The integration of IT technologies

##### Worldwide trends

Decentralization has been gaining worldwide importance for a number of years now. A distributed plant structure can reduce installation, maintenance and diagnostics costs. This involves intelligent devices working locally and being connected together across networks. Openness and flexibility are important in order to expand existing setups and to connect up different systems. For this reason, international committees define and standardize the standards for bus systems.

#### Benefits

##### Industrial communication with Totally Integrated Automation

With Totally Integrated Automation, Siemens is the only manufacturer to offer an integrated range of products and systems for automation in all sectors – from incoming goods and the production process to outgoing goods, from the field level through the production control level to connection with the corporate management level.

The advantages of Totally Integrated Automation already pay off as regards design and engineering, but also assembly and commissioning and operation and maintenance.

Automation solutions can be implemented at little cost. New scope for development allows a quicker and more flexible response to new market requirements. Systems can be easily expanded or converted without having to interrupt ongoing operations. Due to the increased use of Industrial Ethernet in automation, two topics within Totally Integrated Automation are becoming more and more important – PROFINET and SCALANCE.



**Benefits (continued)****PROFINET ...  
for increasing the productivity of your plant**

You need a seamless information flow for your strategic decisions within your company – from the first manufacturing step through operation up to the corporate management level. In order to achieve this, you rely on efficiency and transparency already during engineering.

PROFINET, the open and innovative Industrial Ethernet standard fulfils all the demands of industrial automation and ensures integrated, company-wide communication.

PROFINET also supports the direct connection of distributed field devices to Industrial Ethernet and the implementation of isochronous motion control applications. PROFINET also allows distributed automation with the support of component technology, as well as vertical integration and the implementation of safety-oriented applications. PROFINET also supports controller-controller communication.

**Securely and flexibly networked across all levels with  
SCALANCE network components**

SCALANCE X Industrial Ethernet Switches, SCALANCE S Industrial Security Modules and Industrial Wireless LAN (IWLAN) access points, client modules (SCALANCE W) and SCALANCE M industrial routers that ideally meet the demands of industrial applications are available for networking the stations on the PROFINET/Industrial Ethernet.

The use of wireless communication to automation devices and industrial terminal devices helps to achieve greater flexibility. As a result you can simplify maintenance work and reduce service costs and downtimes. With Safety, even fail-safe communication is possible by means of wireless networking with SCALANCE products. This increases a company's competitiveness considerably.

Challenging applications with real-time requirements can be implemented in the radio field. The use of wireless features for moving machines saves cable and servicing costs; driverless transport systems can receive data via the wireless system without requiring cables and remain flexible in the choice of route.

An overall solution comprises:

- Bus system with
  - Passive network components, e.g. cables
  - Active network components, e.g. switches
- Interfaces for connecting automation devices to the bus systems
  - Integrated interfaces
  - Own communications processors
- Network transitions, e.g. IE/PB Link PN IO
- Software for configuring the networks
- Tools for servicing and diagnostics, e.g. SINEMA

Use of communication systems					
	Industrial Ethernet	PROFINET	PROFIBUS DP	AS-Interface	IO-Link
Enterprise Resource Planning (ERP) (e.g. PC)	●	○			
Control (e.g. SIMATIC S7-300)	●	●	●	○	
Motion Control (e.g. SIMOTION)	●	●	●		
Intelligent field devices (e.g. ET 200S/CPU)		●	●	●	●
Simple field devices (e.g. ET 200)		●	●	●	●
Sensors/actuators		●	●	●	●
Identification systems (e.g. RFID and code reading systems)	●	●	●		
Drives (e.g. SINAMICS)	●	●	●	●	
SIRIUS (e.g. M200D motor starter, compact starters, monitoring and overload relay)		●	●	●	●
CNC system (e.g. SINUMERIK)	●	●	●		
Safety-oriented Communication		●	●	●	

G\_IK10\_XX\_00003

not suitable    ○ suitable    ● ideally suitable

# Introduction

## Industrial bus systems

1

### Industrial bus systems

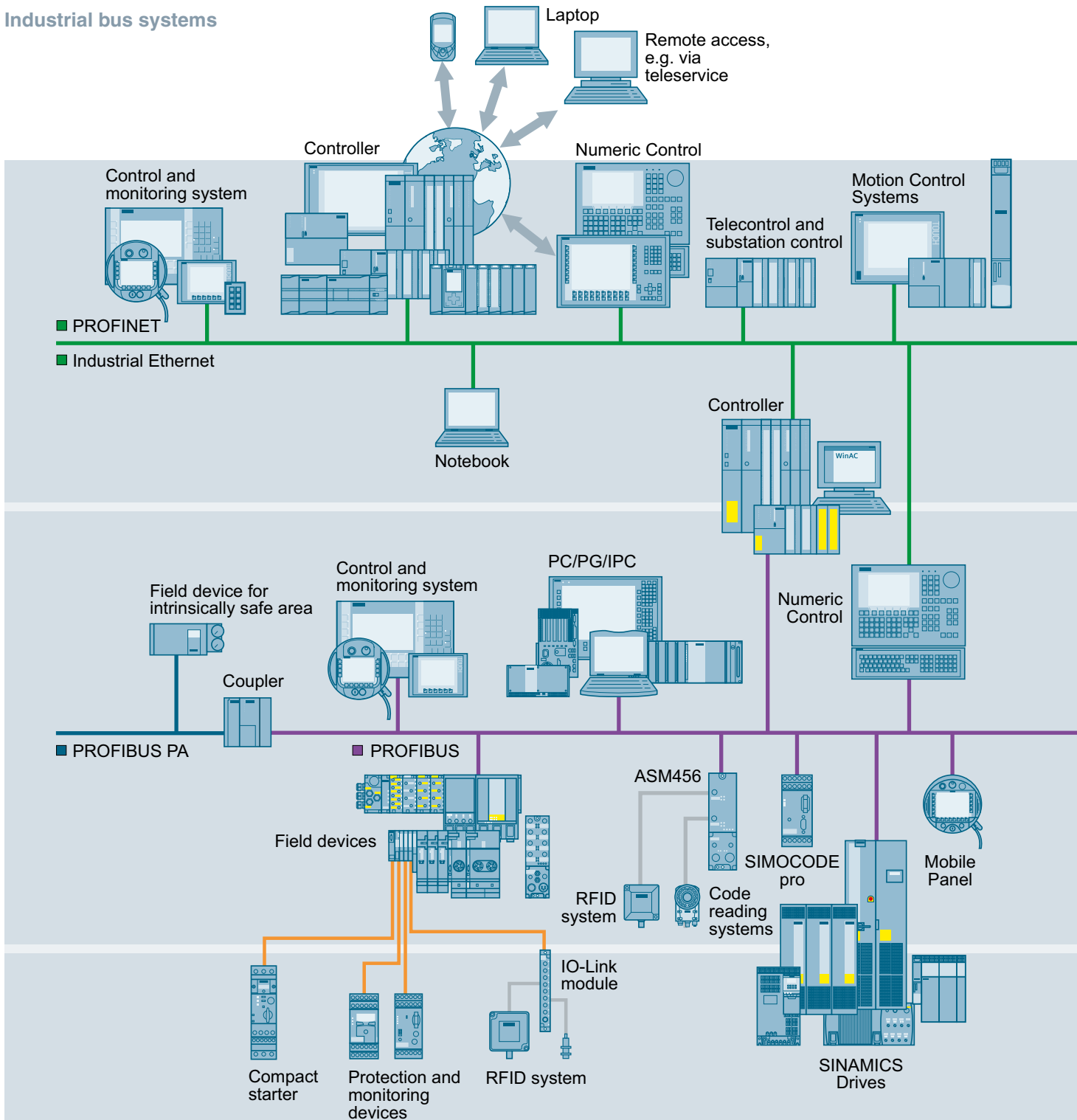

The graphic shows the connection of different automation systems to the standardized networks.



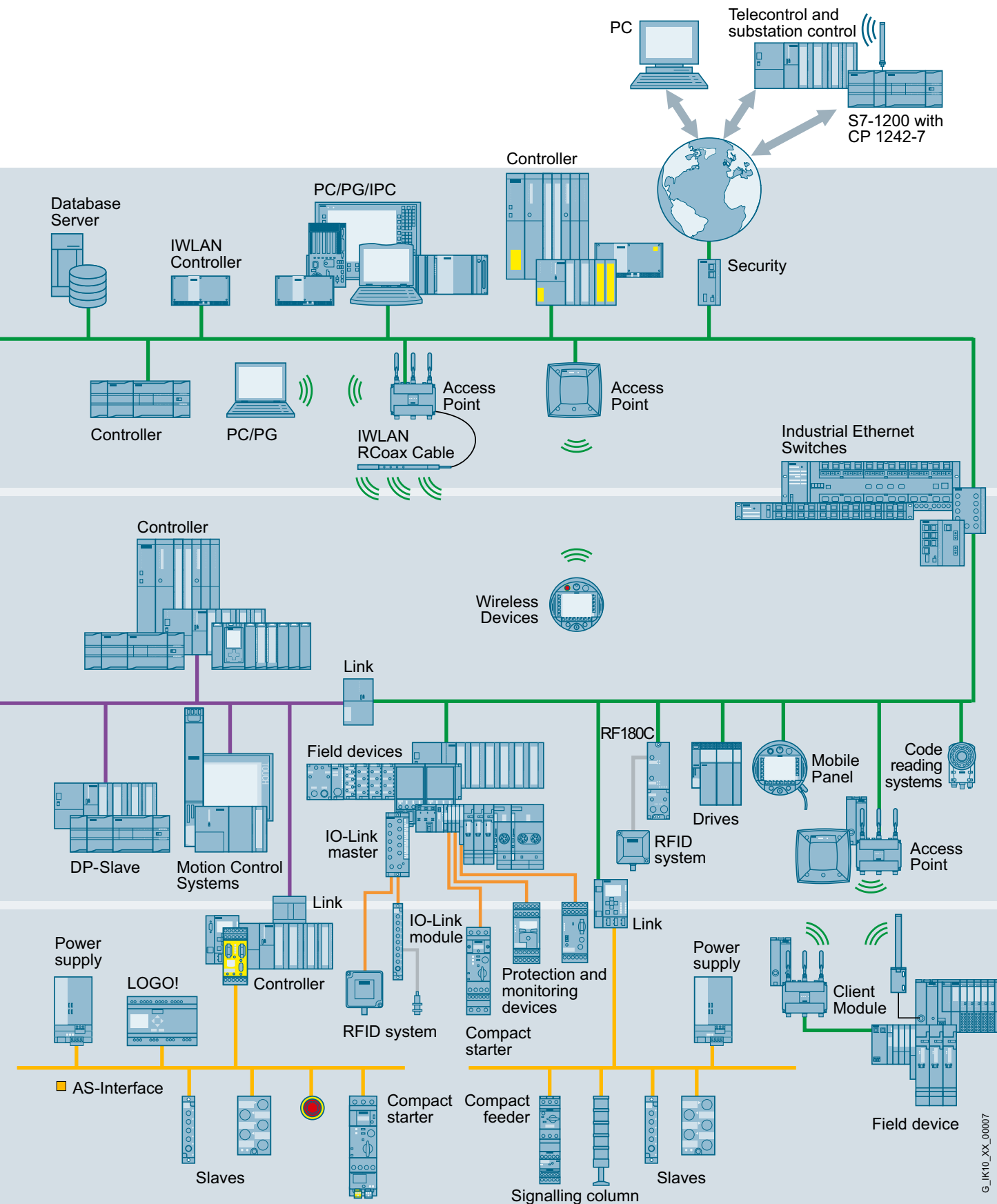

G\_IK10\_XX\_00007

## Introduction

### Industrial bus systems

#### Industrial Ethernet

1

#### Overview

Industrial Ethernet provides the industrial area with a powerful network that complies with the IEEE 802.3 (Ethernet) and 802.11 a/b/g/h/n (wireless LAN) standards.

The diverse options of Ethernet and the Internet that are already available today in the office sector can also be used in factory and process automation by means of Industrial Ethernet.

Ethernet technology, which has been used successfully for decades, allows users to precisely match network performance to requirements. The user can choose the data throughput rate to suit particular needs, as integrated compatibility makes it possible to introduce this technology in stages.

Ethernet is the world's current Number 1 in the network environment and offers significant benefits:

- Fast commissioning thanks to the simplest connection method
- High availability since existing networks can be extended without any adverse effects
- Virtually unlimited communication capabilities, since scalable performance using switching technology and high data rates are available
- Networking of the most varied application areas such as the office and production areas
- Company-wide communication thanks to the Internet connection option, with security components providing for data integrity
- Investment protection through continuous compatible further development
- Precise time-based assignment of events in the overall plant by means of plant-wide clock control.

SIMATIC NET, the industrial communication system from Siemens, relies on this proven technology. Siemens has already supplied several million connections worldwide in tough industrial environments subject to electromagnetic interference.

SIMATIC NET provides important supplements to Ethernet technology for industrial environments:

- Network components of the SCALANCE product families for the use of wired and wireless communication in harsh industrial environments
- Fast on-site assembly using the FastConnect cabling system
- Failsafe networks through high-speed redundancy and redundant power supply
- Continuous monitoring of network components through an effective signaling concept, and network monitoring software

The following communication functions/services are offered by Industrial Ethernet:

#### **PG/OP communication**

Comprises integrated communication functions which allow data communication via SIMATIC, SIMOTION and SINUMERIK automation systems with every HMI device and SIMATIC PG (STEP 7). PG/OP communication is supported by PROFINET/Industrial Ethernet and PROFIBUS.

#### **S7 communication**

S7 communication is the integrated communication function (system function block) for S7-400 or loadable function blocks for S7-300, which have been optimized within SIMOTION, SINUMERIK and SIMATIC S7/WinAC. It also enables PCs/IPCs and workstations to be connected. The maximum volume of user data per task is 64 KB. S7 communication offers simple, powerful communication services and provides a network-independent software interface.

#### **Open communication**

The open communication (SEND/RECEIVE) allows the SIMATIC S7 controllers to communicate with other SIMATIC S7 and SIMATIC S5 controllers, PCs/IPCs and third-party systems. In addition, for the simple connection of HMI stations, FETCH and WRITE are offered.



## Overview (continued)

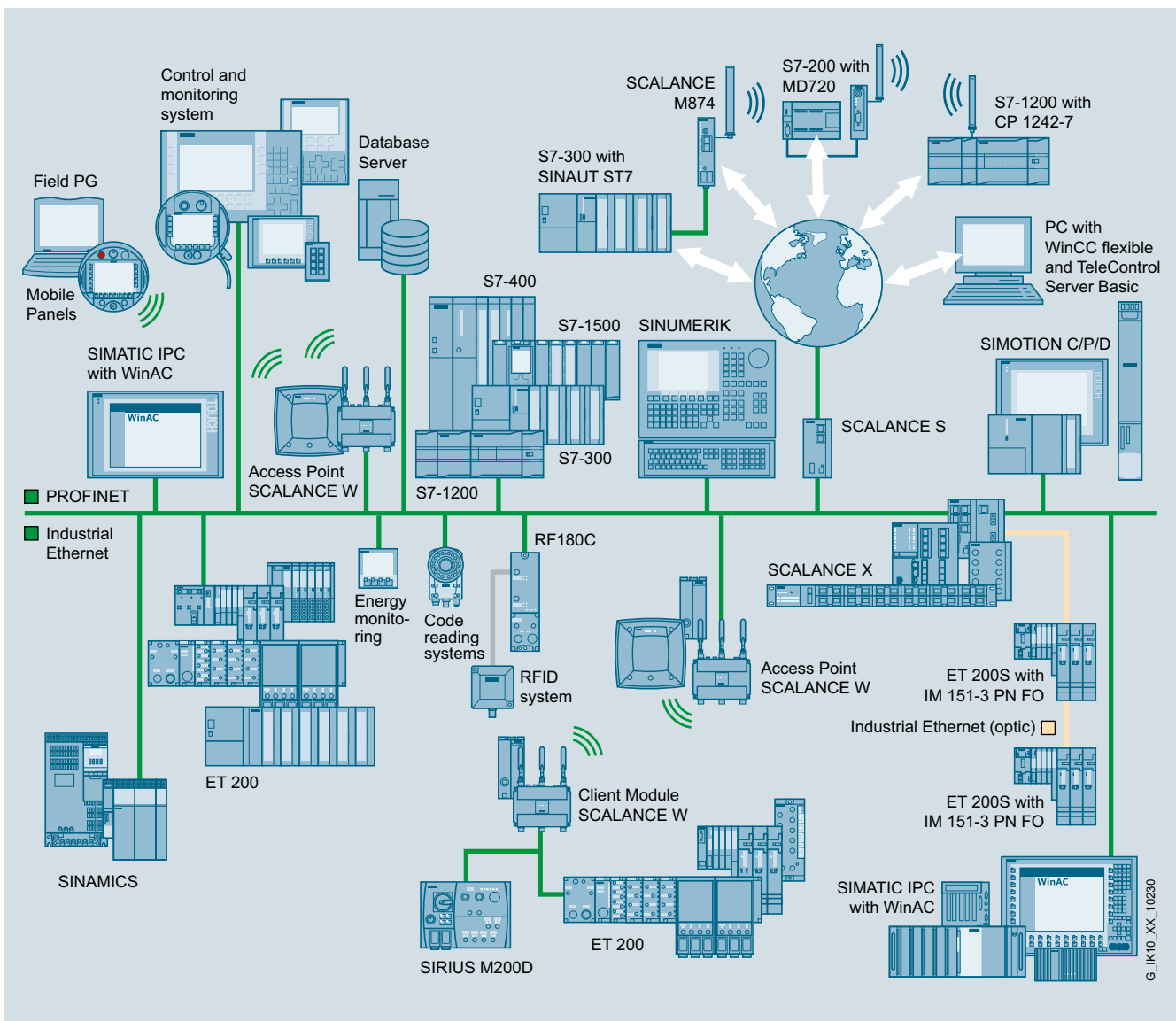

Complete overview of Industrial Ethernet

**The socket interface for Industrial Ethernet**

allows data communication with computers via TCP/IP. On this interface which is widespread in the PC and UNIX world, users can freely program the data exchange. The SEND/RECEIVE blocks (S/R) are used as access to TCP/IP in SIMATIC S7.

**OPC** (Openness, Productivity & Collaboration)

is a standardized, open and cross-vendor software interface. It permits interfacing of OPC-capable Windows applications to S7-communication, open communication (SEND/RECEIVE) and PROFINET.

**IT communication****Information technology (IT) with e-mail, File Transfer (FTP), and web technology**

integrates SIMATIC, SIMOTION and SINUMERIK into IT via Industrial Ethernet. In the office environment, e-mail, FTP, and web browsers have prevailed as widespread means of communication.

**PROFINET communication**

This communication is compliant with the IEC 61158/61784 standard. PROFINET, the international standard, uses Industrial Ethernet and enables real-time communication right down to the field level.

## Introduction

### Industrial bus systems

## PROFINET

### Overview

#### *PROFINET – The Ethernet standard for automation*

PROFINET is the leading Industrial Ethernet standard with more than 7,6 <sup>1)</sup> million nodes worldwide.

PROFINET makes businesses more successful by speeding up processes, boosting productivity, and increasing plant availability.

With PROFINET, Siemens is applying the Ethernet standard to automation. PROFINET enables high-speed and secure data exchange at all levels, thus making it possible to implement innovative machine and plant concepts. Thanks to its flexibility and openness, PROFINET offers users maximum freedom when engineering and structuring their plant architectures.

PROFINET's efficiency means optimal utilization of available user resources and a significant increase in plant availability. Innovative Siemens products and the performance of PROFINET provide a sustained boost to company productivity.

#### *PROFINET innovations*

PROFINET has been expanded by a number of innovative features. These simplify the system configuration, in safety-critical applications for example, and support a leaner and more flexible topology in many different scenarios.

The **I-Device (intelligent IO device)** function enables simple and fast controller-controller communication through direct access to the IO address image with the PROFINET IO protocol. Local controllers such as the ET 200S CPU can be integrated into modular machines more easily, for example.

The **Shared Device** function allows two controllers to access the same PROFINET IO Device, such as a distributed ET 200 or a drive in a safety application. Because fewer devices need to be installed in the field, the engineering, cabling, energy and installation costs are reduced.

Plant availability can be increased using a ring topology and the **Media Redundancy Protocol (MRP)**. This runs directly via the integrated RJ45 ports on PROFINET devices and can be combined in any way with the relevant Industrial Ethernet switches (e.g. SCALANCE X-200).

High network availability can be achieved without reconfiguration time using the **MRPD procedure (Media Redundancy for Planned Duplication)**.

#### Advantages at a glance

##### **More flexibility with PROFINET**

##### *Industrial Wireless LAN (IWLAN)*

IWLAN reduces maintenance costs, increases reliability, and gives a convincing high communication performance. Only PROFINET allows the use of IWLAN with safety.

##### *Safety*

Safety-related communication via PROFIsafe reliably protects personnel, the environment, and plants.

##### *Flexible topologies*

PROFINET also enables the use of star, tree and ring topologies in addition to the linear topology.

##### *Open standard*

Thanks to its openness, PROFINET creates the basis for a uniform machine/plant automation network to which programmable controllers as well as standard Ethernet devices can be connected.

##### *Web tools*

PROFINET is 100 percent Ethernet and supports TCP/IP. Among other things, this enables the use of Web technologies, such as access to the integrated Web server of the field devices.

##### *Expandability*

With PROFINET, network infrastructures can be expanded as desired, even during operation.

<sup>1)</sup> Source: PROFIBUS and PROFINET International (PI), values at end of 2013

## Overview (continued)

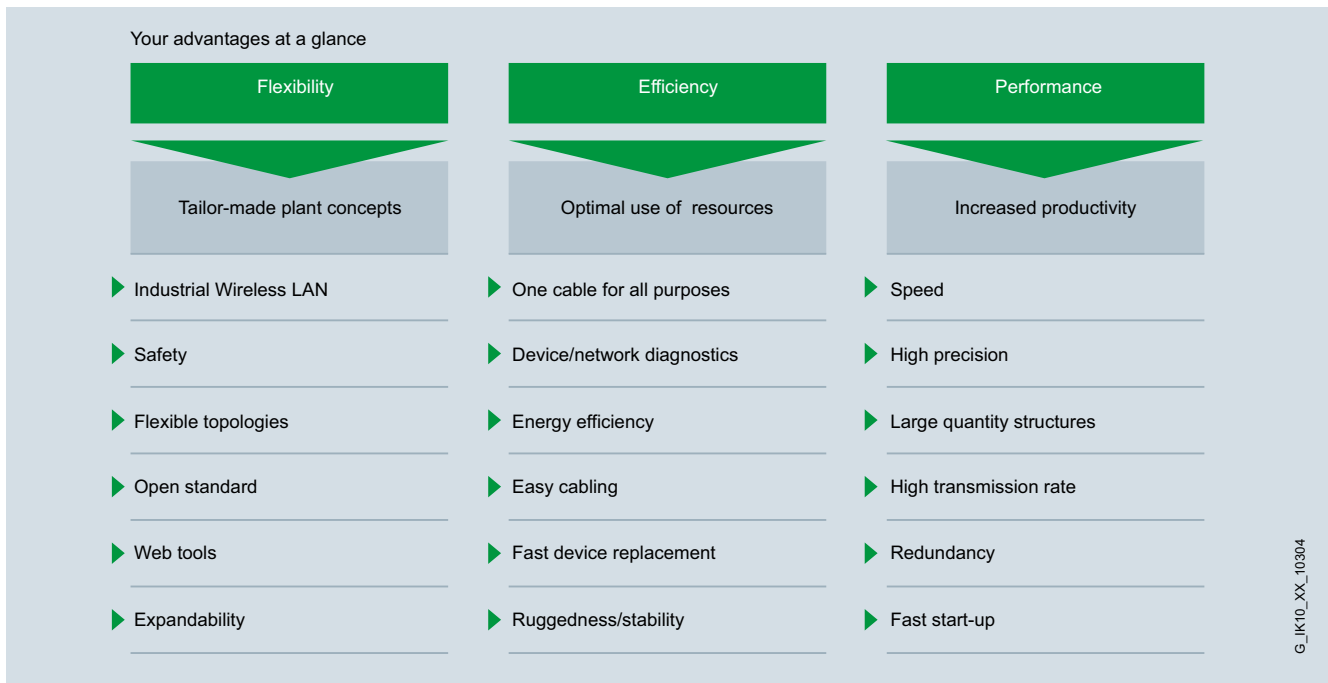
**More efficiency with PROFINET****One cable for all purposes**

PROFINET offers a host of functions on a single cable, allowing convergence of machine data and standard IT data. This creates consistency and cuts costs by reducing the overhead for cabling and training.

**Device and network diagnostics**

Extensive diagnostic data can be read out from the devices to locate faults quickly. HTML standard Web sites are used for servicing PROFINET devices – locally and remotely.

**Increased energy efficiency**

PROFenergy switches off individual loads or entire production units during breaks – in a coordinated and centrally controlled way.

**Easy cabling**

Fault-free establishment of industrial networks in a short time without the need for specialist knowledge: PROFINET makes this possible with the FastConnect system.

**Quick device replacement**

When replacing a PROFINET device, the IO Controller detects the new device and automatically assigns its name.

**Extremely robust**

The use of switches even in field devices prevents faults in one section of the network from influencing the entire plant network. PROFINET enables the use of fiber-optic cables for areas that are particularly sensitive to EMI.

**More performance with PROFINET****Speed**

Fast motion control applications need high-speed data exchange. PROFINET's short cycle times increase the productivity of machines and plants.

**Precision**

Communication via PROFINET is deterministic. A jitter of < 1 µs results in maximum precision cycles and thus ensures high product quality.

**Large quantity structures**

With PROFINET, up to 256 devices can be managed by one SIMATIC controller. The number of nodes per network is more or less unlimited.

**High transmission rate**

By using Ethernet, PROFINET achieves a significantly higher transmission rate than previous fieldbuses. This enables problem-free transmission of even large volumes of data without affecting I/O data transfer.

**Redundancy**

Higher plant availability can be achieved by means of a redundant installation. This can be implemented both with the help of external switches and directly via integral PROFINET interfaces.

**Fast start-up**

In modular plants, IO controllers must be able to detect new machines or plant sections quickly. With Fast Startup, PROFINET can detect devices and connect them to the IO controller within 500 ms.

## Introduction

### Industrial bus systems

## PROFIBUS

### Complete overview of PROFIBUS

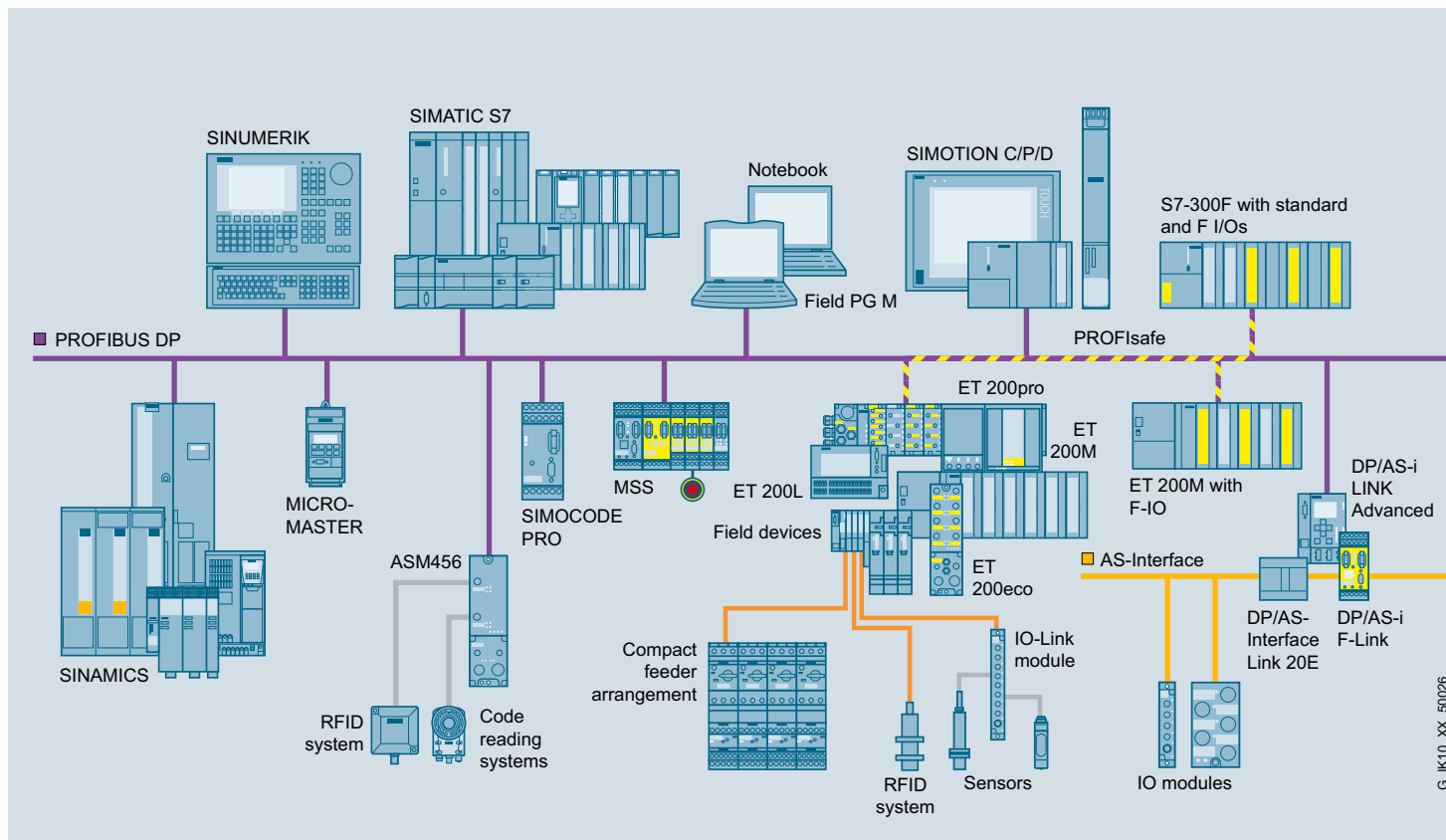

PROFIBUS is used to connect field devices, e.g. distributed I/O devices or drives, to automation systems such as SIMATIC S7, SIMOTION, SINUMERIK or PCs. PROFIBUS is standardized in accordance with IEC 61158/61784 and is a powerful, open and rugged fieldbus system with short response times. PROFIBUS is available in different forms for various applications

#### **PROFIBUS DP** (distributed I/O)

connecting distributed field devices, e.g. SIMATIC ET 200, or drives with extremely fast response times. PROFIBUS DP is used when sensors/actuators are distributed at the machine or in the plant (e.g. field level). The actuators and sensors are connected to the field devices.

The field devices are supplied with output data in accordance with the master/slave technique and transfer input data to the controller or PC.

#### *Openness all along the line*

Dank Thanks to the openness of PROFIBUS DP, standard-compliant components from different manufacturers can also be connected. The IEC 61158/61784 standards provide future protection for your investment. A simple link to other bus systems, e.g. from the AS-Interface, is implemented by means of links and thus permits an integrated solution in the field of failsafety for the protection of both human and machine.

Siemens has a complete range of products of standard and fail-safe controllers, network components, communication software and field devices. And for field device manufacturers, Siemens offers everything to do with the PROFIBUS DP interface, such as ASICs, training, certification, and much more.

#### **PROFIsafe**

permits standard and safety-related communication on one and the same bus cable. It is an open solution for safety-related communication over standard buses and uses the PROFIBUS services.

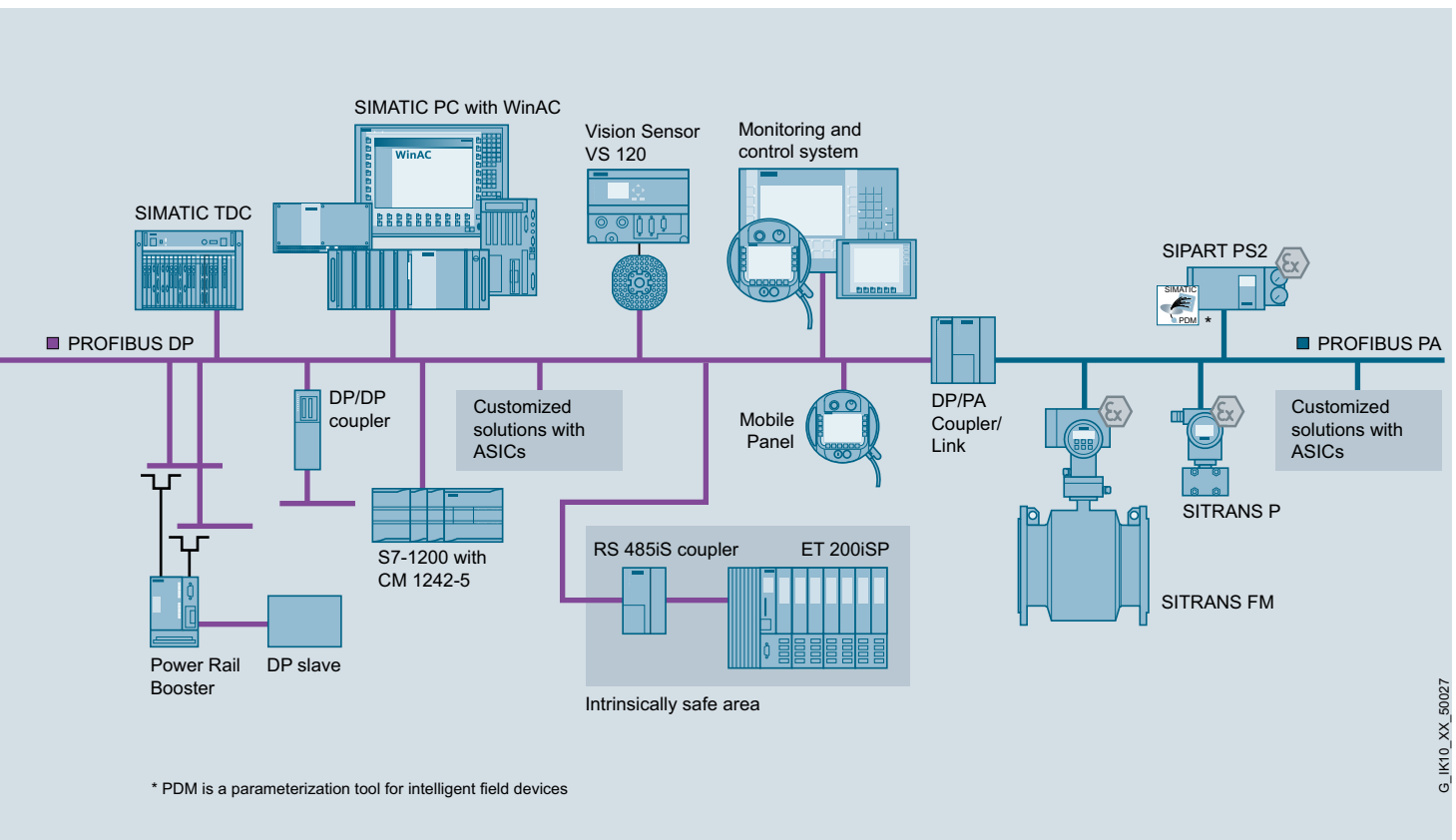

### *Isosynchronous mode*

The CPU, I/O and user program are synchronized with the PROFIBUS cycle. The "Isosynchronous mode" function is supported by many CPUs of SIMATIC, SIMOTION, SINUMERIK and servo drives. The drives are controlled using the PROFIdrive profile.

### **PROFIBUS PA (Process Automation)**

expands PROFIBUS DP with intrinsically safe transmission of data and power (e.g. transducers in the food processing industry) in accordance with the international standard IEC 61158-2 (same protocol, different physical properties). PROFIBUS PA is used predominantly in the hazardous areas of refineries (chemical, oil and gas).

## Introduction

### Industrial bus systems

#### AS-Interface

#### Overview

Sensors, valves, actuators, drives – many different components operate on the field level. All of these actuators/sensors must be connected to an automation system. Distributed I/O devices are used for this; to a certain extent as intelligent outposts directly on-site.

As a cost-effective alternative to the cable harness, AS-Interface links the components of the field level by means of a simple 2-wire cable for data and power.

AS-Interface is standardized as an international industrial standard according to EN 50295 and IEC 62026-2 and is supported worldwide by a number of member companies of the AS-International Association, including the leading manufacturers of actuators and sensors. AS-Interface is used where individual actuators/sensors are spatially distributed throughout the machine (e.g. in a bottle filling plant).

AS-Interface is a single master system. There are communications processors (CPs) for SIMATIC and for SIMOTION and links that control field communication as masters. With the AS-Interface specification V2.1 or V3.0, up to 62 slaves can be connected. The AS-Interface specification V3.0 allows a maximum of 1000 digital inputs/outputs to be connected (profile S-7.A.A: 8DI/8DO as A/B slave). New profiles allow extended addressing (A/B) to be used for analog slaves, too. The analog value transmission is accelerated via "fast analog profiles". Thanks to the integrated analog value processing in the masters, the access to analog values is just as easy as the access to digital values. For connecting the AS-Interface to PROFIBUS DP, the DP/AS-i LINK Advanced, DP/AS-i F-Link or DP/AS-Interface LINK 20E are available with degree of protection IP20. This enables the use of AS-Interface as a subordinate network for PROFIBUS DP. The IE/AS-i LINK PN IO allows AS-Interface to be connected to Industrial Ethernet and thereby a direct embedding in the PROFINET environment.





## Overview (continued)

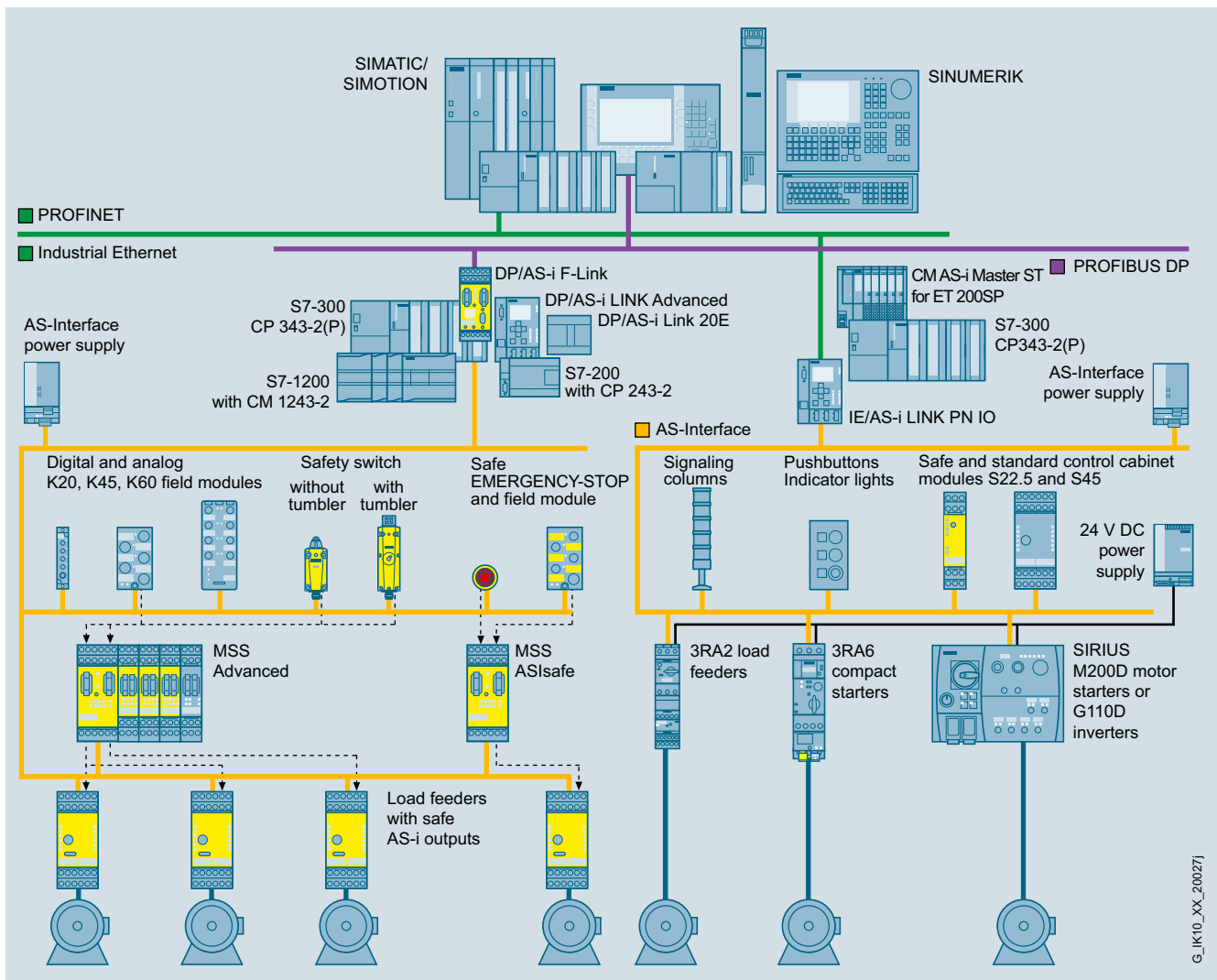

Example of a system configuration

**Cost savings**

AS-Interface replaces costly cable harnesses and connects binary actuators and sensors such as proximity switches, valves or indicator lights, as well as analog signals with a controller such as SIMATIC.

In practice this means: Installation runs smoothly because data and power are transported together over **one** single line. Thanks to the specially developed ribbon cable (yellow in color) and insulation displacement technology, the AS-Interface slaves can be connected anywhere.

This concept is extremely flexible and has a great effect on savings. No expert knowledge is required for installation and commissioning. Furthermore, through simple cable laying and the clear cable structure as well as the special design of the cable, you not only significantly reduce the risk of errors, but also service and maintenance costs.

## Introduction

### Industrial bus systems

#### IO-Link

#### Overview

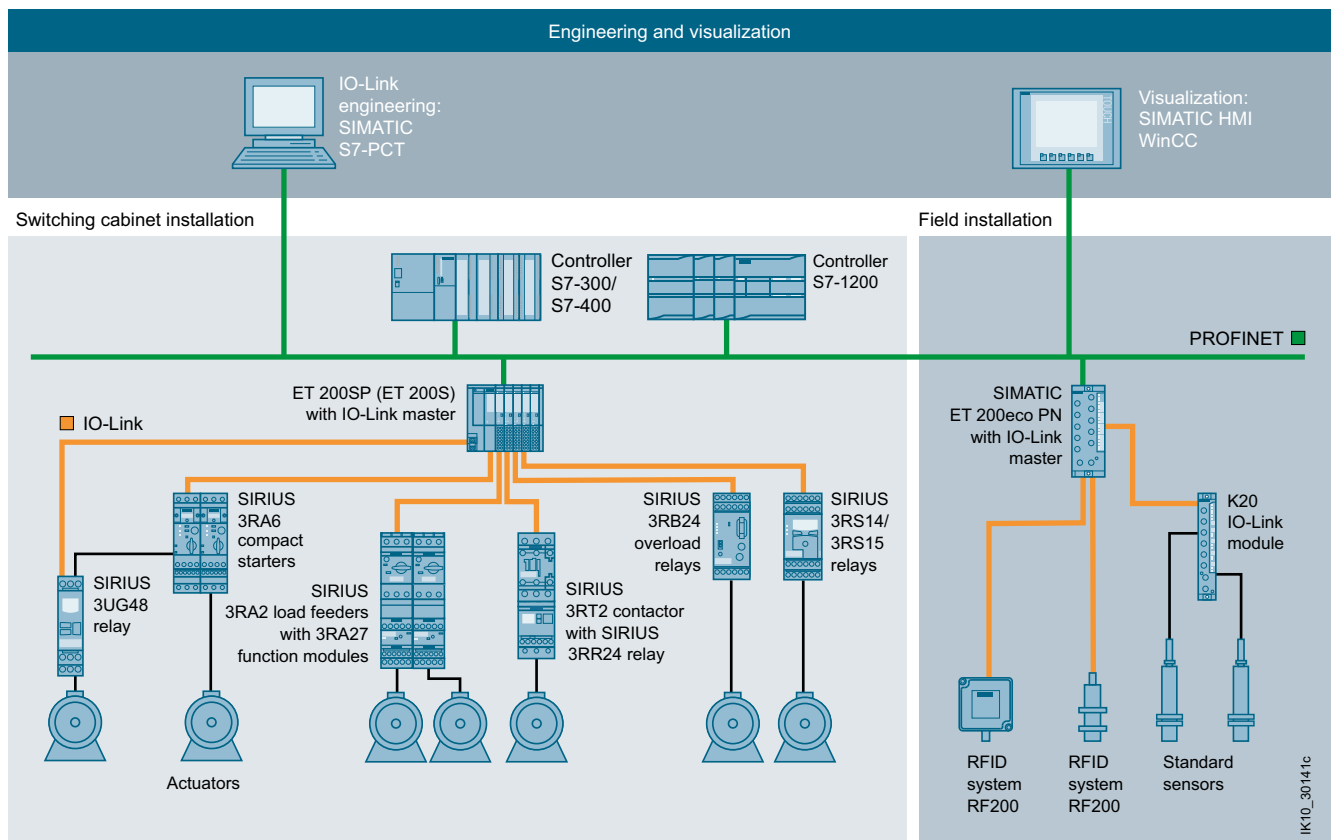

### Uninterrupted communication down to the last meter: the point-to-point interface IO-Link

#### ***IO-Link – more than just another interface***

IO-Link is the smart concept for the standardized linking of switching devices and sensors to the control level by means of an economical point-to-point connection.

The new communications standard IO-Link below the fieldbus level allows central fault diagnosis and location as far as the actuator/sensor level and simplifies both commissioning and maintenance by allowing the parameter data to be modified dynamically, direct from the application.

Improvements in the intelligence of field devices and their integration in the overall automation support data access down to the lowest field level. The result: greater plant availability and reduced engineering overhead.

As an open interface, the IO-Link can be integrated into all common fieldbus and automation systems. Consistent interoperability ensures maximum protection of investment. This also applies in the context of existing machine concepts for continued use of sensors without an IO-Link interface.

**Overview** (continued)**Together for integrated quality**

The requirements for integrated communication are increasing. At the same time, the variety of field devices, actuators, and sensors is increasing immensely – with ever greater intelligence.

IO-Link offers the solution for these requirements and is seen by manufacturers as a valuable addition to the communications landscape (including AS-Interface).

As a committed driver of this issue, Siemens is further developing not only its product and system range accordingly, but by integrating IO-Link in Totally Integrated Automation, it is also providing a unique integrated communication solution.

**Engineering****Reduced engineering times**

- Standardized, open system for more flexibility (third-party IO-Link devices can be integrated in the engineering)
- Uniform and transparent configuration and programming through integrated engineering (SIMATIC STEP 7)
- Freely available function blocks for SIMATIC for user-friendly parameterization and diagnostics, and read-out of measured values
- Efficient engineering thanks to use of off-the-shelf faceplates in SIMATIC HMI
- Low error rate in CAD circuit design thanks to reduction in control circuit wiring

**Commissioning****Reduced commissioning times**

- Faster installation and minimized error rate thanks to reduction in control circuit wiring
- Space savings in the control cabinet
- Low-cost wiring technology with several branches thanks to unrestricted use of existing Siemens components

**Operation and maintenance****Increased plant availability**

- High level of transparency in the plant down to the field level
- Reduction of downtime and maintenance times through plant-wide diagnostics and faster error correction
- Support for preventive maintenance
- High transparency through incorporation of energy management systems, readout of current values, and diagnostic messages
- Shorter conversion times thanks to central parameter and recipe management for field devices as well



## Introduction

### Industrial bus systems

#### Industrial Wireless Communication

#### Overview

Within the scope of industrial communication, wireless communication opens up new perspectives – from partial modernization of a plant, right up to optimizing complex logistics or production processes.

On the basis of Wireless Remote Networks, RUGGEDCOM WiN, Industrial Wireless LAN and WirelessHART, Siemens offers solutions for reliable automation with Industrial Wireless Communication.

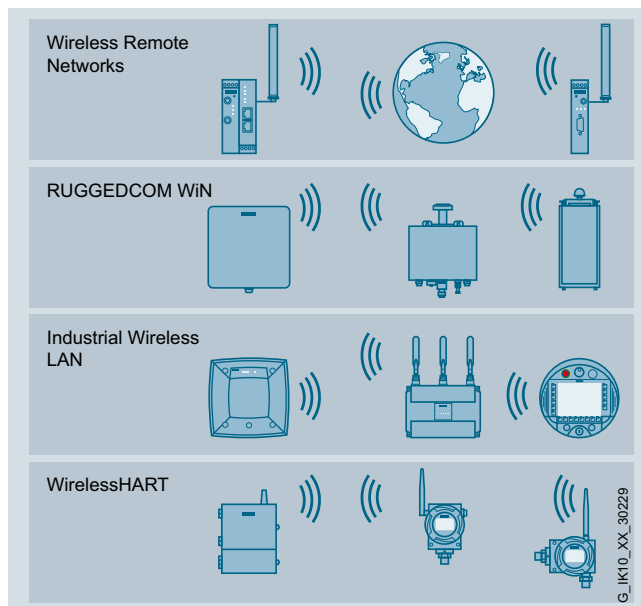

Reliable, wireless communication

#### **Wireless Remote Networks – low-cost and versatile wireless technology for longer distances**

Continuous communication between widely separated plant sections in the area of water/wastewater, or high-speed remote maintenance access to machines and plants on the other side of the world - these are just two of the countless ways you can reap the benefits of Wireless Remote Networks. Thanks to integration in a telecontrol system or an HMI/SCADA system, transferred process data is available at any time via mobile radio.

#### **RUGGEDCOM WiN**

RUGGEDCOM WiN products according to the IEEE 802.16e-2005 (WiMax) standard support longer distances and are designed for use in critical locations or under demanding environmental conditions.



#### **Industrial Wireless LAN – flexible, plant-wide wireless infrastructure**

Wireless solutions are increasingly becoming a matter of course in machines and plants. In the case of high data communication requirements, Industrial Wireless LAN (IWLAN) backs innovations like deterministic radio and the Industrial Ethernet standard PROFINET. Thanks to the use of PROFINET via IWLAN, PROFINET opens up completely new perspectives – from efficient engineering, through real-time solutions, all the way to safety-related tasks. Furthermore, an IWLAN infrastructure can also be used for additional applications such as video monitoring.

#### **WirelessHART – wireless connection of the process instrumentation**

WirelessHART is an open industry standard, developed for the particular requirements of wireless communication for field devices in the process industry. It meets all specific requirements for reliability, security, economy and user-friendly operation system-wide. With more than 30 million installed devices worldwide, HART technology is the most frequently used communication protocol for intelligent process instrumentation at the field level. WirelessHART is backwards-compatible with the wired HART technology and thus offers maximum investment security for hardware, software and expertise.

## Overview (continued)

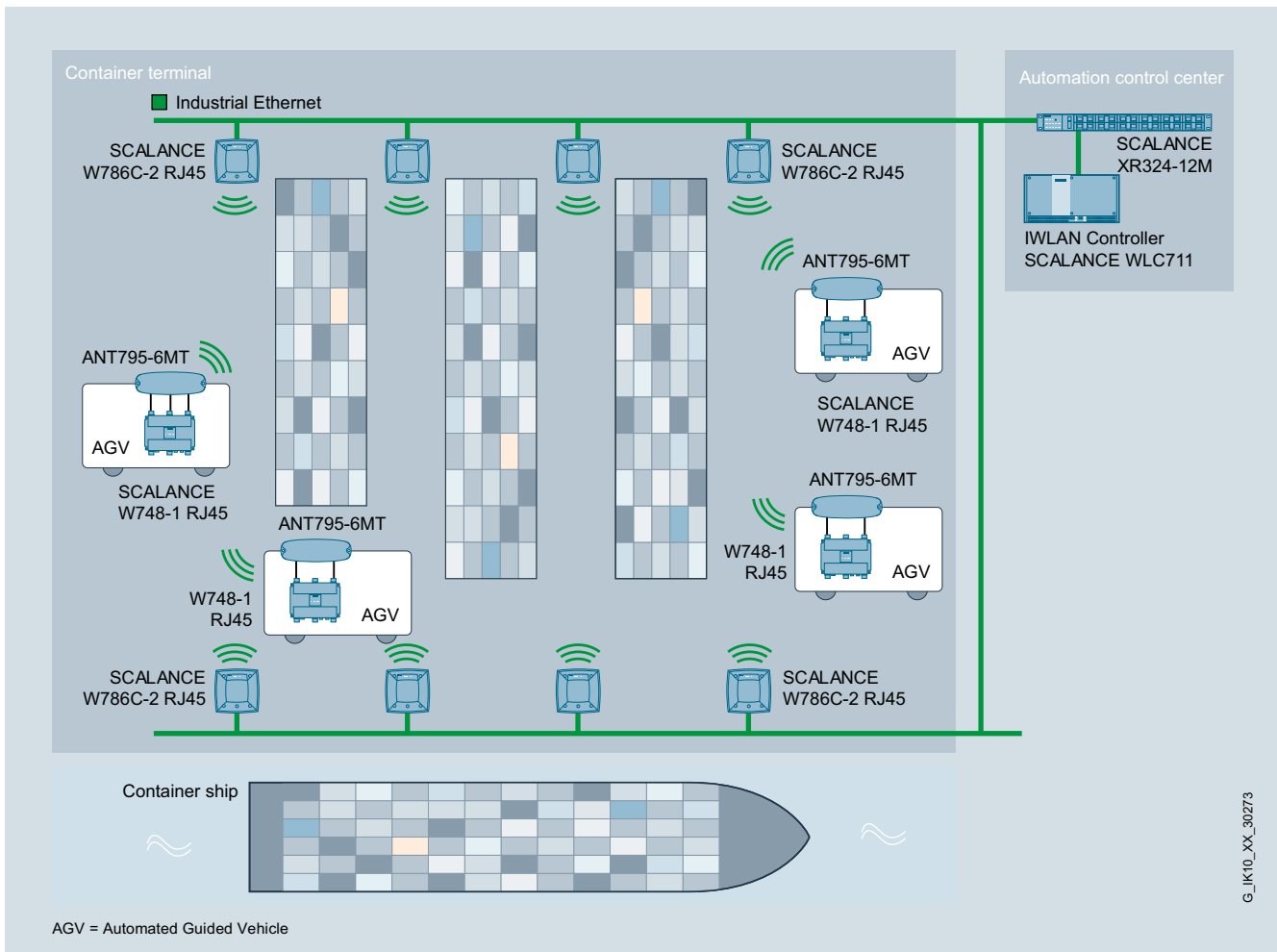

Application example for controller-based IWLAN applications with a large number of access points, e.g. in a container terminal

**Advantages of a wireless communication network**

- Increased competitiveness, since greater flexibility is achieved through mobility
- Maintenance work is simplified, service costs and downtimes are reduced, and personnel are used optimally
- No wear and tear of rotating and moving equipment or system components
- Integrated wireless network for voice and data across the divisions of the company
- Remote diagnostics for different production machines from a central service location reduces service costs
- Awkwardly located installations can be accessed easily; there is no need for complex wiring

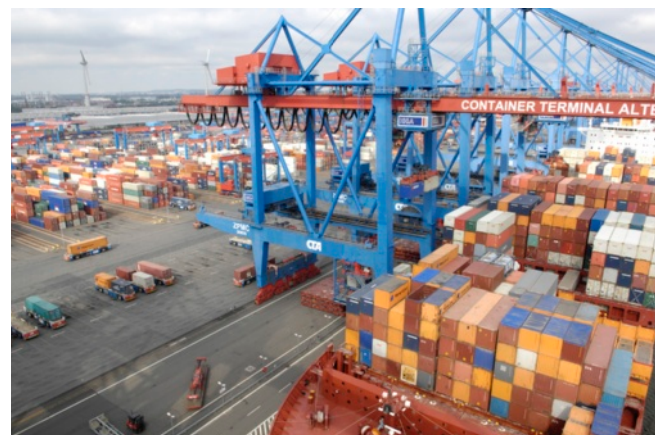

## Introduction

### Industrial bus systems

## Industrial Remote Communication

### Overview

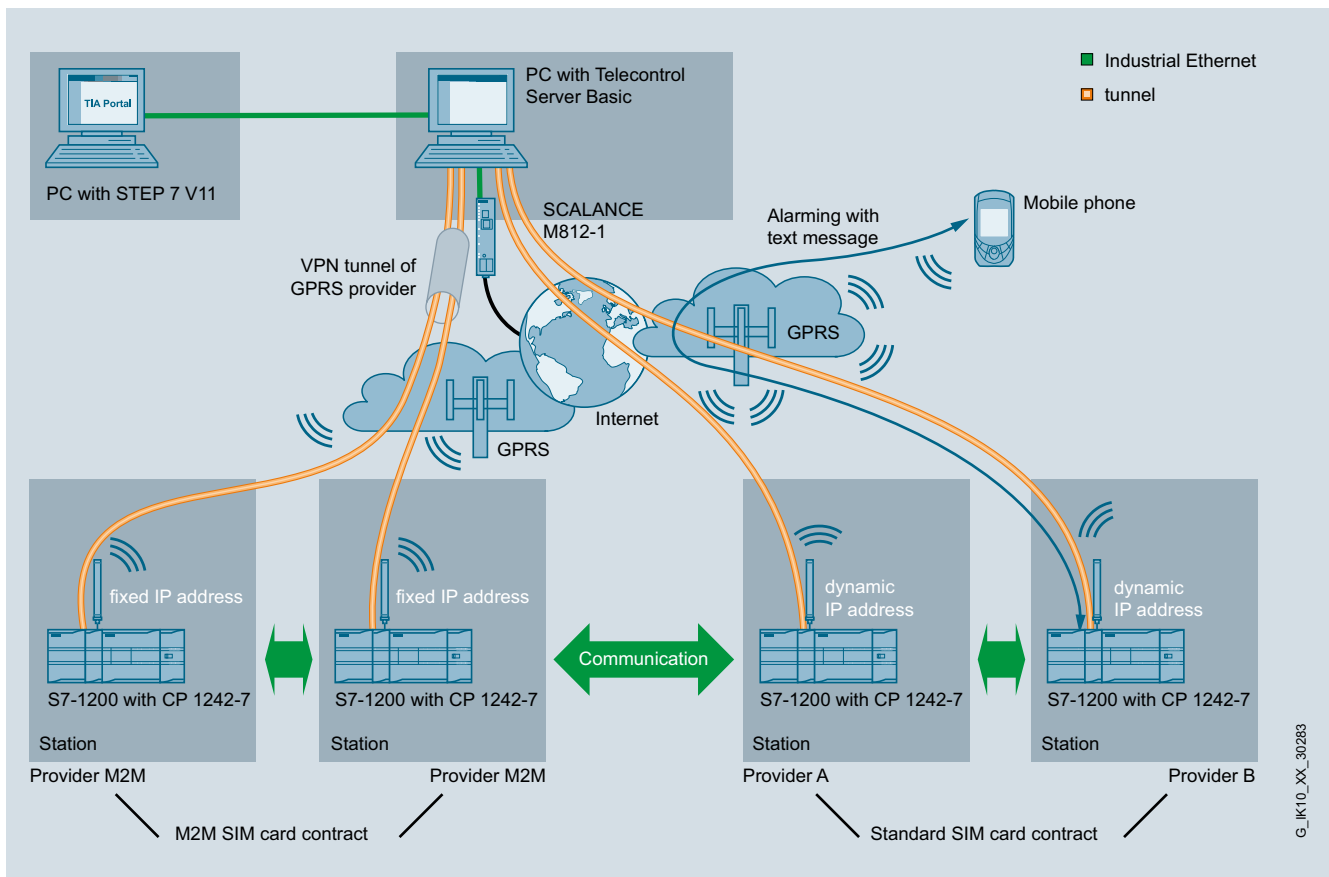

Efficient remote access to plants and machines with SIMATIC via industrial remote access

#### Efficient industrial remote access

Global remote access to far-flung plants, remote machines and mobile applications is gaining in significance – both in industry and in industry-related areas. With a comprehensive range of solutions for industrial remote access, Siemens offers the ideal basis for efficient and reliable monitoring and control of widely distributed plants of any size.

#### Secure and flexible access worldwide

Industrial plants are often distributed over large areas – sometimes even across national borders. Siemens offers proven solutions for industrial remote access, such as flexible telecontrol systems and efficient remote maintenance. Whether in public infrastructure, the manufacturing or process industry: With comprehensive solutions for teleservice and telecontrol, Siemens is the right partner every time.

#### Teleservice (remote maintenance/diagnostics)

Teleservice is data exchange with physically remote technical plants (machines, plants, computers, etc.) for the purpose of error detection, diagnostics, maintenance, repair, or optimization.

#### Telecontrol

Telecontrol involves the connection of distant process stations to one or more central control systems. Various different public or private networks (Remote Networks) can be used for communication for the purposes of monitoring and control. Event-driven or cyclic exchange of process data is performed with special telecontrol protocols and enables the operating personnel to manage the overall process effectively.

The telecontrol systems are based on SIMATIC. They supplement the SIMATIC system with corresponding hardware and software, and thus permit individual process stations to be networked over Remote Networks). The data for this is transmitted via classical WAN, e.g. copper dedicated cable, dial-up networks, wireless, but also via IP-based networks such as mobile wireless networks or the Internet.

G\_IK10\_XX\_30283

**Overview** (continued)**TeleControl Basic**

Telecontrol Basic connects the control center via the Telecontrol Server Basic control center software with the substations, consisting of SIMATIC S7-1200 controllers with CP 1242-7 or CP 1243-1 GPRS module for Ethernet-based connections. The server also supports the connection of S7-200 stations with MD720 modems. Wireless GPRS technology or IP-based networks, such as DSL, are available as transmission media. An S7-1200 substation permits remote communication with a control center (service center) as well as direct slave-slave communication with other S7-1200 substations. Small-scale applications with few outstations can be implemented, as well as large-scale plants comprising up to 5000 outstations. International approvals permit worldwide use.

Extended Telecontrol Server Basic functionalities allow the use of telecontrol server services. The overall solution also includes the teleservice function and thus provides, for example, worldwide access to the S7-1200 stations for international plant and machine manufacturers.

**TeleControl Professional**

TeleControl Professional comprises the Siemens telecontrol systems for extensive, expanded applications in the process industry. Control systems such as PCS 7, WinCC and third-party control systems with OPC allow reliable control and monitoring of outstations based on the SIMATIC S7-1200, S7-300 and S7-400 controllers.

The outstations and substations can communicate with each other as well as with one or more control centers.

**Transmission networks**

Telecontrol supports a wide variety of communication networks. In the classical WAN sector, these are:

- Dedicated lines (private or leased)
- Private radio networks (optionally with time slot procedure)
- Dial-up networks (analog, ISDN, GSM)

SIMATIC NET also offers appropriate modems for conventional WANs. Communication, however, is also possible via Ethernet-based WAN, namely:

- Via Internet connections, e.g. with SCALANCE M ADSL2+ routers
- Via 2-wire connections, e.g. with SCALANCE M SHDSL routers
- Via serial or Ethernet-based wireless systems, e.g. via UHF radio devices or Industrial Wireless LAN with SCALANCE W or RUGGEDCOM WIN (WiMax)
- Via fiber-optic conductors, e.g. through use of SCALANCE X switches with optical ports; distances of up to 120 km can then be covered
- Via mobile networks and the Internet using GPRS, GPRS(E) or UMTS and DSL

There are no restrictions in terms of network combinations in a project. Star, line and node topologies can be designed, and also mixed configurations of these. A station can be linked using two transmission paths to permit redundant data transmission. The two paths can be of the same type or also different, e.g. dedicated line combined with telephone network or ISDN with DSL.

**Control center systems**

A number of different variants can be selected for setting up the control center depending on the process requirements and extent of the information:

- SINAUT ST7cc  
This WinCC-based PC control center is the ideal control center system for both SINAUT ST7 and SINAUT ST1. It has been developed specifically for event-driven and time-stamped data transmission on the SINAUT system and can have a single or redundant design.
- PCS 7 with PCS 7 TeleControl  
This is the ideal control center system for plants in which larger local automation tasks have to be combined with telecontrol connections. In addition to SINAUT ST7, remote stations with other communication protocols can be connected, e.g. over DNP3 or IEC 870-5-101/-104.
- WinCC TeleControl  
This WinCC-based control center system offers the connection of SIMATIC substations to other telecontrol protocols such as DNP3 or IEC 870-5-101/-104.
- SINAUT ST7sc  
This OPC server software is ideal for connecting the SINAUT telecontrol system to control centers from other vendors via OPC client function. ST7sc features extensive buffer mechanisms which prevent data from being lost even if the OPC client fails, and it can have a single or redundant design
- SIMATIC S7 controller as control center  
Like the substations, this control center comprises a SIMATIC S7-300 or S7-400 controller and is suitable for simpler applications requiring only one current process image of the telecontrol stations. The station process control can be influenced by entering commands, setpoints or parameters. The control center can also be used to extend a PC control center (SINAUT ST7cc or ST7sc), e.g. for data output on a panel, as an emergency operating system, or for implementing cross-station control tasks.

## Introduction

### Industrial bus systems

#### Industrial Remote Communication

#### Overview (continued)

#### Teleservice / Remote Access (remote diagnostics and remote maintenance)

Remote diagnostics and remote maintenance of production plants are indispensable in modern automation technology. They are more efficient and more cost-effective than an on-site service employee. This allows faults to be detected and cleared much faster, downtimes of machines are reduced and their availability is increased.

Machines and plants are increasingly operated in places which are far away from the production site. Plant constructors must nevertheless be able to provide support in the event of a fault. And with the industrial security concept from Siemens, the increasing security requirements for remote access of this type are fulfilled. During the warranty period in particular this can result in high costs. TeleService helps to reduce this risk.

The possible applications for TeleService are manifold. Plants can be diagnosed, values set and data transmitted from anywhere in the world via a telephone cable. TeleService also enables the SIMATIC controllers to send text messages per SMS or e-mail, making a significant contribution to saving travel and personnel costs in service work.

#### Teleservice via IP-based networks

Optimum remote maintenance is based on reliable, permanently available, secured and economical data connections.

Depending on the application, SIMATIC NET provides the appropriate solution:

- For continuous connections or simultaneous access to several plants, a solution via the Internet using SCALANCE S modules is recommended, both on the service and the plant side.
- For flexible remote maintenance access from any Internet connection – whether in the office, home office or hotel room – SOFTNET Security Client is the right software solution for connecting to the SCALANCE S Security Module installed in the plant.
- For plants without wired network connection, the M874-2 GPRS router establishes remote maintenance access to the SCALANCE S in the service center.
- The SCALANCE M874-3 and M875 UMTS routers or the M812 and M816 ADSL routers are available for plants requiring remote maintenance access at an especially high bandwidth

In all cases, the communication is reliably protected by authentication and encryption via a virtual private network (VPN) tunnel, in order to rule out the possibility of industrial espionage or manipulation.

#### Siemens Remote Services

The teleservice product portfolio of Siemens is supplemented with a service concept for SRS. "Siemens Remote Services" provides a powerful, secure platform for remote access to machines and plants. The inclusion of "shared experts" ensures effective support, not only from Siemens but also from the company's own specialists.

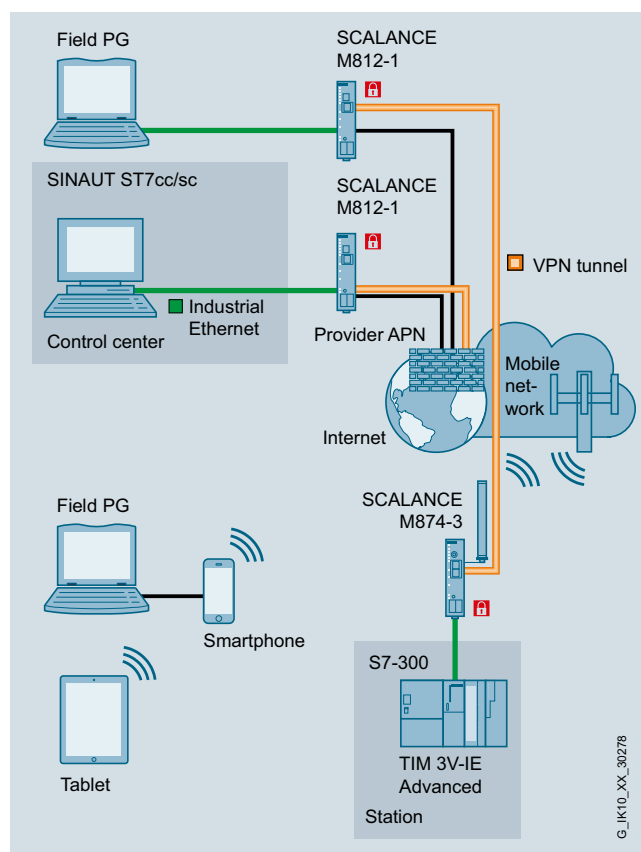

Remote access via an UMTS-based Internet connection

#### Remote networks

Any type of remote communication is based on the public and private networks used for this purpose (e.g. mobile radio or fixed network), referred to as "remote networks".





Under the name SCALANCE M, Siemens offers a comprehensive range of high-performance transmission components, routers and modems that are tailored to the specific properties of the respective remote networks or their transmission media and therefore combine the maximum possible security with reliability. Regardless of whether spontaneous or permanent transmission, whether high or moderate bandwidth, whether mobile or stationary – with the SCALANCE M products for IP-based connectivity, users have a comprehensive spectrum of components at their disposal for remote access – flexible, optimized for industrial use and integrated into the TIA environment and into the Industrial Security concept. SCALANCE M devices can be used universally in the fields of telecontrol, teleservice (remote diagnosis and maintenance), and any other application for industrial remote communication.

G\_IK10\_XX\_30278



## Overview

## Data for practical applications

Communication Systems Compared in Practice					
	Industrial Ethernet	PROFINET	PROFIBUS DP	AS-Interface	IO-Link
Criteria					
Data rate	10/100 Mbit/s 1/10 Gbit/s (only 100 Mbit/s for PROFINET)	9.6 Kbit/s – 12 Mbit/s adjustable 31.25 Kbit/s <sup>1)</sup>	Send cycles 5 ms	4.8/38.4 Kbit/s or SIO (switching operation)	
Number of nodes Maximum	more than 1000	125  125 DP/PA links <sup>1)</sup> 31 field devices per <sup>1)</sup> DP/PA link	62	2	
Length of the network	Between two nodes: ■ electrical up to 100 m ■ optical up to 5 km (multimode) or up to 120 km (singlemode)	For the entire network: ■ electrical up to max. 10 km: - without repeater up to 1 km - with repeater up to 10 km ■ optically with optical link modules (OLM) up to 1875 km	For the entire network: ■ electrical up to max. 600 m: - with extension plug up to 200 m - with repeater or extender up to 300 m - with repeater and extension plug up to 600 m	■ electrical up to 20 m	
Topology	Line Tree Ring Star 	Line Tree Ring Star 	Line Tree Star 	Point-to-point 	
Power supply	- separate 24 V DC - Power-over-Ethernet (PoE)	separate 24 V DC (also via hybrid cable)	Sensors and modules: over bus cable actuators: over U <sub>AUX</sub> 2 V DC (standard case) or over bus cable (30 V)	integrated	
Fail-safe communication	PROFIsafe SIL3, PL e	PROFIsafe SIL3, PL e	ASIsafe SIL3, PL e	–	

<sup>1)</sup> For PROFIBUS PA

G\_IK10\_XX\_00004

The table contains empirical values that can serve as recommendations for selecting the optimum network.

# Introduction

Notes

1



<b>2/4</b>	<b>Introduction</b>	<b>2/249</b>	<a href="#">SCALANCE X-300 managed</a>
2/8	Data communication	<b>2/251</b>	SCALANCE X-300 managed
2/9	Communication overview	<b>2/274</b>	SCALANCE XR-300 managed
2/11	Topologies	<b>2/288</b>	SCALANCE X-300PoE managed
2/23	Network selection criteria	<b>2/296</b>	SCALANCE XR-300PoE managed
		<b>2/309</b>	SCALANCE X-300EEC managed
<b>2/24</b>	<b>PROFINET</b>	<b>2/331</b>	SCALANCE XR-300EEC managed
2/24	Introduction	<b>2/344</b>	Media modules for modular SCALANCE X-300 managed
<b>2/28</b>	<b>Cabling technology</b>	<b>2/359</b>	<b>Industrial Ethernet Layer 3 Switches / Routers</b>
2/28	Overview of passive network components	<b>2/359</b>	<a href="#">SCALANCE X-400 managed</a>
2/31	Overview of Twisted Pair	<b>2/360</b>	SCALANCE X-400 managed
2/32	Industrial Ethernet FastConnect	<b>2/377</b>	SCALANCE XM-400 managed
2/34	IE FC RJ45 Plug 2 x 2	<b>2/395</b>	<a href="#">SCALANCE X-500 managed</a>
2/39	IE FC RJ45 Plug 4 x 2	<b>2/396</b>	SCALANCE XR-500 managed
2/42	IE Push Pull Plug PRO	<b>2/409</b>	Media modules for modular SCALANCE XR-500 managed
2/47	IE FC M12 Plug PRO	<b>2/426</b>	Power supplies for SCALANCE X-500
2/53	IE FC TP Cable 2 x 2	<b>2/429</b>	<a href="#">Accessories for Layer 3 switches / routers</a>
2/65	IE FC TP Cable 4 x 2	<b>2/429</b>	KEY-PLUG X-500, XM-400
2/72	Energy cables		
2/78	IE TP Cord	<b>Sec. 8</b>	<b>Industrial Security</b>
2/83	Pre-assembled IE Connecting Cables	<b>2/430</b>	<b>SINAMICS drive system</b>
2/87	IE FC Outlet RJ45	<b>2/430</b>	Overview
2/90	IE FC RJ45 Modular Outlet	<b>2/433</b>	<b>Measuring systems</b>
2/96	Overview of FC-FOCs	<b>2/433</b>	Overview
2/98	FC glass fiber-optic cables	<b>2/434</b>	<b>Controllers / Modular controllers</b>
2/103	FC FO termination kit	<b>2/434</b>	<a href="#">SIMATIC S7-1200</a>
2/104	Overview of FOCs	<b>2/434</b>	CPU 1211C
2/105	Glass fiber-optic cables	<b>2/438</b>	CPU 1212C
2/121	IE FO Cords	<b>2/442</b>	CPU 1214C
2/126	POF and PCF fiber-optic cables	<b>2/446</b>	CPU 1215C
2/134	POF/PCF FOC termination kit	<b>2/450</b>	CPU 1217C
<b>2/136</b>	<b>SCALANCE X-100 unmanaged / Media converters</b>	<b>2/453</b>	<a href="#">SIMATIC S7-1500</a>
2/136	SCALANCE X-100 unmanaged media converters	<b>2/453</b>	Standard CPUs
<b>2/147</b>	<b>Industrial Ethernet switches</b>	<b>2/462</b>	Fail-safe CPUs
2/147	Overview	<b>2/467</b>	<a href="#">SIMATIC S7-300</a>
2/151	<a href="#">Compact switch modules</a>	<b>2/467</b>	Standard CPUs
2/151	LOGO! CSM unmanaged	<b>2/473</b>	CPU 314C-2 PN/DP
2/154	CSM 1277 unmanaged	<b>2/476</b>	Fail-safe CPUs
2/157	CSM 377 unmanaged	<b>2/482</b>	<a href="#">SIMATIC S7-400</a>
2/161	<a href="#">SCALANCE X-000 unmanaged</a>	<b>2/482</b>	Standard CPUs
2/162	SCALANCE X005 unmanaged	<b>2/487</b>	Fail-safe CPUs
2/166	SCALANCE XB-000 unmanaged	<b>2/492</b>	High-availability CPUs
2/173	<a href="#">SCALANCE X-100 unmanaged</a>	<b>2/498</b>	<b>Controllers / PC-based controllers</b>
2/174	SCALANCE X-100 unmanaged	<b>2/498</b>	SIMATIC WinAC RTX
2/184	SCALANCE XC-100 unmanaged	<b>2/504</b>	SIMATIC WinAC RTX F
2/189	<a href="#">SCALANCE X-200 managed</a>	<b>2/511</b>	SIMATIC WinAC ODK
2/191	SCALANCE X-200 managed	<b>2/512</b>	<b>Controllers / SIMATIC S7-modular Embedded controllers</b>
2/207	SCALANCE XF-200 managed	<b>2/519</b>	EC31
2/214	SCALANCE X204RNA PRP		Expansion modules
2/220	SCALANCE X204RNA HSR		
2/227	<a href="#">SCALANCE X-200IRT managed</a>		
2/228	SCALANCE X-200IRT managed		
2/244	SCALANCE XF-200IRT managed		

## PROFINET/Industrial Ethernet

<b>2/520</b>	<b>Controllers / Embedded bundles</b>	<b>2/664</b>	<b>Accessories</b>
2/520	SIMATIC IPC227D Bundles	2/664	C-PLUG
2/521	SIMATIC IPC427D bundles	2/429	KEY-PLUG X-500, XM-400
2/522	SIMATIC IPC277D bundles	2/666	Time synchronization
2/523	SIMATIC IPC477D bundles	2/672	<u>SICLOCK Time synchronization</u>
<b>2/767</b>	<b>Industrial PC</b>	2/672	Central plant clocks
<b>2/524</b>	<b>System interfaces for SIMATIC S7</b>	2/673	GPS receivers
2/524	Introduction	2/674	DCF77 receivers
2/527	<u>Communication for SIMATIC S7-1200</u>	2/675	Pulse converters
2/154	CSM 1277 unmanaged	2/677	Accessories
2/527	CP 1243-1	<b>2/678</b>	<b>SIMATIC PCS 7</b>
2/531	<u>Communication for SIMATIC S7-1500</u>	<b>process control systems</b>	
2/531	CM 1542-1	2/678	<u>Automation systems</u>
2/535	CP 1543-1	2/680	AS 410 modular systems
2/541	<u>Communication for SIMATIC S7-200</u>	2/683	- Standard automation systems
2/541	CP 243-1	2/686	- Fault-tolerant automation systems
2/545	<u>Communication for SIMATIC S7-300</u>	2/690	- Safety-related automation systems
2/545	CP 343-1 Lean	2/695	Complementary S7-400 systems
2/549	CP 343-1	2/706	<u>Process I/O</u>
2/554	CP 343-1 Advanced	2/706	SIMATIC ET 200M for SIMATIC PCS 7
2/562	CP 343-1 ERPC	2/707	ET 200M for SIMATIC PCS 7
2/567	<u>Communication for SIMATIC S7-400</u>		Interface Modules
2/567	CP 443-1	<b>2/708</b>	<b>Distributed I/O</b>
2/572	CP 443-1 Advanced	2/708	<u>SIMATIC ET 200SP –</u>
2/579	CP 443-1 RNA		<u>Interface modules without CPU</u>
2/584	<u>Communication for SIMATIC S7</u>	2/708	IM 155-6
2/584	Software	2/713	<u>SIMATIC ET 200S –</u>
<b>2/586</b>	<b>System interfaces for PG/PC/IPC</b>		<u>Interface modules with CPU</u>
2/586	<u>Communication for PC-based systems</u>	2/713	IM 151-8 PN/DP CPU
2/586	Introduction	2/715	Master interface module
2/588	Performance data		for IM 151 CPU interface modules
2/589	Connection options to SIMATIC IPCs	2/716	<u>SIMATIC ET 200S –</u>
2/590	CP 1604		<u>Interface modules with fail-safe CPU</u>
2/595	CP 1616	2/716	IM 151-8 F PN/DP CPU
2/599	CP 1612 A2	2/719	<u>SIMATIC ET 200S –</u>
2/602	CP 1613 A2		<u>Interface modules without CPU</u>
2/606	CP 1623	2/719	IM 151-3 PN
2/611	CP 1628	2/721	<u>SIMATIC ET 200MP –</u>
2/616	HARDNET-IE S7-REDCONNECT		<u>Interface modules</u>
2/619	SOFTNET for Industrial Ethernet	2/721	IM 155-5 PN
2/622	SOFTNET-IE RNA	2/724	<u>SIMATIC ET 200M –</u>
2/624	SOFTNET PN IO		<u>Interface modules</u>
2/626	OPC server for Industrial Ethernet	2/724	IM 153-4 PN
2/629	S7 OPC Redundancy	2/727	<u>SIMATIC ET 200pro –</u>
	for Industrial Ethernet		<u>Interface modules</u>
2/631	SNMP OPC server	2/727	IM 154-4 PN
2/633	SOFTNET-S7/Linux	2/730	IM 154-8 PN/DP CPU
2/634	SOFTBUS for Linux	2/734	IM 154-8 F PN/DP CPU
2/636	Software	2/739	<u>SIMATIC ET 200eco</u>
<b>2/638</b>	<b>System interfaces for SIMATIC HMI</b>	2/739	ET 200eco PN
2/638	<u>System interfaces with WinCC</u>	<b>2/752</b>	<b>Motion Control System SIMOTION</b>
	(TIA Portal)	2/752	The SIMOTION system
2/639	SIMATIC S7	2/753	SIMOTION Hardware platforms
2/641	SIMATIC WinCC (TIA Portal) Runtime	2/755	Motion Control architectures
2/642	WinCC Runtime Communication		with SIMOTION
2/647	<u>System interfaces with WinCC flexible</u>	2/756	PROFINET for SIMOTION
2/647	SIMATIC WinCC flexible RT	2/757	PROFIdrive for SIMOTION
2/653	<u>System interfaces with WinCC</u>		
2/653	SIMATIC WinCC		

<b>2/759</b>	<b>SINUMERIK CNC automation systems</b>	<b>2/845</b>	<b>SIMATIC Identification systems</b>
2/759	SINUMERIK 828D BASIC T/ BASIC M with SINAMICS S120 Combi	2/845	<u>RFID systems</u>
2/760	SINUMERIK 840D sl	2/845	SIMATIC RF640R
		2/848	SIMATIC RF670R
<b>2/761</b>	<b>Operating and Monitoring Devices</b>	2/851	SIMATIC RF180C/RF182C
2/761	Key Panels	2/858	<u>Code reading systems</u>
	SIMATIC HMI KP8/KP8F/KP32F	2/858	SIMATIC MV420
2/762	Basic Panels – Standard	2/865	SIMATIC MV440
2/763	Comfort Panels – Standard		
2/764	Mobile Panels	<b>2/875</b>	<b>Industrial Controls</b>
		2/876	<u>Soft Starters</u>
<b>2/767</b>	<b>Industrial PC</b>	2/875	3RW44 soft starters for High-Feature applications
2/767	<u>Rack PC</u>	2/876	Software
2/771	SIMATIC IPC547E	2/876	- Soft Starter ES
2/777	SIMATIC IPC547D	2/877	<u>Motor starters for use in the field, high degree of protection</u>
2/782	SIMATIC IPC647D	2/877	M200D motor starters for PROFINET
2/787	SIMATIC IPC847D	2/882	Communication module, motor starter modules
2/792	<u>Box PC</u>	2/883	Accessories
2/795	SIMATIC IPC227D	2/885	Software
2/798	SIMATIC IPC427D	2/885	- Motor Starter ES
2/801	SIMATIC IPC627D	2/885	- SIRIUS motor starter block library for SIMATIC PCS 7
2/804	SIMATIC IPC827D	Sec. 3	<u>Monitoring and Control Devices</u>
2/807	<u>Panel PC</u>	Sec. 3	SIMOCODE 3UF Motor Management and Control Devices
2/810	SIMATIC IPC277D		
2/814	SIMATIC IPC477D	<b>2/886</b>	<b>SITOP DC UPS 24 V DC uninterruptible power supplies</b>
2/817	SIMATIC HMI IPC577C	2/886	SITOP UPS1600
2/820	SIMATIC IPC677D		
		<b>2/893</b>	<b>Software and tools</b>
<b>2/824</b>	<b>Industry monitors and Thin Clients</b>	2/893	SIMATIC iMap
2/824	SIMATIC Industrial Flat Panel MT	2/895	SINEMA server
2/826	SIMATIC Industrial Flat Panel	2/898	PN IO Bus Analyzer
2/834	SIMATIC Flat Panels	Sec. 7	TeleService
2/839	SCD monitors 1900		
2/841	SIMATIC Industrial Thin Client	<b>2/901</b>	<b>Engineering / Network management / Diagnostics</b>
Sec. 3	<b>Switching and Protection Devices for Power Distribution</b>	2/901	STEP 7 (TIA Portal)
Sec. 3	Power monitoring	2/905	STEP 7
Sec. 3	SENTRON Measuring Devices		
Sec. 3	Configuring, Visualizing and Controlling with SIMATIC	<b>2/912</b>	<b>PROFINET Technology components</b>
Sec. 3	Configuring, Visualizing and Controlling with SENTRON	2/912	Enhanced Real-Time Ethernet Controller ERTEC
		2/915	Development kits
		2/917	PROFINET Driver
		<b>2/918</b>	<b>Network transitions</b>
		2/918	IE/PB Link PN IO
		sEC. 6	IE/WSN-PA LINK
		sEC. 4	IE/AS-i LINK PN IO
		<b>2/924</b>	<b>Industrial Network Services</b>
		2/924	Network validation and monitoring
		<b>2/926</b>	<b>Partner solutions</b>
		2/926	deviceWISE Embedded Edition for SIMATIC S7

# PROFINET/Industrial Ethernet

## Industrial Ethernet

### Introduction

#### Overview

- Area and cell network according to the international standards IEEE 802.3 (Ethernet) and IEEE 802.11 a/b/g/h/n (wireless LAN) designed for the industrial environment right down to the field level
- Connection of automation components (controllers and field devices) to each other and to PCs and workstations as well as components for wireless communication
- PROFINET, the Industrial Ethernet standard for automation, is based on Standard Ethernet (IEEE 802.3) and supports the connection of devices from field level up to management level
- Comprehensive open network solutions can be implemented
- High transmission performance at up to 10 Gigabit/s
- Integration of conventional IT functionalities such as Web server and e-mail in the automation sector
- A security solution especially for industrial automation thanks to the industrial security concept with the security products of SIMATIC NET (SIMATIC NET CPs with Security Integrated, SCALANCE S and SCALANCE M)

2

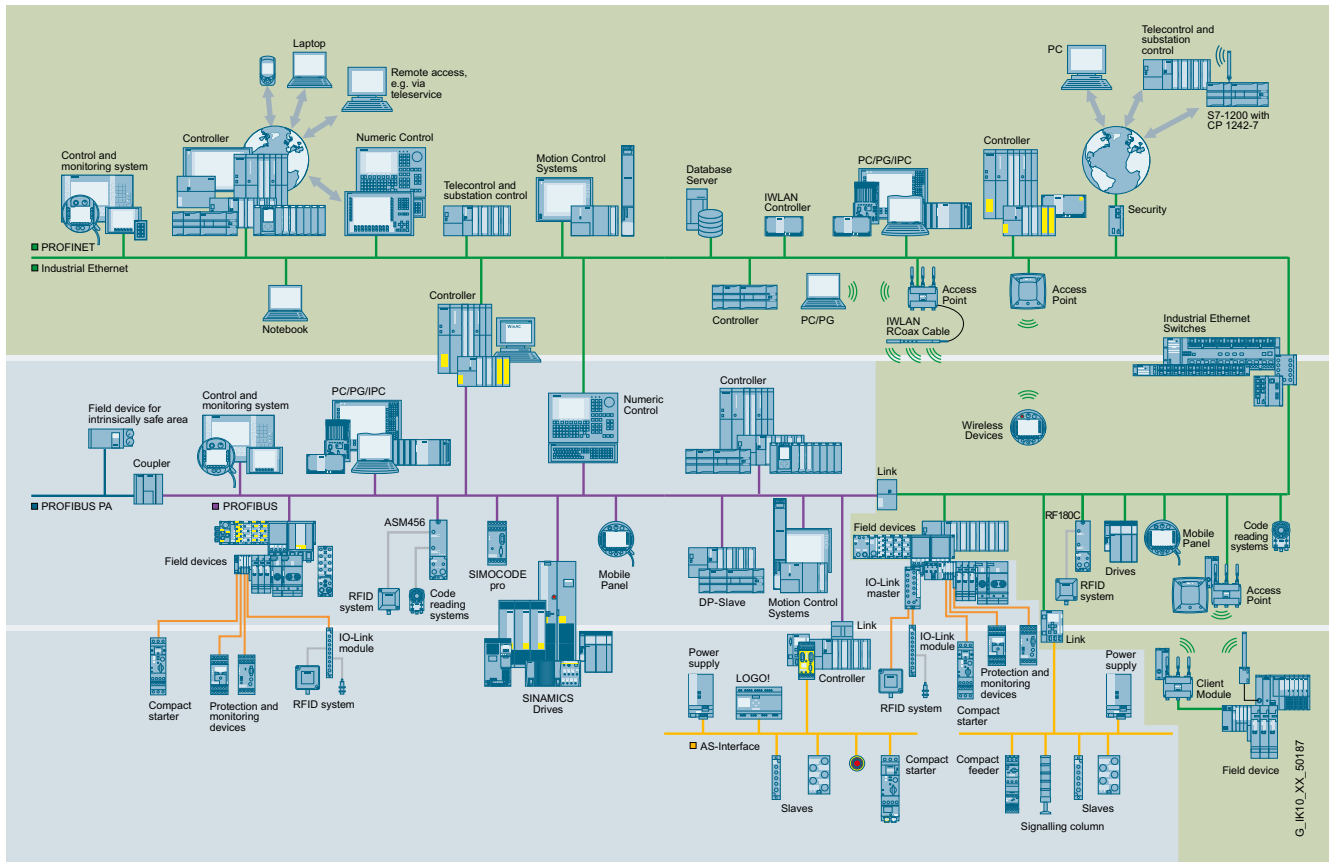

Industrial Ethernet in the communications landscape

**Overview** (continued)

**Ethernet**
The LAN standard from the office sector

Ethernet currently has a market share of over 90% with a rising trend, thus placing it in the pole position in the LAN landscape worldwide. The specification of this baseband LAN was developed in the 70s and standardized in the international IEEE 802.3 standard. Ethernet has continued to experience rapid development and established itself in all speed ranges and application areas.

Milestones include:

- Almost unlimited and very easily scalable data transmission performance thanks to
  - switching technology, full duplex, redundancy
  - continuously rising data rates (10/100 Mbit/s, 1/10 Gbit/s)
- High availability of the network, because:
  - existing networks can be expanded without any adverse effects
  - network structures with any form of meshing compensate for the failure of individual network components (e.g. by means of the Rapid Spanning Tree Protocol)
- Compatible protocol expansions, e.g. support of virtual subnetworks and prioritized data traffic through the use of VLANs
- Structured cabling concept
  - Standardized connection technology
  - Simplest connection technology due to use of preassembled twisted pair cables
  - Glass fiber-optic cables for long distances, areas subject to RFI and inter-building cabling

Ethernet forms the basis for overlaid network protocols such as TCP/IP. TCP/IP is responsible for the transport of data between LANs and represents the basis for IT services (e.g. Internet). In addition, this enables different LAN technologies to be easily integrated, e.g. Ethernet with Wireless LAN.

Ethernet components for the office sector are offered by a large number of vendors, but do not always meet the specific requirements of the industrial sector.

For planning, operation and maintenance of Ethernet networks, sufficiently qualified personnel are available worldwide.

**Industrial Ethernet**
The industry-standard version of Ethernet.

The widespread use of Ethernet in the office sector and the associated wide distribution of technology and know-how have also made this technology interesting for the industrial environment. In order to adapt the networks for the sometimes extremely harsh requirements in the industrial environment, Siemens has made further drastic improvements to their industrial capability, availability, reliability and real-time capability and added rugged connection technology. This gave rise to the "Industrial Ethernet". All Industrial Ethernet devices from Siemens are also extremely easy to operate. This supports implementation without any special IT knowledge.

By means of these additions for tough industrial use, Siemens has shown that Ethernet can also be used successfully in such applications. This approach has been consistently and successfully applied not only for Industrial Ethernet and PROFINET, but also for Industrial WLAN.

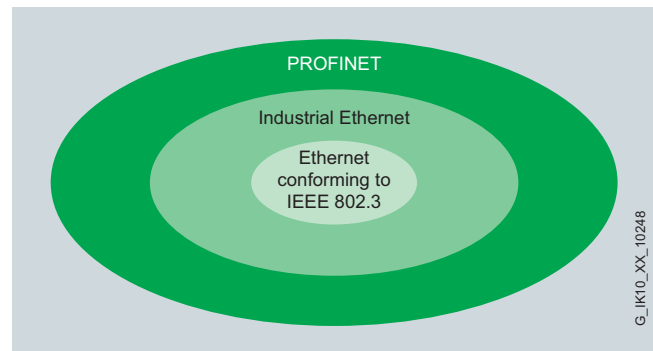

PROFINET/Industrial Ethernet/Ethernet conforming to IEEE 802.3

Industrial Ethernet offers a powerful network, compliant with the IEEE 802.3 standard (Ethernet), for industrial applications. This ensures that the widest range of application areas, such as office and production, can be networked with one another.

Industrial Ethernet utilizes Ethernet technology and strengthens it for use in the industrial sector by means of:

- Network components for use in tough industrial environments (dust, moisture, extreme temperatures, impact loads, vibrations)
- Rugged and simple connection technology for on-site assembly
  - FastConnect cabling system with RJ45 technology
  - On-site assembly of POF and PCF fiber-optic cables
- Failsafe networks through redundancy
- Failsafe devices through redundant design and redundant power supplies
- Connection of automation components (controllers and field devices) to each other and to PCs and workstations
- Optimized communication between automation components and simultaneously open communication according to TCP/IP standard
- Simple connection to the Wireless LAN and Industrial Wireless LAN (IWLAN) networks in accordance with IEEE 802.11
- A security solution specially designed for industrial automation in the form of the Industrial Security concept

Among the Siemens Ethernet components for industrial use, the focus is on compatible successor products and spare parts availability of up to 10 years.

# PROFINET/Industrial Ethernet

## Industrial Ethernet

### Introduction

#### Overview (continued)

##### **PROFINET**

The open Industrial Ethernet standard for automation

With more than six million nodes worldwide (Dec. 2012), PROFINET is the leading cross-vendor Industrial Ethernet standard (IEC 61158/61784) for automation.

PROFINET increases companies' success by accelerating processes, boosting productivity, and increasing plant availability.

#### Advantages at a glance

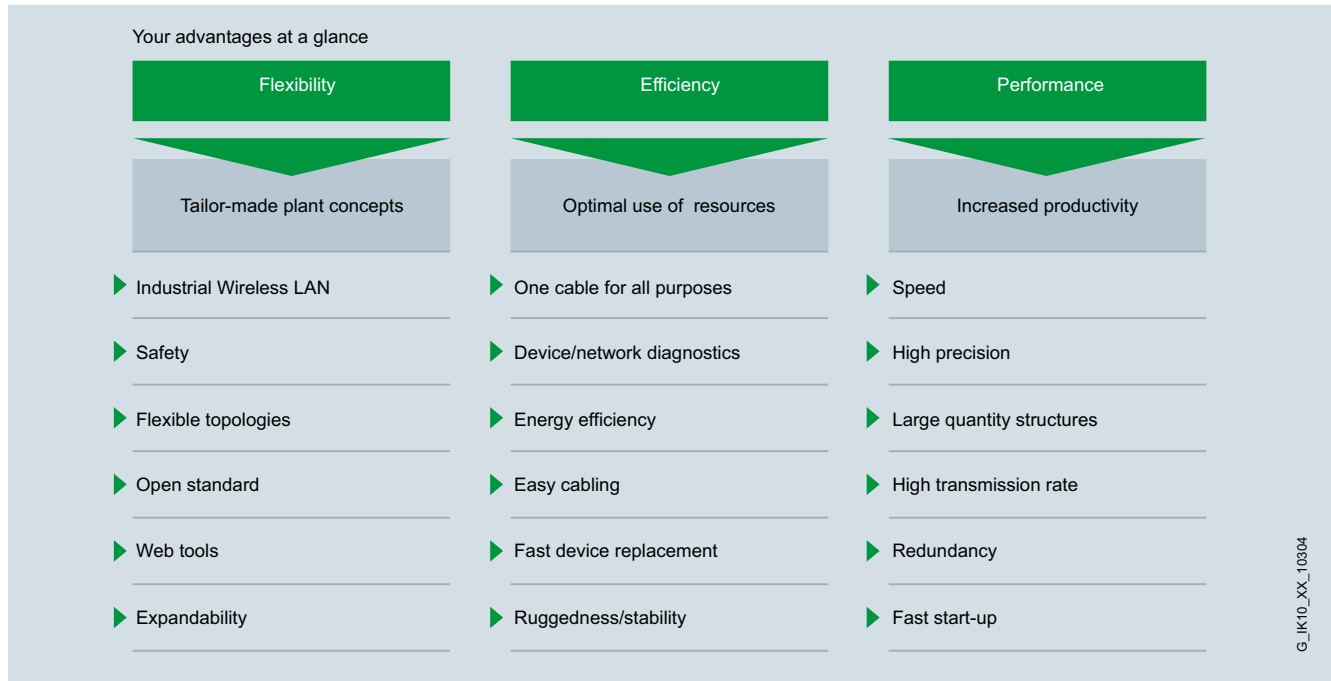



**Overview** (continued)

**Network diagnostics**

Failures in the network not only prevent access by plant operators to the field devices, but often mean that these devices can no longer communicate with one another. In the worst-case scenario, this can result in production downtimes. With the SINEMA Server network monitoring software developed especially for industry, problems can be detected and cleared at an early stage.



The number of nodes of Ethernet-based devices in production networks is growing continuously. Long, time-consuming searches for faults in large industrial networks during commissioning or during a standstill in production are unforeseeable cost drivers, to be avoided where possible. For this reason, network transparency through the continuous diagnosis of Ethernet-based production networks should be part of every efficient production system.

However, with a suitable network management system, such as SINEMA Server, which has been especially designed for industrial applications, problems can be detected at an early stage and appropriate measures taken in good time.

**More information**

Further information on SINEMA Server Basic can be found at: [www.siemens.com/sinema](http://www.siemens.com/sinema)

SINEMA Server V12 software (including 21 trial license); download at: <http://support.automation.siemens.com/WW/view/en/74758725>

**Note:**

In many SIMATIC NET components with a management function, extensive parameterization and diagnostics functions are provided over open protocols and interfaces (e.g. Web server, network management).

These open interfaces provide access to those components, which can also be used for illicit activities.

When the above-mentioned functions and the open interfaces and protocols are used (e.g. SNMP, HTTP and Telnet), appropriate security precautions must be implemented to suppress unauthorized access to the components or network, especially from the WAN/Internet.

Even a single failure in the network during operation can result in a rush of alarms from various network nodes which are connected together. The combination of topology know-how with the diagnostics values of individual network nodes is decisive in order to rapidly identify the location and eliminate the cause of a network fault. A complete physical map of the network permits analysis of the possible effects of cable or device faults. This is helpful when planning high-availability applications.

This established system, that has already been an essential component of network availability in the IT sector for years, is now also becoming a worthwhile addition to the production environment.

The SINEMA Server software provides maximum transparency in industrial networks through automatic topology recognition, constant network monitoring as well as comprehensive diagnostics and reporting functions.

The most important applications at a glance:

- Automatic documentation of networks:  
Do you have up-to-date and complete documentation for your networked automation system?
- Application-specific structuring and visualization of a network:  
Do you have a simple, graphical overview of the devices in your plant network?
- Reporting of changes and faults in the network:  
Are you notified about new devices and network faults in plant operation?
- Analysis of changes and faults in the network:  
Have you already had a plant standstill caused by a sporadic network failure?
- Integration of network diagnostics into HMI/SCADA:  
Can you also monitor the status of the network with your HMI SCADA system?
- Adaptation of monitoring functionality to devices and users:  
Can you adapt your network diagnostics to the individual devices and the users?

For this reason, automation networks should be isolated from the remaining corporate network using appropriate security products (e.g. SCALANCE S).

For further information, see the section on "Industrial Security".

It is important to note the boundary conditions for use of the specified SIMATIC Net products (order numbers 6GK..., 6XV1) which you can view on the Internet.

You will find more information on the Internet at:

<http://www.siemens.com/simatic-net/ik-info>

# PROFINET/Industrial Ethernet

## Industrial Ethernet

### Data communication

#### Overview

##### Standard communication

This comprises standardized protocols for data communication.

##### ISO, TCP/IP, UDP transport protocols

ISO, TCP/IP and UDP are available as transport protocols.

##### PROFINET

Based on Industrial Ethernet, PROFINET enables direct communication of field devices (IO Devices) with controllers (IO Controllers) as well the solution of isochronous drive controls for motion control applications.

##### Media Redundancy Protocol (MRP)

Procedure specified in the IEC 61158 Type 10 standard for increasing the network availability in a ring topology.

##### Parallel Redundancy Protocol (PRP)

Procedure for smooth redundancy in accordance with the IEC 62439-3 standard to set up parallel, separate networks in which high availability is demanded. The PRP redundancy procedure is based on double transmission of frames over two separate networks (LAN A, LAN B).

##### Information technology (IT)

IT integrates SIMATIC into the information technology via Industrial Ethernet. These means of communication and communication paths are also available to SIMATIC. Depending on the product and stage of expansion, SIMATIC or the appropriate communication processors support technologies from the IT environment such as:

- **E-mail;**  
Via the integral e-mail client, network components, communications processors and network transitions can send emails to provide information about plant states, e.g. plant standstill or imminent overload, or to automatically request a service call.
- **Freely definable HTML pages;**  
Communications processors can perform web diagnostics with the aid of static HTML pages and a user-specific display is supported with the aid of freely definable HTML pages.
- **FTP;**  
The file transfer protocol (FTP) permits simple, universal coupling, e.g. the PLC can be connected to different computers or embedded systems

##### IP routing (IP-R)

The system connections for the SIMATIC S7 to Industrial Ethernet, such as CP 343-1 Advanced or CP 443-1 Advanced, with two separate interfaces (integrated network separation) and SCALANCE S and SCALANCE XM-400/XR-500, support the forwarding of IP messages between Gigabit and PROFINET interfaces. The SCALANCE M mobile wireless routers support routing between the mobile Internet and the connected LAN.

##### OPC (Openness, Productivity & Collaboration)

OPC is a standardized, open, and vendor-independent interface that is widely used in automation. It permits the connection of OPC-capable applications using many different protocols such as S7-communication, PROFINET, and SNMP.

##### PG/OP communication

The SIMATIC automation systems can handle data communication with HMI devices (e.g. TP/OP) and programming devices (with STEP 7, STEP 5) via the integral communication functions. PG/OP communication is supported by MPI, PROFIBUS and Industrial Ethernet.

##### S7 communication

S7 communication is the integral communications function (SFB), which has been optimized within the SIMATIC S7. It enables PCs and workstations to be connected. The maximum volume of user data per task is 64 KB. S7 communication offers simple, powerful communication services and provides a network independent software interface for all networks.

##### Open communication

The open communication (SEND/RECEIVE) allows the SIMATIC S7 controller to communicate with other SIMATIC S7 and SIMATIC S5 controllers, PCs and third-party systems. In addition, for the simple connection of HMI stations, FETCH and WRITE are offered.

##### BACnet communication

BACnet (Building Automation and Control Networks) is an ASHRAE (American Society of Heating, Refrigeration and Air Conditioning Engineers Inc.) communication protocol for data networks used for building automation and control. It is equally suitable for the management and automation levels, and is approved as an ANSI, CEN and ISO standard.

##### MES/ERP communication (ERPConnect)

Communication with ERP or MES systems via database link, e.g. ORACLE, MySQL, MS-SQL, DB2 using a firmware expansion which must be ordered separately

##### System connections

For many data terminals, communications modules (CPs, CMs, TIMs) are available that already have the communications functions implemented as firmware and which therefore relieve the data terminal of communication tasks (e.g. flow control, blocking, etc.).

##### Time synchronization

With SIMATIC procedures, the Network Time Protocol (NTP/SNTP) or IEEE1588, various procedures for clock time synchronization are available.





**Overview**

	Hardware	PROFINET					Ethernet communication					IT communication					Security			Transport protocol				Time			Other								
		IO Controller	IO Device	IRT real-time	CBA	MRP	MRPD	Send/Receive	Fetch/Write	TSend/TReceive	S7 communication	PG/OP communication	S7 routing	Web diagnosis	own web pages	send e-mail	receive e-mail	Filetransfer client	Filetransfer server	Access List ACL	SPI firewall	VPN (IP-Sec)	ISO	TCP	UDP	IPv4	IPv6	IP routing	Sender	Receiver	Transfer	PRP	ERP Connect	SNMP	NTP
SIMATIC S7-200	CP 243-1								•	•		•	•	•		•	•							•										○	
SIMATIC S7-1200	S7-1200 CPUs	•							•	•	•	•	•	•										•	•	•			•				○	•	
	CP 1243-1								•	•	•	•	•	• <sup>2)</sup>						•	•	•		•	•	•	○		•				○	•	
SIMATIC S7-1500	CPU 1511-1 PN	•	•	•		•			•	•	•	•	•	•					•					•	•	•		•	•				○	•	
	CPU 1513-1 PN	•	•	•		•			•	•	•	•	•	•					•					•	•	•		•	•				○	•	
	CPU 1516-3 PN/DP	•	•	•		•			•	•	•	•	•	•					•					•	•	•		•	•				○	•	
	CP 1543-1						•	•	•	•	•	•	•	• <sup>2)</sup>		•		•	•	•	•	•	•	•	•	•	○		•	•				•	•
	CM 1542-1	•		•		•				•	•	•	•	• <sup>2)</sup>		○ <sup>1)</sup>									•	•	•		•	•				•	•
SIMATIC S7-300	S7-300 PN CPUs	•	•	•	•	•			•	○ <sup>3)</sup>	•	•	•	•					•					•	•	•		•	•					•	
	CP 343-1 Lean		•			•	•		•	•	•	•	•						•					•	•	•		•	•					•	•
	CP 343-1	•	•			•	•		•	•	•	•	•						•				•	•	•			•	•					•	•
	CP 343-1 Adv	•	•	•	•	•		•	•		•	•	•	•	•		•	•	•	•	•	•	•	•	•		•	•						•	•
	CP 343-1 ERPC						•	•		•	•	•	•	•					•					•	•	•		•	•			•	○	•	•
SIMATIC S7-400	S7-400 PN CPUs	•	•	•	•	•			•	•	•	•	•	•										•	•	•		•	•						•
	CP 443-1	•		•		•	•		○ <sup>4)</sup>	•	•	•	•	•					•				•	•	•	•			•					•	•
	CP 443-1 Adv	•		•	•	•		•	○ <sup>4)</sup>	•	•	•	•	•	•		•	•	•	•	•	•	•	•	•		•	•						•	•
	CP 443-1 RNA						•	•	•	•	•	•	•	•					•				•	•	•	•			•	•				•	•

1) SMTP pass-through only  
 2) via S7-1200/1500 CPU  
 3) Server (S) only  
 4) pass-through only

• applies  
 ○ with reservations

G\_1K10\_XX\_10369

Communications overview for SIMATIC

# PROFINET/Industrial Ethernet

## Industrial Ethernet

### Communication overview

#### Overview (continued)

Hardware	Software	Operation system (64 bit)								Operation system (32 bit)								Other operation systems		Transport protocol			PROFINET		MRP	IT	PG/OP	S7 communication		Open communication		Time						
		Windows 8 Pro	Windows 7 Professional / Ultimate + SP 1	Windows Server 2012	Windows Server 2008 R2	Windows 8 Pro	Windows 7 Professional / Ultimate + SP 1	Vista Business / Ultimate + SP1/2 <sup>8)</sup>	Windows XP Pro + SP3 <sup>8)</sup>	Windows Server 2008 + SP1/2	Windows Server 2003 R2 / SP2 <sup>8)</sup>	Linux	OPC	ISO	TCP	UDP	IO Controller	IO Device	MRP	IT	PG/OP	Standard system	High-availability communication	SEND/RECV	Fetch/Write	SICLOCK	NTP											
CP 1604 (PCI 104) CP 1616 (PCI 32 Bit)	DK-16xx PN IO	•	•				•	•			• <sup>4)</sup>			•		•	•	•																				
CP 1613 A2 (PCI 32 Bit)	HARDNET-IE S7 (S7-1613)	•	•	•	•	•	•	•	•	•		•	•	•	○ <sup>3)</sup>				○ <sup>6)</sup>	•	•		•	•	•	•	•	•	•	•	•	•						
	HARDNET-IE S7-REDCONNECT (S7-REDCONNECT)	•	•	•	•	•	•	•	•	•		•	•	•	○ <sup>3)</sup>				○ <sup>6)</sup>	•	•	•	•	•	•	•	•	•	•	•	•	•	•					
CP 1623 (PCIe x1)	S7 OPC Redundancy for Industrial Ethernet				•							•									•																	
CP 1628 (PCIe x1)	HARDNET-IE S7 (S7-1613)	•	•	•	•	•	•					•	•	•	○ <sup>3)</sup>				○ <sup>6)</sup>	•	•		•	•	•	•	•	•	•	•	•	•	•	•				
	HARDNET-IE S7-REDCONNECT (S7-REDCONNECT)	•	•	•	•	•	•					•	•	•	○ <sup>3)</sup>				○ <sup>6)</sup>	•	•	•	•	•	•	•	•	•	•	•	•	•	•	•	•			
	S7 OPC Redundancy for Industrial Ethernet				•							•									•																	
CP 1612 A2 <sup>7)</sup> (PCI 32 Bit)	SOFTNET-IE S7 (SOFTNET-S7)	•	•	•	•	•	•	•	•	•		•	•	•	○ <sup>3)</sup>				○ <sup>3)</sup>	•	•		•	•	•	•	•	•	•	•	•	•	•	•	•			
	SOFTNET-IE S7 Lean (SOFTNET-S7 Lean)	•	•	•	•	•	•	•	•	•		•	•	•	○ <sup>3)</sup>				○ <sup>3)</sup>	•	•		•	•	•	•	•	•	•	•	•	•	•	•	•	•		
	SOFTNET-IE PG (SOFTNET-PG)	•	•	•	•	•	•	•	•	•		•	• <sup>2)</sup>	• <sup>2)</sup>					○ <sup>3)</sup>	•																		
SIMATIC PG/PC with integrated interface <sup>1)</sup>	SOFTNET-IE RNA	•	•	•	•	•	•		•			•							○ <sup>6)</sup>																			
	SOFTNET-IE S7-REDCONNECT/M	•	•	•	•	•	•					•	•						○ <sup>3)</sup>	•	•		•	•														
	SOFTNET-IE PN IO (SOFTNET PN IO)	•	•	•	•	•	•	•	•	•		•							○ <sup>3)</sup>																			
	S7 OPC Redundancy for Industrial Ethernet				•							•									•																	

1) For info on other hardware, see [www.siemens.com/simatic-net/ik-info](http://www.siemens.com/simatic-net/ik-info)  
 2) PG/OP communication  
 3) IT, FTP and UDP functionalities arise in conjunction with the hardware/the CPs and the Windows/Linux software of the PC  
 4) Software source of the card driver included; for Suse 12  
 5) by means of driver porting  
 6) with SNMP  
 7) CP 1612 A2 is not approved for Win 8  
 8) on SIMATIC NET DVD

• suitable  
 ○ suitable under certain conditions

G\_IK10\_XX\_10058

Communications overview for PG/PC

**Overview****Network performance and network technologies for Industrial Ethernet**

When combined, the current Industrial Ethernet technologies can significantly boost performance on the network in comparison with the original 10 Mbit/s technology. These technologies are:

- **Fast Ethernet** with 100 Mbit/s:  
Compared to 10 Mbit/s, messages are transported much faster and therefore only occupy the cable for an extremely short time. For Fast Ethernet, a 4-wire FastConnect cabling system (Cat5e) is available with cable, plug and outlet.
- **Gigabit Ethernet** at 1 Gbit/s:  
As Gigabit Ethernet is faster than Fast Ethernet by a factor of 10, the cable is occupied for only one tenth of the time. For Gigabit Ethernet, an 8-wire FastConnect cabling system (Cat6) is available with cable, plug and outlet.
- **Gigabit Ethernet** at 10 Gbit/s:  
Compared to Ethernet with 1 Gbit/s, Ethernet with 10 Gbit/s is faster again by a factor of 10.
- **Full Duplex** prevents collisions:  
Data can be sent and received simultaneously between two switches. The data throughput for a full-duplex connection therefore rises to 200 Mbit/s with Fast Ethernet and to 2 Gbit/s with Gigabit Ethernet. With full duplex, a greater length of the network is possible. This means, for example, that when glass fiber-optic cables are used, distances of up to 200 km can be achieved.  
The data throughput increases enormously because the usual frame repetitions are avoided.
- **Switching** reduces the network data traffic:  
The switch dynamically "connects" those stations that are currently communicating. In the overall network, several messages can therefore be en-route simultaneously. The gain in performance derives from the fact that several message frames can pass the switch simultaneously (as they are in parallel).
- **Autocrossover** automatically crosses the send and receive cables on Twisted Pair interfaces.
- **Autosensing** describes the characteristic of network nodes (data terminals and network components) that automatically detect the transmission rate of a signal (10 Mbit/s, 100 Mbit/s or 1 Gbit/s) and support autonegotiation.
- **Autonegotiation** is a configuration protocol on Fast Ethernet. Before initiating the actual data transmission, network devices automatically negotiate a transmission mode which is supported by any device (1 000 Mbit/s, 100 Mbit/s or 10 Mbit/s, full duplex or half duplex)

**Ethernet Switching**

The Industrial Ethernet switch has the following functionality:

- Depending on the number of available interfaces, switches are able to simultaneously interconnect several pairs of subnetworks or stations temporarily and dynamically, with each connection possessing the full data throughput.
- By filtering the data traffic on the basis of the Ethernet (MAC) address of the terminals, the data traffic remains local and only data intended for nodes of another subnetwork is forwarded by the switch.
- More data terminals can be connected than in a classic Ethernet network.
- Error propagation is limited to the subnetwork concerned.

The switching technology offers definite advantages:

- Subnetworks and network segments can be created.
- The data throughput is increased and with it the network performance as a result of structuring the data communication.
- Easy rules for network configuration.
- Unlimited extension of the network by connecting individual collision domains/subnetworks.
- Easy, reaction-free extension of existing networks.

**Full duplex**

Full duplex (FDX) is an operating mode in the network that, in contrast to half duplex, allows stations to send and receive data simultaneously. When FDX is used, collision detection is automatically deactivated in the participating stations.

For FDX, transmission media with separate send and receive channels must be used, e.g. FOC and TP, and the participating components must be able to store data packages. With an FDX connection collisions do not occur, so components that support FDX can send and receive simultaneously at the nominal transmission rate. The data throughput therefore increases to twice the nominal transmission rate of the network, to 20 Mbit/s with the classic Ethernet and 200 Mbit/s with Fast Ethernet. With Gigabit Ethernet, up to 2 000 Mbit/s are achieved.

A further advantage of FDX is the increase in the network extension.

By deactivating the collision principle, the distance between two components can be increased by the size of a collision domain or more. With full duplex, the maximum distance can extend as far as the performance limit of the send and receive components. This is especially the case in connection with fiber-optic cables. When glass fiber-optic cables are used, distances of up to 200 km can be achieved between two switches.

## PROFINET/Industrial Ethernet

### Industrial Ethernet

#### Topologies

#### Overview (continued)

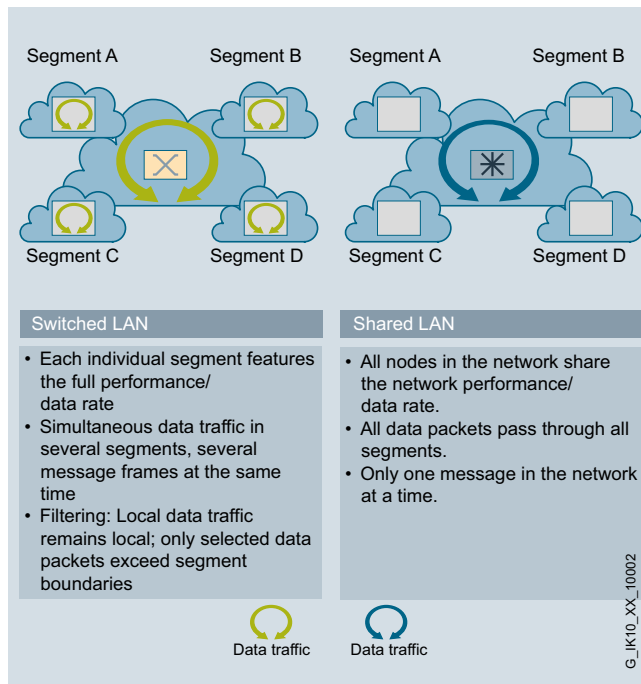

Increased performance through switching, full duplex

#### Autosensing/Autonegotiation

Autosensing describes the characteristic of network nodes (data terminals and network components) that automatically detect the transmission rate of a signal (10 Mbit/s, 100 Mbit/s or 1 000 Mbit/s) and support autonegotiation.

Autonegotiation is the configuration protocol for Twisted Pair. It enables the participating nodes to negotiate and agree the transmission rate before the first data packages are transferred:

- 10 Mbit/s, 100 Mbit/s, 1 Gbit/s or 10 Gbit/s
- Full duplex or half duplex

Autonegotiation can also be deactivated if a specific transmission rate has to be defined.

The advantage with Autosensing lies in the interoperability of all Ethernet components.

Classic Ethernet components that do not support Autosensing work together with Fast Ethernet and new Gigabit Ethernet components that do support Autosensing.

#### Autocrossover

The Autocrossover function automatically crosses the send and receive cables on Twisted Pair interfaces. This means that crossed connecting lines (e.g. TP XP Cords) are no longer required.

#### High Speed Redundancy Protocol (HRP)

Extremely fast reconfiguration of the network following an error is indispensable for industrial applications, because the connected data terminals will otherwise disconnect logical communication links. This would result in a process running out of control or emergency shutdown of the plant.

In order to achieve the very fast reaction times required, various standardized procedures are used. A network can then be reconfigured to form a functional network infrastructure again in a fraction of a second.

In an optical ring comprising 50 switches, the network will be reconfigured after a fault (cable break or switch failure) in less than 300 ms.

In addition to implementing high-speed media redundancy in the ring, Industrial Ethernet switches also offer the functions required for high-speed redundant coupling of rings or network segments. Network segments in any topology or rings can be coupled via two switches in each case.

**Overview** (continued)

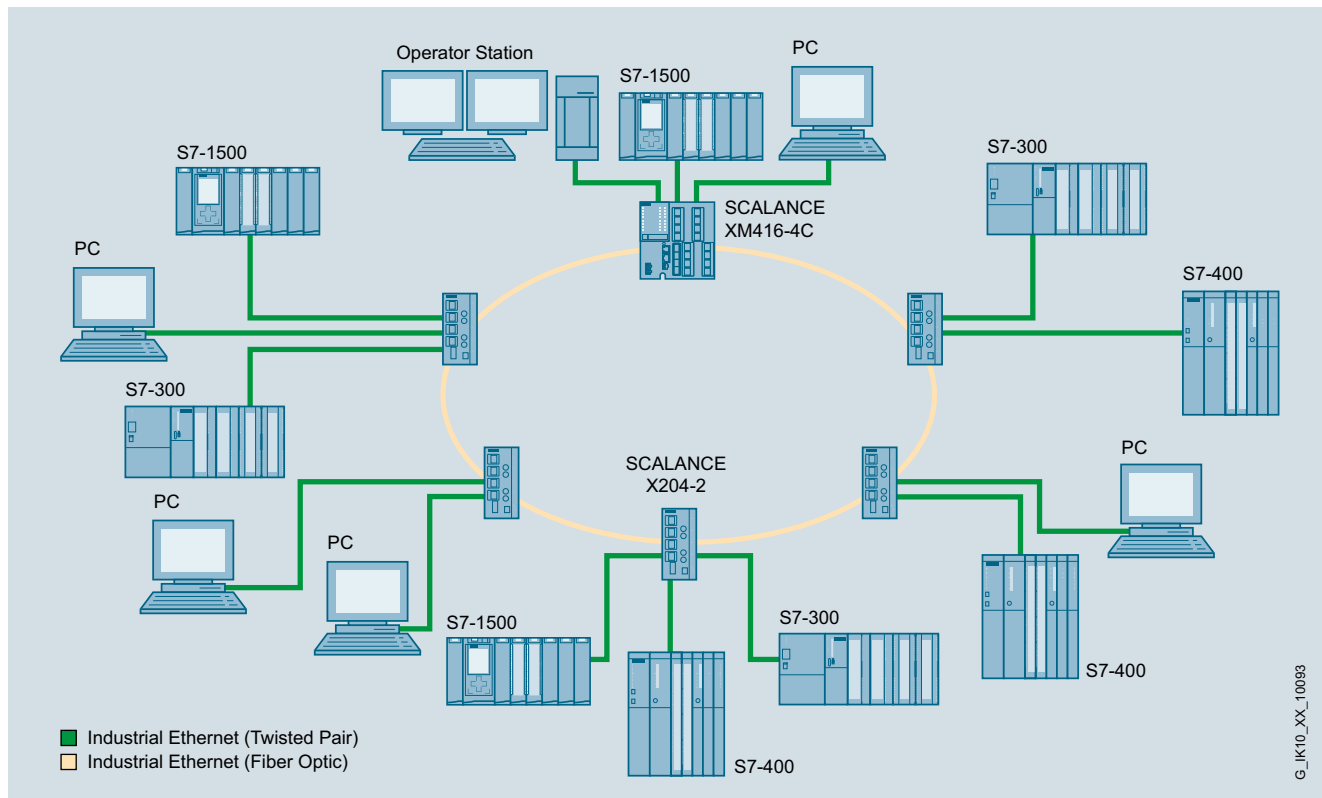

Configuration with high-speed redundancy in the optical ring

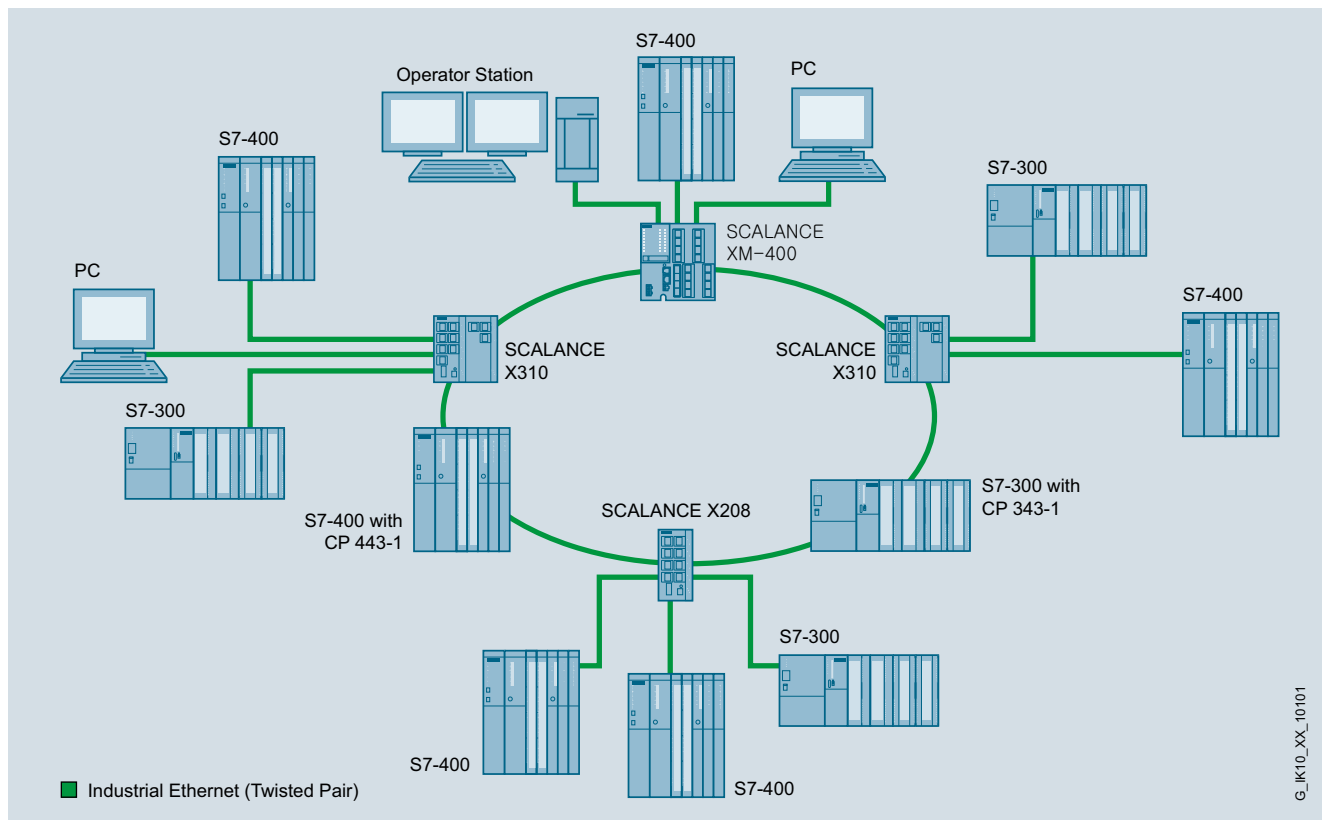

Configuration with high-speed redundancy in the electrical ring

# PROFINET/Industrial Ethernet

## Industrial Ethernet

### Topologies

#### Overview (continued)

#### Media Redundancy Protocol (MRP)

A further option for attaining greater system availability is PROFINET MRP. The media redundancy can be created on the one hand by means of switches, and on the other hand direct via the PROFINET interfaces on SIMATIC controllers and distributed inputs/outputs. Thanks to the MRP protocol (IEC 61158 Type 10), reconfiguration times of less than 200 ms can be achieved, depending on the number of stations.

If the ring is interrupted at one point, immediate reconfiguration takes place and all communication nodes continue to be accessible.

2

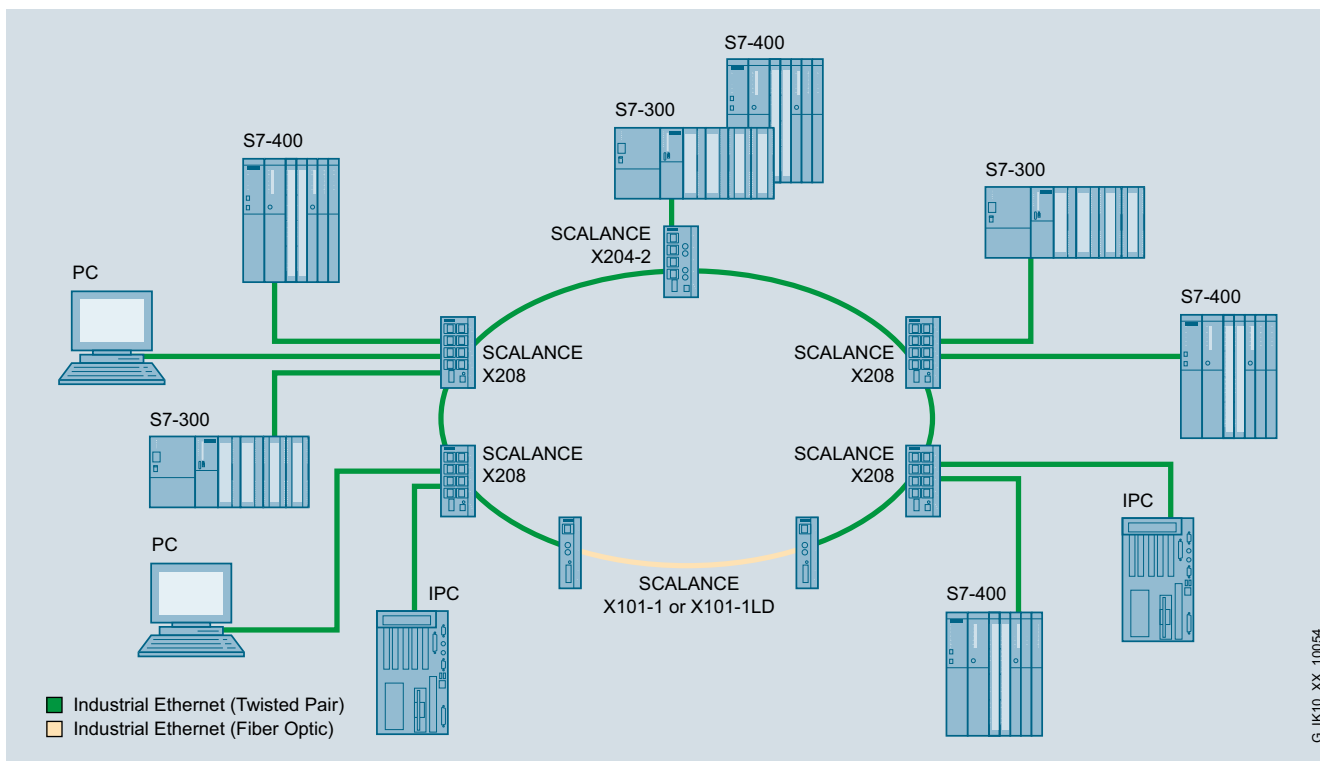

Electrical/optical ring topology with SCALANCE X101-1/X101-1LD

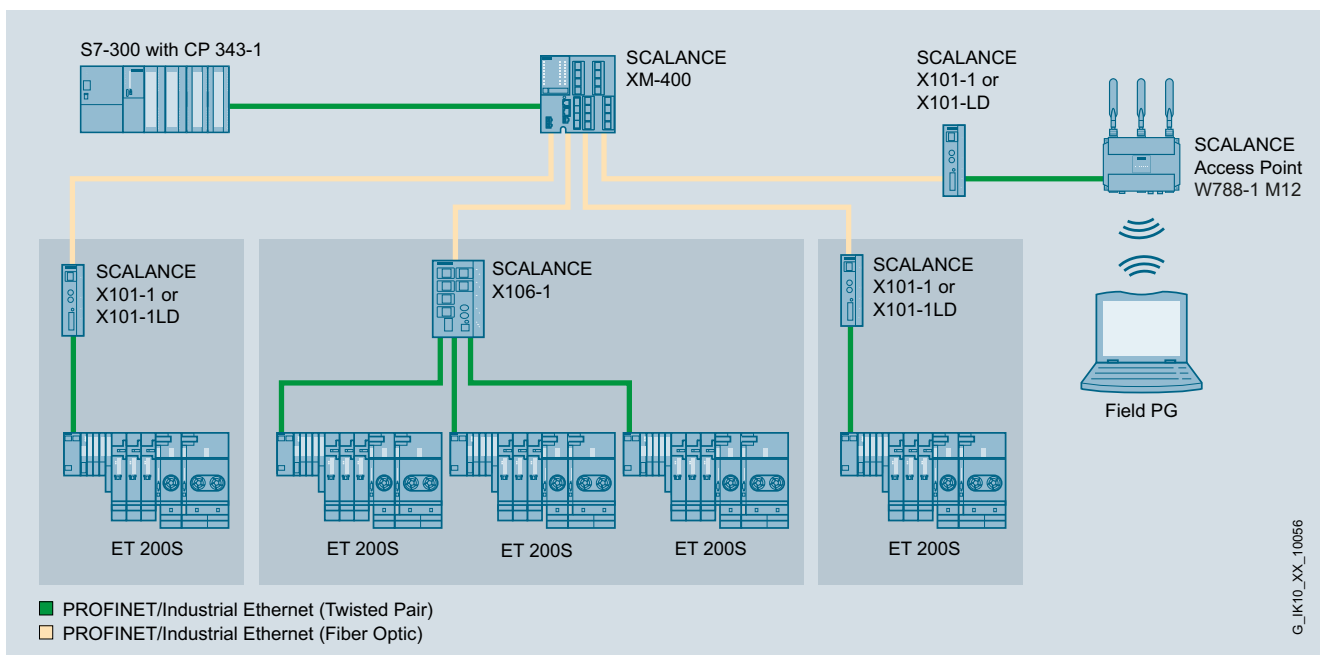

Optical star topology with SCALANCE X101-1/X101-1LD and remote SCALANCE W Access Point



#### Overview (continued)

##### Seamless redundancy

For some applications with particularly high requirements in terms of the reconfiguration time, there is the possibility of setting up a redundant network without any reconfiguration time at all (seamless redundancy).

For this purpose, PROFINET offers the MRPD standard (Media Redundancy for Planned Duplication). This method is based on the topology-optimized IRT communication.

Two other solutions that can be used are High-availability Seamless Redundancy (HSR) and Parallel Redundancy Protocol (PRP) of the IEC 62439-3 standard.

All methods facilitate networks that continue to function in the event of a fault (e.g.: cable break) WITHOUT interruption. This is achieved by duplicating the data packets at the sender and then transmitting them to the recipient over two different paths.

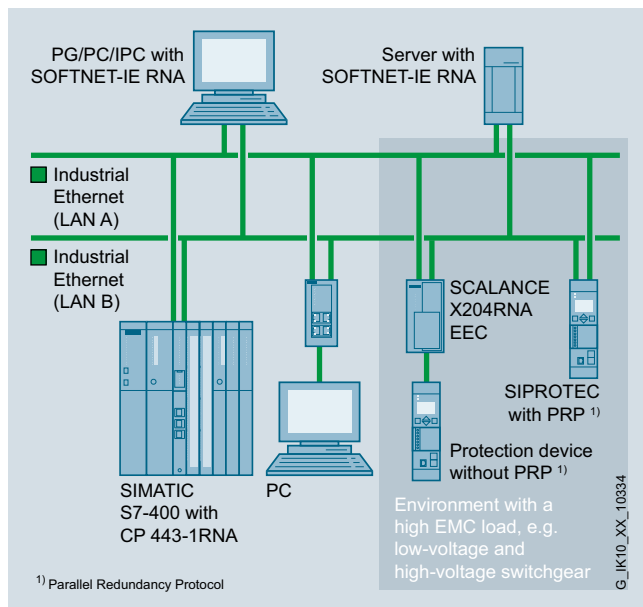

Bumpless, parallel networks with PRP redundancy procedure

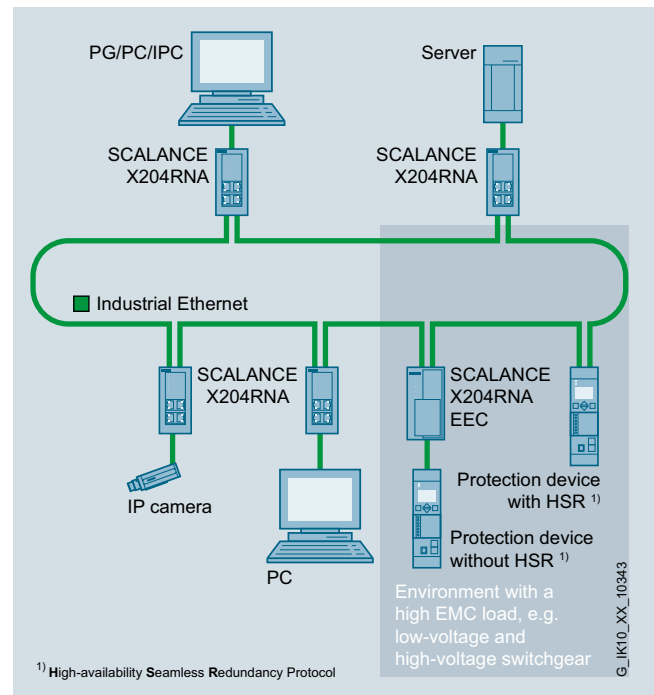

Bumpless, ring-shaped network with HSR redundancy procedure

##### Redundancy with the Spanning Tree algorithm

The Spanning Tree algorithm is described in the IEEE 802.1D standard; it organizes any number of meshed Ethernet structures comprising bridges and switches.

To prevent data packages circulating in the network, in the case of closed meshes different connections are switched to standby so that an open tree structure results from the meshed structure.

For this purpose, switches communicate with each other using the Spanning Tree Protocol. This protocol is extremely complex because it has to handle any type of network structure.

The organization of network structures with the Spanning Tree protocol can take from 30 to 60 seconds. During this period, productive communication for reliable visualization or process control in the network is not possible.

In the time-optimized variant "Rapid Reconfiguration Spanning Tree" according to IEEE 802.1, the time is shortened to between 1 and 3 seconds for up to 10 series-connected switches.

Due to the comparatively long reconfiguration time, this protocol is used predominantly in office networks. For connecting to such office networks, some SIMATIC NET switches support the Rapid Spanning Tree Protocol.

## PROFINET/Industrial Ethernet

### Industrial Ethernet

#### Topologies

##### Overview (continued)

##### Switched network

Switched industrial networks can be configured electrically or optically with a linear, star or ring structure, or a combination.

They are constructed with SCALANCE X switches and with switches integrated into terminal devices, e.g. in communications processors.

As the transmission medium between the switches and for connection to the terminal devices electrical cables (e.g. twisted pair cables) or fiber optic cables are used.

Switched networks can be of any size. In networks of a larger scale (depending on the application) the signal delays are to be considered.

##### Optical cabling with POF/PCF or glass fiber optic cable

Fiber-optic cables are always recommended as an alternative to copper cables in environments subject to strong electromagnetic interference (EMI) if reliable equipotential bonding cannot be guaranteed, or if the system is in the open air.

Glass fiber optic cables are used for data transmission over long distances, while for shorter distances, plastic fiber optic cable made of light-conducting plastics like polymer optical fiber (POF), or plastic covered glass fibers such as polymer clad fiber (PCF), are used.

Simple fiber-optic cabling for machine-level use is implemented with the SC RJ connection system for polymer optical fiber and PCF. The SC RJ connectors can be assembled especially quickly and simply on-site. The plastic fiber optic cables designed for this purpose can be used universally or specifically in festoon cable systems.

For optical cabling, e.g. for a PROFINET system, products with POF or PCF connection are used, e.g. the Industrial Ethernet Switch SCALANCE X200-4P IRT, ET 200S distributed I/O, or the SCALANCE X101-1POF media converter.

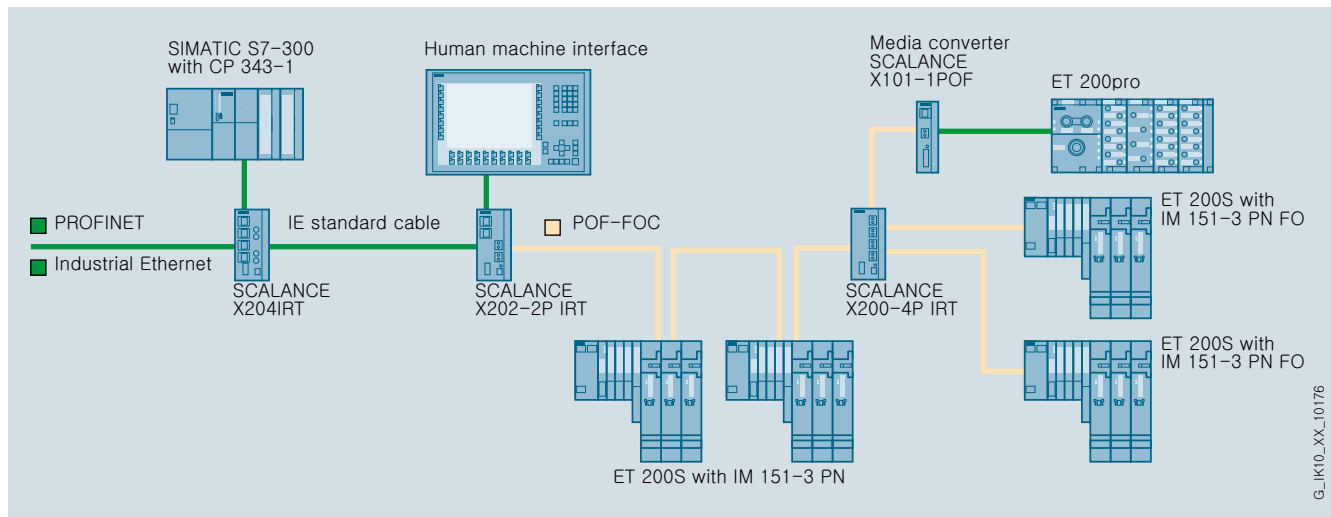

Mixed network with SCALANCE X202-2P IRT and SCALANCE X101-1POF media converter

G\_IK10\_XX\_10176

**Overview** (continued)

**Fault-tolerant communication**

The availability of the communication is increased by means of redundant communication connections, to which the data transmission can be switched quickly in the event of a fault.

Fault-tolerant S7-connections can be set up from S7-400H stations to

- Other H stations (one- or two-channel)
- PCs (S7-REDCONNECT software required)

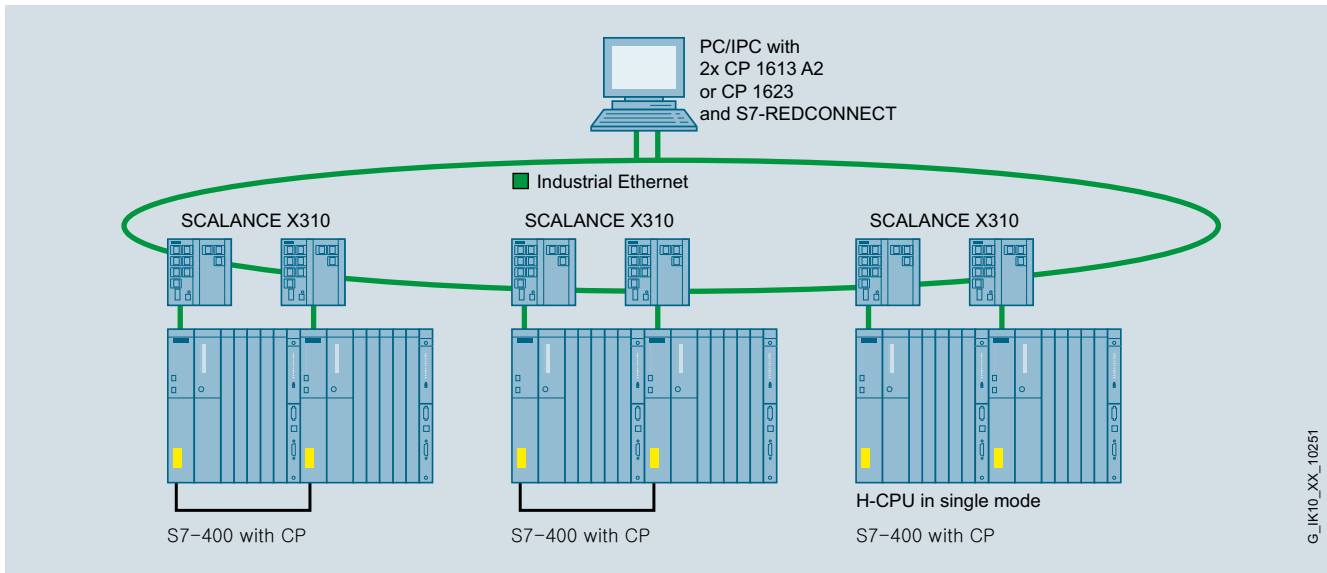

Increased availability by means of redundant communication connections

**Gigabit at the control level**

Whereas in the field level, short response times and small data message frames are in the forefront, the need for high data throughput is constantly increasing in the control level. The reason for this is the rapidly growing number of nodes and data-intensive systems such as HMI, SCADA, code reading systems, web applications or multimedia applications.

In addition to the Gigabit-capable network infrastructure, there are also Gigabit-capable system connections for PCs or SIMATIC S7-300/400/1500. The CP 1623 communications processor for PCI Express supports a high-performance connection of the HMI/SCADA systems and simultaneously increases the reliability of the network by means of an optional external power supply.

The CP 343-1 Advanced and CP 443-1 Advanced communications processors for SIMATIC S7-300/400 implement integral network separation between the control level and field level and provide:

- Separate network connections on a module for the connection of two independent IP-subnetworks, e.g. control level is IP subnetwork 1 (Gigabit Ethernet) and the field level is IP subnetwork 2 (Fast Ethernet)
- Cross-network utilization of IT services through IP routing, such as access to Web servers
- Short response times for the lower-level field device connection with PROFINET
- Firewall for protecting the programmable controllers from unauthorized access regardless of the size of the network to be protected
- Supplementary or alternative VPN tunnel (**V**irtual **P**riate **N**etwork) for secure authentication of the communication partners and encryption of the transmitted data

# PROFINET/Industrial Ethernet

## Industrial Ethernet

### Topologies

#### Overview (continued)

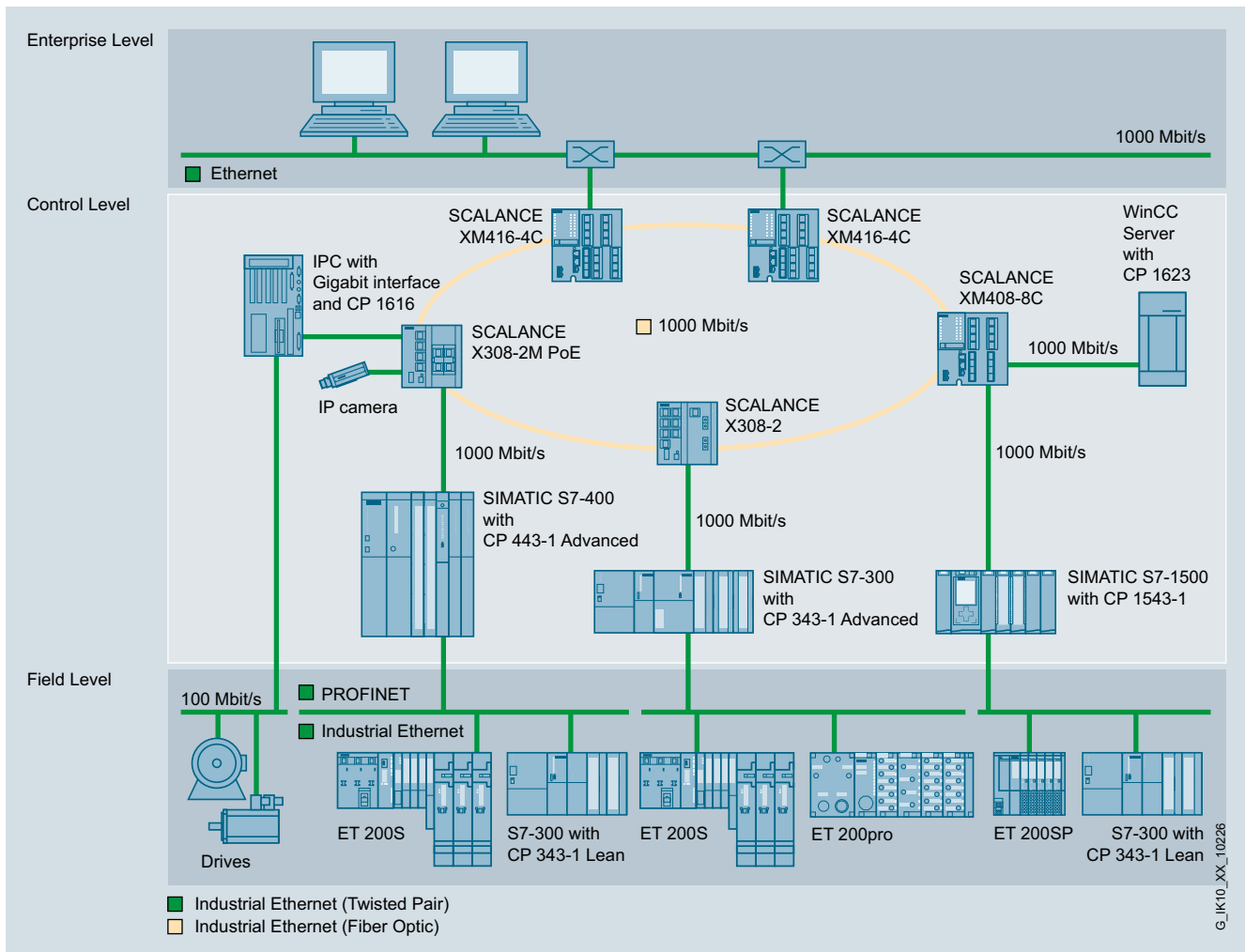

Network separation between field level and control level including Gigabit communication at the control level

#### Network separation between field level and control level

Networks often have to be separated physically from one another, but nevertheless have to communicate with one another. Reasons for network separation are deliberate load decoupling or different responsibilities within an enterprise (e.g. office and production network).

When using the CP 343-1 Advanced and CP 443-1 Advanced communications processors for S7 controllers this requirement can easily be met. With the introduction of interfaces for separate IP subnetworks in Gigabit Ethernet and Fast Ethernet on one module, the cross-network use of IT services is possible by means of static IP routing. A firewall protects programmable controllers against unauthorized access regardless of the size of the network to be protected. As an alternative or supplement, secure authentication of the communication partners and encryption of the transmitted data can be handled via a VPN (Virtual Private Network).

**Overview** (continued)

**SIMATIC PCS 7 process control system with Gigabit**

In the control room, two SCALANCE X-400 switches are used on the terminal bus. If a high number of nodes are connected to the plant bus, SCALANCE XR-500 or XM-400 switches, for example, can be used with port extenders. These are connected together to create an electrical ring with a transfer rate of 1 Gbit/s.

Several operator panels are provided and divided between the two switches so that the system still be operated in the event of a failure. The terminal and plant buses are connected using redundant servers, e.g. with SCALANCE X408-2 also via high-performance Gigabit lines.

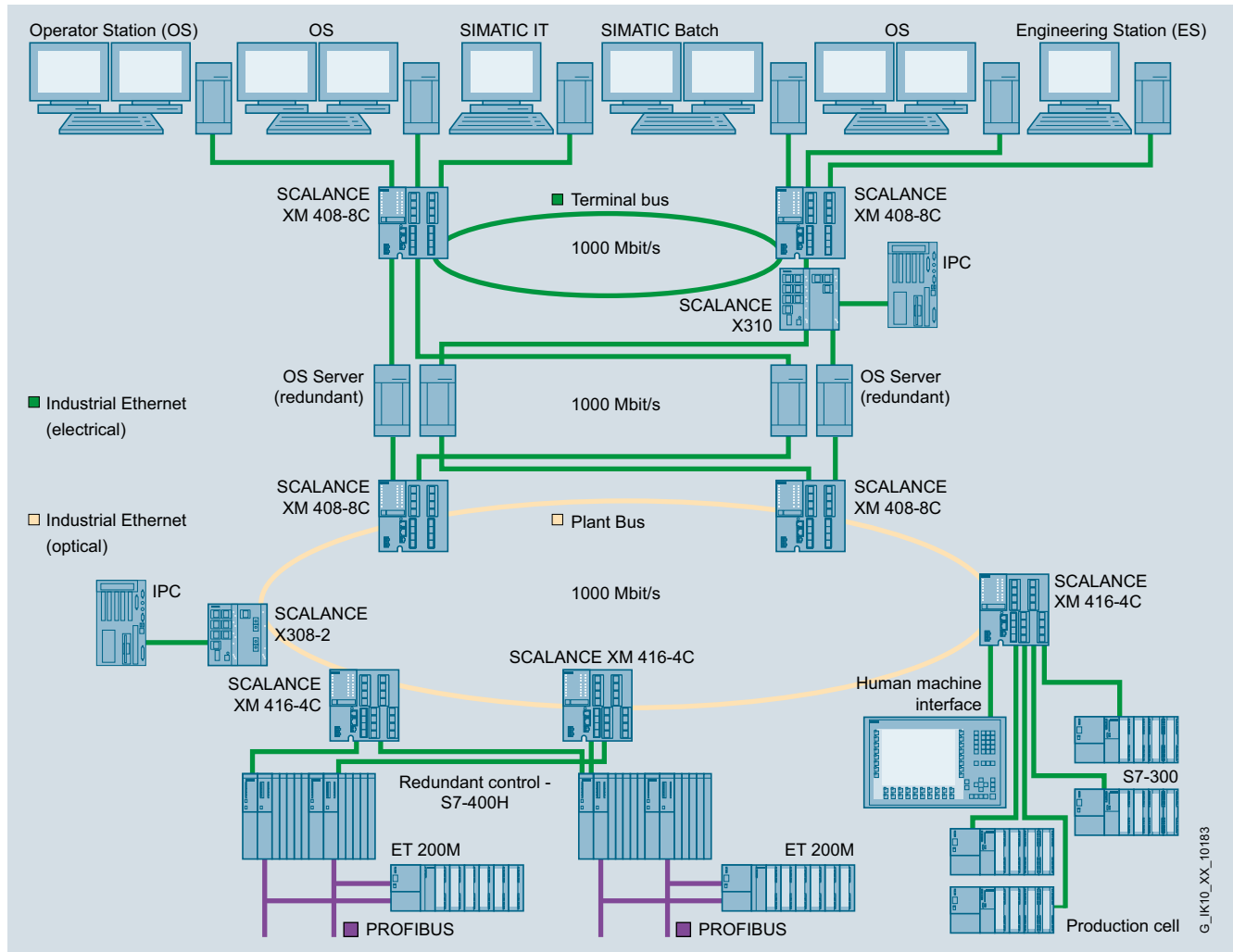

Use of the SCALANCE X switches in a process control system, e.g. PCS 7

# PROFINET/Industrial Ethernet

## Industrial Ethernet

### Topologies

#### Overview (continued)

2

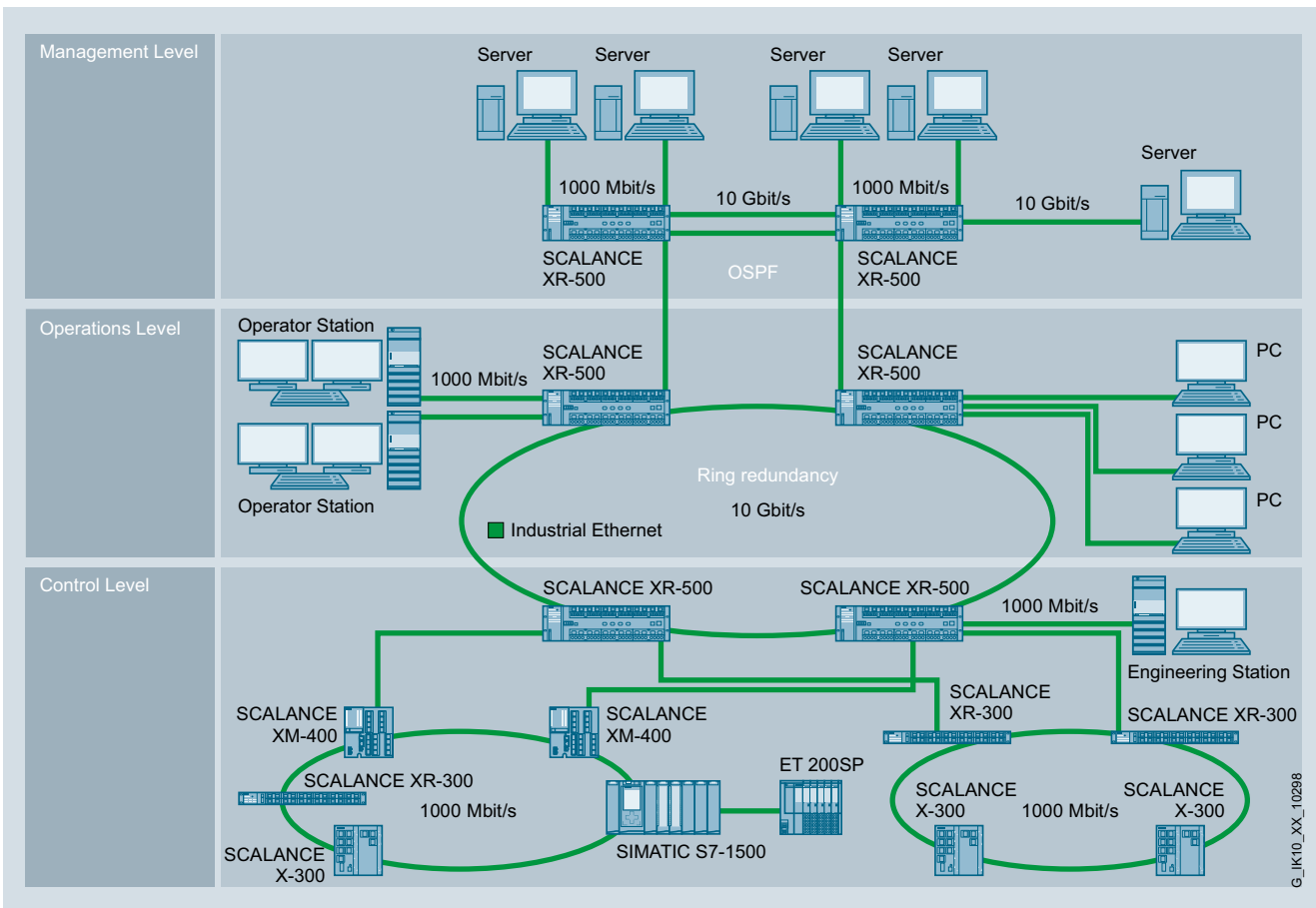

Plant network with connection to the management level or the corporate network with SCALANCE X-500

G\_IK10\_XX\_10298

#### Overview (continued)

#### Fail-safe wireless communication with PROFI-safe

For several years, safety engineering has been integrating into standard automation on the basis of SIMATIC S7 controllers, PROFIBUS and PROFI-safe.

This range has been expanded by PROFINET-enabled components, thus providing a complete product range with failsafe controllers, failsafe I/O and a corresponding engineering environment.

PROFI-safe prevents errors such as address corruption, loss, delay, etc., when transmitting messages through continuous numbering of the PROFI-safe data, time monitoring, and authenticity monitoring using passwords and optimized cyclic redundancy check (CRC).

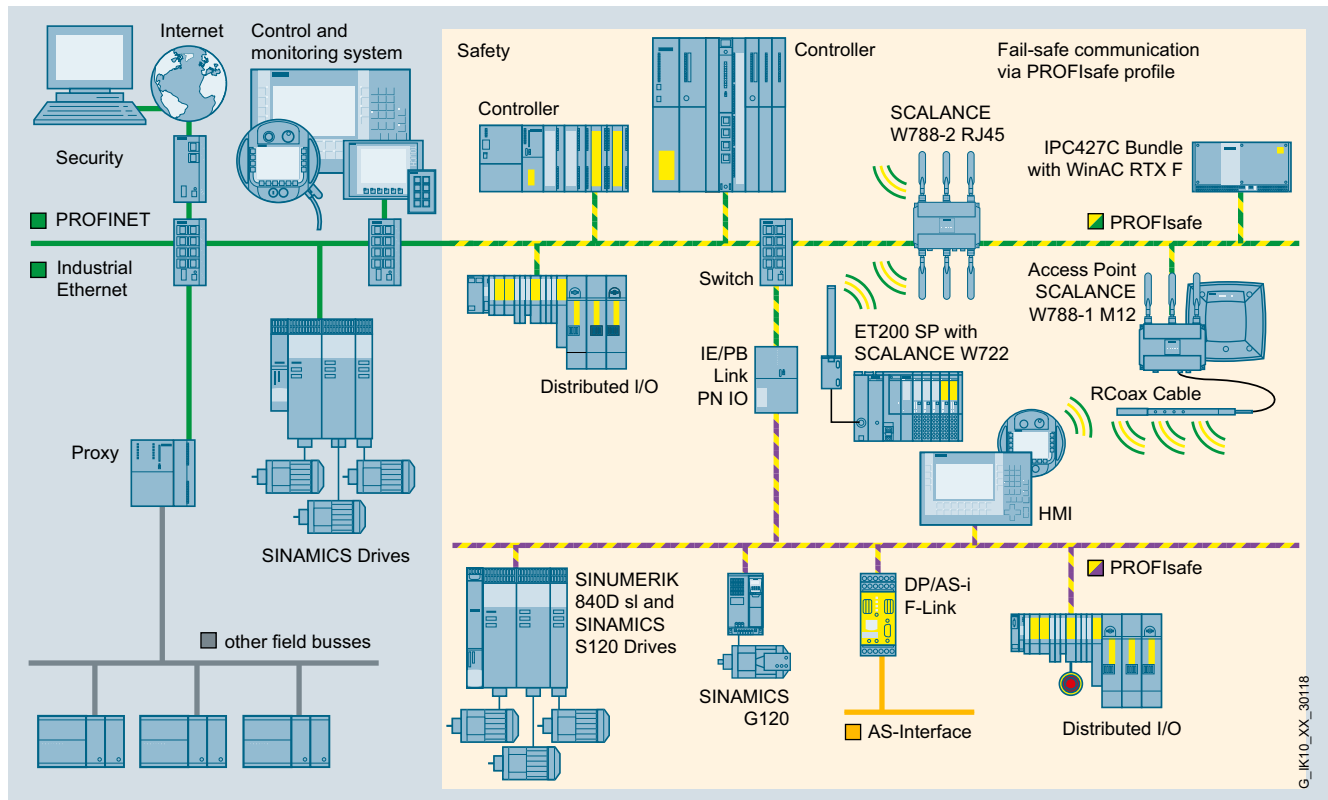

Fail-safe wireless communication with PROFI-safe

#### Coupling of networks

For a high-performance coupling of networks, the modular Industrial Ethernet Switch SCALANCE XM-400 is available. In the case of SCALANCE XM-400, high-speed IP routing permits communication between different IP subnetworks and routers. Methods supported for this include:

- Static routing
- Dynamic routing OSPF (open shortest path first) and
- RIPv1/2 (routing information protocol)
- Redundant routing VRRP (Virtual Router Redundancy Protocol)

# PROFINET/Industrial Ethernet

## Industrial Ethernet

### Topologies

#### Overview (continued)

2

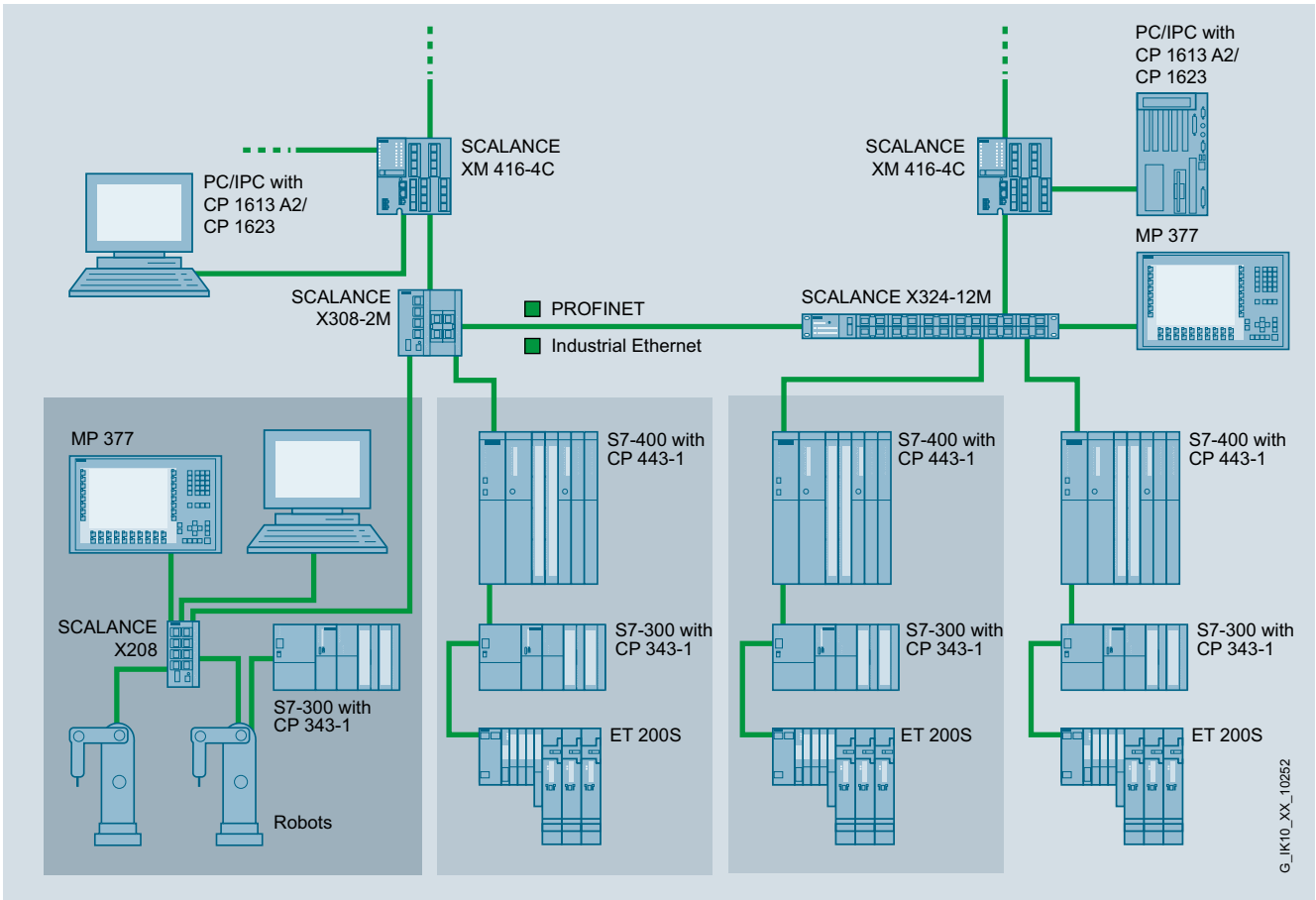

High-performance Layer 3 switching paired with redundant routing (VRRP)

G\_IK10\_XX\_10252



**Overview**

	Twisted pair network	Fiber optic network	Wireless network
Flexibility of the network topology	● ● ● ●	● ● ● ●	● ● ● ●
Suitability for high transmission rates	● ● ● ● ○ <sup>1)</sup>	● ● ● ● ● <sup>1)</sup>	● ● ● ○ ○
Inter-building networking	○ ○ ○ ○	● ● ● ●	● ● ● ○
EMC	● ● ● ○	● ● ● ●	● ● ● ●
Simple cable laying	● ● ● ○	● ● ● ○	—
Performance spectrum for special applications	Cables for indoor area; trailing cable; marine cable; FastConnect cables	Cables for indoor and outdoor area; trailing cable; halogen-free cable	—
Effect of voltage failure	Failure of a subnetwork <sup>2)</sup>	Failure of a subnetwork <sup>2)</sup>	Failure of a subnetwork <sup>2)</sup>
Effect of path failure	Network breaks down into two sub-networks functioning in isolation <sup>3)</sup>	Network breaks down into two sub-networks functioning in isolation <sup>3)</sup>	—
Max. network expansion	5000 m <sup>4)</sup>	Up to 150 km <sup>4)</sup> ; over 150 km, consider signal propagation time	—
Max. distance between two network nodes / Access Points	100 m	50 m POF 100 m PCF 4000-5000 m multimode 120 km single mode	30 m indoors per segment 100 m indoors per segment
Pre-assembled cables	Yes	Yes	—
Assembly on site	without special tool; FastConnect technology	without special tool; FastConnect technology	—
Integrated diagnostics support	LED indicators; signaling contact; SNMP network management; Web-based management, PROFINET diagnostics	LED indicators; signaling contact; SNMP network management; Web-based management, PROFINET diagnostics	LED indicators; SNMP network management; Web-based management, PROFINET diagnostics
Redundant network structures	Electrical ring or doubling of the infrastructure (linear, star, tree)	Optical ring or doubling of the infrastructure (linear, star, tree)	Multiple illumination or use of different frequency bands (2.4 and 5 GHz)
	<sup>1)</sup> suitable for 10 Mbit/s to 10 Gbit/s <sup>2)</sup> Safeguard against subnetwork failure by means of redundant voltage supply <sup>3)</sup> no effect in the case of ring structure <sup>4)</sup> if there are 50 switches in the ring		● ● ● ● suitable ● ● ● ○ partly suitable ● ● ○ ○ ● ○ ○ ○ ○ ○ ○ ○ not applicable

G\_IK10\_XX\_10013

Comparison of networking media

# PROFINET/Industrial Ethernet

## PROFINET

### Introduction

#### Overview

##### **PROFINET – the Ethernet standard for automation**

PROFINET is the leading Industrial Ethernet standard with more than 5.8 <sup>1)</sup> million nodes worldwide.

PROFINET increases companies' success by accelerating processes, boosting productivity, and increasing plant availability.

<sup>1)</sup> Source: PROFIBUS & PROFINET International (PI) Edition 2013

#### Advantages at a glance

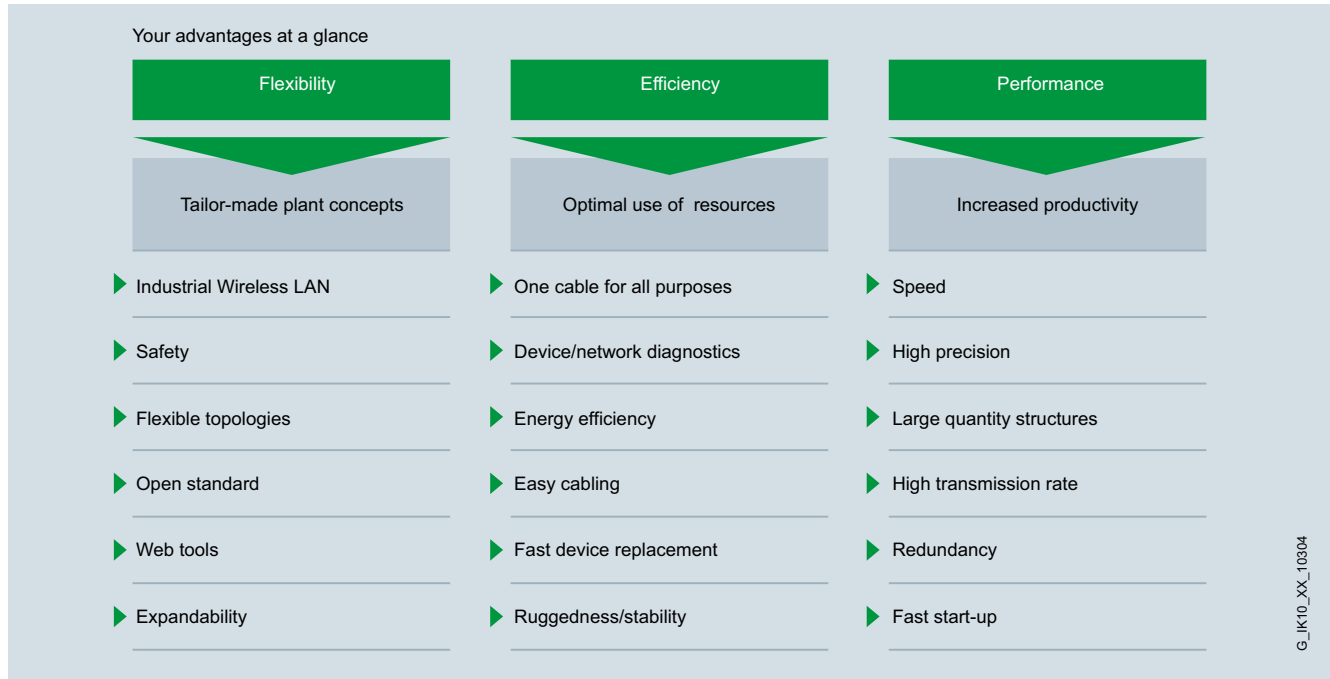

#### **Flexibility**

Short response times and optimized processes are prerequisites for competitiveness in global markets, because product life-cycles are becoming shorter and shorter.

PROFINET ensures maximum flexibility in plant structures and production processes, and it enables you to implement innovative machine and plant concepts. Mobile devices, for example, can be integrated into relatively inaccessible locations.

#### **IWLAN**

PROFINET also supports wireless communication with Industrial Wireless LAN and thus opens up new application fields. For example, technologies subject to wear such as contact wires can be replaced and automated guided vehicle systems and mobile operator panels can be used.

#### **Safety**

The PROFIsafe safety profile, which has been tried and tested with PROFIBUS and which permits the transmission of standard and safety-related data on a single bus cable, can also be used with PROFINET. No special network components are required for fail-safe communication, standard switches and standard network transitions can be used without restrictions. In addition, fail-safe communication is equally possible via Industrial Wireless LAN (IWLAN).

#### **Flexible topologies**

PROFINET also enables the use of star, tree, and ring topologies in addition to the linear topology characterized by the established fieldbuses. This is made possible by means of switching technology via active network components, such as Industrial Ethernet switches and media converters, or by integrating switch functionality into field devices. This results in an increased machine and plant planning flexibility, as well as savings in cabling.

The PROFINET network can be installed without any specialist knowledge and meets all requirements relevant to the industrial environment. The PROFINET Guideline "Cabling and Inter-connection Technology" provides network installation support for manufacturers and users. Symmetrical copper cables or RFI-resistant fiber-optic cables are used depending on the application. Devices from different manufacturers are easily connected via standardized and rugged plug-in connectors (up to IP65/IP67).

Thanks to the integration of switch functionality into the devices, linear topologies can be formed that are configured based on an existing machine or plant structure. This results in savings in cabling overhead and cuts down on components such as external switches.

#### **Open standard**

PROFINET, the open vendor-independent standard (IEC 61158/61784), is supported by PROFIBUS and PROFINET International (PI). It stands for maximum transparency, open IT communication, network security and simultaneous real-time communication.

Due to its openness, PROFINET creates the basis for a uniform automation network in the plant to which all of the machines and devices can be connected. The integration of existing parts of the plant, using PROFIBUS for example, can also be achieved without any problems through the use of network transitions.

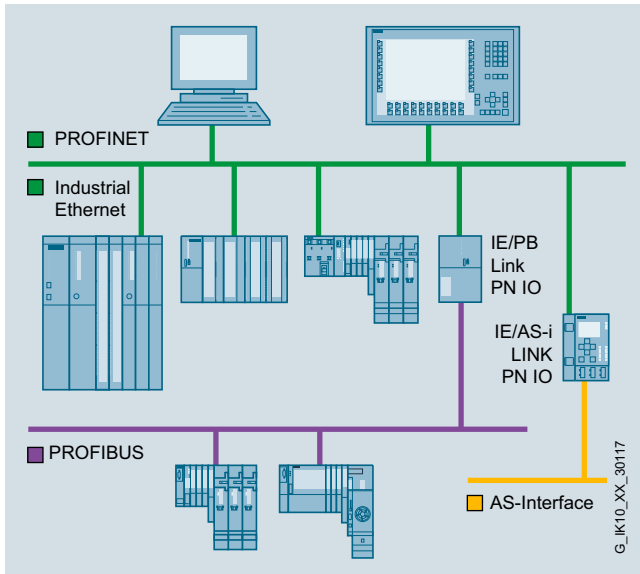
**Overview** (continued)

Fieldbus integration via a proxy

**Use of web tools**

PROFINET's unrestricted support for TCP/IP permits the use of standard web services such as web servers in the device. Independently of the tool used, information from the automation level can be accessed from almost anywhere at any time using a commercially available Internet browser. This considerably simplifies commissioning and diagnostics.

Each user can decide for himself how much openness to the IT world he will permit for his machine or plant. Thus, PROFINET can be easily operated as an isolated plant network or it can be connected to the office network or the Internet via suitable security modules, such as the SCALANCE S modules. This allows new teleservice concepts or even the fast exchange of production data.

**Expandability**

On the one hand, PROFINET permits the easy integration of existing systems and networks without great effort. Thus, PROFINET protects the investments in existing plant units which communicate via PROFIBUS and other fieldbuses such as AS-Interface, for example.

On the other hand, additional PROFINET stations can be added at any time. Network infrastructures can be expanded using additional network components, both wired and wireless versions, even during operation.

**Efficiency**

Global competition means that companies must deploy their resources economically and efficiently. This applies in particular to production. PROFINET ensures more efficiency here.

Simple engineering guarantees fast commissioning, and reliable devices enable high plant availability. Comprehensive diagnostics and maintenance concepts help to reduce plant downtimes and maintenance costs to a minimum.

**One cable for all purposes**

PROFINET permits simultaneous fieldbus communication in isochronous mode and standard IT communication (TCP/IP) via one cable. This real-time communication for the transmission of user/process data and diagnostic data is performed on a single cable. Specific profile communication (PROFIsafe, PROFIdrive and PROFInergy) can be integrated without additional cabling overhead. This solution provides a wide range of functions with a low degree of complexity.

**Device and network diagnostics**

By retaining the field-proven PROFIBUS device model, the same diagnostic information is available with PROFINET. In addition, device diagnostics also includes read-out of module-specific and channel-specific data from the devices. This enables simple and fast location of faults. In addition to the availability of device information, the top priority in network management is reliability of network operation.

The Simple Network Management Protocol (SNMP) has become established in existing networks as the de-facto standard for the maintenance and monitoring of network components and their functions. PROFINET uses this standard and provides users with the option of servicing networks using familiar tools such as the SINEMA Server network management software.

In order to facilitate the maintenance of PROFINET devices, both locally and also remotely via a secure VPN connection, application-specific Web sites in the familiar HTML standard can be created on the integral Web server of the field devices.

# PROFINET/Industrial Ethernet

## PROFINET

### Introduction

#### Overview (continued)

##### Energy efficiency

###### Moving toward the green factory: PROFlenergy

PROFlenergy is a profile that provides functions and mechanisms for PROFINET field devices that support energy-efficient production.

The vendor and device-independent profile defined by PNO allows the user to significantly reduce the energy consumption and costs: PROFlenergy enables specific loads that are not required to be switched off. This noticeably reduces energy costs during pauses in production. PROFlenergy facilitates automated activation and deactivation of technologically related plant sections. The coordination is performed centrally by means of a higher-level controller, and the networking via PROFINET. This means that during long pauses, as much energy as possible is saved. Plant sections that are switched off for short periods contribute to the even distribution and most efficient use of energy.

The use of PROFlenergy is made easier for the machine builder by its integration into well-known series of products. In addition, PROFlenergy is defined in such a way that the necessary function blocks can be integrated into existing automation systems at a later date.

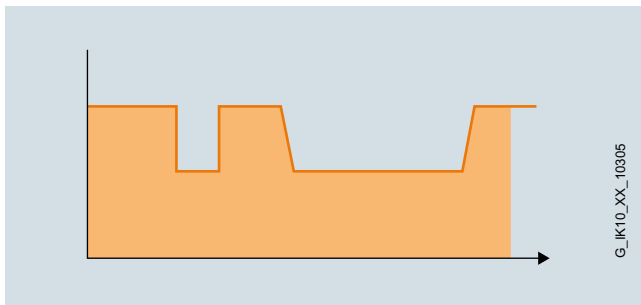

Energy consumption without PROFlenergy

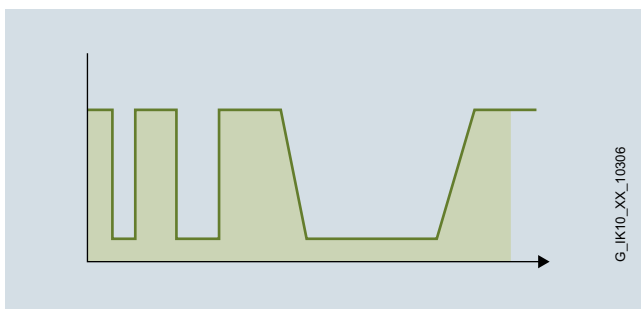

Energy consumption with PROFlenergy

##### Easy cabling

Stringent demands are placed on the installation of cables in the industrial environment. There is also the requirement to set up error-free industry-standard networks in the shortest possible time without specialist knowledge.

Siemens offers FastConnect, a system that meets all these requirements: FastConnect is the standards-compliant, industry-standard cabling system consisting of cables, connectors, and assembly tools for PROFINET networks.

The time spent for connecting the terminal devices is minimized thanks to the easy installation using only a single tool, and installation errors can be avoided thanks to the practical color-coding. Both copper cables and glass fiber-optic cables can be assembled on-site in this way.

##### Fast device replacement

PROFINET devices are identified via a name that is assigned in the configuration. When replacing a defective device, a new device can be recognized by the IO Controller by means of topology information and have a name automatically assigned to it. An engineering tool is therefore not required when replacing devices.

This mechanism can also be used during the initial commissioning of a complete plant. Quick commissioning is thus especially possible for series machines.

##### Ruggedness

An automation network must be able to withstand most external sources of interference. The use of Switched Ethernet prevents faults in one section of the network from influencing the entire plant network. PROFINET enables the use of fiber-optic cables especially for areas that are critically sensitive to EMI.

**Overview** (continued)

**Performance**

Productivity and product quality determine market success. Precise motion control, dynamic drives, high-speed controllers, and the deterministic synchronization of devices are therefore key factors in achieving superior production. They allow high production speeds and simultaneously optimized product quality.

**Speed and precision**

Fast motion control applications need precise and deterministic data exchange. This is implemented thanks to isochronous drive controls using Isochronous Real-Time (IRT).

PROFINET permits high-speed and deterministic communication due to IRT and isochronous mode. The different cycles of a system (input, network, CPU processing and output) are also synchronized in the case of parallel TCP/IP traffic. PROFINET's short cycle times make it possible to increase the productivity of machines and plants, and to ensure product quality through high precision.

The standardized PROFIdrive drive profile enables vendor-independent communication between CPUs and drives.

**Large quantity structures**

Previous limitations in the scope of the machines and systems to be implemented can be easily overcome through the use of PROFINET. With PROFINET, up to 256 field devices can now be managed by one SIMATIC Controller.

In a network, several controllers can interact with their assigned field devices. The number of field devices per PROFINET network is virtually unlimited – the entire band of IP addresses is available.

**High transmission rate**

By using 100 Mbit/s in full duplex mode, PROFINET achieves a significantly higher transmission rate than previous fieldbuses. Thanks to this, both the process data and other plant data can be transferred via TCP/IP without any problems. In this way, PROFINET combines the industrial requirements of simultaneously transferring fast IO data and large data quantities for other parts of the application. Even the transfer of large quantities of data such as by cameras does not affect the speed and the precision of the IO data transfer thanks to PROFINET mechanisms.

**Redundancy**

Higher plant availability can be achieved by means of a redundant installation (ring topology). The media redundancy can be implemented both with the help of external switches and direct via integral PROFINET interfaces. Reconfiguration times of 200 ms can be achieved. In the case of an interruption to the communication in only one part of the ring installation, this means that a plant standstill is prevented and the necessary servicing and repair work can be carried out without time pressure.

**MRPD**

High network availability can be achieved without reconfiguration time using the PROFINET-compatible MRPD procedure (Media Redundancy for Planned Duplication). The MRPD protocol is an extension to the MRP protocol for sending message frames in duplicate within a ring topology. Networks can only be constructed with SCALANCE X-200IRT switches and additional components with the real-time feature Isochronous Real-Time IRT (PROFINET standard), such as SIMATIC controllers, ET 200, SIMOTION and SINAMICS drives.

**Fast start-up**

The Fast Start-Up function allows rapid start-up of PROFINET IO Devices that are connected to SIMATIC Controllers. The communication connection between the controller and the device is established in less than a second. For modular plants, individual plant parts can therefore be connected or disconnected in the shortest time. For example, the tool change can be accelerated significantly in robot applications.

**Benefits**

- PROFINET is the open Industrial Ethernet standard for automation
- PROFINET is based on Industrial Ethernet
- PROFINET uses TCP/IP and IT standards
- PROFINET is Real-Time Ethernet
- PROFINET permits seamless integration of fieldbus systems
- PROFINET supports fail-safe communication via PROFIsafe over IWLAN as well

# PROFINET/Industrial Ethernet

## Cabling technology

### Overview of passive network components

#### Overview

Industrial Ethernet		Maximum cable lengths for industrial Ethernet connections								
Type of fiber		0 - 10 m	0 - 50 m	0 - 55 m	0 - 85 m	0 - 100 m	0 - 750 m	0 - 4.000 m	0 - 5.000 m	0 - 26.000 m
<b>IE FC cables 2x2 at 100 Mbit/s</b>										
FC RJ45 outlet with 2x2 cable (additional 10 m patch cable can be connected in total)				● (0 - 45 m; Torsion Cable)	● (0 - 75 m; Marine/Trailing/ Flexible/ FRNC/Food/ Festoon Cable)	● (0 - 90 m; Standard Cable GP)				
Patch cable		●								
TP FC Standard Cable GP 2x2						●				
TP Ground Cable 2x2						●				
TP Train Cable GP 2x2						●				
TP FC Flexible Cable GP 2x2					●					
TP FC Marine Cable 2x2 GP					●					
TP FC Trailing Cable 2x2					●					
TP FC Trailing Cable GP 2x2					●					
TP Torsion Cable 2x2				●						
TP FC FRNC Cable GP					●					
TP FC Food Cable					●					
TP FC Festoon Cable GP					●					
<b>IE FC cables 4x2 at 1000 Mbit/s</b>										
FC RJ45 outlet with 4x2 cable (AWG 22) (additional 10 m patch cable can be connected in total)						● (0 - 90 m; Standard Cable GP)				
TP Standard Cable GP 4x2 (AWG 24)						●				
TP Flexible Cable GP 4x2 (AWG 24)					●					
TP Train Cable GP 4x2 (AWG 24)						●				
Patch cable		●								
<b>IE Glass FOC</b>										
FO FRNC Cable GP	Multimode (50/125)						● <sup>2)</sup>		● <sup>1)</sup>	
FO Standard Cable GP	Multimode (50/125)						● <sup>2)</sup>		● <sup>1)</sup>	
FO Ground Cable	Multimode (50/125)						● <sup>2)</sup>		● <sup>1)</sup>	
FO Trailing Cable	Multimode (50/125)						● <sup>2)</sup>		● <sup>1)</sup>	
FO Trailing Cable GP	Multimode (50/125)						● <sup>2)</sup>		● <sup>1)</sup>	
FO Robust Cable GP	Multimode (50/125)						● <sup>2)</sup>		● <sup>1)</sup>	
INDOOR FO Cable	Multimode (62,5/125)							● <sup>1)</sup>		
FO Standard Cable	Multimode (62,5/125)							● <sup>1)</sup>		
Flexible FO Trailing Cable	Multimode (62,5/125)							● <sup>1)</sup>		
FO Robust Cable GP <sup>3)</sup>	Multimode (4E9/125)									● <sup>1)</sup>
<b>IE POF/PCF Fiber Optic Cable</b>										
POF Standard Cable GP 980/1000	POF (980/1000)		● <sup>1)</sup>							
POF Trailing Cable 980/1000	POF (980/1000)		● <sup>1)</sup>							
PCF Standard Cable GP	PCF (200/230)					● <sup>1)</sup>				
PCF Trailing Cable	PCF (200/230)					● <sup>1)</sup>				
PCF Trailing Cable GP	PCF (200/230)					● <sup>1)</sup>				





1) at 100 Mbit/s

2) at 1000 Mbit/s

3) 10 km at 10GBase-LR and 40 km at 10GBase-ER

G\_IK10\_XX\_10239

**Overview** (continued)

		Options for connecting Industrial Ethernet cables with plugs, terminals or devices (IE)								
		electrical								
		IE FC Cable 4x2	IE FC Cable 2x2	IE TP Cord 2x2	IE TP Cord 4x2	IE Connecting Cable RJ45	IE Connecting Cable M12	Hybrid cable	Energy Cable	
		IE FC Standard Cable GP 4x2 (AWG22) IE FC Standard Cable GP 4x2 (AWG24) IE FC Flexible Cable GP 4x2 (AWG24)	IE Train Cable GP 422 (AWG24)	IE FC TP Standard Cable GP 2x2 IE FC TP Flexible Cable GP 2x2 IE FC TP FRNC Cable GP 2x2 IE FC TP Trailing Cable GP 2x2 IE FC TP Trailing Cable GP 2x2 IE FC TP Festoon Cable GP 2x2 IE TP Torsion Cable 2x2 IE TP Food Cable GP 2x2 IE FC TP Marine Cable 2x2 IE Train Cable GP 2x2 IE Ground Cable 2x2	IE TP Cord 9/RJ45 IE TP XP Cord 9/RJ45 IE TP Cord 9-45/RJ45 IE TP XP Cord 9-45/RJ45 IE TP Cord RJ45/15 IE TP XP Cord RJ45/15 IE TP XP Cord 9/9	IE TP Cord RJ45/RJ45 IE TP XP Cord RJ45/RJ45	IE FC RJ45 PLUG-180/IE FC RJ45 PLUG-180	M12-180/M12-180 M12-180/IE FC RF-45 PLUG-145	Hybrid cable 2x2 + 4x0,34	Hybrid cable 2x2 + 4x0,34 Energy Cable 5 x 1,5
	IE FC RJ45 Modular Outlet	●				●			●	
	IE FC Outlet RJ45			●	●	●				
	IE FC RJ45 Plug 2x2			●						
	IE FC RJ45 Plug 4x2	●								
	A-coded									●
	2x2 D-coded			●						
	4x2 X-coded	●	●							
	IP67 hybrid connector								●	
	Devices with M12 connection			●				●		
	Devices with RJ45 connection			●	●	●				
	Power Plug PRO									●
	7/8" plug-in connector									●
	IE FC RJ45 Plug PRO			●						●

G\_IK10\_XX\_10245

# PROFINET/Industrial Ethernet

## Cabling technology

### Overview of passive network components

#### Overview (continued)

2

		Options for connecting Industrial Ethernet cables with plugs, terminals or devices								
		Optical								
		Fiber-optic cable 50/125/1400 µm	Fiber-optic cable 62.5/125 µm	PCF fiber optic cable 200/230 µm	Fiber-optic cable with BFOC connector	Fiber-optic cable with SC plug	POF-FOC 980/1000 µm	Fiber-optic cable with SC RJ plug	Fiber-optic cable with LC plug	Fiber-optic cable with FC plug
		FO Standard Cable GP FO Trailing Cable GP FO Ground Cable	FIBER OPTIC standard cable INDOOR Fiber-Optic indoor cable Flexible Fiber-Optic trailing cable SIENOPYR marine duplex fiber optic cable	PCF Standard Cable GP PCF Trailing Cable GP	Preassembled FOC with BFOC plug	Preassembled FOC with SC plug	POF Standard Cable GP POF Trailing Cable	Preassembled FOC with SC RJ plug	FO Robust Cable GP (4E9/125/900) FO Robust Cable GP (50/125/900)	FO FC Standard Cable GP (62.5/200/230) FO FC Trailing Cable (62.5/200/230)
	BFOC connector	•	•							
	IE devices with BFOC connection				•					
	SC plug	•	•							
	IE devices with SC connection					•				
	SC RJ plug			•			•			
	IE devices with SC RJ connection							•		
	IE SC RJ POF Plug PRO						•			
	IE SC RJ PCF Plug PRO			•						
	Multimode FO LC Plug								•	
	Singlemode FO LC Plug								•	
	FO FC BFOC Plug									•
	FO FC SC Plug									•

c\_1K10\_xx\_10246



### Overview

#### Structured cabling

- Structured cabling to ISO IEC 11801/EN 50173 describes the non-application-specific, tree-like cabling of building complexes for IT purposes. A site is subdivided into the following areas:
  - Primary area (connecting the buildings of a site)
  - Secondary area (connecting the floors of a building)
  - Tertiary area (IT connection of data terminals on a floor)

The structured cabling that can be achieved with the Industrial Ethernet FastConnect System corresponds to the structure of the tertiary cabling in accordance with EN 50173 for Ethernet.

#### FastConnect Twisted Pair (FC)

- For structured cabling in the production hall, the FastConnect Twisted Pair cabling system is ideal (RJ45 and M12 connections). With the fast installation system for Industrial Ethernet, structured cabling from the office environment not only becomes industry compatible for installation in the production hall;
- FastConnect cables can also be assembled extremely quickly and easily on site. The RJ45 cabling technique, an existing standard, is also available in an industry-standard version that supports structured cabling (patch cables, patch field, installation cables, connection socket, connecting cable).
- With the FastConnect plugs and FastConnect cables as an alternative to structured cabling, up to 100 m cable length can be achieved for a point-to-point link (requires less patch technology).

#### Benefits

- Extensive product range for flexible cabling in industry
- Faster connection of data terminals thanks to safe stripping of the outer sheath and braided shield in one step
- Easy connection method (insulation-piercing contacts) for 4-core (Cat5) and 8-core (Cat6) Industrial Ethernet FC Twisted Pair installation cables
- Easy assembly for all cable types with the preadjusted FC stripping tool
- Reliable shield contacting and strain relief

### Application

	10/100 Mbit/s	10/100/1 000 Mbit/s
IE FC TP Cable 2x2	•	—
IE FC TP Cable 4x2	—	•
IE FC RJ45 Plug 2x2	•	—
IE FC M12 Plug PRO 2x2	•	—
IE FC RJ45 Plug 4x2	—	•
IE FC M12 Plug PRO 4x2	—	•
IE FC Outlet RJ45	•	—
IE FC RJ45 Modular Outlet	—	•
IE TP Cord	• <sup>1)</sup>	• <sup>2)</sup>
IE Connecting Cable	•	—

<sup>1)</sup> All TP Cord types with a Sub D interface

<sup>2)</sup> IE TP Cord RJ45/RJ45 and IE TP Cord XP

#### UL approvals

UL listing (safety standard) for network cables is especially necessary for the American and Canadian markets. The requirements for the appropriate approvals depend on where the cable is routed within the building. This applies to all cables which have to be routed from a machine to a remote control cabinet and are positioned on cable racks secured on the building. Cables with UL approval have "GP" (**G**eneral **P**urpose) added to their name.

### Design

The FastConnect system comprises:

- Industrial Ethernet FastConnect cables** specially designed for fast connection (UL and CAT5e certified) as FC TP Standard, FC TP Flexible, FC TP Trailing, TP Torsion, FC Ground Cable, FC Food Cable, FC FRNC Cable, FC Festoon Cable and FC TP Marine Cable.
- Easy stripping with the **FastConnect Stripping Tool**; the outer sheath and the braided shield are stripped accurately in one step
- The prepared cable is connected in the **FastConnect products** using the insulation displacement method.

### Integration

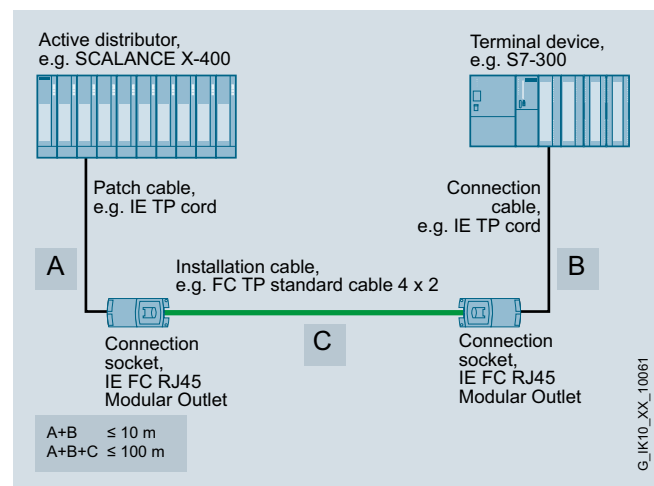

Structured cabling according to EN 50173

## PROFINET/Industrial Ethernet

### Cabling technology

#### Industrial Ethernet FastConnect

##### Overview



- With the FastConnect (FC) system for Industrial Ethernet, structured cabling from the office environment becomes industry-compatible for installation in the production hall.
- Time-saving, error-free installation on-site
- RJ45 cabling technology is used as the permanent standard
- The ideal solution for assembly of RJ45 and M12 connectors in the field area with 4-core (2 x 2) Industrial Ethernet FC cables
- The ideal solution for assembly of the IE FC RJ45 Modular Outlet with 8-core (4 x 2) Industrial Ethernet FC cables
- Mistakes are prevented thanks to color coding and the transparent contact cover
- Coordinated system of FC plug-in connectors and an extensive FC cable spectrum with appropriate UL approvals

##### Benefits

get **Designed for Industry**

- Compliance with the Industrial Ethernet Standard PROFINET (PROFINET Cabling and Interconnection Technology Guideline<sup>1)</sup>)
- Faster connection of data terminals thanks to safe stripping of the outer sheath and braided shield in one step
- Reliable shield contact and strain relief thanks to bolt-on cover
- Excellent EMC shielding and deflection (metal housing)
- Mistakes are prevented thanks to color coding and the transparent contact cover

<sup>1)</sup> Available as a download under [www.profinet.com](http://www.profinet.com)

### Application

Industrial Ethernet FastConnect is a quick-assembly system for easy assembly of 4-core and 8-core Industrial Ethernet FC cables.

After stripping, the IE FC cable can be directly mounted in the IE FC RJ45 Plug (4-core), the IE M12 Plug PRO 2x2 or 4x2, the IE FC Outlet RJ45 (4-core), or the IE RJ45 Modular Outlet (8-core).

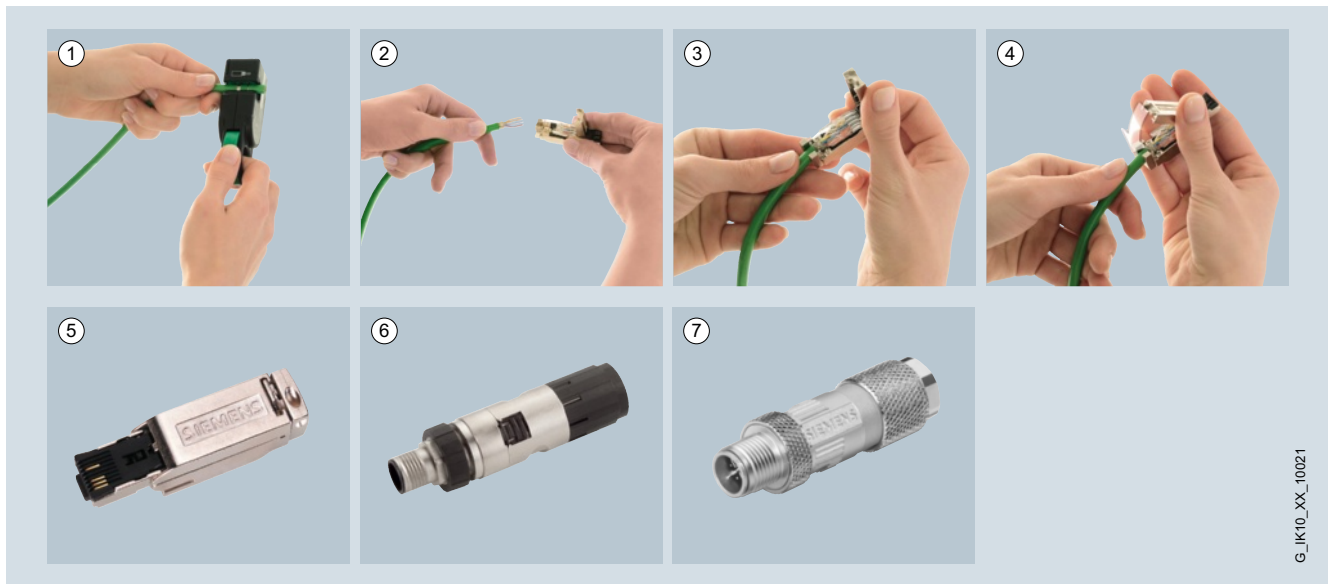

Steps for assembly of Industrial Ethernet copper cables with Industrial Ethernet FastConnect

### Design

The complete system:

- Industrial Ethernet FC installation cables designed for fast assembly; 4-core (2x2) Cat5e;
  - IE FC TP standard cable GP
  - IE FC TP flexible cable GP
  - IE FC TP trailing cable GP
  - IE FC TP Trailing Cable
  - IE TP Torsion Cable
  - IE FC TP Marine Cable
  - IE FC TP FRNC cable GP
  - IE FC TP Food Cable
  - IE FC TP festoon cable GP
  - IE TP Ground Cable
  - IE TP Train Cable
- 8-core (4 x 2) Cat6 certified, with appropriate UL approval:
  - IE FC TP Standard Cable GP (AWG 22/AWG 24)
  - IE FC TP Flexible Cable (AWG 24)
  - IE TP Train Cable (AWG 24)
- User-friendly stripping technique with FC Stripping Tool
- Noise-resistant FC RJ45 and FC M12 Plugs (10/100/1000 Mbit/s), an ideal solution for installation on 4 or 8-core IE FC cables at the field level thanks to the rugged metal enclosure
- The prepared cable is connected in the Industrial Ethernet FC Outlet RJ45 (10/100 Mbit/s; 4-core) or IE FC RJ45 Modular Outlet (10/100/1000 Mbit/s; 8-core) using insulation displacement

### Function

The FastConnect stripping technique supports fast and easy connection of the Industrial Ethernet FC cables

- IE FC RJ45 Plug (10/100/1000 Mbit/s)
- IE FC M12 Plug PRO (10/100/1000 Mbit/s)
- IE FC Outlet RJ45 (10/100 Mbit/s)
- IE FC RJ45 Modular Outlet (10/100/1000 Mbit/s)

The data terminals and network components are connected using outlets via TP Cords.

The Industrial Ethernet FastConnect cables are specially designed for use of the Industrial Ethernet FastConnect Stripping Tool, with which the outer insulation and the braided shield can be stripped accurately in one step. The prepared cable is then connected using insulation displacement.

### Approvals

UL listing (safety standard) for network cables is especially necessary for the American and Canadian markets. The requirements for the appropriate approvals depend on where the cable is routed within the building. This applies to all cables which have to be routed from a machine to a remote control cabinet and are positioned on cable racks secured on the building. OFN/OFNG cable for routing in bundles (general purpose cable).

The various connectors and cables from the FastConnect cabling system can also be used in hazardous areas (EX-Zone 2). No special approval is necessary.

## PROFINET/Industrial Ethernet

### Cabling technology

#### IE FC RJ45 Plug 2 x 2

#### Overview

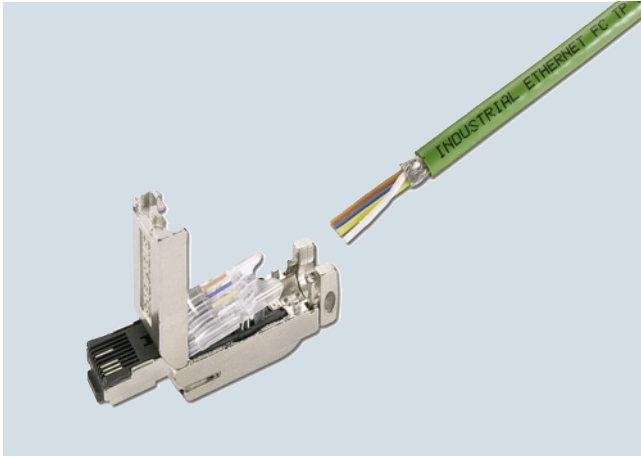

- Implementation of direct device connections over distances of up to 100 m with Industrial Ethernet FC installation cable 2 x 2 without patching
- Easy connection (insulation displacement contacts) for 4-core Twisted Pair installation cables (100 Mbit/s) without the need for special tools
- Error-preventing connection technique thanks to visible connection area as well as colored blade terminals
- Industry-compatible design (rugged metal housing, no easily lost small parts)
- Excellent EMC shielding and deflection (metal housing)
- Integrated strain-relief for installation cables
- Compatible to the EN 50173 (RJ45) / ISO IEC 11801 standard
- Additional strain and bending relief of plug connector possible through latching of plug on device housing, e.g. with SCALANCE X, SCALANCE S, ET 200S.

#### Benefits



- Ideal solution for installing RJ45 plug-in connectors in the field level
- Time-saving, error-free installation using the FastConnect system
- RJ45 plug-in connector is resistant to interference thanks to the rugged metal housing
- Reliable shield attachment and strain relief are integrated
- Mistakes are prevented thanks to color coding and the transparent contact cover
- A compatible system of Industrial Ethernet FastConnect plug-in connectors and a comprehensive range of FastConnect cables with the appropriate UL approvals and PROFINET compatibility

#### Application

The compact, rugged design of the connectors makes the FC RJ45 Plug suitable for use in both industrial environments and on office equipment.

The Industrial Ethernet FastConnect RJ45 Plugs 2 x 2 permit quick and easy installation of the Industrial Ethernet FastConnect installation cables 2 x 2 (4-core twisted pair cables) in the field.

The Industrial Ethernet FastConnect Stripping Tool for preparing the end of a cable (stripping the jacket and shield in one step) allows simple handling and fast, reliable fitting of the cable connector to the cable. As all the cable connector parts are captive, it can also be fitted in difficult conditions.

The plug-in connectors enable point-to-point links to be implemented (100 Mbit/s) for Industrial Ethernet between two data terminals/network components up to 100 m without the need for patches.

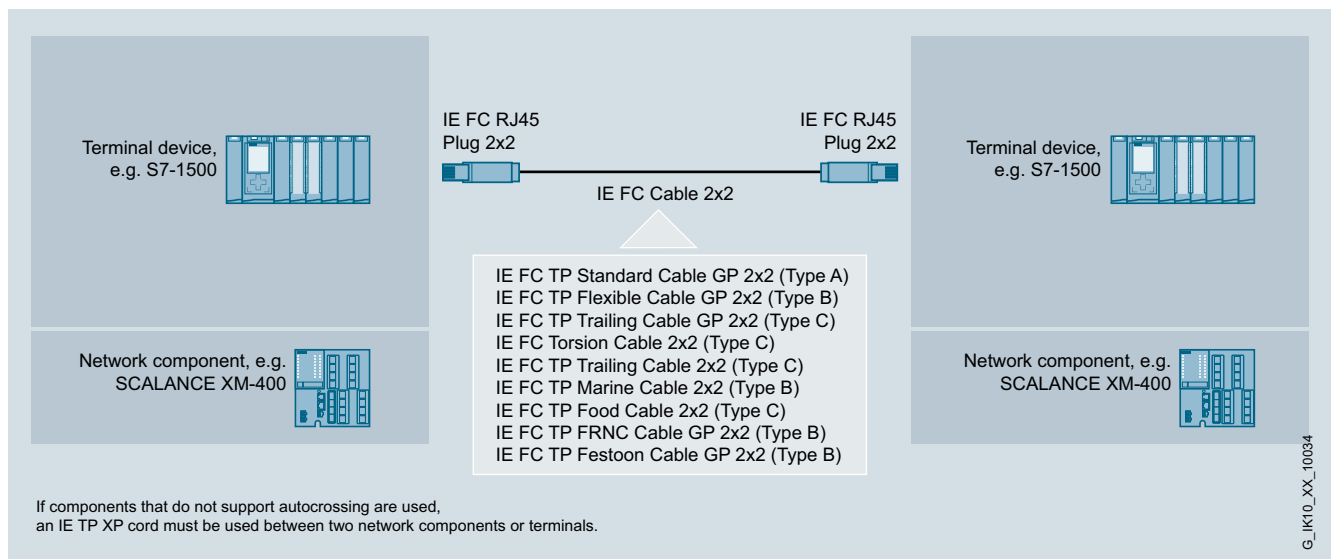

Use of FastConnect cables 2 x 2 with IE FC RJ45 Plug 2 x 2

## Design

Industrial Ethernet FC RJ45 Plugs are available in three designs:

- With 180° (straight) cable outlet
- With 145° (angled) cable outlet (SIMOTION and SINAMICS, for example)
- With 90° (angled) cable outlet (for ET 200S, for example)



They are used for optimized connection of Industrial Ethernet FastConnect cables to data terminals and network components. The plugs have a rugged, industry-compatible metal housing that provides optimum protection against faults in data communication.

The 4 integrated insulation displacement contacts make contacting of the FC cable variants easy and error-free.

After the stripped cable end has been inserted into the insulation displacement terminations (which have been hinged open), the latter are pressed down for reliable contacting of the conductors.

Thanks to their compactness, the plug-in connectors (IE FC Plug 180°) can be used on devices with individual sockets and on devices with multiple sockets (blocks).

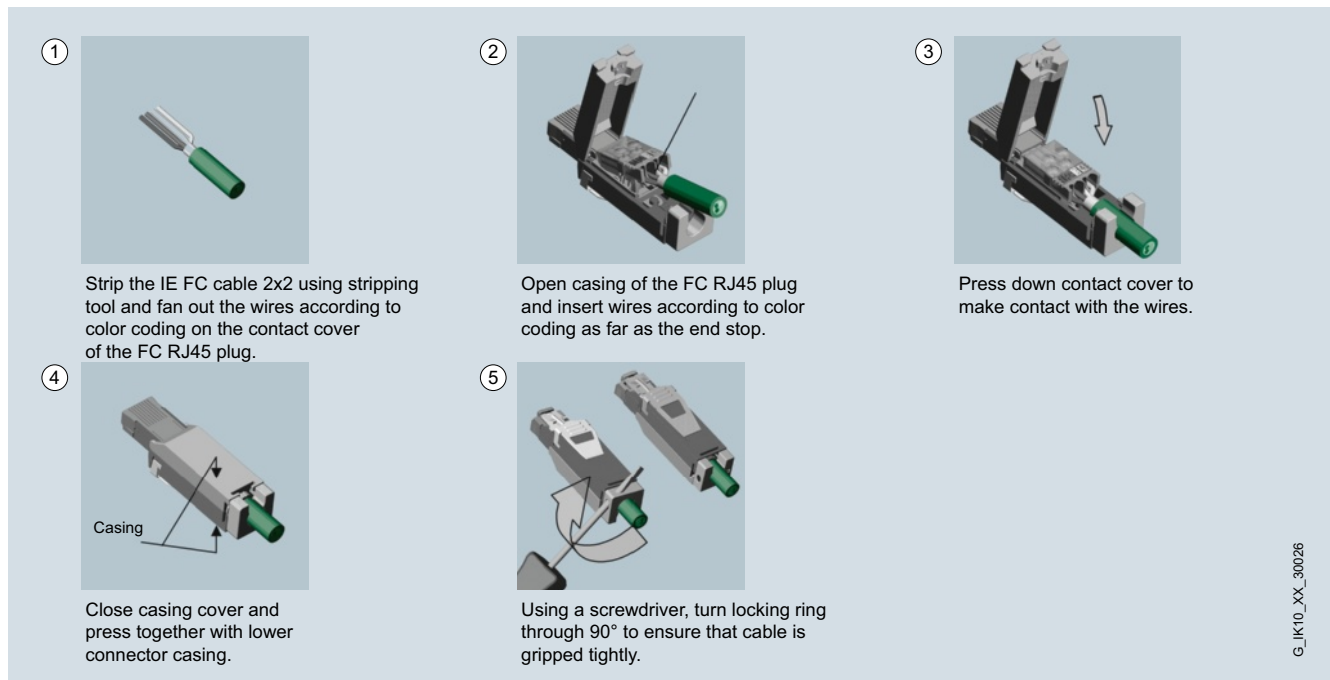

Data terminals with a suitable bracket on the housing provide additional tension and bending relief for the plug-in cable.

## Function

The IE FC RJ45 Plugs are used to install uncrossed 100 Mbit/s Ethernet connections up to 100 m without the use of patches. Crossed cables can also be installed by swapping the transmit and receive pair in a plug.

When the housing is open, color markings on the contact cover make it easier to connect the cores to the blade terminals. The user can check that contact has been made correctly through the transparent plastic material of the contact cover.

## PROFINET/Industrial Ethernet

### Cabling technology

#### IE FC RJ45 Plug 2 x 2

#### Technical specifications

Article No.	6GK1901-1BB20-2AA0	6GK1901-1BB10-2AA0	6GK1901-1BB30-0AA0
Product-type designation	IE FC RJ45 Plug 90 (2x2)	IE FC RJ45 Plug 180 (2x2)	IE FC RJ45 Plug 145 (2x2)
Product description	RJ45 data plug-in connector	RJ45 data plug-in connector	RJ45 data plug-in connector
Acceptability for application	For connection to IE FC TP cables 2x2, suitable for fast assembly with the FastConnect system	For connection to IE FC TP cables 2x2, suitable for fast assembly with the FastConnect system	For connection to IE FC TP cables 2x2, suitable for fast assembly with the FastConnect system
<b>Transmission rate</b>			
Transfer rate			
• 1 for Industrial Ethernet	10 Mbit/s	10 Mbit/s	10 Mbit/s
• 2 for Industrial Ethernet	100 Mbit/s	100 Mbit/s	100 Mbit/s
• 3 for Industrial Ethernet	-	-	-
<b>Interfaces</b>			
Number of electrical connections for Industrial Ethernet FC TP cables	4	4	4
Design of the electrical connection			
• for Industrial Ethernet FC TP cables	integrated cut-and-clamp contacts for 4-wire TP FC installation cable RJ45 connector	integrated cut-and-clamp contacts for 4-wire TP FC installation cable RJ45 connector	integrated cut-and-clamp contacts for 4-wire TP FC installation cable RJ45 connector
• for network components and terminal equipment			
• FastConnect	Yes	Yes	Yes
<b>Mechanical data</b>			
Material of the enclosure	metal	metal	metal
<b>Design, dimensions and weight</b>			
Type of cable outlet	90 degree cable outlet	180 degree cable outlet	145 degree cable outlet
Width	13.7 mm	13.7 mm	13.9 mm
Height	16 mm	16 mm	16 mm
Depth	42 mm	55 mm	55.6 mm
Net weight	35 g	35 g	35 g
<b>Permitted ambient conditions</b>			
Ambient temperature			
• during operating	-40 ... +85 °C	-40 ... +85 °C	-40 ... +85 °C
• during storage	-40 ... +85 °C	-40 ... +85 °C	-40 ... +85 °C
• during transport	-40 ... +85 °C	-40 ... +85 °C	-40 ... +85 °C
Relative humidity at 25 °C without condensation during operating maximum	95 %	95 %	95 %
Protection class IP	IP20	IP20	IP20
Chemical resistance to water	-	-	-
<b>Product properties, functions, components general</b>			
Product feature silicon-free	Yes	Yes	Yes
Product component strain relief	Yes	Yes	Yes
<b>Standards, specifications, approvals</b>			
Verification of suitability			
• RoHS conformity	Yes	Yes	Yes
• UL-registration	Yes	Yes	Yes
Standard for structured cabling	Cat5	Cat5	Cat5

Ordering data	Article No.	Article No.
<b>IE FC RJ45 plugs</b> RJ45 plug connector for Industrial Ethernet with a rugged metal housing and integrated insulation displacement contacts for connecting Industrial Ethernet FC installation cables		
<b>IE FC RJ45 Plug 180</b> 180° cable outlet; for network components and CPs/CPU with Industrial Ethernet interface • 1 pack = 1 unit • 1 pack = 10 units • 1 pack = 50 units	<b>6GK1901-1BB10-2AA0</b> <b>6GK1901-1BB10-2AB0</b> <b>6GK1901-1BB10-2AE0</b>	<b>IE FC TP Trailing Cable GP 2 x 2 (Type C)</b> 4-core, shielded TP installation cable for connection to IE FC Outlet RJ45/ IE FC RJ45 Plug for use in trailing cables; PROFINET-compatible; with UL approval; sold by the meter; max. length 1 000 m, minimum order 20 m
<b>IE FC RJ45 Plug 90</b> 90° cable outlet; e.g. for ET 200S • 1 pack = 1 unit • 1 pack = 10 units • 1 pack = 50 units	<b>6GK1901-1BB20-2AA0</b> <b>6GK1901-1BB20-2AB0</b> <b>6GK1901-1BB20-2AE0</b>	<b>IE FC TP Trailing Cable 2 x 2 (Type C)</b> 4-core, shielded TP installation cable for connection to IE FC Outlet RJ45/ IE FC RJ45 Plug 180/90 for use in trailing cables; PROFINET-compatible; without UL approval; sold by the meter; max. length 1 000 m, minimum order 20 m
<b>IE FC RJ45 Plug 145</b> 145° cable outlet; e.g. for SIMOTION and SINAMICS • 1 pack = 1 unit • 1 pack = 10 units • 1 pack = 50 units	<b>6GK1901-1BB30-0AA0</b> <b>6GK1901-1BB30-0AB0</b> <b>6GK1901-1BB30-0AE0</b>	<b>IE TP Torsion Cable GP 2 x 2 (Type C)</b> 4-core, shielded TP installation cable for connection to IE FC Outlet RJ45/ IE FC RJ45 Plug for use with robots; PROFINET-compatible; with UL approval; sold by the meter; max. length 1 000 m, minimum order 20 m
<b>IE FC stripping tool</b> Preadjusted stripping tool for fast stripping of Industrial Ethernet FC cables	<b>6GK1901-1GA00</b>	
<b>IE FC TP Standard Cable GP 2 x 2 (Type A)</b> 4-core, shielded TP installation cable for connection to IE FC Outlet RJ45/ IE FC RJ45 Plug; PROFINET-compatible; with UL approval; <u>Sold by the meter</u> max. length 1 000 m; minimum order 20 m <u>Preferred length</u> • 1 000 m	<b>6XV1840-2AH10</b>  <b>6XV1840-2AU10</b>	<b>IE FC TP Marine Cable 2 x 2 (Type B)</b> 4-core, shielded TP installation cable for connection to IE FC Outlet RJ45/ IE FC RJ45 Plug 180/90; marine approval; max. length 1 000 m, minimum order 20 m
<b>IE FC TP Flexible Cable GP 2 x 2 (Type B)</b> 4-core, shielded TP installation cable for connection to IE FC Outlet RJ45/ IE FC RJ45 Plug for occasional movement; PROFINET-compatible; with UL approval; sold by the meter; max. length 1 000 m, minimum order 20 m	<b>6XV1870-2B</b>	<b>IE FC TP FRNC Cable GP 2 x 2 (Type B)</b> 4-core, shielded, halogen-free TP installation cable for connection to IE FC Outlet RJ45/ IE FC RJ45 Plug for occasional movement; PROFINET-compatible; with UL approval; sold by the meter; max. length 1 000 m, minimum order 20 m
		<b>6XV1870-2D</b>
		<b>6XV1840-3AH10</b>
		<b>6XV1870-2F</b>
		<b>6XV1840-4AH10</b>
		<b>6XV1871-2F</b>

## PROFINET/Industrial Ethernet

### Cabling technology

#### IE FC RJ45 Plug 2 x 2

Ordering data	Article No.	Article No.	
<p><b>IE FC TP Festoon Cable GP 2 x 2 (Type B)</b></p> <p>4-core, shielded TP installation cable for connection to IE FC Outlet RJ45/IE FC RJ45 Plug 180/90 for use in festoon applications; PROFINET-compatible; with UL approval; sold by the meter; max. length 1 000 m, minimum order 20 m</p>	<b>6XV1871-2S</b>	<p><b>IE TP train cable GP 2x2 (Type C)</b></p> <p>4-core, shielded TP installation cable for connection to IE FC Outlet RJ45/IE FC RJ45 Plug 180/90 for railway applications; PROFINET-compliant; sold by the meter; max. length 1 000 m, minimum order 20 m</p>	<b>6XV1871-2T</b>
<p><b>IE FC TP Food Cable GP 2 x 2 (Type C)</b></p> <p>4-core, shielded TP installation cable for connection to IE FC Outlet RJ45/ IE FC RJ45 Plug 180/90 for the food and beverages industry; PROFINET-compliant; sold by the meter; max. length 1 000 m, minimum order 20 m</p>	<b>6XV1871-2L</b>	<p><b>IE FC Blade Cassettes (5 mm)</b></p> <p>Replacement blade cassette for the Industrial Ethernet stripping tool; for use with IE FC RJ45 Plugs and Modular Outlet, 5 items</p>	<b>6GK1901-1GB01</b>
<p><b>IE TP ground cable 2x2 (Type C)</b></p> <p>4-core, shielded TP installation cable for connection to IE FC Outlet RJ45/ IE FC RJ45 Plug 180/90 (after removal of additional outer sheath) for laying in soil; PROFINET-compliant; sold by the meter; max. length 1 000 m, minimum order 20 m</p>	<b>6XV1871-2G</b>		

2



## Overview



- Implementation of direct device connections of up to 90 m with Industrial Ethernet FC installation cable 4 x 2 without using patch technology
- Easy connection (insulation displacement contacts) for 8-core twisted pair installation cables (10/100/1000 Mbit/s) without the need for special tools
- Error-minimizing connection technique thanks to visible connection area as well as colored insulation displacement termination
- Industry-compatible design (rugged metal housing, no easily lost small parts)
- Excellent EMC shielding and deflection (metal housing)
- Integrated strain-relief for installation cables
- Compatible with the EN 50173 (RJ45) / ISO IEC 11801 standard
- Additional strain and bending relief of plug connector possible through latching of plug on device housing, e.g. with SCALANCE X, SCALANCE S.

## Benefits

get **Designed for Industry**

- Ideal solution for installation of RJ45 plugs in the field
- Time-saving, error-free installation due to FastConnect system
- Noise-resistant RJ45 plug connector due to rugged metal housing
- Reliable shield attachment and strain relief are integrated
- Mistakes are prevented thanks to color coding and the transparent contact cover
- Coordinated system comprising Industrial Ethernet FastConnect plug-in connectors and an extensive range of FastConnect cables with corresponding UL approvals

## Application

The compact, rugged design of the connectors makes the FC RJ45 Plug suitable for use in both industrial environments and on office equipment.

The Industrial Ethernet FastConnect RJ45 Plug 4 x 2 permits quick and easy installation of the Industrial Ethernet FastConnect installation cables 2 x 4 (8-core twisted pair cables) in the field.

The Industrial Ethernet FastConnect Stripping Tool for preparing the end of a cable (stripping the jacket and shield in one step) allows simple handling and fast, reliable fitting of the cable connector to the cable. As all the cable connector parts are captive, it can also be fitted in difficult conditions.

The new plug-in connector enables point-to-point links to be implemented (10/100/1000 Mbit/s) for Industrial Ethernet between two data terminals/network components up to 90 m apart without the need for patches.

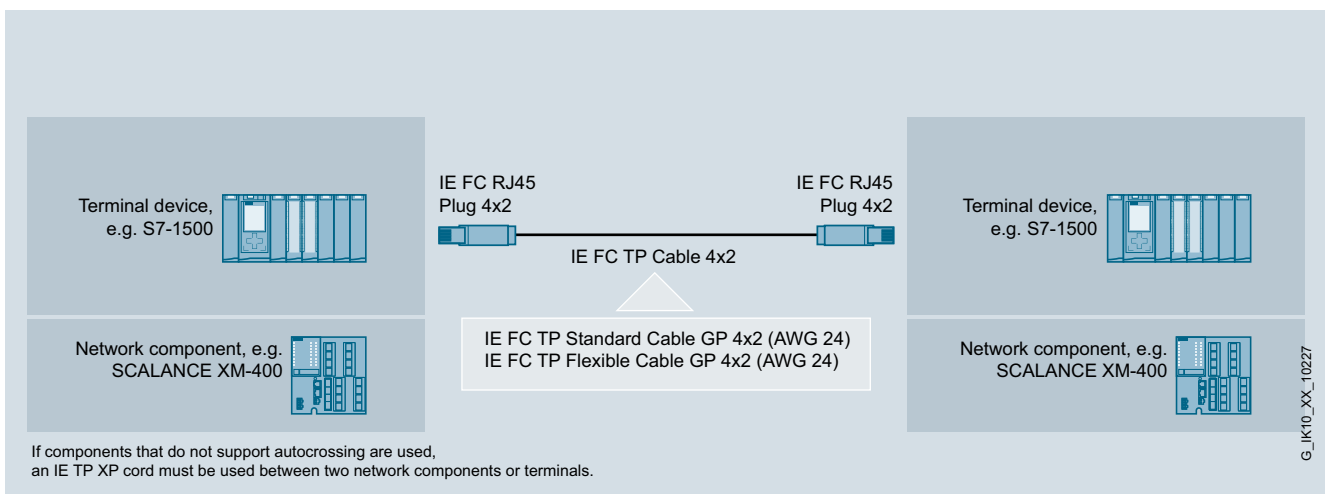

Use of FastConnect cables 4 x 2 with IE FC RJ45 plug 4 x 2

## PROFINET/Industrial Ethernet

### Cabling technology

#### IE FC RJ45 Plug 4 x 2

##### Design

The Industrial Ethernet FC RJ45 Plug 4 x 2 is available with a 180° (straight) cable outlet.

It is the ideal method of connecting an Industrial Ethernet FastConnect cable to data terminals and network components. The plug has a rugged, industry-compatible metal housing that provides optimum protection against faults in data communication.

The eight integrated insulation displacement contacts make contacting of the FC cable variants 4 x 2 and 2 x 2 easy and error-free. After the stripped cable end has been inserted in the insulation displacement terminals, the conductors make contact when the casing is closed.

Owing to their compact size, the plug connectors can be used both on devices with individual jacks and on devices with multiple jacks (blocks).

Data terminals with a suitable bracket on the housing provide additional tension and bending relief for the plug-in cable.

##### Function

The IE FC RJ45 Plug 4 x 2 is used to install uncrossed 10/100/1000 Mbit/s Ethernet connections up to 90 m without the use of patches. Crossed cables can also be installed by swapping the transmit and receive pair in a plug.

With the casing open, colored markers on the contact element make it simple to connect the cores to the insulation displacement contacts. The transparent synthetic material of the contact element allows users to check the contacts themselves.

##### Technical specifications

<b>Article No.</b>	<b>6GK1901-1BB11-2AA0</b>
<b>Product-type designation</b>	<b>IE FC RJ45 Plug 180 (4x2)</b>
Product description	RJ45 data plug-in connector
Acceptability for application	For connection to IE FC TP cables 4x2, suitable for fast assembly with the FastConnect system
<b>Transmission rate</b>	
Transfer rate	
• 1 for Industrial Ethernet	10 Mbit/s
• 2 for Industrial Ethernet	100 Mbit/s
• 3 for Industrial Ethernet	1 000 Mbit/s
<b>Interfaces</b>	
Number of electrical connections for Industrial Ethernet FC TP cables	8
Design of electrical connection	
• for Industrial Ethernet FC TP cables	integrated cut-and-clamp contacts for 8-wire TP FC installation cable RJ45 connector
• for network components and terminal equipment	
• FastConnect	Yes
<b>Mechanical data</b>	
Material of the enclosure	metal
<b>Design, dimensions and weight</b>	
Type of cable outlet	180 degree cable outlet
Width	13.7 mm
Height	16 mm
Depth	55 mm
Net weight	35 g
<b>Permitted ambient conditions</b>	
Ambient temperature	
• during operating	-40 ... +85 °C
• during storage	-40 ... +85 °C
• during transport	-40 ... +85 °C
Relative humidity at 25 °C without condensation during operating maximum	95 %
Protection class IP	IP20
Chemical resistance to water	-
<b>Product properties, functions, components general</b>	
Product feature silicon-free	Yes
Product component strain relief	Yes
<b>Standards, specifications, approvals</b>	
Verification of suitability	
• RoHS conformity	Yes
• UL-registration	Yes
Standard for structured cabling	Cat6

Ordering data	Article No.	Article No.
<b>IE FC RJ45 Plug 4 x 2</b> RJ45 plug connector for Industrial Ethernet (10/100/1 000 Mbit/s) with a rugged metal housing and integrated insulation displacement contacts for connecting Industrial Ethernet FC installation cables; 180° cable outlet; for network components and CPs/CPU's with Industrial Ethernet interface <ul style="list-style-type: none"> <li>• 1 pack = 1 unit</li> <li>• 1 pack = 10 units</li> <li>• 1 pack = 50 units</li> </ul>	<b>6GK1901-1BB11-2AA0</b> <b>6GK1901-1BB11-2AB0</b> <b>6GK1901-1BB11-2AE0</b>	<b>IE FC TP Standard Cable GP 4 x 2</b> 8-core, shielded TP installation cable for universal applications; with UL approval; sold by the meter; max. length 1 000 m, minimum order 20 m <ul style="list-style-type: none"> <li>• AWG 24, for connection to IE FC RJ45 Plug 4 x 2</li> </ul>
<b>IE FC stripping tool</b> Preadjusted stripping tool for fast stripping of Industrial Ethernet FC cables	<b>6GK1901-1GA00</b>	<b>IE FC TP Flexible Cable GP 4 x 2</b> 8-core, shielded TP installation cable for occasional movement; with UL approval; sold by the meter; max. quantity 1 000 m, minimum order 20 m <ul style="list-style-type: none"> <li>• AWG 24, for connection to IE FC RJ45 Plug 4 x 2</li> </ul>
		<b>IE FC blade cassettes (5 mm)</b> Replacement blade cassette for the Industrial Ethernet stripping tool; for use with IE FC RJ45 Plugs and Modular Outlet, 5 units
		<b>6XV1878-2A</b>  <b>6XV1878-2B</b>  <b>6GK1901-1GB01</b>

## PROFINET/Industrial Ethernet

### Cabling technology

#### IE Push Pull Plug PRO

##### Overview



- Data plug-in connectors suitable for on-site assembly for IE FC TP and POF/PCF cables for transmitting data up to 100 Mbit/s
- Power plug-in connector suitable for on-site assembly for transmitting 2 x 24 V between Industrial Ethernet stations
- Degree of protection IP65/67
- The plug-in connectors make contact using a push-pull mechanism.

##### **IE FC RJ45 Plug PRO / IE RJ45 Plug PRO**

- FastConnect Industrial Ethernet RJ45 plug-in connector suitable for on-site assembly for SCALANCE X-200IRT PRO switches, ET 200pro and SIMATIC RF systems
- Easy connection (insulation displacement contacts) for 4-core twisted pair installation cables (100 Mbit/s) with or without FastConnect quick-assembly system, without the need for special tools
- Industrial design (rugged plastic housing)
- Good EMC shielding and discharge

##### **IE SC RJ Plug PRO**

- Industrial Ethernet SC RJ plug-in connector suitable for on-site assembly of:
  - POF cables for SCALANCE X-200IRT PRO and SIMATIC ET 200pro switches
  - PCF cables for SCALANCE X-200IRT PRO switches
- Industrial design (rugged plastic housing)

##### **Power Plug PRO**

- 5-pin power plug-in connector suitable for on-site assembly, for 2 x 24 V voltage supply of the SCALANCE X-200IRT PRO switches, SIMATIC ET 200pro and SIMATIC RF systems

##### Benefits

get **Designed for Industry**

- Simple and flexible assembly on site for application-specific plug-in cables through data and power plug-in connectors suitable for on-site assembly in degree of protection IP65/67

##### Application

IE FC RJ45 Plug PRO and IE SC RJ Plug PRO (POF or PCF) are plug-in connectors with push pull device connection that thanks to their high degree of protection (IP65/67) are used outside cabinets along with suitable end devices and network components with a high degree of protection. Their silicon-free design enables them to also be used in the automobile industry, e.g. in paint shops.

**Technical specifications**

Article No.	6GK1901-1BB20-6AA0	6GK1901-1BB10-6AA0
Product-type designation	IE FC RJ45 Plug PRO (Push Pull)	IE RJ45 Plug PRO (Push Pull)
Product description	RJ45 data plug-in connector	RJ45 data plug-in connector
Acceptability for application	Field-assembly connector for push-pull device connection in high degree of protection	Field-assembly connector for push-pull device connection in high degree of protection
<b>Transmission rate</b>		
Transfer rate		
• 1 for Industrial Ethernet	10 Mbit/s	10 Mbit/s
• 2 for Industrial Ethernet	100 Mbit/s	100 Mbit/s
<b>Interfaces</b>		
Number of electrical connections		
• for Industrial Ethernet FC TP cables	4	4
• for network components and terminal equipment	1	1
Design of electrical connection		
• for Industrial Ethernet FC TP cables	integrated cut-and-clamp contacts for 4-wire TP FC installation cable	integrated cut-and-clamp contacts for 4-wire TP FC installation cable
• for network components and terminal equipment	RJ45 connector (Push Pull device connection)	RJ45 connector (Push Pull device connection)
Number of optical interfaces for optical waveguide	-	-
Design of optical connections for network components or terminal devices	-	-
Design of the electrical connection FastConnect	Yes	No
<b>Mechanical data</b>		
Material of the enclosure	plastic	plastic
<b>Design, dimensions and weight</b>		
Type of cable outlet	180 degree cable outlet	180 degree cable outlet
Width	22 mm	22 mm
Height	29 mm	30 mm
Depth	73 mm	67.7 mm
Net weight	68.8 g	68.8 g
<b>Permitted ambient conditions</b>		
Ambient temperature		
• during operating	-40 ... +70 °C	-40 ... +70 °C
• during storage	-40 ... +70 °C	-40 ... +70 °C
• during transport	-40 ... +70 °C	-40 ... +70 °C
Relative humidity at 25 °C without condensation during operating maximum	-	-
Protection class IP	IP65/67	IP65/67
Chemical resistance to water	resistant	resistant
<b>Product properties, functions, components general</b>		
Product feature silicon-free	Yes	Yes
Product component strain relief	Yes	Yes
<b>Standards, specifications, approvals</b>		
Verification of suitability		
• RoHS conformity	Yes	Yes
• UL-registration	Yes	Yes

## PROFINET/Industrial Ethernet

### Cabling technology

#### IE Push Pull Plug PRO

##### Technical specifications (continued)

Article No.	6GK1900-0MB00-6AA0	6GK1900-0NB00-6AA0	6GK1907-0AB10-6AA0
Product-type designation	IE SC RJ POF Plug PRO (Push Pull)	IE SC RJ PCF Plug PRO (Push Pull)	Power Plug PRO (Push Pull)
Product description	SC RJ plug-in connector for POF fiber-optic cables	SC RJ plug-in connector for PCF fiber-optic cables	Power plug-in connector, 5-pole
Acceptability for application	Field-assembly connector for push-pull device connection in high degree of protection	Field-assembly connector for push-pull device connection in high degree of protection	Field-assembly connector for push-pull device connection in high degree of protection, for voltage supply with 2 x 24 V DC
<b>Transmission rate</b>			
Transfer rate			
• 1 for Industrial Ethernet	100 Mbit/s	100 Mbit/s	-
• 2 for Industrial Ethernet	-	-	-
<b>Interfaces</b>			
Number of electrical connections			
• for Industrial Ethernet FC TP cables	-	-	-
• for network components and terminal equipment	-	-	1
Design of electrical connection			
• for Industrial Ethernet FC TP cables	-	-	-
• for network components and terminal equipment	-	-	Power contacts (Push Pull casing)
Number of optical interfaces for optical waveguide	1	1	-
Design of optical connections for network components or terminal devices	SC RJ connector (Push Pull device connection)	SC RJ connector (Push Pull device connection)	-
Design of the electrical connection FastConnect	No	No	No
<b>Mechanical data</b>			
Material of the enclosure	plastic	plastic	plastic
<b>Design, dimensions and weight</b>			
Type of cable outlet	180 degree cable outlet	180 degree cable outlet	180 degree cable outlet
Width	22 mm	22 mm	36 mm
Height	30 mm	30 mm	30 mm
Depth	62.5 mm	62.5 mm	66.3 mm
Net weight	63.5 g	63.5 g	83.1 g
<b>Permitted ambient conditions</b>			
Ambient temperature			
• during operating	-40 ... +70 °C	-40 ... +70 °C	-40 ... +70 °C
• during storage	-40 ... +70 °C	-40 ... +70 °C	-40 ... +70 °C
• during transport	-40 ... +70 °C	-40 ... +70 °C	-40 ... +70 °C
Relative humidity at 25 °C without condensation during operating maximum	-	-	-
Protection class IP	IP65/67	IP65/67	IP65/67
Chemical resistance to water	resistant	resistant	resistant
<b>Product properties, functions, components general</b>			
Product feature silicon-free	Yes	Yes	Yes
Product component strain relief	Yes	Yes	Yes
<b>Standards, specifications, approvals</b>			
Verification of suitability			
• RoHS conformity	Yes	Yes	Yes
• UL-registration	No	No	Yes

Ordering data	Article No.	Article No.
<b>IE FC RJ45 Plug PRO</b> FastConnect RJ45 plug-in connector suitable for on-site assembly in degree of protection IP65/67; plastic enclosure, insulation displacement technology, for SCALANCE X-200IRT PRO and SIMATIC ET 200pro switches; 1 package = 1 unit	6GK1901-1BB20-6AA0	
<b>IE RJ45 Plug PRO</b> RJ45 plug-in connector suitable for on-site assembly in degree of protection IP65/67; plastic enclosure, insulation displacement technology, for SCALANCE X-200IRT PRO and SIMATIC ET 200pro switches; 1 package = 1 unit	6GK1901-1BB10-6AA0	
<b>IE SC RJ POF Plug PRO</b> SC RJ plug-in connector suitable for on-site assembly in degree of protection IP65/67 for POF fiber optic cables; plastic housing, for SCALANCE X-200IRT PRO and SIMATIC ET 200pro switches; 1 package = 1 unit	6GK1900-0MB00-6AA0	
<b>IE SC RJ POF Plug PRO</b> SC RJ plug-in connector suitable for on-site assembly in degree of protection IP65/67 for PCF fiber optic cables; plastic housing, for SCALANCE X-200IRT PRO switches; 1 package = 1 unit	6GK1900-0NB00-6AA0	
<b>Power Plug PRO</b> 5-pole power plug-in connector suitable for on-site assembly in degree of protection IP65/67 for 2 x 24 V voltage supply; plastic housing, for SCALANCE X-200IRT PRO and SIMATIC ET 200pro switches; 1 package = 1 unit	6GK1907-0AB10-6AA0	
<i>IE FC TP cables</i>		
<b>IE FC TP Standard Cable GP 2 x 2 (Type A)</b> 4-core, shielded TP installation cable for connection to IE FC Outlet RJ45/ IE FC RJ45 Plug; PROFINET-compatible; with UL approval; sold by the meter; max. length 1 000 m, minimum order 20 m	6XV1840-2AH10	
<b>IE FC TP Flexible Cable GP 2 x 2 (Type B)</b> 4-core, shielded TP installation cable for connection to IE FC Outlet RJ45/ IE FC RJ45 Plug for occasional movement; PROFINET-compatible; with UL approval; sold by the meter; max. length 1 000 m, minimum order 20 m	6XV1870-2B	
<b>IE FC TP Trailing Cable GP 2 x 2 (Type C)</b> 4-core, shielded TP installation cable for connection to IE FC Outlet RJ45/ IE FC RJ45 Plug for use as trailing cable; PROFINET-compatible; with UL approval; sold by the meter; max. length 1 000 m, minimum order 20 m	6XV1870-2D	
<b>IE FC TP Trailing Cable 2 x 2 (Type C)</b> 4-core, shielded TP installation cable for connection to IE FC Outlet RJ45/ IE FC RJ45 Plug 180/90 for use as trailing cable; PROFINET-compatible; with UL approval; sold by the meter; max. length 1 000 m, minimum order 20 m	6XV1840-3AH10	
<b>IE TP Torsion Cable 2 x 2 (Type C)</b> 4-core, shielded TP installation cable for connection to IE FC Outlet RJ45/ IE FC RJ45 Plug for use with robots; PROFINET-compatible; with UL approval; sold by the meter; max. length 1 000 m, minimum order 20 m	6XV1870-2F	
<b>IE FC TP Marine Cable 2 x 2 (Type B)</b> 4-core, shielded TP installation cable for connection to IE FC Outlet RJ45/ IE FC RJ45 Plug 180/90; marine approval; max. length 1 000 m, minimum order 20 m	6XV1840-4AH10	
<b>IE FC TP Food Cable GP 2 x 2 (Type C)</b> 4-core, shielded TP installation cable for connection to IE FC Outlet RJ45/ IE FC RJ45 Plug 180/90 for the food and beverages industry; PROFINET-compatible; sold by the meter; max. length 1 000 m, minimum order 20 m	6XV1871-2L	
<b>IE FC TP Festoon Cable GP 2 x 2 (Type B)</b> 4-core, shielded TP installation cable for connection to IE FC Outlet RJ45/ IE FC RJ45 Plug 180/90 for use in festoon applications; PROFINET-compatible; with UL approval; sold by the meter; max. length 1 000 m, minimum order 20 m	6XV1871-2S	
<b>IE FC TP FRNC Cable GP 2 x 2 (Type B)</b> 4-core, shielded, halogen-free TP installation cable for connection to IE FC Outlet RJ45/ IE FC RJ45 Plug for occasional movement; PROFINET-compatible; with UL approval; sold by the meter; max. length 1 000 m, minimum order 20 m	6XV1871-2F	

## PROFINET/Industrial Ethernet

### Cabling technology

#### IE Push Pull Plug PRO

Ordering data	Article No.		Article No.
<i>FO cables</i>		<i>Power cables</i>	
<b>POF Standard Cable GP 980/1000</b>	<b>6XV1874-2A</b>	<b>Energy Cable 5 x 1.5</b>	<b>6XV1830-8AH10</b>
POF standard cable for fixed routing indoors with PVC sheath; sold by the meter; max. length 1 000 m; minimum order 20 m		Trailable power cable with 5 copper cores (1.5 mm <sup>2</sup> ) for connecting to 7/8" plug-in connectors; sold by the meter; max. length 1 000 m; minimum order 20 m	
<b>POF Trailing Cable 980/1000</b>	<b>6XV1874-2B</b>	<i>Pre-assembled cables</i>	
POF trailing cable for use in cable carriers, with rugged PUR sheath; sold by the meter; Delivery unit max. 1 000 m; minimum order 20 m		<b>SIMATIC RF600 connecting cable</b>	<b>6GT2891-1HN10</b>
<b>PCF Standard Cable GP 200/230</b>	<b>6XV1861-2A</b>	Preassembled connecting cable (10 m) with RJ45 Plug PRO and RJ45 Plug	
Standard cable, segmentable, sold by the meter; max. length 2 000 m; minimum order 20 m		<b>PROFINET Cabling and Interconnection Technology Guideline</b>	<a href="http://www.profinet.com">http://www.profinet.com</a>
<b>PCF Trailing Cable 200/230</b>	<b>6XV1861-2C</b>		
Trailing cable, segmentable, sold by the meter; max. length 2 000 m; minimum order 20 m			
<b>POF Trailing Cable GP 200/230</b>	<b>6XV1861-2D</b>		
Trailing cable, segmentable, sold by the meter; max. length 2 000 m; minimum order 20 m			

#### More information

##### Note:

Supplementary components for the SIMATIC NET cable range can be ordered from your local contact person.

Technical advice on this subject is available from:

J. Hertlein

I IA SC CI PRM 4

Phone: +49 (911) 750-4465

E-mail: [juergen.hertlein@siemens.com](mailto:juergen.hertlein@siemens.com)



**Overview**

FastConnect (FC) plug-in connectors that can be assembled in the field for transmission of data (up to 1000 Mbit/s) between Industrial Ethernet nodes with IP65/IP67 degree of protection

**Industrial Ethernet FC M12 Plug PRO (D coded)**

- Industrial Ethernet M12 plug-in connector with FastConnect connection system for on-site assembly for SCALANCE X208PRO, IM 154-4 PN and SIMATIC RF systems
- Easy connection (insulation displacement contacts) for 4-core twisted pair FC installation cables (10/100 Mbit/s) without the need for special tools
- Fault-preventing connection method thanks to visible contacting area and color-coded insulation piercing connecting devices
- Industry-compatible design (rugged metal enclosure)
- Excellent EMC shielding and deflection (metal enclosure)
- Integrated strain-relief for installation cables

**Industrial Ethernet FC M12 Plug PRO 4 x 2 (X-coded)**

- Industrial Ethernet M12 plug connectors, which can be assembled in the field, for on-site installation for SCALANCE W
- Easy connection (insulation displacement contacts) for 8-core twisted pair FC installation cables (10/100/1000 Mbit/s) without the need for special tools
- Fault-preventing connection method thanks to visible contacting area and color-coded insulation piercing connecting devices
- Industry-compatible design (rugged metal enclosure)
- Excellent EMC shielding and deflection (metal enclosure)
- Integrated strain-relief for installation cables

## PROFINET/Industrial Ethernet

### Cabling technology

#### IE FC M12 Plug PRO

##### Overview (continued)



Control cabinet feedthrough IE Panel Feedthrough and IE Panel Feedthrough PRO

##### **Industrial Ethernet panel feedthrough**

- Control cabinet feedthrough for conversion from M12 connection method (D coded, IP65/IP67) to RJ45 connection method (IP20)

##### **Industrial Ethernet panel feedthrough PRO**

- Coupling of M12 plug-in connectors (D-coded, IP65/IP67); can be used as cabinet bushing or for connecting two M12 plug-in connectors outside the control cabinet

##### Benefits

g e t **get** Designed for Industry

- Easy installation on-site for application-specific M12 plug-in cables by means of FastConnect M12 plug-in connectors (IE FC M12 Plug PRO, D-coded, and IE M12 Plug PRO 4x2, X-coded), which can be assembled in the field
- Simple assembly of adapter cables for the transition from IP65/67 degree of protection into the IP20 area within the same control cabinet by connecting the IE FC M12 Plug PRO and IE FC RJ45 Plug 2x2
- Reliable screen contact and strain relief are integrated
- Harmonized system made up of Industrial Ethernet FastConnect plug-in connectors and an extensive range of FastConnect cables with corresponding UL approvals and PROFINET conformity

**Technical specifications**

Article No.	6GK1901-0DB20-6AA0	6GK1901-0DB30-6AA0
Product-type designation	IE FC M12 Plug PRO (PROFINET)	IE FC M12 Plug PRO (PROFINET)
Product description	M12 plug-in connector, high degree of protection, 4-pole, D-coded	M12 plug-in connector, high degree of protection, 8-pole, X-coded
Acceptability for application	For connecting electrical cables to SCALANCE X208PRO, ET200 PRO PN or ET200 eco PN for fast assembly with the FastConnect system	For connecting electrical cables to SCALANCE W (M12 gigabit interface) for fast assembly with the FastConnect system
<b>Transmission rate</b>		
Transfer rate		
• 1 for Industrial Ethernet	10 Mbit/s	10 Mbit/s
• 2 for Industrial Ethernet	100 Mbit/s	100 Mbit/s
• 3 for Industrial Ethernet	-	1 000 Mbit/s
<b>Interfaces</b>		
Number of electrical connections for Industrial Ethernet FC TP cables	4	8
Design of the electrical connection		
• for Industrial Ethernet FC TP cables	integrated cut-and-clamp contacts for 4-wire TP FC installation cable	integrated cut-and-clamp contacts for 8-wire TP FC installation cable
• for network components and terminal equipment	M12 connector (D-coded)	M12 connector (X-coded)
• FastConnect	Yes	Yes
<b>Mechanical data</b>		
Material of the enclosure	metal	metal
<b>Design, dimensions and weight</b>		
Type of cable outlet	180 degree cable outlet	180 degree cable outlet
Width	19 mm	16 mm
Height	19 mm	16 mm
Depth	73 mm	53 mm
Net weight	40 g	40 g
<b>Permitted ambient conditions</b>		
Ambient temperature		
• during operating	-40 ... +85 °C	-40 ... +85 °C
• during storage	-40 ... +85 °C	-40 ... +85 °C
• during transport	-40 ... +85 °C	-40 ... +85 °C
Relative humidity at 25 °C without condensation during operating maximum	95 %	-
Protection class IP	IP65/67	IP65/67
Chemical resistance to water	resistant	resistant
<b>Product properties, functions, components general</b>		
Product feature silicon-free	Yes	Yes
Product component strain relief	Yes	Yes
<b>Standards, specifications, approvals</b>		
Verification of suitability		
• RoHS conformity	Yes	Yes
• UL-registration	Yes	No
Standard for structured cabling	Cat5	Cat5

## PROFINET/Industrial Ethernet

### Cabling technology

#### IE FC M12 Plug PRO

#### Technical specifications (continued)

Article No.	6GK1901-0DM20-2AA5	6GK1901-0DM30-2AA5
Product-type designation	IE M12 Panel Feedthrough	IE M12 Panel Feedthrough PRO
Product description	M12 panel feedthrough (D-coded) / RJ45	M12/M12 coupler (D-coded)
Acceptability for application	Panel feedthrough for conversion from M12 connection method (D-coded, IP65/IP67) to RJ45 connection method (IP20)	M12/M12 coupler and panel feedthrough (D-coded)
<b>Transmission rate</b>		
Transfer rate		
• 1 for Industrial Ethernet	10 Mbit/s	10 Mbit/s
• 2 for Industrial Ethernet	100 Mbit/s	100 Mbit/s
• 3 for Industrial Ethernet	-	-
<b>Interfaces</b>		
Number of electrical connections for Industrial Ethernet FC TP cables	-	-
Design of electrical connection		
• for Industrial Ethernet FC TP cables	-	-
• for network components and terminal equipment	M12 socket (D-coded) and RJ45	2 x M12 socket (D-coded)
• FastConnect	No	No
<b>Mechanical data</b>		
Material of the enclosure	plastic	metal
<b>Design, dimensions and weight</b>		
Type of cable outlet	90 degree cable outlet	180 degree cable outlet
Width	24 mm	35.6 mm
Height	45 mm	22.6 mm
Depth	35.4 mm	44.5 mm
Net weight	0.04 kg	0.036 kg
<b>Permitted ambient conditions</b>		
Ambient temperature		
• during operating	0 ... 70 °C	-5 ... +60 °C
• during storage	0 ... 70 °C	-5 ... +60 °C
• during transport	0 ... 70 °C	-5 ... +60 °C
Relative humidity at 25 °C without condensation during operating maximum	-	-
Protection class IP	IP65/67 (M12) / IP20 (RJ45)	IP65/67 (M12) / IP65/67 (M12)
Chemical resistance to water	-	resistant
<b>Product properties, functions, components general</b>		
Product feature silicon-free	Yes	Yes
Product component strain relief	Yes	Yes
<b>Standards, specifications, approvals</b>		
Verification of suitability		
• RoHS conformity	Yes	Yes
• UL-registration	Yes	No
Standard for structured cabling	Cat5	Cat5

Ordering data	Article No.	Article No.	
<b>IE FC M12 Plug PRO 2 x 2</b> M12 plug-in connector (D-coded, IP65/IP67) that can be assembled in the field, metal enclosure, FastConnect connection method, for SCALANCE X208PRO and IM 154-4 PN <ul style="list-style-type: none"> <li>• 1 unit</li> <li>• 8 unit</li> </ul>	<b>6GK1901-0DB20-6AA0</b> <b>6GK1901-0DB20-6AA8</b>	<b>IE TP Torsion Cable GP 2 x 2 (Type C)</b> 4-core, shielded TP installation cable for connection to IE FC Outlet RJ45/ IE FC RJ45 Plug for use with robots; PROFINET-compatible; with UL approval; sold by the meter; max. length 1 000 m, minimum order length 20 m	<b>6XV1870-2F</b>
<b>IE FC M12 Plug PRO 4 x 2</b> M12 plug-in connector suitable for on-site assembly (X-coded, IP65/IP67), metal enclosure, insulation/displacement fast connection method, for SCALANCE W <ul style="list-style-type: none"> <li>• 1 unit</li> <li>• 8 units</li> </ul>	<b>6GK1901-0DB30-6AA0</b> <b>6GK1901-0DB30-6AA8</b>	<b>IE FC TP Marine Cable 2 x 2 (Type B)</b> 4-core, shielded TP installation cable for connection to IE FC Outlet RJ45/ IE FC RJ45 Plug 180/90; marine approval; max. length 1 000 m, minimum order 20 m	<b>6XV1840-4AH10</b>
<b>IE panel feedthrough</b> Control cabinet feedthrough for conversion from M12 connection method (D coded, IP65/IP67) to RJ45 connection method (IP20) <ul style="list-style-type: none"> <li>• 1 pack = 5 units</li> </ul>	<b>6GK1901-0DM20-2AA5</b>	<b>IE FC TP Trailing Cable GP 2 x 2 (Type C)</b> 4-core, shielded TP installation cable for connection to IE FC Outlet RJ45/ IE FC RJ45 Plug for use as trailing cable; PROFINET-compatible; with UL approval; sold by the meter; max. length 1 000 m, minimum order 20 m	<b>6XV1870-2D</b>
<b>IE panel feedthrough PRO</b> Coupling of M12 plug-in connectors (D-coded, IP65/IP67); can be used as cabinet bushing or for connecting two M12 plug-in connectors outside the control cabinet <ul style="list-style-type: none"> <li>• 1 pack = 5 units</li> </ul>	<b>6GK1901-0DM30-2AA5</b>	<b>IE FC TP Festoon Cable GP 2 x 2 (Type B)</b> 4-core, shielded TP installation cable for connection to IE FC Outlet RJ45/ IE FC RJ45 Plug 180/90 for use in festoon applications; PROFINET-compatible; with UL approval; sold by the meter; max. length 1 000 m, minimum order 20 m	<b>6XV1871-2S</b>
<b>IE FC TP Standard Cable GP 2 x 2 (Type A)</b> 4-core, shielded TP installation cable for connection to IE FC Outlet RJ45/ IE FC RJ45 Plug; PROFINET-compatible; with UL approval; sold by the meter; max. length 1 000 m, minimum order 20 m  <u>Preferred length</u> <ul style="list-style-type: none"> <li>• 1 000 m</li> </ul>	<b>6XV1840-2AH10</b>  <b>6XV1840-2AU10</b>	<b>IE FC TP Food Cable GP 2 x 2 (Type C)</b> 4-core, shielded TP installation cable for connection to IE FC Outlet RJ45/ IE FC RJ45 Plug 180/90 for the food and beverages industry; PROFINET-compatible; sold by the meter; max. length 1 000 m, minimum order 20 m	<b>6XV1871-2L</b>
<b>IE FC TP Flexible Cable GP 2 x 2 (Type B)</b> 4-core, shielded TP installation cable for connection to IE FC Outlet RJ45/ IE FC RJ45 Plug for occasional movement; PROFINET-compatible; with UL approval; sold by the meter; max. length 1 000 m, minimum order 20 m	<b>6XV1870-2B</b>	<b>IE FC TP FRNC cable GP 2x2 (Type B)</b> 4-core, shielded, halogen-free TP installation cable for connection to IE FC Outlet RJ45/ IE FC RJ45 Plug for occasional movement; PROFINET-compatible; with UL approval; sold by the meter; max. length 1 000 m, minimum order 20 m	<b>6XV1871-2F</b>
<b>IE FC TP Trailing Cable 2 x 2 (Type C)</b> 4-core, shielded TP installation cable for connection to IE FC Outlet RJ45/ IE FC RJ45 Plug 180/90 for use in trailing cables; PROFINET-compatible; without UL approval; sold by the meter; max. length 1 000 m, minimum order 20 m	<b>6XV1840-3AH10</b>		

## PROFINET/Industrial Ethernet

### Cabling technology

#### IE FC M12 Plug PRO

##### Ordering data

##### Article No.

##### IE TP train cable GP 2x2 (Type C)

6XV1871-2T

4-core, shielded TP installation cable for connection to IE FC Outlet RJ45/IE FC RJ45 Plug 180/90 with railways approval; PROFINET-compliant; sold by the meter; max. length 1 000 m, minimum order 20 m

##### IE FC Standard Cable GP 4x2

6XV1878-2A

8-core, shielded TP installation cable for connection to IE FC RJ45 Plug 4x2 and IE M12 Plug PRO 4x2; PROFINET-compliant; with UL approval; sold by the meter; max. length 1 000 m, minimum order 20 m

##### IE FC Flexible Cable GP 4x2

6XV1878-2B

8-core, shielded TP installation cable for connection to IE FC RJ45 Plug 4x2 and IE M12 Plug PRO 4x2 for occasional movement; PROFINET-compliant; with UL approval; sold by the meter; max. length 1 000 m, minimum order 20 m

##### IE train cable GP 4x2

6XV1878-2T

8-core, shielded TP installation cable for connection to IE FC M12 plug PRO 4x2 for use in railway applications; with railway; sold by the meter; max length 1 000 m, minimum order 20 m

##### IE FC Stripping Tool

6GK1901-1GA00

Preadjusted stripping tool for fast stripping of Industrial Ethernet FC cables

##### IE FC blade cassettes (5 mm)

6GK1901-1GB01

Replacement blade cassette for the Industrial Ethernet stripping tool; for use with IE FC RJ45 Plugs and IE FC RJ45 Modular Outlet, 5 units

##### PROFINET Cabling and Interconnection Technology Guideline

<http://www.profinet.com>

##### More information

##### Note:

You can order components supplementary to the SIMATIC NET cabling range from your local contact.

Technical advice on this subject is available from:

J. Hertlein  
 I IA SC CI PRM 4  
 Phone: +49 (911) 750-4465  
 E-mail: [juergen.hertlein@siemens.com](mailto:juergen.hertlein@siemens.com)

### Overview

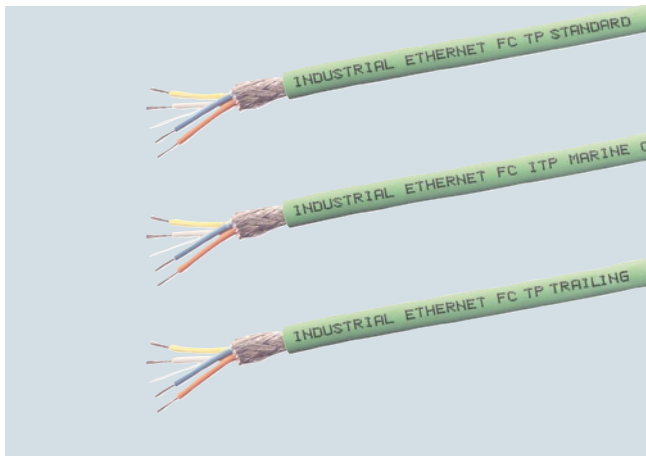

- 4-core FastConnect installation cables for structured Fast Ethernet cabling with special design for fast installation
- Easy stripping with the FastConnect Stripping Tool; the outer sheath and the braided shield are stripped accurately in one step
- Connection to FastConnect products using insulation displacement
- Exceeds Category 5 (Cat5e) of the international cabling standards ISO/IEC 11801 and EN 50173
- PROFINET-compatible
- UL approval
- Different versions for different fields of application (e.g. trailing, food, marine, railways)
- High interference immunity thanks to double shielding
- Easy length measurement thanks to printed meter markings

### Benefits

**get** Designed for Industry

- Time-saving due to simple and quick assembly with FastConnect cables 2 x 2 to Industrial Ethernet FC Outlet RJ45 (10/100 Mbit/s), Industrial Ethernet FC RJ45 Plug 180/145/90, or IE FC M12 Plug PRO 2x2
- Versatile application due to special bus cables
- Network is immune to interference thanks to double shielded cables and a uniform grounding concept
- Silicone-free, therefore suitable for use in the automotive industry (for example on paint lines)

### Application

For the construction of Industrial Ethernet networks (4-core), different cable types are offered to suit the different types of application.

In general, the listed Industrial Ethernet FC cables IE FC Cable 2 x 2 must be used.

#### Note:

You will find other specifications of the network topology in the manual for TP and fiber optic networks and in the Industrial Ethernet/PROFINET system manual.

#### UL approvals

Different cable variants are offered with appropriate UL/ETL approvals for laying in cable bundles and cable racks according to the specifications of NEC (National Electrical Code) Article 800/725. These are identified as GP (General Purpose).

### Design

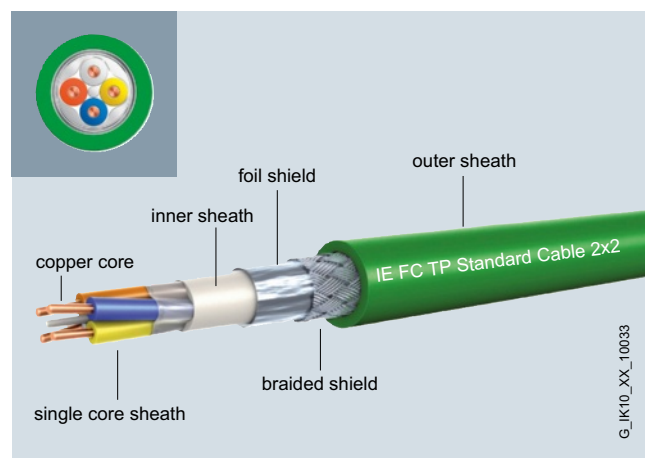

The FastConnect (FC) Industrial Ethernet cables IE FC Cable 2 x 2 are designed with radial symmetry and therefore allow the use of the FC Stripping Tool. The IE FC Outlet RJ45 and the IE FC Plugs can therefore be attached quickly and easily.

- The double shield makes it especially suitable for routing through industrial areas with strong electro-magnetic fields
- Easy connection to the insulation displacement contacts of the IE FC plug without the need for special tools
- System-wide grounding concept can be implemented through the outer shield of the bus cable as well as through the grounding concept of the IE FC Outlet RJ45 and the IE FC Plugs
- Printed meter marks

## PROFINET/Industrial Ethernet

### Cabling technology

#### IE FC TP Cable 2 x 2

##### Design (continued)

##### Cable types

- IE FC TP Standard Cable GP 2 x 2:**  
 Standard bus cable with rigid cores specially designed for fast installation;  
 four rigid cores connected in a four branch star
- IE FC TP Robust Standard Cable GP 2x2:**  
 Standard bus cable with rigid cores specially designed for fast installation;  
 four rigid cores connected in a four branch star with a rugged TPE outer sheath (thermoplastic elastomer)
- IE FC TP Flexible Cable GP 2 x 2:**  
 Flexible bus cable for the special application of occasional motion control;  
 four stranded cores connected in a four branch star
- IE FC TP Robust Flexible Cable GP 2x2:**  
 Flexible bus cable for the special application of occasional motion control;  
 four rigid cores connected in a four branch star with a rugged TPE outer sheath (thermoplastic elastomer)
- IE FC TP FRNC Cable GP 2 x 2:**  
 Flexible, halogen-free cable for use in buildings (FRNC= Flame Retardant Non Corrosive); four conductors (flexible leads) stranded into star-quad for occasional movement
- IE FC TP Trailing Cable GP / IE FC TP Trailing Cable 2 x 2:**  
 Highly flexible bus cable for the special application of constant motion control in a cable carrier, e.g. for continuously moving machine parts; four stranded cores connected in a four branch star
- IE FC Festoon Cable GP 2 x 2:**  
 Flexible cable for special use in constant movement in a cable trail/festoon arrangement, e.g. on crane systems; four cores (stranded) in twisted quads
- IE TP Torsion Cable 2 x 2:**  
 Highly flexible bus cable for the special application of continuous motion control, e.g. for use with robots; stranded cores
- IE FC TP Food Cable 2 x 2:**  
 Flexible cable for special use in the food and beverages industry;  
 four cores (stranded) in twisted quads
- IE FC TP Marine Cable 2 x 2:**  
 Bus cable for marine applications; four cores (stranded) connected in a four branch star, halogen-free, certified for marine applications
- IE TP Ground Cable 2 x 2:**  
 Bus cable for fixed routing in soil; four rigid cores connected in a four branch star, additional outer PE sheath (internal FC cable design)
- IE TP Train Cable 2 x 2:**  
 Bus cable for special applications in trains; four cores (tin-coated stranded wires) connected in a four branch star, certified for railway applications

##### Product overview IE FC TP Cable 2 x 2 (PROFINET-compatible according to "PROFINET Cabling and Interconnection Technology Guideline"<sup>1)</sup>)

	PROFINET Type A	PROFINET Type B	PROFINET Type C
	AWG 22/1 rigid laying	AWG 22/7 flexible cable for occasional movement	AWG 22 highly flexible cable for continuous motion, e.g. cable carrier or robots
IE FC TP Standard Cable GP 2 x 2 (Type A) 6XV1 840-2AH10	●	—	—
IE FC TP Robust Standard Cable GP 2 x 2 (Type A) 6XV1841-2A	●	—	—
IE FC TP Flexible Cable GP 2 x 2 (Type B) 6XV1 870-2B	—	●	—
IE FC TP Robust Flexible Cable GP 2 x 2 (Type B) 6XV1841-2B	—	●	—
IE FC TP FRNC Cable GP 2 x 2 (Type B) 6XV1 871-2F)	—	●	—
IE FC TP Trailing Cable GP 2 x 2 (Type C) 6XV1 870-2D	—	—	●
IE FC TP Trailing Cable 2 x 2 (Type C) 6XV1 840-3AH10	—	—	●
IE FC TP Festoon Cable GP 2 x 2 (Type B) 6XV1871-2S	—	●	—
IE TP Torsion Cable 2 x 2 (Type C) 6XV1 870-2F	—	—	●
IE FC TP Food Cable 2 x 2 (Type C) 6XV1871-2L	—	—	●
IE FC TP Marine Cable 2 x 2 (Type B) 6XV1 840-4AH10	—	●	—
IE TP Ground Cable 2 x 2 (Type C) 6XV1871-2G	—	—	●
IE TP Train Cable 2 x 2 (Type C) 6XV1871-2T	—	—	●

<sup>1)</sup> Available as a download under <http://www.profinet.com>



**Technical specifications**

Article No.	6XV1840-2AH10	6XV1841-2A	6XV1870-2B	6XV1841-2B
Product-type designation	IE FC TP Standard Cable GP 2 x 2 (Type A)	IE FC TP Robust Standard Cable GP 2 x 2 (Type A)	IE FC TP Flexible Cable GP 2 x 2 (Type B)	IE FC TP Robust Flexible Cable GP 2 x 2 (Type B)
Product description	Standard bus cable (4-core), sold by the meter, not assembled	Standard bus cable (4-core), sold by the meter, not assembled	Flexible bus cable (4-core), sold by the meter, not assembled	Flexible bus cable (4-core), sold by the meter, not assembled
Acceptability for application	Standard cable with rigid cores for fast installation	Standard cable with rigid cores for fast installation	For occasionally moved machine parts	For occasionally moved machine parts
Cable designation	2YY (ST) CY 2x2x0,64/1,5-100 GN	2YH (ST) C99Y 2x2x0,64/1,5-100 GN	2YY (ST) CY 2x2x0,75/1,5-100 LI GN	2YH (ST) C99Y 2x2x0,75/1,5-100 LI GN
<b>Electrical data</b>				
Damping ratio per length				
• at 10 MHz	52 dB/km	52 dB/km	60 dB/km	60 dB/km
• at 100 MHz	195 dB/km	195 dB/km	210 dB/km	210 dB/km
Impedance for frequency range 1 MHz ... 100 MHz	100 Ω	100 Ω	100 Ω	100 Ω
Relative symmetrical tolerance of the surge impedance at 1 MHz ... 100 MHz	15 %	15 %	15 %	15 %
Near-end crosstalk per length at 1 MHz ... 100 MHz	500 dB/km	0.5 dB/m	500 dB/km	0.5 dB/m
Transfer impedance at 10 MHz	10 mΩ/m	10 mΩ/m	20 mΩ/m	20 mΩ/m
Loop resistance per length	115 Ω/km	115 Ω/km	120 Ω/km	120 Ω/km
Insulation resistance coefficient	-	-	-	-
Operating voltage RMS value	100 V	100 V	100 V	100 V
Percentage NVP value	66 %	66 %	66 %	66 %
<b>Mechanical data</b>				
Number of electrical wires	4	4	4	4
Design of shield	Overlapped aluminum-clad foil, sheathed in a braided screen of tin-plated copper wires	Overlapped aluminum-clad foil, sheathed in a braided screen of tin-plated copper wires	Overlapped aluminum-clad foil, sheathed in a braided screen of tin-plated copper wires	Overlapped aluminum-clad foil, sheathed in a braided screen of tin-plated copper wires
Design of the electrical connection FastConnect	Yes	Yes	Yes	Yes
AWG number	-	-	-	-
Core diameter of the AWG22 core	0.64 mm	0.64 mm	0.75 mm	0.75 mm
Outer diameter				
• of the inner conductor	0.64 mm	0.64 mm	0.75 mm	0.75 mm
• of the wire insulation	1.5 mm	1.5 mm	1.5 mm	1.5 mm
• of the inner sheath of the cable	3.9 mm	3.9 mm	3.9 mm	3.9 mm
• of the cable sheath	6.5 mm	6.5 mm	6.5 mm	6.5 mm
Symmetrical tolerance of outer diameter of cable sheath	0.2 mm	0.2 mm	0.2 mm	0.2 mm
Material				
• of the wire insulation	PE	PE	PE	PE
• of the inner sheath of the cable	PVC	FRNC	PVC	FRNC
• of the cable sheath	PVC	TPE (FR-TPE)	PVC	TPE (FR-TPE)
Color				
• of the insulation of data wires	white / yellow / blue / orange	white / yellow / blue / orange	white / yellow / blue / orange	white / yellow / blue / orange
• of the cable sheath	green	green	green	green
Bending radius				
• with single bend	19.5 mm	19.5 mm	32.5 mm	32.5 mm
• with multiple bends	49 mm	49 mm	52 mm	52 mm
• with continuous bending	-	-	-	-
Number of bending cycles	-	-	-	-
• Note	-	-	-	-
Number of torsion cycles with torsion by ± 180° on 1 m cable length	-	-	-	-
Traction stress maximum	150 N	150 N	150 N	150 N
Weight per length	67 kg/km	67 kg/km	68 kg/km	68 kg/km

## PROFINET/Industrial Ethernet

### Cabling technology

#### IE FC TP Cable 2 x 2

#### Technical specifications (continued)

Article No.	6XV1840-2AH10	6XV1841-2A	6XV1870-2B	6XV1841-2B
Product-type designation	IE FC TP Standard Cable GP 2 x 2 (Type A)	IE FC TP Robust Standard Cable GP 2 x 2 (Type A)	IE FC TP Flexible Cable GP 2 x 2 (Type B)	IE FC TP Robust Flexible Cable GP 2 x 2 (Type B)
<b>Permitted ambient conditions</b>				
Ambient temperature				
• during operating	-40 ... +75 °C	-40 ... +75 °C	-25 ... +75 °C	-40 ... +75 °C
• during storage	-40 ... +75 °C	-40 ... +75 °C	-25 ... +75 °C	-40 ... +75 °C
• during transport	-40 ... +75 °C	-40 ... +75 °C	-25 ... +75 °C	-40 ... +75 °C
• during installation	-20 ... +60 °C	-20 ... +60 °C	-10 ... +60 °C	-20 ... +60 °C
Burning behaviour	flame resistant according to UL 1685 (CSA FT 4)	flame resistant according to IEC 60332-1-2	flame resistant according to UL 1685 (CSA FT 4)	flame resistant according to IEC 60332-1-2
Chemical resistance				
• to mineral oil	Conditional resistance	oil resistant according to DIN EN 50290-2-22 (VDE 0819), (7x24 h/90 °C), UL13 Sec.40 (96 h/100 °C)	Conditional resistance	oil resistant according to DIN EN 50290-2-22 (VDE 0819), (7x24 h/90 °C), UL13 Sec.40 (96 h/100 °C)
• to grease	Conditional resistance	Conditional resistance	Conditional resistance	Conditional resistance
• to water	Conditional resistance	Conditional resistance	Conditional resistance	Conditional resistance
Radiological resistance to UV radiation	Resistant	Resistant	Resistant	Resistant
<b>Product properties, functions, components general</b>				
Product feature				
• halogen-free	No	No	No	No
• silicon-free	Yes	Yes	Yes	Yes
Cable length with 100BaseTX for Industrial Ethernet	100 m	100 m	85 m	85 m
<b>Standards, specifications, approvals</b>				
UL/ETL listing with 300 V rating	Yes: cULus / CMG / PLTC / ITC(UL) / Sun Res	Yes: c(ETL)us, CM, PLTC, SUN RES	Yes: c(UL)us, CMG / PLTC / Sun Res / OIL RES	Yes: c(ETL)us, CM, PLTC, SUN RES
UL/ETL style with 600 V rating	yes	No	No	No
Verification of suitability				
• CE mark	Yes	Yes	Yes	Yes
• RoHS conformity	Yes	Yes	Yes	Yes
Standard for structured cabling	Cat5e	Cat5e	Cat5e	Cat5e
Marine classification association				
• American Bureau of Shipping Europe Ltd. (ABS)	No	No	No	No
• Bureau Veritas (BV)	No	No	No	No
• Det Norske Veritas (DNV)	No	No	No	No
• Germanische Lloyd (GL)	No	No	No	No
• Lloyds Register of Shipping (LRS)	No	No	No	No

**Technical specifications** (continued)

Article No.	6XV1870-2F	6XV1870-2D	6XV1840-3AH10	6XV1871-2S
Product-type designation	IE TP Torsion Cable 2 x 2 (Type C)	IE FC TP Trailing Cable GP 2 x 2 (Type C)	IE FC TP Trailing Cable 2 x 2 (Type C)	IE FC TP Festoon Cable GP 2 x 2 (Type B)
Product description	Highly flexible bus cable (4-core), sold by the meter, not assembled	Patch cable, preferred length, pre-assembled with a 15-pole Sub-D connector and a RJ45 connector	Highly flexible bus cable (4-core), sold by the meter, not assembled	Flexible bus cable (4-core), sold by the meter, not assembled
Acceptability for application	Continuous motion control when using robots	Continuous motion control in a cable carrier	Continuous motion control in a cable carrier	For continuous motion in a trailing cable, festoon mounting
Cable designation	02YS C11Y 1x4x0,75/1,5-100 LI VZN FRNC GN	2YY (ST) CY 2x2x0,75/1,5-100 LI GN	2YH (ST) C11Y 2x2x0,75/1,5-100 LI GN VZN FRNC	2YY (ST) CY 2x2x0,75/1,5 LI GN
<b>Electrical data</b>				
Damping ratio per length				
• at 10 MHz	81 dB/km	63 dB/km	60 dB/km	63 dB/km
• at 100 MHz	410 dB/km	213 dB/km	220 dB/km	213 dB/km
Impedance for frequency range 1 MHz ... 100 MHz	100 Ω	100 Ω	100 Ω	100 Ω
Relative symmetrical tolerance of the surge impedance at 1 MHz ... 100 MHz	15 %	5 %	15 %	5 %
Near-end crosstalk per length at 1 MHz ... 100 MHz	0.5 dB/m	500 dB/km	500 dB/km	500 dB/km
Transfer impedance at 10 MHz	100 mΩ/m	20 mΩ/m	10 mΩ/m	100 mΩ/m
Loop resistance per length	120 Ω/km	0.12 Ω/m	0.12 Ω/m	0.12 Ω/m
Insulation resistance coefficient	-	-	-	-
Operating voltage RMS value	100 V	100 V	100 V	100 V
Percentage NVP value	70 %	66 %	66 %	66 %
<b>Mechanical data</b>				
Number of electrical wires	4	4	4	4
Design of shield	Overlapped aluminum-clad foil, sheathed in a braided screen of tin-plated copper wires	Overlapped aluminum-clad foil, sheathed in a braided screen of tin-plated copper wires	Overlapped aluminum-clad foil, sheathed in a braided screen of tin-plated copper wires	Overlapped aluminum-clad foil, sheathed in a braided screen of tin-plated copper wires
Design of the electrical connection FastConnect	No	Yes	Yes	Yes
Core diameter of the AWG22 core	0.76 mm	0.75 mm	0.75 mm	0.75 mm
Outer diameter				
• of the inner conductor	0.76 mm	0.75 mm	0.75 mm	0.75 mm
• of the wire insulation	1.5 mm	1.5 mm	1.5 mm	1.5 mm
• of the inner sheath of the cable	-	3.9 mm	3.9 mm	3.9 mm
• of the cable sheath	6.5 mm	6.5 mm	6.5 mm	6.5 mm
Symmetrical tolerance of outer diameter of cable sheath	0.2 mm	0.2 mm	0.2 mm	0.2 mm
Material				
• of the wire insulation	PE	PE	PE	PE
• of the inner sheath of the cable	-	PVC	FRNC	PVC
• of the cable sheath	PUR (TPE-U)	PVC	PUR (TPE-U)	PVC
Color				
• of the insulation of data wires	white / yellow / blue / orange	white / yellow / blue / orange	white / yellow / blue / orange	white / yellow / blue / orange
• of the cable sheath	green	green	green	green
Bending radius				
• with single bend	32.5 mm	32.5 mm	19.5 mm	30 mm
• with multiple bends	65 mm	49 mm	49 mm	70 mm
• with continuous bending	-	100 mm	100 mm	70 mm
Number of bending cycles				
• Note	Not suitable for installation in festoons	3 000 000	4 000 000	5 000 000
		For use in cable carriers, for 3 million bending cycles with a bending radius of 100 mm, a speed of 4 m/s, and an acceleration of 4 m/s <sup>2</sup>	For use in cable carriers, for 4 million bending cycles with a bending radius of 100 mm, a speed of 4 m/s, and an acceleration of 4 m/s <sup>2</sup>	5 million bending cycles for a bending radius of 70 mm and an acceleration of 4 m/s <sup>2</sup>
Number of torsion cycles with torsion by ± 180° on 1 m cable length	5 000 000	-	-	-
Traction stress maximum	130 N	150 N	150 N	150 N
Weight per length	54 kg/km	68 kg/km	63 kg/km	68 kg/km

## PROFINET/Industrial Ethernet

### Cabling technology

#### IE FC TP Cable 2 x 2

#### Technical specifications (continued)

Article No.	6XV1870-2F	6XV1870-2D	6XV1840-3AH10	6XV1871-2S
Product-type designation	IE TP Torsion Cable 2 x 2 (Type C)	IE FC TP Trailing Cable GP 2 x 2 (Type C)	IE FC TP Trailing Cable 2 x 2 (Type C)	IE FC TP Festoon Cable GP 2 x 2 (Type B)
<b>Permitted ambient conditions</b>				
Ambient temperature				
• during operating	-40 ... +80 °C	-25 ... +75 °C	-40 ... +75 °C	-40 ... +75 °C
• during storage	-40 ... +80 °C	-25 ... +75 °C	-50 ... +75 °C	-50 ... +75 °C
• during transport	-40 ... +80 °C	-25 ... +75 °C	-50 ... +75 °C	-50 ... +75 °C
• during installation	-20 ... +60 °C	-10 ... +60 °C	-20 ... +60 °C	-20 ... +60 °C
Burning behaviour	flame resistant according to IEC 60332-1-2	flame resistant according to UL 1685 (CSA FT 4)	flame resistant according to IEC 60332-1-2	flame resistant according to UL 1685 (CSA FT 4)
Chemical resistance				
• to mineral oil	oil resistant according to IEC 60811-2-1 (7x24h/90°C)	Conditional resistance	oil resistant according to IEC 60811-2-1 (7x24h/90°C)	Conditional resistance
• to grease	Resistant	Conditional resistance	Resistant	Conditional resistance
• to water	Resistant	Conditional resistance	Resistant	Conditional resistance
Radiological resistance to UV radiation	Resistant	Resistant	Resistant	Resistant
<b>Product properties, functions, components general</b>				
Product feature				
• halogen-free	Yes	No	Yes	No
• silicon-free	Yes	Yes	Yes	Yes
Cable length with 100BaseTX for Industrial Ethernet	55 m	85 m	85 m	85 m
<b>Standards, specifications, approvals</b>				
UL/ETL listing with 300 V rating	Yes: UL Style 21161	Yes: c(UL)us, CMG / PLTC / Sun Res / OIL RES	Yes: cULus / CMX	Yes: c(UL)us, CMG / PLTC / Sun Res / OIL RES
UL/ETL style with 600 V rating	No	yes	No	yes
Verification of suitability				
• CE mark	Yes	Yes	Yes	Yes
• RoHS conformity	-	Yes	Yes	Yes
Standard for structured cabling	Cat5e	Cat5e	Cat5e	Cat5e
Marine classification association				
• American Bureau of Shipping Europe Ltd. (ABS)	No	No	No	No
• Bureau Veritas (BV)	No	No	No	No
• Det Norske Veritas (DNV)	No	No	No	No
• Germanische Lloyd (GL)	No	No	No	No
• Lloyds Register of Shipping (LRS)	No	No	No	No

**Technical specifications** (continued)

Article No.	6XV1871-2F	6XV1871-2L	6XV1840-4AH10
Product-type designation	IE FC TP FRNC Cable GP 2x2 (Type B)	IE FC TP Food Cable 2 x 2 (Type C)	IE FC TP Marine Cable 2 x 2 (Type B)
Product description	Flexible, halogen-free bus cable (4-core), sold by the meter, not assembled	Flexible bus cable (4-core), sold by the meter, not assembled	Bus cable (4-core), sold by the meter, not assembled
Acceptability for application	For occasionally moved machine parts	Food and beverages industry	For marine and offshore use
Cable designation	L-9YH (ST) CH 2x2x0,34/1,5-100 GN VZN FRNC	2YH (ST) C2Y 2X2X0,75/1,5-100 LI	L-9YH (ST) CH 2 x 2 x 0,34/1,5-100 GN VZN FRNC
<b>Electrical data</b>			
Damping ratio per length			
• at 10 MHz maximum	60 dB/km	63 dB/km	60 dB/km
• at 100 MHz maximum	220 dB/km	213 dB/km	220 dB/km
Impedance for frequency range 1 MHz ... 100 MHz	100 Ω	100 Ω	100 Ω
Relative symmetrical tolerance of the surge impedance at 1 MHz ... 100 MHz	15 %	5 %	15 %
Near-end crosstalk per length at 1 MHz ... 100 MHz	500 dB/km	500 dB/km	500 dB/km
Transfer impedance at 10 MHz	10 mΩ/m	10 mΩ/m	10 mΩ/m
Loop resistance per length	120 Ω/km	120 Ω/km	120 Ω/km
Operating voltage RMS value	100 V	100 V	100 V
Percentage NVP value	66 %	66 %	66 %
<b>Mechanical data</b>			
Number of electrical wires	4	4	4
Design of shield	Overlapped aluminum-clad foil, sheathed in a braided screen of tin-plated copper wires	Overlapped aluminum-clad foil, sheathed in a braided screen of tin-plated copper wires	Overlapped aluminum-clad foil, sheathed in a braided screen of tin-plated copper wires
Design of the electrical connection FastConnect	Yes	Yes	Yes
AWG number	-	-	-
Core diameter of the AWG22 core	0.75 mm	0.75 mm	0.75 mm
Outer diameter			
• of the inner conductor	0.75 mm	0.75 mm	0.75 mm
• of the wire insulation	1.5 mm	1.5 mm	1.5 mm
• of the inner sheath of the cable	3.9 mm	3.9 mm	3.9 mm
• of the cable sheath	6.5 mm	6.5 mm	6.5 mm
Symmetrical tolerance of outer diameter of cable sheath	0.2 mm	0.2 mm	0.2 mm
Material			
• of the wire insulation	PP	PE	PP
• of the inner sheath of the cable	FRNC	FRNC	FRNC
• of the cable sheath	FRNC	PE	FRNC
- Note	-	-	-
Color			
• of the insulation of data wires	white / yellow / blue / orange	white / yellow / blue / orange	white / yellow / blue / orange
• of the cable sheath	green	Black	green
Bending radius			
• with single bend minimum permissible	39 mm	20 mm	39 mm
• with multiple bends minimum permissible	97.5 mm	49 mm	97.5 mm
Traction stress maximum	150 N	150 N	150 N
Weight per length	68 kg/km	55 kg/km	68 kg/km

## PROFINET/Industrial Ethernet

### Cabling technology

#### IE FC TP Cable 2 x 2

#### Technical specifications (continued)

Article No.	6XV1871-2F	6XV1871-2L	6XV1840-4AH10
Product-type designation	IE FC TP FRNC Cable GP 2x2 (Type B)	IE FC TP Food Cable 2 x 2 (Type C)	IE FC TP Marine Cable 2 x 2 (Type B)
<b>Permitted ambient conditions</b>			
Ambient temperature			
• during operating	-25 ... +70 °C	-40 ... +75 °C	-25 ... +70 °C
• during storage	-40 ... +75 °C	-50 ... +75 °C	-40 ... +85 °C
• during transport	-40 ... +75 °C	-50 ... +75 °C	-40 ... +85 °C
• during installation	0 ... 50 °C	-20 ... +60 °C	0 ... 50 °C
Ambient condition for (standard) operation mode	-	-	Temperature range for permanent installation -40 °C to 85 °C
Burning behaviour	flame resistant according to IEC 60332-3-22 (Category A/F), IEC 61034	inflammable	flame resistant according to IEC 60332-3-22 (Category A/F)
Chemical resistance			
• to mineral oil	oil resistant according to IEC 60811-2-1 (4 h / 70°C)	oil resistant according to IEC 60811-2-1 (4 h / 70°C)	Conditional resistance, IEC 60811-2-1 (4 hours / 70 °C)
• to grease	Conditional resistance	Conditional resistance	Conditional resistance
• to water	Conditional resistance	Conditional resistance	Conditional resistance
Radiological resistance to UV radiation	Resistant	Resistant	Resistant
<b>Product properties, functions, components general</b>			
Product feature			
• halogen-free	Yes	Yes	Yes
• silicon-free	Yes	Yes	Yes
Cable length with 100BaseTX for Industrial Ethernet	85 m	85 m	85 m
<b>Standards, specifications, approvals</b>			
UL/ETL listing with 300 V rating	Yes: c(UL)us, CMG / PLTC / Sun Res / OIL RES	No	Yes: cULus / CMG / PLTC / Sun Res
UL/ETL style with 600 V rating			
Verification of suitability			
• CE mark	Yes	Yes	-
• RoHS conformity	Yes	Yes	Yes
Standard for structured cabling	Cat5e	Cat5e	Cat5e
Marine classification association			
• American Bureau of Shipping Europe Ltd. (ABS)	No	No	Yes
• Bureau Veritas (BV)	No	No	Yes
• Det Norske Veritas (DNV)	No	No	Yes
• Germanische Lloyd (GL)	No	No	Yes
• Lloyds Register of Shipping (LRS)	No	No	Yes

**Technical specifications** (continued)

Article No.	6XV1871-2G	6XV1871-2T
Product-type designation	IE TP Ground Cable 2x2 (Typ C)	IE TP Train Cable 2x2 (Typ C, AWG22/7)
Product description	Standard bus cable (4-core), for laying in soil, sold by the meter, not assembled	Flexible bus cable with tin-coated stranded wires, (4-core) for applications in trains, sold by the meter, not assembled
Acceptability for application	Standard cable with rigid cores for fast installation	For laying in rail vehicles and buses
Cable designation	2YY(ST)CY2Y2x2x0.64/1.50-100	-
<b>Electrical data</b>		
Damping ratio per length		
• at 10 MHz	0.063 dB/m	0.053 dB/m
• at 100 MHz	0.213 dB/m	0.188 dB/m
Impedance for frequency range 1 MHz ... 100 MHz	100 Ω	100 Ω
Relative symmetrical tolerance of the surge impedance at 1 MHz ... 100 MHz	5 %	5 %
Near-end crosstalk per length at 1 MHz ... 100 MHz	0.5 dB/m	0.5 dB/m
Transfer impedance at 10 MHz	10 mΩ/m	8 mΩ/m
Loop resistance per length	124 Ω/km	124 Ω/km
Operating voltage RMS value	100 V	125 V
percentage NVP value	64 %	-
<b>Mechanical data</b>		
Number of electrical wires	4	4
Design of shield	Overlapped aluminum-clad foil, sheathed in a braided screen of tin-plated copper wires	Overlapped aluminum-clad foil, sheathed in a braided screen of tin-plated copper wires
Design of the electrical connection FastConnect	Yes	No
AWG number	-	-
Core diameter of the AWG22 core	0.64 mm	0.75 mm
Outer diameter		
• of the inner conductor	0.64 mm	0.75 mm
• of the wire insulation	1.5 mm	1.5 mm
• of the inner sheath of the cable	4 mm	-
• of the cable sheath	9 mm	6.6 mm
Symmetrical tolerance of outer diameter of cable sheath	0.2 mm	0.2 mm
Outer diameter of the cable sheath Note	Cable diameter > 6.5 mm due to additional PE protective jacket. Cable can only be connected in the RJ45/M12 connector after stripping the protective jacket.	-
Material		
• of the wire insulation	PE	PE
• of the inner sheath of the cable	PVC	-
• of the cable sheath	PVC	Elastomer meshed electron beam
Color		
• of the insulation of data wires	white / yellow / blue / orange	white / yellow / blue / orange
• of the cable sheath	Black	Black
Bending radius		
• with single bend	80 mm	40 mm
• with multiple bends	80 mm	40 mm
Traction stress maximum	150 N	150 N
Weight per length	97 kg/km	71 kg/km

## PROFINET/Industrial Ethernet

### Cabling technology

#### IE FC TP Cable 2 x 2

#### Technical specifications (continued)

Article No.	6XV1871-2G	6XV1871-2T
Product-type designation	IE TP Ground Cable 2x2 (Typ C)	IE TP Train Cable 2x2 (Typ C, AWG22/7)
<b>Permitted ambient conditions</b>		
Ambient temperature		
• during operating	-40 ... +70 °C	-40 ... +80 °C
• during storage	-40 ... +70 °C	-40 ... +80 °C
• during transport	-40 ... +70 °C	-40 ... +80 °C
• during installation	-5 ... +50 °C	-20 ... +60 °C
Ambient condition for (standard) operation mode	-	Electrical characteristics measured at 20 °C, tests according to EN 50288-2-1
Burning behaviour	inflammable	BS6853, DIN5510-2 levels of protection 1-4, prEN45545-2 Hazard Level HL1-HL3, EN50306-4, NF F 16-101, NFPA130
Chemical resistance		
• to mineral oil	Conditional resistance	EN 50306-4 (72h/100 °C, IRM 902, 168h/70 °C, IRM 903)
• to grease	Conditional resistance	Conditional resistance
• to water	Resistant	Conditional resistance
Radiological resistance to UV radiation	Resistant	Resistant
<b>Product properties, functions, components general</b>		
Product feature		
• halogen-free	No	Yes
• silicon-free	Yes	Yes
Cable length with 100BaseTX for Industrial Ethernet	100 m	100 m
<b>Standards, specifications, approvals</b>		
UL/ETL listing with 300 V rating	No	No
UL/ETL style with 600 V rating	No	No
Verification of suitability		
• CE mark	Yes	Yes
• UL-registration	-	-
• RoHS conformity	Yes	Yes
Standard for structured cabling	Cat5e	Cat5
Marine classification association		
• American Bureau of Shipping Europe Ltd. (ABS)	No	No
• Bureau Veritas (BV)	No	No
• Det Norske Veritas (DNV)	No	No
• Germanische Lloyd (GL)	No	No
• Lloyds Register of Shipping (LRS)	No	No



Ordering data	Article No.	Article No.	
<b>IE FC TP Standard Cable GP 2 x 2 (Type A)</b> 4-core, shielded TP installation cable for connection to IE FC Outlet RJ45/IE FC RJ45/M12 Plug; PROFINET-compatible; with UL approval; Sold by the meter; max. length 1 000 m, minimum order 20 m <u>Preferred length</u> • 1000 m	<b>6XV1840-2AH10</b>  <b>6XV1840-2AU10</b>	<b>IE FC TP Festoon Cable GP 2 x 2 (Type B)</b> 4-core, shielded TP installation cable for connection to IE FC Outlet RJ45/IE FC RJ45/M12 Plug for use in festoon applications; PROFINET-compatible; with UL approval; sold by the meter; max. length 1 000 m, minimum order 20 m	<b>6XV1871-2S</b>
<b>IE FC TP Robust Cable GP 2 x 2 (Type A)</b> 4-core, shielded TP installation cable with TPE outer sheath for connection to IE FC Outlet RJ45/IE FC RJ45/M12 Plug; PROFINET-compatible; with UL approval Sold by the meter; max. length 1 000 m, minimum order 20 m	<b>6XV1841-2A</b>	<b>IE TP torsion cable 2 x 2 (Type C)</b> 4-core, shielded TP installation cable for connection to IE FC Outlet RJ45/IE FC RJ45/M12 Plug for use with robots; PROFINET-compatible; with UL approval; sold by the meter; max. length 1 000 m, minimum order 20 m	<b>6XV1870-2F</b>
<b>IE FC TP Flexible Cable GP 2 x 2 (Type B)</b> 4-core, shielded TP installation cable for connection to IE FC Outlet RJ45/IE FC RJ45/M12 Plug for occasional movement; PROFINET-compatible; with UL approval; Sold by the meter; max. length 1 000 m, minimum order 20 m	<b>6XV1870-2B</b>	<b>IE FC TP Food Cable GP 2 x 2 (Type C)</b> 4-core, shielded TP installation cable for connection to IE FC Outlet RJ45/IE FC RJ45/M12 Plug for the food and beverages industry; PROFINET-compatible; sold by the meter; max. length 1 000 m, minimum order 20 m	<b>6XV1871-2L</b>
<b>IE FC TP Robust Flexible Cable GP 2 x 2 (Type B)</b> 4-core, shielded TP installation cable with TPE outer sheath for connection to IE FC Outlet RJ45/IE FC RJ45/M12 Plug for occasional movement; PROFINET-compatible; with UL approval; Sold by the meter; max. length 1 000 m, minimum order 20 m	<b>6XV1841-2B</b>	<b>IE FC TP Marine Cable 2 x 2 (Type B)</b> 4-core, shielded TP installation cable for connection to IE FC Outlet RJ45/IE FC RJ45/M12 Plug marine approval; sold by the meter; max. length 1 000 m, minimum order 20 m	<b>6XV1840-4AH10</b>
<b>IE FC TP FRNC Cable GP 2 x 2 (Type B)</b> 4-core, shielded, halogen-free TP installation cable for connection to IE FC Outlet RJ45/IE FC RJ45/M12 Plug for occasional movement; PROFINET-compatible; with UL approval; sold by the meter; max. length 1 000 m, minimum order 20 m	<b>6XV1871-2F</b>	<b>IE TP Ground Cable 2 x 2 (Type C)</b> 4-core, shielded TP installation cable for connection to IE FC Outlet RJ45/IE FC RJ45/M12 Plug (additional outer sheath must be removed) for laying in soil; sold by the meter; max. length 1 000 m, minimum order 20 m	<b>6XV1871-2G</b>
<b>IE FC TP Trailing Cable GP 2 x 2 (Type C)</b> 4-core, shielded TP installation cable for connection to IE FC Outlet RJ45/IE FC RJ45/M12 Plug for use in trailing cables; PROFINET-compatible; with UL approval; sold by the meter; max. length 1 000 m, minimum order 20 m	<b>6XV1870-2D</b>	<b>IE TP Train Cable 2 x 2 (Type C)</b> 4-core, shielded TP installation cable for connection to IE FC RJ45 Plug and IE FC M12 Plug PRO; sold by the meter; max. length 1 000 m, minimum order 20 m	<b>6XV1871-2T</b>
<b>IE FC TP Trailing Cable 2 x 2 (Type C)</b> 4-core, shielded TP installation cable for connection to IE FC Outlet RJ45/IE FC RJ45/M12 Plug for use in trailing cables; PROFINET-compatible; with UL approval; sold by the meter; max. length 1 000 m, minimum order 20 m	<b>6XV1840-3AH10</b>	<b>IE Hybrid Cable 2x2 + 4x0.34</b> Flexible cable, 4 x Cu Cat5, shielded (0.75 mm) and 4 x Cu (0.34 mm <sup>2</sup> ) with IE FC modular outlet and power insert and IP67 hybrid plug connector; sold by the meter; up to 1 000 m; minimum order 20 m	<b>6XV1870-2J</b>

## PROFINET/Industrial Ethernet

### Cabling technology

#### IE FC TP Cable 2 x 2

Ordering data	Article No.
<i>Accessories</i>	
<b>IE FC stripping tool</b> Preadjusted stripping tool for fast stripping of Industrial Ethernet FC cables	<b>6GK1901-1GA00</b>
<b>IE FC Blade Cassettes (12 mm)</b> Replacement blade cassette for the Industrial Ethernet stripping tool; for use with IE FC Outlet RJ45, ELS TP40, 5 units	<b>6GK1901-1GB00</b>
<b>IE FC Blade Cassettes (5 mm)</b> Replacement blade cassette for the Industrial Ethernet stripping tool; for use with IE FC RJ45 Plugs and IE FC RJ45 Modular Outlet, 5 units	<b>6GK1901-1GB01</b>
<i>IE FC RJ45 plugs</i>	
RJ45 plug connector for Industrial Ethernet with a rugged metal housing and integrated insulation displacement contacts for connecting Industrial Ethernet FC installation cables	
<b>IE FC RJ45 Plug 180</b> 180° cable outlet; for network components and CPs/CPUs with Industrial Ethernet interface <ul style="list-style-type: none"> <li>• 1 pack = 1 unit</li> <li>• 1 pack = 10 units</li> <li>• 1 pack = 50 units</li> </ul>	<b>6GK1901-1BB10-2AA0</b> <b>6GK1901-1BB10-2AB0</b> <b>6GK1901-1BB10-2AE0</b>
<b>IE FC RJ45 plug 90</b> 90° cable outlet; e.g. for ET 200S <ul style="list-style-type: none"> <li>• 1 pack = 1 unit</li> <li>• 1 pack = 10 units</li> <li>• 1 pack = 50 units</li> </ul>	<b>6GK1901-1BB20-2AA0</b> <b>6GK1901-1BB20-2AB0</b> <b>6GK1901-1BB20-2AE0</b>
<b>IE FC RJ45 Plug 145</b> 145° cable outlet; e.g. for SIMOTION and SINAMICS <ul style="list-style-type: none"> <li>• 1 pack = 1 unit</li> <li>• 1 pack = 10 units</li> <li>• 1 pack = 50 units</li> </ul>	<b>6GK1901-1BB30-0AA0</b> <b>6GK1901-1BB30-0AB0</b> <b>6GK1901-1BB30-0AE0</b>
<i>IE FC M12 Plugs</i>	
<b>IE FC M12 Plug PRO 2x2</b> M12 plug-in connector (D-coded, IP65/IP67) that can be assembled in the field, metal enclosure, FastConnect connection method, for SCALANCE X208PRO and IM 154-4 PN <ul style="list-style-type: none"> <li>• 1 unit</li> <li>• 8 units</li> </ul>	<b>6GK1901-0DB20-6AA0</b> <b>6GK1901-0DB20-6AA8</b>
<b>SIMATIC NET Manual Collection</b> Electronic manuals for communication systems, communication protocols, and communication products; on DVD; German/English	<b>6GK1975-1AA00-3AA0</b>
<b>PROFINET Cabling and Interconnection Technology Guideline</b>	<a href="http://www.profinet.com">http://www.profinet.com</a>

#### More information

##### Installation instructions

The bus cables are supplied by the meter with meter marks printed on them.

##### FastConnect

With the help of Industrial Ethernet FastConnect Stripping Tool, it is possible to strip the outer sheath and shield of Industrial Ethernet FastConnect cables 2 x 2 to the right length in one step. The IE Outlet RJ45 and the PROFINET-compatible plug-in connectors IE FC RJ45 and IE FC M12 can be connected quickly and easily to the Industrial Ethernet FC cable 2 x 2.

##### Cable routing

During storage, transport and cable laying, keep both ends sealed with a shrink-on cap; comply with the permissible bending radii and tensile load.

### Overview

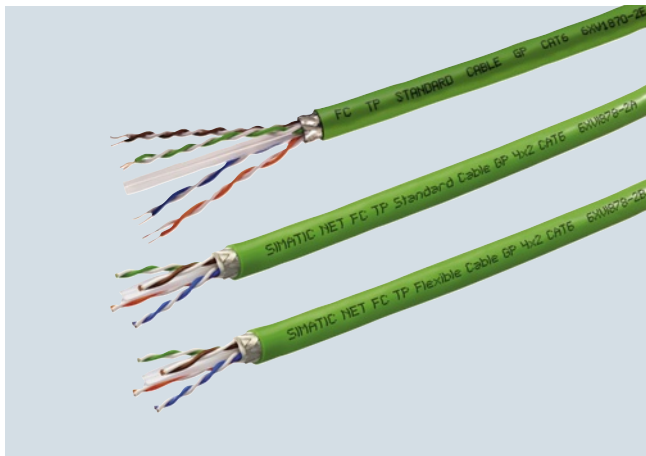

- 8-core FastConnect installation cables for cabling system with Gigabit capability (AWG22 and AWG24 versions)
- Easy stripping with the FastConnect Stripping Tool; the outer sheath and the braided shield are stripped accurately in one step
- Connection to IE FC RJ45 Modular Outlet (AWG22) or IE FC RJ45 Plug 4 x 2 (AWG24) using insulation displacement
- Satisfies Category 6 (Cat6) of the international cabling standards ISO/IEC 11801 and EN 50173
- UL approval
- Easy length measurement thanks to printed meter markings

### Benefits

**get** Designed for Industry

- Time-saving due to quick and easy assembly using FastConnect cables 4 x 2 on IE FC RJ 45 Modular Outlet or IE FC RJ45 Plug 4 x 2 or IE FC M12 Plug PRO 4x2 (X-coded)
- Simple and error-free construction of an 8-core cabling system with Gigabit capability
- Due to the 8-core cabling, you can either implement two Industrial Ethernet connections for Fast Ethernet (with IE FC RJ 45 Modular Outlet) or one Gigabit Ethernet
- Noise-immune network due to a consistent grounding concept.

### Application

The 8-core cabling system of SIMATIC NET allows transmission rates of 10/100/1 000 Mbit/s for Ethernet as with the service-independent cabling from the office environment. This permits the transition from the 4-core Industrial Ethernet cabling system to the 8-core cabling system with Gigabit capability.

The IE FC TP Standard Cable GP 4 x 2 (AWG22) must be used in conjunction with the IE FC Modular Outlet and the TP Cords for constructing Industrial Ethernet networks (8-core) up to 100 m.

#### IE FC TP Standard Cable 4x2 (AWG22)

The IE FC TP Standard Cable GP 4 x 2 (AWG22) must be used in conjunction with the IE FC Modular Outlet and the TP Cords for constructing Industrial Ethernet networks (8-core) up to 100 m.

#### IE FC TP Cable 4x2 (AWG24)

For direct connection without using patch technology, the IE FC RJ45 Plug 4 x 2 and the IE FC TP Cable 4 x 2 (AWG24) of up to 90 m can be used.

#### IE TP Train Cable 4x2 (AWG24)

For the construction of Industrial Ethernet networks (8-core) up to 100 m in railway applications (cable is approved for railway applications)

#### Note:

Further information on the network configuration can be found in the manual for TP and fiber-optic networks.

#### UL approvals

The IE FC TP cable GP 4 x 2 (AWG22 and AWG24) has the relevant UL / ETL approvals for laying in cable bundles and cable racks according to the specifications of NEC (National Electrical Code) Article 800/725.

### Design

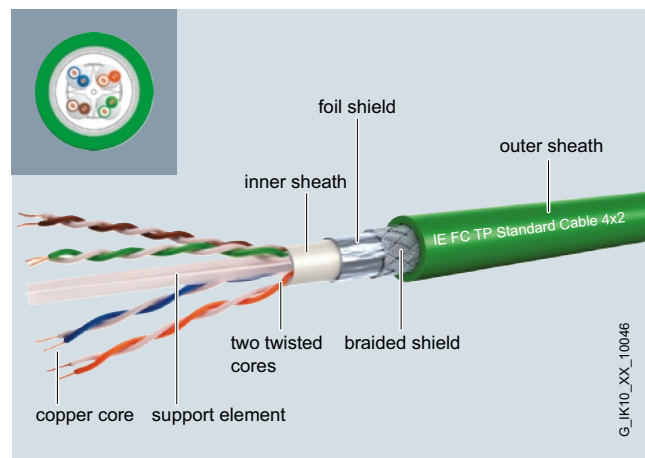

The FastConnect (FC) Industrial Ethernet cables IE FC Cable 4 x 2 (AWG22 and AWG24) are designed with radial symmetry and therefore allow the use of the IE FC Stripping Tool. The IE FC RJ45 Modular Outlet and the IE FC RJ45 Plug 4 x 2 can then be connected quickly and easily by means of insulation displacement contacts without the need for special tools.

## PROFINET/Industrial Ethernet

### Cabling technology

#### IE FC TP Cable 4 x 2

#### Design (continued)

##### Cable types

- IE FC Standard Cable GP 4 x 2 (AWG22):**  
 Standard bus cable with rigid cores specially designed for fast mounting on IE FC RJ45 Modular Outlet; with appropriate UL approval (General Purpose) for laying in cable bundles and on cable racks, according to the specifications of the NEC (National Electrical Code) Article 800/725
- IE FC Standard Cable GP 4 x 2 (AWG24):**  
 Standard bus cable with rigid cores specially designed for fast mounting on IE FC RJ45 Plug 4 x 2; with appropriate UL approval (General Purpose) for laying in cable bundles and on cable racks, according to the specifications of the NEC (National Electrical Code) Article 800/725
- IE FC Flexible Cable GP 4 x 2 (AWG24/7):**  
 Bus cable with flexible cores for occasional movement and specially designed for fast mounting on IE FC RJ45 Plug 4 x 2; with appropriate UL approval (General Purpose) for laying in cable bundles and on cable racks, according to the specifications of the NEC (National Electrical Code) Article 800/725
- IE Train Cable GP 4 x 2 (AWG24/7):**  
 Bus cable with flexible cores for laying in trains (railway applications) with appropriate approval, connection only possible via IE FC M12 Plug PRO 4x2 (x-coded)

#### Integration

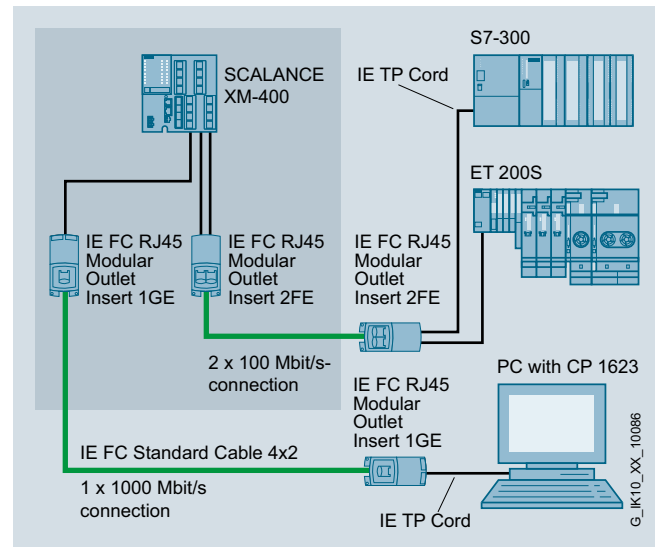

System configuration with IE FC RJ45 Modular Outlet 100 Mbit/s and 1000 Mbit/s

**Technical specifications**

Article No.	6XV1870-2E	6XV1878-2A
Product-type designation	IE FC TP Standard Cable GP 4x2 (AWG 22)	IE FC TP Standard Cable GP 4x2 (AWG 24)
Product description	Standard bus cable (8-core), sold by the meter, not assembled	Shielded TP installation cable (8-core), sold by the meter, not assembled
Acceptability for application	Standard cable with rigid cores for fast, permanent installation	Standard cable with rigid cores for fast, permanent installation
Cable designation	2YH (ST) C 4X2X0.64/1.25-100 GN 4x2xAWG22	2YH (ST) CY 4x2x0,5/1,0- 100 GN
<b>Electrical data</b>		
Damping ratio per length		
• at 10 MHz	60 dB/km	63 dB/km
• at 100 MHz	190 dB/km	210 dB/km
• at 250 MHz	330 dB/km	350 dB/km
Near-end crosstalk per length at 1 MHz ... 250 MHz	383 dB/km	383 dB/km
Transfer impedance at 10 MHz	10 mΩ/m	20 mΩ/m
Loop resistance per length	118 Ω/km	180 Ω/km
Insulation resistance coefficient	5 000 GΩ·m	5 000 GΩ·m
Operating voltage RMS value	100 V	100 V
Percentage NVP value	68 %	66 %
<b>Mechanical data</b>		
Number of electrical wires	8	8
Design of shield	Overlapped aluminum-clad foil, sheathed in a braided screen of tin-plated copper wires	Overlapped aluminum-clad foil, sheathed in a braided screen of tin-plated copper wires
Design of the electrical connection FastConnect	Yes	Yes
AWG number	-	-
Core diameter		
• of the AWG22 core	0.64 mm	-
• of the AWG24 core	-	0.51 mm
Outer diameter		
• of the inner conductor	0.64 mm	0.51 mm
• of the wire insulation	1.25 mm	1 mm
• of the inner sheath of the cable	7.6 mm	5.8 mm
• of the cable sheath	9.6 mm	8 mm
Symmetrical tolerance of outer diameter of cable sheath	0.3 mm	0.2 mm
Material		
• of the wire insulation	PE	PE
• of the inner sheath of the cable	PVC	FRNC
• of the cable sheath	PVC	PVC
Color		
• of the insulation of data wires	white/blue, white/orange, white/green, white/brown	white-blue/blue, white-orange/orange, white-green/green, white-brown/brown
• of the cable sheath	green	green
Bending radius		
• with single bend minimum permissible	38 mm	24 mm
• with multiple bends minimum permissible	80 mm	40 mm
Traction stress maximum	180 N	100 N
Weight per length	104 kg/km	78 kg/km

## PROFINET/Industrial Ethernet

### Cabling technology

#### IE FC TP Cable 4 x 2

#### Technical specifications (continued)

Article No.	6XV1870-2E	6XV1878-2A
Product-type designation	IE FC TP Standard Cable GP 4x2 (AWG 22)	IE FC TP Standard Cable GP 4x2 (AWG 24)
<b>Permitted ambient conditions</b>		
Ambient temperature		
• during operating	-40 ... +80 °C	-40 ... +85 °C
• during storage	-40 ... +80 °C	-40 ... +85 °C
• during transport	-40 ... +80 °C	-40 ... +85 °C
• during installation	-40 ... +80 °C	-40 ... +80 °C
Burning behaviour	flame resistant according to IEC 60332-1	flame resistant according to IEC 60332-3-24 (Category C)
Chemical resistance		
• to mineral oil	oil resistant according to IEC 60811-2-1 (4 h / 70°C)	oil resistant according to IEC 60811-2-1 (4 h / 70°C)
• to grease	Conditional resistance	Conditional resistance
• to water	Conditional resistance	Conditional resistance
Radiological resistance to UV radiation	Resistant	Resistant
<b>Product properties, functions, components general</b>		
Product feature		
• halogen-free	No	No
• silicon-free	Yes	Yes
Cable length		
• with 100BaseTX for Industrial Ethernet	90 m	100 m
• with 1000BaseT for Industrial Ethernet	90 m	100 m
<b>Standards, specifications, approvals</b>		
UL/ETL listing with 300 V rating	Yes: c(UL)us, CMG, Sun Res	Yes: c(UL)us, CMG
UL/ETL style with 600 V rating	No	No
Verification of suitability		
• CE mark	Yes	Yes
• RoHS conformity	Yes	Yes
Standard for structured cabling	Cat6	Cat6

**Technical specifications** (continued)

Article No.	6XV1878-2B	6XV1878-2T
Product-type designation	IE FC TP Flexible Cable GP 4x2 (AWG 24)	IE TP Train Cable 4x2 (AWG24/7)
Product description	Bus cable (8-core) with flexible cores, sold by the meter, not assembled	Flexible bus cable with tin-coated stranded wires (8-core), for applications in trains, sold by the meter, not assembled
Acceptability for application	Flexible cable for quick assembly, for occasionally moving machine parts	For laying in rail vehicles and buses
Cable designation	LI02YSH (ST) CY 4x2x0,22/1,1- 100 GN	-
<b>Electrical data</b>		
Damping ratio per length		
• at 10 MHz	90 dB/km	63 dB/km
• at 100 MHz	299 dB/km	207 dB/km
• at 250 MHz	495 dB/km	343 dB/km
Near-end crosstalk per length at 1 MHz ... 250 MHz	383 dB/km	-
Transfer impedance at 10 MHz	20 mΩ/m	5 mΩ/m
Loop resistance per length	180 Ω/km	124 Ω/km
Insulation resistance coefficient	5 000 GΩ·m	5 000 GΩ·m
Operating voltage RMS value	100 V	125 V
percentage NVP value	70 %	-
<b>Mechanical data</b>		
Number of electrical wires	8	8
Design of shield	Overlapped aluminum-clad foil, sheathed in a braided screen of tin-plated copper wires	Overlapped aluminum-clad foil, sheathed in a protective braided shield of tin-plated copper wires with additional pair shielding
Design of the electrical connection FastConnect	Yes	No
Core diameter		
• of the AWG24 core	0.51 mm	0.51 mm
Outer diameter		
• of the inner conductor	0.6 mm	-
• of the wire insulation	1.1 mm	0.15 mm
• of the inner sheath of the cable	6.1 mm	-
• of the cable sheath	8 mm	8.8 mm
Symmetrical tolerance of outer diameter of cable sheath	0.2 mm	0.2 mm
Material		
• of the wire insulation	PE	PE
• of the inner sheath of the cable	FRNC	-
• of the cable sheath	PVC	Elastomer meshed electron beam
Color		
• of the insulation of data wires	white-blue/blue, white-orange/orange, white-green/green, white-brown/brown	white/blue, white/green, white/brown, white/orange
• of the cable sheath	green	Black
Bending radius		
• with single bend	24 mm	53 mm
• with multiple bends	40 mm	53 mm
Traction stress maximum	100 N	100 N
Weight per length	72 kg/km	79 kg/km

## PROFINET/Industrial Ethernet

### Cabling technology

#### IE FC TP Cable 4 x 2

#### Technical specifications (continued)

Article No.	6XV1878-2B	6XV1878-2T
Product-type designation	IE FC TP Flexible Cable GP 4x2 (AWG 24)	IE TP Train Cable 4x2 (AWG24/7)
<b>Permitted ambient conditions</b>		
Ambient temperature		
• during operating	-40 ... +80 °C	-40 ... +80 °C
• during storage	-40 ... +80 °C	-40 ... +80 °C
• during transport	-40 ... +80 °C	-40 ... +80 °C
• during installation	-40 ... +80 °C	-20 ... +60 °C
Ambient condition for (standard) operation mode	Temperature range for permanent installation -40 °C to +85 °C	-
Burning behaviour	flame resistant according to IEC 60332-3-24 (Category C)	BS 6853, DIN5510-2 levels of protection 1-4, prEN 45545-2 Hazard Level HL 1-HL 3, EN 50306-4, NF F 16-101, NFPA130
Chemical resistance		
• to mineral oil	oil resistant according to IEC 60811-2-1 (4 h / 70°C)	EN 50306-4 (72h/100 °C, IRM 902, 168h/70 °C, IRM 903)
• to grease	Conditional resistance	Conditional resistance
• to water	Conditional resistance	Conditional resistance
Radiological resistance to UV radiation	Resistant	Resistant
<b>Product properties, functions, components general</b>		
Product feature		
• halogen-free	No	Yes
• silicon-free	Yes	Yes
Cable length		
• with 100BaseTX for Industrial Ethernet	80 m	100 m
• with 1000BaseT for Industrial Ethernet	80 m	100 m
<b>Standards, specifications, approvals</b>		
UL/ETL listing with 300 V rating	Yes: c(ETL)us, CMG	No
UL/ETL style with 600 V rating	No	No
Verification of suitability		
• CE mark	Yes	Yes
• RoHS conformity	Yes	Yes
Standard for structured cabling	Cat6	Cat7



Ordering data	Article No.	Article No.	
<b>IE FC TP Standard Cable GP 4 x 2</b> 8-core, shielded TP installation cable for universal applications; with UL approval; sold by the meter; max. length 1 000 m, minimum order 20 m <ul style="list-style-type: none"> <li>• AWG22, for connection to IE FC RJ45 Modular Outlet</li> <li>• AWG24, for connection to IE FC RJ45 Plug 4 x 2, IE FC M12 Plug PRO 4 x 2</li> </ul>	<b>6XV1870-2E</b>  <b>6XV1878-2A</b>	<b>IE FC RJ45 Modular Outlet</b> FastConnect RJ45 Outlet for Industrial Ethernet with interface for a replaceable insert; <ul style="list-style-type: none"> <li>• <b>without replaceable insert</b></li> <li>• <b>With 2FE insert;</b> replaceable insert for 2 x 100 Mbit/s interfaces</li> <li>• <b>With 1GE insert;</b> replaceable insert for 1 x 1 000 Mbit/s interfaces</li> <li>• <b>With power insert;</b> replaceable insert for 1 x 24 V DC and 1 x 100 Mbit/s interface</li> </ul>	<b>6GK1901-1BE00-0AA0</b> <b>6GK1901-1BE00-0AA1</b>  <b>6GK1901-1BE00-0AA2</b>  <b>6GK1901-1BE00-0AA3</b>
<b>IE FC TP Flexible Cable GP 4 x 2</b> 8-core, shielded TP installation cable for occasional movement; with UL approval; sold by the meter; max. length 1 000 m, minimum order 20 m <ul style="list-style-type: none"> <li>• AWG24, for connection to IE FC RJ45 Plug 4 x 2, IE FC M12 Plug PRO 4 x 2</li> </ul>	<b>6XV1878-2B</b>	<b>IE FC RJ45 Modular Outlet Insert 2FE</b> Replaceable insert for FC Modular Outlet Base; 2 x RJ45 for 2 x 100 Mbit/s interfaces; 1 pack = 4 items	<b>6GK1901-1BK00-0AA1</b>
<b>IE TP Train Cable GP 4 x 2</b> 8-core, shielded TP installation cable for use in trains; sold by the meter; max. length 1 000 m, minimum order 20 m <ul style="list-style-type: none"> <li>• AWG24, for connection to IE M12 RJ45 Plug PRO 4 x 2</li> </ul>	<b>6XV1878-2T</b>	<b>IE FC RJ45 Modular Outlet Insert 1GE</b> Replaceable insert for FC Modular Outlet Base; 1 x RJ45 for 1 x 1000 Mbit/s interface; 1 pack = 4 items	<b>6GK1901-1BK00-0AA2</b>
<b>IE FC stripping tool</b> Preadjusted stripping tool for fast stripping of Industrial Ethernet FC cables 4 x 2	<b>6GK1901-1GA00</b>	<b>IE FC RJ45 Plug 4 x 2</b> RJ45 plug connector for Industrial Ethernet with a rugged metal housing and integrated insulation displacement contacts for connecting Industrial Ethernet FC installation cables 4 x 2; 180° cable outlet; for network components and CPs/CPU's with Industrial Ethernet interface <ul style="list-style-type: none"> <li>• 1 pack = 1 unit</li> <li>• 1 pack = 10 units</li> <li>• 1 pack = 50 units</li> </ul>	<b>6GK1901-1BB11-2AA0</b> <b>6GK1901-1BB11-2AB0</b> <b>6GK1901-1BB11-2AE0</b>
<b>IE FC Blade Cassettes (5 mm)</b> Replacement blade cassette for the Industrial Ethernet stripping tool, for use with IE FC RJ45 Plugs and IE FC RJ45 Modular Outlet, 5 units	<b>6GK1901-1GB01</b>	<b>IE FC M12 Plug PRO 4 x 2</b> M12 plug-in connector suitable for on-site assembly (X-coded, IP65/IP67), metal enclosure, insulation/displacement fast connection method, for SCALANCE W <ul style="list-style-type: none"> <li>• 1 unit</li> <li>• 8 units</li> </ul>	<b>6GK1901-0DB30-6AA0</b> <b>6GK1901-0DB30-6AA8</b>
		<b>SIMATIC NET Manual Collection</b> Electronic manuals for communication systems, communication protocols, and communication products; on DVD; German/English	<b>6GK1975-1AA00-3AA0</b>

## More information

### Installation instructions

The bus cable is supplied by the meter with meter marks printed on it.

#### FastConnect

With the help of Industrial Ethernet FastConnect Stripping Tool, it is possible to strip the outer sheath and shield of the Industrial Ethernet FastConnect cable 4 x 2 to the right length in one step. This allows the IE FC RJ45 Modular Outlet to be attached quickly and easily to the Industrial Ethernet FC cable 4 x 2.

### Cable routing

During storage, transport and cable laying, keep both ends sealed with a shrink-on cap; comply with the permissible bending radii and tensile load.

## PROFINET/Industrial Ethernet

### Cabling technology

#### Energy cables

##### Overview

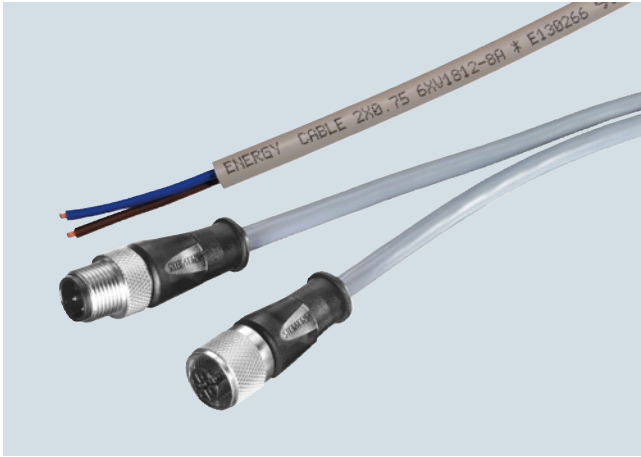

- Different versions (5-core, 2-core) for different fields of application
- Pre-assembled M12 plug-in cables for energy transfer
- Rugged cable design for installation in industrial applications
- UL approvals
- Easy length measurement thanks to printed meter markings

##### Benefits



- Flexible application possibilities thanks to rugged cable design
- Silicon-free, therefore particularly suitable for use in the automotive industry (e.g. on paint shop conveyors)

##### Application

Different cable types are needed to supply power to Industrial Ethernet/PROFINET or PROFIBUS. The listed power cables should always be used. They are used for devices with IP65/67 degree of protection to connect the signaling contact or 24-V supply of the SCALANCE X and SCALANCE W components (power cable 2x0.75) and for the power supply (power cable 5x1.5 for ET 200).

In addition, preassembled power connecting cables (4 x 0.75) are available in different lengths for the power supply of the ET 200 (M12 Power Connecting Cable).

##### UL approvals

As a result of appropriate UL styles, the cables can be used worldwide.

##### Design

Rugged 2-core, 4-core or 5-core cable with circular cross-section for connection of signaling contact and power supply to IP65/67 components in industrial areas.

##### Cable types

The following cables with industrial capability are available for connection of the power supply and signaling contact:

- Power cable 2 x 0.75; power cable for connection of signaling contact and 24 V supply voltage to SCALANCE X and SCALANCE W components
- Power cable 5 x 1.5; power cable for connection of 24 V power supply of ET 200 using 7/8" plug connectors
- M12 Power Connecting Cable M12-180/M12-180; 4-core M12 power connecting cables (A-coded) with straight cable outlet for 24 V power supply of the ET 200 (pre-assembled)

**Technical specifications**

Article No.	6XV1812-8A	6XV1830-8AH10
Product-type designation	Energy Cable 2 x 0.75	Energy Cable 5 x 1.5
Product description	Energy cable (2-core), sold by the meter, not assembled	Energy cable (5-core), sold by the meter, not assembled
Acceptability for application	Connection of signaling contact and 24 V power supply to SCALANCE X and SCALANCE W	Power supply of ET 200 modules with 7/8" power port
Cable designation	L-YY-2x1x0.75 GR	L-Y11Y-Z 5x1x1.5 GR
<b>Electrical data</b>		
Operating voltage RMS value	600 V	600 V
Conductor cross section of the power wires	0.75 mm <sup>2</sup>	1.5 mm <sup>2</sup>
Continuous current of the power wires	6 A	16 A
<b>Mechanical data</b>		
Number of electrical wires	2	5
Design of the electrical connection FastConnect	-	No
Outer diameter		
• of the inner conductor	1.3 mm	1.55 mm
• of the wire insulation	2.5 mm	2.73 mm
• of the cable sheath	7.4 mm	10.5 mm
Material		
• of the wire insulation	PVC	PVC
• of the cable sheath	PVC	PUR
Symmetrical tolerance of outer diameter of cable sheath	0.3 mm	0.3 mm
Color		
• of the power wire insulation	Brown/blue	4x black, 1x green / yellow
• of the cable sheath	gray	gray
Bending radius		
• with single bend	19 mm	27 mm
• with multiple bends	45 mm	63 mm
• with continuous bending	-	75 mm
Number of bending cycles	-	5 000 000
• Note	-	For use in cable carriers, for 5 million bending cycles with a bending radius of 75 mm, an acceleration of 4 m/s <sup>2</sup> and a speed of 180 m/min
Traction stress maximum	100 N	500 N
Weight per length	70 kg/km	149 kg/km
<b>Permitted ambient conditions</b>		
Ambient temperature		
• during operating	-20 ... +80 °C	-40 ... +80 °C
• during storage	-20 ... +80 °C	-40 ... +80 °C
• during transport	-20 ... +80 °C	-40 ... +80 °C
• during installation	-20 ... +80 °C	-40 ... +80 °C
Burning behaviour	Flame retardant acc. to IEC 60332-1	Flame retardant acc. to IEC 60332-1
Chemical resistance		
• to mineral oil	Conditional resistance	Resistant
• to grease	Conditional resistance	Resistant
• to water	Conditional resistance	Conditional resistance
Radiological resistance to UV radiation	Resistant	Resistant
<b>Product properties, functions, components general</b>		
Product feature		
• halogen-free	No	No
• silicon-free	Yes	Yes
<b>Standards, specifications, approvals</b>		
UL/ETL listing with 300 V rating	Yes: CL3	No
UL/ETL style with 600 V rating	Yes	Yes
Verification of suitability		
• CE mark	Yes	Yes
• RoHS conformity	Yes	Yes

# PROFINET/Industrial Ethernet

## Cabling technology

### Energy cables

#### Technical specifications (continued)

Article No.	6XV1801-5DH10	Article No.	6XV1801-5DH10
Product-type designation	POWER CONNECTING CABLE M12-180/M12-180	Product-type designation	POWER CONNECTING CABLE M12-180/M12-180
Product description	Flexible power connecting cable (4-core), preferred length, assembled with A-coded 5-pin M12 connector and A-coded, 5-pin M12 socket	<b>Permitted ambient conditions</b>	
Acceptability for application	Cable for connecting the 24 V power supply to ET 200eco PN to IP 65/67 degree of protection	Ambient temperature	
Cable designation	LI9YH-Y 4x0,75	• during operating	-25 ... +80 °C
Cable length	1 m	• during storage	-25 ... +80 °C
<b>Electrical data</b>		• during transport	-25 ... +80 °C
Operating voltage RMS value	300 V	• during installation	-5 ... +80 °C
Conductor cross section of the power wires	0.75 mm <sup>2</sup>	• Comment	With moving applications, the permissible operating temperature range is -5 to +80 degrees Celsius
Continuous current of the power wires	-	Ambient condition for (standard) operation mode	-
<b>Mechanical data</b>		Protection class IP	IP65/67
Number of electrical wires	4	Burning behaviour	Flame resistant acc. to UL 758 (CSA FT 1)
Outer diameter		Chemical resistance	
• of the inner conductor	1.1 mm	• to mineral oil	Conditional resistance
• of the wire insulation	1.7 mm	• to grease	Conditional resistance
• of the cable sheath	5.7 mm	• to water	Conditional resistance
Outer diameter of the cable sheath	-	Radiological resistance to UV radiation	Not resistant
Note		<b>Product properties, functions, components general</b>	
Symmetrical tolerance of outer diameter of cable sheath	0.2 mm	Product feature	
Material		• halogen-free	No
• of the wire insulation	PP	• silicon-free	Yes
• of the cable sheath	PVC	<b>Standards, specifications, approvals</b>	
- Note	-	Verification of suitability	
Color		• UL-registration	Yes
• of the power wire insulation	Brown / white / blue / black	• RoHS conformity	Yes
• of the cable sheath	gray		
Bending radius			
• with single bend minimum permissible	57 mm		
• with multiple bends minimum permissible	57 mm		
Traction stress maximum	15 N		
Weight per length	54 kg/km		

**Technical specifications** (continued)

Article No.	6GK1905-0FA00	6GK1905-0FB00	6GK1905-0FC00
Product-type designation	7/8-inch connector	7/8-inch connector	7/8-inch Power T-Tap PRO
Product description	7/8" plug-in connector with pin insert, 5-pole	7/8" plug-in connector with socket insert, 5-pole	Power T-piece with two 7/8" socket inserts and one 7/8" pin insert, 5-pole both
Acceptability for application	For field assembly with ET 200	For field assembly with ET 200	For power connection and distribution to ET 200pro modules
<b>Interfaces</b>			
Number of electrical connections for network components and terminal equipment	1	1	3
Design of electrical connection for network components and terminal equipment	7/8 inch plug (male insert)	7/8 inch plug (female insert)	7/8 inch plug (2 x female insert, 1 x male insert)
<b>Mechanical data</b>			
Material of the enclosure	metal	metal	metal
<b>Design, dimensions and weight</b>			
Type of cable outlet	180 degree cable outlet	180 degree cable outlet	-
Width	27 mm	27 mm	58.5 mm
Height	27 mm	27 mm	73.5 mm
Depth	83 mm	83 mm	26.5 mm
Net weight	50 g	50 g	112 g
<b>Permitted ambient conditions</b>			
Ambient temperature			
• during operating	-40 ... +70 °C	-40 ... +70 °C	-40 ... +70 °C
• during storage	-40 ... +80 °C	-40 ... +80 °C	-40 ... +80 °C
• during transport	-40 ... +80 °C	-40 ... +80 °C	-40 ... +80 °C
Protection class IP	IP65/67	IP65/67	IP65/67
Chemical resistance to water	resistant	resistant	resistant
<b>Product properties, functions, components general</b>			
Product feature silicon-free	Yes	Yes	Yes
Product component strain relief	Yes	Yes	Yes
<b>Standards, specifications, approvals</b>			
Verification of suitability RoHS conformity	Yes	Yes	Yes

## PROFINET/Industrial Ethernet

### Cabling technology

#### Energy cables

#### Technical specifications (continued)

Article No.	6GK1908-0DC10-6AA3	6GK1907-0DC10-6AA3	6GK1907-0DB10-6AA3
Product-type designation	Signaling Contact M12 Cable Connector	Power M12 Cable Connector PRO	Power M12 Plug PRO
Product description	M12 connection socket for signaling contact; 5-pole, B-coded	M12 connection socket; 4-pole, A-coded	M12 power plug, 4-pole, A-coded
Acceptability for application	For connection to SCALANCE X208PRO for signaling contact	For connection to SCALANCE W-700 / X208PRO for 24 V DC voltage supply	For connection to PS791-1PRO power supply for 24 V DC voltage supply
<b>Interfaces</b>			
Number of electrical connections for network components and terminal equipment	1	1	1
Design of electrical connection for network components and terminal equipment	M12 connector (B-coded, 5-pin)	M12 connector (female insert, A-coded, 4-pin)	M12 connector (male insert, A-coded, 4-pin)
<b>Mechanical data</b>			
Material of the enclosure	plastic	plastic	plastic
<b>Design, dimensions and weight</b>			
Type of cable outlet	180 degree cable outlet	180 degree cable outlet	180 degree cable outlet
Width	14 mm	19 mm	19 mm
Height	14 mm	19 mm	19 mm
Depth	59 mm	73 mm	73 mm
Net weight	37 g	40 g	40 g
<b>Permitted ambient conditions</b>			
Ambient temperature			
• during operating	-40 ... +70 °C	-40 ... +70 °C	-40 ... +70 °C
• during storage	-40 ... +80 °C	-40 ... +80 °C	-40 ... +80 °C
• during transport	-40 ... +80 °C	-40 ... +80 °C	-40 ... +80 °C
Relative humidity at 25 °C without condensation during operating maximum	-	-	-
Protection class IP	IP65/67	IP65/67	IP65/67
Chemical resistance to water	resistant	resistant	resistant
<b>Product properties, functions, components general</b>			
Product feature silicon-free	Yes	Yes	Yes
Product component strain relief	Yes	Yes	Yes
<b>Standards, specifications, approvals</b>			
Verification of suitability RoHS conformity	Yes	Yes	Yes

Ordering data	Article No.	Article No.	
<b>Power cable 2 x 0.75</b> Power cable with trailing capability with 2 copper cores (0.75 mm <sup>2</sup> ) for connecting to M12 plug-in connector; <u>sold by the meter</u> ; max. 1 000 m, minimum order quantity 20 m	<b>6XV1812-8A</b>	<b>Additional components</b>  <b>7/8" plug-in connector</b> Plug with axial cable outlet for field assembly for ET 200, 5-core, plastic enclosure, 1 pack = 5 items <ul style="list-style-type: none"> <li>• Male pins</li> <li>• Socket insert</li> </ul> <b>7/8" Power T-Tap PRO</b> Power T-piece for ET 200 with two 7/8" socket inserts and one 7/8" pin insert 1 pack = 5 items	
<b>Power cable 5 x 1.5</b> Power cable with trailing capability with 5 copper cores (1.5 mm <sup>2</sup> ) for connecting to 7/8" plug-in connector; <u>sold by the meter</u> ; max. 1 000 m; minimum order quantity 20 m	<b>6XV1830-8AH10</b>		<b>6GK1905-0FA00</b> <b>6GK1905-0FB00</b>  <b>6GK1905-0FC00</b>
<b>M12 Power Connecting Cable M12-180/M12-180</b> Flexible 4-core power connecting cable, assembled with A-coded 5-pin M12 connector and A-coded, 5-pin M12 socket to supply the ET 200 with 24 V DC; length: <ul style="list-style-type: none"> <li>• 0.3 m</li> <li>• 0.5 m</li> <li>• 1.0 m</li> <li>• 1.5 m</li> <li>• 2.0 m</li> <li>• 3.0 m</li> <li>• 5.0 m</li> <li>• 10 m</li> <li>• 15 m</li> </ul>	<b>6XV1801-5DE30</b> <b>6XV1801-5DE50</b> <b>6XV1801-5DH10</b> <b>6XV1801-5DH15</b> <b>6XV1801-5DH20</b> <b>6XV1801-5DH30</b> <b>6XV1801-5DH50</b> <b>6XV1801-5DN10</b> <b>6XV1801-5DN15</b>		<b>6GK1908-0DC10-6AA3</b>  <b>6GK1907-0DC10-6AA3</b>  <b>6GK1907-0DB10-6AA3</b>  <b>6GK1975-1AA00-3AA0</b>
		<b>Signaling Contact M12 Cable Connector PRO</b> Socket for connection of SCALANCE X208PRO for signaling contact; 5-pole, B-coded, with assembly instructions; 3 items	
		<b>Power M12 Cable Connector PRO</b> Socket for connection of SCALANCE W-700 for 24 V DC supply voltage; 4-pole, A-coded, with assembly instructions, 3 items	
		<b>Power M12 Plug PRO</b> Plug for connection to PS791-1PRO power supply for 24 V DC supply voltage; 4-pole, A-coded, with assembly instructions, 3 items	
		<b>SIMATIC NET Manual Collection</b> Electronic manuals for communication systems, communication protocols, and communication products; on DVD, German/English	

**More information****Cable routing:**

During storage, transport and cable laying, keep both ends sealed with a shrink-on cap.

Comply with the permissible bending radii and tensile load!

**Note:**

You can order components supplementary to the SIMATIC NET cabling range from your local contact.

Technical advice on this subject is available from:

J. Hertlein  
 I IA SC CI PRM 4  
 Phone: +49 (911) 750-4465  
 E-mail: [juergen.hertlein@siemens.com](mailto:juergen.hertlein@siemens.com)

## PROFINET/Industrial Ethernet

### Cabling technology

#### IE TP Cord

##### Overview



- Patch cable, available as preassembled cables (max. length 10 m)
- With 2 x 2 cores for 10/100 Mbit/s and 4 x 2 cores for 10/100/1 000 Mbit/s Ethernet
- Small cable diameter
- Category Cat5e (2 x 2) and Cat6 (4 x 2) of the international cabling standards ISO/IEC 11801 and EN 50173

##### Benefits

get **Designed for Industry**

- Simple connection of terminals with an RJ45 interface to the interference-proof Industrial Ethernet FC cabling system (10/100/1 000 Mbit/s)
- Quick and error-free commissioning thanks to pre-assembled, factory-tested patch cables
- Simple cable laying due to small cable diameter
- Silicone-free, therefore suitable for use in the automotive industry (for example on paint lines)
- Color-coded RJ45 connectors for differentiation between twisted and non-twisted lines
  - Twisted: RJ45 connector red on both sides
  - Non-twisted: RJ45 connector green on both sides

##### Application

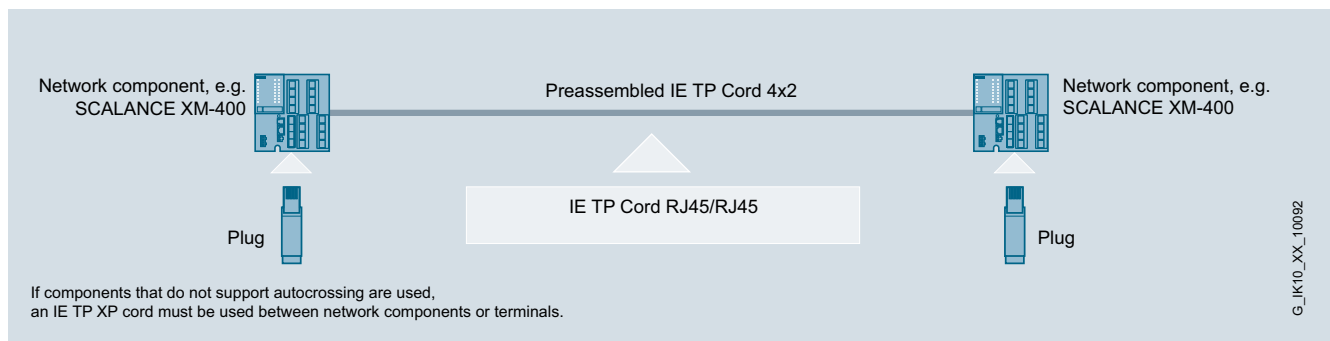

IE TP Cord RJ45/RJ45 can be used to directly connect individual components (10/100/1 000 Mbit/s)



### Design

- 2 x 2 cores for 10/100 Mbit/s transmission rate;  
4 x 2 cores for 10/100/1 000 Mbit/s transmission rate
- Two cores with two dummy elements twisted into a pair.
- Each pair is encased in plastic film and shielded with a plastic-clad aluminum foil
- Outer woven shield around all pairs comprising tinned copper wires
- Plastic sheath (PVC)

IE TP Cord is available as TP Cord 4 x 2, pre-assembled cables in the following versions:

- **IE TP Cord RJ45/RJ45**  
with 2 x RJ45 plugs
- **IE TP XP Cord RJ45/RJ45**  
with 2 x RJ45 plugs, send and receive cables are twisted.

IE TP Cord is available as TP Cord 2 x 2, pre-assembled cables in the following versions:

- **IE TP Cord 9/RJ45**  
with one 9-pole Sub-D connector and one RJ45 connector
- **IE TP XP Cord 9/RJ45**  
with one RJ45 connector and one 9-pole Sub-D connector, send and receive cable are twisted
- **IE TP Cord 9-45/RJ45**  
with one RJ45 connector and one 9-pole Sub-D connector, 45° cable outlet
- **IE TP XP Cord 9-45/RJ45**  
with one RJ45 connector and one 9-pole Sub-D connector, 45° cable outlet; send and receive cable are twisted
- **IE TP XP Cord 9/9**  
with two 9-pole Sub-D connectors, send and receive cable are twisted.
- **IE TP Cord RJ45/15**  
with one RJ45 connector and one 15-pole Sub-D connector; this is used to directly connect data terminals with ITP interfaces to network components with an RJ45 interface.
- **IE TP XP Cord RJ45/15**  
with one RJ45 connector and one 15-pole Sub-D connector, twisted send and receive cable; used for direct connection of a data terminal with 15-pole Sub-D connector to a data terminal with RJ45 plug.
- **IE TP Converter Cord 15/RJ45**  
with a 15-pole Sub-D socket with slide locking and an RJ45 plug. A retaining clip clamps it in place.  
IE TP Converter Cord 15/RJ45 2 x 2 is used to connect data terminals with an RJ45 interface to the ITP cabling system, e.g. over the ITP Standard 9/15 cable.

### Function

The flexibility of the cable ensures easy installation, for example in a control cabinet, or to connect equipment in a control room. The maximum length of an IE TP Cord is 10 m.

Adapter cables are used to connect devices with a 9-pin ITP interface to devices with an RJ45 interface.

The IE TP Converter Cord 15/RJ45 is used to connect devices with a 15-pin ITP interface to devices with an RJ45 interface.

# PROFINET/Industrial Ethernet

## Cabling technology

### IE TP Cord

#### Technical specifications

Article No.	6XV1870-3QH10	6XV1850-2JH10
Product-type designation	IE TP Cord RJ45/RJ45, 4x2	IE TP Cord 9/RJ45, 2x2
Product description	Patch cable, preferred length, preassembled with two RJ45 connectors	Patch cable, preferred length, preassembled with one 9-pole Sub-D connector and one RJ45 connector
Acceptability for application	Easy connection of data terminals to the IE FC cabling system	Easy connection of data terminals to the IE FC cabling system
Cable designation	LI 02YSCH 4x2x0,15 PIMF GN FRNC	LI 02YSCY 2x2x0,15/0,98 PIMF ICCS GN
Cable length	1 m	1 m
<b>Electrical data</b>		
Damping ratio per length		
• at 10 MHz maximum	86 dB/km	85 dB/km
• at 100 MHz maximum	28 dB/km	278 dB/km
• at 300 MHz maximum	501 dB/km	5 dB/km
• at 600 MHz maximum	735 dB/km	733 dB/km
Impedance		
• for frequency range 1 MHz ... 100 MHz	100 Ω	100 Ω
• for frequency range 10 MHz ... 600 MHz	100 Ω	100 Ω
Relative symmetrical tolerance		
• of the surge impedance at 1 MHz ... 100 MHz	15 %	15 %
• of the surge impedance at 10 MHz ... 600 MHz	10 %	6 %
Transfer impedance at 10 MHz	10 mΩ/m	10 mΩ/m
Loop resistance per length maximum	290 Ω/km	300 Ω/km
Insulation resistance coefficient	500 GΩ·m	500 GΩ·m
<b>Mechanical data</b>		
Number of electrical wires	8	4
Design of shield	Overlapped aluminum-clad foil, sheathed in a braided screen of tin-plated copper wires	Overlapped aluminum-clad foil, sheathed in a braided screen of tin-plated copper wires
AWG number	-	-
Core diameter		
• of AWG26 core	0.5 mm	0.48 mm
Outer diameter		
• of the inner conductor	0.5 mm	0.48 mm
• of the wire insulation	1 mm	0.98 mm
• of the cable sheath	6.2 mm	-
Symmetrical tolerance of outer diameter of cable sheath	0.3 mm	-
Width of the cable sheath	-	5.8 mm
Symmetrical tolerance of width of cable sheath	-	0.2 mm
Thickness of the cable sheath	-	3.7 mm
Symmetrical tolerance of thickness of cable sheath	-	0.2 mm

**Technical specifications** (continued)

Article No.	6XV1870-3QH10	6XV1850-2JH10
Product-type designation	IE TP Cord RJ45/RJ45, 4x2	IE TP Cord 9/RJ45, 2x2
Material		
• of the wire insulation	PE	PE
• of the cable sheath	FRNC	PVC
Color		
• of the insulation of data wires	white/blue, white/orange, white/green, white/brown	white/blue, white/orange
• of the cable sheath	green	green
Bending radius		
• with single bend minimum permissible	31 mm	24 mm
• with multiple bends minimum permissible	43.5 mm	42 mm
Weight per length	50 kg/km	32 kg/km
<b>Permitted ambient conditions</b>		
Ambient temperature		
• during operating	-25 ... +80 °C	-40 ... +70 °C
• during storage	-25 ... +80 °C	-40 ... +70 °C
• during transport	-25 ... +80 °C	-40 ... +70 °C
• during installation	-25 ... +80 °C	-40 ... +70 °C
Protection class IP	IP20	IP20
Burning behaviour	flame resistant according to IEC 60332-1	flame resistant according to IEC 60332-1
Chemical resistance		
• to mineral oil	oil resistant according to IEC 60811-2-1 (4 h / 70°C)	oil resistant according to IEC 60811-2-1 (4 h / 70°C)
• to grease	Conditional resistance	Conditional resistance
<b>Product properties, functions, components general</b>		
Product feature		
• halogen-free	Yes	No
• silicon-free	Yes	Yes
<b>Standards, specifications, approvals</b>		
UL/ETL listing with 300 V rating	No	No
UL/ETL style with 600 V rating	No	No
Verification of suitability		
• UL-registration	Yes	Yes

# PROFINET/Industrial Ethernet

## Cabling technology

### IE TP Cord

#### Ordering data

##### IE TP Cord RJ45/RJ45

TP cable 4 x 2  
with 2 RJ45 plugs

- 0.5 m
- 1 m
- 2 m
- 6 m
- 10 m

#### Article No.

**6XV1870-3QE50**  
**6XV1870-3QH10**  
**6XV1870-3QH20**  
**6XV1870-3QH60**  
**6XV1870-3QN10**

##### IE TP XP Cord RJ45/RJ45

Twisted TP cable 4 x 2  
with 2 RJ45 plugs

- 0.5 m
- 1 m
- 2 m
- 6 m
- 10 m

**6XV1870-3RE50**  
**6XV1870-3RH10**  
**6XV1870-3RH20**  
**6XV1870-3RH60**  
**6XV1870-3RN10**

##### IE TP Cord 9/RJ45

TP cable 2 x 2  
with one 9-pole sub D connector  
and one RJ45 connector

- 0.5 m
- 1 m
- 2 m
- 6 m
- 10 m

**6XV1850-2JE50**  
**6XV1850-2JH10**  
**6XV1850-2JH20**  
**6XV1850-2JH60**  
**6XV1850-2JN10**

##### IE TP XP Cord 9/RJ45

Twisted TP cable 2 x 2  
with one 9-pole sub D connector  
and one RJ45 connector

- 0.5 m
- 1 m
- 2 m
- 6 m
- 10 m

**6XV1850-2ME50**  
**6XV1850-2MH10**  
**6XV1850-2MH20**  
**6XV1850-2MH60**  
**6XV1850-2MN10**

##### IE TP Cord 9-45/RJ45

TP cable 2 x 2  
with one RJ45 connector and one  
Sub D connector with 45° cable  
outlet (not for OSM/ESM)

- 1 m

**6XV1850-2NH10**

##### IE TP XP Cord 9-45/RJ45

Twisted TP cable 2 x 2  
with one RJ45 connector and one  
Sub D connector with 45° cable  
outlet (not for OSM/ESM)

- 1 m

**6XV1850-2PH10**

##### IE TP XP Cord 9/9

Twisted TP cable 2 x 2 for direct  
connection of two Industrial  
Ethernet components with an  
ITP interface with two 9-pole  
Sub D connectors

- 1 m

**6XV1850-2RH10**

##### IE TP Cord RJ45/15

TP cable 2 x 2  
with one 15-pole Sub D connector  
and one RJ45 connector

- 0.5 m
- 1 m
- 2 m
- 6 m
- 10 m

**6XV1850-2LE50**  
**6XV1850-2LH10**  
**6XV1850-2LH20**  
**6XV1850-2LH60**  
**6XV1850-2LN10**

##### IE TP XP Cord RJ45/15

Crossed TP cable 2 x 2  
with one 15-pole sub D connector  
and one RJ45 connector

- 0.5 m
- 1 m
- 2 m
- 6 m
- 10 m

**6XV1850-2SE50**  
**6XV1850-2SH10**  
**6XV1850-2SH20**  
**6XV1850-2SH60**  
**6XV1850-2SN10**

##### IE TP Converter Cord 15/RJ45

TP connecting cable 2 x 2  
for connecting data terminals  
with RJ45 interfaces to the ITP  
cabling system;  
with a 15-pole Sub D socket  
with slide locking and an  
RJ45 connector.

- 0.5 m
- 2 m

**6XV1850-2EE50**  
**6XV1850-2EH20**

##### IE FC Outlet RJ45

For connection Industrial Ethernet  
FC cables and TP Cords;  
graded prices from 10 and 50 units

**6GK1901-1FC00-0AA0**

##### IE FC RJ45 Modular Outlet

FastConnect RJ45 Outlet  
for Industrial Ethernet with interface  
for a replaceable insert;

- **With 2FE insert** ;  
replaceable insert for  
2 x 100 Mbit/s interfaces
- **With 1GE insert**;  
replaceable insert for  
1 x 1 000 Mbit/s interfaces
- **With power insert**;  
replaceable insert for  
1 x 24 V DC and  
1 x 100 Mbit/s interface

**6GK1901-1BE00-0AA1**  
  
**6GK1901-1BE00-0AA2**  
  
**6GK1901-1BE00-0AA3**

##### SIMATIC NET Manual Collection

Electronic manuals  
for communication systems,  
communication protocols,  
and communication products;  
on DVD;  
German/English

**6GK1975-1AA00-3AA0**

#### More information

You can order components supplementary to the SIMATIC NET  
cabling range from your local contact.

Technical advice on this subject is available from:

J. Hertlein  
I A SC CI PRM 4  
Phone: +49 (911) 750-4465  
E-mail: [juergen.hertlein@siemens.com](mailto:juergen.hertlein@siemens.com)

**Overview**

Connecting cables with M12 plug or RJ45 plugs for transferring data or power between Industrial Ethernet nodes.

**Industrial Ethernet Connecting Cable M12-180/M12-180 (D-coded)**

- Pre-assembled connecting cable (IE FC TP Trailing Cable GP) for connecting Industrial Ethernet nodes (such as SIMATIC ET 200, SCALANCE X208PRO and SIMATIC RF systems) with IP65/IP67 degree of protection
- For transmission rates of 10/100 Mbit/s

**Industrial Ethernet Connecting Cable M12-180 (D-coded)/ IE FC RJ45 Plug-145**

- Pre-assembled connecting cable (IE FC TP Trailing Cable GP) for connecting Industrial Ethernet nodes (such as SIMATIC ET 200, SCALANCE X208PRO and SIMOTION) with IP65/IP67 degree of protection
- For transmission rates of 10/100 Mbit/s

**Industrial Ethernet Connecting Cable IE FC RJ45 plug-180/ IE FC RJ45 plug-180**

- Pre-assembled connecting cable (IE FC TP trailing cable GP) for connecting Industrial Ethernet nodes (e.g. SIMATIC ET 200 and SCALANCE X208) with IP20 degree of protection

**Power Connecting Cable M12-180/M12-180 (A-coded)**

- Pre-assembled connecting cable (4-core power cable, 4 x 0.75 mm<sup>2</sup>) for connecting Industrial Ethernet nodes (such as SIMATIC ET 200, SCALANCE X208PRO) with IP65/IP67 degree of protection
- For power transfer (24 V DC, 4-pin)

**Benefits**

get **Designed for Industry**

- Time-saving and fault-free connection of terminal stations by means of pre-fabricated connection cables
- Reliable screen contact and strain relief are integrated
- Comprehensive product range with different lengths and corresponding UL approvals and PROFINET conformity

# PROFINET/Industrial Ethernet

## Cabling technology

### Pre-assembled IE Connecting Cables

#### Technical specifications

Article No.	6XV1870-8AH10	6XV1871-5TN10
Product-type designation	IE Connecting Cable M12-180/M12-180	IE Connecting Cable M12-180/IE FC RJ45-145
Product description	Flexible connecting cable (4-core), preferred length, preassembled with two 4-pole M12 connectors (D-coded)	Flexible connecting cable (4-core), preferred length, preassembled with one 4-pole M12 connector (D-coded) and one IE FC RJ45 Plug 145
Acceptability for application	For connecting Industrial Ethernet stations (e.g. SIMATIC ET200pro and SCALANCE X208PRO) to IP 65/67 degree of protection	For connecting Industrial Ethernet stations (e.g. SIMATIC ET200pro, SCALANCE X208PRO and SIMOTION)
Cable designation	2YY (ST) CY 2x2x0,75/1,5-100 LI GN	2YY (ST) CY 2x2x0,75/1,5-100 LI GN
Cable length	1 m	10 m
<b>Electrical data</b>		
Damping ratio per length		
• at 10 MHz maximum	63 dB/km	63 dB/km
• at 100 MHz maximum	213 dB/km	213 dB/km
Impedance for frequency range 1 MHz ... 100 MHz	100 Ω	100 Ω
Relative symmetrical tolerance of the surge impedance at 1 MHz ... 100 MHz	5 %	5 %
Near-end crosstalk per length at 1 MHz ... 100 MHz	500 dB/km	500 dB/km
Transfer impedance at 10 MHz	20 mΩ/m	20 mΩ/m
Loop resistance per length maximum	120 Ω/km	120 Ω/km
Percentage NVP value	66 %	66 %
<b>Mechanical data</b>		
Number of electrical wires	4	4
Design of shield	Overlapped aluminum-clad foil, sheathed in a braided screen of tin-plated copper wires	Overlapped aluminum-clad foil, sheathed in a braided screen of tin-plated copper wires
Design of the electrical connection FastConnect	-	-
AWG number	-	-
Core diameter of the AWG22 core	0.75 mm	0.75 mm
Outer diameter		
• of the inner conductor	0.75 mm	0.75 mm
• of the wire insulation	1.5 mm	1.5 mm
• of the inner sheath of the cable	3.9 mm	3.9 mm
• of the cable sheath	6.5 mm	6.5 mm
Symmetrical tolerance of outer diameter of cable sheath	0.2 mm	0.2 mm
Material		
• of the wire insulation	PE	PE
• of the inner sheath of the cable	PVC	PVC
• of the cable sheath	PVC	PVC
Color		
• of the insulation of data wires	white / yellow / blue / orange	white / yellow / blue / orange
• of the cable sheath	green	green
Bending radius		
• with single bend minimum permissible	32.5 mm	32.5 mm
• with multiple bends minimum permissible	49 mm	49 mm
• with continuous bending	100 mm	100 mm
Number of bending cycles	3 000 000	3 000 000
• Note	For use in cable carriers, for 3 million bending cycles with a bending radius of 100 mm, a speed of 4 m/s, and an acceleration of 4 m/s <sup>2</sup>	For use in cable carriers, for 3 million bending cycles with a bending radius of 100 mm, a speed of 4 m/s, and an acceleration of 4 m/s <sup>2</sup>
Traction stress maximum	150 N	150 N
Weight per length	68 kg/km	68 kg/km

**Technical specifications** (continued)

Article No.	6XV1870-8AH10	6XV1871-5TN10
Product-type designation	IE Connecting Cable M12-180/M12-180	IE Connecting Cable M12-180/IE FC RJ45-145
<b>Permitted ambient conditions</b>		
Ambient temperature		
• during operating	-25 ... +75 °C	-25 ... +75 °C
• during storage	-25 ... +75 °C	-25 ... +75 °C
• during transport	-25 ... +75 °C	-25 ... +75 °C
• during installation	-10 ... +60 °C	-10 ... +60 °C
Protection class IP	IP65/67	-
Burning behaviour	flame resistant according to UL 1685 (CSA FT 4)	flame resistant according to UL 1685 (CSA FT 4)
Chemical resistance		
• to mineral oil	Conditional resistance	Conditional resistance
• to grease	Conditional resistance	Conditional resistance
• to water	-	Conditional resistance
Radiological resistance to UV radiation	Resistant	Resistant
<b>Product properties, functions, components general</b>		
Product feature		
• halogen-free	No	No
• silicon-free	Yes	Yes
<b>Standards, specifications, approvals</b>		
UL/ETL listing with 300 V rating	Yes: c(UL)us, CMG / PLTC / Sun Res / OIL RES	Yes: c(UL)us, CMG / PLTC / Sun Res / OIL RES
UL/ETL style with 600 V rating	Yes	Yes
Verification of suitability		
• RoHS conformity	Yes	Yes
Standard for structured cabling	Cat5e	Cat5e
Marine classification association		
• American Bureau of Shipping Europe Ltd. (ABS)	No	No
• Bureau Veritas (BV)	No	No
• Det Norske Veritas (DNV)	No	No
• Germanische Lloyd (GL)	No	No
• Lloyds Register of Shipping (LRS)	No	No

## PROFINET/Industrial Ethernet Cabling technology

### Pre-assembled IE Connecting Cables

Ordering data	Article No.	Article No.
<b>IE Connecting Cable M12-180/M12-180</b> Pre-assembled IE FC TP Trailing Cable GP 2 x 2 (PROFINET Type C) with two 4-pin M12 plugs (D-coded) up to 85 m, IP65/IP67 degree of protection Length: <ul style="list-style-type: none"> <li>• 0.3 m</li> <li>• 0.5 m</li> <li>• 1.0 m</li> <li>• 1.5 m</li> <li>• 2.0 m</li> <li>• 3.0 m</li> <li>• 5.0 m</li> <li>• 10 m</li> <li>• 15 m</li> </ul>	<b>6XV1870-8AE30</b> <b>6XV1870-8AE50</b> <b>6XV1870-8AH10</b> <b>6XV1870-8AH15</b> <b>6XV1870-8AH20</b> <b>6XV1870-8AH30</b> <b>6XV1870-8AH50</b> <b>6XV1870-8AN10</b> <b>6XV1870-8AN15</b>	<b>IE Connecting Cable IE FC RJ45 Plug-180/IE FC RJ45 Plug-180</b> Preassembled IE FC TP trailing cable GP 2 x 2 (PROFINET type C) with two IE FC RJ45 plug-180, IP20 degree of protection; length: <ul style="list-style-type: none"> <li>• 1.0 m</li> <li>• 2.0 m</li> <li>• 3.0 m</li> <li>• 5.0 m</li> <li>• 10 m</li> <li>• 15 m</li> <li>• 20 m</li> </ul>
<b>IE Connecting Cable M12-180/IE FC RJ45 Plug-145</b> Pre-assembled IE FC TP trailing cable GP 2 x 2 (PROFINET type C) with M12 plug (D-coded) and IE FC RJ45 plug, IP65/IP67 degree of protection Length: <ul style="list-style-type: none"> <li>• 2.0 m</li> <li>• 3.0 m</li> <li>• 5.0 m</li> <li>• 10 m</li> <li>• 15 m</li> </ul>	<b>6XV1871-5TH20</b> <b>6XV1871-5TH30</b> <b>6XV1871-5TH50</b> <b>6XV1871-5TN10</b> <b>6XV1871-5TN15</b>	<b>M12 Power Connecting Cable M12-180/M12-180</b> Flexible 4-core power connecting cable, assembled with A-coded 5-pin M12 connector and A-coded, 5-pin M12 socket to supply the ET 200 with 24 V DC; length: <ul style="list-style-type: none"> <li>• 0.3 m</li> <li>• 0.5 m</li> <li>• 1.0 m</li> <li>• 1.5 m</li> <li>• 2.0 m</li> <li>• 3.0 m</li> <li>• 5.0 m</li> <li>• 10 m</li> <li>• 15 m</li> </ul> Additional special lengths with 90° or 180° cable outlet  <b>PROFINET Cabling and Interconnection Technology Guideline</b>
		<b>6XV1871-5BH10</b> <b>6XV1871-5BH20</b> <b>6XV1871-5BH30</b> <b>6XV1871-5BH50</b> <b>6XV1871-5BN10</b> <b>6XV1871-5BN15</b> <b>6XV1871-5BN20</b>  <b>6XV1801-5DE30</b> <b>6XV1801-5DE50</b> <b>6XV1801-5DH10</b> <b>6XV1801-5DH15</b> <b>6XV1801-5DH20</b> <b>6XV1801-5DH30</b> <b>6XV1801-5DH50</b> <b>6XV1801-5DN10</b> <b>6XV1801-5DN15</b>  See <a href="http://support.automation.siemens.com/WW/view/en/26999294">http://support.automation.siemens.com/WW/view/en/26999294</a>  <a href="http://www.profinet.com">http://www.profinet.com</a>

### More information

#### Note:

You can order components supplementary to the SIMATIC NET cabling range from your local contact.

Technical advice on this subject is available from:

J. Hertlein  
 I IA SC CI PRM 4  
 Phone: +49 (911) 750-4465  
 E-mail: [juergen.hertlein@siemens.com](mailto:juergen.hertlein@siemens.com)



## Overview

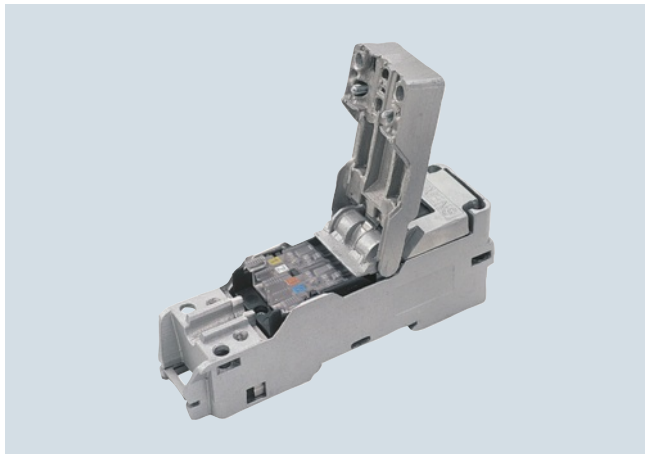

- Simple design of structured twisted-pair cabling
- Extremely short installation times thanks to insulation displacement method
- Rugged full-metal module certified according to Category 5
- Reliable shield contact and strain relief thanks to bolt-on cover
- Color marking prevents errors

## Benefits

get **Designed for Industry**

- Simple connection of network components or terminals to the interference-proof Industrial Ethernet FC cabling system
- Time-saving and error-free installation thanks to FC cables and pre-assembled TP Cords (10/100 Mbit/s)
- Noise-resistant due to rugged metal enclosure
- Flexible mounting options (DIN rail, direct mounting)
- Reliable shield contact and strain relief thanks to bolt-on cover
- Color marking prevents errors

## Application

The IE FC Outlet RJ45 is used as a transition from the rugged Industrial Ethernet FC cables used in the industrial environment to prefabricated TP Cord cables (10/100 Mbit/s) using an RJ45 socket.

By connecting several IE FC Outlet RJ45 devices in series, a patch field can be constructed with the required connection density (e.g. 16 outlets over 19" width).

## Design

The IE FC Outlet RJ45 has a rugged metal housing and satisfies Category 5 of the international cable standard ISO/IEC 11801 and EN 50173. It is suitable both for mounting on rails and wall mounting by means of four through holes.

The Outlet RJ45 can also be mounted behind a metal plate with a cutout (e.g. in a control cabinet).

The Outlet RJ45 has the following connections

- 4 insulation-piercing contacts for connecting the Industrial Ethernet FC cable 2 x 2 (contacts are color coded)
- RJ45 socket with dust protection cap for connecting different TP Cord cables (10/100 Mbit/s).

## Function

The Industrial Ethernet FC Outlet RJ45 is attached directly to the Industrial Ethernet FC cable 2 x 2.

For connection between IE Outlet RJ45 and network components or a terminal device, various preassembled RJ45 patch cables (10/100 Mbit/s) are available.

## PROFINET/Industrial Ethernet

### Cabling technology

#### IE FC Outlet RJ45

#### Technical specifications

Article No.	6GK1901-1FC00-0AA0
Product-type designation	IE FC outlet RJ45
<b>Electrical data</b>	
Transfer rate 1	10 Mbit/s
Transfer rate 2	100 Mbit/s
<b>Interfaces</b>	
Number of electrical connections	
• for Industrial Ethernet FC TP cables	1
• for network components and terminal equipment	1
Design of the electrical connection	
• for Industrial Ethernet FC TP cables	integrated insulation displacement contacts
• FastConnect	Yes
<b>Mechanical data</b>	
Material of the enclosure	metal
Design, dimensions and weight	
Width	31.7 mm
Height	107 mm
Depth	30 mm
Net weight	300 g
Mounting type	
• 35 mm DIN rail mounting	Yes
• wall mounting	Yes

Article No.	6GK1901-1FC00-0AA0
Product-type designation	IE FC outlet RJ45
<b>Permitted ambient conditions</b>	
Ambient temperature	
• during operating	-25 ... +70 °C
• during storage	-40 ... +70 °C
• during transport	-40 ... +70 °C
Protection class IP	IP20
<b>Standards, specifications, approvals</b>	
Verification of suitability UL-registration	Yes
Standard for structured cabling	Cat5

2

Ordering data	Article No.	Article No.	
<b>IE FC Outlet RJ45</b> For connection of Industrial Ethernet FC cables and TP Cords; graded prices from 10 and 50 units on	<b>6GK1901-1FC00-0AA0</b>	<b>IE FC TP Trailing Cable 2 x 2 (Type C)</b> 4-core, shielded TP installation cable for connection to IE FC Outlet RJ45/ IE FC RJ45 Plug 180/90 for use as trailing cable; PROFINET-compatible; with UL approval; <u>sold by the meter</u> ; max. length 1 000 m, minimum order 20 m	<b>6XV1840-3AH10</b>
<b>IE TP Cord RJ45/RJ45</b> TP cable 2 x 2 with two RJ45 plugs <ul style="list-style-type: none"> <li>• 0.5 m</li> <li>• 1 m</li> <li>• 2 m</li> <li>• 6 m</li> <li>• 10 m</li> </ul>	<b>6XV1850-2GE50</b> <b>6XV1850-2GH10</b> <b>6XV1850-2GH20</b> <b>6XV1850-2GH60</b> <b>6XV1850-2GN10</b>	<b>IE FC TP Festoon Cable GP 2 x 2 (Type B)</b> 4-core, shielded TP installation cable for connection to IE FC Outlet RJ45/ IE FC RJ45 Plug 180/90 for use in festoon applications; PROFINET-compatible; with UL approval; <u>sold by the meter</u> ; max. length 1 000 m, minimum order 20 m	<b>6XV1871-2S</b>
<b>IE TP XP Cord RJ45/RJ45</b> TP cable 2 x 2 with two RJ45 plugs <ul style="list-style-type: none"> <li>• 0.5 m</li> <li>• 1 m</li> <li>• 2 m</li> <li>• 6 m</li> <li>• 10 m</li> </ul>	<b>6XV1850-2HE50</b> <b>6XV1850-2HH10</b> <b>6XV1850-2HH20</b> <b>6XV1850-2HH60</b> <b>6XV1850-2HN10</b>	<b>IE TP Torsion Cable 2 x 2 (Type C)</b> 4-core, shielded TP installation cable for connection to IE FC Outlet RJ45/ IE FC RJ45 Plug for use with robots; PROFINET-compatible; with UL approval; <u>sold by the meter</u> ; max. length 1 000 m, minimum order 20 m	<b>6XV1870-2F</b>
<b>SIMATIC NET Manual Collection</b> Electronic manuals for communication systems, communication protocols, and communication products; on DVD; German/English	<b>6GK1975-1AA00-3AA0</b>	<b>IE FC TP Standard Cable GP 2 x 2 (Type A)</b> 4-core, shielded TP installation cable for connection to IE FC Outlet RJ45/ IE FC RJ45 Plug; PROFINET-compatible; with UL approval; <u>sold by the meter</u> Max. length 1 000 m; minimum order 20 m  Preferred length <ul style="list-style-type: none"> <li>• 1000 m</li> </ul>	<b>6XV1840-2AH10</b>
<b>IE FC TP Flexible Cable GP 2 x 2 (Type B)</b> 4-core, shielded TP installation cable for connection to IE FC Outlet RJ45/ IE FC RJ45 Plug for occasional movement; PROFINET-compatible; with UL approval; <u>sold by the meter</u> ; max. length 1 000 m, minimum order 20 m	<b>6XV1870-2B</b>	<b>IE FC TP Food Cable GP 2 x 2 (Type C)</b> 4-core, shielded TP installation cable for connection to IE FC Outlet RJ45/ IE FC RJ45 Plug 180/90 for the food and beverages industry; PROFINET-compatible; <u>sold by the meter</u> ; max. length 1 000 m, minimum order 20 m	<b>6XV1871-2L</b>
<b>IE FC TP FRNC Cable GP 2 x 2 (Type B)</b> 4-core, shielded, halogen-free TP installation cable for connection to IE FC Outlet RJ45/ IE FC RJ45 Plug for occasional movement; PROFINET-compatible; with UL approval; <u>sold by the meter</u> ; max. length 1 000 m, minimum order 20 m	<b>6XV1871-2F</b>	<b>IE FC TP Marine Cable 2 x 2 (Type B)</b> 4-core, shielded TP installation cable for connection to IE FC Outlet RJ45/ IE FC RJ45 Plug 180/90; marine approval; max. length 1 000 m, minimum order 20 m	<b>6XV1840-4AH10</b>
<b>IE FC TP Trailing Cable GP 2 x 2 (Type C)</b> 4-core, shielded TP installation cable for connection to IE FC Outlet RJ45/ IE FC RJ45 Plug for use as trailing cable; PROFINET-compatible; with UL approval; <u>sold by the meter</u> ; max. length 1 000 m, minimum order 20 m	<b>6XV1870-2D</b>	<b>IE TP Ground Cable 2 x 2 (Type C)</b> 4-core, shielded TP installation cable for connection to IE FC Outlet RJ45/ IE FC RJ45 Plug 180/90 (additional outer sheath must be removed) for laying in soil; <u>sold by the meter</u> ; max. length 1 000 m, minimum order 20 m	<b>6XV1871-2G</b>
<b>IE FC TP Trailing Cable GP 2 x 2 (Type C)</b> 4-core, shielded TP installation cable for connection to IE FC Outlet RJ45/ IE FC RJ45 Plug for use as trailing cable; PROFINET-compatible; with UL approval; <u>sold by the meter</u> ; max. length 1 000 m, minimum order 20 m	<b>6XV1870-2D</b>	<b>IE TP Train Cable 2 x 2 (Type C)</b> 4-core, shielded TP installation cable for connection to IE FC RJ45 Plug and IE FC M12 Plug PRO; <u>sold by the meter</u> ; max. length 1 000 m, minimum order 20 m	<b>6XV1871-2T</b>

## PROFINET/Industrial Ethernet

### Cabling technology

#### IE FC RJ45 Modular Outlet

##### Overview



- Simple connection technology (insulation displacement contacts) for 8-core Industrial Ethernet FastConnect twisted pair installation cables (Cat6)
- Safe connection technology thanks to visible connection area
- Industry-standard design
  - Rugged metal housing
  - Dust caps
- Wall and DIN rail mounting inside or outside control cubicles thanks to IP40 protection
- Good electromagnetic shielding and conduction due to metal housing
- Integral strain relief for 8-core installation cables
- Replaceable inserts for
  - 2 x Fast Ethernet connection  
*IE FC RJ45 Modular Outlet Insert 2FE*
  - 1 x Gigabit Ethernet connection  
*IE FC RJ45 Modular Outlet insert 1GE*

##### Benefits

**get** Designed for Industry

- Easy and problem-free assembly due to integrated color-coded insulation displacement contacts
- Time-saving and trouble-free installation with 8-core Industrial Ethernet FC TP installation cables
- Universal use due to replaceable inserts (insert for two 10/100 Mbit/s ports, one 1 000 Mbit/s port or one 24 V DC power supply and 100 Mbit/s port)
- Wide operating temperature range (-20 °C to +70 °C)
- Reliable shield contact and strain relief thanks to bolt-on cover
- Protection of investment, as a 100 Mbit/s network can be upgraded without difficulty to a 1 000 Mbit/s network by replacing the insert without having to release the cable contacts

##### Application

The 8-core cabling system of SIMATIC NET allows transfer rates of 10/100/1000 Mbit/s for Ethernet and for the service-independent cabling from this office environment. Thanks to the 8-core cabling it is now possible to implement two Industrial Ethernet connections for Fast Ethernet, but in future it will also be possible to upgrade to a Gigabit Ethernet connection. This implements the transition from 4-core Industrial Ethernet FastConnect TP cabling system to the 8-core Gigabit cabling system.

The FC RJ45 Modular Outlet base module can optionally be equipped with two different replaceable inserts, as follows:

- IE FC RJ45 Modular Outlet Insert 2FE with 2 x RJ45 sockets for 100 Mbit/s systems
- IE FC RJ45 Modular Outlet Insert 1GE with 1 x RJ45 socket for 1 000 Mbit/s systems

Thus it is possible not only to implement individual device connections, but also 100 Mbit/s dual connections.

By replacing the insert, it is possible to switch from network structures that are operated at transfer rates of 100 Mbit/s to structures with rates of 1 000 Mbit/s. Replacement of the cabling is not necessary (permanent cabling).

Like the 4-wire cabling system, the Gigabit cabling system with the IE FC RJ45 Modular Outlet also takes the conditions in the field of industrial automation into account. No special tools are required for the assembly; the same FC stripping tool is used as for the 4-wire system.

8-wire FC installations cables are used for the cabling (AWG 22):

- IE FC Standard Cable 4 x 2; for fixed routing as standard type for the IE FC RJ45 Modular Outlet Inserts 2FE and 1GE

Max. distance which can be covered between two IE FC Modular Outlets using IE FC Standard Cable is 90 m; the total length of the patch cords to the terminal units at each end must not exceed 10 m.

**Application** (continued)

**Application examples**

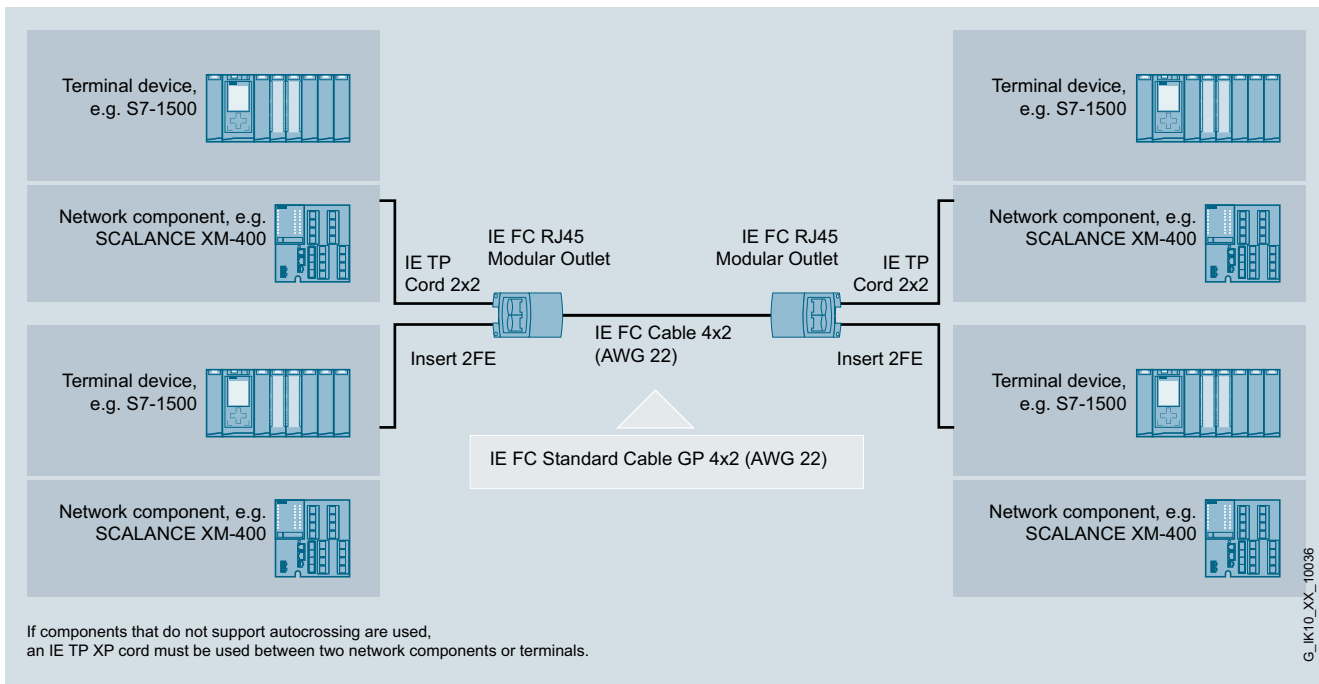

IE TP Cord can be used with IE FC RJ45 Modular Outlet with Insert 2FE (10/100 Mbit/s)

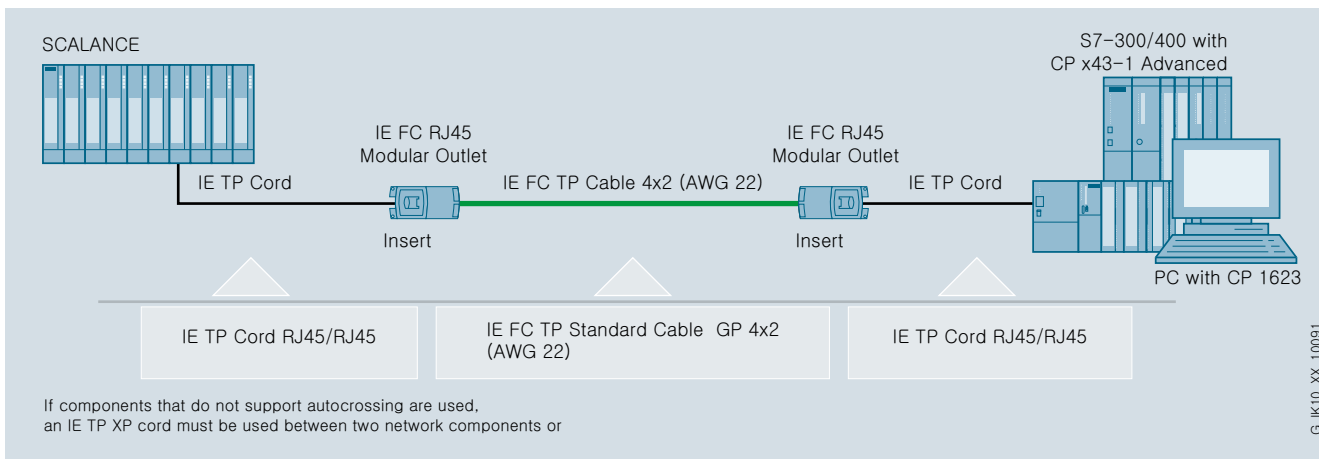

IE TP Cord RJ45/RJ45 can be used for patch technology with IE FC RJ45 Modular Outlet with Insert 1GE (10/100/1 000 Mbit/s)

## PROFINET/Industrial Ethernet

### Cabling technology

#### IE FC RJ45 Modular Outlet

#### Design

IE FC RJ45 Modular Outlet (base modules)

- Robust metal housing, complies with Category 6 of the international cabling standards ISO/IEC 11801 and EN 50173
- Suitable both for DIN rail and wall mounting
- Thanks to its high degree of protection IP40, it can be mounted directly on site

Ports:

- 8 insulation displacement contacts for connection of the 8-core Industrial Ethernet FC installation cables
- Interface for insertion of a replaceable insert with one or two RJ45 sockets or one RJ45 socket and one terminal for 24 V DC voltage supply (outlet insert, outlet power insert).



As delivered

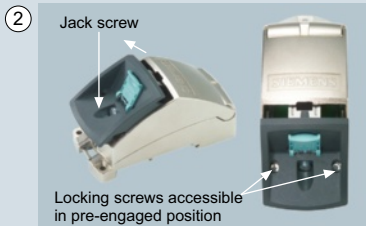

Release insert with jack screw and pull into pre-engaged position

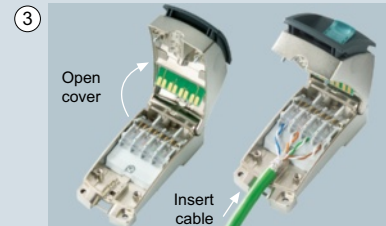

Connect cable

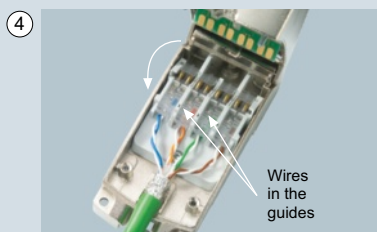

Connect cable:  
Press down insulation displacement contacts

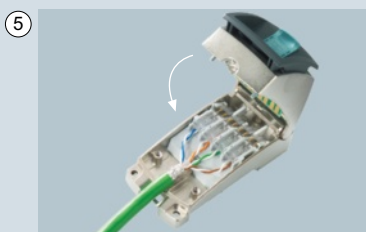

Close cover



Push insert into end position. Tighten the interlocking screws of the strain-relief, push insert in, tighten jack screw



Outlet assembly complete



Outlet ready for use

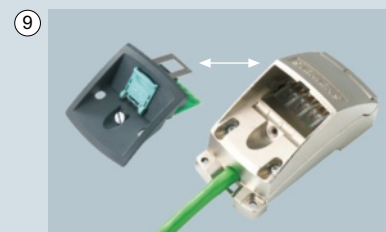

Exchanging the insert: Insert can be replaced while basic housing is closed by pulling it past the pre-engaged position.

G\_IK10\_XX\_30029

Mounting instructions

### Function

The IE FC RJ45 Modular Outlet is connected direct to the 8-core Industrial Ethernet FC cables 4 x 2. Pre-assembled RJ45 patch cables (TP cord) are available for the connection between outlet and network component or data terminal. These conform with Cat6 of the international cabling standards.

When housing is opened, colored markings on the contact element simplify connection of the individual wires to the insulation displacement contacts.

A maximum of 80 m can be covered between the Outlet and the IP67 hybrid connector. The connection between Outlet and data terminal can be established using a patch cable with a maximum length of 6 m.

2

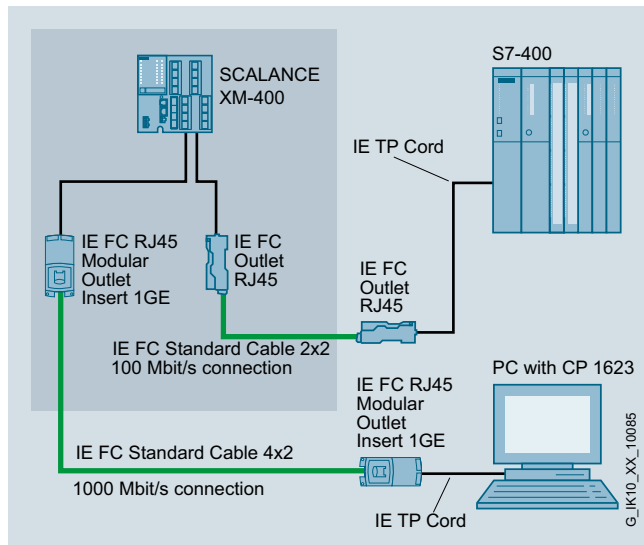

System configuration with IE FC RJ45 Modular Outlet and IE FC Outlet RJ45

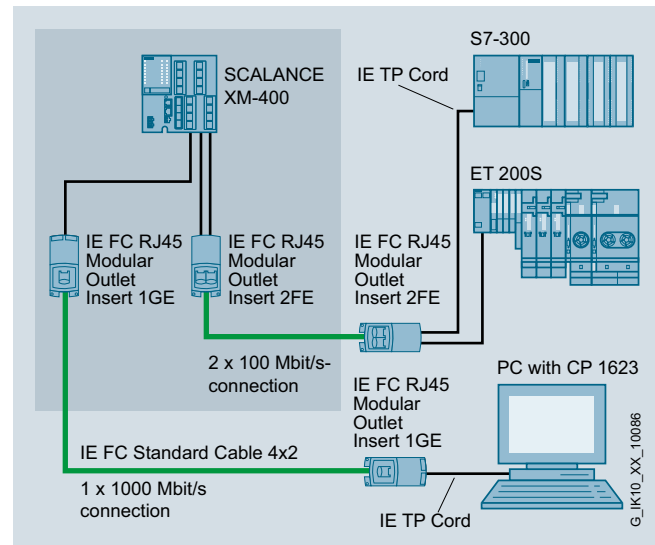

System configuration with IE FC RJ45 Modular Outlet 100 Mbit/s and 1 000 Mbit/s

# PROFINET/Industrial Ethernet

## Cabling technology

### IE FC RJ45 Modular Outlet

#### Technical specifications

Article No.	6GK1901-1BE00-0AA0	6GK1901-1BE00-0AA1	6GK1901-1BE00-0AA2	6GK1901-1BE00-0AA3
Product-type designation	IE FC RJ45 modular outlet (without insert)	IE FC RJ45 modular outlet (insert 2FE)	IE FC RJ45 modular outlet (insert 1GE)	IE FC RJ45 modular outlet (power insert)
<b>Electrical data</b>				
Transfer rate 1	10 Mbit/s	10 Mbit/s	10 Mbit/s	10 Mbit/s
Transfer rate 2	100 Mbit/s	100 Mbit/s	100 Mbit/s	100 Mbit/s
Transfer rate 3	1 000 Mbit/s	-	1 000 Mbit/s	-
<b>Interfaces</b>				
Number of electrical connections				
• for Industrial Ethernet FC TP cables	1	1	1	1
• for network components and terminal equipment	-	2	1	1
Design of the electrical connection				
• for Industrial Ethernet FC TP cables	integrated insulation displacement contacts	integrated insulation displacement contacts	integrated insulation displacement contacts	integrated insulation displacement contacts
• for FC RJ45 modular outlet insert 2FE	-	2 x RJ45 socket (10/100 Mbit/s)	-	-
• for FC RJ45 modular outlet insert 1GE	-	-	1 x RJ45 socket (10/100 Mbit/s)	-
• for FC RJ45 modular outlet power insert	-	-	-	1 x RJ45 socket (10/100 Mbit/s), 1 x 24 V DC terminal
• FastConnect	Yes	Yes	Yes	Yes
<b>Mechanical data</b>				
Material of the enclosure	metal	metal	metal	metal
Design, dimensions and weight				
Width	50 mm	50 mm	50 mm	50 mm
Height	115.25 mm	115.25 mm	115.25 mm	115.25 mm
Depth	58.95 mm	58.95 mm	58.95 mm	58.95 mm
Net weight	450 g	450 g	450 g	450 g
Mounting type				
• 35 mm DIN rail mounting	Yes	Yes	Yes	Yes
• wall mounting	Yes	Yes	Yes	Yes
<b>Permitted ambient conditions</b>				
Ambient temperature				
• during operating	-20 ... +70 °C	-20 ... +70 °C	-20 ... +70 °C	-20 ... +70 °C
• during storage	-40 ... +80 °C	-40 ... +80 °C	-40 ... +80 °C	-40 ... +80 °C
• during transport	-40 ... +80 °C	-40 ... +80 °C	-40 ... +80 °C	-40 ... +80 °C
Relative humidity at 25 °C without condensation during operating maximum	95 %	95 %	95 %	95 %
Protection class IP	IP40	IP40	IP40	IP40
<b>Standards, specifications, approvals</b>				
Verification of suitability	Yes	Yes	Yes	Yes
RoHS conformity				
Verification of suitability	Yes	Yes	Yes	Yes
UL-registration				
Standard for structured cabling	Cat 6	Cat 6	Cat 6	Cat 6



Ordering data	Article No.	Ordering data	Article No.
<b>IE FC RJ45 Modular Outlet</b> FastConnect RJ45 Outlet for Industrial Ethernet with interface for a replaceable insert; <ul style="list-style-type: none"> <li>• without replaceable insert</li> <li>• <b>With 2FE insert;</b> replaceable insert for 2 x 100 Mbit/s interfaces</li> <li>• <b>With 1GE insert;</b> replaceable insert for 1 x 1 000 Mbit/s interfaces</li> </ul>	<b>6GK1901-1BE00-0AA0</b> <b>6GK1901-1BE00-0AA1</b>  <b>6GK1901-1BE00-0AA2</b>	<b>IE FC TP Standard Cable 4 x 2</b> 8-core FastConnect cable (Cat6) for permanent wiring; <u>sold by the meter</u>	<b>6XV1870-2E</b>
<b>IE FC RJ45 Modular Outlet Insert 2FE</b> Replaceable insert for FC Modular Outlet Base; 2 x RJ45 for 2 x 100 Mbit/s interfaces; 1 pack = 4 items	<b>6GK1901-1BK00-0AA1</b>	<b>IE TP Cord</b> 8-core patch cable for connection between FC Modular Outlet base modules and data terminal; available in different lengths	see IE TP Cord
<b>IE FC RJ45 Modular Outlet Insert 1GE</b> Replaceable insert for FC Modular Outlet Base; 1 x RJ45 for 1 x 1 000 Mbit/s interface; 1 pack = 4 items	<b>6GK1901-1BK00-0AA2</b>	<b>IE FC stripping tool</b> Preadjusted stripping tool for fast stripping of Industrial Ethernet FC cables	<b>6GK1901-1GA00</b>

## PROFINET/Industrial Ethernet

### Cabling technology

#### Overview of FC-FOCs

##### Overview

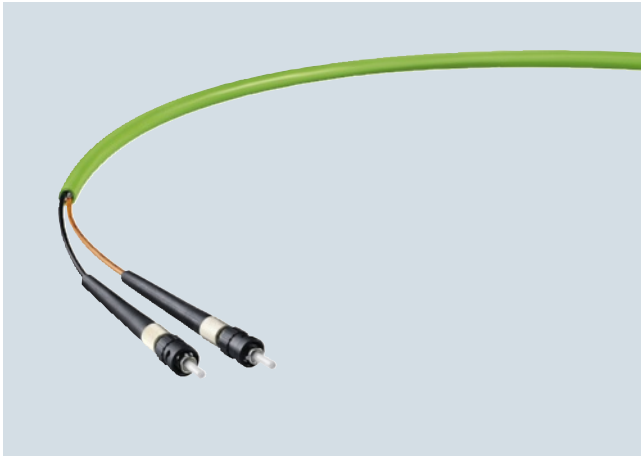

- Simple on-site assembly of glass FOC in the field
- Optical signal transmission
- No radiation emission from the cable
- Unaffected by external noise fields
- No grounding problems
- Electrical isolation
- Low weight
- Simple laying of cables

##### Design

Fiber-optic cables with glass core (62.5/200/230) are offered for the FastConnect fiber-optic cable system:

- FC glass fiber-optic cable; duplex cable for indoor and outdoor fiber-optic networks

The fiber structure corresponds to that of the PCF. This allows simple assembly on site.

Sheath material	Application
PVC	Standard use in indoor and outdoor areas of industrial applications
PUR	Highly mobile applications (tow chains) for high mechanical or chemical stress in harsh industrial environments
PE	Routing of cables in moist areas indoors and outdoors, and for direct burying in earth
FRNC	Standard applications with high fire protection requirements

##### Approvals

UL listing (safety standard) for network lines is especially necessary for the American and Canadian markets. The requirements for the appropriate approvals depend on where the cable is routed within the building. This applies to all cables which have to be routed from a machine to a remote control cabinet and are positioned on cable racks secured in the building. These cables are identified by the suffix "GP" (general purpose) in the product name and have the corresponding UL approvals.

### Application

The fiber-optic cable (FOC) is used for the transmission of signals in very extensive plants and where there are significant potential differences within a plant. The light beam is guided by total reflection at the transition from core to cladding which has a lower refractive index than the core.

The FastConnect fiber-optic (FC FO) system enables fast on-site assembly of glass fiber-optic cables with the right lengths to suit the respective application.

### Assembly with FastConnect for glass fiber-optic cables

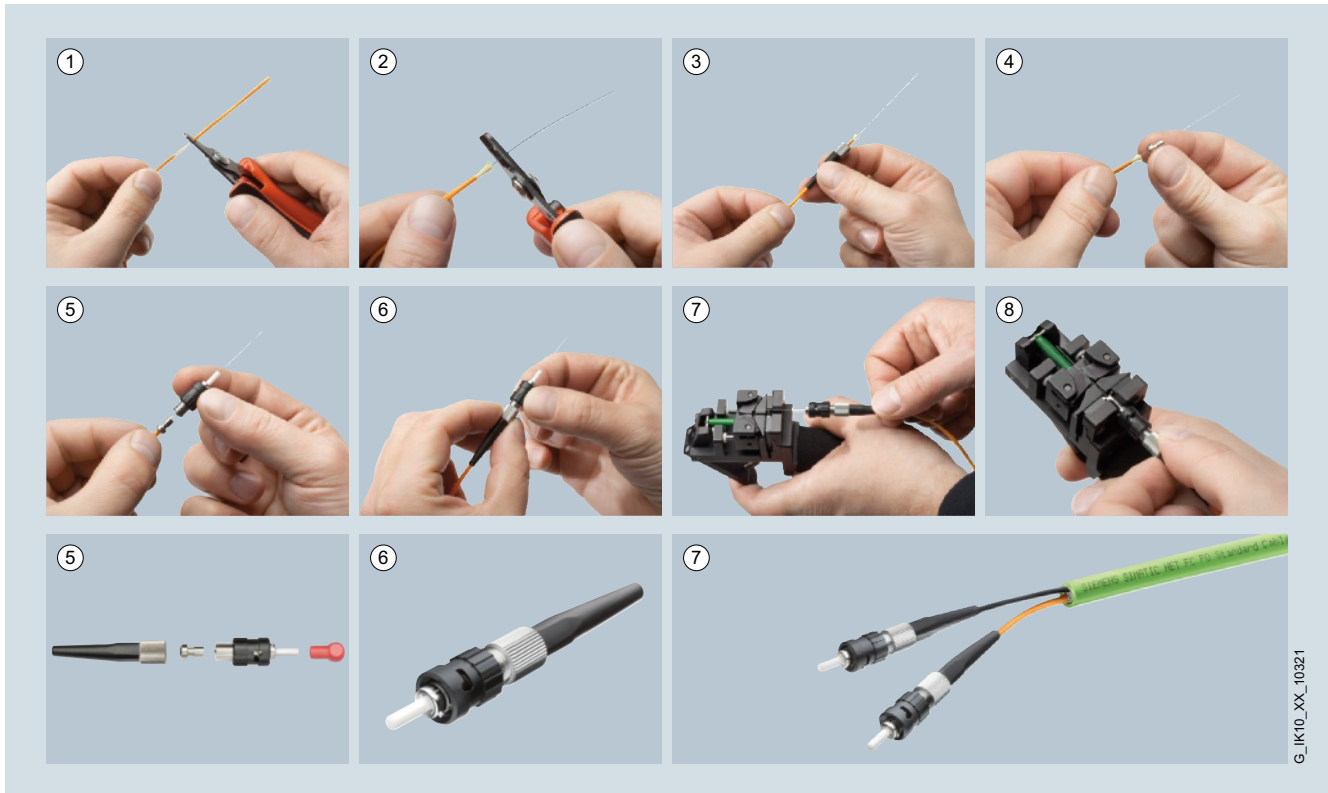

Steps for assembly of Industrial Ethernet fiber-optic cables with Industrial Ethernet FastConnect

## PROFINET/Industrial Ethernet

### Cabling technology

#### FC glass fiber-optic cables

##### Overview



- FastConnect standard fiber-optic cable for use in optical Industrial Ethernet and PROFIBUS networks
- For all users who want to install and assemble the glass fiber-optic cables themselves over longer distances on site for office or industrial applications.
- Simple FastConnect SC/BFOC connector assembly on site
- Rugged construction for industrial applications both indoors and outdoors
- High interference immunity, as they are not sensitive to electromagnetic interference
- Extensive range of approvals (UL approvals)

##### Benefits



- Avoidance of excessive cable lengths in the control cabinet, as the fiber-optic cables can be assembled to the right length on site
- Easy installation of cables in buildings, as cables can be pulled in without connectors attached
- Simple extension of installed glass fiber-optic cables via SC and BFOC couplers
- Devices with different connection method (SC or BFOC) can easily be connected to one another using self-assembled adapter cables
- Electrical isolation of Industrial Ethernet/PROFINET/PROFIBUS devices
- Unaffected by electromagnetic interference
- Tap-proof: no radiation from cable

##### Application

SIMATIC NET FastConnect glass fiber-optic cables are used to construct optical indoor and outdoor Industrial Ethernet/PROFINET and PROFIBUS networks. Devices with integral optical interface (SC or BFOC connection technology) are, for example, optical link modules (OLM) and SCALANCE X Industrial Ethernet switches.

FastConnect glass fiber-optic cables are to be assembled on site using FastConnect SC or FastConnect BFOC connectors. A corresponding assembly kit (FC FO Termination Kit) is available for this purpose. The Termination Kit permits the stripping and the "cleaving" of the fiber in the assembled connector, as is familiar from PCF fiber-optic cables. To extend existing lines, a BFOC or SC coupler may be used depending on the connection technology.

##### Design

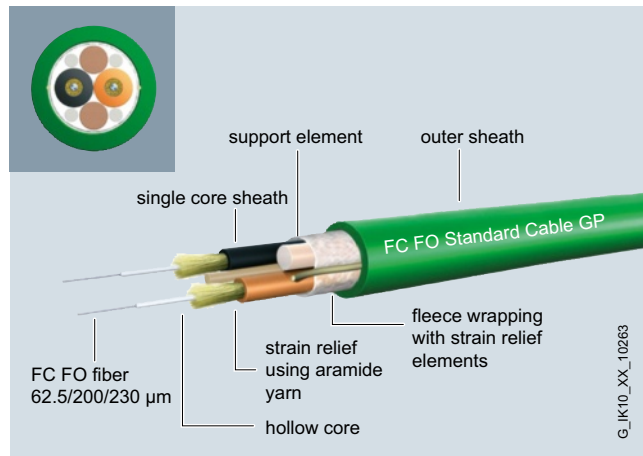

**FC FO Standard Cable GP (General Purpose);** rugged round cable with green outer sheath, Kevlar strain relief elements, and 62.5/200/230 FC FO fibers for indoor/outdoor applications

**FC FO Trailing Cable;** rugged round cable with green outer sheath, Kevlar strain relief elements and 62.5/200/230 FC FO fibers for use in tow chains and moving applications

Maximum cable length between two devices:

- 3 000 m for 100 Mbit/s Ethernet or for PROFIBUS
- 350 m for 1 000 Mbit/s Ethernet (1000Base-SX)
- 550 m for 1 000 Mbit/s Ethernet (1000Base-LX)

The maximum cable lengths can be assembled from partial lengths using FastConnect couplings (SC or BFOC; maximum two couplings, approx. 2.5 dB attenuation per coupling). It is also possible to combine existing installed, conventional 62.5/125 μm multimode glass fiber-optic cable sections with the FastConnect fiber-optic cables.

**Technical specifications**

Article No.	6XV1847-2A	6XV1847-2C
Product-type designation	FC FO standard cable GP	FC FO trailing cable
Product description	Glass fiber-optic cable for assembly in the field, sold by the meter, unassembled	Flexible glass fiber-optic cable for assembly in the field, sold by the meter, unassembled
Acceptability for application	Cable for fixed routing in cable ducts and conduits, UL approval	Cable for high mechanical loading for use in trailing cables indoors and outdoors
Version of the assembled FO cable	can be assembled with four BFOC or SC connectors	can be assembled with four BFOC or SC connectors
Cable designation	AT-V(ZN)YY 2GK 62.5/200/230	AT-V(ZN)Y(ZN)11Y 2GK 62.5/200/230
<b>Optical data</b>		
Damping ratio per length		
• at 850 nm maximum	3.2 dB/km	3.2 dB/km
• at 1300 nm maximum	0.9 dB/km	0.9 dB/km
Bandwidth length product		
• at 850 nm	200 GHz·m	200 GHz·m
• at 1300 nm	500 GHz·m	500 GHz·m
<b>Mechanical data</b>		
Number of fibers per FOC core	1	1
Number of FOC cores per FOC cable	2	2
Version of the FO conductor fiber	Multi-mode gradient fiber 62.5/200/230 μm	Multi-mode gradient fiber 62.5/200/230 μm
Design of the FOC core	Fixed core	Fixed core
Design of the fiber-optic cable	Segmentable cable	Segmentable cable
Outer diameter		
• of optical fibers	62.5 μm	62.5 μm
• of the optical fiber sheath	230 μm	230 μm
• of the FOC core sheath	2.2 mm	2.2 mm
• of the cable	7.2 mm	8.8 mm
Symmetrical deviation		
• of the outer diameter of the FOC core sheath	0.1 mm	0.1 mm
• of the outer diameter of the line	0.5 mm	0.5 mm
Material		
• of the fiber-optic cable core	Quartz glass	Quartz glass
• of the optical fiber sheath	ETFE	ETFE
• of the FOC core sheath	PVC	PVC
• of the fiber-optic cable sheath	PVC	PUR
• of the strain relief	Aramide fibers	Aramide fibers (double-ply)
Color		
• of the FOC core sheath	orange / black	orange / black
• of the cable sheath	green	green
Bending radius		
• with single bend minimum permissible	70 mm	88 mm
• with multiple bends minimum permissible	105 mm	88 mm
• with continuous bending	-	88 m
Number of bending cycles	-	5 000 000
Number of torsion cycles in the case of torsion by ± 360° on 1 m cable length	-	-
Traction stress maximum	100 N	800 N
Short-term shear force per length	500 N/cm	500 N/cm
Continuous lateral force per length	300 N/cm	300 N/cm
Weight per length	49 kg/km	65 kg/km

## PROFINET/Industrial Ethernet

### Cabling technology

#### FC glass fiber-optic cables

#### Technical specifications (continued)

Article No.	6XV1847-2A	6XV1847-2C
Product-type designation	FC FO standard cable GP	FC FO trailing cable
<b>Permitted ambient conditions</b>		
Ambient temperature		
• during operating	-40 ... +85 °C	-25 ... +75 °C
• during storage	-40 ... +85 °C	-30 ... +75 °C
• during transport	-40 ... +85 °C	-30 ... +75 °C
• during installation	-5 ... +50 °C	-5 ... +50 °C
Burning behaviour	Flame-retardant in accordance with IEC 60332-1-2 and IEC 60332-3-22 (Cat. A)	Flame-retardant in accordance with IEC 60332-1-2
Chemical resistance		
• to mineral oil	Conditional resistance	Resistant
• to grease	Conditional resistance	Resistant
• to water	Conditional resistance	Conditional resistance
Radiological resistance to UV radiation	Resistant	Resistant
<b>Product properties, functions, components general</b>		
Product feature		
• halogen-free	No	No
• silicon-free	Yes	Yes
Product component Rodent protection	No	No
Cable length for glass FOC		
• for 100BaseFX for Industrial Ethernet maximum	3 000 m	3 000 m
• for 1000BaseSX for Industrial Ethernet maximum	350 m	350 m
• for 1000BaseLX for Industrial Ethernet maximum	550 m	550 m
• for PROFIBUS maximum	3 000 m	3 000 m
<b>Standards, specifications, approvals</b>		
Verification of suitability	UL approval: OFN (NEC Article 770, UL 1651) / CSA approval: OFN 90 Cel, FT1, FT4 (CSA standard C22.2 No232-M1988)	-
• RoHS conformity	Yes	Yes

**Technical specifications** (continued)

Article No.	6GK1900-1LB00-0AC0	6GK1900-1GB00-0AC0	6GK1900-1LP00-0AB0	6GK1900-1GP00-0AB0
Product-type designation	IE SC RJ PCF Plug PRO (Push Pull)	FC FO BFOC Plug	FC FO SC Coupler	FC FO BFOC Coupler
Product description	SC plug for FastConnect assembly	BFOC plug for FastConnect assembly	SC duplex coupler for FastConnect assembly	BFOC coupler for FastConnect assembly
Acceptability for application	For connecting glass fiber-optic cables, suitable for fast assembly with the FastConnect FO system	For connecting glass fiber-optic cables, suitable for fast assembly with the FastConnect FO system	-	-
<b>Transmission rate</b>				
Transfer rate				
• 1 for Industrial Ethernet	10 Mbit/s	10 Mbit/s	10 Mbit/s	10 Mbit/s
• 2 for Industrial Ethernet	100 Mbit/s	100 Mbit/s	100 Mbit/s	100 Mbit/s
• 3 for Industrial Ethernet	1 000 Mbit/s	1 000 Mbit/s	1 000 Mbit/s	1 000 Mbit/s
• with PROFIBUS	9.6 kbit/s ... 12 Mbit/s	9.6 kbit/s ... 12 Mbit/s	9.6 kbit/s ... 12 Mbit/s	9.6 kbit/s ... 12 Mbit/s
<b>Interfaces</b>				
Number of optical interfaces for optical waveguide	1	1	1	1
Design of optical connections for network components or terminal devices	SC connector	BFOC connector	SC duplex coupling	BFOC coupling
Design of the electrical connection FastConnect	Yes	Yes	Yes	Yes
<b>Mechanical data</b>				
Material of the enclosure	Metal and plastic	Metal and plastic	Metal and plastic	Metal and plastic
<b>Design, dimensions and weight</b>				
Type of cable outlet	180 degree cable outlet	180 degree cable outlet	180 degree cable outlet	180 degree cable outlet
Width	8 mm	10 mm	9 mm	11 mm
Height	8 mm	10 mm	35 mm	11 mm
Depth	49 mm	22 mm	28 mm	29.5 mm
Net weight	11 g	9 g	18 g	9 g
<b>Permitted ambient conditions</b>				
Ambient temperature				
• during operating	-40 ... +85 °C	-40 ... +85 °C	-40 ... +85 °C	-40 ... +85 °C
• during storage	-40 ... +85 °C	-40 ... +85 °C	-40 ... +85 °C	-40 ... +85 °C
• during transport	-40 ... +85 °C	-40 ... +85 °C	-40 ... +85 °C	-40 ... +85 °C
Relative humidity at 25 °C without condensation during operating maximum	95 %	95 %	95 %	95 %
Protection class IP	IP20	IP20	IP20	IP20
<b>Product properties, functions, components general</b>				
Product feature silicon-free	Yes	Yes	Yes	Yes
Product component strain relief	Yes	Yes	Yes	Yes
<b>Standards, specifications, approvals</b>				
Verification of suitability RoHS conformity	Yes	Yes	Yes	Yes

## PROFINET/Industrial Ethernet

### Cabling technology

#### FC glass fiber-optic cables

Ordering data	Article No.
<b>FC FO standard cable GP</b> 62.5/200/230  FC FO standard cable for fixed routing indoors with PVC sheath; <u>sold by the meter</u> max. length 1 000 m; minimum order 20 m	<b>6XV1847-2A</b>
<b>FC FO trailing cable</b>  FC FO trailing cable for use in tow chains and moving applications; <u>sold by the meter</u>	<b>6XV1847-2C</b>
<b>FC FO termination kit</b>  Assembly case for local assembly of FC SC and FC BFOC connectors to FC FO standard cable, comprising a stripping tool, Kevlar cutters, fiber breaking tool and microscope	<b>6GK1900-1GL00-0AA0</b>
<b>FC SC plug</b>  Screw connector for on-site assembly on FC fiber-optic cable; (1 pack = 10 duplex plugs + cleaning cloths)	<b>6GK1900-1LB00-0AC0</b>
<b>FC BFOC plug</b>  Screw connector for on-site assembly on FC fiber-optic cable; (1 pack = 20 units + cleaning cloths)	<b>6GK1900-1GB00-0AC0</b>
<b>FC SC coupler</b>  FC SC duplex coupling; (1 pack = 5 units)	<b>6GK1900-1LP00-0AB0</b>
<b>FC BFOC coupler</b>  FC BFOC coupling; (1 pack = 10 units)	<b>6GK1900-1GP00-0AB0</b>
<b>SIMATIC NET Manual Collection</b>  Electronic manuals for communication systems, communication protocols, and communication products; on DVD; German/English	<b>6GK1975-1AA00-3AA0</b>

#### More information

You can order components supplementary to the SIMATIC NET cabling range from your local contact.

Technical advice on this subject is available from:

J. Hertlein  
 I IA SC CI PRM 4  
 Phone: +49 (911) 750-4465  
 E-mail: [juergen.hertlein@siemens.com](mailto:juergen.hertlein@siemens.com)



## Overview



- Compact, rugged assembly case for FastConnect glass fiber-optic cables
- Simple fitting of SC and BFOC connectors to FastConnect glass fiber-optic cables
- The quality of the assembly can be checked using the enclosed microscope

## Benefits

**get** Designed for Industry

- Simple installation of the unassembled cable
- Flexible connector assembly possible on site (SC/BFOC connectors)
- Prevention of faults by simply checking the assembled connectors using a microscope
- Simple repair of FC glass fiber-optic cables in the field

## Application

SIMATIC NET FC glass fiber-optic cables are used to construct optical indoor and outdoor Industrial Ethernet/PROFINET and PROFIBUS networks. They are easy to assemble on-site using the termination kit with SC or BFOC connectors. The maximum cable length between two Industrial Ethernet/PROFINET or PROFIBUS devices is 3 000 m in the case of 100 Mbit/s Ethernet or PROFIBUS.

## Design

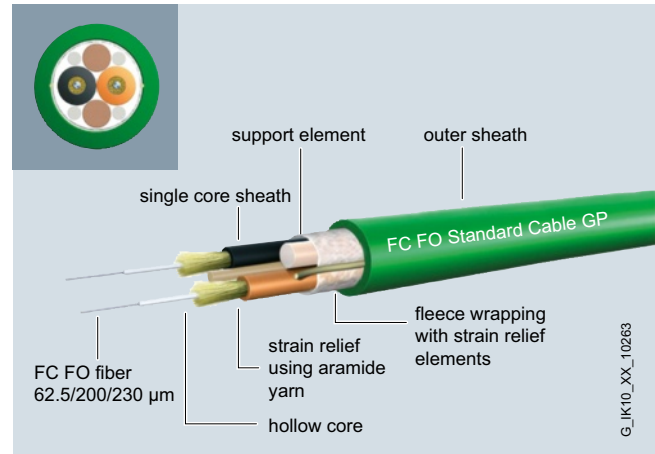

Cable construction FC glass optical fiber

The kit is available in an assembly case for on-site installation of FC SC and FC BFOC connectors on FC glass fiber-optic cables.

It consists of a stripping tool, buffer stripping tool, Kevlar scissors, fiber breaking tool and microscope.

## Ordering data

## Article No.

### FC FO termination kit

Assembly case for local assembly of FC SC and FC BFOC connectors to FC FO standard cable, comprising a stripping tool, Kevlar cutters, fiber breaking tool and microscope

**6GK1900-1GL00-0AA0**

## More information

You can order components supplementary to the SIMATIC NET cabling range from your local contact.

Technical advice on this subject is available from:

J. Hertlein  
 I IA SC CI PRM 4  
 Phone: +49 (911) 750-4465  
 E-mail: [juergen.hertlein@siemens.com](mailto:juergen.hertlein@siemens.com)

## PROFINET/Industrial Ethernet

### Cabling technology

#### Overview of FOCs

#### Overview

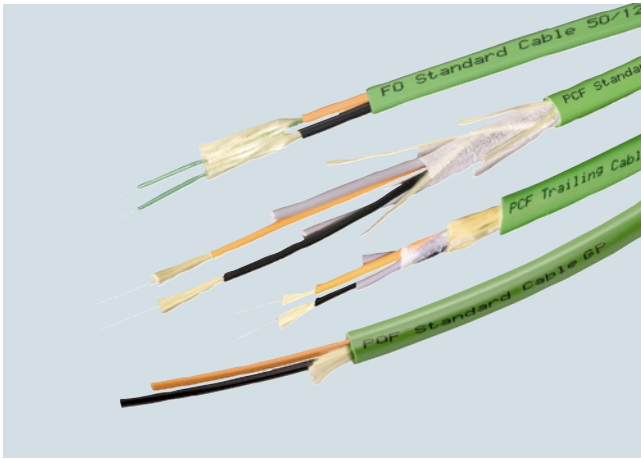

- Optical signal transmission
- No radiation along the cable
- Unaffected by external noise fields
- No grounding problems
- Electrical isolation
- Low weight
- Easy routing

#### Application

The fiber optic (FO) cable is used for transmitting signals with the help of waves in the optical frequency range. The light beam is guided by total reflection at the transition from core to cladding which has a lower refractive index than the core.

The fiber optic cable is provided with a protective coating. The term "fiber" is often also used for fiber-optic cables (FOC).

#### Design

Fiber-optic cables with glass fibers, PCF fibers (**P**olymer **C**ladded **F**iber) and POF fibers (**P**olymer **O**ptical **F**iber) are offered for Industrial Ethernet:

- Glass fiber-optic cable; duplex cable for fiber-optic networks indoors and outdoors
- POF fiber-optic cable; Duplex cable for POF networks in the indoor area
- PCF fiber-optic cable; duplex cable for PCF networks indoors and outdoors

Sheath material	Application
PVC	Standard use in indoor and outdoor areas of industrial applications
PUR	Highly mobile applications (tow chains) for high mechanical or chemical stress in harsh industrial environments
PE	Routing of cables in moist areas indoors and outdoors, and for direct burying in earth
FRNC	Standard applications with high fire protection requirements

#### Approvals

UL listing (safety standard) for network cables is especially necessary for the American and Canadian markets. The requirements for the appropriate approvals depend on where the cable is routed within the building. This applies to all cables which have to be routed from a machine to a remote control cabinet and are positioned on cable racks secured in the building. These cables are identified by the suffix "GP" (general purpose) in the product name and have the corresponding UL approvals.

#### Product overview

##### PROFINET fiber optic, PCF and POF cable

		PROFINET Type B	PROFINET Type C
		fixed or flexible cable depending on cable design	extremely flexible, continuous movement, vibrations or torsion loading, also for special applications
<b>Fiber Optic Cable</b>	<b>2x 50/125µ</b>		
<u>FO Standard Cable GP</u> 6XV1 873-2A		—	•
<u>FO FRNC Cable</u> 6XV1 873-2B		•	—
<u>FO Trailing Cable</u> 6XV1 873-2C		—	•
<u>FO TP Trailing Cable GP</u> 6XV1 873-2D		—	•
<u>FO Ground Cable</u> 6XV1873-2G		—	•
<u>FO Robust Cable GP</u>		—	•
<u>FO Robust Cable GP</u>	<b>4x 9/125/900µ</b>	—	—
<b>PCF Cable</b>	<b>2x 200/230µ</b>		
<u>PCF Standard Cable GP</u> 6XV1 861-2A		•	—
<u>PCF Tailing Cable</u> 6XV1 861-2C		•	—
<u>PCF Tailing Cable GP</u> 6XV1 861-2C		•	—
<b>POF Cable</b>	<b>2x 980/1 000µ</b>		
<u>POF Standard Cable GP</u> 6XV1 874-2A		•	—
<u>POF Trailing Cable</u> 6XV1 874-2B		—	•

## Overview

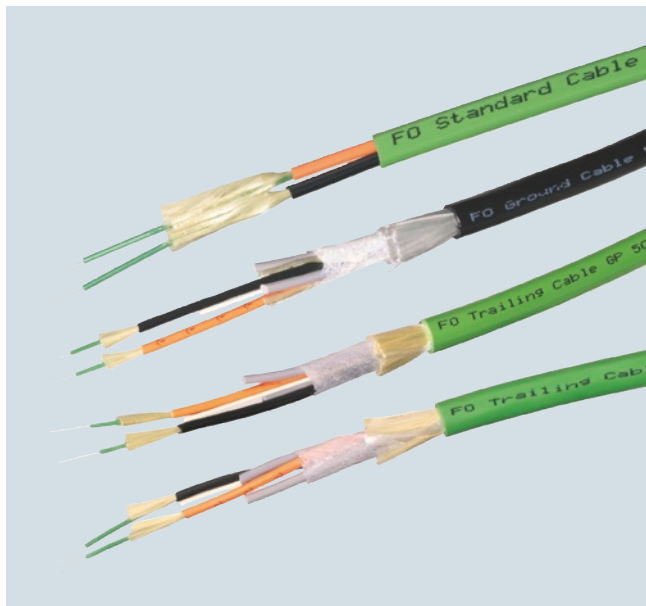

- Used for the optical Industrial Ethernet and PROFIBUS networks
- Rugged design for industrial applications indoors and outdoors
- Halogen-free design for installation inside buildings
- Trailing cable for the special application of forced motion control
- High immunity to noise thanks to insensitivity to electro-magnetic fields
- Available preassembled
- Extensive approvals (UL)

## Benefits

**get** Designed for Industry

- Easy routing with
  - Pre-assembled cables
  - No grounding problems
  - Very light fiber-optic cable
- Tap-proof due to lack of radiation from the cable
- Silicon-free; therefore suitable for use in the automotive industry (e.g. on paint shop conveyors)

## Application

### Marine duplex FOC SIENOPYR

Halogen-free, non-crush, flame-retardant, marine-approved fiber-optic cable for permanent installation on ships and offshore platforms indoors and on open deck. Sold by the meter

### Fiber-optic indoor cable

Halogen-free fiber-optic cable, non-crush, flame-retardant, for installation inside buildings (e.g. in production halls and in building automation). Supplied in fixed lengths, pre-assembled with four BFOC connectors.

### Standard FOC/FRNC cable

Fiber-optic cables for the following application areas indoors and outdoors

- For routing above ground
- For installation inside buildings.

Sold by the meter and in fixed lengths, pre-assembled with four BFOC connectors or four SC connectors.

### Fiber-optic trailing cable

Fiber-optic cables for the special application of forced motion control, such as in continuously moving machine parts (in trailing cables) indoors and outdoors. Two cable variants are available for this application:

- FO Trailing Cable; Cable for high mechanical stress, PUR outer sheath, no UL approval
- FO Trailing Cable GP (general purpose); Cable for low mechanical stress, PVC outer sheath, with UL approval

Sold by the meter and in fixed lengths, pre-assembled with four BFOC connectors or four SC connectors.

### Fiber-optic outdoor cable

Waterproof cable (lengthwise and sideways) for use outdoors with non-metallic protection against rodents for laying into the ground.

Sold by the meter and in fixed lengths, pre-assembled with four BFOC connectors or four SC connectors.

### Note:

Special tools and specially trained personnel are required for pre-assembling glass fiber-optic cables

# PROFINET/Industrial Ethernet

## Cabling technology

### Glass fiber-optic cables

#### Application (continued)

#### Application examples

2

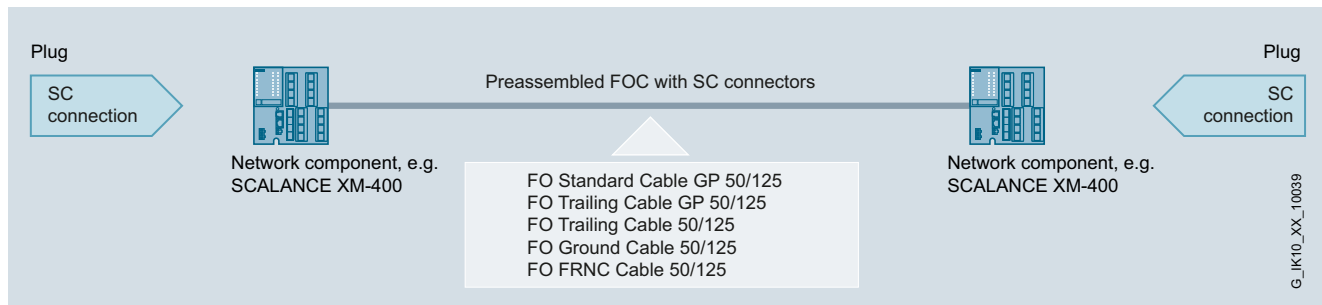

Use of pre-assembled fiber-optic cables with SC connectors (1 000 Mbit/s)

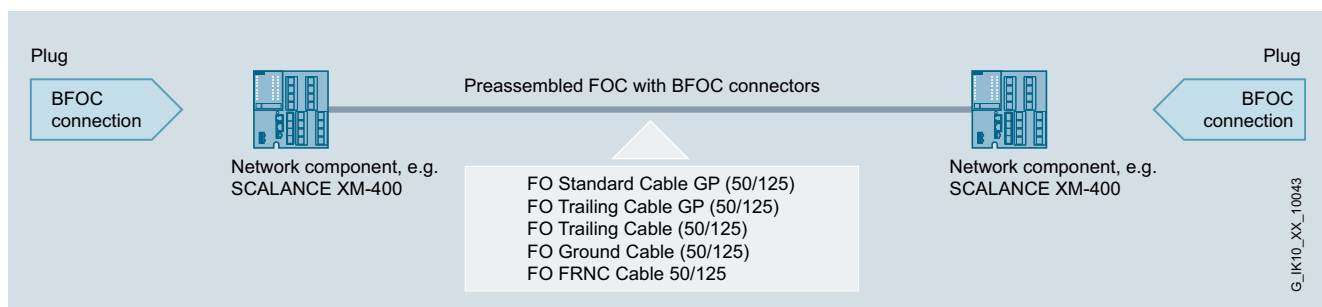

Use of pre-assembled fiber-optic cables with BFOC connectors (100 Mbit/s)

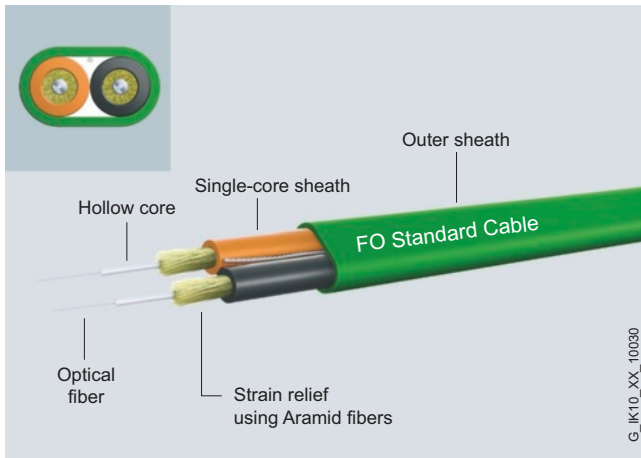
**Design**

The following types of cable are available:

- 100Base FX;  
62.5/125  $\mu\text{m}$  fiber, 4 000 m
- 100Base FX;  
50/125  $\mu\text{m}$  fiber, 5 000 m
- 100Base FX;  
9/125  $\mu\text{m}$  fiber, 26 000 m
- 1000Base SX;  
50/125  $\mu\text{m}$  fiber, 750 m
- 1000Base LX;  
50/125  $\mu\text{m}$  fiber, 2 000 m
- 1000Base LX;  
9/125  $\mu\text{m}$  fiber, 10 000 m
- 10GBASE-SR;  
62.5/125  $\mu\text{m}$  fiber, 26 m;  
50/125  $\mu\text{m}$  OM2 fiber 82 m;  
50/125  $\mu\text{m}$  OM3 fiber 300 m
- 10GBASE-LR;  
9/125  $\mu\text{m}$  fiber, 10 000 m;
- 10GBASE-ER;  
9/125  $\mu\text{m}$  fiber, 40 000 m;

The distances that can be spanned by cables depend on the device-specific wavelength.

In the respective applications, the maximum cable lengths must be taken into account. Passive connection of different fiber types is not permissible. The use of 50  $\mu\text{m}$  fiber is recommended for future installations due to the greater range of gigabit Ethernet. Use of the 62.5  $\mu\text{m}$  fiber is only recommended for existing network installations. In order to span very long distances, the use of singlemode cables with a 9  $\mu\text{m}$  fiber is recommended.

Cable types	50/125 $\mu\text{m}$	62.5/125 $\mu\text{m}$	9/125 $\mu\text{m}$
FO standard cable GP (50/125/1 400)	•	–	–
FO FRNC cable (50/125/1 400)	•	–	–
FO trailing cable (50/125/1 400)	•	–	–
FO trailing cable GP (50/125/1 400)	•	–	–
FO ground cable (50/125/1 400)	•	–	–
FO robust cable GP (50/125/900)	•	–	–
Fiber-optic standard cable (62.5/125/900)	–	•	–
INDOOR fiber-optic cable (62.5/125/900)	–	•	–
Flexible fiber-optic trailing cable (62.5/125/1 400)	–	•	–
SIENOPYR marine duplex fiber-optic cable (62.5/125/900)	–	•	–
FO robust cable GP (4E9/125/900)	–	–	•

# PROFINET/Industrial Ethernet

## Cabling technology

### Glass fiber-optic cables

#### Technical specifications

Article No.	6XV1873-2A	6XV1873-2B	6XV1873-2G
Product-type designation	FO Standard Cable GP	FO FRNC Cable GP	FO Ground Cable
Product description	Glass fiber-optic cable, sold by the meter, unassembled	Glass fiber-optic cable, sold by the meter, unassembled	Glass fiber-optic cable, sold by the meter, unassembled
Acceptability for application	Cable for indoor and outdoor use, UL approval	Halogen-free cable for indoor and outdoor use, for fixed installation, UL approval	Cable with longitudinal and lateral water tightness with non-metallic protection against rodents for outdoor use and for direct laying in soil.
Version of the assembled FO cable	can be assembled with four BFOC or SC connectors	can be assembled with four BFOC or SC connectors	can be assembled with four BFOC or SC connectors
Cable designation	AT-W(ZN)YY 2x1 G 50/125	AT-W(ZN)HH 2G 50/125 UV	AT-WQ(ZN)Y(ZN)B2Y 2G 50/125
<b>Optical data</b>			
Damping ratio per length			
• at 850 nm maximum	2.7 dB/km	2.7 dB/km	2.7 dB/km
• at 1 300 nm maximum	0.7 dB/km	0.7 dB/km	0.7 dB/km
Bandwidth length product			
• at 850 nm	600 GHz·m	600 GHz·m	600 GHz·m
• at 1 300 nm	1 200 GHz·m	1 200 GHz·m	1 200 GHz·m
<b>Mechanical data</b>			
Number of fibers per FOC core	1	1	1
Number of FOC cores per FOC cable	2	2	2
Version of the FO conductor fiber	Multi-mode gradient fiber 50/125 µm, OM 2	Multi-mode gradient fiber 50/125 µm, OM 2	Multi-mode gradient fiber 50/125 µm, OM 2
Design of the FOC core	Hollow core, filled, diameter 1400 µm	Hollow core, filled, diameter 1400 µm	Hollow core, filled, diameter 1400 µm
Design of the fiber-optic cable	Segmentable	Segmentable	Segmentable
Outer diameter			
• of optical fibers	50 µm	50 µm	50 µm
• of the optical fiber sheath	125 µm	125 µm	125 µm
• of the FOC core sheath	2.9 mm	2.9 mm	2.9 mm
• of the cable	-	9.2 mm	10.5 mm
Symmetrical deviation			
• of the outer diameter of the FOC core sheath	0.1 mm	0.1 mm	0.1 mm
• of the outer diameter of the line	-	0.3 mm	0.5 mm
Width of the cable sheath	7.4 mm	-	-
Thickness of the cable sheath	4.5 mm	-	-
Material			
• of the fiber-optic cable core	Quartz glass	Quartz glass	Quartz glass
• of the optical fiber sheath	Quartz glass	Quartz glass	Quartz glass
• of the FOC core sheath	PVC	FRNC	PVC
• of the fiber-optic cable sheath	PVC	FRNC	PE
• of the strain relief	Aramide fibers	Aramide fibers	Aramide fibers
Color			
• of the FOC core sheath	orange / black	orange / black	orange / black
• of the cable sheath	green	green	black
Bending radius			
• with single bend	45 mm	90 mm	105 mm
• minimum permissible			
• with multiple bends	65 mm	135 mm	155 mm
• minimum permissible			
Traction stress maximum	500 N	500 N	800 N
Short-term shear force per length	600 N/cm	500 N/cm	500 N/cm
Continuous lateral force per length	400 N/cm	-	300 N/cm
Weight per length	40 kg/km	85 kg/km	90 kg/km

**Technical specifications** (continued)

Article No.	6XV1873-2A	6XV1873-2B	6XV1873-2G
Product-type designation	FO Standard Cable GP	FO FRNC Cable GP	FO Ground Cable
<b>Permitted ambient conditions</b>			
Ambient temperature			
• during operating	-25 ... +80 °C	-40 ... +85 °C	-40 ... +85 °C
• during storage	-25 ... +80 °C	-40 ... +85 °C	-40 ... +85 °C
• during transport	-25 ... +80 °C	-40 ... +85 °C	-40 ... +85 °C
• during installation	-5 ... +50 °C	-5 ... +50 °C	-5 ... +50 °C
Burning behaviour	Flame-retardant in accordance with IEC 60332-1-2 and IEC 60332-3-22 (Cat. A)	Flame-retardant in accordance with IEC 60332-1-2 and IEC 60332-3-22 (Cat. A)	Flammable
Chemical resistance			
• to mineral oil	Conditional resistance	Conditional resistance	resistant
• to grease	Conditional resistance	Conditional resistance	resistant
• to water	Conditional resistance	Conditional resistance	resistant
Radiological resistance to UV radiation	resistant	resistant	resistant
<b>Product properties, functions, components general</b>			
Product feature			
• halogen-free	No	Yes	No
• silicon-free	Yes	Yes	Yes
Product component	No	No	Yes
Rodent protection			
Cable length for glass FOC			
• for 100BaseFX for Industrial Ethernet maximum	5 000 m	5 000 m	5 000 m
• for 1000BaseSX for Industrial Ethernet maximum	750 m	750 m	750 m
• for 1000BaseLX for Industrial Ethernet maximum	2 000 m	2 000 m	2 000 m
• for PROFIBUS maximum	3 000 m	3 000 m	3 000 m
<b>Standards, specifications, approvals</b>			
Verification of suitability	UL approval: OFN (NEC Article 770, UL 1651) / CSA approval: OFN 90 Cel, FT1, FT4 (CSA standard C22.2 No232-M1988)	UL approval: OFN (NEC Article 770, UL 1651) / CSA approval: OFN (CSA standard C22.2 No232-M1988)	-
• RoHS conformity	Yes	Yes	Yes

## PROFINET/Industrial Ethernet

### Cabling technology

#### Glass fiber-optic cables

#### Technical specifications (continued)

Article No.	6XV1873-2C	6XV1873-2D
Product-type designation	FO Trailing Cable	FO Trailing Cable GP
Product description	Glass fiber-optic cable, sold by the meter, unassembled	Glass fiber-optic cable, sold by the meter, unassembled
Acceptability for application	Flexible cable for use in trailing cables with high mechanical stress, without UL approval	Flexible cable for use in trailing cables with high mechanical stress, UL approval
Version of the assembled FO cable	can be assembled with four BFOC or SC connectors	can be assembled with four BFOC or SC connectors
Cable designation	AT-W(ZN)Y(ZN)11Y 2G 50/125	AT-W(ZN)Y(ZN)Y 2G 50/125
<b>Optical data</b>		
Damping ratio per length		
• at 850 nm maximum	2.7 dB/km	2.7 dB/km
• at 1 300 nm maximum	0.7 dB/km	0.7 dB/km
Bandwidth length product		
• at 850 nm	600 GHz·m	600 GHz·m
• at 1 300 nm	1 200 GHz·m	1 200 GHz·m
<b>Mechanical data</b>		
Number of fibers per FOC core	1	1
Number of FOC cores per FOC cable	2	2
Version of the FO conductor fiber	Multi-mode gradient fiber 50/125 µm, OM 2	Multi-mode gradient fiber 50/125 µm, OM 2
Design of the FOC core	Hollow core, filled, diameter 1 400 µm	Hollow core, filled, diameter 1 400 µm
Design of the fiber-optic cable	Segmentable	Segmentable
Outer diameter		
• of optical fibers	50 µm	50 µm
• of the optical fiber sheath	125 µm	125 µm
• of the FOC core sheath	2.9 mm	2.9 mm
• of the cable	10.5 mm	10.5 mm
Symmetrical deviation		
• of the outer diameter of the FOC core sheath	0.1 mm	0.1 mm
• of the outer diameter of the line	0.5 mm	0.5 mm
Material		
• of the fiber-optic cable core	Quartz glass	Quartz glass
• of the optical fiber sheath	Quartz glass	Quartz glass
• of the FOC core sheath	PVC	PVC
• of the fiber-optic cable sheath	PUR	PVC
• of the strain relief	Aramide fibers	Aramide fibers
Color		
• of the FOC core sheath	orange / black	orange / black
• of the cable sheath	green	green
Bending radius		
• with single bend minimum permissible	150 mm	150 mm
• with multiple bends minimum permissible	200 mm	200 mm
Number of bending cycles	5 000 000	3 500 000
Traction stress maximum	800 N	800 N
Short-term shear force per length	700 N/cm	700 N/cm
Continuous lateral force per length	400 N/cm	400 N/cm
Weight per length	90 kg/km	90 kg/km



**Technical specifications** (continued)

Article No.	6XV1873-2C	6XV1873-2D
Product-type designation	FO Trailing Cable	FO Trailing Cable GP
<b>Permitted ambient conditions</b>		
Ambient temperature		
• during operating	-40 ... +80 °C	-25 ... +80 °C
• during storage	-40 ... +80 °C	-25 ... +80 °C
• during transport	-40 ... +80 °C	-25 ... +80 °C
• during installation	-5 ... +50 °C	-5 ... +50 °C
Burning behaviour	flammable	flame-retardant in accordance with IEC 60332-1-2 and IEC 60332-3-22 (Cat. A)
Chemical resistance		
• to mineral oil	resistant	Conditional resistance
• to grease	resistant	Conditional resistance
• to water	Conditional resistance	Conditional resistance
Radiological resistance to UV radiation	resistant	resistant
<b>Product properties, functions, components general</b>		
Product feature		
• halogen-free	No	No
• silicon-free	Yes	Yes
Product component Rodent protection	No	No
Cable length for glass FOC		
• for 100BaseFX for Industrial Ethernet maximum	5 000 m	5 000 m
• for 1000BaseSX for Industrial Ethernet maximum	750 m	750 m
• for 1000BaseLX for Industrial Ethernet maximum	2 000 m	2 000 m
• for PROFIBUS maximum	3 000 m	3 000 m
<b>Standards, specifications, approvals</b>		
Verification of suitability	-	UL approval: OFN (NEC Article 770, UL 1651) / CSA approval: OFN 90 °C, FT1, FT4 (CSA standard C22.2 No. 232-M1988)
• RoHS conformity	Yes	Yes

## PROFINET/Industrial Ethernet

### Cabling technology

#### Glass fiber-optic cables

#### Technical specifications (continued)

Article No.	6XV1820-5AH10	6XV1820-7AH10
Product-type designation	Fiber optic standard cable	INDOOR fiber optic indoor cable
Product description	Flexible glass fiber-optic cable, sold by the meter, unassembled	Glass fiber-optic cable, sold by the meter, unassembled
Acceptability for application	Cable for indoor and outdoor use	Crush-resistant, halogen-free and flame-retardant cable for indoor use
Version of the assembled FO cable	can be assembled with four BFOC connectors	can be assembled with four BFOC connectors
Cable designation	AT-V(ZN)YY 2X1 G 62.5/125	I-V(ZN)HH 2x1 G 62.5/125
<b>Optical data</b>		
Damping ratio per length		
• at 850 nm maximum	3.1 dB/km	3.1 dB/km
• at 1 300 nm maximum	0.8 dB/km	0.8 dB/km
Bandwidth length product		
• at 850 nm	200 GHz·m	200 GHz·m
• at 1 300 nm	600 GHz·m	600 GHz·m
<b>Mechanical data</b>		
Number of fibers per FOC core	1	1
Number of FOC cores per FOC cable	2	2
Version of the FO conductor fiber	Multimode graded-index fiber 62,5/125 µm, OM 1	Multimode graded-index fiber 62,5/125 µm, OM 1
Design of the FOC core	Compact core, diameter 900 µm	Solid core, diameter 900 µm
Design of the fiber-optic cable	Segmentable outer conductor	Segmentable inner conductor
Outer diameter		
• of optical fibers	62.5 µm	62.5 µm
• of the optical fiber sheath	125 µm	125 µm
• of the FOC core sheath	3.5 mm	2.9 mm
Symmetrical deviation		
• of the outer diameter of the FOC core sheath	-	0,1 mm
Width of the cable sheath	9.8 mm	6.8 mm
Thickness of the cable sheath	6.3 mm	3.9 mm
Material		
• of the fiber-optic cable core	Quartz glass	Quartz glass
• of the optical fiber sheath	Quartz glass	Quartz glass
• of the FOC core sheath	PVC	FRNC
• of the fiber-optic cable sheath	PVC	FRNC
• of the strain relief	Aramide fibers with additionally integrated compression protection elements	Aramide fibers
Color		
• of the FOC core sheath	Gray	Gray
• of the cable sheath	Black	Orange
Bending radius		
• with single bend minimum permissible	80 mm	30 mm
• with multiple bends minimum permissible	80 mm	50 mm
Traction stress maximum	1 500 N	200 N
Short-term shear force per length	-	300 N/cm
Continuous lateral force per length	200 N/cm	100 N/cm
Weight per length	70 kg/km	30 kg/km

**Technical specifications** (continued)

Article No.	6XV1820-5AH10	6XV1820-7AH10
Product-type designation	Fiber optic standard cable	INDOOR fiber optic indoor cable
<b>Permitted ambient conditions</b>		
Ambient temperature		
• during operating	-40 ... +85 °C	-20 ... +60 °C
• during storage	-40 ... +85 °C	-25 ... +70 °C
• during transport	-40 ... +85 °C	-25 ... +70 °C
• during installation	-5 ... +50 °C	-5 ... +50 °C
Burning behaviour	Flame-retardant in accordance with IEC 60332-1-2 and IEC 60332-3-22 (Cat. A)	Flame-retardant in accordance with IEC 60332-1-2 and IEC 60332-3-22 (Cat. A)
Chemical resistance		
• to mineral oil	not resistant	not resistant
• to grease	not resistant	not resistant
• to water	Conditional resistance	Conditional resistance
Radiological resistance to UV radiation	resistant	not resistant
<b>Product properties, functions, components general</b>		
Product feature		
• halogen-free	No	Yes
• silicon-free	Yes	Yes
Product component	No	No
Rodent protection		
Cable length for glass FOC		
• for 100BaseFX for Industrial Ethernet maximum	4 000 m	4 000 m
• for 1000BaseSX for Industrial Ethernet maximum	350 m	350 m
• for 1000BaseLX for Industrial Ethernet maximum	550 m	550 m
• for PROFIBUS maximum	3 000 m	3 000 m
<b>Standards, specifications, approvals</b>		
Verification of suitability		
• RoHS conformity	Yes	Yes

## PROFINET/Industrial Ethernet

### Cabling technology

#### Glass fiber-optic cables

#### Technical specifications (continued)

Article No.	6XV1820-6AH10	6XV1830-0NH10
<b>Product-type designation</b>	<b>Flexible fiber optic trailing cable</b>	<b>SIENOPYR marine duplex fiber-optic cable</b>
Product description	Flexible glass fiber-optic cable, sold by the meter, unassembled	Glass fiber-optic cable SIENOPYR marine cable, sold by the meter, unassembled
Acceptability for application	Flexible cable for indoor and outdoor use in trailing cables	For fixed installation on ships and offshore units, in all rooms and exposed decks, marine approval assigned
Version of the assembled FO cable	can be assembled with four BFOC connectors	can be assembled with four BFOC connectors
Cable designation	AT-W11Y(ZN)11Y 2 G 62.5/125	MI-VHH 2G 62.5/125 3.1B200 + 0.8F600 + 2x1Cu 300V
<b>Optical data</b>		
Damping ratio per length		
• at 850 nm maximum	3.1 dB/km	3.1 dB/km
• at 1 300 nm maximum	0.8 dB/km	0.8 dB/km
Bandwidth length product		
• at 850 nm	200 GHz·m	200 GHz·m
• at 1 300 nm	600 GHz·m	600 GHz·m
<b>Mechanical data</b>		
Number of fibers per FOC core	1	1
Number of FOC cores per FOC cable	2	2
Version of the FO conductor fiber	Multimode graded-index fiber 62,5/125 µm, OM 1	Multimode graded-index fiber 62.5/125 µm, OM 2
Design of the FOC core	Hollow core, filled, diameter 1 400 µm	Solid core
Design of the fiber-optic cable	Segmentable outer conductor	Segmentable outer conductor
Outer diameter		
• of optical fibers	62.5 µm	62.5 µm
• of the optical fiber sheath	125 µm	125 µm
• of the FOC core sheath	3.5 mm	2.9 mm
• of the cable	12.9 mm	13.3 mm
Symmetrical deviation		
• of the outer diameter of the line	-	0.5 mm
Material		
• of the fiber-optic cable core	Quartz glass	Mineral glass
• of the optical fiber sheath	Quartz glass	-
• of the FOC core sheath	PUR	Polyolefine
• of the fiber-optic cable sheath	PUR	SHF1 mixture
• of the strain relief	Aramide fibers, plus central element made of glass-reinforced plastic	Aramide fibers
Color		
• of the FOC core sheath	Black	-
• of the cable sheath	Black	Black
Bending radius		
• with single bend minimum permissible	150 mm	133 mm
• with multiple bends minimum permissible	150 mm	266 mm
Number of bending cycles	100 000	-
Traction stress maximum	1 000 N	250 N
Weight per length	130 kg/km	220 kg/km

**Technical specifications** (continued)

Article No.	6XV1820-6AH10	6XV1830-0NH10
Product-type designation	Flexible fiber optic trailing cable	SIENOPYR marine duplex fiber-optic cable
<b>Permitted ambient conditions</b>		
Ambient temperature		
• during operating	-30 ... +60 °C	-40 ... +80 °C
• during storage	-30 ... +70 °C	-40 ... +80 °C
• during transport	-30 ... +70 °C	-40 ... +80 °C
• during installation	-30 ... +60 °C	-10 ... +50 °C
Ambient condition for (standard) operation mode	-	At ambient temperatures below -10 degrees Celsius, the cable must not be subjected to any movements other than the normal vibration levels encountered on board ship
Burning behaviour	Flammable	Flame-retardant in accordance with IEC 60332-3 (Cat. A)
Chemical resistance		
• to mineral oil	resistant	-
• to grease	resistant	-
• to water	Conditional resistance	Conditional resistance
Radiological resistance to UV radiation	resistant	resistant
<b>Product properties, functions, components general</b>		
Product feature		
• halogen-free	Yes	Yes
• silicon-free	Yes	Yes
Product component Rodent protection	No	No
Cable length for glass FOC		
• for 100BaseFX for Industrial Ethernet maximum	4 000 m	4 000 m
• for 1000BaseSX for Industrial Ethernet maximum	350 m	350 m
• for 1000BaseLX for Industrial Ethernet maximum	550 m	550 m
• for PROFIBUS maximum	3 000 m	3 000 m
<b>Standards, specifications, approvals</b>		
Verification of suitability	-	-
• RoHS conformity	Yes	Yes
Marine classification association		
• Bureau Veritas (BV)	-	Yes
• Germanische Lloyd (GL)	-	Yes
• Lloyds Register of Shipping (LRS)	-	Yes

## PROFINET/Industrial Ethernet

### Cabling technology

#### Glass fiber-optic cables

#### Technical specifications (continued)

Article No.	6XV1873-2R	6XV1843-2R
Product-type designation	MM FO Robust Cable GP	SM FO robust cable GP
Product description	Glass fiber-optic cable, sold by the meter, unassembled	Glass fiber-optic cable, sold by the meter, unassembled
Acceptability for application	Cable with longitudinal and lateral water tightness with non-metallic protection against rodents for outdoor and indoor use and for direct laying in soil	Cable with longitudinal and lateral water tightness with non-metallic protection against rodents for outdoor and indoor use and for direct laying in soil
Version of the assembled FO cable	can be assembled with the BFOC, SC and LC duplex plugs	can be assembled with the BFOC, SC and LC duplex plugs
Cable designation	AT-V(ZN)H(ZN)BH 2G50/125	AT-V(ZN)H(ZN)BH 4E9/125
<b>Optical data</b>		
Damping ratio per length		
• at 850 nm maximum	2.7 dB/km	-
• at 1 300 nm maximum	1 dB/km	0.5 dB/km
• at 1 550 nm maximum	-	0.5 dB/km
Bandwidth length product		
• at 850 nm	600 GHz·m	-
• at 1 300 nm	1 200 GHz·m	-
<b>Mechanical data</b>		
Number of fibers per FOC core	1	1
Number of FOC cores per FOC cable	2	4
Version of the FO conductor fiber	Multi-mode gradient fiber 50/125/245 µm, OM2	Single mode fiber 4E9/125/900, OS1 and OS2
Design of the FOC core	Solid core, diameter 900 µm	Solid core, diameter 900 µm
Design of the fiber-optic cable	Segmentable	Segmentable
Outer diameter		
• of optical fibers	50 µm	9 µm
• of the optical fiber sheath	125 µm	125 µm
• of the FOC core sheath	2.2 mm	2.2 mm
• of the cable	7.5 mm	9 mm
Material		
• of the fiber-optic cable core	Quartz glass	Quartz glass
• of the optical fiber sheath	Quartz glass	Quartz glass
• of the FOC core sheath	PE flame retardant	PE flame retardant
• of the fiber-optic cable sheath	PE flame retardant	PE flame retardant
• of the strain relief	Aramide fibers and glass roving	Aramide fibers, plus central support element and glass roving
Color		
• of the FOC core sheath	orange / black, with directional arrow	orange / black, with directional arrow (numbering of the core pairs with 1 and 2)
• of the cable sheath	Black	Black
Bending radius		
• with single bend minimum permissible	25 mm	90 mm
• with multiple bends minimum permissible	40 mm	135 mm
Traction stress maximum	1 000 N	1 000 N
Short-term shear force per length	600 N/cm	600 N/cm
Continuous lateral force per length	200 N/cm	200 N/cm
Weight per length	67 kg/km	87 kg/km

**Technical specifications** (continued)

Article No.	6XV1873-2R	6XV1843-2R
Product-type designation	MM FO Robust Cable GP	SM FO robust cable GP
<b>Permitted ambient conditions</b>		
Ambient temperature		
• during operating	-40 ... +70 °C	-40 ... +70 °C
• during storage	-40 ... +70 °C	-40 ... +70 °C
• during transport	-40 ... +70 °C	-40 ... +70 °C
• during installation	-20 ... +60 °C	-20 ... +60 °C
Burning behaviour	Flame-retardant in accordance with IEC 60332-3-24	Flame-retardant in accordance with IEC 60332-3-24
Chemical resistance		
• to mineral oil	Conditional resistance	Conditional resistance
• to grease	Conditional resistance	Conditional resistance
• to water	resistant	resistant
Radiological resistance to UV radiation	resistant	resistant
<b>Product properties, functions, components general</b>		
Product feature		
• halogen-free	Yes	Yes
• silicon-free	Yes	Yes
Product component Rodent protection	Yes	Yes
Cable length for glass FOC		
• for 100BaseFX for Industrial Ethernet maximum	5 000 m	26 000 m
• for 1000BaseSX for Industrial Ethernet maximum	750 m	-
• for 1000BaseLX for Industrial Ethernet maximum	2 000 m	5 000 m
• for PROFIBUS maximum	3 000 m	15 000 m
<b>Standards, specifications, approvals</b>		
Verification of suitability		
• RoHS conformity	Yes	Yes

# PROFINET/Industrial Ethernet

## Cabling technology

### Glass fiber-optic cables

#### Technical specifications (continued)

<b>Article No.</b>	<b>6GK1901-0DA20-0AA0</b>
<b>Product-type designation</b>	<b>BFOC Connector Set</b>
Product description	BFOC connector
Acceptability for application	For connection of fiber-optic cables
<b>Transmission rate</b>	
Transfer rate	
• 1 for Industrial Ethernet	10 Mbit/s
• 2 for Industrial Ethernet	100 Mbit/s
• 3 for Industrial Ethernet	1 000 Mbit/s
• with PROFIBUS	9.6 kbit/s ... 12 Mbit/s
<b>Interfaces</b>	
Number of optical interfaces for optical waveguide	1
Design of optical connections for network components or terminal devices	BFOC connector
Design of the electrical connection FastConnect	No
<b>Mechanical data</b>	
Material of the enclosure	Metal and plastic
<b>Design, dimensions and weight</b>	
Type of cable outlet	180 degree cable outlet
Width	10 mm
Height	10 mm
Depth	10 mm
Net weight	8 g
<b>Permitted ambient conditions</b>	
Protection class IP	IP20
<b>Product properties, functions, components general</b>	
Product feature silicon-free	Yes
Product component strain relief	Yes
<b>Standards, specifications, approvals</b>	
Verification of suitability	Yes
RoHS conformity	

#### Ordering data

##### FO standard cable GP 50/125/1400 <sup>2)</sup>

Multimode cable,  
sold by the meter;  
max. delivery unit 1 000 m;  
minimum order 20 m;

Preferred lengths <sup>1)</sup>  
pre-assembled  
with 4 BFOC connectors

- 0.5 m
- 1 m
- 2 m
- 3 m
- 5 m
- 10 m
- 15 m
- 20 m
- 30 m
- 40 m
- 50 m
- 80 m
- 100 m
- 150 m
- 200 m
- 300 m

Preferred lengths <sup>1)</sup>  
pre-assembled  
with 4 SC connectors

- 0.5 m
- 1 m
- 2 m
- 3 m
- 5 m
- 10 m
- 15 m
- 20 m
- 30 m
- 40 m
- 50 m
- 80 m
- 100 m
- 150 m
- 200 m
- 300 m

##### FO FRNC cable 50/125/1 400 <sup>2)</sup>

Multimode cable,  
sold by the meter;  
max. delivery unit 1 000 m;  
minimum order 20 m;

#### Article No.

**6XV1873-2A**

**6XV1873-3AH05**  
**6XV1873-3AH10**  
**6XV1873-3AH20**  
**6XV1873-3AH30**  
**6XV1873-3AH50**  
**6XV1873-3AN10**  
**6XV1873-3AN15**  
**6XV1873-3AN20**  
**6XV1873-3AN30**  
**6XV1873-3AN40**  
**6XV1873-3AN50**  
**6XV1873-3AN80**  
**6XV1873-3AT10**  
**6XV1873-3AT15**  
**6XV1873-3AT20**  
**6XV1873-3AT30**

**6XV1873-6AH05**  
**6XV1873-6AH10**  
**6XV1873-6AH20**  
**6XV1873-6AH30**  
**6XV1873-6AH50**  
**6XV1873-6AN10**  
**6XV1873-6AN15**  
**6XV1873-6AN20**  
**6XV1873-6AN30**  
**6XV1873-6AN40**  
**6XV1873-6AN50**  
**6XV1873-6AN80**  
**6XV1873-6AT10**  
**6XV1873-6AT15**  
**6XV1873-6AT20**  
**6XV1873-6AT30**

**6XV1873-2B**

<sup>1)</sup> Special fiber-optic cables, lengths and accessories available on request

<sup>2)</sup> Special tools and specially trained personnel are required for pre-assembling glass fiber-optic cables



Ordering data	Article No.	Article No.	
<b>FO trailing cable</b> 50/125/1 400 <sup>2)</sup> Multimode cable, <u>sold by the meter</u> ; max. delivery unit 1 000 m; minimum order 20 m; <u>Preferred lengths</u> <sup>1)</sup> <u>pre-assembled</u> with 4 BFOC connectors <ul style="list-style-type: none"> <li>• 3 m</li> <li>• 5 m</li> <li>• 10 m</li> <li>• 20 m</li> <li>• 50 m</li> <li>• 100 m</li> </ul> <u>Preferred lengths</u> <sup>1)</sup> <u>pre-assembled</u> with 4 SC connectors <ul style="list-style-type: none"> <li>• 3 m</li> <li>• 5 m</li> <li>• 10 m</li> <li>• 20 m</li> <li>• 50 m</li> <li>• 100 m</li> </ul>	<b>6XV1873-2C</b>  <b>6XV1873-3CH30</b> <b>6XV1873-3CH50</b> <b>6XV1873-3CN10</b> <b>6XV1873-3CN20</b> <b>6XV1873-3CN50</b> <b>6XV1873-3CT10</b>  <b>6XV1873-6CH30</b> <b>6XV1873-6CH50</b> <b>6XV1873-6CN10</b> <b>6XV1873-6CN20</b> <b>6XV1873-6CN50</b> <b>6XV1873-6CT10</b>	<b>FO robust cable GP</b> 50/125/900 <sup>2)</sup> Multimode cable, <u>sold by the meter</u> ; max. delivery unit 2 000 m; minimum order 20 m; <b>Standard FIBER OPTIC CABLE</b> (62.5/125/900), segmentable <sup>2)</sup> Multimode cable, <u>sold by the meter</u> ; max. delivery unit 2 000 m minimum order 20 m <u>Preferred lengths</u> <sup>1)</sup> <u>pre-assembled</u> with 4 BFOC plugs <ul style="list-style-type: none"> <li>• 1 m</li> <li>• 2 m</li> <li>• 3 m</li> <li>• 4 m</li> <li>• 5 m</li> <li>• 10 m</li> <li>• 15 m</li> <li>• 20 m</li> <li>• 30 m</li> <li>• 40 m</li> <li>• 50 m</li> <li>• 55 m</li> <li>• 60 m</li> <li>• 65 m</li> <li>• 70 m</li> <li>• 75 m</li> <li>• 80 m</li> <li>• 100 m</li> <li>• 120 m</li> <li>• 130 m</li> <li>• 150 m</li> <li>• 200 m</li> <li>• 250 m</li> <li>• 300 m</li> </ul> <b>INDOOR FIBER OPTIC CABLE</b> (62.5/125/900), segmentable <sup>2)</sup> Multimode cable, <u>sold by the meter</u> ; max. delivery unit 2 000 m minimum order 20 m <u>Preferred lengths</u> ; <u>pre-assembled</u> with 4 BFOC connectors <ul style="list-style-type: none"> <li>• 0.5 m</li> <li>• 1 m</li> <li>• 2 m</li> <li>• 3 m</li> <li>• 5 m</li> <li>• 10 m</li> <li>• 15 m</li> <li>• 20 m</li> <li>• 25 m</li> <li>• 50 m</li> <li>• 75 m</li> <li>• 100 m</li> </ul>	<b>6XV1873-2R</b>  <b>6XV1820-5AH10</b>  <b>6XV1820-5BH10</b> <b>6XV1820-5BH20</b> <b>6XV1820-5BH30</b> <b>6XV1820-5BH40</b> <b>6XV1820-5BH50</b> <b>6XV1820-5BN10</b> <b>6XV1820-5BN15</b> <b>6XV1820-5BN20</b> <b>6XV1820-5BN30</b> <b>6XV1820-5BN40</b> <b>6XV1820-5BN50</b> <b>6XV1820-5BN55</b> <b>6XV1820-5BN60</b> <b>6XV1820-5BN65</b> <b>6XV1820-5BN70</b> <b>6XV1820-5BN75</b> <b>6XV1820-5BN80</b> <b>6XV1820-5BT10</b> <b>6XV1820-5BT12</b> <b>6XV1820-5BT13</b> <b>6XV1820-5BT15</b> <b>6XV1820-5BT20</b> <b>6XV1820-5BT25</b> <b>6XV1820-5BT30</b>  <b>6XV1820-7AH10</b>  <b>6XV1820-7BH05</b> <b>6XV1820-7BH10</b> <b>6XV1820-7BH20</b> <b>6XV1820-7BH30</b> <b>6XV1820-7BH50</b> <b>6XV1820-7BN10</b> <b>6XV1820-7BN15</b> <b>6XV1820-7BN20</b> <b>6XV1820-7BN25</b> <b>6XV1820-7BN50</b> <b>6XV1820-7BN75</b> <b>6XV1820-7BT10</b>
<b>FO trailing cable GP</b> 50/125/1 400 <sup>2)</sup> Multimode cable, <u>sold by the meter</u> ; max. delivery unit 1 000 m; minimum order 20 m; <u>Preferred lengths</u> <sup>1)</sup> <u>pre-assembled</u> with 4 BFOC connectors <ul style="list-style-type: none"> <li>• 3 m</li> <li>• 5 m</li> <li>• 10 m</li> <li>• 20 m</li> <li>• 50 m</li> <li>• 100 m</li> </ul> <u>Preferred lengths</u> <sup>1)</sup> <u>pre-assembled</u> with 4 SC connectors <ul style="list-style-type: none"> <li>• 3 m</li> <li>• 5 m</li> <li>• 10 m</li> <li>• 20 m</li> <li>• 50 m</li> <li>• 100 m</li> </ul>	<b>6XV1873-2D</b>  <b>6XV1873-3DH30</b> <b>6XV1873-3DH50</b> <b>6XV1873-3DN10</b> <b>6XV1873-3DN20</b> <b>6XV1873-3DN50</b> <b>6XV1873-3DT10</b>  <b>6XV1873-6DH30</b> <b>6XV1873-6DH50</b> <b>6XV1873-6DN10</b> <b>6XV1873-6DN20</b> <b>6XV1873-6DN50</b> <b>6XV1873-6DT10</b>		
<b>FO ground cable</b> 50/125/1 400 <sup>2)</sup> Multimode cable, <u>sold by the meter</u> ; max. delivery unit 2 000 m; minimum order 20 m; <u>Preferred lengths</u> <sup>1)</sup> <u>pre-assembled</u> with 4 BFOC connectors <ul style="list-style-type: none"> <li>• 100 m</li> <li>• 200 m</li> <li>• 300 m</li> </ul> <u>Preferred lengths</u> <sup>1)</sup> <u>pre-assembled</u> with 4 SC connectors <ul style="list-style-type: none"> <li>• 100 m</li> <li>• 200 m</li> <li>• 300 m</li> </ul>	<b>6XV1873-2G</b>  <b>6XV1873-3GT10</b> <b>6XV1873-3GT20</b> <b>6XV1873-3GT30</b>  <b>6XV1873-6GT10</b> <b>6XV1873-6GT20</b> <b>6XV1873-6GT30</b>		

<sup>1)</sup> Special fiber-optic cables, lengths and accessories available on request

<sup>2)</sup> Special tools and specially trained personnel are required for pre-assembling glass fiber-optic cables



## Overview

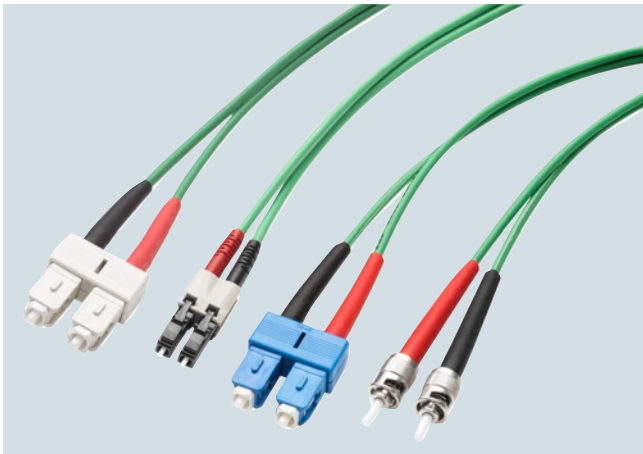

- Patch cables, available as pre-assembled cables (max. length 1 m)
- 2-wire patch cables for directly connecting active network components in the control cabinet
- Small cable diameter for easy laying of cables
- Easy connection of active network components with different fiber-optic interfaces by means of patch cords with two types of connectors

## Benefits

**get** Designed for Industry

- Quick and error-free commissioning thanks to pre-assembled, factory-tested FO patch cables
- Simple cable laying in the control cabinet due to small cable diameter
- Silicone-free, therefore suitable for use in the automotive industry (for example on paint lines)
- Easy connection of active network components with various fiber-optic connection methods in the control cabinet

## Application

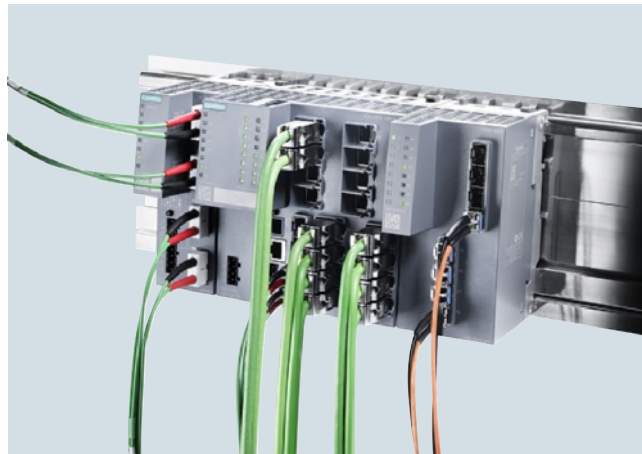

FO Cord SC/SC connecting cable between XC100-4OBR and SCALANCE X320-3LD

## Design

- 2 x 2-wire multimode patch cable with fixed cores and integrated aramid strain relief
- 2 x 2-wire singlemode patch cable with fixed cores and integrated aramid strain relief
- Low-emission and halogen-free outer sheath for use in buildings

The FO Cord is available as a pre-assembled cable in the following versions:

- MM FO Cord SC/SC  
Multimode fiber-optic cable pre-assembled with two SC duplex connectors
- MM FO Cord SC/BFOC  
Multimode fiber-optic cable pre-assembled with one SC duplex connector and two BFOC connectors
- MM FO Cord SC/LC  
Multimode fiber-optic cable pre-assembled with one SC duplex connector and one LC duplex connector
- SM FO Cord SC/SC  
Singlemode fiber-optic cable pre-assembled with two SC duplex connectors
- SM FO Cord SC/BFOC  
Singlemode fiber-optic cable pre-assembled with one SC duplex connector and two BFOC connectors
- SM FO Cord SC/LC  
Singlemode fiber-optic cable pre-assembled with one SC duplex connector and one LC duplex connector

## Function

The flexibility of the cable ensures easy installation, for example in a control cabinet, or to connect equipment in a control room. The length of an IE FO TP Cord is 1 m.

Cable variants with different fiber-optic connectors are used for the easy connecting of devices to various fiber-optic interfaces.

# PROFINET/Industrial Ethernet

## Cabling technology

### IE FO Cords

#### Technical specifications

Article No.	6XV1843-5EH10-0CC0	6XV1843-5EH10-0CB0	6XV1843-5EH10-0CA0
Product-type designation	MM FO CORD SC/SC, 50/125	MM FO CORD SC/BFOC, 50/125	MM FO CORD SC/LC, 50/125
Product description	Multimode glass FO cable, pre-assembled	Multimode glass FO cable, pre-assembled	Multimode glass FO cable, pre-assembled
Acceptability for application	Cable for applications in control cabinet	Cable for applications in control cabinet	Cable for applications in control cabinet
Version of the assembled FO cable	pre-assembled with 2X SC DUPLEX connectors	pre-assembled with 1X SC DUPLEX connector and 1XBFOC connector	pre-assembled with 1X SC DUPLEX connector and 1X LC DUPLEX connector
Cable designation	I-V(ZN)H 2x50/125 OM2	I-V(ZN)H 2x50/125 OM2	I-V(ZN)H 2x50/125 OM2
Cable length	1 m	1 m	1 m
<b>Optical data</b>			
Damping ratio per length			
• at 850 nm maximum	3.5 dB/km	3.5 dB/km	3.5 dB/km
• at 1 300 nm maximum	1.5 dB/km	1.5 dB/km	1.5 dB/km
Bandwidth length product			
• at 850 nm	500 kHz·m	500 kHz·m	500 kHz·m
• at 1 300 nm	1 300 kHz·m	1 300 kHz·m	1 300 kHz·m
<b>Mechanical data</b>			
Number of fibers per FOC core	1	1	1
Number of FOC cores per FOC cable	2	2	2
Version of the FO conductor fiber	Multi-mode gradient fiber 50/125 µm, OM 2	Multi-mode gradient fiber 50/125 µm, OM 2	Multi-mode gradient fiber 50/125 µm, OM 2
Design of the FOC core	fixed cores	fixed cores	fixed cores
Outer diameter			
• of optical fibers	5 µm	5 µm	5 µm
• of the optical fiber sheath	125 µm	125 µm	125 µm
• of the FOC core sheath	2.8 mm	2.8 mm	2.8 mm
Width of the cable sheath	5.9 mm	5.9 mm	5.9 mm
Thickness of the cable sheath	2.8 mm	2.8 mm	2.8 mm
Material			
• of the fiber-optic cable core	Quartz glass	Quartz glass	Quartz glass
• of the optical fiber sheath	Quartz glass	Quartz glass	Quartz glass
• of the FOC core sheath	FR-LSZH	FR-LSZH	FR-LSZH
• of the fiber-optic cable sheath	LSZH	LSZH	LSZH
• of the strain relief	Aramide fibers	Aramide fibers	Aramide fibers
Color			
• of the FOC core sheath	green/green	green/green	green/green
Bending radius			
• with single bend minimum permissible	42 mm	42 mm	42 mm
Traction stress maximum	500 N	500 N	500 N
Continuous lateral force per length	100 N/cm	100 N/cm	100 N/cm
Weight per length	19 kg/km	19 kg/km	19 kg/km
<b>Permitted ambient conditions</b>			
Ambient temperature			
• during operating	-20 ... +70 °C	-20 ... +70 °C	-20 ... +70 °C
• during storage	-25 ... +70 °C	-25 ... +70 °C	-25 ... +70 °C
• during transport	-25 ... +70 °C	-25 ... +70 °C	-25 ... +70 °C
• during installation	-10 ... +70 °C	-10 ... +70 °C	-10 ... +70 °C
Protection class IP	IP20	IP20	IP20
Burning behaviour	Flame-retardant in accordance with IEC 60332-3-22 (CatA)	Flame-retardant in accordance with IEC 60332-3-22 (CatA)	Flame-retardant in accordance with IEC 60332-3-22 (CatA)

**Technical specifications (continued)**

Article No.	6XV1843-5EH10-0CC0	6XV1843-5EH10-0CB0	6XV1843-5EH10-0CA0
<b>Product-type designation</b>	<b>MM FO CORD SC/SC, 50/125</b>	<b>MM FO CORD SC/BFOC, 50/125</b>	<b>MM FO CORD SC/LC, 50/125</b>
<b>Product properties, functions, components general</b>			
Product feature			
• halogen-free	Yes	Yes	Yes
• silicon-free	Yes	Yes	Yes
Product component	No	No	No
Rodent protection			
<b>Standards, specifications, approvals</b>			
Verification of suitability			
• RoHS conformity	Yes	Yes	Yes
Article No.	6XV1843-5FH10-0CC0	6XV1843-5FH10-0CB0	6XV1843-5FH10-0CA0
<b>Product-type designation</b>	<b>SM FO CORD SC/SC, 9/125</b>	<b>SM FO CORD SC/BFOC, 9/125</b>	<b>SM FO CORD SC/LC, 9/125</b>
Product description	Singlemode glass FO cable, pre-assembled	Singlemode glass FO cable, pre-assembled	Singlemode glass FO cable, pre-assembled
Acceptability for application	Cable for applications in control cabinet	Cable for applications in control cabinet	Cable for applications in control cabinet
Version of the assembled FO cable	pre-assembled with 2X2 SC DUPLEX connectors	pre-assembled with 1X SC DUPLEX connector and 1X, BFOC connector	pre-assembled with 1X SC DUPLEX connector and 1X LC DUPLEX connector
Cable designation	I-V(ZN)H 2E9/125 G.652D	I-V(ZN)H 2E9/125 G.652D	I-V(ZN)H 2E9/125 G.652D
Cable length	1 m	1 m	1 m
<b>Optical data</b>			
Damping ratio per length			
• at 1300 nm maximum	0.4 dB/km	0.4 dB/km	0.4 dB/km
• at 1550 nm maximum	0.3 dB/km	0.3 dB/km	0.3 dB/km
<b>Mechanical data</b>			
Number of fibers per FOC core	1	1	1
Number of FOC cores per FOC cable	2	2	2
Version of the FO conductor fiber			
Design of the FOC core			
Outer diameter			
• of optical fibers	9 µm	9 µm	9 µm
• of the optical fiber sheath	125 µm	125 µm	125 µm
• of the FOC core sheath	2.8 mm	2.8 mm	2.8 mm
Width of the cable sheath	5.9 mm	5.9 mm	5.9 mm
Thickness of the cable sheath	2.8 mm	2.8 mm	2.8 mm
Material			
• of the fiber-optic cable core	Quartz glass	Quartz glass	Quartz glass
• of the optical fiber sheath	Quartz glass	Quartz glass	Quartz glass
• of the FOC core sheath	FR-LSZH	FR-LSZH	FR-LSZH
• of the fiber-optic cable sheath	LSZH	LSZH	LSZH
• of the strain relief	Aramide fibers	Aramide fibers	Aramide fibers
Color			
• of the FOC core sheath	green/green	green/green	green/green
Bending radius			
• with single bend minimum permissible	42 mm	42 mm	42 mm
Traction stress maximum	500 N	500 N	500 N
Continuous lateral force per length	100 N/cm	100 N/cm	100 N/cm
Weight per length	19 kg/km	19 kg/km	19 kg/km

## PROFINET/Industrial Ethernet

### Cabling technology

#### IE FO Cords

#### Technical specifications (continued)

Article No.	6XV1843-5FH10-0CC0	6XV1843-5FH10-0CB0	6XV1843-5FH10-0CA0
Product-type designation	SM FO CORD SC/SC, 9/125	SM FO CORD SC/BFOC, 9/125	SM FO CORD SC/LC, 9/125
<b>Permitted ambient conditions</b>			
Ambient temperature			
• during operating	-20 ... +70 °C	-20 ... +70 °C	-20 ... +70 °C
• during storage	-25 ... +70 °C	-25 ... +70 °C	-25 ... +70 °C
• during transport	-25 ... +70 °C	-25 ... +70 °C	-25 ... +70 °C
• during installation	-10 ... +70 °C	-10 ... +70 °C	-10 ... +70 °C
Protection class IP	IP20	IP20	IP20
Burning behaviour	Flame-retardant in accordance with IEC 60332-3-22 (CatA)	Flame-retardant in accordance with IEC 60332-3-22 (CatA)	Flame-retardant in accordance with IEC 60332-3-22 (CatA)
<b>Product properties, functions, components general</b>			
Product feature			
• halogen-free	Yes	Yes	Yes
• silicon-free	Yes	Yes	Yes
Product component Rodent protection	No	No	No
<b>Standards, specifications, approvals</b>			
Verification of suitability			
• RoHS conformity	Yes	Yes	Yes

2

**Ordering data**
**Article No.**
*Multimode*
**MM FO Cord SC/SC**

 With two SC duplex connectors,  
 1 m

**6XV1843-5EH10-0CC0**
**MM FO Cord SC/BFOC**

 With one SC duplex connector and  
 two BFOC connectors, 1 m

**6XV1843-5EH10-0CB0**
**MM FO Cord SC/LC**

 With one SC duplex connector and  
 one LC duplex connector, 1 m

**6XV1843-5EH10-0CA0**
*Singlemode*
**SM FO Cord SC/SC**

 With two SC duplex connectors,  
 1 m

**6XV1843-5FH10-0CC0**
**SM FO Cord SC/BFOC**

 With one SC duplex connector and  
 two BFOC connectors, 1 m

**6XV1843-5FH10-0CB0**
**SM FO Cord SC/LC**

 With one SC duplex connector and  
 one LC duplex connector, 1 m

**6XV1843-5FH10-0CA0**
**More information**

You can order components supplementary to the SIMATIC NET cabling range from your local contact.

Technical advice on this subject is available from:

J. Hertlein  
 I IA SC CI PRM 4  
 Phone: +49 (911) 750-4465  
 E-mail: [juergen.hertlein@siemens.com](mailto:juergen.hertlein@siemens.com)

## PROFINET/Industrial Ethernet

### Cabling technology

#### POF and PCF fiber-optic cables

##### Overview

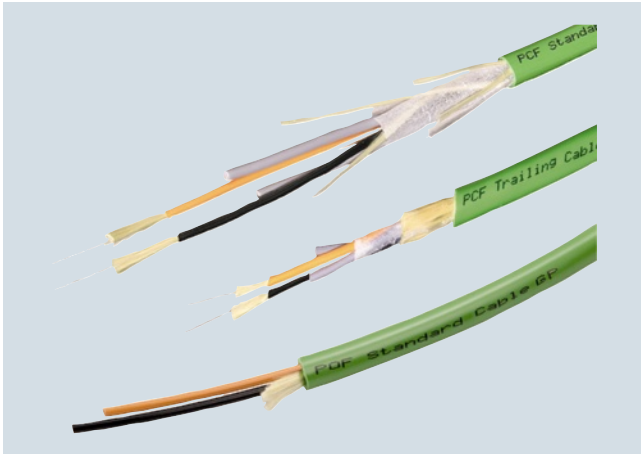

- Electrical isolation of PROFINET/Ethernet devices
- Protection of the transmission path against electromagnetic interference
- Up to 50 m cable length with plastic fiber optic cables and up to 100 m with PCF fiber optic cables
- Rugged fiber-optic standard cables, designed for industrial applications
- Extensive approvals (UL)

##### Benefits



- Plastic and PCF fiber optic cables can be pre-assembled on site
- Easy connector assembly on site
- Time savings on start-up thanks to pre-assembled cables
- Protection of the transmission path against electromagnetic interference
- Tap-proof, because the cable does not radiate

##### Application

SIMATIC NET POF and PCF fiber optic conductors are used to construct optical indoor PROFINET and Industrial Ethernet networks. Devices with integral optical interface (SC RJ connection system) are, for example, SCALANCE X200-4P IRT, SCALANCE X201-3P IRT, SCALANCE X202-2P IRT, SCALANCE X101-1POF and ET 200S.

POF and PCF fiber optic cables can be assembled easily on site with SC RJ plugs. The maximum cable length between two devices is 50 m for POF and 100 m for PCF fiber-optic cables.



## Design

Different types of POF and PCF fiber optic cables are offered:

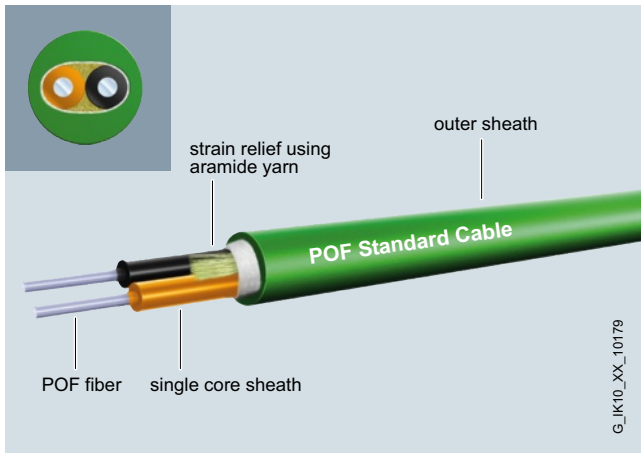

### POF fiber optic cables

Rugged round cables with green outer sheath and Kevlar strain relief elements as well as two plastic fibers with rugged Polyamid inner sheath for applications indoors/outdoors with cable lengths **up to 50 m**. The cables are suitable for assembly in the field.

- **POF Standard Cable GP** (General Purpose); for applications indoor/outdoors
- **POF Trailing Cable**; for trailing cable applications

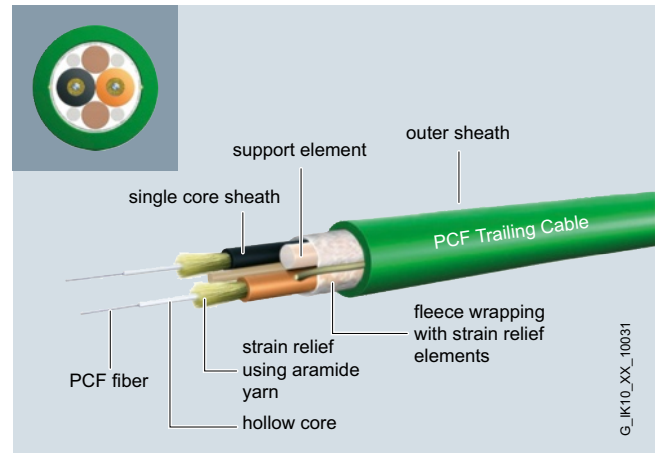

### PCF fiber optic cables

Rugged round cables with green outer sheath and Kevlar strain relief elements for applications indoor/outdoors with cable lengths **up to 100 m**. The cables are suitable for assembly in the field.

- **PCF Standard Cable GP** (General Purpose); for applications indoor/outdoors with cable lengths up to 100 m.
- **PCF fiber-optic trailing cable**; for trailing cable applications with cable lengths of up to 100 m. The cable is suitable for assembly in the field. The following cable versions are available:
  - PCF Trailing Cable; cable for high mechanical stress, PUR outer sheath, no UL approval
  - PCF Trailing Cable GP (general purpose); cable for low mechanical stress, PVC outer sheath, with UL approval

## PROFINET/Industrial Ethernet

### Cabling technology

#### POF and PCF fiber-optic cables

#### Technical specifications

Article No.	6XV1874-2A	6XV1874-2B
Product-type designation	POF Standard Cable GP	POF Trailing Cable
Product description	Fiber-optic cable with polyoptical fiber, sold by the meter, unassembled	Fiber-optic cable with polyoptical fiber, sold by the meter, unassembled
Acceptability for application	Cable for fixed installation indoors, UL approval	Cable for moving applications (e.g. trailing cables)
Version of the assembled FO cable	can be assembled with SC RJ or SC RJ Plug PRO connectors	can be assembled with SC RJ or SC RJ Plug PRO connectors
Cable designation	I-V4Y(ZN)Y 2P 980/1 000	I-V4Y(ZN)11Y 2P 980/1 000 FLEX UL
<b>Optical data</b>		
Damping ratio per length at 650 nm maximum	0.16 dB/m	0.18 dB/m
Bandwidth length product at 650 nm	1 GHz·m	1 GHz·m
<b>Mechanical data</b>		
Number of fibers per FOC core	1	1
Number of FOC cores per FOC cable	2	2
Version of the FO conductor fiber	POF FOC 980/1 000 µm	POF FOC 980/1 000 µm
Outer diameter		
• of optical fibers	980 µm	980 µm
• of the optical fiber sheath	1 000 µm	1 000 µm
• of the FOC core sheath	2.2 mm	2.2 mm
• of the cable	7.8 mm	8 mm
Symmetrical deviation		
• of the outer diameter of the FOC core sheath	0.1 mm	0.1 mm
Material		
• of the fiber-optic cable core	Polymethylmethacrylate (PMMA)	Polymethylmethacrylate (PMMA)
• of the optical fiber sheath	Fluoridated special polymer	Fluoridated special polymer
• of the FOC core sheath	PA	PA
• of the fiber-optic cable sheath	PVC	PUR
• of the strain relief	Kevlar fibers	Kevlar fibers
Color		
• of the FOC core sheath	orange / black	orange / black
• of the cable sheath	green	green
Bending radius		
• with single bend minimum permissible	100 mm	40 mm
• with multiple bends minimum permissible	150 mm	55 mm
• with continuous bending	-	55 mm
Number of bending cycles	-	5 000 000
Number of torsion cycles in the case of torsion by ± 360° on 1 m cable length	-	10 000
Traction stress maximum	100 N	100 N
Short-term shear force per length	100 N/cm	400 N/cm
Continuous lateral force per length	-	20 N/cm
Weight per length	65 kg/km	55 kg/km

**Technical specifications** (continued)

Article No.	6XV1874-2A	6XV1874-2B
Product-type designation	POF Standard Cable GP	POF Trailing Cable
<b>Permitted ambient conditions</b>		
Ambient temperature		
• during operating	-30 ... +70 °C	-20 ... +70 °C
• during storage	-30 ... +70 °C	-40 ... +80 °C
• during transport	-30 ... +70 °C	-40 ... +80 °C
• during installation	0 ... 50 °C	5 ... 50 °C
Burning behaviour	Flame-retardant in accordance with IEC 60332-1-2	Flame-retardant in accordance with IEC 60332-1-2
Chemical resistance		
• to mineral oil	Conditional resistance	resistant
• to grease	Conditional resistance	resistant
Radiological resistance to UV radiation	not resistant	resistant
<b>Product properties, functions, components general</b>		
Product feature		
• halogen-free	No	No
• silicon-free	Yes	Yes
Product component	No	No
Rodent protection		
Cable length for POF FOC		
• for Industrial Ethernet maximum	50 m	50 m
<b>Standards, specifications, approvals</b>		
Verification of suitability	UL approval: OFN (NEC Article 770, UL 1651) / CSA approval: OFN (CSA standard C22.2 No232-M1988)	UL-758 AWM Style 5422
• RoHS conformity	Yes	Yes

## PROFINET/Industrial Ethernet

### Cabling technology

#### POF and PCF fiber-optic cables

##### Technical specifications (continued)

Article No.	6XV1861-2A	6XV1861-2C	6XV1861-2D
Product-type designation	PCF Standard Cable GP	PCF Trailing Cable	PCF Trailing Cable GP
Product description	PCF fiber-optic cable with plastic cladding, sold by the meter, unassembled	PCF fiber-optic cable with plastic cladding, sold by the meter, unassembled	PCF fiber-optic cable with plastic cladding, sold by the meter, unassembled
Acceptability for application	Cable for fixed installation for indoor and outdoor use, UL approval	Cable for use with high mechanical stress and moving applications (e.g. trailing cables), without UL approval	Cable for use with high mechanical stress and moving applications (e.g. trailing cables), without UL approval
Version of the assembled FO cable	can be assembled with SC RJ, SC RJ Plug PRO, BFOC and Simplex connectors	can be assembled with SC RJ, SC RJ Plug PRO, BFOC and Simplex connectors	can be assembled with SC RJ, SC RJ Plug PRO, BFOC and Simplex connectors
Cable designation	AT-V(ZN)YY 2K 200/230	AT-V(ZN)Y(ZN)11Y 2K 200/230	AT-V(ZN)Y(ZN)Y 2K 200/230
<b>Optical data</b>			
Damping ratio per length at 660 nm maximum	10 dB/km	10 dB/km	10 dB/km
Bandwidth length product at 650 nm	17 GHz·m	17 GHz·m	17 GHz·m
<b>Mechanical data</b>			
Number of fibers per FOC core	1	1	1
Number of FOC cores per FOC cable	2	2	2
Version of the FO conductor fiber	Step index fiber 200/230 µm	Step index fiber 200/230 µm	Step index fiber 200/230 µm
Outer diameter			
• of optical fibers	200 µm	200 µm	200 µm
• of the optical fiber sheath	230 µm	230 µm	230 µm
• of the FOC core sheath	2.2 mm	2.2 mm	2.2 mm
• of the cable	7.2 mm	8.8 mm	8.8 mm
Symmetrical deviation			
• of the outer diameter of the FOC core sheath	0.1 mm	0.1 mm	0.1 mm
• of the outer diameter of the line	0.5 mm	0.5 mm	0.5 mm
Material			
• of the fiber-optic cable core	Quartz glass	Quartz glass	Quartz glass
• of the optical fiber sheath	Special polymer	Special polymer	Special polymer
• of the FOC core sheath	PVC	PVC	PVC
• of the fiber-optic cable sheath	PVC	PUR	PVC
• of the strain relief	Aramide fibers	Aramide fibers	Aramide fibers
Color			
• of the FOC core sheath	orange / black	orange / black	orange / black
• of the cable sheath	green	green	green
Bending radius			
• with single bend minimum permissible	70 mm	130 mm	130 mm
• with multiple bends minimum permissible	105 mm	175 mm	175 mm
Number of bending cycles	-	5 000 000	5 000 000
Traction stress maximum	100 N	800 N	800 N
Short-term shear force per length	500 N/cm	500 N/cm	500 N/cm
Continuous lateral force per length	300 N/cm	300 N/cm	300 N/cm
Weight per length	45 kg/km	85 kg/km	85 kg/km

**Technical specifications (continued)**

Article No.	6XV1861-2A	6XV1861-2C	6XV1861-2D
Product-type designation	PCF Standard Cable GP	PCF Trailing Cable	PCF Trailing Cable GP
<b>Permitted ambient conditions</b>			
Ambient temperature			
• during operating	-40 ... +90 °C	-25 ... +75 °C	-25 ... +75 °C
• during storage	-40 ... +90 °C	-30 ... +75 °C	-30 ... +75 °C
• during transport	-40 ... +90 °C	-30 ... +75 °C	-30 ... +75 °C
• during installation	-5 ... +50 °C	-5 ... +50 °C	-5 ... +50 °C
Burning behaviour	Flame-retardant in accordance with IEC 60332-1-2 and IEC 60332-3-22 (Cat. A)	Flame-retardant	Flame-retardant in accordance with IEC 60332-1-2 and IEC 60332-3-22 (Cat. A)
Chemical resistance			
• to mineral oil	Conditional resistance	resistant	Conditional resistance
• to grease	Conditional resistance	resistant	Conditional resistance
• to water	Conditional resistance	Conditional resistance	Conditional resistance
Radiological resistance to UV radiation	resistant	resistant	resistant
<b>Product properties, functions, components general</b>			
Product feature			
• halogen-free	No	No	No
• silicon-free	Yes	Yes	Yes
Product component	No	No	No
Rodent protection			
Cable length for PCF FOC			
• for Industrial Ethernet maximum	100 m	100 m	100 m
• for PROFIBUS maximum	400 m	400 m	400 m
<b>Standards, specifications, approvals</b>			
Verification of suitability	UL approval: OFN (NEC Article 770, UL 1651) / CSA approval: OFN 90 Cel, FT1, FT4 (CSA standard C22.2 No232-M1988)	-	UL approval: OFN (NEC Article 770, UL 1651) / CSA approval: OFN 90 Cel, FT1, FT4 (CSA standard C22.2 No232-M1988)
• RoHS conformity	Yes	Yes	Yes

## PROFINET/Industrial Ethernet

### Cabling technology

#### POF and PCF fiber-optic cables

##### Technical specifications (continued)

Article No.	6GK1900-0MB00-6AA0	6GK1900-0MB00-0AC0	6GK1900-0NB00-0AC0
Product-type designation	IE SC RJ POF Plug PRO (Push Pull)	IE SC RJ POF Plug	IE SC RJ PCF Plug
Product description	SC RJ connector for POF FO cables	SC RJ connector for POF FO cables	SC RJ connector for PCF FO cables
Acceptability for application	Field-assembly connector for push-pull device connection in high degree of protection	For connection of POF fiber-optic cables	For connection of PCF fiber-optic cables
<b>Transmission rate</b>			
Transfer rate			
• 1 for Industrial Ethernet	100 Mbit/s	100 Mbit/s	100 Mbit/s
• 2 for Industrial Ethernet	-	-	-
<b>Interfaces</b>			
Number of electrical connections			
• for Industrial Ethernet FC TP cables	-	-	-
• for network components and terminal equipment	-	-	-
Design of electrical connection			
• for Industrial Ethernet FC TP cables	-	-	-
• for network components and terminal equipment	-	-	-
Number of optical interfaces for optical waveguide	1	1	1
Design of optical connections for network components or terminal devices	SC RJ connector (Push Pull device connection)	SC RJ connector (Push Pull device connection)	SC RJ connector (Push Pull device connection)
Design of the electrical connection FastConnect	No	No	No
<b>Mechanical data</b>			
Material of the enclosure	plastic	plastic	plastic
<b>Design, dimensions and weight</b>			
Type of cable outlet	180 degree cable outlet	180 degree cable outlet	180 degree cable outlet
Width	22 mm	22 mm	22 mm
Height	30 mm	30 mm	30 mm
Depth	62.5 mm	62.5 mm	62.5 mm
Net weight	63.5 g	63.5 g	63.5 g
<b>Permitted ambient conditions</b>			
Ambient temperature			
• during operating	-40 ... +70 °C	-40 ... +70 °C	-40 ... +70 °C
• during storage	-40 ... +70 °C	-40 ... +70 °C	-40 ... +70 °C
• during transport	-40 ... +70 °C	-40 ... +70 °C	-40 ... +70 °C
Relative humidity at 25 °C without condensation during operating maximum	-	-	-
Protection class IP	IP65/67	IP65/67	IP65/67
Chemical resistance to water	resistant	resistant	resistant
<b>Product properties, functions, components general</b>			
Product feature silicon-free	Yes	Yes	Yes
Product component strain relief	Yes	Yes	Yes
<b>Standards, specifications, approvals</b>			
Verification of suitability			
• RoHS conformity	Yes	Yes	Yes
• UL-registration	No	No	No

Ordering data	Article No.	Article No.	
<b>POF Standard Cable GP 980/1000</b> POF standard cable for fixed routing indoors with PVC sheath; sold by the meter; max. length 1 000 m; minimum order 20 m	<b>6XV1874-2A</b>	<b>IE SC RJ POF Plug</b> Screw connector for local assembly on POF FOC (1 pack = 20 items)	<b>6GK1900-0MB00-0AC0</b>
<b>POF Trailing Cable 980/1000</b> POF trailing cable for use in cable carriers, with rugged PUR sheath; sold by the meter; max. length 1 000 m; minimum order 20 m	<b>6XV1874-2B</b>	<b>IE SC RJ POF Plug PRO</b> Screw connector for local assembly on POF FOC (1 pack = 1 unit)	<b>6GK1900-0MB00-6AA0</b>
<b>PCF Standard Cable GP 200/230</b> Standard cable, segmentable, sold by the meter; max. length 2 000 m; minimum order 20 m;	<b>6XV1861-2A</b>	<b>IE SC RJ POF refill set</b> Refill set for Termination Kit SC RJ POF Plug consisting of grinding paper and grinding base (set of 5)	<b>6GK1900-0MN00-0AA0</b>
<b>PCF Trailing Cable 200/230</b> Trailing cable, segmentable, sold by the meter; max. length 2 000 m; minimum order 20 m;	<b>6XV1861-2C</b>	<b>Termination Kit SC RJ PCF Plug</b> Assembly case for local assembly of SC RJ connectors, comprising a stripping tool, buffer stripping tool, Kevlar scissors, fiber breaking tool, microscope	<b>6GK1900-0NL00-0AA0</b>
<b>PCF Trailing Cable GP 200/230</b> Trailing cable, segmentable, sold by the meter; max. length 2 000 m; minimum order 20 m;	<b>6XV1861-2D</b>	<b>Industrial Ethernet SC RJ PCF Plug</b> Screw connector for local assembly on POF FOC (1 pack = 10 items)	<b>6GK1900-0NB00-0AC0</b>
<b>Termination Kit SC RJ POF Plug</b> Assembly case for local assembly of SC RJ connectors, comprising a stripping tool, Kevlar scissors, microscope, grinding paper and grinding base	<b>6GK1900-0ML00-0AA0</b>	<b>IE SC RJ PCF Plug PRO</b> Screw connector for local assembly on POF FOC (1 pack = 1 unit)	<b>6GK1900-0NB00-6AA0</b>
		<b>SIMATIC NET Manual Collection</b> Electronic manuals for communication systems, communication protocols, and communication products; on DVD; German/English	<b>6GK1975-1AA00-3AA0</b>

### More information

You can order components supplementary to the SIMATIC NET cabling range from your local contact.

Technical advice on this subject is available from:

J. Hertlein  
 I IA SC CI PRM 4  
 Phone: +49 (911) 750-4465  
 E-mail: [juergen.hertlein@siemens.com](mailto:juergen.hertlein@siemens.com)

## PROFINET/Industrial Ethernet

### Cabling technology

#### POF/PCF FOC termination kit

##### Overview



- Compact, rugged assembly case for POF and PCF fiber-optic cables
- Special versions for easy assembly of SC RJ plugs on POF and PCF fiber-optic cables
- The quality of the assembly can be checked using the enclosed microscope

##### Benefits



- Easy installation of the unassembled cables in industrial plants
- Flexible assembly of connectors on POF and PCF fiber optic cables on site (SC RJ connectors)
- Mistakes are prevented with easy visual inspection of the assembled connector on site using a microscope
- Simple repair of POF and PCF fiber optic cables in the field

##### Application

SIMATIC NET POF and PCF fiber-optic cables are used to construct optical indoor and outdoor Industrial Ethernet/PROFINET networks. They are easy to assemble on-site with the Termination Kits and 2 x 2 RJ connectors. The maximum cable length between two Industrial Ethernet/PROFINET devices is 100 m for PCF and 50 m for POF fiber-optic cables.

Industrial Ethernet/PROFINET devices with integral optical interface (SC RJ connection system) are, for example, SCALANCE X-200P IRT and ET200S.

##### Design

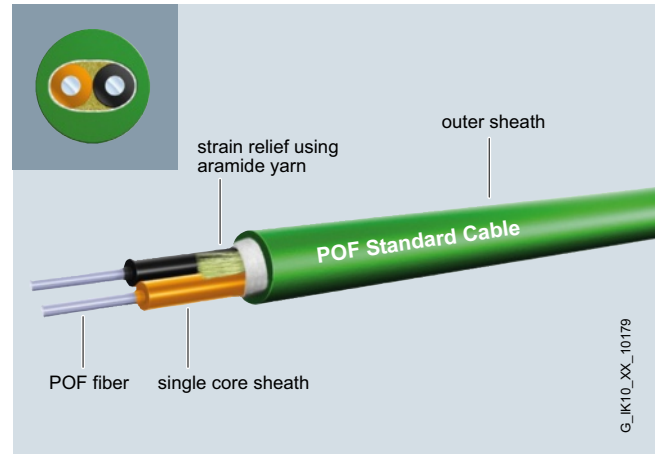

Cable construction POF plastic optical fiber

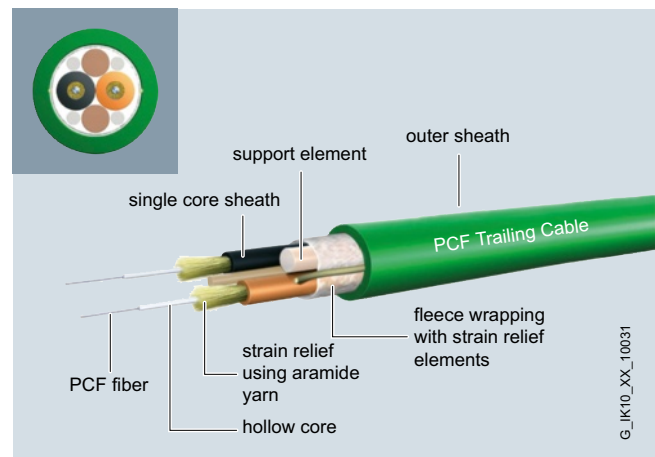

Cable construction PCF plastic optical fiber

The kit is available in assembly cases for on-site installation of SC RJ connectors on PCF fiber-optic cables.

It consists of a stripping tool, buffer stripping tool, Kevlar scissors, fiber breaking tool and microscope.



Ordering data	Article No.
<b>Termination Kit SC RJ POF Plug</b> Assembly case for on-site installation of SC RJ POF connectors; consisting of stripping tool, Kevlar cutters, SC RJ grinding plate, grinding paper, grinding base and microscope	<b>6GK1900-0ML00-0AA0</b>
<b>Termination Kit SC RJ PCF Plug</b> Assembly case for on-site assembly of SC RJ PCF connectors, comprising a stripping tool, buffer stripping tool, Kevlar cutters, fiber breaking tool and microscope	<b>6GK1900-0NL00-0AA0</b>
<i>Accessories</i>	
<b>IE SC RJ POF Plug</b> 20 plugs for on-site assembly	<b>6GK1900-0MB00-0AC0</b>
<b>IE SC RJ POF Plug PRO</b> 1 plug for on-site assembly	<b>6GK1900-0MB00-6AA0</b>
<b>IE SC RJ PCF Plug</b> 10 plugs for on-site assembly	<b>6GK1900-0NB00-0AC0</b>
<b>IE SC RJ PCF Plug PRO</b> 1 plug for on-site assembly	<b>6GK1900-0NB00-6AA0</b>
<b>IE SC RJ POF refill set</b> Refill set for Termination Kit SC RJ POF Plug consisting of grinding paper and grinding plate (set of 5)	<b>6GK1900-0MN00-0AA0</b>

**More information**

You can order components supplementary to the SIMATIC NET cabling range from your local contact.

Technical advice on this subject is available from:

J. Hertlein  
 I IA SC CI PRM 4  
 Phone: +49 (911) 750-4465  
 E-mail: [juergen.hertlein@siemens.com](mailto:juergen.hertlein@siemens.com)

## PROFINET/Industrial Ethernet SCALANCE X-100 unmanaged / Media converters

### SCALANCE X-100 unmanaged media converters

#### Overview



The unmanaged Industrial Ethernet media converters of the SCALANCE X-100 product line are ideally suited to the conversion of different transmission media in Industrial Ethernet networks at data transfer rates of 10/100 Mbit/s in line, star and ring topologies.

- Electrical or optical connection to stations or network in accordance with the port type of the devices
- Rugged metal enclosure for space-saving cubicle mounting on standard rails, S7-300 DIN rails, or for wall mounting
- Rugged, industry-standard station connections with PROFINET-compatible RJ45 connectors that offer additional strain relief and bending strain relief thanks to latching on the housing
- Redundant power supply
- Diagnostics on the device by means of LEDs (power, link status, data communication)
- Error signaling contact with easy adjustment using the SET button
- Connection of existing 10 Mbit/s fiber-optic networks
- Connection of existing 10Base5 networks (e.g. SINEC H1)

#### Product versions

**SCALANCE X101-1, SCALANCE X101-1LD,  
SCALANCE X101-1POF, SCALANCE X101-1FL and  
SCALANCE X101-1AUI**

- For converting electrical signals into optical signals in Industrial Ethernet line, star and ring topologies
- The Industrial Ethernet media converters have an electrical 10/100 Mbit/s RJ45 port and:
  - **SCALANCE X101-1**  
1x 100 Mbit/s BFOC port, optical (multimode, glass FOC)
  - **SCALANCE X101-1LD**  
1x 100 Mbit/s BFOC port, optical (singlemode, glass FOC)
  - **SCALANCE X101-1POF**  
1x 100 Mbit/s SC-RJ port, optical (plastic optical fiber, POF FOC)
  - **SCALANCE X101-1AUI**  
1x 10 Mbit/s AUI interface with Sub-D connections
  - **SCALANCE X101-1FL**  
1x 10 Mbit/s BFOC port, optical (multimode, glass FOC)
- Redundant power supply with 2 x 24 V DC
- Diagnostics on the device using LEDs (power, link status, data traffic) and signaling contact (alarm screen form can be set using a button on the device)
- The electric RJ45 port is industry-standard and features an additional retaining collar for connection of the IE FC RJ45 Plugs

#### Benefits

get **Designed for Industry**

- Ideal solution for converting various transmission media in Industrial Ethernet line, star and ring topologies
- Space-saving installation in the cabinet thanks to the compact design in S7-300 format
- Reliable plug-in connection thanks to industry-standard device connection with PROFINET-compliant FastConnect connectors
- Integration of existing 10Base FL and/or 10Base5 networks
- Cost savings, since installation is possible without a patch field by means of IE FC RJ45 Plug and IE FC Standard Cable
- Uncrossed connecting cables can be used due to the integrated Autocrossover function

#### Application

The unmanaged media converters of the SCALANCE X-100 product line permit low-cost conversion of various transmission media within Industrial Ethernet line, star and ring topologies. They are designed for installation in the control cabinet.

Single, remote terminal units on network segments can be linked via the optical path of the SCALANCE X-100 media converters. Integration of an optical path into a redundant ring is also possible, as well as installation of the SCALANCE X-100 media converters into a standby link.

## PROFINET/Industrial Ethernet SCALANCE X-100 unmanaged / Media converters

### SCALANCE X-100 unmanaged media converters

#### Design

The SCALANCE Industrial Ethernet media converters with a rugged metal housing are optimized for mounting on a standard rail and an S7-300 DIN rail. Direct wall mounting in various positions is also possible. Due to the housing dimensions that correspond to those of the S7-300, the devices are ideally suited for integration into an automation solution using S7-300 components.

The SCALANCE X-100 media converters feature:

- A 4-pole terminal block for connecting the redundant supply voltage (2 x 24 V DC)
- A row of LEDs for displaying status information (power, link status, data communication, signaling contact)
- A 2-pole terminal block for connecting the floating signaling contact
- A SET button for local configuration of the signaling contact and of cascading mode

The following port types are available:

- **10/100BaseTX, RJ45 port:** automatic detection of the data rate (10 or 100 Mbit/s), with autosensing and autocrossover function for connecting IE FC cables via IE FC RJ45 connectors over distances up to 100 m
- **100BaseFX, BFOC port** with glass fiber-optic cable: for direct connection to Industrial Ethernet glass fiber-optic cables up to 3000 m or 26000 m for configuring line, star or ring topologies
- **100BaseFX, SC RJ port** with POF fiber-optic cable: for direct connection to Industrial Ethernet POF fiber-optic cables up to 50 m or to Industrial Ethernet PCF fiber-optic cables up to 100 m for configuring line, star or ring topologies
- **10BaseFL, BFOC port** with glass fiber-optic cable: for direct connection to Industrial Ethernet glass fiber-optic cables up to 3000 m for configuring line, star or ring topologies
- **AUI, 15-pin Sub-D port:** for connecting an Industrial Ethernet AUI cable (connecting cable 727-1/drop cable) of up to 50 m to AUI transceiver (no terminal equipment)

#### Function

- Configuring electrical and optical Industrial Ethernet line, star or ring topologies
- Uncrossed connecting cables can be used due to Autocrossover function integrated in the TP ports
- Easy configuration and extension of the network; no limits to network extension when switches or media converters of the SCALANCE X-100 family are cascaded.
- Integration of existing 10Base FL and/or 10Base5 networks

	Type and number of ports						Characteristics						
	Twisted Pair		Fiber Optic				Compact enclosure	LED diagnostics	SIMATIC environment	2 x 24 V DC	Signaling contact	On-site display (SET button)	Ring redundancy without RM
			Fast Ethernet										
	10 / 100 Mbit/s	10 Mbit/s	100 Mbit/s			10 Mbit/s							
	RJ45	AUI	POF / PCF	Multimode BFOC	Singlemode BFOC	Multimode BFOC							
SCALANCE X101-1	1			1									
SCALANCE X101-1LD	1				1		•	•	•	•	•	•	
SCALANCE X101-1POF	1		1				•	•	•	•	•	•	
SCALANCE X101-1AUI	1	1					•	•	•	•	•	•	
SCALANCE X101-1FL	1					1	•	•	•	•	•	•	

Function overview of Industrial Ethernet media converters

## PROFINET/Industrial Ethernet SCALANCE X-100 unmanaged / Media converters

### SCALANCE X-100 unmanaged media converters

#### Function (continued)

#### Network topology and network configuration

The SCALANCE X-100 media converters are typically accommodated in one control cabinet together with the nodes to be connected. They can be installed in line, star and ring topologies.

When configuring the network, it is necessary to observe the following boundary conditions:

- Length of the TP cable between two SCALANCE X media converters:
  - Max. 100 m with Industrial Ethernet FastConnect products
- Length of the optical cables:
  - Max. 5 km with Industrial Ethernet multimode fiber-optic cables
  - Max. 26 km with Industrial Ethernet singlemode fiber-optic cables
  - Max. 100 m with Industrial Ethernet PCF fiber-optic cables
  - Max. 50 m with Industrial Ethernet POF fiber-optic cables
- Length of the AUI cable:
  - max. 50 m with Industrial Ethernet connecting cable 727-1 (AUI drop cable)

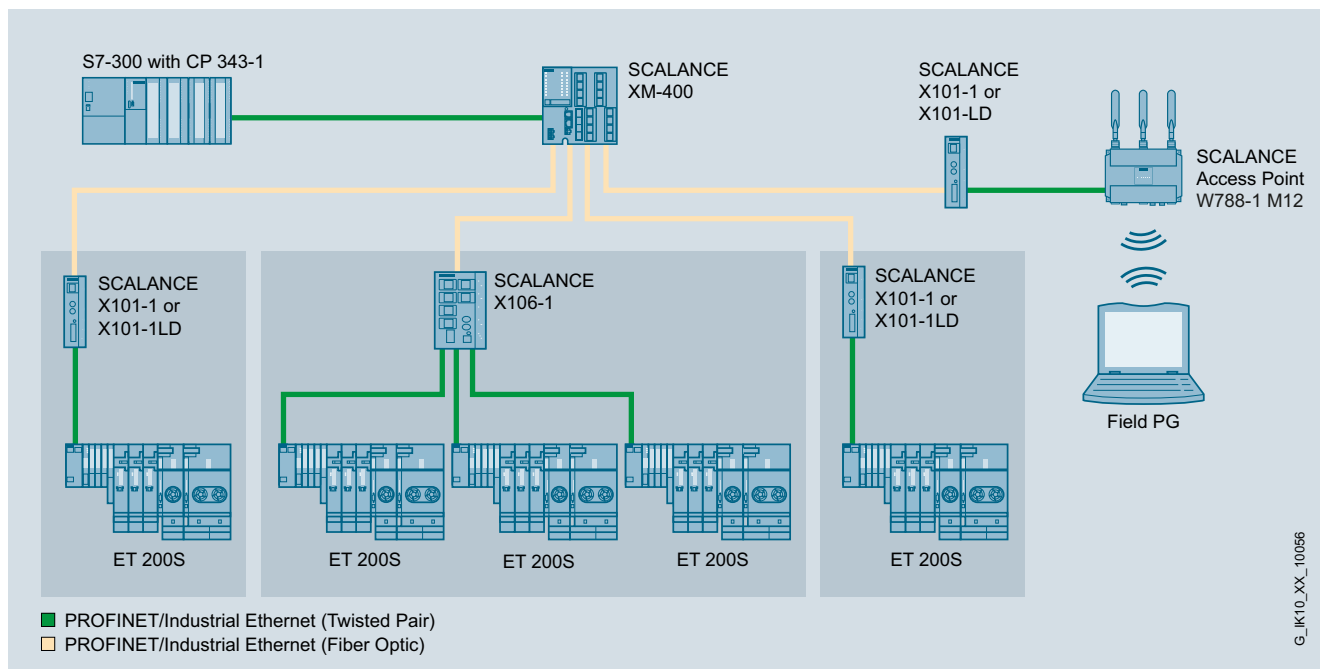

Optical star topology with SCALANCE X101-1/X101-1LD and remote SCALANCE W Access Point

### Function (continued)

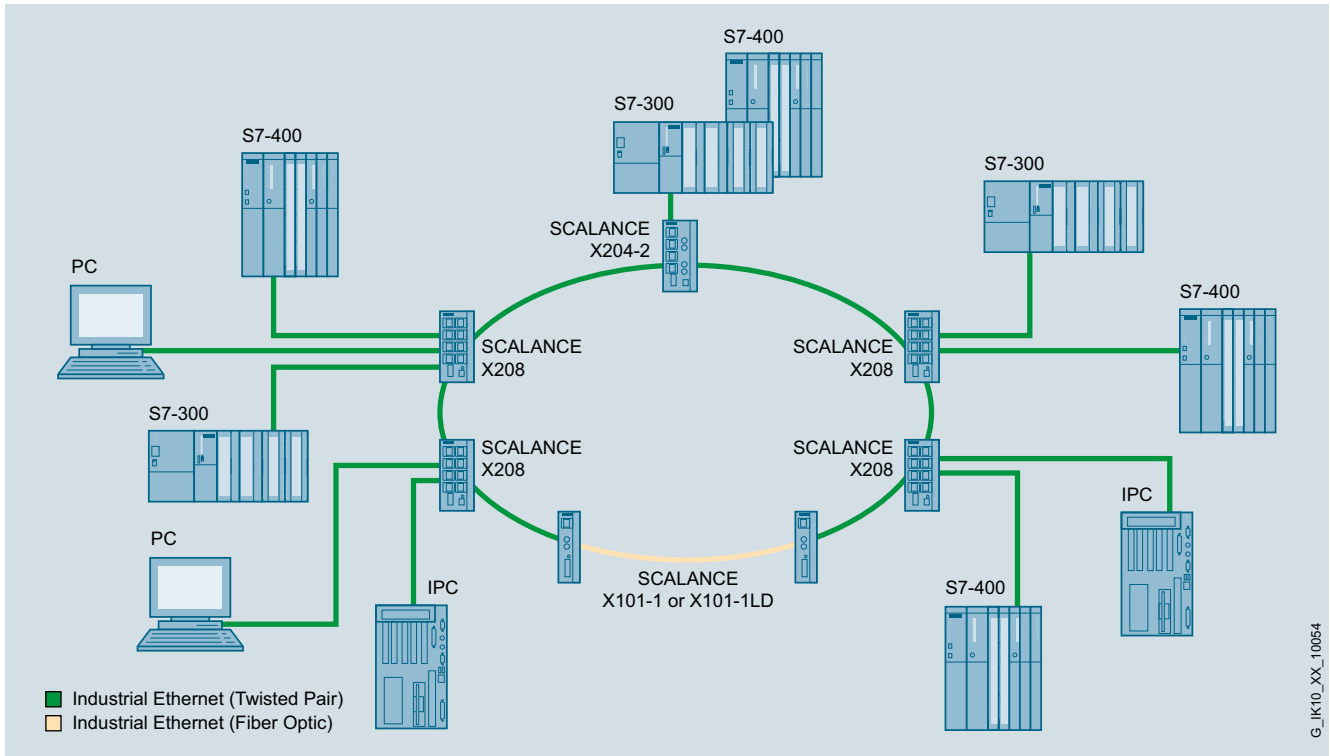

Mixed ring topology with twisted-pair and fiber optic cables

# PROFINET/Industrial Ethernet

## SCALANCE X-100 unmanaged / Media converters

### SCALANCE X-100 unmanaged media converters

#### Function (continued)

2

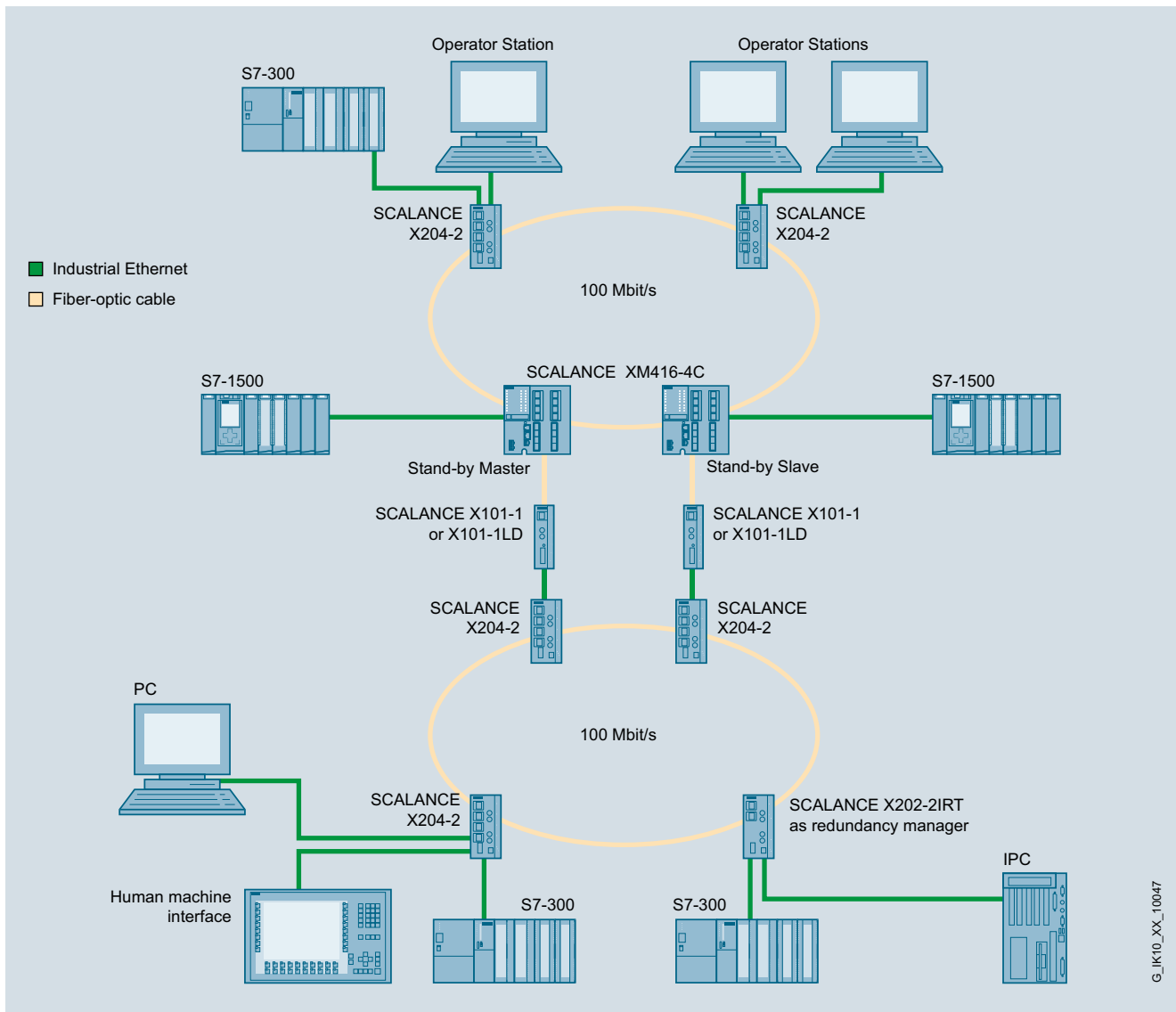

G\_IK10\_XX\_10047

Optical redundant connection of two optical rings with SCALANCE X101-1 or SCALANCE X101-1LD

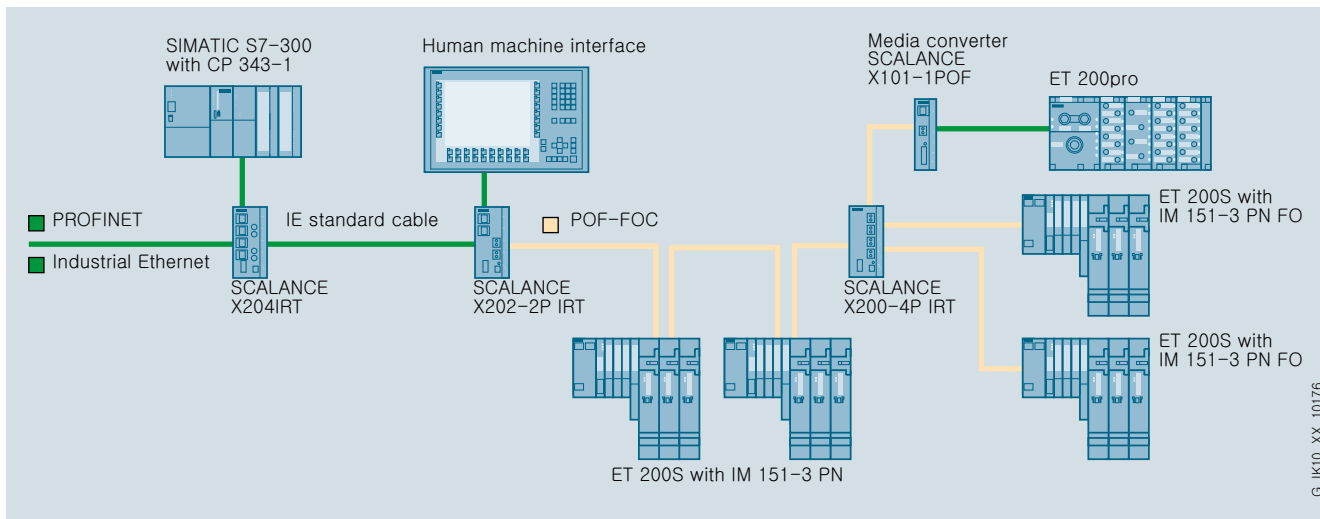

G\_IK10\_XX\_10176

Network structure with plastic fiber optic cabling

#### Function (continued)

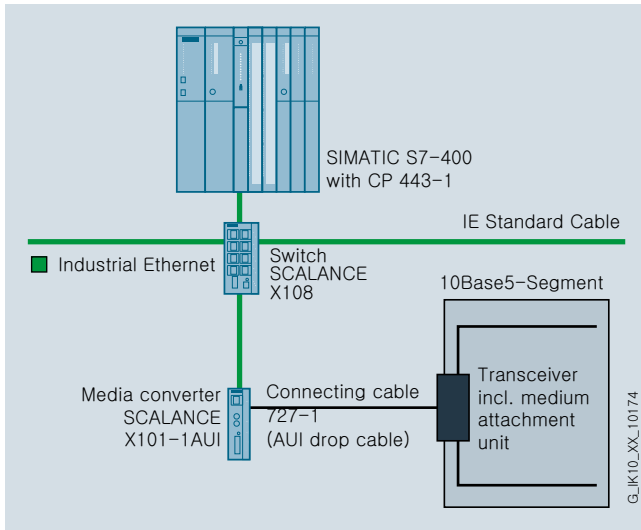

Connection of a 10Base5 segment (e.g. SINEC H1) to Industrial Ethernet (10/100 Mbit/s) with SCALANCE X101-1AUI

#### Diagnostics

The following information is displayed on site by LEDs:

- Power
- Port status
- Data traffic

The Industrial Ethernet media converters of the SCALANCE X-100 product line can also be monitored using the floating signaling contact. Two media converters of the same type can be connected in cascading mode.

## PROFINET/Industrial Ethernet

### SCALANCE X-100 unmanaged / Media converters

#### SCALANCE X-100 unmanaged media converters

#### Technical specifications

Article No.	6GK5101-1BB00-2AA3	6GK5101-1BC00-2AA3
Product-type designation	SCALANCE X101-1	SCALANCE X101-1LD
<b>Transmission rate</b>		
Transfer rate 1	-	-
Transfer rate 2	100 Mbit/s	100 Mbit/s
<b>Interfaces</b>		
Number of electrical/optical connections for network components or terminal equipment maximum	2	2
Number of electrical connections		
• for network components and terminal equipment	1	1
• for Power-over-Ethernet for network components or terminal equipment	-	-
• for signaling contact	1	1
• for power supply	1	1
• for redundant power supply	1	1
Design of electrical connection		
• for network components and terminal equipment	RJ45 port	RJ45 port
• for Power-over-Ethernet for network components or terminal equipment	-	-
• for signaling contact	2-pole terminal block	2-pole terminal block
• for power supply	5-pole terminal block	5-pole terminal block
Number of optical interfaces for optical waveguide		
• at 100 Mbit/s	1	1
Design of optical interface for optical waveguide		
• at 10 Mbit/s	-	-
• at 100 Mbit/s	BFOC-Port (Multimode up to 5 km)	ST/SC-Port
Connectable optical power relative to 1 mW		
• of the receiver input maximum	-14 dB	0 dB
• of the transmitter output	-14 ... -19 dB	0 ... -5 dB
Optical sensitivity relative to 1 mW of the receiver input minimum	-31 dB	-35 dB
Attenuation of fiber-optic cable transmission link minimum necessary	0 dB	0 dB
Range at the optical interface depending on the optical fiber used	0 ... 5 km	0 ... 26 km
<b>Signal-Inputs/outputs</b>		
Operating voltage of signaling contacts at DC rated value	24 V	24 V
Operating current of signaling contacts at DC maximum	0.1 A	0.1 A
<b>Supply voltage, current consumption, power loss</b>		
Type of supply voltage	DC	DC
Supply voltage external	24 V	24 V
• minimum	18 V	18 V
• maximum	32 V	32 V
Product component fusing at power supply input	Yes	Yes
Type of fusing at input for supply voltage	0.5 A/60 V	0.5 A/60 V
Consumed current maximum	0.12 A	0.12 A
Active power loss at 24 V for DC	3 W	3 W



## PROFINET/Industrial Ethernet

### SCALANCE X-100 unmanaged / Media converters

#### SCALANCE X-100 unmanaged media converters

#### Technical specifications (continued)

Article No.	6GK5101-1BB00-2AA3	6GK5101-1BC00-2AA3
Product-type designation	SCALANCE X101-1	SCALANCE X101-1LD
<b>Permitted ambient conditions</b>		
Ambient temperature		
• during operating	-10 ... +60 °C	-10 ... +60 °C
• during storage	-40 ... +80 °C	-40 ... +80 °C
• during transport	-40 ... +80 °C	-40 ... +80 °C
Relative humidity at 25 °C without condensation during operating maximum	95 %	95 %
Protection class IP	IP30	IP30
<b>Design, dimensions and weight</b>		
Design	Compact	Compact
Width	40 mm	40 mm
Height	125 mm	125 mm
Depth	124 mm	124 mm
Net weight	0.55 kg	0.55 kg
Mounting type		
• 35 mm DIN rail mounting	Yes	Yes
• wall mounting	Yes	Yes
• S7-300 rail mounting	Yes	Yes
<b>Standards, specifications, approvals</b>		
Standard		
• for EMC from FM	FM3611: Class 1, Division 2, Group A, B, C, D / T.., Class 1, Zone 2, Group IIC, T..	FM3611: Class 1, Division 2, Group A, B, C, D / T.., Class 1, Zone 2, Group IIC, T..
• for hazardous zone	EN 600079-15 II 3 G EEx nA II T.. KEMA 06 ATEX 0021 X	EN 600079-15 II 3 G EEx nA II T.. KEMA 06 ATEX 0021 X
• for safety of CSA and UL	UL 60950-1, CSA C22.2 No. 60950-1	UL 60950-1, CSA C22.2 No. 60950-1
• for hazardous area of CSA and UL	UL 1604 and UL 2279-15 (Hazardous Location), Class 1 / Division 2 / Group A, B, C, D / T.., Class 1 / Zone 2 / Group IIC / T..	UL 1604 and UL 2279-15 (Hazardous Location), Class 1 / Division 2 / Group A, B, C, D / T.., Class 1 / Zone 2 / Group IIC / T..
• for emitted interference	EN 61000-6-3	EN 61000-6-4:2001
• for interference immunity	EN 61000-6-4:2001	EN 61000-6-4:2001
Verification of suitability	EN 61000-6-2:2001, EN 61000-6-4:2001	EN 61000-6-2:2001, EN 61000-6-4:2001
• CE mark	Yes	Yes
• C-Tick	Yes	Yes
• KC approval	Yes	Yes
Marine classification association		
• American Bureau of Shipping Europe Ltd. (ABS)	Yes	Yes
• Bureau Veritas (BV)	Yes	Yes
• Det Norske Veritas (DNV)	Yes	Yes
• Germanische Lloyd (GL)	Yes	Yes
• Lloyds Register of Shipping (LRS)	Yes	Yes
• Nippon Kaiji Kyokai (NK)	Yes	Yes
• Polski Rejestr Statkow (PRS)	No	No

## PROFINET/Industrial Ethernet

### SCALANCE X-100 unmanaged / Media converters

#### SCALANCE X-100 unmanaged media converters

#### Technical specifications (continued)

Article No.	6GK5101-1BH00-2AA3	6GK5101-1BY00-2AA3	6GK5101-1BX00-2AA3
Product-type designation	SCALANCE X101-1POF	SCALANCE X101-1FL	SCALANCE X101-1AUI
<b>Transmission rate</b>			
Transfer rate 1	-	10 Mbit/s	10 Mbit/s
Transfer rate 2	100 Mbit/s	-	-
<b>Interfaces</b>			
Number of electrical/optical connections for network components or terminal equipment maximum	2	2	2
Number of electrical connections			
• for network components and terminal equipment	1	1	2
• for signaling contact	1	1	1
• for power supply	1	1	1
• for redundant power supply	1	1	1
Design of electrical connection			
• for network components and terminal equipment	RJ45 port	RJ45 port	RJ45 port, 15-pin D-sub socket
• for signaling contact	2-pole terminal block	2-pole terminal block	2-pole terminal block
• for power supply	5-pole terminal block	5-pole terminal block	5-pole terminal block
Number of optical interfaces for optical waveguide			
• at 10 Mbit/s	-	1	-
• at 100 Mbit/s	1	-	-
Design of optical interface for optical waveguide			
• at 10 Mbit/s	-	BFOC port (multimode up to 5 km)	-
• at 100 Mbit/s	SC-RJ/POF-Port	-	-
Connectable optical power relative to 1 mW			
• of the transmitter output	-6 ... -0.5 dB	-16 ... -9 dB	-
• of the receiver input maximum	1 dB	-8.2 dB	-
Optical sensitivity relative to 1 mW of the receiver input minimum	-23 dB	-30.6 dB	-
Attenuation of fiber-optic cable transmission link minimum necessary	0 dB	0 dB	-
Range at the optical interface depending on the optical fiber used	0 ... 0.05 km	0 ... 5 km	-
<b>Signal-Inputs/outputs</b>			
Operating voltage of signaling contacts at DC rated value	24 V	24 V	24 V
Operating current of signaling contacts at DC maximum	0.1 A	0.1 A	0.1 A
<b>Supply voltage, current consumption, power loss</b>			
Type of supply voltage	DC	DC	DC
Supply voltage external	24 V	24 V	24 V
• minimum	18 V	18 V	18 V
• maximum	32 V	32 V	32 V
Product component fusing at power supply input	Yes	Yes	Yes
Type of fusing at input for supply voltage	0.5 A/60 V	0.5 A/60 V	1 A / 33 V
Consumed current maximum	0.12 A	0.12 A	0.16 A
Active power loss at 24 V for DC	3 W	3 W	3 W

## PROFINET/Industrial Ethernet SCALANCE X-100 unmanaged / Media converters

### SCALANCE X-100 unmanaged media converters

#### Technical specifications (continued)

Article No.	6GK5101-1BH00-2AA3	6GK5101-1BY00-2AA3	6GK5101-1BX00-2AA3
Product-type designation	SCALANCE X101-1POF	SCALANCE X101-1FL	SCALANCE X101-1AU
<b>Permitted ambient conditions</b>			
Ambient temperature			
• during operating	-10 ... +60 °C	-10 ... +60 °C	-10 ... +60 °C
• during storage	-40 ... +80 °C	-40 ... +80 °C	-40 ... +80 °C
• during transport	-40 ... +80 °C	-40 ... +80 °C	-40 ... +80 °C
Relative humidity at 25 °C without condensation during operating maximum	95 %	95 %	95 %
Protection class IP	IP30	IP30	IP30
<b>Design, dimensions and weight</b>			
Design	Compact	Compact	Compact
Width	40 mm	40 mm	40 mm
Height	125 mm	125 mm	125 mm
Depth	124 mm	124 mm	124 mm
Net weight	0.55 kg	0.55 kg	0.56 kg
Mounting type			
• 35 mm DIN rail mounting	Yes	Yes	Yes
• wall mounting	Yes	Yes	Yes
• S7-300 rail mounting	Yes	Yes	Yes
Mounting type			
<b>Standards, specifications, approvals</b>			
Standard			
• for EMC from FM	FM3611: Class 1, Division 2, Group A, B, C, D / T..., Class 1, Zone 2, Group IIC, T..	FM3611: Class 1, Division 2, Group A, B, C, D / T..., Class 1, Zone 2, Group IIC, T..	FM3611: Class 1, Division 2, Group A, B, C, D / T..., Class 1, Zone 2, Group IIC, T..
• for hazardous zone	EN 600079-15 II 3 G EEx nA II T.. KEMA 06 ATEX 0021 X	EN 600079-15 II 3 G EEx nA II T.. KEMA 06 ATEX 0021 X	EN 600079-15 II 3 G EEx nA II T.. KEMA 06 ATEX 0021 X
• for safety of CSA and UL	UL 60950-1, CSA C22.2 No. 60950-1	UL 60950-1, CSA C22.2 No. 60950-1	UL 60950-1, CSA C22.2 No. 60950-1
• for hazardous area of CSA and UL	UL 1604 and UL 2279-15 (Hazardous Location), Class 1 / Division 2 / Group A, B, C, D / T..., Class 1 / Zone 2 / Group IIC / T..	UL 1604 and UL 2279-15 (Hazardous Location), Class 1 / Division 2 / Group A, B, C, D / T..., Class 1 / Zone 2 / Group IIC / T..	UL 1604 and UL 2279-15 (Hazardous Location), Class 1 / Division 2 / Group A, B, C, D / T..., Class 1 / Zone 2 / Group IIC / T..
• for emitted interference	EN 61000-6-3 (Class B)	EN 61000-6-3	EN 61000-6-4:2001
• for interference immunity	EN 61000-6-4:2001	EN 61000-6-4:2001	EN 61000-6-4:2001
Verification of suitability	EN 61000-6-2:2001, EN 61000-6-4:2001	EN 61000-6-2:2001, EN 61000-6-4:2001	EN 61000-6-2:2001, EN 61000-6-4:2001
• CE mark	Yes	Yes	Yes
• C-Tick	Yes	Yes	Yes
• KC approval	Yes	Yes	Yes
Marine classification association			
• American Bureau of Shipping Europe Ltd. (ABS)	Yes	Yes	Yes
• Bureau Veritas (BV)	Yes	Yes	Yes
• Det Norske Veritas (DNV)	Yes	Yes	Yes
• Germanische Lloyd (GL)	Yes	Yes	Yes
• Lloyds Register of Shipping (LRS)	Yes	Yes	Yes
• Nippon Kaiji Kyokai (NK)	Yes	Yes	Yes
• Polski Rejestr Statkow (PRS)	No	No	No

## PROFINET/Industrial Ethernet

### SCALANCE X-100 unmanaged / Media converters

#### SCALANCE X-100 unmanaged media converters

##### Ordering data

##### Article No.

##### SCALANCE X-100 unmanaged media converter

Industrial Ethernet media converters, LED diagnostics, fault signaling contact with SET key, redundant power supply, PROFINET-compatible retaining collar;  
incl. Operating Instructions, Industrial Ethernet network manual and configuration software on CD-ROM

- **SCALANCE X101-1**  
1 x 10/100 Mbit/s RJ45 port  
1 x 100 Mbit/s multimode FOC BFOC
- **SCALANCE X101-1LD**  
1 x 10/100 Mbit/s RJ45 port  
1 x 100 Mbit/s singlemode FOC BFOC
- **SCALANCE X101-1POF**  
1 x 10/100 Mbit/s RJ45 port  
1 x 100 Mbit/s POF SC RJ
- **SCALANCE X101-1AUI**  
1 x 10 Mbit/s RJ45 port  
1 x 10 Mbit/s AUI segment port
- **SCALANCE X101-1FL**  
1 x 10 Mbit/s RJ45 port  
1 x 10 Mbit/s multimode FOC

**6GK5101-1BB00-2AA3**

**6GK5101-1BC00-2AA3**

**6GK5101-1BH00-2AA3**

**6GK5101-1BX00-2AA3**

**6GK5101-1BY00-2AA3**

##### Accessories

##### IE FC TP Standard Cable GP 2 x 2 (Type A)

4-core, shielded TP installation cable for connection to IE FC Outlet RJ45/IE FC RJ45 Plug; PROFINET-compatible; with UL approval; sold by the meter; max. length 1 000 m, minimum order quantity 20 m

**6XV1840-2AH10**

##### IE FC RJ45 Plug 180 2 x 2

RJ45 plug connector for Industrial Ethernet with a rugged metal enclosure and integrated insulation displacement contacts for connecting Industrial Ethernet FC installation cables; 180° cable outlet; for network components and CPs/CPUs with Industrial Ethernet interface

- 1 pack = 1 unit
- 1 pack = 10 units
- 1 pack = 50 units

**6GK1901-1BB10-2AA0**

**6GK1901-1BB10-2AB0**

**6GK1901-1BB10-2AE0**

##### IE FC Stripping Tool

Preadjusted stripping tool for fast stripping of the Industrial Ethernet FC cables

**6GK1901-1GA00**

##### SITOP compact 24 V/0.6 A

1-phase power supply with wide-range input 85 – 264 V AC/110 – 300 V DC, stabilized output voltage 24 V, rated output current value 0.6 A, slim design

**6EP1331-5BA00**

##### More information

##### Selection tools:

To assist in selecting the right Industrial Ethernet switches as well as configuration of modular variants, the SIMATIC NET Selection Tool and the TIA Selection Tool are available at:

SIMATIC NET Selection Tool:

- Online version:  
<http://www.siemens.com/snst>
- Offline version:  
<http://www.siemens.com/snst-download>

TIA Selection Tool:

<http://www.siemens.com/tia-selection-tool>

## Overview

Industrial Ethernet switching components comprise

- Compact Switch Modules (CSMs)
- SCALANCE X Industrial Ethernet switches
- Communications processors (CP) with integral switch

### **Compact Switch Modules (CSMs)**

Unmanaged switches for use directly on the SIMATIC for interface expansion and integration of machines into existing plant networks

#### **SCALANCE X-000/XB-000 unmanaged**

Unmanaged switches with electrical and/or optical ports for designing small networks for machine or plant islands with 10/100/1000 Mbit/s

#### **SCALANCE X-100 unmanaged**

Switches with electrical and/or optical ports, redundant power supply, and signaling contact for use in machine-level applications (also available as media converter with two ports for conversion between two different media).

#### **SCALANCE X-200 managed**

For universal use, from machine-level applications to networked subsystems. Configuration and remote diagnosis are integrated into the STEP 7 engineering tool. This increases the level of plant availability. Devices with a high degree of protection facilitate cabinet-free construction.

Corresponding switches (SCALANCE X-200IRT) are also available for use in subsystem networks with hard real-time requirements and maximum availability.

#### **SCALANCE XF-200 managed**

SCALANCE XF-200 Industrial Ethernet switches have the same functions as SCALANCE X-200 switches. The flat design in ET 200S format (IP20 protection) mean they are optimally suitable for space-saving use in small control boxes.

#### **SCALANCE X-300 managed**

Networking of subsystem/plant areas, as well as linking to the enterprise network. The SCALANCE X-300 managed product line combines the firmware functionality of the SCALANCE X-400 line with the compact design of the SCALANCE X-200 line. This means the SCALANCE X-300 switches have extended management functions and an extended firmware functionality compared to the SCALANCE X-200 switches.

Electrical and optical Gigabit Ethernet ports are also available.

#### **SCALANCE XR-300 managed**

The SCALANCE XR-300 Industrial Ethernet switches correspond functionally to the SCALANCE X-300 switches. Designed as rack switches, they are particularly suitable for use in 19" control cabinets. They are also fully modular, and due to their 2-port media modules (electrical and optical) they can be adapted to the respective task.

For use in power plants and under difficult environmental conditions, ECC (Enhanced Environmental Conditions) versions may be used in compact and rack designs.

### **SCALANCE X-400 managed (Layer 3)**

For flexibly networking and structuring high-performance plant networks. Thanks to the modular design, the switches can be adapted to the respective task. Near Field Communication (NFC) in connection with existing WLAN also enables rapid access to web-based management via a smartphone or tablet connected to an available wireless network.

Optional routing functions on Layer 3 permit communication between different IP subnets.

### **SCALANCE X-500 managed (Layer 3)**

For networking and structuring high-performance industrial networks and for connecting office networks to automation networks. As a Layer 3 switch, SCALANCE X-500 is extremely well suited to use as a central component in backbone networks, e.g. when a high number of ports is required, at extremely high transmission rates (10 Gigabit Ethernet), or for redundant connection to an office infrastructure. The rack switch (19" design) can be used flexibly to suit requirements thanks to its modular design and the plug-in 4-port media modules (electrical and optical).

Routing functions on Layer 3 permit communication between different IP subnets.

### **Communications processors for SIMATIC with integral switch**

Managed switches for adding Industrial Ethernet/PROFINET interfaces to the SIMATIC and for integrating the controllers into existing line or ring topologies.

Thanks to integral Layer 3 functionality, the Advanced-CPs can also be used as routers between IP subnets.

### **Communications processors for PC with integral switch**

Managed switches for adding Industrial Ethernet/PROFINET interfaces to industrial PCs and for integrating PCs into existing line topologies.

# PROFINET/Industrial Ethernet

## Industrial Ethernet switches

### Overview

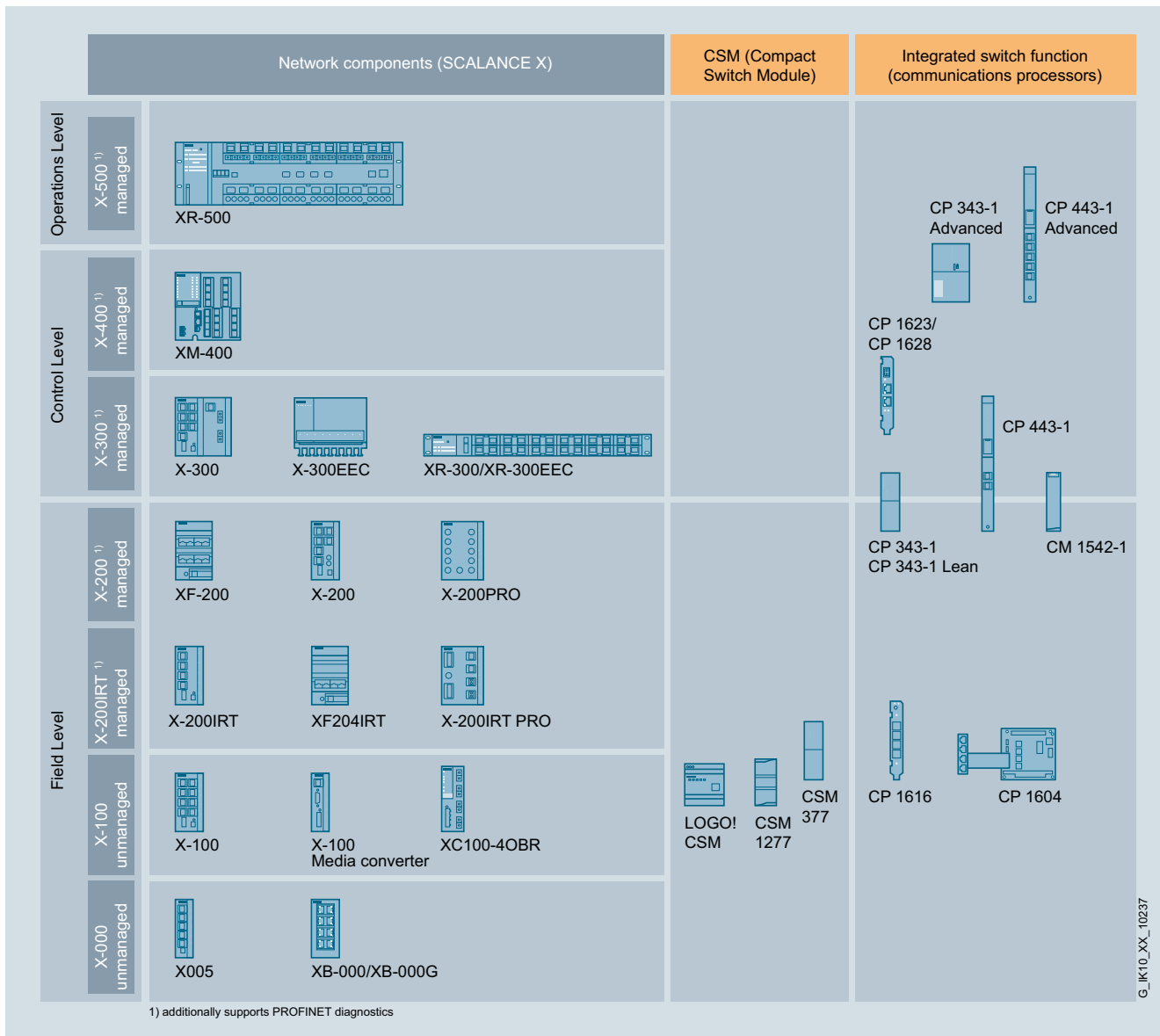

### Overview (continued)

2

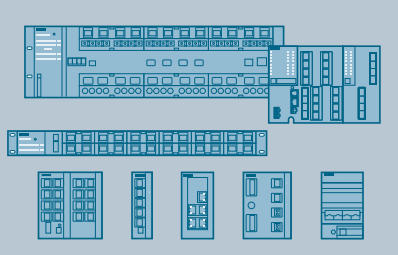

Overview of SCALANCE X Industrial Ethernet switches and components with switch functionality

**Overview** (continued)

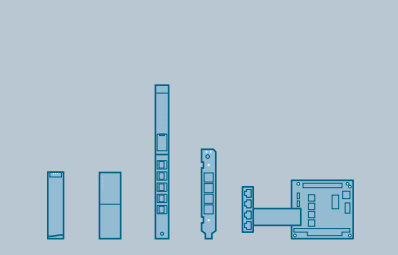
Network component	CSM	Integral switch function
		
<ul style="list-style-type: none"> <li>• Basis for integrated networking in industrial automation - from the field to the management level</li> <li>• Network components optimized for various applications:                             <ul style="list-style-type: none"> <li>- Small and large-scale structured networks</li> <li>- Management functions</li> <li>- Connection to IT networks</li> <li>- Configuring of redundant networks</li> <li>- Use with Industrial Ethernet and PROFINET</li> </ul> </li> <li>• Robust housing for harsh environments</li> <li>• Graded diagnostics concept</li> </ul>	<ul style="list-style-type: none"> <li>• Configuration of small networks</li> <li>• Easy expansion of the number of ports for:                             <ul style="list-style-type: none"> <li>- Connection of local HMI systems</li> <li>- Connection to higher-level networks</li> <li>- Service/maintenance</li> </ul> </li> <li>• Space-saving design of SIMATIC</li> <li>• Unmanaged Switch with local diagnostics</li> </ul>	<ul style="list-style-type: none"> <li>• Communications processor for interfacing with PROFINET/Industrial Ethernet including integral switch for:                             <ul style="list-style-type: none"> <li>- For interfacing with distributed I/O.</li> <li>- Connection to higher-level networks</li> <li>- IP routing</li> <li>- Service/maintenance</li> </ul> </li> <li>• SIMATIC or PC module design</li> <li>• Functions for network diagnostics</li> </ul>

G\_IK10\_XX\_10238

Application areas / type of network / requirements		Office incorporation	Plant networking	Industry-related applications	Energy generation and distribution	Wind energy plants	Machine building and plant engineering	Plant subnetworking	High-volume machine building	Internal machine networking	Network setup using SIMATIC S7	PC-based applications
X-500	High-performance backbone networks with very high emphasis on functionality / port density / availability and interface to IT network	•	•	•								
X-400	High-performance plant network with high emphasis on functionality and availability	•	•	•								
X-300	Large networks with high emphasis on functionality and availability		•									
X-200				•	•							
X-200	Networks with higher emphasis on functionality and availability		•				•	•				
X-100			•		•	•						
X-100	Networks with low emphasis on functionality						•		•			
X-000	Networks with low emphasis on functionality and robustness								•	•		
CSM	Very small networks or interface expansion for SIMATIC S7										•	
CPs	Very small networks through integrated switch in CP										•	•

G\_IK10\_XX\_10301

Industrial Ethernet Switches SCALANCE X: Areas of application

## PROFINET/Industrial Ethernet

### Industrial Ethernet switches

#### Overview

#### Overview (continued)

Features	Modular through media modules	19" design	Support of Gigabit Ethernet	Additional interface for SIMATIC S7	Power-over-Ethernet	Can be used under Enhanced Environmental Conditions (EEC)	Isochronous Real-Time (IRT)	Layer 3	Office features (VLAN)	Diagnosis	PROFINET IO Device	Time synchronization according to IEEE 1588
X-500	•	•	•		•			•	•	•	•	
X-400	•		•					•	•	•	•	
X-300	•	•	•		•				•	•	•	
X-300EEC/ XR-300EEC	•	•	•			•				•	•	•
X-200							• <sup>2)</sup>			•	•	
X204RNA										•		
X204RNA EEC						•				•		
X-100					•							
X-000			• <sup>1)</sup>									
CSM				•								
CPs <sup>3)</sup>				•				•		•	•	
• applies      1) with Gigabit version      2) with IRT version      3) SIMATIC S7 Advanced CPs only												

G\_IK10\_XX\_10302

Industrial Ethernet Switches SCALANCE X: Overview of functions

#### More information

##### Selection tools:

To assist in selecting the right Industrial Ethernet switches as well as configuration of modular variants, the SIMATIC NET Selection Tool and the TIA Selection Tool are available at:

SIMATIC NET Selection Tool:

- Online version:  
<http://www.siemens.com/snst>
- Offline version:  
<http://www.siemens.com/snst-download>

TIA Selection Tool:

<http://www.siemens.com/tia-selection-tool>



## Overview



The module is used to connect a LOGO! and up to three other nodes to an Industrial Ethernet network with 10/100 Mbit/s in an electrical linear, tree or star topology.

The essential features of the LOGO! CSM are:

- Unmanaged 4-port switch, of which one port is on the front for easy diagnostics access
- Two versions for the voltage ranges 12/24 V DC or 230 V AC/DC
- Problem-free connection using four RJ45 standard connectors
- Space-saving, optimized for connection to LOGO!
- Low-cost solution for implementing small, local Ethernet networks
- Stand-alone use for networking any Ethernet devices

## Benefits

**get** Designed for Industry

- Reduction in assembly costs and mounting space compared to use of external network components
- Fast commissioning, as no configuration is necessary
- Fast and uncomplicated diagnostics access in the control cabinet
- Flexible expansion of the network by simply inserting the CSM

## Application

The LOGO! CSM is an Industrial Ethernet switch in compact, modular design for use in devices of the new LOGO! generation with Industrial Ethernet connection. With the LOGO! CSM, the Ethernet interface of the SIMATIC LOGO! can be multiplied to enable simultaneous communication with control and programming devices, other controllers, or the office world.

Problem-free external access (for diagnostics purposes, for example) is possible via the four Ethernet ports.

### Product versions

#### LOGO!CSM 12/24

- For operation with DC power at a voltage of 12 and 24 volts

#### LOGO!CSM 230

- For operation with alternating voltage of 110 and 230 volts

## Design

The design of the LOGO! CSM Compact Switch Modules corresponds to that of the LOGO! components:

- Compact design; the rugged plastic enclosure contains:
  - 4 x RJ45 ports for connecting to Industrial Ethernet; of which one port is on the front for easy diagnostics access
  - 3-pin connection for the external supply voltage
  - LEDs for diagnostics and for status display of the Industrial Ethernet ports
- Simple mounting on the standard mounting rail
- Fanless and consequently low-maintenance design

# PROFINET/Industrial Ethernet

## Industrial Ethernet Switches

### Compact switch modules

#### LOGO! CSM unmanaged

#### Function

- Multiplication of the Ethernet interfaces for logic modules of the product range LOGO! with Ethernet connection (...-0BA7)
- Design of a small, local Industrial Ethernet network with three further nodes
- Automatic detection of data transfer rate by means of autosensing and autocrossover functions
- LEDs for diagnostics and for status display

#### Network topology and network configuration

With the LOGO! CSM, different network topologies can be implemented:

- Connection of the LOGO! in linear topology:  
at least one RJ45 connection of the LOGO! remains vacant, e.g. for connecting a programming device (PG)
- Connection of the LOGO! to a higher-level network in a tree/star topology:  
at least two RJ45 connections of the LOGO! remain vacant, e.g. for connecting a programming device/operator panel (PG/OP)
- Design of a small, local network with a LOGO! and three further Ethernet nodes

#### Configuration

The LOGO! CSM is an unmanaged switch and does not require configuring.

#### Diagnostics

The following information is displayed on LEDs on the device:

- Power
- Port status
- Data traffic

#### Integration

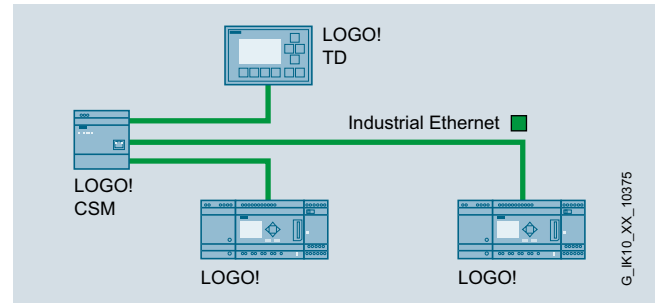

Linear structure with LOGO! CSM

#### Technical specifications

Article No.	6GK7177-1FA10-0AA0	6GK7177-1MA10-0AA0
Product-type designation	LOGO! CSM 230	LOGO! CSM 12/24
<b>Transmission rate</b>		
Transfer rate 1	10 Mbit/s	10 Mbit/s
Transfer rate 2	100 Mbit/s	100 Mbit/s
<b>Interfaces</b>		
Number of electrical/optical connections for network components or terminal equipment maximum	4	4
Number of electrical connections		
• for network components and terminal equipment	4	4
• for power supply	1	1
Design of electrical connection		
• for network components and terminal equipment	RJ45 port / 1 connection on front of module	RJ45 port / 1 connection on front of module
• for power supply	3-pole terminal block	3-pole terminal block
<b>Supply voltage, current consumption, power loss</b>		
Type of supply voltage	AC/DC 115 ... 240 V	DC 12/24 V
Supply voltage external	230 V	24 V
• minimum	100 V	10.2 V
• maximum	240 V	30.2 V
Product component fusing at power supply input	Yes	Yes
Consumed current maximum	0.02 A	0.15 A
Active power loss at 24 V for DC	-	1.5 W

**Technical specifications** (continued)

Article No.	6GK7177-1FA10-0AA0	6GK7177-1MA10-0AA0
Product-type designation	LOGO! CSM 230	LOGO! CSM 12/24
<b>Permitted ambient conditions</b>		
Ambient temperature		
• during operating	0 ... 55 °C	0 ... 55 °C
• during storage	-40 °C 70 °C	-40 °C 70 °C
• during transport	-40 °C	-40 °C
Relative humidity at 25 °C without condensation during operating maximum	90 %	90 %
Protection class IP	IP20	IP20
<b>Design, dimensions and weight</b>		
Design	LOGO! module	LOGO! module
Width	72 mm	72 mm
Height	90 mm	90 mm
Depth	55 mm	55 mm
Net weight	0.155 kg	0.14 kg
Mounting type		
• 35 mm DIN rail mounting	Yes	Yes
• wall mounting	Yes	Yes
• S7-300 rail mounting	No	No
<b>Product functions management, configuration</b>		
Product function switch-managed	No	No
<b>Standards, specifications, approvals</b>		
Standard		
• for EMC from FM		
• for safety of CSA and UL		
• CE mark	Yes	Yes
• C-Tick	Yes	Yes
• KC approval	No	No

**Ordering data**
**LOGO! CSM Compact Switch Modules**

Unmanaged switch for connecting a LOGO! (...0BA7) and up to three further nodes on Industrial Ethernet with 10/100 Mbit/s;  
 4 x RJ45 ports;  
 LED diagnostics, LOGO! module

- **LOGO! CSM 12/24**  
external 12 V DC or 24 V DC power supply,
- **LOGO! CSM 230**  
external 115 ... 240 V AC power supply

**6GK7177-1MA10-0AA0**
**6GK7177-1FA10-0AA0**
**Accessories**
**IE TP Cord RJ45/RJ45**

TP cable 4 x 2  
 with 2 RJ45 connectors

- 0.5 m
- 1 m
- 2 m
- 6 m
- 10 m

**6XV1870-3QE50**  
**6XV1870-3QH10**  
**6XV1870-3QH20**  
**6XV1870-3QH60**  
**6XV1870-3QN10**

**IE FC Outlet RJ45**

For connecting Industrial Ethernet FC cables and TP cords;  
 graduated prices for 10 and 50 units or more

**6GK1901-1FC00-0AA0**
**More information**
**Selection tools:**

To assist in selecting the right Industrial Ethernet switches as well as configuration of modular variants, the SIMATIC NET Selection Tool and the TIA Selection Tool are available at:

SIMATIC NET Selection Tool:

- Online version:  
<http://www.siemens.com/snst>
- Offline version:  
<http://www.siemens.com/snst-download>

TIA Selection Tool:

<http://www.siemens.com/tia-selection-tool>

## PROFINET/Industrial Ethernet

### Industrial Ethernet Switches

#### Compact switch modules

#### CSM 1277 unmanaged

#### Overview



- Unmanaged switch for connecting a SIMATIC S7-1200 to an Industrial Ethernet network with a line, tree or star topology
- Multiplication of Ethernet interfaces on a SIMATIC S7-1200 for additional connection of up to three programming devices, operator controls, and further Ethernet nodes
- Simple, space-saving mounting on the SIMATIC S7-1200 mounting rail
- Low-cost solution for implementing small, local Ethernet networks
- Connection without any problems using RJ45 standard connectors
- Simple and fast status display via LEDs on the device
- Integral autocrossover function permits use of uncrossed connecting cables

#### Benefits



- Reduction in assembly costs and mounting space compared to use of external network components
- Fast commissioning, as no configuration is necessary
- Flexible expansion of the network by simply inserting the CSM

#### Application

The CSM 1277 is an Industrial Ethernet switch of compact design for use in the SIMATIC S7-1200. The CSM 1277 can be used to multiply the Ethernet interface of the SIMATIC S7-1200 for simultaneous communication with operator panels, programming devices, other controllers, or the office world.

The CSM 1277 and the SIMATIC S7-1200 controller can be used to implement simple automation networks at low cost.

#### Design

The CSM 1277 compact switch module offers all advantages of the SIMATIC S7-1200 design:

- Compact design; the rugged plastic enclosure contains:
  - 4 x RJ45 ports for connecting to Industrial Ethernet
  - 3-pole plug-in terminal strip for connection of the external 24 V DC supply on the top
  - LEDs for diagnostics and for status display of the Industrial Ethernet ports
- Simple mounting on the mounting rail of the S7-1200
- Fanless and consequently low-maintenance design
- The module can be replaced without using a programming device

#### Function

- Multiplication of Ethernet interfaces of the SIMATIC S7-1200
- Design of a small, local Industrial Ethernet network with three further nodes
- Automatic detection of data transfer rate by means of autosensing and autocrossover functions
- LEDs for diagnostics and for status display

#### Network topology and network configuration

Various network topologies can be implemented using the CSM 1277 compact switch module:

- Connection of SIMATIC S7-1200 in linear topology: at least one RJ45 connection of the SIMATIC S7-1200 remains vacant, e.g. for connecting a programming device (PG)
- Connection of SIMATIC S7-1200 to a higher-level network in a tree/star topology: at least two RJ45 connections of the SIMATIC S7-1200 remain vacant, e.g. for connecting a programming device/operator panel (PG/OP)
- Design of a small, local network with a SIMATIC S7-1200 and three further Ethernet nodes

#### Configuration

The CSM 1277 compact switch module is an unmanaged switch and need not be configured.

#### Diagnostics

The following information is displayed on LEDs on the device:

- Power
- Port status
- Data traffic

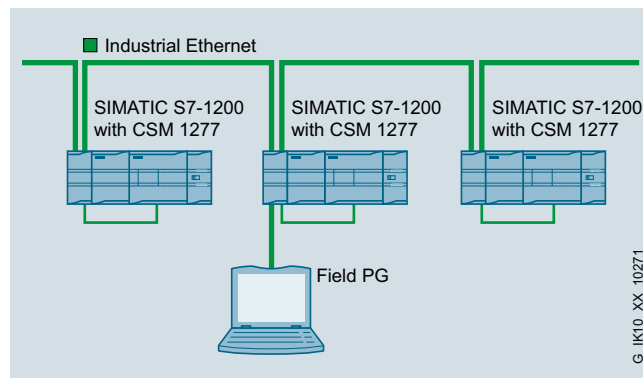

Linear topology with CSM 1277

**Technical specifications**

Article No.	6GK7277-1AA10-0AA0	Article No.	6GK7277-1AA10-0AA0
Product-type designation	CSM 1277	Product-type designation	CSM 1277
<b>Transmission rate</b>		<b>Design, dimensions and weight</b>	
Transfer rate 1	10 Mbit/s	Design	SIMATIC S7-1200 device design
Transfer rate 2	100 Mbit/s	Width	45 mm
<b>Interfaces</b>		Height	100 mm
Number of electrical/optical connections for network components or terminal equipment maximum	4	Depth	75 mm
Number of electrical connections		Net weight	0.15 kg
• for network components and terminal equipment	4	Mounting type	
• for power supply	1	• 35 mm DIN rail mounting	Yes
Design of electrical connection		• wall mounting	Yes
• for network components and terminal equipment	RJ45 port	• S7-300 rail mounting	No
• for power supply	3-pole terminal block	<b>Product functions management, configuration</b>	
<b>Supply voltage, current consumption, power loss</b>		Product function switch-managed	No
Type of supply voltage	DC	<b>Standards, specifications, approvals</b>	
Supply voltage external	24 V	Standard	
• minimum	19.2 V	• for EMC from FM	FM3611: Class 1, Division 2, Group A, B, C, D / T., CL.1, Zone 2, GP. IIC, T., Ta
• maximum	28.8 V	• for hazardous zone	EN 600079-15:2005, EN 600079-0:2006, II 3 G Ex nA II T4, KEMA 08 ATEX 0003 X
Product component fusing at power supply input	Yes	• for safety of CSA and UL	UL 508, CSA C22.2 No. 142
Type of fusing at input for supply voltage	0.5 A / 60 V	• for emitted interference	EN 61000-6-4 (Class A)
Consumed current maximum	0.07 A	• for interference immunity	EN 61000-6-2
Active power loss at 24 V for DC	1.6 W	Verification of suitability	EN 61000-6-2, EN 61000-6-4
<b>Permitted ambient conditions</b>		• CE mark	Yes
Ambient temperature		• C-Tick	Yes
• during operating	0 ... 60 °C	• KC approval	No
• during storage	-40 ... +70 °C		
• during transport	-40 ... +70 °C		
Relative humidity at 25 °C without condensation during operating maximum	95 %		
Protection class IP	IP20		

# PROFINET/Industrial Ethernet

## Industrial Ethernet Switches

### Compact switch modules

#### CSM 1277 unmanaged

Ordering data	Article No.
<b>CSM 1277 compact switch module</b> Unmanaged switch for connecting a SIMATIC S7-1200 and up to three further nodes to Industrial Ethernet with 10/100 Mbit/s; 4 x RJ45 ports; external 24 V DC power supply, diagnostics on LEDs, S7-1200 module including electronic manual on CD-ROM	<b>6GK7277-1AA10-0AA0</b>
<i>Accessories</i>	
<b>IE FC TP Trailing Cable 2 x 2 (Type C)</b> 4-core, shielded TP installation cable for connection to IE FC Outlet RJ45/IE FC RJ45 Plug 180/90 for use as trailing cable; PROFINET-compatible; with UL approval; sold by the meter; max. delivery unit 1 000 m, minimum order quantity 20 m	<b>6XV1840-3AH10</b>
<b>IE FC RJ45 Plug 180 2 x 2</b> RJ45 plug connector for Industrial Ethernet with a rugged metal housing and integrated insulation displacement contacts for connecting Industrial Ethernet FC installation cables; 180° cable outlet; for network components and CPs/CPUs with Industrial Ethernet interface <ul style="list-style-type: none"> <li>• 1 pack = 1 unit</li> <li>• 1 pack = 10 units</li> <li>• 1 pack = 50 units</li> </ul>	<b>6GK1901-1BB10-2AA0</b> <b>6GK1901-1BB10-2AB0</b> <b>6GK1901-1BB10-2AE0</b>
<b>IE FC Outlet RJ45</b> For connecting Industrial Ethernet FC cables and TP cords; graduated prices for 10 and 50 units or more	<b>6GK1901-1FC000AA0</b>
<b>IE TP Cord RJ45/RJ45</b> <ul style="list-style-type: none"> <li>• TP cord preassembled with 2 RJ45 connectors; length: 0.5 m</li> <li>• TP cable 4 x 2 with 2 RJ45 connectors; length: 0.5 m</li> </ul>	<b>6XV1850-2GE50</b>  <b>6XV1870-3QE50</b>

#### More information

##### Selection tools:

To assist in selecting the right Industrial Ethernet switches as well as configuration of modular variants, the SIMATIC NET Selection Tool and the TIA Selection Tool are available at:

SIMATIC NET Selection Tool:

- Online version:  
<http://www.siemens.com/snst>
- Offline version:  
<http://www.siemens.com/snst-download>

TIA Selection Tool:

<http://www.siemens.com/tia-selection-tool>

## Overview



- Unmanaged switch for the connection of a SIMATIC S7-300 with integral PROFINET interface or with an Industrial Ethernet CP or ET 200M to an Industrial Ethernet in an electrical linear, tree or star structure
- As many as three additional nodes can be connected
- As an unmanaged switch, the CSM 377 is used for integrating small machines into existing automation networks or for the standalone operation of the machines
- Simple, space-saving attachment to S7-300 mounting rail due to design as single-width module in S7-300 format
- Low-cost solution for implementing small, local Ethernet networks
- Rugged, industry-standard node connections with PROFINET-compliant RJ45 connectors that latch onto the enclosure to offer additional strain and bending relief

## Benefits

**get** Designed for Industry

- Quick and easy connection of a SIMATIC S7-300 or ET 200M to electrical Industrial Ethernets in linear, tree or star structures by means of three additional RJ45 ports
- Ideal solution for the implementation of small local Ethernets with a SIMATIC S7-300 station
- Secure data communication by means of industry standard device connection with PROFINET-compliant connector IE FC RJ45 Plug 180 and latching of the connector to the enclosure to provide additional strain relief
- Low-maintenance operation thanks to fanless construction
- Quick and easy diagnosis by means of LEDs on the device
- Use of uncrossed connection cables possible by means of integrated autocrossover function

## Application

- For the economical construction of small, electrical Industrial Ethernets with star, tree and linear structures using a SIMATIC S7-300 or ET 200M

## Design

The compact switch module CSM 377 features all the advantages of the SIMATIC S7-300 design:

- Compact construction; the rugged plastic enclosure features the following on the front panel:
  - 4 x RJ45 ports for the connection to Industrial Ethernet (retaining collar)
  - 1 x 2-pin pluggable terminal strip for the connection of the external 24 VDC power supply
  - LEDs for diagnostics and for status display of the Industrial Ethernet ports
- 10/100BaseTX; automatic detection of the data rate with autosensing and autocrossover function for the connection of IE FC cables by means of IE FC RJ45 Plug 180 up to 100 m
- Simple mounting; the CSM 377 switch module is mounted on the mounting rail of the S7-300. As it has no connection to the backplane bus of the S7-300 or ET 200M, it must either be inserted at the beginning (first module to the left of the CPU) or at the end (last module on far right) of the S7-300 station. The connection to the CPU of the S7-300 is either by means of an Industrial Ethernet cable or an Industrial Ethernet twisted pair cord.
- Three further Industrial Ethernet interfaces (TP ports) are available for the connection of additional Ethernet nodes such as HMI panels or ET 200
- The CSM 377 can be operated without a fan and no backup battery is necessary
- The module can be replaced without a programming device

## PROFINET/Industrial Ethernet

### Industrial Ethernet Switches

#### Compact switch modules

#### CSM 377 unmanaged

#### Function

- Connection of a SIMATIC S7-300 to a higher-level electrical network in a linear, tree or point-to-point structure
- Construction of a small local network with one SIMATIC S7-300 and three other Ethernet nodes

Thanks to the switching technology used, the CSM 377 is suitable for use in PROFINET networks, but offers no additional PROFINET functions, i.e. no integration into the PROFINET diagnostics.

#### Network topology and network configuration

When configuring the network, it is necessary to observe the following boundary conditions:

- Length of the TP cable between two nodes:
  - max. 100 m with Industrial Ethernet FastConnect cable and IE FC RJ45 Plug 180;
  - of which no more than 10 m by means of patching with TP cord

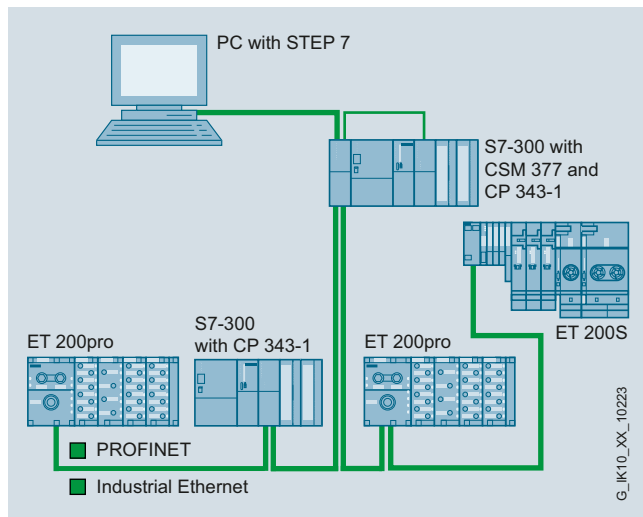

Connection of SIMATIC S7-300 with CSM 377 to Industrial Ethernet with linear structure

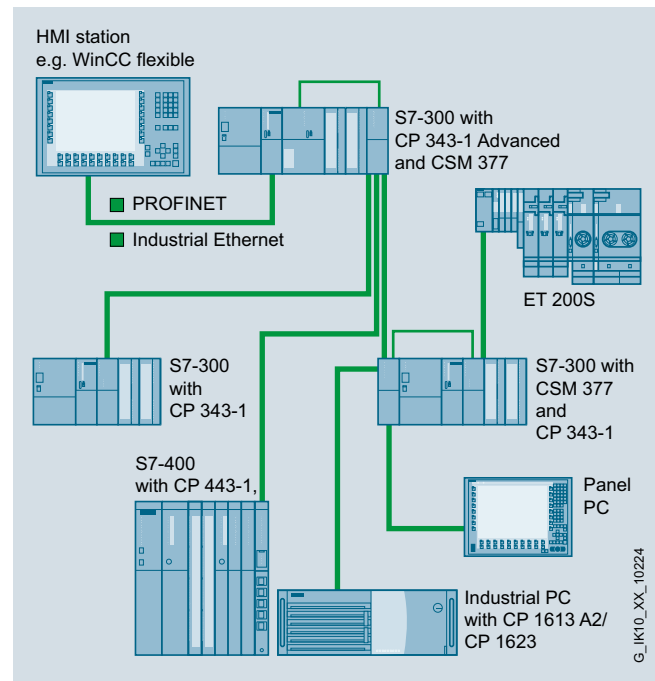

Construction of a local Industrial Ethernet with SIMATIC S7-300 and CSM 377 in a point-to-point structure

#### Configuration

The Compact Switch Module CSM 377 is an unmanaged switch and requires no configuration.

#### Diagnostics

The following information is indicated on the device by means of LEDs:

- Power
- Port status
- Data traffic



**Technical specifications**

Article No.	6GK7377-1AA00-0AA0
Product-type designation	CSM 377
<b>Transmission rate</b>	
Transfer rate 1	10 Mbit/s
Transfer rate 2	100 Mbit/s
<b>Interfaces</b>	
Number of electrical/optical connections for network components or terminal equipment maximum	4
Number of electrical connections	
• for network components and terminal equipment	4
• for power supply	1
Design of electrical connection	
• for network components and terminal equipment	RJ45 port
• for power supply	2-pole terminal block
<b>Supply voltage, current consumption, power loss</b>	
Type of supply voltage	DC
Supply voltage external	24 V
• minimum	19.2 V
• maximum	28.8 V
Product component fusing at power supply input	Yes
Type of fusing at input for supply voltage	0.5 A / 60 V
Consumed current maximum	0.07 A
Active power loss at 24 V for DC	1.6 W
<b>Permitted ambient conditions</b>	
Ambient temperature	
• during operating	0 ... 60 °C
• during storage	-40 ... +70 °C
• during transport	-40 ... +70 °C
Relative humidity at 25 °C without condensation during operating maximum	95 %
Protection class IP	IP20

Article No.	6GK7377-1AA00-0AA0
Product-type designation	CSM 377
<b>Design, dimensions and weight</b>	
Design	SIMATIC S7-300 device design
Width	40 mm
Height	125 mm
Depth	118 mm
Net weight	0.2 kg
Mounting type	
• 35 mm DIN rail mounting	No
• wall mounting	No
• S7-300 rail mounting	Yes
<b>Product functions management, configuration</b>	
Product function switch-managed	No
<b>Standards, specifications, approvals</b>	
Standard	
• for EMC from FM	FM3611: Class 1, Division 2, Group A, B, C, D / T., CL.1, Zone 2, GP. IIC, T. Ta
• for hazardous zone	EN 60079-15, II 3 G Ex nA II T., KEMA 06 ATEX 0021 X
• for safety of CSA and UL	UL 508, CSA C22.2 No. 142
• for hazardous area of CSA and UL	UL 1604 and UL 2279-15 (Hazardous Location)
• for emitted interference	EN 61000-6-4:2001
• for interference immunity	EN 61000-6-2:2001
Verification of suitability	EN 61000-6-2:2001, EN 61000-6-4:2001
• CE mark	Yes
• C-Tick	Yes
• KC approval	No

# PROFINET/Industrial Ethernet

## Industrial Ethernet Switches

### Compact switch modules

#### CSM 377 unmanaged

#### Ordering data

#### Article No.

##### Compact Switch Module CSM 377

Unmanaged switch for connecting a SIMATIC S7-300, ET200 M and up to three further nodes to Industrial Ethernet with 10/100 Mbit/s; 4 x RJ45 ports; external 24 V DC power supply, diagnostics on LEDs, S7-300 module including electronic manual on CD-ROM

**6GK7377-1AA00-0AA0**

##### Accessories

##### IE FC TP standard cable GP 2 x 2 (Type A)

4-core, shielded TP installation cable for connection to IE FC outlet RJ45/ IE FC RJ45 plug; PROFINET-compliant; with UL approval; sold by the meter; max. quantity 1 000 m, minimum order 20 m

**6XV1840-2AH10**

##### IE FC RJ45 Plug 180 2 x 2

RJ45 plug connector for Industrial Ethernet with a rugged metal housing and integrated insulation displacement contacts for connecting Industrial Ethernet FC installation cables; 180° cable outlet; for network components and CPs/CPUs with Industrial Ethernet interface

- 1 pack = 1 unit
- 1 pack = 10 units
- 1 pack = 50 units

**6GK1901-1BB10-2AA0**  
**6GK1901-1BB10-2AB0**  
**6GK1901-1BB10-2AE0**

##### IE FC stripping tool

Preadjusted stripping tool for fast stripping of the Industrial Ethernet FC cables

**6GK1901-1GA00**

#### More information

##### Selection tools:

To assist in selecting the right Industrial Ethernet switches as well as configuration of modular variants, the SIMATIC NET Selection Tool and the TIA Selection Tool are available at:

SIMATIC NET Selection Tool:

- Online version:  
<http://www.siemens.com/snst>
- Offline version:  
<http://www.siemens.com/snst-download>

TIA Selection Tool:

<http://www.siemens.com/tia-selection-tool>

**Overview**

SCALANCE X-000	Type of device	Hardware																	
		Connection to S7 backplane bus	Format module S7	PC module	Flat type of construction	Box type of construction	19" type of construction	Rugged, compact housing	Modular design	10 Gigabit Ethernet	Gigabit Ethernet	PoE (Power over Ethernet)	LED diagnosis	SIMATIC environment	Redundant power supply (2 x 24 V DC)	External supply for integrated switch	Signal contact	Local display (SET pushbutton)	C-PLUG slot
	X005 / X005TS						•					•	•	•					
	XB004-1					•							•	•					
	XB004-1G					•							•	•					
	XB004-1LD					•							•	•					
	XB004-1LDG					•							•	•					
	XB005					•							•	•					
	XB005G					•							•	•					
	XB008					•							•	•					
	XB008G					•							•	•					

• applies

G\_IK10\_XX\_10317

Function overview SCALANCE X-000 unmanaged

## PROFINET/Industrial Ethernet

### Industrial Ethernet Switches

#### SCALANCE X005 unmanaged

##### Overview



The unmanaged Industrial Ethernet Switch SCALANCE X005 is optimized for low-cost installation of small Industrial Ethernet networks with data transfer rates of 10/100 Mbit/s in a line and star topology.

- Five electrical nodes or network connections
- Rugged metal enclosure for space-saving cubicle mounting on standard rails, S7-300 DIN rails, or for wall mounting
- Rugged, industry-standard station connections with PROFINET-compatible RJ45 connectors that offer additional strain relief and bending strain relief thanks to latching on the housing
- Diagnostics on the device by means of LEDs (power, link status, data communication)

##### Product versions

- **SCALANCE X005**  
for setting up electrical star and linear topologies with five electrical ports
- **SCALANCE X005TS**  
for setting up electrical star and linear topologies with five electrical ports for use in rail and road transport with extended temperature range

##### Benefits



- Ideal solution for configuring small Industrial Ethernet line and star topologies
- Space-saving installation in the cabinet thanks to the compact design in S7-300 format
- Reliable plug-in connection thanks to rugged, industry-standard device connection in conjunction with PROFINET-compliant FastConnect connectors
- Installation is possible without a patch field by means of IE FC RJ45 Plug 180 and IE FC Standard Cable
- Use of uncrossed connection cables possible by means of integrated autocrossover function

##### Application

- For low-cost configuration of small, electrical Industrial Ethernet star and line topologies with switching functionality, e.g. machine or plant islands
- For use in the control cabinet
- The SCALANCE X005TS (**T**ransportation **S**ystems) is suitable for use in rail and road transport due to its specification according to EN 50155 and e1/E1

##### Design

The SCALANCE Industrial Ethernet switches with a rugged metal housing (IP30) are optimized for mounting on a standard rail and an S7-300 DIN rail. Direct wall mounting in different positions is also possible. Due to the housing dimensions that correspond to those of the SIMATIC S7-300, the devices are very well suited for integration into an automation solution using S7-300 components.

The SCALANCE X005 switch is equipped with:

- Supply voltage 1 x 24 V DC
- A row of LEDs for displaying status information (power, link status, data communication)
- 5 x 10/100BaseTX, RJ45 ports: automatic detection of the data rate (10 or 100 Mbit/s), with autosensing and autocrossover function for connecting IE FC cables via IE FC RJ45 Plug 180 over distances up to 100 m

### Function

- Uncrossed connecting cables can be used due to Autocrossover function integrated in the ports
- Network load disconnection through integral switch functionality

### Network topology and network configuration

The SCALANCE X005 is typically accommodated in one control cubicle together with the nodes to be connected. It can be operated in small electrical star and line topologies. Network configuration and expansion are easy to implement; there are no limitations with the cascading of SCALANCE X005.

When configuring the network, it is necessary to observe the following boundary conditions:

- Length of the TP cable between two SCALANCE X switches:  
- Max. 100 m with Industrial Ethernet FastConnect products

### Diagnostics

The following information is displayed on site by LEDs:

- Port status
- Data traffic

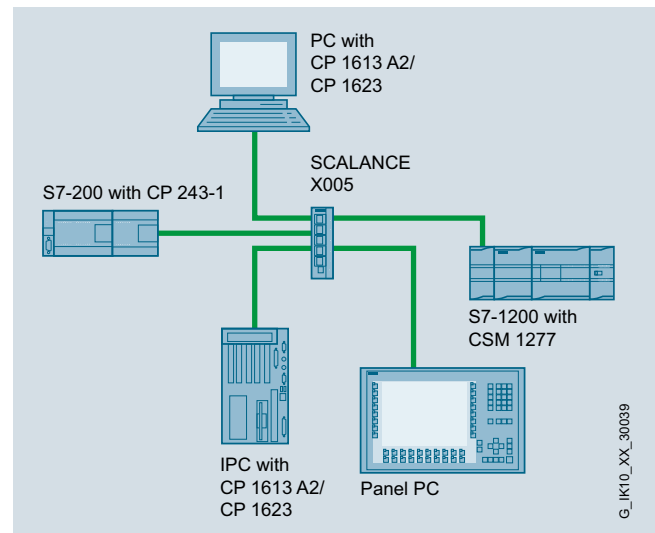

Star-shaped network topology with SCALANCE X005

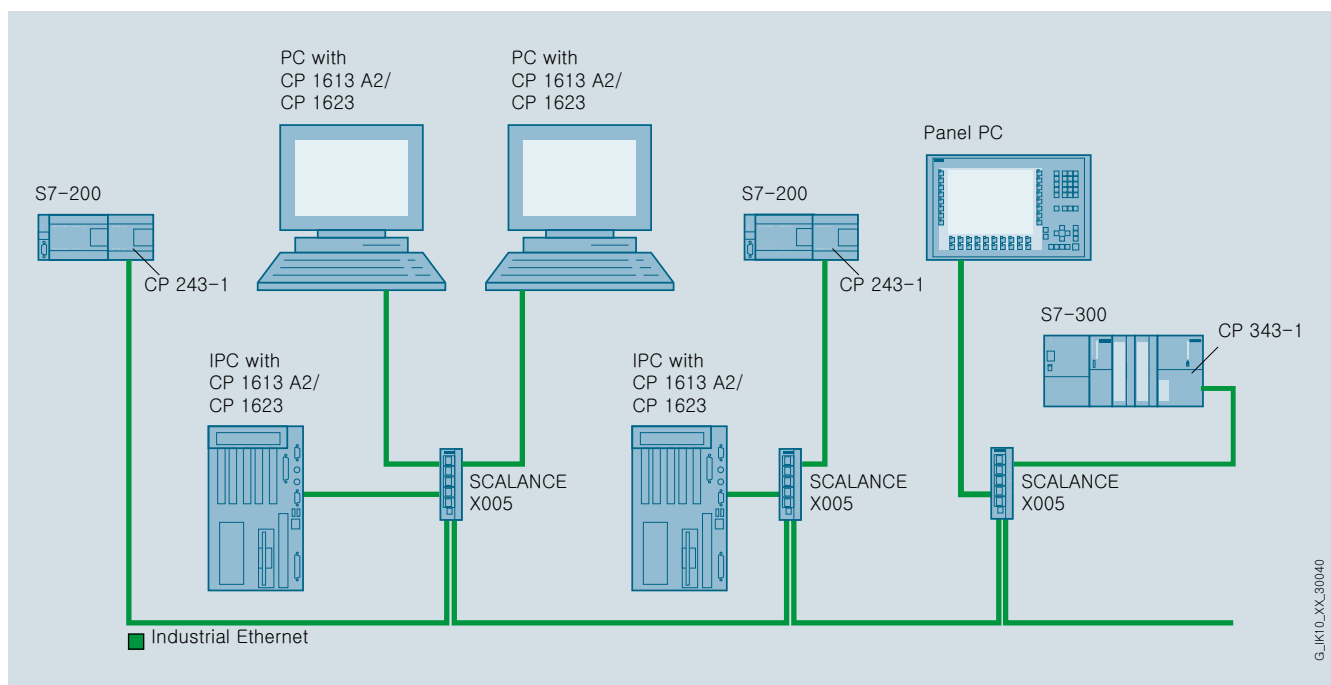

Electrical line topology with SCALANCE X005

## PROFINET/Industrial Ethernet

### Industrial Ethernet Switches

#### SCALANCE X005 unmanaged

#### Technical specifications

Article No.	6GK5005-0BA00-1AA3	6GK5005-0BA00-1CA3
Product-type designation	SCALANCE X005	SCALANCE X005TS
<b>Transmission rate</b>		
Transfer rate 1	10 Mbit/s	10 Mbit/s
Transfer rate 2	100 Mbit/s	100 Mbit/s
<b>Interfaces</b>		
Number of electrical/optical connections for network components or terminal equipment maximum	5	5
Number of electrical connections		
• for network components	5	5
• and terminal equipment		
• for power supply	1	1
Design of electrical connection		
• for network components and terminal equipment	RJ45 port	RJ45 port
• for power supply	2-pole terminal block	2-pole terminal block
<b>Supply voltage, current consumption, power loss</b>		
Type of supply voltage	DC	DC
Supply voltage external	24 V	24 V
• minimum	18 V	18 V
• maximum	32 V	32 V
Product component fusing at power supply input	Yes	Yes
Type of fusing at input for supply voltage	0.5 A / 60 V	0.5 A / 60 V
Consumed current maximum	0.08 A	0.08 A
Active power loss at 24 V for DC	2 W	2 W
<b>Permitted ambient conditions</b>		
Ambient temperature		
• during operating	0 ... 65 °C	-40 ... +75 °C
• during storage	-40 ... +80 °C	-40 ... +80 °C
• during transport	-40 ... +80 °C	-40 ... +80 °C
Relative humidity at 25 °C without condensation during operating maximum	95 %	95 %
Ambient condition for (standard) operation mode	-	Conformal coating, no
Protection class IP	IP20	IP30
<b>Design, dimensions and weight</b>		
Design	compact	compact
Width	40 mm	40 mm
Height	125 mm	125 mm
Depth	124 mm	124 mm
Net weight	0.55 kg	0.55 kg
Mounting type		
• 35 mm DIN rail mounting	Yes	Yes
• wall mounting	Yes	Yes
• S7-300 rail mounting	Yes	Yes

**Technical specifications (continued)**

Article No.	6GK5005-0BA00-1AA3	6GK5005-0BA00-1CA3
Product-type designation	SCALANCE X005	SCALANCE X005TS
<b>Standards, specifications, approvals</b>		
Standard		
• for safety of CSA and UL	UL 60950-1, CSA C22.2 No. 60950-1	UL 60950-1, CSA C22.2 No. 60950-1
• for emitted interference	EN 61000-6-4 (Class A)	EN 61000-6-4 (Class A)
• for interference immunity	EN 61000-6-2	EN 61000-6-2
Verification of suitability	EN 61000-6-2, EN 61000-6-4	EN 61000-6-2, EN 61000-6-4
• CE mark	Yes	Yes
• C-Tick	Yes	Yes
• KC approval	Yes	Yes
• E1 approval	No	Yes
• e1 approval	No	Yes
Marine classification association		
• American Bureau of Shipping Europe Ltd. (ABS)	Yes	Yes
• Bureau Veritas (BV)	Yes	Yes
• Det Norske Veritas (DNV)	No	No
• Germanische Lloyd (GL)	No	No
• Lloyds Register of Shipping (LRS)	Yes	Yes
• Nippon Kaiji Kyokai (NK)	Yes	Yes

**Ordering data**

Article No.	Article No.
<b>SCALANCE X005</b> Industrial Ethernet Switch for 10/100 Mbit/s; with five 10/100 Mbit/s RJ45 ports for configuring small star and line structures	<b>6GK5005-0BA00-1AA3</b>
<b>SCALANCE X005TS</b> Industrial Ethernet Switch for 10/100 Mbit/s; with five 10/100 Mbit/s RJ45 ports for configuring small star and line structures with extended temperature range and approvals for use in rail and road transport	<b>6GK5005-0BA00-1CA3</b>
<b>Accessories</b>	
<b>IE FC TP Standard Cable GP 2 x 2 (Type A)</b> 4-core, shielded TP installation cable for connection to IE FC Outlet RJ45/ IE FC RJ45 Plug; PROFINET-compliant; with UL approval; <u>sold by the meter</u> ; max. length 1 000 m, minimum order 20 m	<b>6XV1840-2AH10</b>
<b>IE FC RJ45 Plug 180 2 x 2</b> 180° cable outlet; for network components and CPs/CPUs with Industrial Ethernet interface • 1 pack = 1 unit • 1 pack = 10 units • 1 pack = 50 units	<b>6GK1901-1BB10-2AA0</b> <b>6GK1901-1BB10-2AB0</b> <b>6GK1901-1BB10-2AE0</b>
<b>IE FC Stripping Tool</b> Preadjusted stripping tool for fast stripping of the Industrial Ethernet FC cables	<b>6GK1901-1GA00</b>
<b>SITOP compact 24 V/ 0.6 A</b> 1-phase power supply with wide-range input 85 - 264 V AC/110 - 300 V DC, stabilized output voltage 24 V, rated output current value 0.6 A, slim design	<b>6EP1331-5BA00</b>

**More information**
**Selection tools:**

To assist in selecting the right Industrial Ethernet switches as well as configuration of modular variants, the SIMATIC NET Selection Tool and the TIA Selection Tool are available at:

SIMATIC NET Selection Tool:

- Online version:  
<http://www.siemens.com/snst>
- Offline version:  
<http://www.siemens.com/snst-download>

TIA Selection Tool:

<http://www.siemens.com/tia-selection-tool>

## PROFINET/Industrial Ethernet

### Industrial Ethernet Switches

#### SCALANCE XB-000 unmanaged

##### Overview

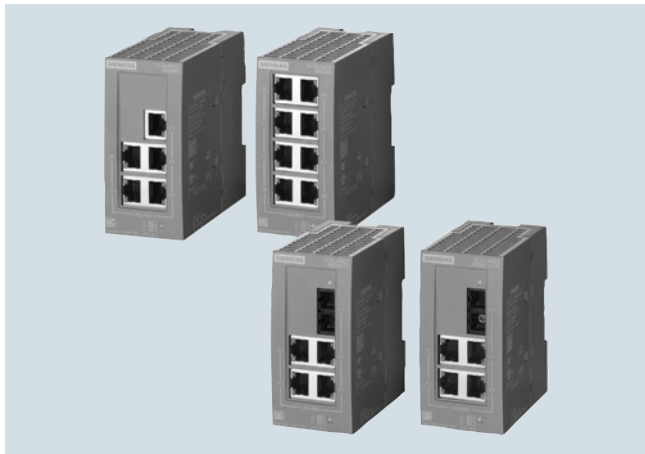

The unmanaged Industrial Ethernet switches of the SCALANCE XB-000 line are optimized for installing Industrial Ethernet networks in a line and star topology.

- Enclosure for space-saving installation in control cabinets or boxes on a standard mounting rail

##### Product versions

###### *SCALANCE XB005 and SCALANCE XB008*

- 5 or 8 x 10/100 Mbit/s RJ45 ports, electrical

###### *SCALANCE XB005G and SCALANCE XB008G (Gigabit)*

- 5 or 8 x 10/100/1 000 Mbit/s RJ45 ports, electrical

###### *SCALANCE XB004-1*

- 4 x 10/100 Mbit/s RJ45 ports, electrical
- 1 x 100 Mbit/s SC port, optical (multi-mode, glass), up to 5 km

###### *SCALANCE XB004-1LD (Long Distance)*

- 4 x 10/100 Mbit/s RJ45 ports, electrical
- 1 x 100 Mbit/s SC port, optical (single-mode, glass), up to 26 km

###### *SCALANCE XB004-1G (Gigabit)*

- 4 x 10/100/1 000 Mbit/s RJ45 ports, electrical
- 1 x 1000 Mbit/s SC port, optical (multi-mode, glass), up to 750 m

###### *SCALANCE XB004-1LDG (Long Distance)*

- 4 x 10/100/1000 Mbit/s RJ45 ports, electrical
- 1 x 1 000 Mbit/s SC port, optical (single-mode, glass), up to 10 km

##### Benefits

get **Designed for Industry**

- Implementation of simple and very economical machine networking
- Space-saving installation thanks to small, compact design
- Can be used in industrial environments
- Quick commissioning without configuration
- Easy on-site diagnostics via LEDs
- Uncomplicated use of uncrossed connecting cables possible thanks to the integrated Autocrossover function
- Low-cost connection of especially remote nodes possible

##### Application

The unmanaged Industrial Ethernet switches of the SCALANCE XB-000 line allow cost-effective solutions for setting up small, electrical/optical star or line topologies with switching functionality in machines or plant units.

The enclosure is designed for space-saving installation in a control cabinet on a standard rail.



### Design

The SCALANCE XB-000 Industrial Ethernet switches are optimized for installation on a standard rail. Wall mounting is possible.

The SCALANCE XB-000 switches have:

- A 3-pole terminal block for connecting the power supply (1 x 24 V DC) and functional ground
- An LED for indicating the status information (power)
- LEDs for indicating the status information (link status and data exchange) per port

The following port types are available:

- 10/100 BaseTX electrical RJ45 ports or 10/100/1 000 BaseTX electrical RJ45 ports:  
automatic data transmission rate detection (10 or 100 Mbit/s), with Autosensing and Autocrossing function for connecting IE TP cables up to 100 m.
- 100 BaseFX, optical SC port:  
for direct connection to Industrial Ethernet FO cables. Multimode fiber-optic cable up to 5 km
- 100 BaseFX, optical SC port:  
for direct connection to Industrial Ethernet FO cables. Single mode fiber-optic cable up to 26 km
- 1000 BaseSX, optical SC port:  
for direct connection to Industrial Ethernet FO cables. Multimode fiber-optic cable up to 750 m
- 1000 BaseLX, optical SC port:  
for direct connection to Industrial Ethernet FO cables. Single mode fiber-optic cable up to 10 km

All connections for data cables are located at the front, and the connection for the power supply is at the bottom.

### Function

- Construction of electrical Industrial Ethernet line or star topologies
- Automatic data transmission rate detection (10/100/1 000 Mbit/s), with autosensing and autocrossover function
- Easy network configuration and network expansion; no limitation on network expansion with cascading of the switches

### Network topology and network configuration

The SCALANCE XB-000 switches are typically installed with the stations to be connected in a control cabinet or control box.

When configuring the network, it is necessary to observe the following boundary conditions:

- Length of the TP cable between two SCALANCE XB-000 switches:
  - max. 100 m
  - max. 10 m via patch cables with TP Cord
  - max. 100 m via Industrial Ethernet FC Outlet RJ45, IE FC Standard Cable and TP Cord
- Length of the fiber-optic cables:
  - max. 5 km with Industrial Ethernet FO cables Multimode
  - max. 26 km with Industrial Ethernet FO cables Single mode

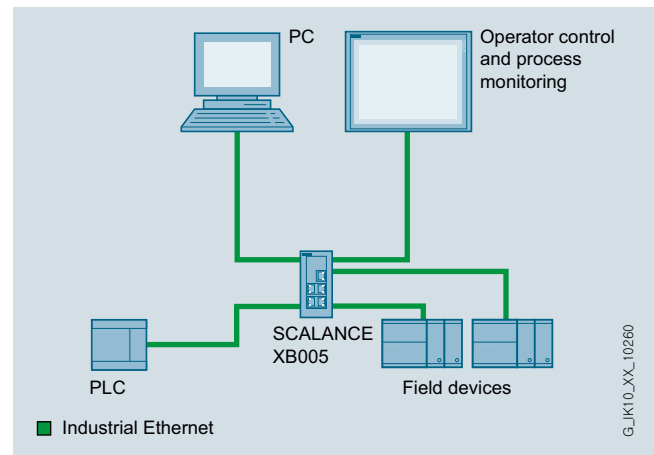

Electrical star topology with SCALANCE XB005 or SCALANCE XB005G

# PROFINET/Industrial Ethernet

## Industrial Ethernet Switches

### SCALANCE XB-000 unmanaged

#### Function (continued)

2

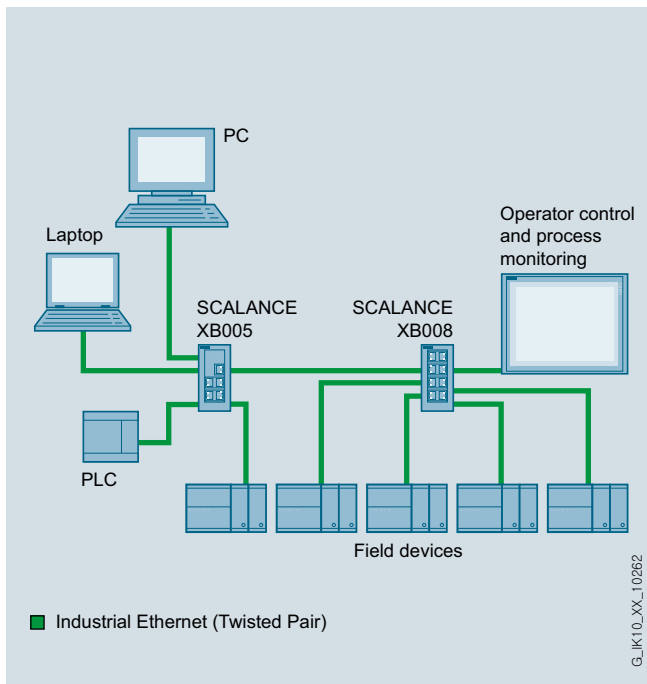

Electrical line topology with SCALANCE XB005 and XB008, or SCALANCE XB005G and XB008G

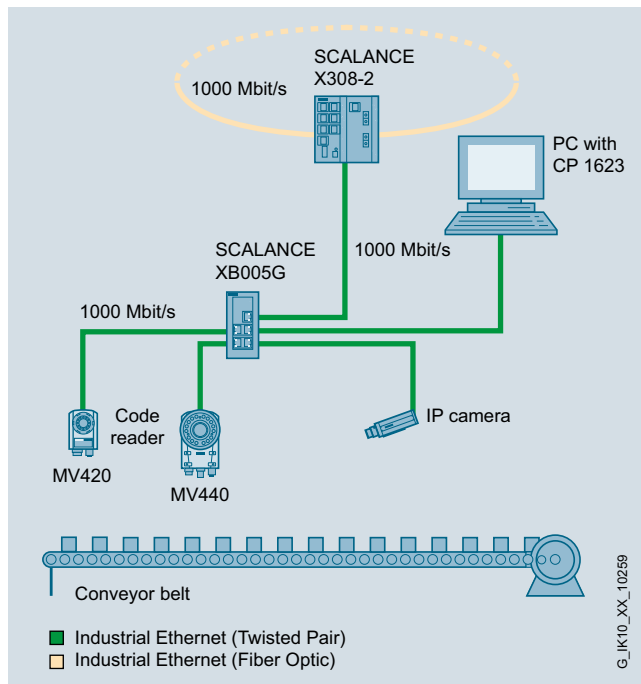

Electrical star topology with SCALANCE XB005G and connection to a Gigabit Ethernet ring

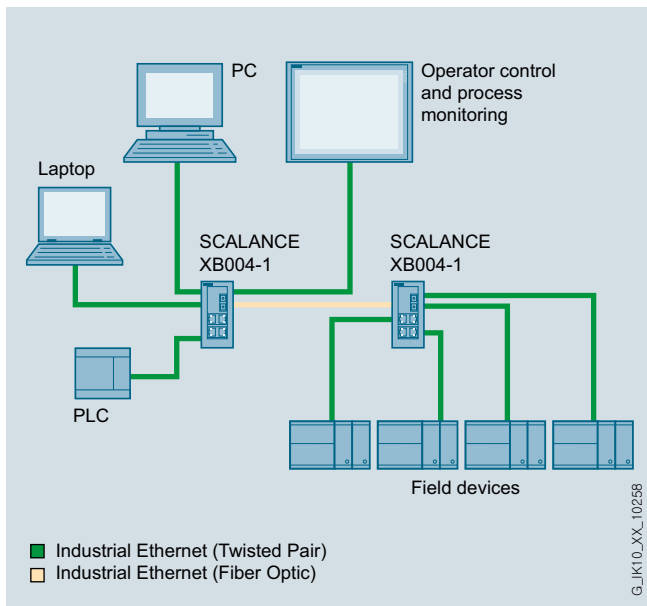

Mixed star topology with SCALANCE XB004-1 or SCALANCE XB004-1G

#### Diagnostics

The following information is displayed by LEDs on site:

- Power
- Port status
- Data traffic

**Technical specifications**

Article No.	6GK5004-1BD00-1AB2	6GK5004-1BF00-1AB2	6GK5005-0BA00-1AB2	6GK5008-0BA00-1AB2
Product-type designation	SCALANCE XB004-1	SCALANCE XB004-1LD	SCALANCE XB005	SCALANCE XB008
<b>Transmission rate</b>				
Transfer rate 1	10 Mbit/s	10 Mbit/s	10 Mbit/s	10 Mbit/s
Transfer rate 2	100 Mbit/s	100 Mbit/s	100 Mbit/s	100 Mbit/s
<b>Interfaces</b>				
Number of electrical/optical connections for network components or terminal equipment maximum	5	5	5	8
Number of electrical connections				
• for network components	4	4	5	8
• and terminal equipment				
• for power supply	1	1	1	1
Design of electrical connection				
• for network components and terminal equipment	RJ45 port	RJ45 port	RJ45 port	RJ45 port
• for power supply	3-pole terminal block	3-pole terminal block	3-pole terminal block	3-pole terminal block
Number of optical interfaces for optical waveguide				
• at 100 Mbit/s	1	1	-	-
Design of optical interface for optical waveguide				
• at 100 Mbit/s	SC port (multimode up to 5 km)	SC port (singlemode up to 26 km)	-	-
Connectable optical power relative to 1 mW				
• of the transmitter output	-19 ... -14 dB	-5 ... +0 dB	--	--
• of the receiver input maximum	-14 dB	0 dB	-	-
Optical sensitivity relative to 1 mW of the receiver input minimum	-32 dB	-34 dB	-	-
Attenuation of fiber-optic cable transmission link minimum necessary	0 dB	0 dB	-	-
Range at the optical interface depending on the optical fiber used	0 ... 5 km	0 ... 26 km	--	--
<b>Supply voltage, current consumption, power loss</b>				
Type of supply voltage	DC	DC	DC	DC
Supply voltage external	24 V	24 V	24 V	24 V
• minimum	19.2 V	19.2 V	19.2 V	19.2 V
• maximum	28.8 V	28.8 V	28.8 V	28.8 V
Product component fusing at power supply input	Yes	Yes	Yes	Yes
Type of fusing at input for supply voltage	0.6 A / 60 V	0.6 A / 60 V	0.6 A / 60 V	0.6 A / 60 V
Consumed current maximum	0.11 A	0.1 A	0.07 A	0.12 A
Active power loss at 24 V for DC	2.64 W	2.4 W	1.68 W	2.88 W
<b>Permitted ambient conditions</b>				
Ambient temperature				
• during operating	-10 ... +60 °C	-10 ... +60 °C	-10 ... +60 °C	-10 ... +60 °C
• during storage	-40 ... +80 °C	-40 ... +80 °C	-40 ... +80 °C	-40 ... +80 °C
• during transport	-40 ... +80 °C	-40 ... +80 °C	-40 ... +80 °C	-40 ... +80 °C
Relative humidity at 25 °C without condensation during operating maximum	95 %	95 %	95 %	95 %
Protection class IP	IP20	IP20	IP20	IP20

## PROFINET/Industrial Ethernet

### Industrial Ethernet Switches

#### SCALANCE XB-000 unmanaged

#### Technical specifications (continued)

Article No.	6GK5004-1BD00-1AB2	6GK5004-1BF00-1AB2	6GK5005-0BA00-1AB2	6GK5008-0BA00-1AB2
Product-type designation	SCALANCE XB004-1	SCALANCE XB004-1LD	SCALANCE XB005	SCALANCE XB008
<b>Design, dimensions and weight</b>				
Design	Box	Box	Box	Box
Width	45 mm	45 mm	45 mm	45 mm
Height	100 mm	100 mm	100 mm	100 mm
Depth	87 mm	87 mm	87 mm	87 mm
Net weight	0.165 kg	0.165 kg	0.165 kg	0.18 kg
Mounting type				
• 35 mm DIN rail mounting	Yes	Yes	Yes	Yes
• wall mounting	Yes	Yes	Yes	Yes
<b>Standards, specifications, approvals</b>				
Standard				
• for safety of CSA and UL	UL 60950-1, CSA C22.2 No. 60950-1	UL 60950-1, CSA C22.2 No. 60950-1	UL 60950-1, CSA C22.2 No. 60950-1	UL 60950-1, CSA C22.2 No. 60950-1
• for emitted interference	EN 61000-6-4 (Class A)	EN 61000-6-4 (Class A)	EN 61000-6-4 (Class A)	EN 61000-6-4 (Class A)
• for interference immunity	EN 61000-6-2	EN 61000-6-2	EN 61000-6-2	EN 61000-6-2
Verification of suitability	EN 61000-6-2, EN 61000-6-4	EN 61000-6-2, EN 61000-6-4	EN 61000-6-2, EN 61000-6-4	EN 61000-6-2, EN 61000-6-4
• CE mark	Yes	Yes	Yes	Yes
• C-Tick	Yes	Yes	Yes	Yes
• KC approval	Yes	Yes	Yes	Yes

Article No.	6GK5004-1GL00-1AB2	6GK5004-1GM00-1AB2	6GK5005-0GA00-1AB2	6GK5008-0GA00-1AB2
Product-type designation	SCALANCE XB004-1G	SCALANCE XB004-1LDG	SCALANCE XB005G	SCALANCE XB008G
<b>Transmission rate</b>				
Transfer rate 1	10 Mbit/s	10 Mbit/s	10 Mbit/s	10 Mbit/s
Transfer rate 2	100 Mbit/s	100 Mbit/s	100 Mbit/s	100 Mbit/s
Transfer rate 3	1 000 Mbit/s	1 000 Mbit/s	1 000 Mbit/s	1 000 Mbit/s
<b>Interfaces</b>				
Number of electrical/optical connections for network components or terminal equipment maximum	5	5	5	8
Number of electrical connections				
• for network components and terminal equipment	4	4	5	8
• for power supply	1	1	1	1
Design of electrical connection				
• for network components and terminal equipment	RJ45 port	RJ45 port	RJ45 port	RJ45 port
• for power supply	3-pole terminal block	3-pole terminal block	3-pole terminal block	3-pole terminal block
Number of optical interfaces for optical waveguide				
• at 1000 Mbit/s	1	1	-	-
Design of optical interface for optical waveguide				
• at 1000 Mbit/s	SC port (multimode up to 0.75 km)	SC port (singlemode up to 10 km)	-	-
Connectable optical power relative to 1 mW				
• of the transmitter output	-9.5 ... -4 dB	-9.5 ... -3 dB	-	-
• of the receiver input maximum	-3 dB	-3 dB	-	-
Optical sensitivity relative to 1 mW of the receiver input minimum	-17 dB	-21 dB	-	-
Attenuation of fiber-optic cable transmission link minimum necessary	0 dB	0 dB	-	-
Range at the optical interface depending on the optical fiber used	0 ... 0.75 km	0 ... 10 km	-	-

**Technical specifications (continued)**

Article No.	6GK5004-1GL00-1AB2	6GK5004-1GM00-1AB2	6GK5005-0GA00-1AB2	6GK5008-0GA00-1AB2
Product-type designation	SCALANCE XB004-1G	SCALANCE XB004-1LDG	SCALANCE XB005G	SCALANCE XB008G
<b>Supply voltage, current consumption, power loss</b>				
Type of supply voltage	DC	DC	DC	DC
Supply voltage external	24 V	24 V	24 V	24 V
• minimum	19.2 V	19.2 V	19.2 V	19.2 V
• maximum	28.8 V	28.8 V	28.8 V	28.8 V
Product component fusing at power supply input	Yes	Yes	Yes	Yes
Type of fusing at input for supply voltage	0.6 A / 60 V	0.6 A / 60 V	0.6 A / 60 V	0.6 A / 60 V
Consumed current maximum	0.52 A	0.52 A	0.44 A	0.52 A
Active power loss at 24 V for DC	12.5 W	12.5 W	10.5 W	12.5 W
<b>Permitted ambient conditions</b>				
Ambient temperature				
• during operating	-10 ... +60 °C	-10 ... +60 °C	-10 ... +60 °C	-10 ... +60 °C
• during storage	-40 ... +80 °C	-40 ... +80 °C	-40 ... +80 °C	-40 ... +80 °C
• during transport	-40 ... +80 °C	-40 ... +80 °C	-40 ... +80 °C	-40 ... +80 °C
Relative humidity at 25 °C without condensation during operating maximum	95 %	95 %	95 %	95 %
Protection class IP	IP20	IP20	IP20	IP20
<b>Design, dimensions and weight</b>				
Design	Box	Box	Box	Box
Width	45 mm	45 mm	45 mm	45 mm
Height	100 mm	100 mm	100 mm	100 mm
Depth	87 mm	87 mm	87 mm	87 mm
Net weight	0.21 kg	0.21 kg	0.22 kg	0.26 kg
Mounting type				
• 35 mm DIN rail mounting	Yes	Yes	Yes	Yes
• wall mounting	Yes	Yes	Yes	Yes
<b>Standards, specifications, approvals</b>				
Standard				
• for safety of CSA and UL	UL 60950-1, CSA C22.2 No. 60950-1	UL 60950-1, CSA C22.2 No. 60950-1	UL 60950-1, CSA C22.2 No. 60950-1	UL 60950-1, CSA C22.2 No. 60950-1
• for emitted interference	EN 61000-6-4 (Class A)	EN 61000-6-4 (Class A)	EN 61000-6-4 (Class B)	EN 61000-6-4 (Class B)
• for interference immunity	EN 61000-6-2	EN 61000-6-2	EN 61000-6-2	EN 61000-6-2
Verification of suitability	EN 61000-6-2, EN 61000-6-4	EN 61000-6-2, EN 61000-6-4	EN 61000-6-2, EN 61000-6-4	EN 61000-6-2, EN 61000-6-4
• CE mark	Yes	Yes	Yes	Yes
• C-Tick	Yes	Yes	Yes	Yes
• KC approval	Yes	Yes	Yes	Yes

## PROFINET/Industrial Ethernet

### Industrial Ethernet Switches

#### SCALANCE XB-000 unmanaged

##### Ordering data

##### Article No.

##### SCALANCE XB-000 Industrial Ethernet switches

Unmanaged Industrial Ethernet switches for 10/100/1 000 Mbit/s, degree of protection IP20, incl. operating instructions, Industrial Ethernet network manual on CD-ROM

<ul style="list-style-type: none"> <li>• <b>SCALANCE XB005</b> 5 x 10/100 Mbit/s RJ45 ports electrical</li> </ul>	<b>6GK5005-0BA00-1AB2</b>
<ul style="list-style-type: none"> <li>• <b>SCALANCE XB008</b> 8 x 10/100 Mbit/s RJ45 ports electrical</li> </ul>	<b>6GK5008-0BA00-1AB2</b>
<ul style="list-style-type: none"> <li>• <b>SCALANCE XB004-1</b> 4 x 10/100 Mbit/s RJ45 ports electrical 1x 100 Mbit/s SC port optical (multimode, glass), up to 5 km</li> </ul>	<b>6GK5004-1BD00-1AB2</b>
<ul style="list-style-type: none"> <li>• <b>SCALANCE XB004-1LD</b> 4 x 10/100 Mbit/s RJ45 ports electrical 1x 100 Mbit/s SC port optical (singlemode, glass), up to 26 km</li> </ul>	<b>6GK5004-1BF00-1AB2</b>
<ul style="list-style-type: none"> <li>• <b>SCALANCE XB005G</b> 5 x 10/100/1 000 Mbit/s electrical RJ45 ports</li> </ul>	<b>6GK5005-0GA00-1AB2</b>
<ul style="list-style-type: none"> <li>• <b>SCALANCE XB008G</b> 8 x 10/100/1 000 Mbit/s electrical RJ45 ports</li> </ul>	<b>6GK5008-0GA00-1AB2</b>
<ul style="list-style-type: none"> <li>• <b>SCALANCE XB004-1G</b> 4 x 10/100/1 000 Mbit/s RJ45 electrical ports 1x 1 000 Mbit/s optical SC port (multimode, glass), up to 0.75 km</li> </ul>	<b>6GK5004-1GL00-1AB2</b>
<ul style="list-style-type: none"> <li>• <b>SCALANCE XB004-1LDG</b> 4 x 10/100/1 000 Mbit/s electrical RJ45 ports 1x 1 000 Mbit/s SC optical port (singlemode, glass), up to 10 km</li> </ul>	<b>6GK5004-1GM00-1AB2</b>

##### Accessories

##### IE TP Cord RJ45/RJ45

TP cable 4 x 2 with 2 RJ45 connectors

• 0.5 m	<b>6XV1870-3QE50</b>
• 1 m	<b>6XV1870-3QH10</b>
• 2 m	<b>6XV1870-3QH20</b>
• 6 m	<b>6XV1870-3QH60</b>
• 10 m	<b>6XV1870-3QN10</b>

##### FO Standard Cable GP 50/125/1400 <sup>1) 2)</sup>

Multimode cable, sold by the meter; max. length 1 000 m; minimum order 20 m;

**6XV1873-2A**

##### SITOP compact 24 V/0.6 A

1-phase power supply with wide-range input 85 – 264 V AC/110 – 300 V DC, stabilized output voltage 24 V, rated output current value 0.6 A, slim design

**6EP1331-5BA00**

<sup>1)</sup> Special fiber-optic cables, lengths and accessories available on request

<sup>2)</sup> Special tools and trained personnel are required for pre-assembling glass fiber-optic cables

##### More information

##### Selection tools:

To assist in selecting the right Industrial Ethernet switches as well as configuration of modular variants, the SIMATIC NET Selection Tool and the TIA Selection Tool are available at:

SIMATIC NET Selection Tool:

- Online version:  
<http://www.siemens.com/snst>
- Offline version:  
<http://www.siemens.com/snst-download>

TIA Selection Tool:

<http://www.siemens.com/tia-selection-tool>

**Overview**

SCALANCE X-100	Type of device	Hardware																
		Connection to S7 backplane bus	Format module S7	PC module	Flat type of construction	Box type of construction	19" type of construction	Rugged, compact housing	Modular design	10 Gigabit Ethernet	Gigabit Ethernet	PoE (Power over Ethernet)	LED diagnosis	SIMATIC environment	Redundant power supply (2 x 24 V DC)	External supply for integrated switch	Signal contact	Local display (SET pushbutton)
	X104-2						•					•	•	•		•	•	
	X106-1						•					•	•	•		•	•	
	X108						•					•	•	•		•	•	
	X108PoE						•				•	•	•	•		•	•	
	X112-2						•					•	•	•		•	•	
	X116						•					•	•	•		•	•	
	X124						•					•	•	•		•	•	

• applies

G\_IK10\_XX\_10316

Function overview SCALANCE X-100 unmanaged

## PROFINET/Industrial Ethernet

### Industrial Ethernet Switches

#### SCALANCE X-100 unmanaged

#### Overview



The unmanaged Industrial Ethernet switches of the SCALANCE X-100 product line are optimized for installing Industrial Ethernet networks at transmission rates of 10/100 Mbit/s in a line and star topology.

- Depending on the port type of the devices, the connection to a station or network is electrical or optical with Power-over-Ethernet (PoE) functionality according to IEEE 802.3af Type 1 (corresponds to IEEE 802.3af)
- Rugged metal enclosure for space-saving cubicle mounting on standard rails, S7-300 DIN rails, or for wall mounting
- Rugged, industry-standard station connections with PROFINET-compatible RJ45 connectors that offer additional strain relief and bending strain relief thanks to latching on the housing
- Redundant power supply
- Diagnostics on the device by means of LEDs (power, link status, data communication)
- Error signaling contact with easy adjustment using the SET button

#### Product versions

##### SCALANCE X104-2 / SCALANCE X106-1 / SCALANCE X112-2

- Construction of optical Industrial Ethernet line or star topologies:
  - SCALANCE X104-2; with 4 electrical ports and 2 optical ports
  - SCALANCE X106-1; with 6 electrical ports and 1 optical port
  - SCALANCE X112-2; with 12 electrical ports and 2 optical ports
- Diagnostics on the device using LEDs (power, link status, data traffic) and signaling contact (alarm screen form can be set using a button on the device)
- The RJ45 ports are suitable for industrial use and have additional retaining collars: optimized for connecting the IE FC RJ45 Plug 180

##### SCALANCE X108 / SCALANCE X108PoE / SCALANCE X116 / SCALANCE X124

- Construction of electrical Industrial Ethernet star and line topologies
  - SCALANCE X108 with eight electrical ports
  - SCALANCE X108PoE with eight electrical ports, two of which have Power-over-Ethernet functionality
  - SCALANCE X116 with 16 electrical ports
  - SCALANCE X124 with 24 electrical ports
- Diagnostics on the device using LEDs (power, link status, data traffic) and signaling contact (alarm screen form can be set using a button on the device)
- The RJ45 ports are suitable for industrial use and have additional retaining collars: optimized for connecting the IE FC RJ45 Plug 180

#### Benefits



- Ideal solution for configuring Industrial Ethernet line and star topologies
- Reduction of network installation costs by transmitting data and energy (Power-over-Ethernet) via the conventional 4-core Industrial Ethernet cable (only SCALANCE X108PoE)
- Additional power supply units can be omitted thanks to generating the Power-over-Ethernet voltage (48 V DC) direct at the switch (SCALANCE X108PoE only)
- Space-saving installation in the cabinet thanks to the compact design in S7-300 format
- Reliable plug-in connection thanks to industry-standard device connection in conjunction with PROFINET-compliant FastConnect connectors
- Installation is possible without a patch field by means of IE FC RJ45 Plug 180 and IE FC Standard Cable
- Use of uncrossed connection cables possible by means of integrated autocrossover function

#### Application

The switches of the SCALANCE X-100 product line support the inexpensive construction of Industrial Ethernet line or star topologies with switching functions. They are designed for installation in the control cabinet.



## Design

The SCALANCE Industrial Ethernet switches with a rugged metal housing are optimized for mounting on a standard rail and an S7-300 rail. Direct wall mounting in various positions is also possible. Due to the dimensions of the housing that conform to those of SIMATIC S7-300, the devices are optimized for integration in an automation solution with S7-300 components.

The SCALANCE X-100 switches have:

- A 4-pole terminal block for connecting the redundant supply voltage (2 x 24 V DC)
- A row of LEDs for displaying status information (power, link status, data communication, signaling contact)
- A 2-pole terminal block for connecting the floating signaling contact
- A SET button for on-site configuration of the signaling contact

The following port types are available:

- **10/100BaseTX, RJ45 port;**  
automatic detection of the transmission rate (10 or 100 Mbit/s), with autosensing and autocrossover functions for connecting IE FC cables using IE FC RJ45 Plug 180 up to 100 m
- **10/100BaseTX, RJ45 ports and Power-over-Ethernet functionality;**  
automatic detection of the transmission rate (10 or 100 Mbit/s), with autosensing and autocrossover functions for connecting IE FC cables using IE FC RJ45 Plug 180 up to 100 m and integrated Power-over-Ethernet functionality according to IEEE 802.3at Type 1
- **100BaseFX, BFOC port;**  
for direct connection to the Industrial Ethernet glass FOC up to 5 km

## Function

- Construction of electrical and optical Industrial Ethernet line or star topologies
- Use of uncrossed connecting leads is possible due to integrated auto-crossover function of the ports
- Power supply of Power-over-Ethernet-capable terminal equipment via the data line for SCALANCE X108PoE
- Isolation of the load due to integrated switch functions
- Easy network configuration and network expansion; no limitation of the expansion of the network when switches of the SCALANCE X-100 product line are cascaded

### Network topology and network configuration

The SCALANCE X-100 switches are typically installed with the stations to be connected in a control cabinet. They can be mixed electrically and optically in star and line topologies.

When configuring the network, it is necessary to observe the following boundary conditions:

- Length of the TP cable between SCALANCE X switches:
  - Max. 100 m with Industrial Ethernet FastConnect products
- Length of the TP cable between SCALANCE X switch and Power-over-Ethernet terminal equipment:
  - Max. 100 m with Industrial Ethernet FastConnect products
- Length of the fiber-optic cables:
  - Max. 5 km with Industrial Ethernet glass fiber-optic cables

# PROFINET/Industrial Ethernet

## Industrial Ethernet Switches

### SCALANCE X-100 unmanaged

#### Function (continued)

2

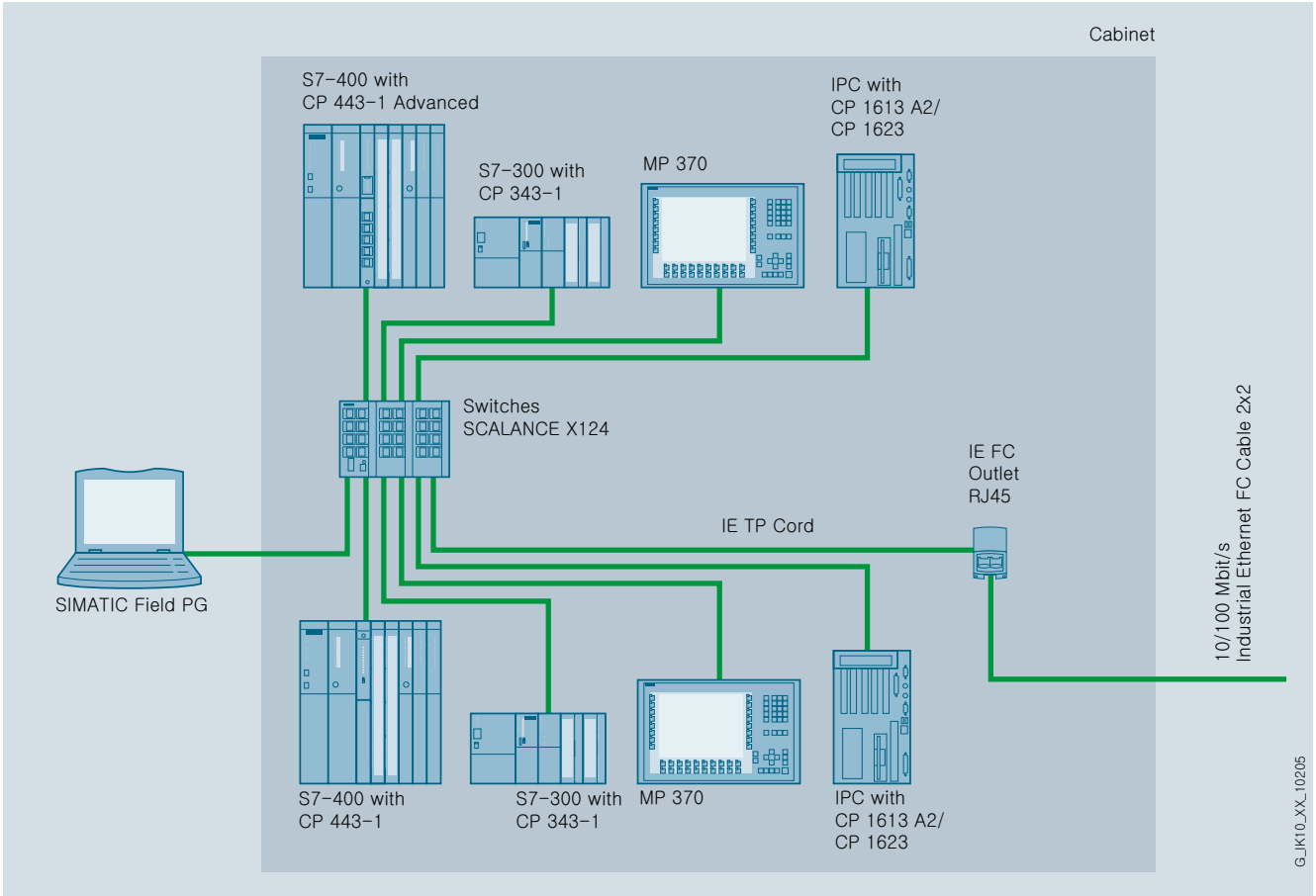

Star-shaped network topology with SCALANCE X124

G\_JK10\_XX\_10205

**Function** (continued)

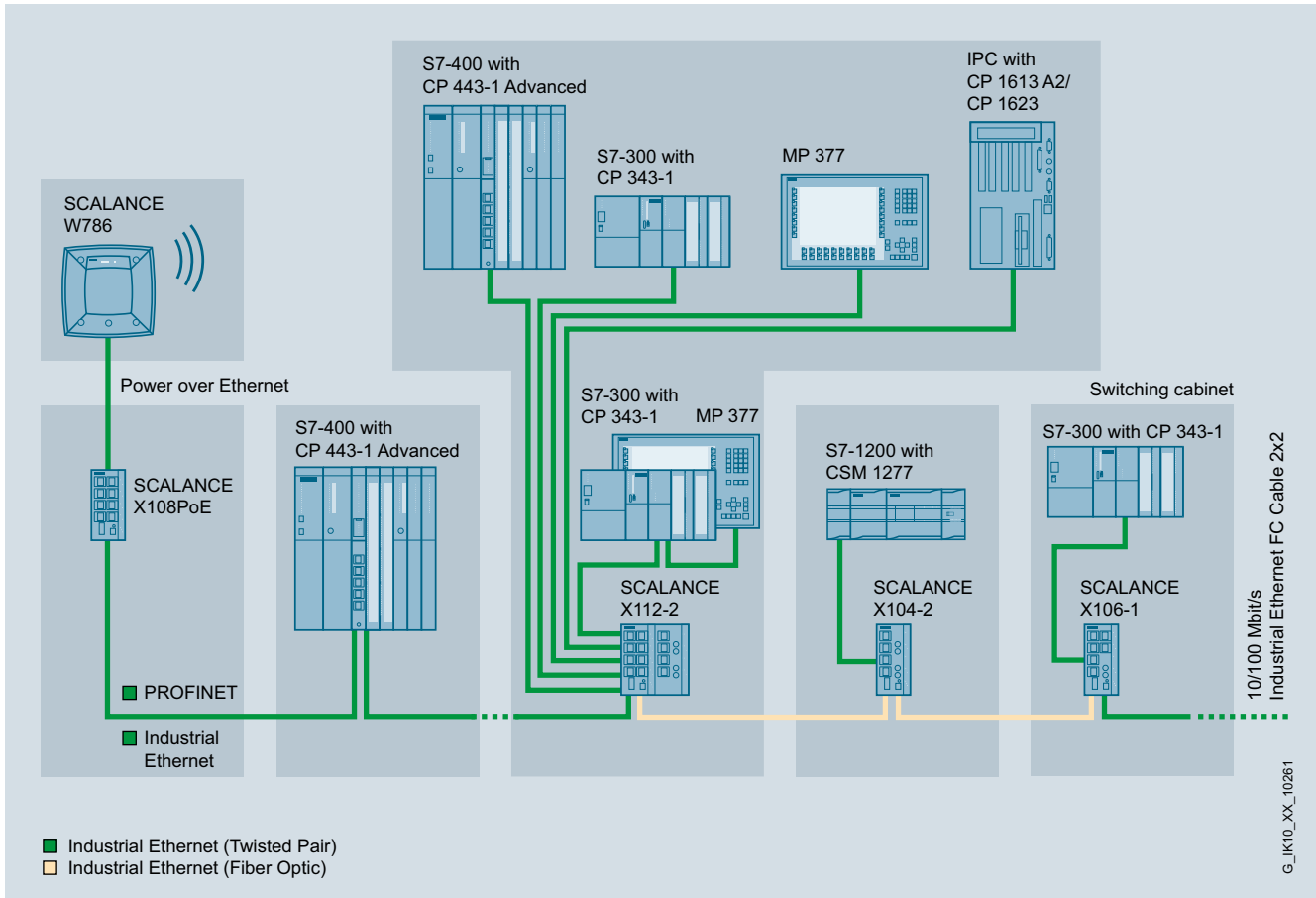

Electrical and optical line topology with SCALANCE X112-2, X104-2 and X106-1 as well as connection and supply of data terminals with Power-over-Ethernet (PoE) by SCALANCE X108PoE

## PROFINET/Industrial Ethernet

### Industrial Ethernet Switches

#### SCALANCE X-100 unmanaged

#### Function (continued)

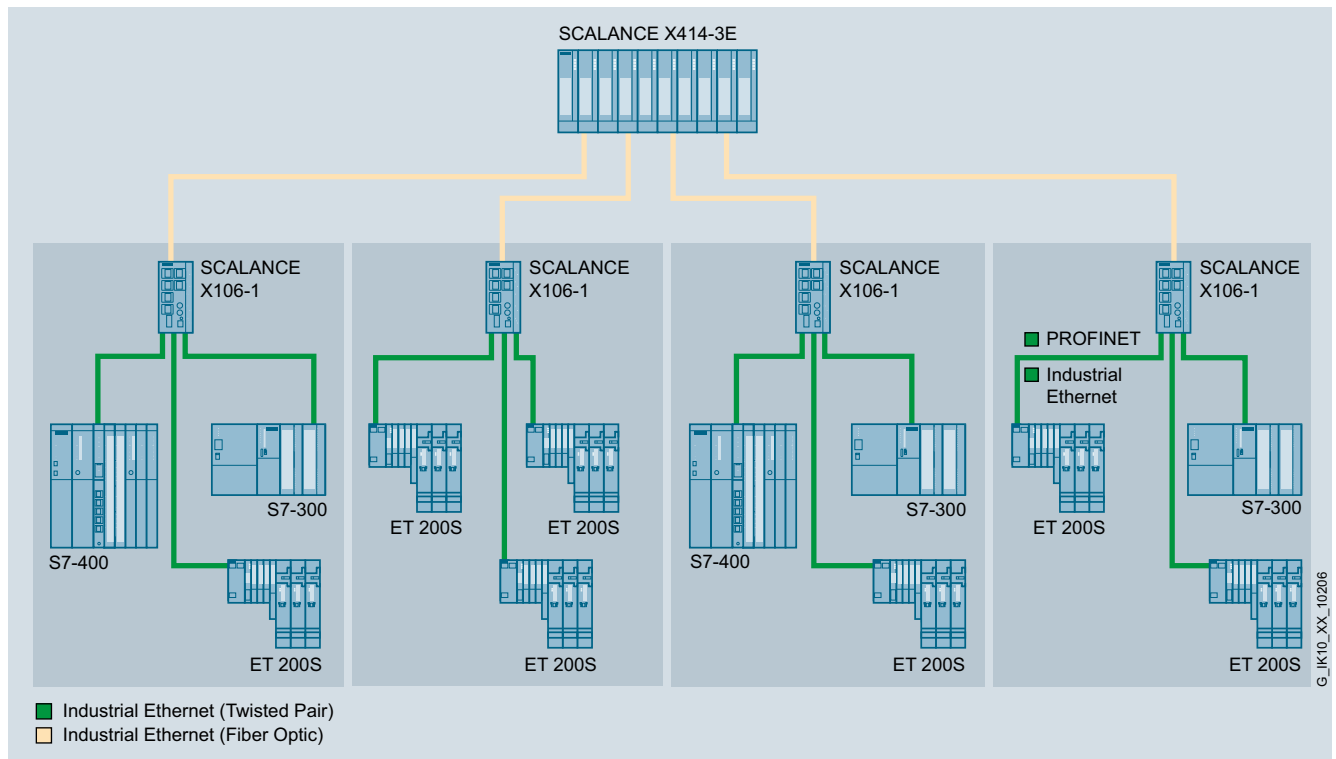

Optical star topology with SCALANCE X106-1

#### Diagnostics

The following information is displayed by LEDs on site:

- Power
- Port status
- Data traffic

The Industrial Ethernet switches of the SCALANCE X-100 line can also be monitored over the floating signaling contact.

**Technical specifications**

Article No.	6GK5104-2BB00-2AA3	6GK5106-1BB00-2AA3	6GK5108-0BA00-2AA3	6GK5108-0PA00-2AA3
Product-type designation	SCALANCE X104-2	SCALANCE X106-1	SCALANCE X108	SCALANCE X108PoE
<b>Transmission rate</b>				
Transfer rate 1	10 Mbit/s	10 Mbit/s	10 Mbit/s	10 Mbit/s
Transfer rate 2	100 Mbit/s	100 Mbit/s	100 Mbit/s	100 Mbit/s
<b>Interfaces</b>				
Number of electrical/optical connections for network components or terminal equipment maximum	6	7	8	8
Number of electrical connections				
• for network components and terminal equipment	4	6	8	6
• for Power-over-Ethernet for network components or terminal equipment	-	-	-	2
• for signaling contact	1	1	1	1
• for power supply	1	1	1	1
• for redundant power supply	1	1	1	1
Design of electrical connection				
• for network components and terminal equipment	RJ45 port	RJ45 port	RJ45 port	RJ45 port
• for Power-over-Ethernet for network components or terminal equipment	-	-	-	RJ45 port
• for signaling contact	2-pole terminal block	2-pole terminal block	2-pole terminal block	2-pole terminal block
• for power supply	4-pole terminal block	4-pole terminal block	4-pole terminal block	4-pole terminal block
Number of optical interfaces for optical waveguide				
• at 100 Mbit/s	2	1	-	-
Design of optical interface for optical waveguide				
• at 100 Mbit/s	BFOC sockets (multimode up to 5 km)	BFOC sockets (multimode up to 5 km)	-	-
Connectable optical power relative to 1 mW				
• of the transmitter output	-19 ... -14 dB	-19 ... -14 dB	-	-
• of the receiver input maximum	-14 dB	-14 dB	-	-
Optical sensitivity relative to 1 mW of the receiver input minimum	-32 dB	-32 dB	-	-
Attenuation of fiber-optic cable transmission link minimum necessary	0 dB	0 dB	-	-
Range at the optical interface depending on the optical fiber used	0 ... 5 km	0 ... 5 km	-	-
<b>Signal-Inputs/outputs</b>				
Operating voltage of signaling contacts at DC rated value	24 V	24 V	24 V	24 V
Operating current of signaling contacts at DC maximum	0.1 A	0.1 A	0.1 A	0.1 A
<b>Supply voltage, current consumption, power loss</b>				
Type of supply voltage	DC	DC	DC	DC
Supply voltage external	24 V	24 V	24 V	24 V
• minimum	18 V	18 V	18 V	18 V
• maximum	32 V	32 V	32 V	32 V
Product component fusing at power supply input	Yes	Yes	Yes	Yes
Type of fusing at input for supply voltage	0.6 A / 60 V	0.6 A / 60 V	0.6 A / 60 V	4 A / 125 V
Consumed current maximum	0.16 A	0.15 A	0.14 A	1.7 A
Active power loss at 24 V for DC	3.8 W	3.6 W	3.36 W	10 W

# PROFINET/Industrial Ethernet

## Industrial Ethernet Switches

### SCALANCE X-100 unmanaged

#### Technical specifications (continued)

Article No.	6GK5104-2BB00-2AA3	6GK5106-1BB00-2AA3	6GK5108-0BA00-2AA3	6GK5108-0PA00-2AA3
Product-type designation	SCALANCE X104-2	SCALANCE X106-1	SCALANCE X108	SCALANCE X108PoE
<b>Permitted ambient conditions</b>				
Ambient temperature				
• during operating	-10 ... +60 °C	-10 ... +60 °C	-20 ... +70 °C	-20 ... +60 °C
• during storage	-40 ... +80 °C	-40 ... +80 °C	-40 ... +80 °C	-40 ... +80 °C
• during transport	-40 ... +80 °C	-40 ... +80 °C	-40 ... +80 °C	-40 ... +80 °C
Relative humidity at 25 °C without condensation during operating maximum	95 %	95 %	95 %	95 %
Protection class IP	IP30	IP30	IP30	IP30
<b>Design, dimensions and weight</b>				
Design	compact	compact	compact	compact
Width	60 mm	60 mm	60 mm	60 mm
Height	125 mm	125 mm	125 mm	125 mm
Depth	124 mm	124 mm	124 mm	124 mm
Net weight	0.78 kg	0.78 kg	0.78 kg	0.9 kg
Mounting type				
• 35 mm DIN rail mounting	Yes	Yes	Yes	Yes
• wall mounting	Yes	Yes	Yes	Yes
• S7-300 rail mounting	Yes	Yes	Yes	Yes
Mounting type	-	-	-	-
<b>Standards, specifications, approvals</b>				
Standard				
• for EMC from FM	FM3611: Class 1, Division 2, Group A, B, C, D / T., Class 1, Zone 2, Group IIC, T..	FM3611: Class 1, Division 2, Group A, B, C, D / T., Class 1, Zone 2, Group IIC, T..	FM3611: Class 1, Division 2, Group A, B, C, D / T., Class 1, Zone 2, Group IIC, T..	FM3611: Class 1, Division 2, Group A, B, C, D / T., Class 1, Zone 2, Group IIC, T..
• for hazardous zone	EN 60079-0: 2006, EN 60079-15: 2005, II 3 G Ex nA IIT., KEMA 07 ATEX 0145 X	EN 60079-0: 2006, EN 60079-15: 2005, II 3 G Ex nA IIT., KEMA 07 ATEX 0145 X	EN 60079-0: 2006, EN 60079-15: 2005, II 3 G Ex nA IIT., KEMA 07 ATEX 0145 X	EN 60079-0: 2006, EN 60079-15: 2005, II 3 G Ex nA IIT., KEMA 07 ATEX 0145 X
• for safety of CSA and UL	UL 60950-1, CSA C22.2 No. 60950-1	UL 60950-1, CSA C22.2 No. 60950-1	UL 60950-1, CSA C22.2 No. 60950-1	UL 60950-1, CSA C22.2 No. 60950-1
• for hazardous area of CSA and UL	UL 1604 and UL 2279-15 (Hazardous Location), Class 1 / Division 2 / Group A, B, C, D / T., Class 1 / Zone 2 / Group IIC / T..	UL 1604 and UL 2279-15 (Hazardous Location), Class 1 / Division 2 / Group A, B, C, D / T., Class 1 / Zone 2 / Group IIC / T..	UL 1604 and UL 2279-15 (Hazardous Location), Class 1 / Division 2 / Group A, B, C, D / T., Class 1 / Zone 2 / Group IIC / T..	UL 1604 and UL 2279-15 (Hazardous Location), Class 1 / Division 2 / Group A, B, C, D / T., Class 1 / Zone 2 / Group IIC / T..
• for emitted interference	EN 61000-6-4 (Class A)	EN 61000-6-4 (Class A)	EN 61000-6-4 (Class A)	EN 61000-6-4:2001
• for interference immunity	EN 61000-6-2	EN 61000-6-2	EN 61000-6-2	EN 61000-6-2:2001
Verification of suitability	EN 61000-6-2, EN 61000-6-4	EN 61000-6-2, EN 61000-6-4	EN 61000-6-2, EN 61000-6-4	EN 61000-6-2:2001, EN 61000-6-4:2001
• CE mark	Yes	Yes	Yes	Yes
• C-Tick	Yes	Yes	Yes	Yes
• KC approval	Yes	Yes	Yes	Yes
Marine classification association				
• American Bureau of Shipping Europe Ltd. (ABS)	Yes	Yes	Yes	No
• Bureau Veritas (BV)	Yes	Yes	Yes	No
• Det Norske Veritas (DNV)	Yes	Yes	Yes	No
• Germanische Lloyd (GL)	Yes	Yes	Yes	No
• Lloyds Register of Shipping (LRS)	Yes	Yes	Yes	No
• Nippon Kaiji Kyokai (NK)	Yes	Yes	Yes	No
• Polski Rejestr Statkow (PRS)	Yes	Yes	Yes	No

**Technical specifications (continued)**

Article No.	6GK5112-2BB00-2AA3	6GK5116-0BA00-2AA3	6GK5124-0BA00-2AA3
Product-type designation	SCALANCE X112-2	SCALANCE X116	SCALANCE X124
<b>Transmission rate</b>			
Transfer rate 1	10 Mbit/s	10 Mbit/s	10 Mbit/s
Transfer rate 2	100 Mbit/s	100 Mbit/s	100 Mbit/s
<b>Interfaces</b>			
Number of electrical/optical connections for network components or terminal equipment maximum	14	16	24
Number of electrical connections			
• for network components and terminal equipment	12	16	24
• for signaling contact	1	1	1
• for power supply	1	1	1
• for redundant power supply	1	1	1
Design of electrical connection			
• for network components and terminal equipment	RJ45 port	RJ45 port	RJ45 port
• for signaling contact	2-pole terminal block	2-pole terminal block	2-pole terminal block
• for power supply	4-pole terminal block	4-pole terminal block	4-pole terminal block
Number of optical interfaces for optical waveguide			
• at 100 Mbit/s	2	-	-
Design of optical interface for optical waveguide			
• at 100 Mbit/s	BFOC sockets (multimode up to 5 km)	-	-
Connectable optical power relative to 1 mW			
• of the transmitter output	-19 ... -14 dB	-	-
• of the receiver input maximum	-14 dB	-	-
Optical sensitivity relative to 1 mW of the receiver input minimum	-32 dB	-	-
Attenuation of fiber-optic cable transmission link minimum necessary	0 dB	-	-
Range at the optical interface depending on the optical fiber used	0 ... 5 km	-	-
<b>Signal-Inputs/outputs</b>			
Operating voltage of signaling contacts at DC rated value	24 V	24 V	24 V
Operating current of signaling contacts at DC maximum	0.1 A	0.1 A	0.1 A
<b>Supply voltage, current consumption, power loss</b>			
Type of supply voltage	DC	DC	DC
Supply voltage external	24 V	24 V	24 V
• minimum	18 V	18 V	18 V
• maximum	32 V	32 V	32 V
Product component fusing at power supply input	No	No	No
Consumed current maximum	0.45 A	0.3 A	0.45 A
Active power loss at 24 V for DC	5.16 W	4.4 W	4.8 W
<b>Permitted ambient conditions</b>			
Ambient temperature			
• during operating	-10 ... +70 °C	-20 ... +70 °C	-20 ... +70 °C
• during storage	-40 ... +80 °C	-40 ... +80 °C	-40 ... +80 °C
• during transport	-40 ... +80 °C	-40 ... +80 °C	-40 ... +80 °C
Relative humidity at 25 °C without condensation during operating maximum	95 %	95 %	95 %
Protection class IP	IP30	IP30	IP30

## PROFINET/Industrial Ethernet

### Industrial Ethernet Switches

#### SCALANCE X-100 unmanaged

#### Technical specifications (continued)

Article No.	6GK5112-2BB00-2AA3	6GK5116-0BA00-2AA3	6GK5124-0BA00-2AA3
Product-type designation	SCALANCE X112-2	SCALANCE X116	SCALANCE X124
<b>Design, dimensions and weight</b>			
Design	compact	compact	compact
Width	120 mm	120 mm	180 mm
Height	125 mm	125 mm	125 mm
Depth	124 mm	124 mm	124 mm
Net weight	1.1 kg	1.1 kg	1.5 kg
Mounting type			
• 35 mm DIN rail mounting	Yes	Yes	Yes
• wall mounting	Yes	Yes	Yes
• S7-300 rail mounting	Yes	Yes	Yes
Mounting type	-	-	-
<b>Standards, specifications, approvals</b>			
Standard			
• for EMC from FM	FM3611: Class 1, Division 2, Group A, B, C, D / T.., Class 1, Zone 2, Group IIC, T..	FM3611: Class 1, Division 2, Group A, B, C, D / T.., Class 1, Zone 2, Group IIC, T..	FM3611: Class 1, Division 2, Group A, B, C, D / T.., Class 1, Zone 2, Group IIC, T..
• for hazardous zone	EN 60079-0:2006, EN 60079-15:2005, II 3 G Ex nA II T.. KEMA 08 ATEX 0003 X	EN 60079-0:2006, EN 60079-15:2005, II 3 G Ex nA II T.. KEMA 08 ATEX 0003 X	EN 60079-0:2006, EN 600EN 60079-15:2005, II 3 G Ex nA II T.. KEMA 08 ATEX 0003 X
• for safety of CSA and UL	UL 60950-1, CSA C22.2 No. 60950-1	UL 60950-1, CSA C22.2 No. 60950-1	UL 60950-1, CSA C22.2 No. 60950-1
• for hazardous area of CSA and UL	UL 1604 and UL 2279-15 (Hazardous Location), Class 1 / Division 2 / Group A, B, C, D / T.., Class 1 / Zone 2 / Group IIC / T..	UL 1604 and UL 2279-15 (Hazardous Location), Class 1 / Division 2 / Group A, B, C, D / T.., Class 1 / Zone 2 / Group IIC / T..	UL 1604 and UL 2279-15 (Hazardous Location), Class 1 / Division 2 / Group A, B, C, D / T.., Class 1 / Zone 2 / Group IIC / T..
• for emitted interference	EN 61000-6-4:2001	EN 61000-6-4:2001	EN 61000-6-4:2001
• for interference immunity	EN 61000-6-2:2001	EN 61000-6-2:2001	EN 61000-6-2:2001
Verification of suitability	EN 61000-6-2:2001, EN 61000-6-4:2001	EN 61000-6-2:2001, EN 61000-6-4:2001	EN 61000-6-2:2001, EN 61000-6-4:2001
• CE mark	Yes	Yes	Yes
• C-Tick	Yes	Yes	Yes
• KC approval	Yes	Yes	Yes
Marine classification association			
• American Bureau of Shipping Europe Ltd. (ABS)	Yes	Yes	Yes
• Bureau Veritas (BV)	Yes	Yes	Yes
• Det Norske Veritas (DNV)	No	No	No
• Germanische Lloyd (GL)	No	No	No
• Lloyds Register of Shipping (LRS)	Yes	Yes	Yes
• Nippon Kaiji Kyokai (NK)	Yes	Yes	Yes
• Polski Rejestr Statkow (PRS)	No	No	No



Ordering data	Article No.	Article No.
<b>SCALANCE X-100</b> <b>Industrial Ethernet switches</b>  Industrial Ethernet switches for 10/100 Mbit/s, incl. operating instructions, Industrial Ethernet network manual and configuration software on CD-ROM		
<ul style="list-style-type: none"> <li>• <b>SCALANCE X104-2</b> 4 x 10/100 Mbit/s RJ45 ports, electrical 2 x BFOC ports, optical (multimode, glass) up to 5 km</li> </ul>	<b>6GK5104-2BB00-2AA3</b>	<b>FC FO Standard Cable GP 62.5/200/230</b>  FC FO standard cable for fixed routing indoors with PVC sheath; sold by the meter max. length 1 000 m, minimum order 20 m
<ul style="list-style-type: none"> <li>• <b>SCALANCE X106-1</b> 6 x 10/100 Mbit/s RJ45 ports, electrical 1 x BFOC port, optical (multi-mode, glass) up to 5 km</li> </ul>	<b>6GK5106-1BB00-2AA3</b>	<b>IE FC RJ45 Plug 180 2 x 2</b>  RJ45 plug connector for Industrial Ethernet with a rugged metal enclosure and integrated insulation displacement contacts for connecting Industrial Ethernet FC installation cables; with 180° cable outlet; for network components and CPs/CPUs with Industrial Ethernet interface <ul style="list-style-type: none"> <li>• 1 pack = 1 unit</li> <li>• 1 pack = 10 units</li> <li>• 1 pack = 50 units</li> </ul>
<ul style="list-style-type: none"> <li>• <b>SCALANCE X112-2</b> 12 x 10/100 Mbit/s RJ45 ports, electrical 2 x BFOC ports, optical (multi-mode, glass) up to 5 km</li> </ul>	<b>6GK5112-2BB00-2AA3</b>	<b>FC BFOC Plug</b>  Screw connector for on-site assembly on FC fiber-optic cable; (1 pack = 20 units + cleaning cloths)
<ul style="list-style-type: none"> <li>• <b>SCALANCE X108</b> 8 x 10/100 Mbit/s RJ45 ports, electrical</li> </ul>	<b>6GK5108-0BA00-2AA3</b>	<b>IE FC Stripping Tool</b>  Preadjusted stripping tool for fast stripping of the Industrial Ethernet FC cables
<ul style="list-style-type: none"> <li>• <b>SCALANCE X108PoE</b> 6 x 10/100 Mbit/s RJ45 ports, electrical 2 x 10/100 Mbit/s RJ45 PoE ports, electrical</li> </ul>	<b>6GK5108-0PA00-2AA3</b>	<b>FC FO termination kit</b>  Assembly case for local assembly of FC SC and FC BFOC connectors to FC FO standard cable, comprising a stripping tool, Kevlar cutters, fiber breaking tool and microscope
<ul style="list-style-type: none"> <li>• <b>SCALANCE X116</b> 16 x 10/100 Mbit/s RJ45 ports, electrical</li> </ul>	<b>6GK5116-0BA00-2AA3</b>	<b>SITOP compact 24 V/ 0.6 A</b>  1-phase power supply with wide-range input 85 – 264 V AC/110 – 300 V DC, stabilized output voltage 24 V, rated output current value 0.6 A, slim design
<ul style="list-style-type: none"> <li>• <b>SCALANCE X124</b> 24 x 10/100 Mbit/s RJ45 ports, electrical</li> </ul>	<b>6GK5124-0BA00-2AA3</b>	
<b>Accessories</b>		
<b>IE FC TP Standard Cable GP 2 x 2 (Type A)</b>  4-core, shielded TP installation cable for connection to IE FC Outlet RJ45/IE FC RJ45 Plug; PROFINET-compliant; with UL approval; sold by the meter; max. length 1 000 m, minimum order 20 m	<b>6XV1840-2AH10</b>	
<b>FO Standard Cable GP 50/125/1400<sup>1) 2)</sup></b>  Multimode cable, sold by the meter; max. length 1 000 m; minimum order 20 m	<b>6XV1873-2A</b>	

<sup>1)</sup> Special fiber-optic cables, lengths and accessories available on request

<sup>2)</sup> Special tools and trained personnel are required for pre-assembling glass fiber-optic cables

## More information

### Selection tools:

To assist in selecting the right Industrial Ethernet switches as well as configuration of modular variants, the SIMATIC NET Selection Tool and the TIA Selection Tool are available at:

SIMATIC NET Selection Tool:

- Online version:  
<http://www.siemens.com/snst>
- Offline version:  
<http://www.siemens.com/snst-download>

TIA Selection Tool:

<http://www.siemens.com/tia-selection-tool>

## PROFINET/Industrial Ethernet

### Industrial Ethernet Switches

#### SCALANCE XC-100 unmanaged

##### Overview



The SCALANCE XC100-4OBR optical bypass relays are ideally suitable as ballast in Industrial Ethernet networks in linear and ring topologies with data transfer rates of 100/1 000 Mbit/s. They are used for uninterruptible connection and disconnection of SCALANCE X switches.

- Uninterruptible connection and disconnection of network nodes by means of integrated optical relays for multi-mode and single-mode fiber-optic networks
- Suitable for use in extended networks (e.g. in wind farms, pipelines, or large chemical plants) thanks to low optical attenuation
- Rugged plastic enclosure in SIMATIC S7-1500 format, with installation options on standard mounting rail, and SIMATIC S7-300/S7-1500 mounting rail in different installation positions
- Rugged, industry-standard node/network connections using SC FO interfaces
- Redundant voltage infeed and monitoring of large voltage range (12 V DC, 24 V DC, 48 V DC)
- Diagnostics on the device by means of LEDs (bypass function, configuration, power supply)
- Fault signaling contact for signaling switching operations
- Digital input contact for remote function check of the bypass relay

##### Product versions

###### **SCALANCE XC100-4OBR with multimode fiber optic ports**

- For establishing optical multimode fiber optic line or ring topologies with four optical SC ports and TAP function for quickly establishing links

###### **SCALANCE XC100-4OBR with singlemode fiber optic ports**

- For establishing optical singlemode fiber optic line topologies with four optical SC ports and low throughput attenuation in the optical relay
- For establishing optical singlemode fiber optic line or ring topologies with four optical SC ports and TAP function for quickly establishing links

###### **SCALANCE XC100-4OBR, SM, line topology**

- For establishing optical singlemode fiber optic line topologies with four optical SC ports and low throughput attenuation in the optical relay without TAP function

##### Benefits

get

Designed for Industry

- Ideal solution for uninterruptible connection and disconnection of network nodes, e.g. for maintenance work in MRP or HRP (high speed redundancy) rings
- Simple integration into existing Industrial Ethernet line, star and ring topologies for increasing the availability of the network
- Use in harsh industrial environments thanks to wide temperature range and coated PCBs (conformal coating)
- Integration into extended multi-mode and single-mode networks thanks to low throughput attenuation of the integrated optical relay
- Combination with different network components thanks to configurable reset delay by means of SET pushbutton on the device
- Low installation width (50 mm) enables simple retrofitting in existing control cabinets
- High device availability thanks to redundant voltage infeed and large voltage range (12 V DC, 24 V DC, 48 V DC)

##### Application

The SCALANCE XC100-4OBR optical bypass relays increase network availability in Industrial Ethernet line, star and ring topologies, especially in the case of networks in pipelines or wind farms, for example, that are difficult to access.

## Design

The SCALANCE XC100-4OBRs with rugged enclosures are optimized for mounting on a standard rail and the S7-300 or S7-1500 rail in different installation positions. Thanks to the S7-1500 housing dimensions, the devices are suitable for integration into an automation solution with S7-1500 components. The SCALANCE XC100-4OBRs with degree of protection IP20 are designed for operation in the control cabinet. The coated PCBs (conformal coating) protect against condensation.

The SCALANCE XC100-4OBR features:

- An enclosure in SIMATIC S7-1500 design with recessed fiber-optic interfaces
- A row of LEDs for displaying status information (bypass, display mode, power supply)
- A 4-pole terminal block for connecting the redundant supply voltage (2 x 12 V DC ... 48 V DC)
- A 2-pole terminal block for connecting the floating signaling contact
- A 2-pole terminal block for connecting the digital input signal (switching signal)
- A SET pushbutton for on-site configuration of the monitored voltage range and the reset delay; optimal adaptation of the reset delay:
  - short reset delay for unmanaged network components
  - long reset delay for managed network components
- Four FO SC interfaces for integration into the FO network and connection of network components; simple connection to active network components thanks to extensive range of fiber-optic patch cords with different fiber-optic connectors

## Function

- Integration into optical Industrial Ethernet line, star and ring topologies
- Fast bridging of network nodes using optical relays within 10 ms in the event of a fault (e.g. power failure)
- Maintenance of network communication thanks to bridging of the failed network components
- No activation of the redundancy manager when resetting a network component in MRP and HRP ring topologies thanks to previous establishment of link; this avoids a message burst in the network in the case of planned maintenance work. Thanks to the configurable connection delay, network components are not switched back into the network until they have been fully powered up and the link has been established (only on versions with TAP function).

- Simple integration of the SCALANCE XC100-4OBR into existing 100/1000 Mbit/s networks thanks to extensive portfolio of FO adapter cables

- Simple diagnostics via signaling contact and LED on-site

### **Network topology and network configuration**

The Industrial Ethernet SCALANCE XC100-4OBRs with IP20 degree of protection are usually installed in a control cabinet together with the network components to be connected.

When configuring the network, the following parameters have to be taken into account for calculating the cable length between two devices:

- The line attenuation of the fiber-optic cables used
- The attenuation of the optical relay
- The maximum number of SCALANCE XC100-4OBR bypass relays that can be activated simultaneously

### **Commissioning and diagnostics**

Before commissioning the SCALANCE XC100-4OBR, the reset delay and the voltage range to be monitored must be selected using the SET pushbutton on the device.

The following information is displayed by LEDs on site:

- Bypass
- Display mode
- Power supply

The SCALANCE XC100-4OBR can also be monitored using the floating signaling contact. A digital input contact enables remote function checking of the relay.

# PROFINET/Industrial Ethernet

## Industrial Ethernet Switches

### SCALANCE XC-100 unmanaged

#### Integration

2

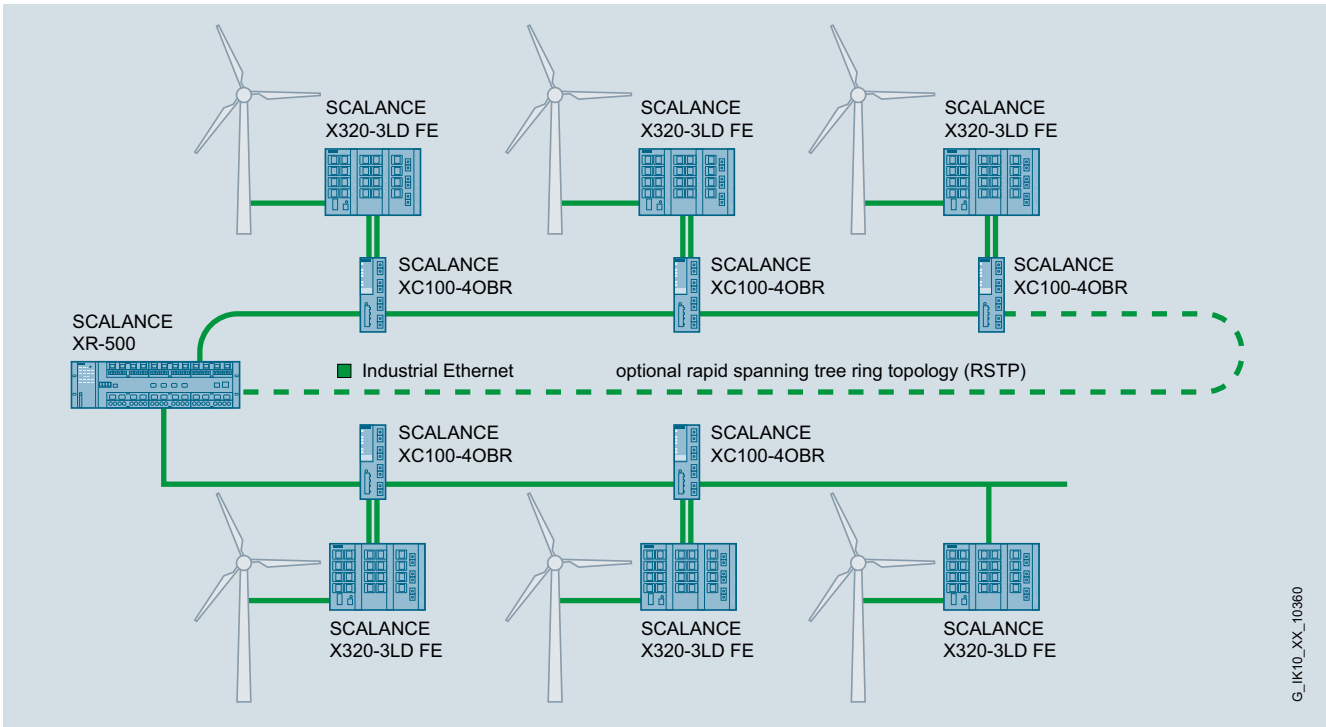

G\_IK10\_XX\_10360

Redundant network with SCALANCE XC100-4OBR

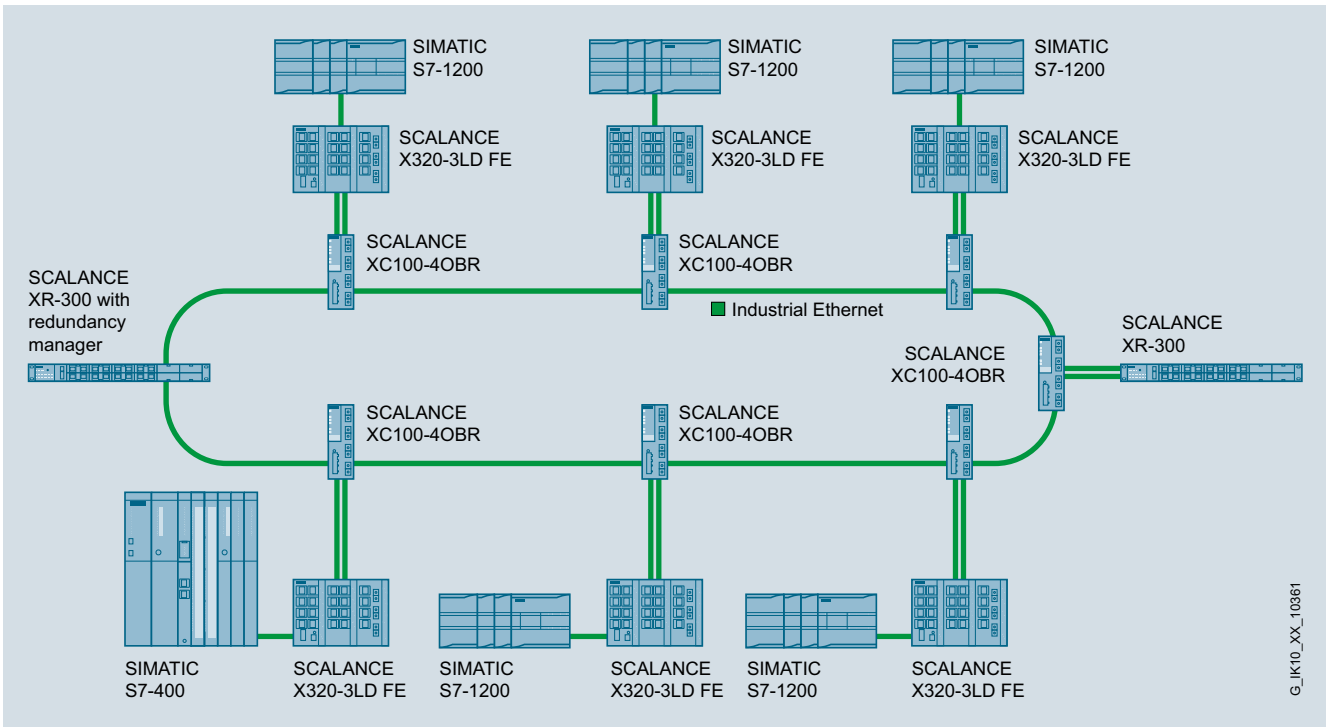

G\_IK10\_XX\_10361

Redundant MRP network with SCALANCE XC100-4OBR in ring topology

**Technical specifications**

Article No.	6GK5100-4AV00-2DA2	6GK5100-4AV00-2FA2	6GK5100-4AW00-2FA2
Product-type designation	SCALANCE XC100-4OBR, SM, LINE STRUCTURE	SCALANCE XC100-4OBR, SM	SCALANCE XC100-4OBR, MM
Product description	Optical bypass relay for single-mode fiber-optic networks without Tap function	Optical bypass relay for single-mode fiber-optic networks with Tap function	Optical bypass relay for multi-mode fiber-optic networks with Tap function
<b>Electrical data</b>			
Transfer rate 2	100 Mbit/s	100 Mbit/s	100 Mbit/s
Transfer rate 3	1 000 Mbit/s	1 000 Mbit/s	-
<b>Interfaces</b>			
Transmission loss			
• at Rx-In P1 and Tx-Out P2	1.2 dB	4.1 dB	4.5 dB
• at Rx-In P2 and Tx-Out P1	1.2 dB	4.1 dB	4.5 dB
• at Rx-In P1 and Tx-Out P1'	1.2 dB	5.7 dB	6 dB
• at Rx-In P2 and Tx-Out P2'	1.2 dB	5.7 dB	6 dB
• at Rx-In P1' and Tx-Out P1	1.2 dB	1.2 dB	1.5 dB
• at Rx-In P2' and Tx-Out P2	1.2 dB	1.2 dB	1.5 dB
<b>Supply voltage</b>			
Type of voltage supply	DC	DC	DC
Supply voltage external			
• minimum	12 V	12 V	12 V
• maximum	48 V	48 V	48 V
<b>Mechanical data</b>			
Material of the enclosure	Metal/plastic	Metal/plastic	Metal/plastic
Design, dimensions and weight			
Width	50 mm	50 mm	50 mm
Height	140 mm	140 mm	140 mm
Depth	125 mm	125 mm	125 mm
Net weight	550 g	550 g	550 g
Mounting type			
• 35 mm DIN rail mounting	Yes	Yes	Yes
• wall mounting	No	No	No
<b>Permitted ambient conditions</b>			
Ambient temperature			
• during operating	-40 ... +70 °C	-40 ... +70 °C	-40 ... +70 °C
• during storage	-40 ... +85 °C	-40 ... +85 °C	-40 ... +85 °C
• during transport	-40 ... +85 °C	-40 ... +85 °C	-40 ... +85 °C
Protection class IP	IP20	IP20	IP20
<b>Standards, specifications, approvals</b>			
Verification of suitability			
• RoHS conformity	Yes	Yes	Yes
• UL-registration	Yes	Yes	Yes
Standard for hazardous zone			

## PROFINET/Industrial Ethernet

### Industrial Ethernet Switches

#### SCALANCE XC-100 unmanaged

#### Ordering data

#### Article No.

#### Article No.

##### SCALANCE XC100-4OBR optical bypass relay

for integration into 100/1 000 Mbit/s Industrial Ethernet networks with redundant voltage infeed, signaling contact and digital input contact

with **four optical SC ports and TAP function** for fast link establishment;  
for integration into optical line or ring topologies

- Multi-mode FO
- Single-mode FO

with **four optical SC ports and reduced throughput attenuation in the optical relay**;  
for integration into optical line topologies

- Single-mode FO

**6GK5100-4AV00-2DA2**  
**6GK5100-4AV00-2FA2**

**6GK5100-4AW00-2FA2**

##### Accessories

##### FO Standard Cable GP 50/125/1400<sup>1) 2)</sup>

Multi-mode cable for use indoors and outdoors, sold by the meter;  
max. length 1 000 m;  
minimum order length 20 m

**6XV1873-2A**

##### FO ground cable 50/125/1400<sup>1) 2)</sup>

Multi-mode cable for use in the outdoor area, as well as for direct routing underground;  
longitudinally and laterally water-tight cable with non-metallic rodent protection;  
sold by the meter  
max. length 2 000 m,  
minimum order 20 m

**6XV1873-2G**

##### FO Robust Cable GP 50/125/900<sup>1) 2)</sup>

Multi-mode cable for outdoor and indoor use, as well as for direct routing underground;  
longitudinally and laterally water-tight cable with non-metallic rodent protection;  
sold by the meter  
max. length 2 000 m,  
minimum order 20 m

**6XV1873-2R**

##### FO Robust Cable GP 4E9/125/900<sup>1) 2)</sup>

Single-mode cable for outdoor and indoor use, as well as for direct routing underground;  
longitudinally and laterally water-tight cable with non-metallic rodent protection;  
sold by the meter  
max. length 2 000 m,  
minimum order 20 m

**6XV1843-2R**

##### Multi-mode FO BFOC connector set

for FO standard cable (50/125/1 400), FO ground cable (50/125/1 400), flexible FO trailing cable, INDOOR FO cable (62.5/125/900), 20 units

**6GK1901-0DA20-0AA0**

##### Multi-mode FO SC duplex connector set

for FO standard cable (50/125/1 400), FO ground cable (50/125/1 400), flexible FO trailing cable, INDOOR FO cable (62.5/125/900), 10 units

**6GK1901-0LB10-2AA0**

##### Multi-mode FO LC duplex plug

LC duplex plug (10 units) for INDOOR FO cable (62.5/125/900), FO robust cable GP (50/125/900), FO standard cable (62.5/125/900)

**6GK1901-0RB10-2AB0**

##### Single-mode FO LC duplex plug

LC duplex plug (10 units) for FO robust cable GP (4E9/125/900)

**6GK1901-0SB10-2AB0**

##### Pre-assembled FO patch cables

###### Multi-mode

##### MM FO Cord SC/SC

With two SC duplex connectors, 1 m

**6XV1843-5EH10-0CC0**

##### MM FO Cord SC/BFOC

With one SC duplex connector and two BFOC connectors, 1 m

**6XV1843-5EH10-0CB0**

##### MM FO Cord SC/LC

With one SC duplex connector and one LC duplex connector, 1 m

**6XV1843-5EH10-0CA0**

###### Single-mode

##### SM FO Cord SC/SC

With two SC duplex connectors, 1 m

**6XV1843-5FH10-0CC0**

##### SM FO Cord SC/BFOC

With one SC duplex connector and two BFOC connectors, 1 m

**6XV1843-5FH10-0CB0**

##### SM FO Cord SC/LC

With one SC duplex connector and one LC duplex connector, 1 m

**6XV1843-5FH10-0CA0**

<sup>1)</sup> Special fiber-optic cables, lengths and accessories available on request

<sup>2)</sup> Special tools and trained personnel are required for pre-assembling glass fiber-optic cables

#### More information

##### Selection tools:

To assist in selecting the right Industrial Ethernet switches as well as configuration of modular variants, the SIMATIC NET Selection Tool and the TIA Selection Tool are available at:

SIMATIC NET Selection Tool:

- Online version:  
<http://www.siemens.com/snst>
- Offline version:  
<http://www.siemens.com/snst-download>

TIA Selection Tool:

<http://www.siemens.com/tia-selection-tool>

**Overview**

SCALANCE X-200	Type of device	Hardware																
		Connection to S7 backplane bus	Format module S7	PC module	Flat type of construction	Box type of construction	19" type of construction	Rugged, compact housing	Modular design	10 Gigabit Ethernet	Gigabit Ethernet	PoE (Power over Ethernet)	LED diagnosis	SIMATIC environment	Redundant power supply (2 x 24 V DC)	External supply for integrated switch	Signal contact	Local display (SET pushbutton)
X204-2							•					•	•	•		•	•	•
X204-2TS							•					•	•	•		•	•	•
X204-2LD							•					•	•	•		•	•	•
X206-1							•					•	•	•		•	•	•
X206-1LD							•					•	•	•		•	•	•
X208							•					•	•	•		•	•	•
X208PRO							•					•	•	•		•	•	•
X212-2							•					•	•	•		•	•	•
X212-2LD							•					•	•	•		•	•	•
X216							•					•	•	•		•	•	•
X224							•					•	•	•		•	•	•
XF204				•								•	•	•		•	•	•
XF204-2				•								•	•	•		•	•	•
XF206-1				•								•	•	•		•	•	•
XF208				•								•	•	•		•	•	•
X204RNA PRP					•							•	•	•		•	•	•
X204RNA EEC PRP							•					•				•	•	•
X204RNA HSR					•							•	•	•		•	•	•
X204RNA EEC HSR							•					•				•	•	•
X204RNA EEC PRP+HSR							•					•				•	•	•

• applies

G\_IK10\_XX\_10312

Function overview SCALANCE X-200 managed: Hardware



# PROFINET/Industrial Ethernet

## Industrial Ethernet Switches

### SCALANCE X-200 managed

#### Overview (continued)

2

SCALANCE X-200	Type of device	Software																												
		Security Integrated (Firewall/VPN)	PROFINET diagnosis	Topology support (LLDP)	Command Line Interface / Telnet	Web based Management	Configuration with STEP 7 / TIA	SNMP	Ring redundancy incl. RM-functionality	Standby redundancy	IRT capability	VLAN (Virtual Local Area Network)	GVRP (Generic VLAN Registration Protocol)	STP/ RSTP (Spanning Tree Protocol/ Rapid Spanning Tree Protocol)	Passive Listening	IGMP Snooping/Querier (Internet Group Management Protocol)	GMRP (Generic Multicast Protocol)	Broadcast/ Multicast/ Unicast Limiter	Broadcast blocking	DHCP Option 82 (Dynamic Host Configuration Protocol)	Access Control List (IP)	Access Control List (MAC)	IEEE 802.1x (Radius)	Link Aggregation	Static Routing	RIPv2 (Dynamic Routing)	OSPFv2 (Dynamic Routing)	RRRP, Router Redundancy (Virtual Router Redundancy Protocol)	PRP communication	HSR communication
X204-2		•	•	•	•	•	•	•						•							•									
X204-2TS		•	•	•	•	•	•	•														•								
X204-2LD		•	•	•	•	•	•	•						•								•								
X206-1		•	•	•	•	•	•	•						•								•								
X206-1LD		•	•	•	•	•	•	•						•								•								
X208		•	•	•	•	•	•	•						•								•								
X208PRO		•	•	•	•	•	•	•														•								
X212-2		•	•	•	•	•	•	•						•								•								
X212-2LD		•	•	•	•	•	•	•						•								•								
X216		•	•	•	•	•	•	•						•								•								
X224		•	•	•	•	•	•	•						•								•								
XF204		•	•	•	•	•	•	•						•								•								
XF204-2		•	•	•	•	•	•	•						•								•								
XF206-1		•	•	•	•	•	•	•						•								•								
XF208		•	•	•	•	•	•	•						•								•								
X204RNA PRP					•	•		•														•							•	
X204RNA EEC PRP					•	•		•														•							•	
X204RNA HSR					•	•		•														•							•	
X204RNA EEC HSR					•	•		•														•							•	
X204RNA EEC PRP+HSR					•	•		•														•							•	

• applies

Function overview SCALANCE X-200 managed: Software

G\_IK10\_XX\_10313



### Overview



The managed Industrial Ethernet switches of the SCALANCE X-200 line are optimized for setting up Industrial Ethernet networks at data transfer rates of 10/100 Mbit/s in a line, star or ring topology.

- Integrated redundancy manager for constructing Fast Ethernet ring topologies with fast media redundancy
- Electrical or optical connection to stations or network in accordance with the port type of the devices
- Rugged metal housing in S7-300 format for mounting on standard rail, S7-300 standard mounting rail or for direct wall mounting in various positions
- Rugged, industry-standard station connections with PROFINET-compatible RJ45 connectors that offer additional strain relief and bending strain relief thanks to latching on the housing
- Redundant power supply
- Diagnostics on the device by means of LEDs (power, link status, data communication)
- Error signaling contact with easy adjustment using the SET button
- PROFINET diagnostics, SNMP access, integrated web server and automatic e-mail transmission function for remote diagnostics and signaling via the network

### Product versions

- Switches with electrical and optical ports for glass multi-mode FOC up to 5 km:
  - **SCALANCE X204-2;** for constructing optical line or ring topologies with four electrical ports and two optical ports
  - **SCALANCE X204-2TS (degree of protection IP20);** for setting up optical line or ring topologies with four electrical ports and two optical ports especially for railway applications (EN 50155) with extended temperature range
  - **SCALANCE X206-1;** for setting up star topologies with 6 electrical ports and 1 optical port, line or ring topologies with electrical and optical transmission paths
  - **SCALANCE X212-2;** for constructing optical line or ring topologies with 12 electrical ports and two optical ports

- Switches with electrical and optical ports for glass single mode FOC up to 26 km:
  - **SCALANCE X204-2LD;** for constructing optical line or ring topologies with four electrical ports and two optical ports
  - **SCALANCE X206-1LD;** for constructing star topologies with 6 electrical ports and 1 optical port, line or ring topologies with electrical and optical transmission paths
  - **SCALANCE X212-2LD;** for constructing optical line or ring topologies with 12 electrical ports and 2 optical ports
- Switches with electrical ports for configuring electrical Industrial Ethernet line, star or ring topologies:
  - **SCALANCE X208;** with 8 electrical ports for mounting in the control cabinet
  - **SCALANCE X208PRO (IP65/67 degree of protection);** with 8 electrical ports especially for use outside the control cabinet (M12 connection system)
  - **SCALANCE X216;** with 16 electrical ports for mounting in the control cabinet
  - **SCALANCE X224;** with 24 electrical ports for mounting in the control cabinet

### Benefits



- Ideal solution for configuring Industrial Ethernet line, star and ring topologies
- Reliable plug-in connection thanks to rugged, industry-standard device connection in conjunction with PROFINET-compliant FastConnect connectors
- High network availability through design of redundant ring structures (redundancy manager integrated)
- Integration of the SCALANCE X-200 switches in the existing network management infrastructure through SNMP access point
- Easy integration in the process diagnosis and system diagnosis with PROFINET
- Configuration and diagnostics integrated into STEP 7 provide significant benefits during engineering, commissioning, and the operating phase of a plant
- Module replacement without the need for a programming device, using the C-PLUG swap media for backing up the configuration data

## PROFINET/Industrial Ethernet

### Industrial Ethernet Switches

#### SCALANCE X-200 managed

#### Application

The SCALANCE X-200 Industrial Ethernet switches permit cost-effective configuration of Industrial Ethernet line, star or ring topologies with switching functionality for networks in which high availability or remote diagnostics options are required. The devices with IP30 degree of protection have been designed for use in the control cabinet. The SCALANCE X208PRO is designed to the IP65/67 degree of protection for installation outside the control cabinet. The SCALANCE X204-2TS (TS = Transportation Systems) is suitable for use in railway applications due to its specification according to EN 50155.

#### Features:

- The RJ45 ports are industry-standard and feature additional retaining collars (except for SCALANCE X208PRO), for connection to the IE FC RJ45 Plug 180
- The eight PROFINET-compliant M12 ports (d-coded) of the SCALANCE X208PRO are designed with IP65/67 degree of protection for connection to the IE FC M12 Plug PRO 2x2 or the pre-assembled IE M12 connecting cable
- The SCALANCE X208PRO can be mounted on a DIN rail or S7-300 rail or direct on the equipment or machine; the status information can be read off regardless of the mounting position thanks to the angled LED strip.
- Power can also be supplied to the SCALANCE X208PRO from outside the control cabinet from the PS791-1PRO power supply module at 230 V AC.

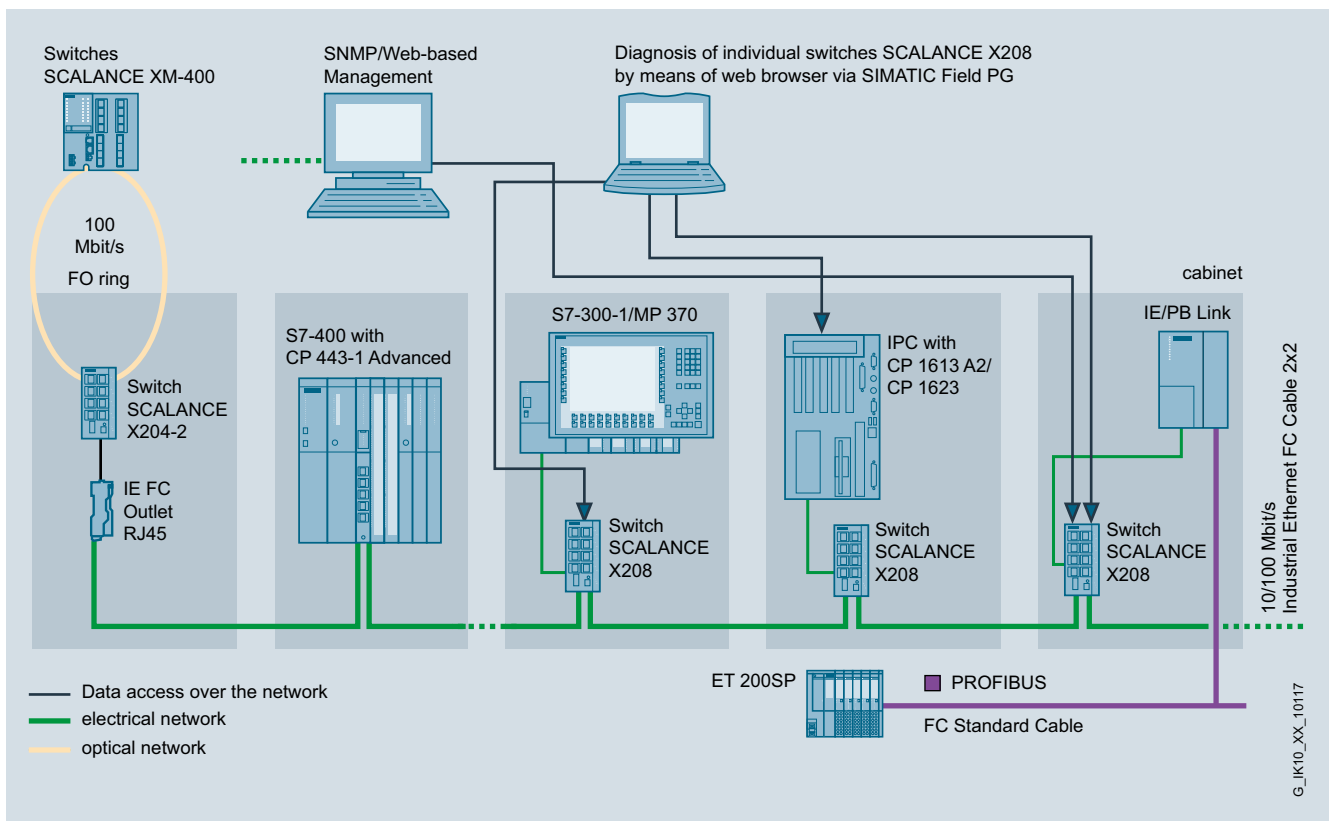

Diagnostics access over SNMP and Web browser with SCALANCE X208

## Design

The SCALANCE X-200 Industrial Ethernet switches with a rugged metal housing are optimized for mounting on a standard rail and an S7-300 rail. Direct wall mounting in various positions is also possible. Thanks to the S7-300 housing dimensions, the devices are suitable for integration into an automation solution with S7-300 components.

The switches with IP20/IP30 degree of protection feature:

- A 4-pole terminal block for connecting the redundant supply voltage (2 x 24 V DC)
- A row of LEDs to indicate the status information (power, link status, data exchange, power supply, signaling contact)
- A 2-pole terminal block for connecting the floating signaling contact
- A SET button for on-site configuration of the signaling contact

The SCALANCE X208PRO with IP65/67 degree of protection features:

- 2 x M12 interfaces for connecting the redundant supply voltage (2 x 24 V DC)
- A row of LEDs to indicate the status information (power, link status, data exchange, power supply, signaling contact)
- An M12 interface for connecting the isolated signaling contact

The SCALANCE X-200 switches are available with the following port types:

- **10/100BaseTX, RJ45 or M12 connection;**  
RJ45 or M12 port, automatic detection of the data rate (10 or 100 Mbit/s), with autosensing and autocrossover functions for connecting IE FC cables using IE FC RJ45 Plug 180 or IE FC M12 Plug PRO up to 100 m.
- **100BaseFX, BFOC connection technique;**  
BFOC ports for direct connection to Industrial Ethernet glass fiber-optic cables up to 5 km (multimode FOC) or up to 26 km (singlemode FOC) for configuring line, ring and star topologies.

## Function

- Configuring electrical and optical Industrial Ethernet line, star and ring topologies
- Fast redundancy in the ring with
  - High Speed Redundancy Protocol (HRP); up to 0.3 seconds for reconfiguration of the ring with 50 switches in the ring
  - PROFINET MRP (Media Redundancy Protocol); up to 0.2 seconds for reconfiguration of the ring with 50 switches in the ring
- The functioning of the ring is continuously monitored by the integrated redundancy manager. It recognizes failure of a transmission path in the ring or failure of a SCALANCE X-200 and activates the substitute path within 0.3 seconds or 0.2 seconds with MRP
- Use in ring topologies (100 Mbit/s) together with SCALANCE X-300, SCALANCE X-400 and SCALANCE X-500
- Uncrossed connecting cables can be used due to Autocrossover function integrated in the ports
- Easy diagnostics using signaling contact, SNMP and Web browser
- Easy copper cable diagnostics with Web browser for localizing cable breaks
- Integration into the diagnostics of a PROFINET I/O controller with expanded diagnostics functions for a consistent diagnostics concept, including network infrastructure
- Diagnosis of data traffic by means of a parameterizable mirror port with a standard commercial network analyzer
- Optimized support of PROFINET real-time communication (RT) through prioritizing
- Fast device replacement in the event of a fault by using the optional C-PLUG swap medium (not included in scope of supply)

### Network topology and network configuration

The Industrial Ethernet SCALANCE X-200 switches with IP30 degree of protection are usually installed in a control cabinet together with the stations to be connected. Electrical and optical versions can be installed together in star, line and ring topologies. The SCALANCE X208PRO is designed for installation outside the control cabinet.

When configuring the network, it is necessary to observe the following boundary conditions:

- Length of the TP cable between two SCALANCE X switches:
  - Max. 100 m with IE FC cable and IE FC RJ45 Plug 180 or IE FC M12 Plug PRO
  - Max. 10 m using patches with TP cord
- Length of the optical cables
  - Max. 5 000 m with Industrial Ethernet glass fiber-optic cables (multimode)
  - Max. 26 000 m with Industrial Ethernet glass fiber-optic cables (singlemode)
- IP Address:  
The IP address is assigned by means of the DHCP (Dynamic Host Configuration Protocol). If there is no corresponding server in the network, the IP address can be assigned using the supplied software tool PST (Primary Setup Tool) or STEP 7.

# PROFINET/Industrial Ethernet

## Industrial Ethernet Switches

### SCALANCE X-200 managed

#### Function (continued)

2

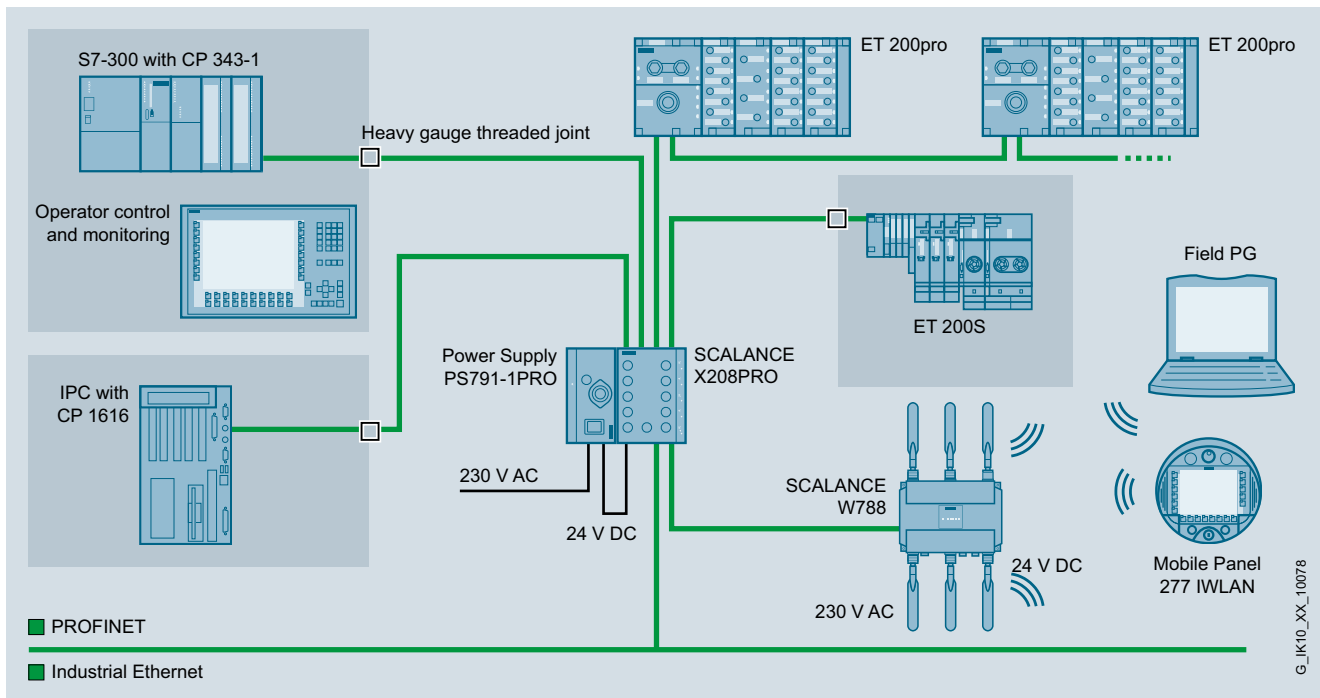

Star network topology with SCALANCE X208PRO outside the control cabinet and 230 V AC power supply

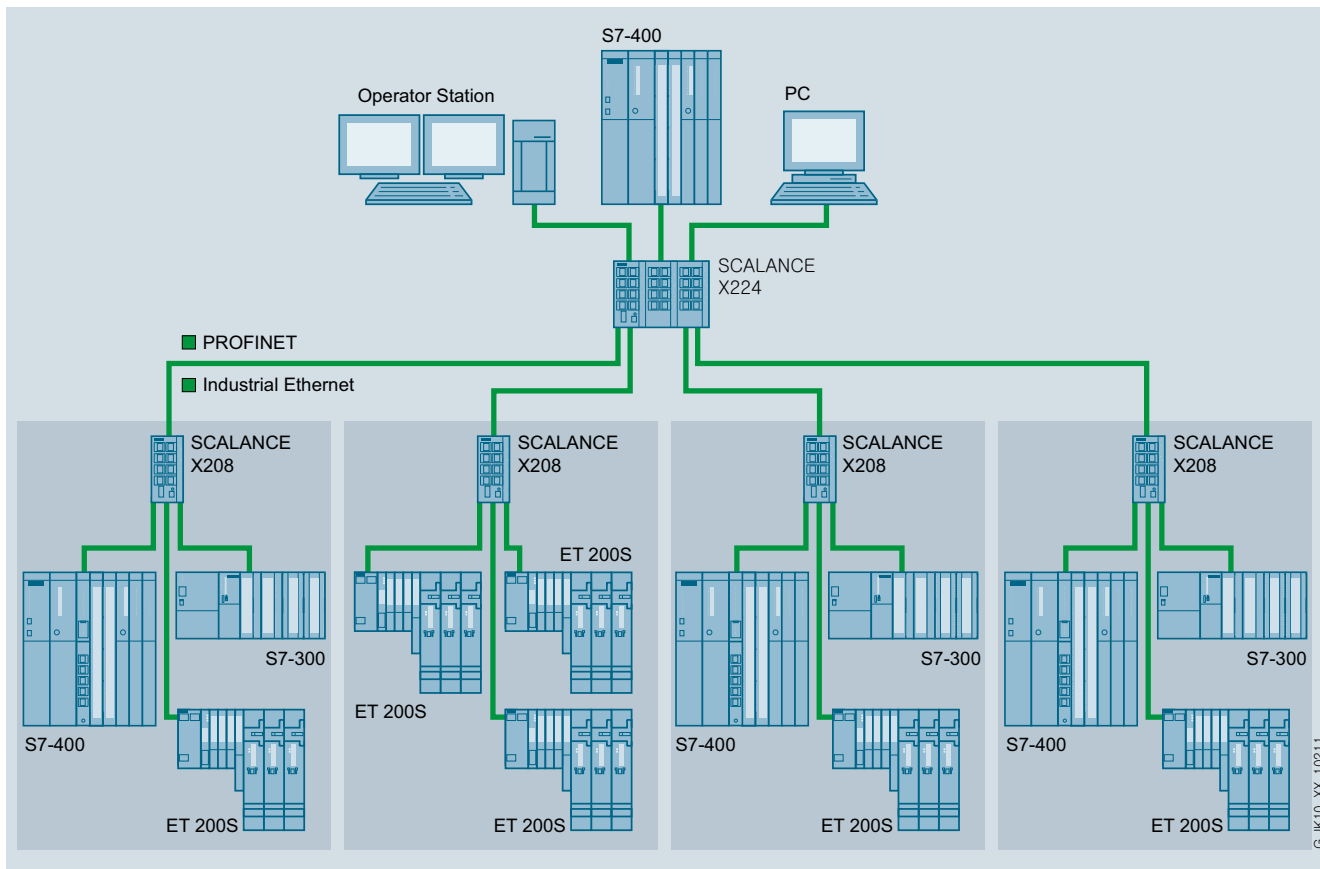

Star topology with SCALANCE X224

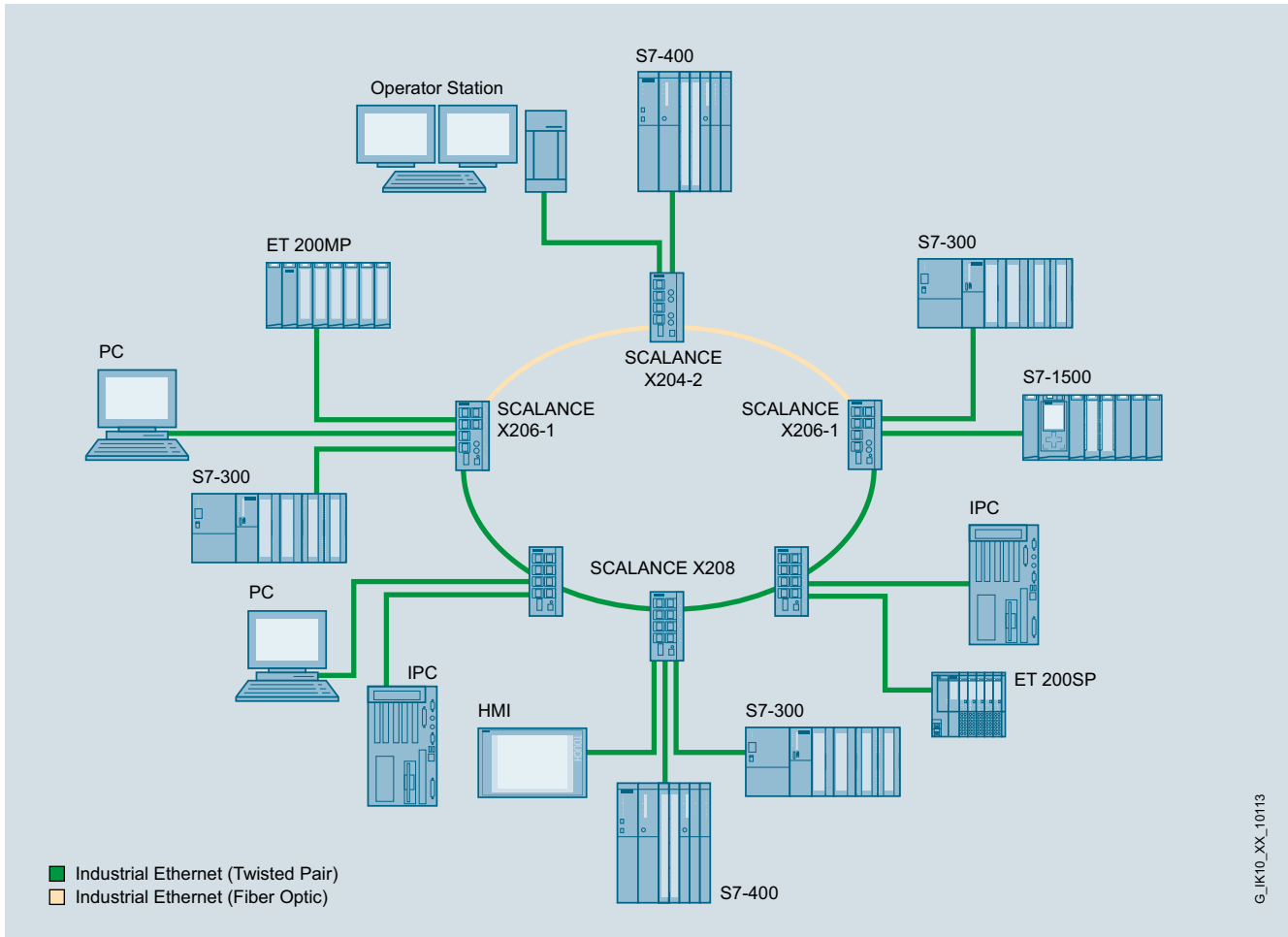
**Function** (continued)

High-speed redundancy in mixed ring with fiber-optic and twisted-pair cables

**Commissioning and diagnostics**

PROFINET diagnostic interrupts from SCALANCE X 200 Switches can be displayed with the appropriate SIMATIC Engineering Tools and processed in the controller with expanded diagnostics function. The engineering outlay for the PLC and HMI have been drastically reduced due to the complete integration in the SIMATIC concept for system error messages.

The SCALANCE X-200 Industrial Ethernet switches can also be integrated into a network management system such as SINEMA Server through the standardized Simple Network Management Protocol (SNMP). If faults occur on the device, error messages (SNMP traps) can be sent to a network management system or as e-mail to a specified network administrator.

The integral Web server enables configuration and diagnostics settings to be made using a standard browser (e.g. port configuration). Statistical information can also be read out over the Web server (e.g. port capacity utilization).

The following information is displayed on site by LEDs:

- Power
- Port status
- Data traffic
- Signaling contact
- Redundancy manager function

The Industrial Ethernet switches of the SCALANCE X-200 line can also be monitored using the floating signaling contact.

# PROFINET/Industrial Ethernet

## Industrial Ethernet Switches

### SCALANCE X-200 managed

#### Technical specifications

Article No.	6GK5204-2BB10-2AA3	6GK5204-2BC10-2AA3	6GK5204-2BB10-2CA2
Product-type designation	SCALANCE X204-2	SCALANCE X204-2LD	SCALANCE X204-2TS
<b>Transmission rate</b>			
Transfer rate 1	10 Mbit/s	10 Mbit/s	10 Mbit/s
Transfer rate 2	100 Mbit/s	100 Mbit/s	100 Mbit/s
<b>Interfaces</b>			
Number of electrical/optical connections			
• for network components or terminal equipment maximum	6	6	6
Number of electrical connections			
• for network components and terminal equipment	4	4	4
• for signaling contact	1	1	1
• for power supply	1	1	1
• for redundant power supply	1	1	1
Design of electrical connection			
• for network components and terminal equipment	RJ45 port	RJ45 port	RJ45 port
• for signaling contact	2-pole terminal block	2-pole terminal block	2-pole terminal block
• for power supply	4-pole terminal block	4-pole terminal block	4-pole terminal block
Number of optical interfaces for optical waveguide at 100 Mbit/s	2	2	2
Design of optical interface for optical waveguide at 100 Mbit/s	BFOC sockets (multimode up to 5 km)	BFOC port (singlemode up to 26 km)	BFOC sockets (multimode up to 5 km)
Connectable optical power relative to 1 mW			
• of the transmitter output	-19 ... -14 dB	-15 ... -7 dB	-19 ... -14 dB
• of the receiver input maximum	-	-	-
Optical sensitivity relative to 1 mW of the receiver input minimum	-34 dB	-34 dB	-34 dB
Attenuation of fiber-optic cable transmission link minimum necessary	0 dB	0 dB	0 dB
Range at the optical interface depending on the optical fiber used	0 ... 5 km	0 ... 26 km	0 ... 5 km
Design of the removable storage C-PLUG	Yes	Yes	Yes
<b>Signal-Inputs/outputs</b>			
Operating voltage of signaling contacts at DC rated value	24 V	24 V	24 V
Operating current of signaling contacts at DC maximum	0.1 A	0.1 A	0.05 A
<b>Supply voltage, current consumption, power loss</b>			
Type of supply voltage	DC	DC	DC
Supply voltage external	24 V	24 V	12 V
• minimum	18 V	18 V	10 V
• maximum	32 V	32 V	30 V
Product component fusing at power supply input	Yes	Yes	Yes
Type of fusing at input for supply voltage	0.6 A / 60 V	0.6 A / 60 V	3 A / 32 V
Consumed current maximum	0.265 A	0.265 A	0.6 A
Active power loss at 24 V for DC	6.36 W	6.36 W	6.6 W

**Technical specifications (continued)**

Article No.	6GK5204-2BB10-2AA3	6GK5204-2BC10-2AA3	6GK5204-2BB10-2CA2
Product-type designation	SCALANCE X204-2	SCALANCE X204-2LD	SCALANCE X204-2TS
<b>Permitted ambient conditions</b>			
Ambient temperature			
• during operating	-40 ... +60 °C	-40 ... +60 °C	-40 ... +70 °C
• during storage	-40 ... +70 °C	-40 ... +70 °C	-40 ... +70 °C
• during transport	-40 ... +70 °C	-40 ... +70 °C	-40 ... +70 °C
• Comment	-	-	If the IE switch X-204-2TS is installed horizontally, a maximum ambient temperature of +40 °C is permitted
Relative humidity at 25 °C without condensation during operating maximum	95 %	95 %	95 %
Ambient condition for (standard) operation mode	-	-	Conformal coating, yes
Protection class IP	IP30	IP30	IP20
<b>Design, dimensions and weight</b>			
Design	compact	compact	compact
Width	60 mm	60 mm	60 mm
Height	125 mm	125 mm	125 mm
Depth	124 mm	124 mm	124 mm
Net weight	0.78 kg	0.78 kg	0.78 kg
Mounting type			
• 35 mm DIN rail mounting	Yes	Yes	Yes
• wall mounting	Yes	Yes	Yes
• S7-300 rail mounting	Yes	Yes	Yes
<b>Product properties, functions, components general</b>			
Cascading in the case of a redundant ring at reconfiguration time of < 0.3 s	50	50	50
Cascading in cases of star structuring	Any (depending only on signal propagation time)	Any (depending only on signal propagation time)	Any (depending only on signal propagation time)
<b>Product functions management, configuration</b>			
Product function			
• CLI	Yes	Yes	Yes
• web-based management	Yes	Yes	Yes
• MIB support	Yes	Yes	Yes
• TRAPs via email	Yes	Yes	Yes
• Configuration with STEP 7	Yes	Yes	Yes
• SMTP server	-	-	-
• Port mirroring	Yes	Yes	Yes
• for IRT PROFINET IO switch	No	No	No
• PROFINET IO diagnosis	Yes	Yes	Yes
• switch-managed	Yes	Yes	Yes
Protocol is supported			
• Telnet	Yes	Yes	Yes
• HTTP	Yes	Yes	Yes
• HTTPS	Yes	Yes	Yes
• TFTP	Yes	Yes	Yes
• FTP	Yes	Yes	Yes
• BOOTP	No	No	No
• SNMP v1	Yes	Yes	Yes
• SNMP v2	Yes	Yes	Yes
• SNMP v3	Yes	Yes	Yes
• DCP	Yes	Yes	Yes
• LLDP	Yes	Yes	Yes
Identification & maintenance function			
• I&M0 - device-specific information	Yes	Yes	Yes
• I&M1 - higher level designation/location designation	Yes	Yes	Yes

# PROFINET/Industrial Ethernet

## Industrial Ethernet Switches

### SCALANCE X-200 managed

#### Technical specifications (continued)

Article No.	6GK5204-2BB10-2AA3	6GK5204-2BC10-2AA3	6GK5204-2BB10-2CA2
Product-type designation	SCALANCE X204-2	SCALANCE X204-2LD	SCALANCE X204-2TS
<b>Product functions Diagnosis</b>			
Product function			
• Port diagnostics	Yes	Yes	Yes
• Statistics packet size	Yes	Yes	Yes
• Statistics packet type	Yes	Yes	Yes
• Error statistics	Yes	Yes	Yes
<b>Product functions DHCP</b>			
Product function DHCP client	Yes	Yes	Yes
<b>Product functions Redundancy</b>			
Product function			
• Ring redundancy	Yes	Yes	Yes
• Redundancy manager	Yes	Yes	Yes
• Standby redundancy	No	No	No
• High Speed Redundancy Protocol (HRP)	Yes	Yes	Yes
• Media Redundancy Protocol (MRP)	Yes	Yes	Yes
• Parallel Redundancy Protocol (PRP)	No	No	No
• Passive listening	Yes	Yes	Yes
Protocol is supported PRP	Yes	Yes	Yes
<b>Product functions Security</b>			
Protocol is supported SSH	Yes	Yes	Yes
<b>Product functions Time</b>			
Product function			
• SICLOCK support	Yes	Yes	Yes
Protocol is supported			
• NTP	No	No	No
• SNTP	Yes	Yes	Yes
<b>Standards, specifications, approvals</b>			
Standard			
• for EMC from FM	FM3611: Class 1, Division 2, Group A, B, C, D / T4, CL.1, Zone 2, GP. IIC, T4	FM3611: Class 1, Division 2, Group A, B, C, D / T4, CL.1, Zone 2, GP. IIC, T4	FM3611: Class 1, Division 2, Group A, B, C, D / T4, CL.1, Zone 2, GP. IIC, T4
• for hazardous zone	EN 60079-0: 2006, EN 60079-15: 2005, II 3 (2) G Ex nA [op is] IIC T4, KEMA 07 ATEX 0145 X	EN 60079-0 : 2006, EN 60079-15: 2005, II 3 G Ex nA II T4 KEMA 07 ATEX 0145X	EN 60079-0: 2006, EN 60079-15: 2005, II 3 (2) G Ex nA [op is] IIC T4, KEMA 07 ATEX 0145 X
• for safety of CSA and UL	UL 60950-1, CSA C22.2 No. 60950-1	UL 60950-1, CSA C22.2 No. 60950-1	UL 60950-1, CSA C22.2 No. 60950-1
• for hazardous area of CSA and UL	ANSI / ISA 12.12.01, CSA C22.2 No. 213-M1987, CL. 1 / Div. 2 / GP. A, B, C, D T4, CL. 1 / Zone 2 / GP. IIC, T4	ANSI / ISA 12.12.01, CSA C22.2 No. 213-M1987, CL. 1 / Div. 2 / GP. A, B, C, D T4, CL. 1 / Zone 2 / GP. IIC, T4	ANSI / ISA 12.12.01, CSA C22.2 No. 213-M1987, CL. 1 / Div. 2 / GP. A, B, C, D T4, CL. 1 / Zone 2 / GP. IIC, T4
• for emitted interference	EN 61000-6-4:2001 (Class A)	EN 61000-6-4 (Class A)	EN 61000-6-4 (Class A)
• for interference immunity	EN 61000-6-4:2001	EN 61000-6-2	EN 61000-6-2
Verification of suitability	EN 61000-6-4:2001	EN 61000-6-2, EN 61000-6-4	EN 61000-6-2, EN 61000-6-4
• CE mark	Yes	Yes	Yes
• C-Tick	Yes	Yes	Yes
• KC approval	Yes	Yes	Yes
• Railway application in accordance with EN 50155	No	No	Yes
• Railway application in accordance with EN 50124-1	No	No	No
Marine classification association			
• American Bureau of Shipping Europe Ltd. (ABS)	Yes	Yes	No
• Bureau Veritas (BV)	Yes	Yes	No
• Det Norske Veritas (DNV)	Yes	Yes	No
• Germanische Lloyd (GL)	Yes	Yes	No
• Lloyds Register of Shipping (LRS)	Yes	Yes	No
• Nippon Kaiji Kyokai (NK)	Yes	Yes	No
• Polski Rejestr Statkow (PRS)	Yes	Yes	No



**Technical specifications (continued)**

Article No.	6GK5206-1BB10-2AA3	6GK5206-1BC10-2AA3	6GK5208-0BA10-2AA3	6GK5208-0HA10-2AA6
Product-type designation	SCALANCE X206-1	SCALANCE X206-1LD	SCALANCE X208	SCALANCE X208PRO
<b>Transmission rate</b>				
Transfer rate 1	10 Mbit/s	10 Mbit/s	10 Mbit/s	10 Mbit/s
Transfer rate 2	100 Mbit/s	100 Mbit/s	100 Mbit/s	100 Mbit/s
<b>Interfaces</b>				
Number of electrical/optical connections				
• for network components or terminal equipment maximum	7	7	8	8
Number of electrical connections				
• for network components and terminal equipment	6	6	8	8
• for signaling contact	1	1	1	1
• for power supply	1	1	1	1
• for redundant power supply	1	1	1	1
Design of electrical connection				
• for network components and terminal equipment	RJ45 port	RJ45 port	RJ45 port	M12 port, 4-pin, D-coded
• for signaling contact	2-pole terminal block	2-pole terminal block	2-pole terminal block	5-pin M12 socket (b-coded)
• for power supply	4-pole terminal block	4-pole terminal block	4-pole terminal block	4-pin M12 interface (A-coded)
Number of optical interfaces for optical waveguide at 100 Mbit/s	1	1	-	-
Design of optical interface for optical waveguide at 100 Mbit/s	BFOC sockets (multimode up to 5 km)	BFOC port (singlemode up to 26 km)	-	-
Connectable optical power relative to 1 mW				
• of the transmitter output	-19 ... -14 dB	-15 ... -7 dB	-	-
Optical sensitivity relative to 1 mW of the receiver input minimum	-	-34 dB	-	-
Attenuation of fiber-optic cable transmission link minimum necessary	0 dB	0 dB	-	-
Range at the optical interface depending on the optical fiber used	0 ... 5 km	0 ... 26 km	-	-
Design of the removable storage C-PLUG	Yes	Yes	Yes	Yes
<b>Signal-Inputs/outputs</b>				
Operating voltage of signaling contacts at DC rated value	24 V	24 V	24 V	24 V
Operating current of signaling contacts at DC maximum	0.1 A	0.1 A	0.1 A	0.1 A
<b>Supply voltage, current consumption, power loss</b>				
Type of supply voltage	DC	DC	DC	DC
Supply voltage external	24 V	24 V	24 V	24 V
• minimum	18 V	18 V	18 V	18 V
• maximum	32 V	32 V	32 V	32 V
Product component fusing at power supply input	Yes	Yes	Yes	Yes
Type of fusing at input for supply voltage	0.6 A / 60 V	0.6 A / 60 V	0.6 A / 60 V	0.6 A / 60 V
Consumed current maximum	0.22 A	0.2 A	0.185 A	0.185 A
Active power loss at 24 V for DC	5.28 W	5.28 W	3.84 W	4.4 W

## PROFINET/Industrial Ethernet

### Industrial Ethernet Switches

#### SCALANCE X-200 managed

#### Technical specifications (continued)

Article No.	6GK5206-1BB10-2AA3	6GK5206-1BC10-2AA3	6GK5208-0BA10-2AA3	6GK5208-0HA10-2AA6
Product-type designation	SCALANCE X206-1	SCALANCE X206-1LD	SCALANCE X208	SCALANCE X208PRO
<b>Permitted ambient conditions</b>				
Ambient temperature				
• during operating	-40 °C ... + 60 °C	-40 °C ... + 60 °C	-40 °C ... + 60 °C	-40 °C ... + 70 °C
• during storage	-40 ... +70 °C	-40 ... +70 °C	-40 ... +70 °C	-40 ... +70 °C
• during transport	-40 ... +70 °C	-40 ... +70 °C	-40 ... +70 °C	-40 ... +70 °C
Relative humidity at 25 °C without condensation during operating maximum	95 %	95 %	95 %	95 %
Protection class IP	IP30	IP30	IP30	IP65/67
<b>Design, dimensions and weight</b>				
Design	compact	compact	compact	compact
Width	60 mm	60 mm	60 mm	90 mm
Height	125 mm	125 mm	125 mm	125 mm
Depth	124 mm	124 mm	124 mm	124 mm
Net weight	0.78 kg	0.78 kg	0.78 kg	1 kg
Mounting type				
• 35 mm DIN rail mounting	Yes	Yes	Yes	Yes
• wall mounting	Yes	Yes	Yes	Yes
• S7-300 rail mounting	Yes	Yes	Yes	Yes
<b>Product properties, functions, components general</b>				
Cascading in the case of a redundant ring at reconfiguration time of < 0.3 s	50	50	50	50
Cascading in cases of star structuring	Any (depending only on signal propagation time)	Any (depending only on signal propagation time)	Any (depending only on signal propagation time)	Any (depending only on signal propagation time)
<b>Product functions management, configuration</b>				
Product function				
• CLI	Yes	Yes	Yes	Yes
• web-based management	Yes	Yes	Yes	Yes
• MIB support	Yes	Yes	Yes	Yes
• TRAPs via email	Yes	Yes	Yes	Yes
• Configuration with STEP 7	Yes	Yes	Yes	Yes
• SMTP server	-	-	-	-
• Port mirroring	Yes	Yes	Yes	Yes
• for IRT PROFINET IO switch	No	No	No	No
• PROFINET IO diagnosis	Yes	Yes	Yes	Yes
• switch-managed	Yes	Yes	Yes	Yes
Protocol is supported				
• Telnet	Yes	Yes	Yes	Yes
• HTTP	Yes	Yes	Yes	Yes
• HTTPS	Yes	Yes	Yes	Yes
• TFTP	Yes	Yes	Yes	Yes
• FTP	Yes	Yes	Yes	Yes
• BOOTP	No	No	No	No
• SNMP v1	Yes	Yes	Yes	Yes
• SNMP v2	Yes	Yes	Yes	Yes
• SNMP v3	Yes	Yes	Yes	Yes
• DCP	Yes	Yes	Yes	Yes
• LLDP	Yes	Yes	Yes	Yes
Identification & maintenance function				
• I&M0 - device-specific information	Yes	Yes	Yes	Yes
• I&M1 - higher level designation/location designation	Yes	Yes	Yes	Yes

**Technical specifications (continued)**

Article No.	6GK5206-1BB10-2AA3	6GK5206-1BC10-2AA3	6GK5208-0BA10-2AA3	6GK5208-0HA10-2AA6
Product-type designation	SCALANCE X206-1	SCALANCE X206-1LD	SCALANCE X208	SCALANCE X208PRO
<b>Product functions Diagnosis</b>				
Product function				
• Port diagnostics	Yes	Yes	Yes	Yes
• Statistics packet size	Yes	Yes	Yes	Yes
• Statistics packet type	Yes	Yes	Yes	Yes
• Error statistics	Yes	Yes	Yes	Yes
<b>Product functions DHCP</b>				
Product function DHCP client	Yes	Yes	Yes	Yes
<b>Product functions Redundancy</b>				
Product function				
• Ring redundancy	Yes	Yes	Yes	Yes
• Redundancy manager	Yes	Yes	Yes	Yes
• Standby redundancy	No	No	No	No
• High Speed Redundancy Protocol (HRP)	Yes	Yes	Yes	Yes
• Media Redundancy Protocol (MRP)	Yes	Yes	Yes	Yes
• Parallel Redundancy Protocol (PRP)	No	No	No	No
• Passive listening	Yes	Yes	Yes	Yes
Protocol is supported PRP	Yes	Yes	Yes	Yes
<b>Product functions Security</b>				
Protocol is supported SSH	Yes	Yes	Yes	Yes
<b>Product functions Time</b>				
Product function				
• SICKLOCK support	Yes	Yes	Yes	Yes
Protocol is supported				
• NTP	No	No	No	No
• SNTP	Yes	Yes	Yes	Yes
<b>Standards, specifications, approvals</b>				
Standard				
• for EMC from FM	FM3611: Class 1, Division 2, Group A, B, C, D / T4, CL. 1, Zone 2, GP. IIC, T4	FM3611: Class 1, Division 2, Group A, B, C, D / T4, CL. 1, Zone 2, GP. IIC, T4	FM3611: Class 1, Division 2, Group A, B, C, D / T4, CL. 1, Zone 2, GP. IIC, T4	FM3611: Class 1, Division 2, Group A, B, C, D / T4, CL. 1, Zone 2, GP. IIC, T4
• for hazardous zone	EN 60079-0: 2006, EN 60079-15: 2005, II 3 (2) G Ex nA [op is] IIC T4, KEMA 07 ATEX 0145 X	EN 60079-0: 2006, EN 60079-15: 2005, II 3 G Ex nA II T4 KEMA 07 ATEX 0145X	EN 60079-0: 2006, EN 60079-15: 2005, II 3 G Ex nA II T4 KEMA 07 ATEX 0145X	EN 60079-0: 2006, EN 60079-15: 2005, II 3 G Ex nA II T4 KEMA 07 ATEX 0145X
• for safety of CSA and UL	UL 60950-1, CSA C22.2 No. 60950-1	UL 60950-1, CSA C22.2 No. 60950-1	UL 60950-1, CSA C22.2 No. 60950-1	UL 60950-1, CSA C22.2 No. 60950-1
• for hazardous area of CSA and UL	ANSI / ISA 12.12.01, CSA C22.2 No. 213-M1987, CL. 1 / Div. 2 / GP. A, B, C, D T4, CL. 1 / Zone 2 / GP. IIC, T4	ANSI / ISA 12.12.01, CSA C22.2 No. 213-M1987, CL. 1 / Div. 2 / GP. A, B, C, D T4, CL. 1 / Zone 2 / GP. IIC, T4	ANSI / ISA 12.12.01, CSA C22.2 No. 213-M1987, CL. 1 / Div. 2 / GP. A, B, C, D T4, CL. 1 / Zone 2 / GP. IIC, T4	ANSI / ISA 12.12.01, CSA C22.2 No. 213-M1987, CL. 1 / Div. 2 / GP. A, B, C, D T4, CL. 1 / Zone 2 / GP. IIC, T4
• for emitted interference	EN 61000-6-4:2001 (Class A)	EN 61000-6-4 (Class A)	EN 61000-6-4 (Class A)	EN 61000-6-4 (Class A)
• for interference immunity	EN 61000-6-2:2001	EN 61000-6-2	EN 61000-6-2	EN 61000-6-2
Verification of suitability	EN 61000-6-2:2001, EN 61000-6-4:2001	EN 61000-6-2, EN 61000-6-4	EN 61000-6-2, EN 61000-6-4	EN 61000-6-2, EN 61000-6-4
• CE mark	Yes	Yes	Yes	Yes
• C-Tick	Yes	Yes	Yes	Yes
• KC approval	Yes	Yes	Yes	Yes
• Railway application in accordance with EN 50155	No	No	No	No
• Railway application in accordance with EN 50124-1	No	No	No	No
Marine classification association				
• American Bureau of Shipping Europe Ltd. (ABS)	Yes	Yes	Yes	No
• Bureau Veritas (BV)	Yes	Yes	Yes	No
• Det Norske Veritas (DNV)	Yes	Yes	Yes	No
• Germanische Lloyd (GL)	Yes	Yes	Yes	No
• Lloyds Register of Shipping (LRS)	Yes	Yes	Yes	No
• Nippon Kaiji Kyokai (NK)	Yes	Yes	Yes	No
• Polski Rejestr Statkow (PRS)	Yes	Yes	Yes	No

# PROFINET/Industrial Ethernet

## Industrial Ethernet Switches

### SCALANCE X-200 managed

#### Technical specifications (continued)

Article No.	6GK5212-2BB00-2AA3	6GK5212-2BC00-2AA3	6GK5216-0BA00-2AA3	6GK5224-0BA00-2AA3
Product-type designation	SCALANCE X212-2	SCALANCE X212-2LD	SCALANCE X216	SCALANCE X224
<b>Transmission rate</b>				
Transfer rate 1	10 Mbit/s	10 Mbit/s	10 Mbit/s	10 Mbit/s
Transfer rate 2	100 Mbit/s	100 Mbit/s	100 Mbit/s	100 Mbit/s
<b>Interfaces</b>				
Number of electrical/optical connections				
• for network components or terminal equipment maximum	14	14	16	24
Number of electrical connections				
• for network components and terminal equipment	12	12	16	24
• for signaling contact	1	1	1	1
• for power supply	1	1	1	1
• for redundant power supply	1	1	1	1
Design of electrical connection				
• for network components and terminal equipment	RJ45 port	RJ45 port	RJ45 port	RJ45 port
• for signaling contact	2-pole terminal block	2-pole terminal block	2-pole terminal block	2-pole terminal block
• for power supply	4-pole terminal block	4-pole terminal block	4-pole terminal block	4-pole terminal block
Number of optical interfaces for optical waveguide at 100 Mbit/s	2	2	-	-
Design of optical interface for optical waveguide at 100 Mbit/s	BFOC sockets (multimode up to 5 km)	BFOC port (singlemode up to 26 km)	-	-
Connectable optical power relative to 1 mW				
• of the transmitter output	-19 ... -14 dB	-15 ... -7 dB	-	-
• of the receiver input maximum	-	-	-	-
Optical sensitivity relative to 1 mW of the receiver input minimum	-34 dB	-34 dB	-	-
Attenuation of fiber-optic cable transmission link minimum necessary	0 dB	0 dB	-	-
Range at the optical interface depending on the optical fiber used	0 ... 5 km	0 ... 26 km	-	-
Design of the removable storage C-PLUG	Yes	Yes	Yes	Yes
<b>Signal-Inputs/outputs</b>				
Operating voltage of signaling contacts at DC rated value	24 V	24 V	24 V	24 V
Operating current of signaling contacts at DC maximum	0.1 A	0.1 A	0.1 A	0.1 A
<b>Supply voltage, current consumption, power loss</b>				
Type of supply voltage	DC	DC	DC	DC
Supply voltage external	24 V	24 V	24 V	24 V
• minimum	18 V	18 V	18 V	18 V
• maximum	32 V	32 V	32 V	32 V
Product component fusing at power supply input	Yes	Yes	Yes	Yes
Type of fusing at input for supply voltage	1.1 A / 33 V	1.1 A / 33 V	1.1 A / 33 V	1.1 A / 33 V
Consumed current maximum	0.33 A	0.33 A	0.24 A	0.35 A
Active power loss at 24 V for DC	7.92 W	7.92 W	5.76 W	8.4 W

**Technical specifications (continued)**

Article No.	6GK5212-2BB00-2AA3	6GK5212-2BC00-2AA3	6GK5216-0BA00-2AA3	6GK5224-0BA00-2AA3
Product-type designation	SCALANCE X212-2	SCALANCE X212-2LD	SCALANCE X216	SCALANCE X224
<b>Permitted ambient conditions</b>				
Ambient temperature				
• during operating	-40 ... +60 °C	-40 ... +60 °C	-40 ... +60 °C	-40 ... +60 °C
• during storage	-40 ... +70 °C	-40 ... +70 °C	-40 ... +70 °C	-40 ... +70 °C
Relative humidity at 25 °C without condensation during operating maximum	95 %	95 %	95 %	95 %
Protection class IP	IP30	IP30	IP30	IP30
<b>Design, dimensions and weight</b>				
Design	compact	compact	compact	compact
Width	120 mm	120 mm	120 mm	180 mm
Height	125 mm	125 mm	125 mm	125 mm
Depth	124 mm	124 mm	124 mm	124 mm
Net weight	1.2 kg	1.2 kg	1.2 kg	1.6 kg
Mounting type				
• 35 mm DIN rail mounting	Yes	Yes	Yes	Yes
• wall mounting	Yes	Yes	Yes	Yes
• S7-300 rail mounting	Yes	Yes	Yes	Yes
<b>Product properties, functions, components general</b>				
Cascading in the case of a redundant ring at reconfiguration time of < 0.3 s	50	50	50	50
Cascading in cases of star structuring	Any (depending only on signal propagation time)	Any (depending only on signal propagation time)	Any (depending only on signal propagation time)	Any (depending only on signal propagation time)
<b>Product functions management, configuration</b>				
Product function				
• CLI	Yes	Yes	Yes	Yes
• web-based management	Yes	Yes	Yes	Yes
• MIB support	Yes	Yes	Yes	Yes
• TRAPs via email	Yes	Yes	Yes	Yes
• Configuration with STEP 7	Yes	Yes	Yes	Yes
• SMTP server	-	-	-	-
• Port mirroring	Yes	Yes	Yes	Yes
• for IRT PROFINET IO switch	No	No	No	No
• PROFINET IO diagnosis	Yes	Yes	Yes	Yes
• switch-managed	Yes	Yes	Yes	Yes
Protocol is supported				
• Telnet	Yes	Yes	Yes	Yes
• HTTP	Yes	Yes	Yes	Yes
• HTTPS	Yes	Yes	Yes	Yes
• TFTP	Yes	Yes	Yes	Yes
• FTP	Yes	Yes	Yes	Yes
• BOOTP	No	No	No	No
• SNMP v1	Yes	Yes	Yes	Yes
• SNMP v2	Yes	Yes	Yes	Yes
• SNMP v3	Yes	Yes	Yes	Yes
• DCP	Yes	Yes	Yes	Yes
• LLDP	Yes	Yes	Yes	Yes
Identification & maintenance function				
• I&M0 - device-specific information	Yes	Yes	Yes	Yes
• I&M1 - higher level designation/location designation	Yes	Yes	Yes	Yes

# PROFINET/Industrial Ethernet

## Industrial Ethernet Switches

### SCALANCE X-200 managed

#### Technical specifications (continued)

Article No.	6GK5212-2BB00-2AA3	6GK5212-2BC00-2AA3	6GK5216-0BA00-2AA3	6GK5224-0BA00-2AA3
Product-type designation	SCALANCE X212-2	SCALANCE X212-2LD	SCALANCE X216	SCALANCE X224
<b>Product functions Diagnosis</b>				
Product function				
• Port diagnostics	Yes	Yes	Yes	Yes
• Statistics packet size	Yes	Yes	Yes	Yes
• Statistics packet type	Yes	Yes	Yes	Yes
• Error statistics	Yes	Yes	Yes	Yes
<b>Product functions DHCP</b>				
Product function DHCP client	Yes	Yes	Yes	Yes
<b>Product functions Redundancy</b>				
Product function				
• Ring redundancy	Yes	Yes	Yes	Yes
• Redundancy manager	Yes	Yes	Yes	Yes
• Standby redundancy	No	No	No	No
• High Speed Redundancy Protocol (HRP)	Yes	Yes	Yes	Yes
• Media Redundancy Protocol (MRP)	Yes	Yes	Yes	Yes
• Parallel Redundancy Protocol (PRP)	No	No	No	No
• Passive listening	Yes	Yes	Yes	Yes
Protocol is supported PRP	Yes	Yes	Yes	Yes
<b>Product functions Security</b>				
Protocol is supported SSH	Yes	Yes	Yes	Yes
<b>Product functions Time</b>				
Product function SICLOCK support	Yes	Yes	Yes	Yes
Protocol is supported				
• NTP	No	No	No	No
• SNTP	Yes	Yes	Yes	Yes
<b>Standards, specifications, approvals</b>				
Standard				
• for EMC from FM	FM3611: Class 1, Division 2, Group A, B, C, D / T4, CL.1, Zone 2, GP. IIC, T4	FM3611: Class 1, Division 2, Group A, B, C, D / T4, CL.1, Zone 2, GP. IIC, T4	FM3611: Class 1, Division 2, Group A, B, C, D / T4, CL.1, Zone 2, GP. IIC, T4	FM3611: Class 1, Division 2, Group A, B, C, D / T4, CL.1, Zone 2, GP. IIC, T4
• for hazardous zone	EN 60079-0: 2006, EN 60079-15: 2005, II 3 (2) G Ex nA [op is] IIC T4, KEMA 07 ATEX 0145 X	EN 60079-0 : 2006, EN 60079-15: 2005, II 3 G Ex nA II T4 KEMA 07 ATEX 0145X	EN 60079-0 : 2006, EN 60079-15: 2005, II 3 G Ex nA II T4 KEMA 07 ATEX 0145X	EN 60079-0 : 2006, EN 60079-15: 2005, II 3 G Ex nA II T4 KEMA 07 ATEX 0145X
• for safety of CSA and UL	UL 60950-1, CSA C22.2 No. 60950-1	UL 60950-1, CSA C22.2 No. 60950-1	UL 60950-1, CSA C22.2 No. 60950-1	UL 60950-1, CSA C22.2 No. 60950-1
• for hazardous area of CSA and UL	ANSI / ISA 12.12.01, CSA C22.2 No. 213-M1987, CL. 1 / Div. 2 / GP. A, B, C, D T4, CL. 1 / Zone 2 / GP. IIC, T4	ANSI / ISA 12.12.01, CSA C22.2 No. 213-M1987, CL. 1 / Div. 2 / GP. A, B, C, D T4, CL. 1 / Zone 2 / GP. IIC, T4	ANSI / ISA 12.12.01, CSA C22.2 No. 213-M1987, CL. 1 / Div. 2 / GP. A, B, C, D T4, CL. 1 / Zone 2 / GP. IIC, T4	ANSI / ISA 12.12.01, CSA C22.2 No. 213-M1987, CL. 1 / Div. 2 / GP. A, B, C, D T4, CL. 1 / Zone 2 / GP. IIC, T4
• for emitted interference	EN 61000-6-4:2001 (Class A)	EN 61000-6-4:2001 (Class A)	EN 61000-6-4:2001 (Class A)	EN 61000-6-4:2001 (Class A)
• for interference immunity	EN 61000-6-2:2001	EN 61000-6-2:2001	EN 61000-6-2:2001	EN 61000-6-2:2001
Verification of suitability	EN 61000-6-2:2001, EN 61000-6-4:2001	EN 61000-6-2:2001, EN 61000-6-4:2001	EN 61000-6-2:2001, EN 61000-6-4:2001	EN 61000-6-2:2001, EN 61000-6-4:2001
• CE mark	Yes	Yes	Yes	Yes
• C-Tick	Yes	Yes	Yes	Yes
• KC approval	Yes	Yes	Yes	Yes
• Railway application in accordance with EN 50155	No	No	No	No
• Railway application in accordance with EN 50124-1	No	No	No	No
Marine classification association				
• American Bureau of Shipping Europe Ltd. (ABS)	Yes	Yes	Yes	Yes
• Bureau Veritas (BV)	Yes	Yes	Yes	Yes
• Det Norske Veritas (DNV)	Yes	Yes	Yes	Yes
• Germanische Lloyd (GL)	Yes	Yes	Yes	Yes
• Lloyds Register of Shipping (LRS)	Yes	Yes	Yes	Yes
• Nippon Kaiji Kyokai (NK)	Yes	Yes	Yes	Yes
• Polski Rejestr Statkow (PRS)	No	No	No	No

**Ordering data**
**Article No.**
**Article No.**
**Industrial Ethernet Switches  
SCALANCE X-200**

Industrial Ethernet switches with integral SNMP access, online diagnostics, copper cable diagnostics and PROFINET diagnostics for configuring line, star and ring topologies; with integrated redundancy manager (exception: SCALANCE X208PRO); incl. operating instructions, Industrial Ethernet network manual and configuration software on CD-ROM

- With electrical and optical ports for glass multimode FOC up to max. 5 km
  - **SCALANCE X204-2**  
with four 10/100 Mbit/s RJ45 ports and two fiber-optic ports
  - **SCALANCE X204-2TS**  
with four 10/100 Mbit/s RJ45 ports and two fiber-optic ports with extended temperature range and EN 50155 approval for railway applications
  - **SCALANCE X206-1**  
with six 10/100 Mbit/s RJ45 ports and one fiber-optic port
  - **SCALANCE X212-2**  
with twelve 10/100 Mbit/s RJ45 ports and two fiber-optic ports
- With electrical and optical ports for glass single mode FOC up to max. 26 km
  - **SCALANCE X204-2LD**  
with four 10/100 Mbit/s RJ45 ports and two long-distance fiber-optic ports
  - **SCALANCE X206-1LD**  
with six 10/100 Mbit/s RJ45 ports and one long-distance fiber-optic port
  - **SCALANCE X212-2LD**  
with twelve 10/100 Mbit/s RJ45 ports and two long-distance fiber-optic ports
- With electrical ports
  - **SCALANCE X208;**  
with eight 10/100 Mbit/s RJ45 ports
  - **SCALANCE X208PRO**  
with eight 10/100 Mbit/s M12 ports, incl. eleven M12 dust protection caps, IP65 degree of protection
  - **SCALANCE X216**  
with sixteen 10/100 Mbit/s RJ45 ports
  - **SCALANCE X224**  
with twenty-four 10/100 Mbit/s RJ45 ports

**6GK5204-2BB10-2AA3**
**6GK5204-2BB10-2CA2**
**6GK5206-1BB10-2AA3**
**6GK5212-2BB00-2AA3**
**6GK5204-2BC10-2AA3**
**6GK5206-1BC10-2AA3**
**6GK5212-2BC00-2AA3**
**6GK5208-0BA10-2AA3**
**6GK5208-0HA10-2AA6**
**6GK5216-0BA00-2AA3**
**6GK5224-0BA00-2AA3**
**Accessories**
**IE FC TP Standard Cable GP 2 x 2  
(Type A)**

4-core, shielded TP installation cable for connection to IE FC Outlet RJ45/IE FC RJ45 Plug; PROFINET-compatible; with UL approval; sold by the meter; max. length 1 000 m, minimum order quantity 20 m

**6XV1840-2AH10**
**FO Standard Cable GP  
50/125/1400<sup>1)2)</sup>**

Multimode cable, sold by the meter; max. length 1 000 m; minimum order 20 m;

**6XV1873-2A**
**FO Robust Cable GP  
4E9/125/90**

Singlemode cable, sold by the meter; max. length 1 000 m; minimum order 20 m

**6XV1843-2R**
**FC FO Standard Cable GP  
62.5/200/230**

FC FO standard cable for fixed routing indoors with PVC sheath; sold by the meter; max. length 1 000 m; minimum order 20 m

**6XV1847-2A**
**IE FC RJ45 Plug 180 2 x 2**

RJ45 plug connector for Industrial Ethernet with a rugged metal enclosure and integrated insulation displacement contacts for connecting Industrial Ethernet FC installation cables; with 180° cable outlet; for network components and CPs/CPUs with Industrial Ethernet interface

- 1 pack = 1 unit
- 1 pack = 10 units
- 1 pack = 50 units

**6GK1901-1BB10-2AA0**  
**6GK1901-1BB10-2AB0**  
**6GK1901-1BB10-2AE0**
**FC BFOC Plug**

Screw connector for on-site assembly on FC fiber-optic cable; (1 pack = 20 units + cleaning cloths)

**6GK1900-1GB00-0AC0**
**IE FC M12 Plug PRO 2 x 2**

M12 plug connector for connection of Industrial Ethernet FC installation cables; 4-pole, D-coded, metal enclosure, IP65 degree of protection, pin insert; 180° cable outlet; for network components and Industrial Ethernet stations with IP65/IP67 degree of protection

- 1 pack = 1 unit
- 1 pack = 8 units

**6GK1901-0DB20-6AA0**  
**6GK1901-0DB20-6AA8**

<sup>1)</sup> Special fiber-optic cables, lengths and accessories available on request

<sup>2)</sup> Special tools and trained personnel are required for pre-assembling glass fiber-optic cables

## PROFINET/Industrial Ethernet

### Industrial Ethernet Switches

#### SCALANCE X-200 managed

Ordering data	Article No.	Article No.	
<b>IE connecting cable M12-180/M12-180</b> Pre-assembled IE FC TP trailing cable GP 2 x 2 (PROFINET type C) with two 4-pole M12 plugs, 4-pole, D-coded, IP65/IP67 degree of protection; Length: <ul style="list-style-type: none"> <li>• 0.3 m</li> <li>• 0.5 m</li> <li>• 1.0 m</li> <li>• 1.5 m</li> <li>• 2.0 m</li> <li>• 3.0 m</li> <li>• 5.0 m</li> <li>• 10 m</li> <li>• 15 m</li> </ul>	<b>6XV1870-8AE30</b> <b>6XV1870-8AE50</b> <b>6XV1870-8AH10</b> <b>6XV1870-8AH15</b> <b>6XV1870-8AH20</b> <b>6XV1870-8AH30</b> <b>6XV1870-8AH50</b> <b>6XV1870-8AN10</b> <b>6XV1870-8AN15</b>	<b>SITOP compact 24 V/0.6 A</b> 1-phase power supply with wide-range input 85 – 264 V AC/110 – 300 V DC, stabilized output voltage 24 V, rated output current value 0.6 A, slim design <b>PS791-1PRO Power Supply</b> AC/DC power supply, 10 W, IP65 (-20 to +60 °C) for SCALANCE X208PRO, input: AC 85 V – 265 V, output: 24 V DC, metal enclosure, scope of delivery: AC power 3+PE cable connector, DC power cord M12, installation materials, manuals German/English	<b>6EP1331-5BA00</b> <b>6GK5791-1PS00-0AA6</b>
<b>IE M12 Panel Feedthrough</b> Control cabinet feedthrough for transition from 4-pole, D-coded M12 interface (IP65/IP67) to RJ45 socket (IP20) <ul style="list-style-type: none"> <li>• 1 pack = 5 units</li> </ul>	<b>6GK1901-0DM20-2AA5</b>	<b>C-PLUG</b> Swap medium for simple replacement of devices in the event of a fault; for storing configuration or engineering and application data; can be used for SIMATIC NET products with C-PLUG slot	<b>6GK1900-0AB00</b>
<b>IE Power M12 Cable Connector PRO</b> Socket for connecting SCALANCE W-700/SCALANCE X208PRO for 24 V DC supply; 4-pole, A-coded, with installation instructions	<b>6GK1907-0DC10-6AA3</b>	<b>IE Connecting Cable IE FC RJ45 Plug-180/IE FC RJ45 Plug-180</b> Preassembled IE FC TP trailing cable GP 2 x 2 (PROFINET type C) with two IE FC RJ45 plug-180, IP20 degree of protection; length: <ul style="list-style-type: none"> <li>• 1.0 m</li> <li>• 2.0 m</li> <li>• 3.0 m</li> <li>• 5.0 m</li> <li>• 10.0 m</li> <li>• 15.0 m</li> <li>• 20.0 m</li> </ul>	<b>6XV1871-5BH10</b> <b>6XV1871-5BH20</b> <b>6XV1871-5BH30</b> <b>6XV1871-5BH50</b> <b>6XV1871-5BN10</b> <b>6XV1871-5BN15</b> <b>6XV1871-5BN20</b>
<b>Signaling Contact M12 Cable Connector PRO</b> Socket for connecting SCALANCE X208PRO for signaling contact; 5-pole, B-coded, with installation instructions	<b>6GK1908-0DC10-6AA3</b>		

#### More information

##### Selection tools:

To assist in selecting the right Industrial Ethernet switches as well as configuration of modular variants, the SIMATIC NET Selection Tool and the TIA Selection Tool are available at:

SIMATIC NET Selection Tool:

- Online version:  
<http://www.siemens.com/snst>
- Offline version:  
<http://www.siemens.com/snst-download>

TIA Selection Tool:

<http://www.siemens.com/tia-selection-tool>



## Overview



The managed Industrial Ethernet switches of the SCALANCE XF-200 line are optimized for setting up Industrial Ethernet networks at data transfer rates of 10/100 Mbit/s in a line, star or ring topology.

- Integrated redundancy manager for constructing Fast Ethernet ring topologies with fast media redundancy
- Electrical or optical connection to stations or network in accordance with the port type of the devices
- Enclosure in ET 200S format (slim design) for use in small control boxes
- Rugged, industry-standard station connections with PROFINET-compatible RJ45 connectors that offer additional strain relief and bending strain relief thanks to latching on the housing
- PROFINET diagnostics, SNMP access, integrated web server and automatic e-mail transmission function for remote diagnostics and signaling via the network

### Product versions

- Switches with electrical and optical ports for glass multi-mode FOC up to 5 km:
  - **SCALANCE XF204-2;**  
4 x 10/100 Mbit/s RJ45 port, electrical  
2 x 100 Mbit/s BFOC port, optical
  - **SCALANCE XF206-1;**  
6 x 10/100 Mbit/s RJ45 port, electrical  
1 x 100 Mbit/s BFOC port, optical
- Switches with electrical ports:
  - **SCALANCE XF204;**  
4 x 10/100 Mbit/s RJ45 port, electrical
  - **SCALANCE XF208;**  
8 x 10/100 Mbit/s RJ45 port, electrical

## Benefits

get

Designed for Industry

- Saves space in the control cabinet and uses smaller control boxes due to slim design in the format of the ET 200S distributed I/O
- Simple connection and disconnection of the RJ45 plug by means of easily accessible RJ45 sockets angled downward on the device
- High availability of the network thanks to:
  - Redundant power supply
  - Redundant network structures based on fiber-optic or twisted pair cables (redundancy manager integrated)
  - Easy device replacement by means of plug-in C-PLUG swap medium
- Lower susceptibility to failure and higher availability of the plant networking due to latching of the RJ45 FastConnect connectors in the sleeve of the RJ45 ports
- Protection of investment due to integration into existing network management systems by means of standardized SNMP access
- Time savings during engineering, commissioning and in the operating phase of a plant by using the configuration and diagnostics integrated in STEP 7

## PROFINET/Industrial Ethernet

### Industrial Ethernet Switches

#### SCALANCE XF-200 managed

#### Application

The SCALANCE XF-200 Industrial Ethernet switches permit cost-effective configuration of Industrial Ethernet line, star or ring topologies with switching functionality for networks in which high availability or remote diagnostics options are required. The devices with degree of protection IP20 are designed for operation in the control cabinet.

#### Features:

- Device diagnostics with LEDs (power, link status, data communication)
- Remote diagnostics by means of signaling contact, PROFINET, SNMP, and Web browser
- The RJ45 sockets are designed to be industry-compatible with additional sleeves, for connection of the IE FC RJ45 Plug 180

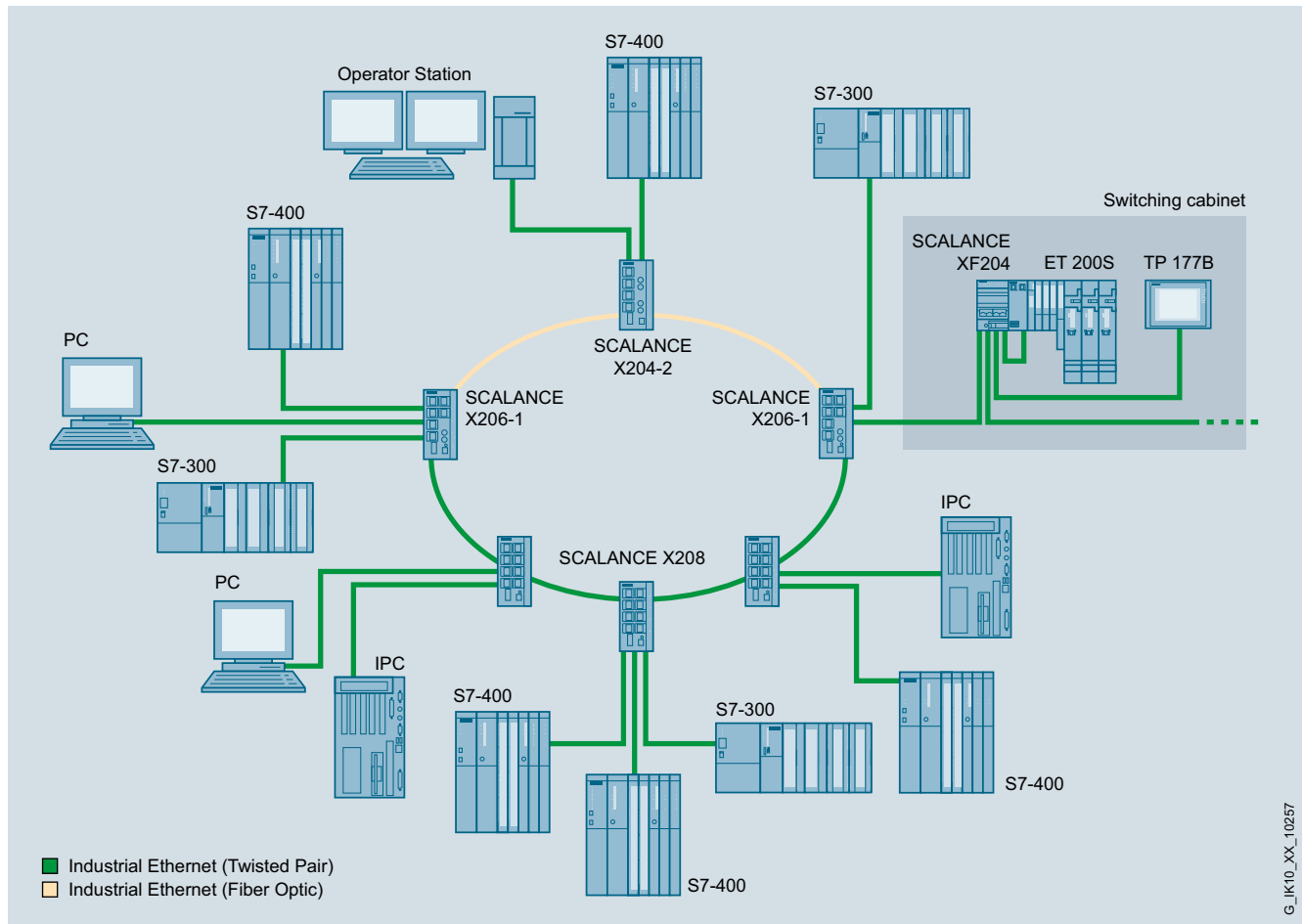

Ring topology with SCALANCE X-200 and XF-200

G\_IK10\_XX\_10257

## Design

The SCALANCE XF-200 managed Industrial Ethernet switches are designed for installation on a standard DIN rail. With their enclosure in ET 200S format (slim design), the devices are optimally suited for integration in automation solutions in small control boxes together with the ET200S.

The switches with IP20 degree of protection feature:

- A 4-pole terminal block for connecting the redundant supply voltage (2 x 24 V DC)
- A row of LEDs to indicate the status information (power, link status, data traffic, power supply, signaling contact)
- A 2-pole terminal block for connecting the isolated signaling contact
- A SET button for on-site configuration of the signaling contact

The SCALANCE XF-200 switches are available with the following port types:

- **10/100BaseTX, RJ45 connection;**  
RJ45 socket, automatic detection of the data rate (10 or 100 Mbit/s), with Autosensing and Autocrossover functions for connecting IE FC cables using the IE FC RJ45 Plug 180.
- **100BaseFX, BFOC connection technique;**  
BFOC sockets for direct connection to Industrial Ethernet glass fiber-optic cables up to 5 km (multimode fiber-optic cable) for configuring line, ring, and star topologies.

## Function

- Setup of electrical and optical Industrial Ethernet line, star and ring topologies
- Fast redundancy in the ring with High Speed Redundancy (HSR); up to 0.3 seconds for reconfiguration of the ring with 50 switches in the ring
- Fast redundancy in the ring with PROFINET-compliant Media Redundancy Protocol (MRP); max. 0.2 seconds required for reconfiguration of the ring with 50 switches in the ring
- The functioning of the ring is continuously monitored by the integrated redundancy manager. It recognizes failure of a transmission path in the ring or failure of a SCALANCE XF-200 and activates the substitute path within 0.3 or 0.2 seconds
- Use in ring topologies (100 Mbit/s) together with SCALANCE X-400, SCALANCE X-300, SCALANCE X-200, SCALANCE X-200IRT
- Uncrossed connecting cables can be used due to Autocrossover function integrated in the ports
- Load disconnection through integral switch functionality
- Easy diagnostics using signaling contact, SNMP and Web browser
- Easy copper cable diagnostics with Web browser for localizing cable breaks
- Integration into the diagnostics of a PROFINET I/O controller with expanded diagnostics functions for a consistent diagnostics concept, including network infrastructure
- Diagnosis of data traffic by means of a parameterizable mirror port with a standard commercial network analyzer
- Fast device replacement in the event of a fault by using the optional C-PLUG swap medium (not included in scope of supply)

## Network topology and network configuration

The SCALANCE XF-200 Industrial Ethernet switches with IP20 degree of protection are usually installed in a control cabinet together with the stations to be connected. Electrical and optical versions can be installed together in star, line and ring topologies.

When configuring the network, it is necessary to observe the following boundary conditions:

- Length of the TP cable between two SCALANCE XF switches:
  - Max. 100 m with IE FC cable and IE FC RJ45 Plug 180
  - Max. 10 m using patches with TP cord
- Length of the optical cables
  - Max. 5 000 m with Industrial Ethernet glass fiber-optic cables (multimode)
- IP address:  
The IP address is assigned by means of the DHCP (Dynamic Host Configuration Protocol). If there is no corresponding server in the network, the IP address can be assigned using the supplied software tool PST (Primary Setup Tool) or STEP 7. The SCALANCE XF-200 switches are configured with STEP 7.

## Commissioning and diagnostics

PROFINET diagnostic interrupts from SCALANCE XF-200 switches can be displayed with the appropriate SIMATIC Engineering Tools and processed in the controller with expanded diagnostics function. The engineering outlay for the PLC and HMI have been drastically reduced due to the complete integration in the SIMATIC concept for system error messages.

The SCALANCE XF-200 Industrial Ethernet switches can also be integrated into a network management system through the standardized protocol SNMP (Simple Network Management Protocol). In the event of a fault in the device, error messages (SNMP traps) can be sent to a network system or as e-mail to a specified network administrator.

The integral Web server enables configuration and diagnostics settings to be made using a standard browser (e.g. port configuration). Statistical information can also be read out over the Web server (e.g. port capacity utilization).

The following information is displayed on site by LEDs:

- Power
- Port status
- Data traffic
- Signaling contact
- Redundancy manager function

The Industrial Ethernet switches of the SCALANCE XF-200 line can also be monitored using the floating signaling contact.

# PROFINET/Industrial Ethernet

## Industrial Ethernet Switches

### SCALANCE XF-200 managed

#### Technical specifications

Article No.	6GK5204-0BA00-2AF2	6GK5204-2BC00-2AF2	6GK5206-1BC00-2AF2	6GK5208-0BA00-2AF2
Product-type designation	SCALANCE XF204	SCALANCE XF204-2	SCALANCE XF206-1	SCALANCE XF208
<b>Transmission rate</b>				
Transfer rate 1	10 Mbit/s	10 Mbit/s	10 Mbit/s	10 Mbit/s
Transfer rate 2	100 Mbit/s	100 Mbit/s	100 Mbit/s	100 Mbit/s
<b>Interfaces</b>				
Number of electrical/optical connections				
• for network components or terminal equipment maximum	4	6	7	8
Number of electrical connections				
• for network components and terminal equipment	4	4	6	8
• for signaling contact	1	1	1	1
• for power supply	1	1	1	1
• for redundant power supply	1	1	1	1
Design of electrical connection				
• for network components and terminal equipment	RJ45 port	RJ45 port	RJ45 port	RJ45 port
• for signaling contact	2-pole terminal block	2-pole terminal block	2-pole terminal block	2-pole terminal block
• for power supply	4-pole terminal block	4-pole terminal block	4-pole terminal block	4-pole terminal block
Number of optical interfaces for optical waveguide at 100 Mbit/s	-	2	1	-
Design of optical interface for optical waveguide at 100 Mbit/s	-	BFOC sockets (multimode up to 5 km)	BFOC sockets (multimode up to 5 km)	-
Connectable optical power relative to 1 mW				
• of the transmitter output	-	-19 ... -14 dB	-19 ... -14 dB	-
Optical sensitivity relative to 1 mW of the receiver input minimum	-	-34 dB	-	-
Attenuation of fiber-optic cable transmission link minimum necessary	-	0 dB	0 dB	-
Range at the optical interface depending on the optical fiber used	-	0 ... 5 km	0 ... 5 km	-
Design of the removable storage C-PLUG	Yes	Yes	Yes	Yes
<b>Signal-Inputs/outputs</b>				
Operating voltage of signaling contacts at DC rated value	24 V	24 V	24 V	24 V
Operating current of signaling contacts at DC maximum	0.1 A	0.1 A	0.1 A	0.1 A
<b>Supply voltage, current consumption, power loss</b>				
Type of supply voltage	DC	DC	DC	DC
Supply voltage external	24 V	24 V	24 V	24 V
• minimum	18 V	18 V	18 V	18 V
• maximum	32 V	32 V	32 V	32 V
Product component fusing at power supply input	Yes	Yes	Yes	Yes
Type of fusing at input for supply voltage	1.1 A / 33 V	1.1 A / 33 V	1.1 A / 33 V	1.1 A / 33 V
Consumed current maximum	0.11 A	0.22 A	0.17 A	0.13 A
Active power loss at 24 V for DC	2.64 W	5.28 W	4.08 W	3.12 W

**Technical specifications (continued)**

Article No.	6GK5204-0BA00-2AF2	6GK5204-2BC00-2AF2	6GK5206-1BC00-2AF2	6GK5208-0BA00-2AF2
Product-type designation	SCALANCE XF204	SCALANCE XF204-2	SCALANCE XF206-1	SCALANCE XF208
<b>Permitted ambient conditions</b>				
Ambient temperature				
• during operating	-40 ... +60 °C	-40 ... +60 °C	-40 ... +60 °C	-40 ... +60 °C
• during storage	-40 ... +70 °C	-40 ... +70 °C	-40 ... +70 °C	-40 ... +70 °C
• during transport	-40 ... +70 °C	-40 ... +70 °C	-40 ... +70 °C	-40 ... +70 °C
• Comment	If the IE switch XF 200 is installed horizontally a maximum ambient temperature of +40 °C is permitted	If the IE switch XF 200 is installed horizontally a maximum ambient temperature of +40 °C is permitted	If the IE switch XF 200 is installed horizontally a maximum ambient temperature of +40 °C is permitted	If the IE switch XF 200 is installed horizontally a maximum ambient temperature of +40 °C is permitted
Relative humidity at 25 °C without condensation during operating maximum	95 %	95 %	95 %	95 %
Protection class IP	IP20	IP20	IP20	IP20
<b>Design, dimensions and weight</b>				
Design	Flat	Flat	Flat	Flat
Width	75 mm	75 mm	75 mm	75 mm
Height	125 mm	125 mm	125 mm	125 mm
Depth	73 mm	73 mm	73 mm	73 mm
Net weight	250 g	250 g	250 g	250 g
Mounting type				
• 35 mm DIN rail mounting	Yes	Yes	Yes	Yes
• wall mounting	No	No	No	No
• S7-300 rail mounting	No	No	No	No
<b>Product properties, functions, components general</b>				
Cascading in the case of a redundant ring at reconfiguration time of < 0.3 s	50	50	50	50
Cascading in cases of star structuring	Any (depending only on signal propagation time)	Any (depending only on signal propagation time)	Any (depending only on signal propagation time)	Any (depending only on signal propagation time)
<b>Product functions management, configuration</b>				
Product function				
• CLI	Yes	Yes	Yes	Yes
• web-based management	Yes	Yes	Yes	Yes
• MIB support	Yes	Yes	Yes	Yes
• TRAPs via email	Yes	Yes	Yes	Yes
• Configuration with STEP 7	Yes	Yes	Yes	Yes
• SMTP server	-	-	-	-
• Port mirroring	Yes	Yes	Yes	Yes
• for IRT PROFINET IO switch	No	No	No	No
• PROFINET IO diagnosis	Yes	Yes	Yes	Yes
• switch-managed	Yes	Yes	Yes	Yes
Protocol is supported				
• Telnet	Yes	Yes	Yes	Yes
• HTTP	Yes	Yes	Yes	Yes
• HTTPS	Yes	Yes	Yes	Yes
• TFTP	Yes	Yes	Yes	Yes
• FTP	Yes	Yes	Yes	Yes
• BOOTP	No	No	No	No
• SNMP v1	Yes	Yes	Yes	Yes
• SNMP v2	Yes	Yes	Yes	Yes
• SNMP v3	Yes	Yes	Yes	Yes
• DCP	Yes	Yes	Yes	Yes
• LLDP	Yes	Yes	Yes	Yes
Identification & maintenance function				
• I&M0 - device-specific information	Yes	Yes	Yes	Yes
• I&M1 - higher level designation/location designation	Yes	Yes	Yes	Yes

# PROFINET/Industrial Ethernet

## Industrial Ethernet Switches

### SCALANCE XF-200 managed

#### Technical specifications (continued)

Article No.	6GK5204-0BA00-2AF2	6GK5204-2BC00-2AF2	6GK5206-1BC00-2AF2	6GK5208-0BA00-2AF2
Product-type designation	SCALANCE XF204	SCALANCE XF204-2	SCALANCE XF206-1	SCALANCE XF208
<b>Product functions Diagnosis</b>				
Product function				
• Port diagnostics	Yes	Yes	Yes	Yes
• Statistics packet size	Yes	Yes	Yes	Yes
• Statistics packet type	Yes	Yes	Yes	Yes
• Error statistics	Yes	Yes	Yes	Yes
<b>Product functions DHCP</b>				
Product function DHCP client	Yes	Yes	Yes	Yes
<b>Product functions Redundancy</b>				
Product function				
• Ring redundancy	Yes	Yes	Yes	Yes
• Redundancy manager	Yes	Yes	Yes	Yes
• Standby redundancy	No	No	No	No
• High Speed Redundancy Protocol (HRP)	Yes	Yes	Yes	Yes
• Media Redundancy Protocol (MRP)	Yes	Yes	Yes	Yes
• Parallel Redundancy Protocol (PRP)	No	No	No	No
• Passive listening	Yes	Yes	Yes	Yes
Protocol is supported PRP	Yes	Yes	Yes	Yes
<b>Product functions Security</b>				
Protocol is supported SSH	Yes	Yes	Yes	Yes
<b>Product functions Time</b>				
Product function SICLOCK support	Yes	Yes	Yes	Yes
Protocol is supported				
• NTP	No	No	No	No
• SNTP	Yes	Yes	Yes	Yes
<b>Standards, specifications, approvals</b>				
Standard				
• for EMC from FM	FM3611: Class 1, Division 2, Group A, B, C, D / T4, CL.1, Zone 2, GP. IIC, T4	FM3611: Class 1, Division 2, Group A, B, C, D / T4, CL.1, Zone 2, GP. IIC, T4	FM3611: Class 1, Division 2, Group A, B, C, D / T4, CL.1, Zone 2, GP. IIC, T4	FM3611: Class 1, Division 2, Group A, B, C, D / T4, CL.1, Zone 2, GP. IIC, T4
• for hazardous zone	EN 60079-0: 2006, EN 60079-15: 2005, II 3 G Ex nA II T4, KEMA 07 ATEX 0145 X	EN 60079-0: 2006, EN 60079-15: 2005, II 3 (2) G Ex nA [op is] IIC T4, KEMA 07 ATEX 0145 X	EN 60079-0: 2006, EN 60079-15: 2005, II 3 (2) G Ex nA [op is] IIC T4, KEMA 07 ATEX 0145 X	EN 60079-0: 2006, EN 60079-15: 2005, II 3 G Ex nA II T4, KEMA 07 ATEX 0145 X
• for safety of CSA and UL	UL 60950-1, CSA C22.2 No. 60950-1	UL 60950-1, CSA C22.2 No. 60950-1	UL 60950-1, CSA C22.2 No. 60950-1	UL 60950-1, CSA C22.2 No. 60950-1
• for hazardous area of CSA and UL	ANSI / ISA 12.12.01, CSA C22.2 No. 213-M1987, CL. 1 / Div. 2 / GP. A, B, C, D T4, CL. 1 / Zone 2 / GP. IIC, T4	ANSI / ISA 12.12.01, CSA C22.2 No. 213-M1987, CL. 1 / Div. 2 / GP. A, B, C, D T4, CL. 1 / Zone 2 / GP. IIC, T4	ANSI / ISA 12.12.01, CSA C22.2 No. 213-M1987, CL. 1 / Div. 2 / GP. A, B, C, D T4, CL. 1 / Zone 2 / GP. IIC, T4	ANSI / ISA 12.12.01, CSA C22.2 No. 213-M1987, CL. 1 / Div. 2 / GP. A, B, C, D T4, CL. 1 / Zone 2 / GP. IIC, T4
• for emitted interference	EN 61000-6-4:2001 (Class A)	EN 61000-6-4:2001 (Class A)	EN 61000-6-4:2001 (Class A)	EN 61000-6-4:2001 (Class A)
• for interference immunity	EN 61000-6-2:2001	EN 61000-6-2:2001	EN 61000-6-2:2001	EN 61000-6-2:2001
Verification of suitability	EN 61000-6-4:2001	EN 61000-6-2:2001, EN 61000-6-4:2001	EN 61000-6-2:2001, EN 61000-6-4:2001	EN 61000-6-2:2001, EN 61000-6-4:2001
• CE mark	Yes	Yes	Yes	Yes
• C-Tick	Yes	Yes	Yes	Yes
• KC approval	Yes	Yes	Yes	Yes
• Railway application in accordance with EN 50155	No	No	No	No
• Railway application in accordance with EN 50124-1	No	No	No	No
Marine classification association				
• American Bureau of Shipping Europe Ltd. (ABS)	No	No	No	No
• Bureau Veritas (BV)	Yes	No	No	No
• Det Norske Veritas (DNV)	No	No	No	No
• Germanische Lloyd (GL)	No	No	No	No
• Lloyds Register of Shipping (LRS)	No	No	No	No
• Nippon Kaiji Kyokai (NK)	No	No	No	No
• Polski Rejestr Statkow (PRS)	No	No	No	No

Ordering data	Article No.	Article No.	
<b>SCALANCE XF-200 Industrial Ethernet switches</b> Industrial Ethernet switches with integrated SNMP access, online diagnostics, copper cable diagnostics and PROFINET diagnostics for configuring line, star and ring topologies; with integrated redundancy manager; incl. operating instructions, Industrial Ethernet network manual and configuration software on CD-ROM			
<ul style="list-style-type: none"> <li> <b>SCALANCE XF204-2</b>                4 x 10/100 Mbit/s RJ45 ports, electrical;                2 x 100 Mbit/s BFOC ports, optical (multimode, glass), up to 5 km             </li> </ul>	<b>6GK5204-2BC00-2AF2</b>	<b>IE FC RJ45 Plug 180 2 x 2</b> RJ45 plug-in connector for Industrial Ethernet with a rugged metal enclosure and integrated insulation displacement contacts for connecting Industrial Ethernet FC installation cables; with 180° cable outlet; for network components and CPs/CPU's with Industrial Ethernet interface <ul style="list-style-type: none"> <li>• 1 pack = 1 unit</li> <li>• 1 pack = 10 units</li> <li>• 1 pack = 50 units</li> </ul>	<b>6GK1901-1BB10-2AA0</b> <b>6GK1901-1BB10-2AB0</b> <b>6GK1901-1BB10-2AE0</b>
<ul style="list-style-type: none"> <li> <b>SCALANCE XF206-1</b>                6 x 10/100 Mbit/s RJ45 ports, electrical;                1 x 100 Mbit/s BFOC ports, optical (multimode, glass), up to 5 km             </li> </ul>	<b>6GK5206-1BC00-2AF2</b>	<b>FC BFOC plug</b> Screw connector for on-site assembly on FC fiber-optic cable; (1 pack = 20 units + cleaning cloths)	<b>6GK1900-1GB00-0AC0</b>
<ul style="list-style-type: none"> <li> <b>SCALANCE XF204</b>                4 x 10/100 Mbit/s RJ45 ports, electrical             </li> </ul>	<b>6GK5204-0BA00-2AF2</b>	<b>IE FC stripping tool</b> Preadjusted stripping tool for fast stripping of Industrial Ethernet FC cables	<b>6GK1901-1GA00</b>
<ul style="list-style-type: none"> <li> <b>SCALANCE XF208</b>                8 x 10/100 Mbit/s RJ45 ports, electrical             </li> </ul>	<b>6GK5208-0BA00-2AF2</b>	<b>FC FO termination kit</b> Assembly case for local assembly of FC SC and FC BFOC connectors to FC FO standard cable, comprising a stripping tool, Kevlar cutters, fiber breaking tool and microscope	<b>6GK1900-1GL00-0AA0</b>
<b>Accessories</b>			
<b>IE FC TP Standard Cable GP 2 x 2 (Type A)</b> 4-core, shielded TP installation cable for connection to IE FC RJ45 outlet / IE FC RJ45 plug; PROFINET-compliant; with UL approval; sold by the meter; max. length 1 000 m, minimum order 20 m	<b>6XV1840-2AH10</b>		
<b>FO Standard Cable GP 50/125/1400<sup>1) 2)</sup></b> Multimode cable, sold by the meter; max. length 1 000 m; minimum order 20 m;	<b>6XV1873-2A</b>		
<b>FC FO Standard Cable GP 62.5/200/230</b> FC FO standard cable for fixed routing indoors with PVC sheath; sold by the meter; max. length 1 000 m; minimum order 20 m	<b>6XV1847-2A</b>	<b>SITOP compact 24 V/ 0.6 A</b> 1-phase power supply with wide-range input 85 – 264 V AC/110 – 300 V DC, stabilized output voltage 24 V, rated output current value 0.6 A, slim design	<b>6EP1331-5BA00</b>
		<b>C-PLUG</b> Swap medium for simple replacement of devices in the event of a fault; for storing configuration or engineering and application data; can be used for SIMATIC NET products with C-PLUG slot	<b>6GK1900-0AB00</b>

<sup>1)</sup> Special fiber-optic cables, lengths and accessories available on request

<sup>2)</sup> Special tools and trained personnel are required for pre-assembling glass fiber-optic cables

## More information

### Selection tool:

To assist in selecting the right Industrial Ethernet switches as well as configuration of modular variants, the SIMATIC NET Selection Tool and the TIA Selection Tool are available at:

SIMATIC NET Selection Tool:

- Online version:  
<http://www.siemens.com/snst>
- Offline version:  
<http://www.siemens.com/snst-download>

TIA Selection Tool:

<http://www.siemens.com/tia-selection-tool>

## PROFINET/Industrial Ethernet

### Industrial Ethernet Switches

#### SCALANCE X204RNA PRP

#### Overview



The SCALANCE X-200RNA (**R**edundant **N**etwork **A**ccess) managed Industrial Ethernet network access points with PRP functionality (**P**arallel **R**edundancy **P**rotocol in accordance with IEC 62439-3) are used to connect up to two non-PRP-enabled terminal devices or network segments to parallel networks.

- Electrical or optical connection to stations or network in accordance with the port type of the devices
- Media redundancy thanks to duplicate transmission of frames in two parallel, separate networks
- High system availability since frames are sent simultaneously over two separate networks
- Reconfiguration times in a subnetwork do not affect the propagation time because the frames are transmitted via two separate networks (bumpless redundancy)
- Redundant 24 V DC voltage infeed or wide-range power supply unit, depending on device version
- SNMP access, integrated Web server and automatic e-mail transmission function for remote diagnostics and signaling via the network

#### Product versions

- Network access point in plastic enclosure with electrical ports
  - **SCALANCE X204RNA for PRP networks;** for connecting up to two non-PRP-enabled terminal devices to redundant networks with four electrical ports
- Network access point in metal enclosure with electrical and optical ports, as well as a wide-range power supply unit for use under extended ambient conditions
  - **SCALANCE X204RNA EEC for PRP networks;** for connecting up to two non-PRP-enabled terminal devices to redundant networks with two electrical terminal device ports and two optical/electrical combo ports for network connection
  - **SCALANCE X204RNA EEC for PRP or HSR networks;** for connecting up to two non-PRP-enabled or non-HSR-enabled terminal devices to redundant networks with two electrical terminal device ports and two optical/electrical combo ports for network connection. PRP or HSR function can be defined by the user when starting the device (for description of HSR function, see Section on X204RNA with HSR function).

#### Benefits

get **Designed for Industry**

- Ideal solution for establishing Industrial Ethernet networks with high network availability (bumpless media redundancy through parallel data transfer in parallel network topologies)
- The reconfiguration time of a subnetwork does not influence frame transmission
- Fast and easy diagnosis with LEDs on the device, through the integral Web server and through signaling contacts
- Integration of the SCALANCE X-200RNA network access points into the existing network management infrastructure through SNMP access
- Simple commissioning without mandatory configuring
- Module replacement without the need for a programming device, using the C-PLUG swap media for backing up the configuration data

#### Application

The SCALANCE X-200RNA Industrial Ethernet network access points enable low-cost connection of non-PRP-enabled terminal equipment to parallel, separate networks in which high availability is demanded. The devices with degree of protection IP20 are designed for operation in the control cabinet.

#### Features:

- Device diagnostics with LEDs (power, link status, data communication)
- Remote diagnostics possible via signaling contact (signal screen can be set locally using buttons), SNMP, and Web browser
- With its extended ambient conditions, the SCALANCE X204RNA EEC is suitable for use in power switching and distribution systems (IEC 61850-3, IEEE 1613) in tough industrial environments



### Design

The SCALANCE X204RNA and X204RNA EEC network access points with rugged plastic or metal enclosure have been optimized for installation on a standard mounting rail and for direct wall mounting in different mounting positions.

The network access points with IP20 degree of protection feature:

- A 4-pole terminal block for connecting the redundant supply voltage (2 x 24 V DC), or a 3-pole terminal block in the case of the wide-range power supply unit
- A row of LEDs to indicate the status information (power, link status, data exchange, power supply, signaling contact)
- A 2-pole or 3-pole terminal block for connecting the floating signaling contact in the corresponding voltage range
- A SET button for on-site configuration of the signaling contact

The SCALANCE X200RNA devices are available with the following port types:

- **100BaseTX, RJ45 connection;**  
RJ45 port with a data rate of 100 Mbit/s, with autosensing and autocrossover function for the connection of IE FC cables via IE FC RJ45 Plug 180 up to 100 m
- **100BaseTX, combo port (RJ45, SFP slot);**  
100 Mbit/s combo ports for direct connection to Industrial Ethernet copper cables or glass fiber-optic cables (multimode/singlemode fiber-optic cable); if the RJ45 interface of the combo port is used, the SFP slot is deactivated, and vice versa.

### Function

- Connection of non-PRP-enabled terminal equipment to parallel, separate networks
- Parallel data transfer over two parallel, separate networks
- Uncrossed connecting cables can be used due to Autocrossover function integrated in the ports
- Easy diagnostics using signaling contact, SNMP and Web browser
- Fast device replacement in the event of a fault by using the optional C-PLUG swap medium (not included in scope of supply)

### Network topology and network configuration

The SCALANCE X-200RNA switches with IP30 degree of protection are usually installed in a control cabinet together with the stations to be connected. They can be mixed electrically and optically in star and line topologies.

When configuring the network, it is necessary to observe the following boundary conditions:

- Length of the TP cable between the network and SCALANCE X-200RNA:
  - Max. 100 m with IE FC cable and IE FC RJ45 Plug 180
  - Max. 10 m using patches with TP cord
- Length of the optical cables between the network and SCALANCE X-200RNA
  - Max. 5 000 m with Industrial Ethernet glass fiber-optic cables (multimode)
  - Max. 26 000 m with Industrial Ethernet glass fiber-optic cables (singlemode)
- IP address:  
The IP address is assigned by means of the DHCP (Dynamic Host Configuration Protocol). If there is no corresponding server in the network, the IP address can be assigned using the supplied software tool PST (Primary Setup Tool).

### Commissioning and diagnosis

The SCALANCE X-200RNA Industrial Ethernet network access points can be integrated into a network management system via the standardized protocol SNMP (**S**imple **N**etwork **M**anagement **P**rotocol). In the event of a fault in the device, error messages (SNMP traps) can be sent to a network system or as e-mail to a specified network administrator.

The integral Web server enables configuration and diagnostics settings to be made using a standard browser (e.g. port configuration). Statistical information can also be read out over the Web server (e.g. port capacity utilization).

The following information is displayed on site by LEDs:

- Power
- Port status
- Data traffic
- Signaling contact
- PRP activity

The SCALANCE X-200RNA Industrial Ethernet network access points can also be monitored using the floating signaling contact.

### Integration

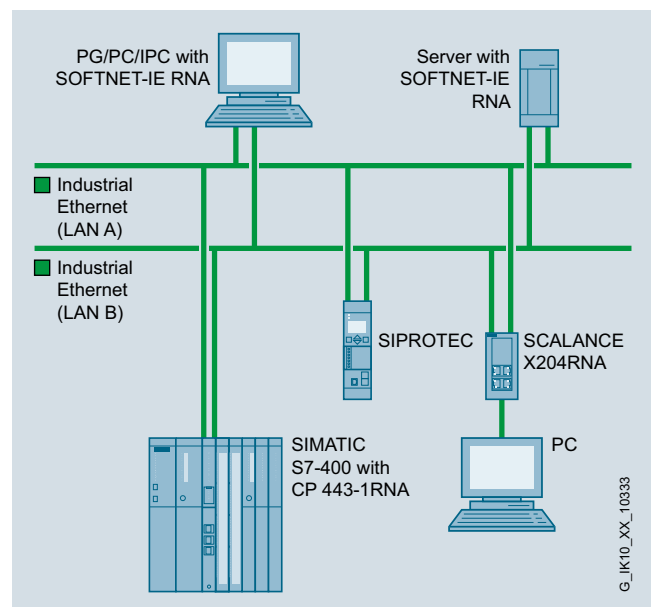

## PROFINET/Industrial Ethernet

### Industrial Ethernet Switches

#### SCALANCE X204RNA PRP

#### Technical specifications

Article No.	6GK5204-0BA00-2KB2	6GK5204-0BS00-3LA3	6GK5204-0BS00-3PA3
Product-type designation	SCALANCE X204RNA	SCALANCE X204RNA EEC	SCALANCE X204RNA EEC
<b>Transmission rate</b>			
Transfer rate 2	100 Mbit/s	100 Mbit/s	100 Mbit/s
<b>Interfaces</b>			
Number of electrical/optical connections			
• for network components or terminal equipment maximum	4	4	4
• as combo port for network components or terminal equipment	-	2	2
Number of electrical connections			
• for network components and terminal equipment	4	2	2
• for signaling contact	1	1	1
• for power supply	1	1	1
• for redundant power supply	2	1	1
Design of electrical/optical connections for network components or terminal equipment	-	SFP	SFP
Design of electrical connection			
• for network components and terminal equipment	RJ45 port	RJ45 port	RJ45 port
• for signaling contact	2-pole terminal block	3-pole terminal block	
• for power supply	4-pole terminal block	3-pole terminal block	3-pole terminal block
Number of optical interfaces for optical waveguide at 100 Mbit/s	-	2	2
Design of optical interface for optical waveguide at 100 Mbit/s	-	SFF port	SFF port
Design of the removable storage C-PLUG	Yes	Yes	Yes
<b>Signal-Inputs/outputs</b>			
Operating current of signaling contacts at AC maximum	-	0.1 A	0.1 A
Operating voltage of signaling contacts at DC rated value	24 V	24 V	24 V
Operating current of signaling contacts at DC maximum	0.1 A	0.1 A	0.1 A
<b>Supply voltage, current consumption, power loss</b>			
Type of supply voltage	DC	-	-
Supply voltage external	24 V	-	-
Supply voltage external			
• minimum	19.2 V	-	-
• maximum	28.8 V	-	-
Product component fusing at power supply input	Yes	Yes	Yes
Type of fusing at input for supply voltage			
Consumed current maximum	0.15 A	0.25 A	0.25 A
Active power loss at 24 V for DC	3.5 W	6 W	6 W

**Technical specifications (continued)**

Article No.	6GK5204-0BA00-2KB2	6GK5204-0BS00-3LA3	6GK5204-0BS00-3PA3
Product-type designation	SCALANCE X204RNA	SCALANCE X204RNA EEC	SCALANCE X204RNA EEC
<b>Permitted ambient conditions</b>			
Ambient temperature			
• during operating	-40 ... +60 °C	-40 ... +70 °C	-40 ... +70 °C
• during storage	-40 ... +70 °C	-40 ... +70 °C	-40 ... +70 °C
• during transport	-40 ... +70 °C	-40 ... +70 °C	-40 ... +70 °C
• Comment	-	A maximum operating temperature of +85 °C is permissible for a duration of 16 hours	A maximum operating temperature of +85 °C is permissible for a duration of 16 hours
Relative humidity at 25 °C without condensation during operating maximum	95 %	95 %	95 %
Ambient condition for (standard) operation mode	-	-	-
Protection class IP	IP20	IP20	IP20
<b>Design, dimensions and weight</b>			
Design	compact	compact	compact
Width	45 mm	70 mm	70 mm
Height	100 mm	147 mm	147 mm
Depth	87 mm	123 mm	123 mm
Net weight	0.23 kg	0.78 kg	0.78 kg
Mounting type			
• 35 mm DIN rail mounting	Yes	Yes	Yes
• wall mounting	Yes	No	No
• S7-300 rail mounting	No	No	No
Mounting type	-	-	-
<b>Product properties, functions, components general</b>			
Cascading in the case of a redundant ring at reconfiguration time of < 0.3 s	-	-	-
Cascading in cases of star structuring	-	-	-
<b>Product functions management, configuration</b>			
Product function			
• CLI	Yes	Yes	Yes
• web-based management	Yes	Yes	Yes
• MIB support	Yes	Yes	Yes
• TRAPs via email	Yes	Yes	Yes
• Configuration with STEP 7	No	No	No
• Port mirroring	No	No	No
• for IRT PROFINET IO switch	No	No	No
• PROFINET IO diagnosis	No	No	No
• switch-managed	No	No	No
Protocol is supported			
• Telnet	No	No	No
• HTTP	Yes	Yes	Yes
• HTTPS	Yes	Yes	Yes
• TFTP	No	No	No
• FTP	No	No	No
• BOOTP	No	No	No
• SNMP v1	Yes	Yes	Yes
• SNMP v2	Yes	Yes	Yes
• SNMP v3	Yes	Yes	Yes
• DCP	No	No	No
• LLDP	No	No	No
Identification & maintenance function			
• I&M0 - device-specific information	Yes	Yes	Yes
• I&M1 - higher level designation/location designation	Yes	Yes	Yes

# PROFINET/Industrial Ethernet

## Industrial Ethernet Switches

### SCALANCE X204RNA PRP

#### Technical specifications (continued)

Article No.	6GK5204-0BA00-2KB2	6GK5204-0BS00-3LA3	6GK5204-0BS00-3PA3
Product-type designation	SCALANCE X204RNA	SCALANCE X204RNA EEC	SCALANCE X204RNA EEC
<b>Product functions Diagnosis</b>			
Product function			
• Port diagnostics	Yes	Yes	Yes
• Statistics packet size	Yes	Yes	Yes
• Statistics packet type	Yes	Yes	Yes
• Error statistics	Yes	Yes	Yes
<b>Product functions DHCP</b>			
Product function DHCP client	-	-	-
<b>Product functions Redundancy</b>			
Product function			
• Ring redundancy	No	No	No
• Redundancy manager	No	No	No
• Standby redundancy	No	No	No
• High Speed Redundancy Protocol (HRP)	No	No	No
• Media Redundancy Protocol (MRP)	No	No	No
• Parallel Redundancy Protocol (PRP)	Yes	Yes	Yes
• High availability Seamless Redundancy (HSR)	No	No	Yes
• Passive listening	No	No	No
Protocol is supported PRP	Yes	Yes	Yes
<b>Product functions Security</b>			
Protocol is supported SSH	Yes	Yes	Yes
<b>Product functions Time</b>			
Product function			
• SICLOCK support	No	No	No
Protocol is supported			
• NTP	No	No	No
• SNTP	Yes	Yes	Yes
<b>Standards, specifications, approvals</b>			
Standard			
• for EMC	-	IEC 61850, IEEE 1613	IEC 61850, IEEE 1613
- from FM	FM3611: Class 1, Division 2, Group A, B, C, D / T4, CL.1, Zone 2, GP. IIC, T4	FM3611: Class 1, Division 2, Group A, B, C, D / T4, CL.1, Zone 2, GP. IIC, T4	FM3611: Class 1, Division 2, Group A, B, C, D / T4, CL.1, Zone 2, GP. IIC, T4
• for hazardous zone	EN 60079-0: 2006, EN 60079-15: 2005, II 3 G Ex nA II T4, KEMA 07 ATEX 0145 X	EN 60079-0: 2006, EN 60079-15: 2005, II 3 G Ex nA II T4, KEMA 07 ATEX 0145 X	EN 60079-0: 2006, EN 60079-15: 2005, II 3 G Ex nA II T4, KEMA 07 ATEX 0145 X
• for safety of CSA and UL	UL 60950-1, CSA C22.2 No. 60950-1	UL 508, CSA C22.2 No. 142-M1987	UL 508, CSA C22.2 No. 142-M1987
• for hazardous area of CSA and UL			
• for emitted interference	EN 61000-6-4:2001 (Class A)	EN 61000-6-4:2001 (Class A)	EN 61000-6-4:2001 (Class A)
• for interference immunity	EN 61000-6-4:2001	EN 61000-6-4:2001	EN 61000-6-4:2001
Verification of suitability	EN 61000-6-4:2001	EN 61000-6-4:2001	EN 61000-6-4:2001
• CE mark	Yes	Yes	Yes
• C-Tick	Yes	Yes	Yes
• KC approval	Yes	Yes	Yes
• Railway application in accordance with EN 50155	No	No	No
• Railway application in accordance with EN 50124-1	No	No	No
• IEC 61850-3	No	Yes	Yes
Certificate of suitability IEEE 1613	-	Yes	Yes
Marine classification association			
• American Bureau of Shipping Europe Ltd. (ABS)	No	No	No
• Bureau Veritas (BV)	No	No	No
• Det Norske Veritas (DNV)	No	No	No
• Germanische Lloyd (GL)	No	No	No
• Lloyds Register of Shipping (LRS)	No	No	No
• Nippon Kaiji Kyokai (NK)	No	No	No
• Polski Rejestr Statkow (PRS)	No	No	No

**Ordering data****Article No.****Article No.****SCALANCE X-200RNA Industrial Ethernet network access points**

Industrial Ethernet network access points with integrated SNMP access, web diagnostics and PROFINET diagnostics, for connecting non-PRP-enabled terminal equipment to PRP networks; incl. operating instructions, Industrial Ethernet network manual and configuration software on CD-ROM; with electrical and optical ports for glass multimode fiber optic cables up to 5 km

- **SCALANCE X204RNA** with four 100 Mbit/s RJ45 ports
- **SCALANCE X204RNA EEC** with two 100 Mbit/s RJ45 ports and two RJ45/SFP combo ports
- **SCALANCE X204RNA EEC** with two 100 Mbit/s RJ45 ports and two RJ45/SFP combo ports with PRP or HSR support

**6GK5204-0BA00-2KB2****6GK5204-0BS00-3LA3****6GK5204-0BS00-3PA3****SIMATIC NET communications processor CP 443-1 RNA****6GK7443-1RX00-0XE0**

S7 integration into bumpless, redundant network structures on the basis of the Parallel Redundancy Protocol (PRP)

**SOFTNET-IE RNA**

Software for connecting PCs to PRP-enabled networks with integrated SNMP, runtime software, software and electronic manual on CD-ROM, license key on USB flash drive, Class A

**SOFTNET-IE RNA V12**

for 32/64-bit Windows 7 Professional/Ultimate; for Windows 2008 Server R2; for 32/64-bit Windows 8 Professional/Enterprise; for Windows Server 2012 German/English

- Single License for one installation

**6GK1711-1EW12-0AA0****SOFTNET-IE RNA V8.1**

for 32-bit Windows XP; German/English

- Single License for one installation

**6GK1711-1EW08-1AA0****Software Update Service****6GK1711-1EW00-3AL0**

for 1 year with automatic extension; requirement: Current software version

**Accessories****IE FC TP Standard Cable GP 2 x 2 (Type A)****6XV1840-2AH10**

4-wire, shielded TP installation cable for connecting to IE FC RJ45 outlet/IE FC RJ45 plug; PROFINET-compliant; with UL approval; sold by the meter; max. length 1 000 m, minimum order 20 m

**IE FC RJ45 Plug 180 2 x 2**

RJ45 plug-in connector for Industrial Ethernet with a rugged metal enclosure and integrated insulation displacement contacts for connecting Industrial Ethernet FC installation cables; with 180° cable outlet; for network components and CPs/CPU with Industrial Ethernet interfaces

- 1 pack = 1 unit
- 1 pack = 10 units
- 1 pack = 50 units

**6GK1901-1BB10-2AA0****6GK1901-1BB10-2AB0****6GK1901-1BB10-2AE0****SFP plug-in transceiver**

- SFP991-1 (multimode, glass, up to 3 km)
- SFP991-1LH+ (singlemode, glass, up to 70 km, LH+)
- SFP991-1LD (singlemode, glass, up to 26 km)

**6GK5991-1AD00-8AA0****6GK5991-1AE00-8AA0****6GK5991-1AF00-8AA0****LC Plug MM<sup>2)</sup>****6GK1901-0RB10-2AB0****LC Plug SM<sup>2)</sup>****6GK1901-0SB10-2AB0****FO Robust Cable GP 50/125/900<sup>1)</sup>****6XV1873-2R****FO Robust Cable GP 4x9/125/900<sup>1)</sup>****6XV1843-2R****SITOP compact 24 V/0.6 A****6EP1331-5BA00**

1-phase power supply with wide-range input 85 – 264 V AC/110 – 300 V DC, stabilized output voltage 24 V, rated output current value 0.6 A, slim design

**C-PLUG****6GK1900-0AB00**

Swap medium for simple replacement of devices in the event of a fault; for storing configuration or engineering and application data; can be used for SIMATIC NET products with C-PLUG slots

<sup>1)</sup> Special fiber-optic cables, lengths and accessories available on request

<sup>2)</sup> Special tools and trained personnel are required for pre-assembling glass fiber-optic cables

**More information****Selection tools:**

To assist in selecting the right Industrial Ethernet switches as well as configuration of modular variants, the SIMATIC NET Selection Tool and the TIA Selection Tool are available at:

SIMATIC NET Selection Tool:

- Online version: <http://www.siemens.com/snst>
- Offline version: <http://www.siemens.com/snst-download>

TIA Selection Tool:

<http://www.siemens.com/tia-selection-tool>

## PROFINET/Industrial Ethernet

### Industrial Ethernet Switches

#### SCALANCE X204RNA HSR

##### Overview



The SCALANCE X-200RNA (**R**edundant **N**etwork **A**ccess) managed Industrial Ethernet network access points with HSR functionality (**H**igh-availability **S**eamless **R**edundancy Protocol in accordance with IEC 62439-3) are used to connect up to two non-HSR-enabled terminal devices or network segments to a ring-shaped HSR network structure. They can also be used for simple and redundant transition from HSR to PRP (Parallel Redundancy Protocol) network structures.

- Electrical or optical connection to stations or network in accordance with the port type of the devices
- Media redundancy thanks to duplicate transmission of frames in ring-shaped networks
- High system availability since frames are sent simultaneously via two routes in the ring
- No reconfiguration times of the ring-shaped network are required in the event of an error due to duplicate transmission of frames in the ring
- Simple and redundant connection of HSR and PRP network structures
- Redundant 24 V DC voltage infeed or wide-range power supply unit, depending on device version
- SNMP access, integrated Web server and automatic e-mail transmission function for remote diagnostics and signaling via the network

##### Product versions

- Network access point in plastic enclosure with electrical ports
  - **SCALANCE X204RNA for HSR networks;** for connecting up to two non-HSR-enabled terminal devices to ring-topology networks with four electrical ports
- Network access point in metal enclosure with electrical and optical ports, as well as a wide-range power supply unit for use under extended ambient conditions
  - **SCALANCE X204RNA EEC for HSR networks;** for connecting up to two non-HSR-enabled terminal devices to ring-shaped networks with two electrical terminal device ports and two optical/electrical combo ports for network connection
  - **SCALANCE X204RNA EEC for PRP or HSR networks;** for connecting up to two non-PRP-enabled or non-HSR-enabled terminal devices to redundant networks with two electrical terminal device ports and two optical/electrical combo ports for network connection. PRP or HSR function can be defined by the user when starting the device (for description of PRP function, see Section on X204RNA with PRP function).

##### Benefits

get **Designed for Industry**

- Ideal solution for establishing Industrial Ethernet networks with high network availability (bumpless media redundancy through parallel data transfer in parallel network topologies)
- Bumpless data transmission in ring-shaped network structures for high availability systems (e.g. process automation)
- Fast and easy diagnosis with LEDs on the device, through the integral Web server and through signaling contacts
- Integration of the SCALANCE X-200RNA network access points into the existing network management infrastructure through SNMP access
- Simple commissioning without mandatory configuring
- Module replacement without the need for a programming device, using the C-PLUG swap media for backing up the configuration data

##### Application

The SCALANCE X-200RNA Industrial Ethernet network access points with HSR functionality enable low-cost connection of non-HSR-enabled terminal devices to ring-shaped networks in which high availability is demanded. The devices with degree of protection IP20 are designed for operation in the control cabinet.

##### Features:

- Device diagnostics with LEDs (power, link status, data communication)
- Remote diagnostics possible via signaling contact (signal screen can be set locally using buttons), SNMP, and Web browser
- With its extended ambient conditions, the SCALANCE X204RNA EEC is suitable for use in power switching and distribution systems (IEC 61850-3, IEEE 1613) in tough industrial environments

## Design

The SCALANCE X204RNA and X204RNA EEC network access points with rugged plastic or metal enclosure have been optimized for installation on a standard mounting rail and for direct wall mounting in different mounting positions.

The network access points with IP20 degree of protection feature:

- A 4-pole terminal block for connecting the redundant supply voltage (2 x 24 V DC), or a 3-pole terminal block in the case of the wide-range power supply unit
- A row of LEDs to indicate the status information (power, link status, data exchange, power supply, signaling contact)
- A 2-pole or 3-pole terminal block for connecting the floating signaling contact in the corresponding voltage range
- A SET button for on-site configuration of the signaling contact

The SCALANCE X200RNA devices are available with the following port types:

- **100BaseTX, RJ45 connection;**  
RJ45 port with a data rate of 100 Mbit/s, with autosensing and autocrossover function for the connection of IE FC cables via IE FC RJ45 Plug 180 up to 100 m
- **100BaseTX, combo port (RJ45, SFP slot);**  
100 Mbit/s combo ports for direct connection to Industrial Ethernet copper cables or glass fiber-optic cables (multimode/singlemode fiber-optic cable); if the RJ45 interface of the combo port is used, the SFP slot is deactivated, and vice versa.

## Function

- Connection of non-HSR-enabled terminal devices to ring-shaped networks
- Transition from ring-shaped HSR networks to parallel PRP network structures
- Parallel data transmission by means of duplicate transmission in the ring network
- Uncrossed connecting cables can be used due to Autocrossover function integrated in the ports
- Easy diagnostics using signaling contact, SNMP and Web browser
- Fast device replacement in the event of a fault by using the optional C-PLUG swap medium (not included in scope of supply)

### Network topology and network configuration

The SCALANCE X-200RNA switches with IP20 degree of protection are usually installed in a control cabinet together with the stations to be connected. They can be mixed electrically and optically in star and line topologies.

When configuring the network, it is necessary to observe the following boundary conditions:

- Length of the TP cable between the network and SCALANCE X-200RNA:
  - Max. 100 m with IE FC cable and IE FC RJ45 Plug 180
  - Max. 10 m using patches with TP cord
- Length of the optical cables between the network and SCALANCE X-200RNA
  - Max. 5 000 m with Industrial Ethernet glass fiber-optic cables (multimode)
  - Max. 26 000 m with Industrial Ethernet glass fiber-optic cables (singlemode)
- IP address:  
The IP address is assigned by means of the DHCP (Dynamic Host Configuration Protocol). If there is no corresponding server in the network, the IP address can be assigned using the supplied software tool PST (Primary Setup Tool).

### Commissioning and diagnostics

The SCALANCE X-200RNA Industrial Ethernet network access points can be integrated into a network management system via the standardized protocol SNMP (**S**imple **N**etwork **M**anagement **P**rotocol). In the event of a fault in the device, error messages (SNMP traps) can be sent to a network system or as e-mail to a specified network administrator.

The integral Web server enables configuration and diagnostics settings to be made using a standard browser (e.g. port configuration). Statistical information can also be read out over the Web server (e.g. port capacity utilization).

The following information is displayed on site by LEDs:

- Power
- Port status
- Data traffic
- Signaling contact
- HSR activity

The SCALANCE X-200RNA Industrial Ethernet network access points can also be monitored using the floating signaling contact.

# PROFINET/Industrial Ethernet

## Industrial Ethernet Switches

### SCALANCE X204RNA HSR

#### Integration

2

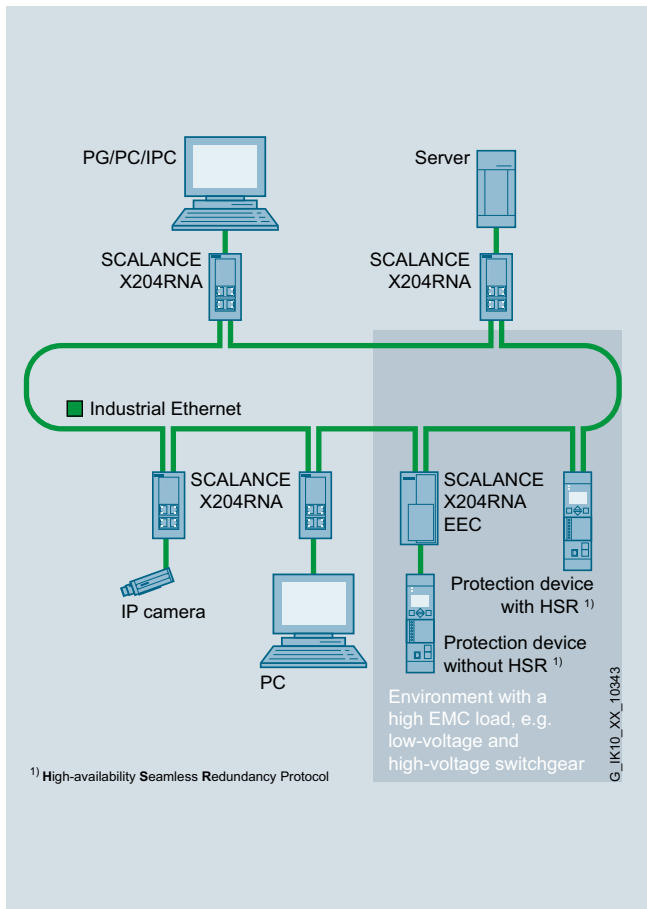

Ring-shaped HSR network structure with SCALANCE X-204RNA

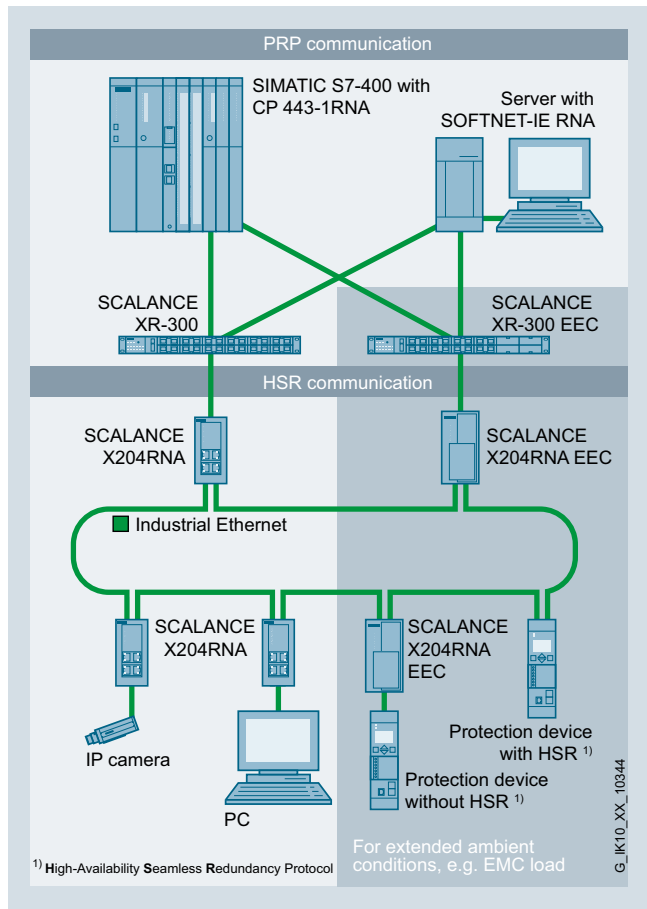

Redundant transition from ring-shaped HSR network structure to parallel PRP network structure by means of SCALANCE X204RNA



**Technical specifications**

Article No.	6GK5204-0BA00-2MB2	6GK5204-0BS00-2NA3	6GK5204-0BS00-3PA3
Product-type designation	SCALANCE X204RNA	SCALANCE X204RNA EEC	SCALANCE X204RNA EEC
<b>Transmission rate</b>			
Transfer rate 2	100 Mbit/s	100 Mbit/s	100 Mbit/s
<b>Interfaces</b>			
Number of electrical/optical connections			
• for network components or terminal equipment maximum	4	4	4
• as combo port for network components or terminal equipment	-	2	2
Number of electrical connections			
• for network components and terminal equipment	4	2	2
• for signaling contact	1	1	1
• for power supply	1	1	1
• for redundant power supply	2	1	1
Design of electrical/optical connections for network components or terminal equipment	-	SFP	SFP
Design of electrical connection			
• for network components and terminal equipment	RJ45 port	RJ45 port	RJ45 port
• for signaling contact	2-pole terminal block	3-pole terminal block	3-pole terminal block
• for power supply	4-pole terminal block	3-pole terminal block	3-pole terminal block
Number of optical interfaces for optical waveguide at 100 Mbit/s	-	2	2
Design of optical interface for optical waveguide at 100 Mbit/s	-	SFF port	SFF port
Design of the removable storage C-PLUG	Yes	Yes	Yes
<b>Signal-Inputs/outputs</b>			
Operating current of signaling contacts at AC maximum	-	0.1 A	0.1 A
Operating voltage of signaling contacts at DC rated value	24 V	24 V	24 V
Operating current of signaling contacts at DC maximum	0.1 A	0.1 A	0.1 A
<b>Supply voltage, current consumption, power loss</b>			
Type of supply voltage	DC	-	-
Supply voltage external	24 V	-	-
• minimum	19.2 V	-	-
• maximum	28.8 V	-	-
Product component fusing at power supply input	Yes	Yes	Yes
Type of fusing at input for supply voltage			
Consumed current maximum	0.15 A	0.25 A	0.25 A
Active power loss at 24 V for DC	3.5 W	6 W	6 W

## PROFINET/Industrial Ethernet

### Industrial Ethernet Switches

#### SCALANCE X204RNA HSR

#### Technical specifications (continued)

Article No.	6GK5204-0BA00-2MB2	6GK5204-0BS00-2NA3	6GK5204-0BS00-3PA3
Product-type designation	SCALANCE X204RNA	SCALANCE X204RNA EEC	SCALANCE X204RNA EEC
<b>Permitted ambient conditions</b>			
Ambient temperature			
• during operating	-40 ... +60 °C	-40 ... +70 °C	-40 ... +70 °C
• during storage	-40 ... +70 °C	-40 ... +70 °C	-40 ... +70 °C
• during transport	-40 ... +70 °C	-40 ... +70 °C	-40 ... +70 °C
• Comment	-	A maximum operating temperature of +85 °C is permissible for a duration of 16 hours	A maximum operating temperature of +85 °C is permissible for a duration of 16 hours
Relative humidity at 25 °C without condensation during operating maximum	95 %	95 %	95 %
Protection class IP	IP20	IP20	IP20
<b>Design, dimensions and weight</b>			
Design	compact	compact	compact
Width	45 mm	70 mm	70 mm
Height	100 mm	147 mm	147 mm
Depth	87 mm	123 mm	123 mm
Net weight	0.23 kg	0.78 kg	0.78 kg
Mounting type			
• 35 mm DIN rail mounting	Yes	Yes	Yes
• wall mounting	Yes	No	No
• S7-300 rail mounting	No	No	No
<b>Product functions management, configuration</b>			
Product function			
• CLI	Yes	Yes	Yes
• web-based management	Yes	Yes	Yes
• MIB support	Yes	Yes	Yes
• TRAPs via email	Yes	Yes	Yes
• Configuration with STEP 7	No	No	No
• SMTP server	-	-	-
• Port mirroring	No	No	No
• for IRT PROFINET IO switch	No	No	No
• PROFINET IO diagnosis	No	No	No
• switch-managed	No	No	No
Protocol is supported			
• Telnet	No	No	No
• HTTP	Yes	Yes	Yes
• HTTPS	Yes	Yes	Yes
• TFTP	No	No	No
• FTP	No	No	No
• BOOTP	No	No	No
• SNMP v1	Yes	Yes	Yes
• SNMP v2	Yes	Yes	Yes
• SNMP v3	Yes	Yes	Yes
• DCP	No	No	No
• LLDP	No	No	No
Identification & maintenance function			
• I&M0 - device-specific information	Yes	Yes	Yes
• I&M1 - higher level designation/location designation	Yes	Yes	Yes

**Technical specifications** (continued)

Article No.	6GK5204-0BA00-2MB2	6GK5204-0BS00-2NA3	6GK5204-0BS00-3PA3
Product-type designation	SCALANCE X204RNA	SCALANCE X204RNA EEC	SCALANCE X204RNA EEC
<b>Product functions Diagnosis</b>			
Product function			
• Port diagnostics	Yes	Yes	Yes
• Statistics packet size	Yes	Yes	Yes
• Statistics packet type	Yes	Yes	Yes
• Error statistics	Yes	Yes	Yes
<b>Product functions Redundancy</b>			
Product function			
• Ring redundancy	Yes	Yes	No
• Redundancy manager	No	No	No
• Standby redundancy	No	No	No
• High Speed Redundancy Protocol (HRP)	No	No	No
• Media Redundancy Protocol (MRP)	No	No	No
• Parallel Redundancy Protocol (PRP)	No	No	Yes
• High availability Seamless Redundancy (HSR)	Yes	Yes	Yes
• Passive listening	No	No	No
Protocol is supported PRP	Yes	Yes	Yes
<b>Product functions Security</b>			
Protocol is supported SSH	Yes	Yes	Yes
<b>Product functions Time</b>			
Product function			
• SICLOCK support	No	No	No
Protocol is supported			
• NTP	No	No	No
• SNTP	Yes	Yes	Yes
<b>Standards, specifications, approvals</b>			
Standard			
• for EMC	-	IEC 61850, IEEE 1613	IEC 61850, IEEE 1613
- from FM	FM3611: Class 1, Division 2, Group A, B, C, D / T4, CL.1, Zone 2, GP. IIC, T4	FM3611: Class 1, Division 2, Group A, B, C, D / T4, CL.1, Zone 2, GP. IIC, T4	FM3611: Class 1, Division 2, Group A, B, C, D / T4, CL.1, Zone 2, GP. IIC, T4
• for hazardous zone	EN 60079-0: 2006, EN 60079-15: 2005, II 3 G Ex nA II T4, KEMA 07 ATEX 0145 X	EN 60079-0: 2006, EN 60079-15: 2005, II 3 G Ex nA II T4, KEMA 07 ATEX 0145 X	EN 60079-0: 2006, EN 60079-15: 2005, II 3 G Ex nA II T4, KEMA 07 ATEX 0145 X
• for safety of CSA and UL	UL 60950-1, CSA C22.2 No. 60950-1	UL 508, CSA C22.2 No. 142-M1987	UL 508, CSA C22.2 No. 142-M1987
• for hazardous area of CSA and UL			
• for emitted interference	EN 61000-6-4:2001 (Class A)	EN 61000-6-4:2001 (Class A)	EN 61000-6-4:2001 (Class A)
• for interference immunity	EN 61000-6-4:2001	EN 61000-6-4:2001	EN 61000-6-4:2001
Verification of suitability	EN 61000-6-4:2001	EN 61000-6-4:2001	EN 61000-6-4:2001
• CE mark	Yes	Yes	Yes
• C-Tick	Yes	Yes	Yes
• KC approval	Yes	Yes	Yes
• Railway application in accordance with EN 50155	No	No	No
• Railway application in accordance with EN 50124-1	No	No	No
• IEC 61850-3	No	Yes	Yes
Certificate of suitability IEEE 1613	-	Yes	Yes
Marine classification association			
• American Bureau of Shipping Europe Ltd. (ABS)	No	No	No
• Bureau Veritas (BV)	No	No	No
• Det Norske Veritas (DNV)	No	No	No
• Germanische Lloyd (GL)	No	No	No
• Lloyds Register of Shipping (LRS)	No	No	No
• Nippon Kaiji Kyokai (NK)	No	No	No
• Polski Rejestr Statkow (PRS)	No	No	No

## PROFINET/Industrial Ethernet

### Industrial Ethernet Switches

#### SCALANCE X204RNA HSR

##### Ordering data

##### Article No.

##### Article No.

##### SCALANCE X-200RNA HSR Industrial Ethernet network access points

Industrial Ethernet network access points with integrated SNMP access, web diagnostics and PROFINET diagnostics, for connecting non-HSR-enabled terminal devices to ring-shaped HSR networks; incl. operating instructions, Industrial Ethernet network manual, and configuration software on CD-ROM; with electrical and optical ports for glass multimode fiber optic cables up to 5 km

- **SCALANCE X204RNA** with four 100 Mbit/s RJ45 ports
- **SCALANCE X204RNA EEC** with two 100 Mbit/s RJ45 ports and two RJ45/SFP combo ports
- **SCALANCE X204RNA EEC** with two 100 Mbit/s RJ45 ports and two RJ45/SFP combo ports with PRP or HSR support

**6GK5204-0BA00-2MB2**

**6GK5204-0BS00-2NA3**

**6GK5204-0BS00-3PA3**

##### Accessories

##### IE FC TP Standard Cable GP 2 x 2 (Type A)

4-wire, shielded TP installation cable for connecting to IE FC RJ45 outlet/IE FC RJ45 plug; PROFINET-compliant; with UL approval; sold by the meter; max. length 1 000 m, minimum order 20 m

**6XV1840-2AH10**

##### IE FC RJ45 Plug 180 2 x 2

RJ45 plug-in connector for Industrial Ethernet with a rugged metal enclosure and integrated insulation displacement contacts for connecting Industrial Ethernet FC installation cables; with 180° cable outlet; for network components and CPs/CPU with Industrial Ethernet interfaces

- 1 pack = 1 unit
- 1 pack = 10 units
- 1 pack = 50 units

**6GK1901-1BB10-2AA0**

**6GK1901-1BB10-2AB0**

**6GK1901-1BB10-2AE0**

<sup>1)</sup> Special fiber-optic cables, lengths and accessories available on request

<sup>2)</sup> Special tools and trained personnel are required for pre-assembling glass fiber-optic cables

##### SFP plug-in transceiver

- SFP991-1 (multimode, glass, up to 3 km)
- SFP991-1LH+ (singlemode, glass, up to 70 km, LH+)
- SFP991-1LD (singlemode, glass, up to 26 km)

**6GK5991-1AD00-8AA0**

**6GK5991-1AE00-8AA0**

**6GK5991-1AF00-8AA0**

##### LC Plug MM<sup>2)</sup>

**6GK1901-ORB10-2AB0**

##### LC Plug SM<sup>2)</sup>

**6GK1901-OSB10-2AB0**

##### FO Robust Cable GP 50/125/900<sup>1)</sup>

**6XV1873-2R**

##### FO Robust Cable GP 4x9/125/900<sup>1)</sup>

**6XV1843-2R**

##### SITOP compact 24 V/0.6 A

1-phase power supply with wide-range input 85 – 264 V AC/110 – 300 V DC, stabilized output voltage 24 V, rated output current value 0.6 A, slim design

**6EP1331-5BA00**

##### C-PLUG

Swap medium for simple replacement of devices in the event of a fault; for storing configuration or engineering and application data; can be used for SIMATIC NET products with C-PLUG slots

**6GK1900-0AB00**

##### More information

##### Selection tool:

To assist in selecting the right Industrial Ethernet switches as well as configuration of modular variants, the SIMATIC NET Selection Tool and the TIA Selection Tool are available at:

SIMATIC NET Selection Tool:

- Online version: <http://www.siemens.com/snst>
- Offline version: <http://www.siemens.com/snst-download>

TIA Selection Tool:

<http://www.siemens.com/tia-selection-tool>



**Overview**

SCALANCE X-200IRT	Type of device	Hardware																
		Connection to S7 backplane bus	Format module S7	PC module	Flat type of construction	Box type of construction	19" type of construction	Rugged, compact housing	Modular design	10 Gigabit Ethernet	Gigabit Ethernet	PoE (Power over Ethernet)	LED diagnosis	SIMATIC environment	Redundant power supply (2 x 24 V DC)	External supply for integrated switch	Signal contact	Local display (SET pushbutton)
	X200-4P IRT											•	•	•		•	•	•
	X201-3P IRT											•	•	•		•	•	•
	X201-3P IRT PRO											•	•	•		•	•	•
	X202-2IRT											•	•	•		•	•	•
	X202-2P IRT											•	•	•		•	•	•
	X202-2P IRT PRO											•	•	•		•	•	•
	X204IRT											•	•	•		•	•	•
	X204IRT PRO											•	•	•		•	•	•
	XF204IRT			•								•	•	•		•	•	•

• applies

G\_IK10\_XX\_10314

Function overview SCALANCE X-200IRT managed: Hardware

SCALANCE X-200IRT	Type of device	Software																										
		Security Integrated (Firewall/VPN)	PROFINET diagnosis	Topology support (LLDP)	Command Line Interface / Telnet	Web based Management	Configuration with STEP 7	SNMP	Ring redundancy incl. RM-functionality	Standby redundancy	IRT capability	VLAN (Virtual Local Area Network)	GVRP (Generic VLAN Registration Protocol)	STP/ RSTP (Spanning Tree Protocol/ Rapid Spanning Tree Protocol)	Passive Listening	IGMP Snooping/Querier (Internet Group Management Protocol)	GMRP (Generic Multicast Protocol)	Broadcast/ Multicast/ Unicast Limiter	Broadcast blocking	DHCP Option 82 (Dynamic Host Configuration Protocol)	IP Access List	Access Control List (MAC)	IEEE 802.1x (Radius)	Link Aggregation	Static Routing	RIPv2 (Dynamic Routing)	OSPFv2 (Dynamic Routing)	VRRP, Router Redundancy (Virtual Router Redundancy Protocol)
	X200-4P IRT	•	•	•	•	•	•	•	•	•				•														
	X201-3P IRT	•	•	•	•	•	•	•	•	•				•														
	X201-3P IRT PRO	•	•	•	•	•	•	•	•	•				•														
	X202-2IRT	•	•	•	•	•	•	•	•	•				•														
	X202-2P IRT	•	•	•	•	•	•	•	•	•				•														
	X202-2P IRT PRO	•	•	•	•	•	•	•	•	•				•														
	X204IRT	•	•	•	•	•	•	•	•	•				•														
	X204IRT PRO	•	•	•	•	•	•	•	•	•				•														
	XF204IRT	•	•	•	•	•	•	•	•	•				•														

• applies

G\_IK10\_XX\_10315

Function overview SCALANCE X-200IRT managed: Software

## PROFINET/Industrial Ethernet

### Industrial Ethernet Switches

#### SCALANCE X-200IRT managed

#### Overview



SCALANCE X-200IRT switches are especially designed for constructing isochronous real-time (IRT) Industrial Ethernet networks in line, star and ring topologies at transmission rates of 10/100 Mbit/s (Redundancy Manager integrated); construction of redundant ring connections possible.

- Optimized performance due to combination of the switching mechanisms "Cut Through" and "Store and Forward"
- Fast media redundancy due to the integrated redundancy manager for Fast Ethernet
- Rugged, industry-standard station connections with PROFINET-compatible plug-in connectors that offer additional strain relief and bending strain relief thanks to latching on the enclosure
- PROFINET diagnostics, SNMP access, integrated web server and automatic e-mail transmission function for remote diagnostics and signaling via the network
- Different device versions with copper and fiber-optic interfaces (BFOC, SC RJ)
- Implementation of cabinet-free plant concepts with PROFINET-compliant push pull connection systems with device variants with IP65/67 protection

#### Product versions

##### SCALANCE X204IRT

- For configuring electrical Industrial Ethernet linear bus, star or ring topologies with 4 electrical ports

##### SCALANCE X202-2IRT

- For configuring electrical/optical Industrial Ethernet linear bus, star or ring topologies with two electrical ports and two glass fiber optic ports

##### SCALANCE X202-2P IRT

- For configuring electrical/optical Industrial Ethernet linear bus, star or ring topologies with two electrical ports and two optical POF fiber optic ports

##### SCALANCE X201-3P IRT

- For configuring electrical/optical Industrial Ethernet linear bus, star or ring topologies with one electrical port and three optical POF fiber optic ports

##### SCALANCE X200-4P IRT

- For configuring optical Industrial Ethernet linear bus, star or ring topologies with 4 optical POF fiber-optic ports

##### SCALANCE X204 IRT PRO

- For the construction of electrical Industrial Ethernet linear, star or ring topologies with four electrical ports in degree of protection IP65/67 with PROFINET-compliant push-pull connection technology

##### SCALANCE X202-2P IRT PRO

- For the construction of electrical/optical Industrial Ethernet linear bus, star or ring structures with two electrical and two optical POF/PCF fiber optic ports in degree of protection IP65/67 with PROFINET-compliant push-pull connection technology

##### SCALANCE X201-3P IRT PRO

- For the construction of electrical/optical Industrial Ethernet linear bus, star or ring topologies with one electrical and three optical POF/PCF fiber optic ports in degree of protection IP65/67 with PROFINET-compliant push-pull connection technology

Applicable to all versions:

- Integral redundancy manager (RM)
- Device diagnostics with LEDs (power, link status, data communication)
- Remote diagnosis is possible through signaling contact (signal mask can be set locally using buttons), PROFINET, SNMP and Web browser
- Automatic e-mail send function
- Rugged, industry-standard station connections with PROFINET-compatible RJ45 connectors that offer additional strain relief and bending strain relief thanks to latching on the housing

The SCALANCE X-200IRT switches, based on PROFINET, satisfy the real-time requirements of the field level up to high-performance motion control applications.

## Benefits



## Designed for Industry

- The ideal solution for constructing isochronous real-time (IRT) Industrial Ethernet segments especially in line, star and ring topologies with copper and fiber-optic cabling (glass FOC, PCF FOC, POF FOC)
- Reliable data communication thanks to rugged, industry-standard device connection using PROFINET-compatible connectors (IE FC RJ45 Plug 2x2) that offer additional strain relief and bending strain relief thanks to latching on the enclosure
- High network availability in ring topologies, without reconfiguration times, when using the PROFINET-compliant MRPD process (**M**edia **R**edundancy for **P**lanned **D**uplication according to IEC 61158)
- Fast and easy diagnosis with LEDs on the device, through the integral Web server and through signaling contacts
- Easy integration in the process diagnosis and system diagnosis with PROFINET
- Configuration and diagnostics integrated into STEP 7 provide significant benefits during the engineering, start-up and operating phases of a plant
- Module replacement without the need for a programming device, using the C-PLUG swap media for backing up the configuration data

## Application

The SCALANCE X-200IRT Industrial Ethernet switches permit the construction of isochronous real-time (IRT) Industrial Ethernet line and star topologies. Ring structures can also be designed using the integral redundancy manager (RM). Redundant ring connections are also possible. Thanks to innovative switching technology, the special requirements of automation with regard to line topology, isochronous mode for motion control applications and unlimited IT openness have been satisfied for the first time within a single technology based on the PROFINET standard.

The switches with IP30 degree of protection have been designed for use in the control cabinet. The switches with IP65/67 protection are designed for cabinet-free mounting (PROFINET-compliant push pull connection technology).

### Real-time Ethernet

- Interfacing of the PROFINET IO Devices to the PROFINET IO Controller through high-performance, optimized data transmission
- Coexistence of isochronous mode for motion control applications and IT openness:  
Reaction-free transmission of real-time and non-real-time communication on the same line

### Additionally through isochronous real-time (IRT) Ethernet

- Isochronous real-time communication based on the transmission procedure of the IEEE 802 standard by combining the switching mechanisms "Cut Through" and "Store and Forward"
- For drive controls, PROFINET with isochronous real-time is the best performing system worldwide with regard to its isochronous and deterministic response.  
With a cycle time of 1 ms, for example, axes can be controlled in isochronous mode whereby 50% of the bandwidth is available solely for IT communication.

## Design

- The SCALANCE X-200IRT switches in a rugged metal housing with IP30 and IP65/67 degree of protection are optimized for mounting on a standard rail and an S7-300 rail. Direct wall mounting in various positions is also possible. Thanks to the S7-300 housing dimensions, the devices are suitable for integration into an automation solution with S7-300 components.
- The switches have a 4-pin terminal block for connecting the redundant supply voltage (2 x 24 V DC). The variants with IP65/67 protection have two 5-pin push-pull connectors via which the supply voltage is fed and forwarded. In addition, the load voltage circuit is also looped through for the ET200pro devices further along the line. The devices with IP65/67 protection thus have no redundant voltage feed, but permit optimal integration into cabinet-free plant concepts with ET200pro modules.  
The status information (power, link status, data traffic, voltage supply, signaling contact) is indicated by means of a row of LEDs.

The SCALANCE X-200IRT modules are available with the following port types:

- **10/100BaseTX, RJ45 connection**  
RJ45 port, automatic detection of the data rate (10 or 100 Mbit/s), with Autosensing and Autocrossover function for connecting IE FC cables over IE FC RJ45 Plug 180 over distances up to 100 m.
- **10/100BaseTX, push-pull RJ45 connection**  
RJ45 port, automatic detection of the data rate (10 or 100 Mbit/s), with Autosensing and Autocrossover function for connecting IE FC cables via IE FC RJ45 Plug PRO over distances up to 100 m
- **100BaseFX, BFOC connection technique**  
BFOC ports for direct connection to Industrial Ethernet glass fiber-optic cables up to 5000 m for configuring line and star topologies.
- **100BaseFX, SC RJ connections**  
SC RJ ports for connection to Industrial Ethernet POF (50 m) and PCF FOC (100 m) using SC RJ plug connectors
- **100BaseFX, push-pull SC RJ connections**  
SC RJ ports for connection to Industrial Ethernet POF (50 m) and PCF FOC (100 m) using SC RJ plug PRO connectors

## PROFINET/Industrial Ethernet

### Industrial Ethernet Switches

#### SCALANCE X-200IRT managed

#### Function

- 4-port switch for configuring electrical and optical Industrial Ethernet line, star and ring topologies
- Integral redundancy manager for design of ring topologies
- Integral standby function for redundant coupling of two rings
- Extremely short cycle times with highly accurate clock-pulse rates thanks to integrated real-time functions
- Bumpless ring redundancy by sending message frames twice in the ring, by means of PROFINET-compliant MRPD procedure (**M**edia **R**edundancy for **P**lanned **D**uplication according to IEC 61158)
- System-wide clock accuracy (less than 1 ms)
- Uncrossed connecting cables can be used due to Autocrossover function integrated in the ports
- Load disconnection through integral switch functionality
- Easy diagnostics using signaling contact, SNMP and Web browser
- Automatic e-mail function
- Integration into the diagnostics of a PROFINET IO-Controllers for a consistent diagnostics concept, including network infrastructure
- Fast device replacement in the event of a fault by using the optional C-PLUG swap medium (not included in scope of supply)

#### Network topology and network configuration

The SCALANCE X-200IRT Industrial Ethernet Switches are usually installed in the control cabinet together with the stations to be connected (e.g. ET 200S) or, in the case of cabinet-free designs, mounted directly onto the machine. When configuring the network, it is necessary to observe the following boundary conditions:

- Length of the TP cable between two SCALANCE X switches:
  - Max. 100 m with IE FC cable and IE FC RJ45 Plug 180 or IE FC RJ45 Plug PRO
  - Max. 10 m with TP Cord
- Length of the optical cables
  - Max. 4 000 m with Industrial Ethernet glass fiber-optic cables (62.5/125 µm)
  - Max. 5 000 m with Industrial Ethernet glass fiber-optic cables (50/125 µm)
  - Max. 100 m with Industrial Ethernet PCF fiber-optic cables.
  - Max. 50 m with Industrial Ethernet POF fiber-optic cables.
- IP Address:
 

The IP address is assigned by means of the DHCP (Dynamic Host Configuration Protocol). If there is no corresponding server in the network, the IP address can be assigned using the supplied software tool PST (Primary Setup Tool) or STEP 7. The SCALANCE X-200IRT switches and their real-time functions are configured with STEP 7.

#### Commissioning and diagnostics

PROFINET diagnostic alarms from SCALANCE X-200IRT Switches can be displayed with the appropriate SIMATIC Engineering Tools and processed in the control unit. The engineering outlay for the PLC and HMI have been drastically reduced due to the complete integration in the SIMATIC concept for system error messages.

The SCALANCE X-200IRT Industrial Ethernet switches can also be integrated into a network management system through the standardized protocol SNMP (Simple Network Management Protocol). In the event of a device fault, error messages (SNMP traps) can be sent to a network system or as e-mail to a specified network manager.

The integral Web server enables configuration and diagnosis settings to be made using a standard browser. Statistical information can also be read out over the Web server. Warning thresholds, and alarms generated by them, permit early recognition of critical fiber states (only with POF). Cable failures (fiber breakage) can thus be avoided, and plant downtimes reduced, since maintenance work can be carried out at an early point in time and outside production periods.

The following information is displayed on site by LEDs:

- Power
- Port status
- Data traffic
- RM activated
- POF cable diagnostics (for POF versions only)

The Industrial Ethernet switches of the SCALANCE X-200IRT line can also be monitored using the floating signaling contact.

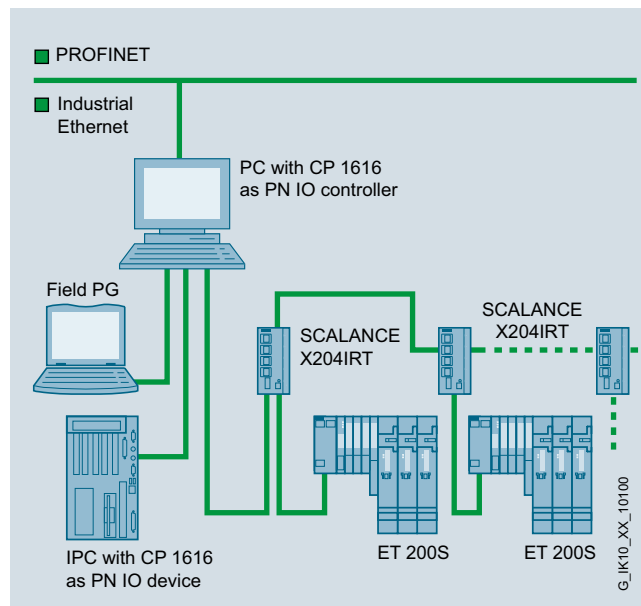

Configuration example for SCALANCE X204IRT



**Function** (continued)

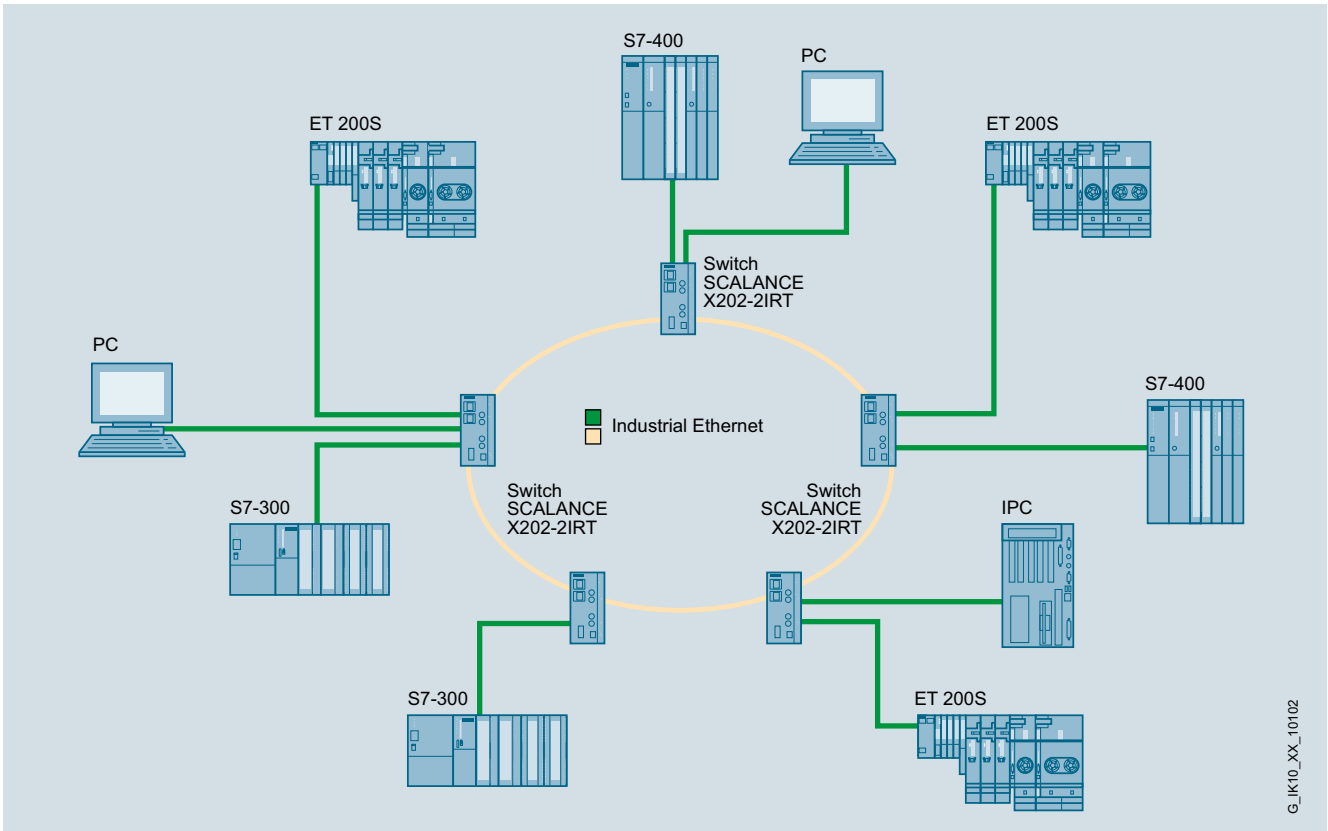

Configuration with high-speed redundancy in the optical ring

# PROFINET/Industrial Ethernet

## Industrial Ethernet Switches

### SCALANCE X-200IRT managed

#### Function (continued)

2

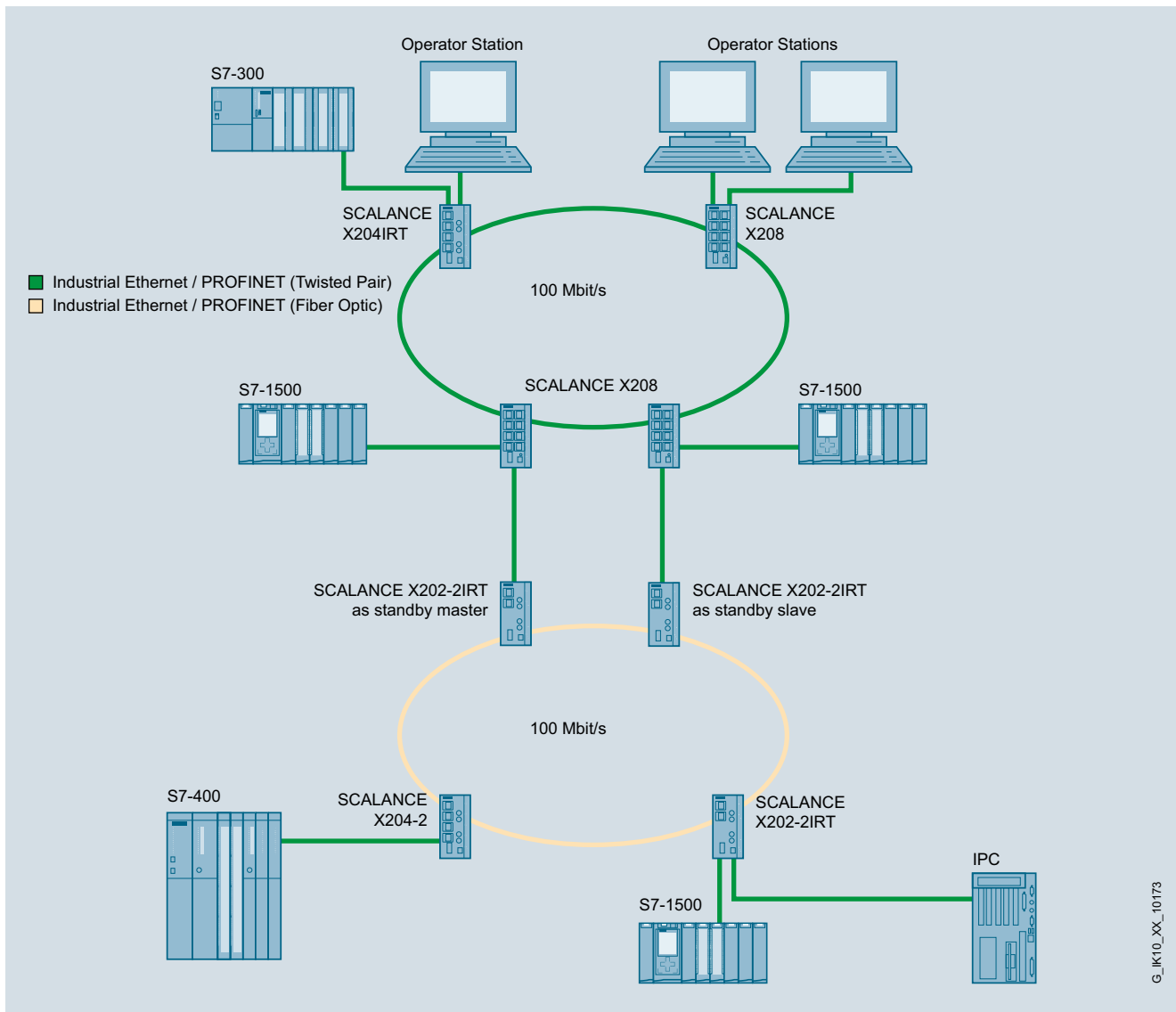

Redundant coupling of two subnetworks with SCALANCE X-200IRT

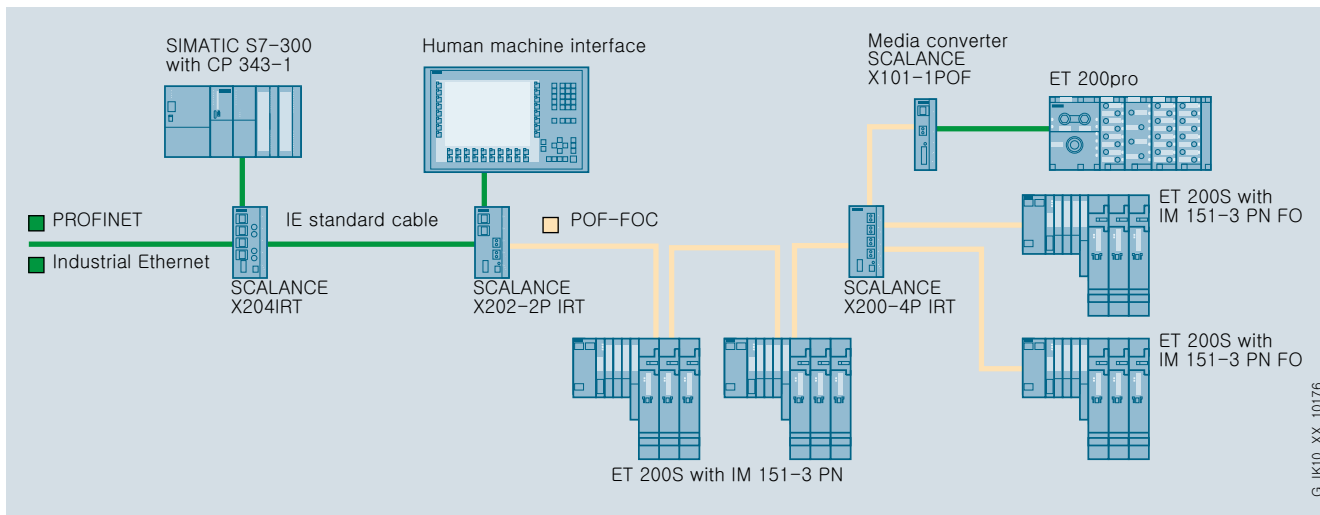

Mixed network topology with plastic fiber-optic cables and twisted-pair cables

**Technical specifications**

Article No.	6GK5200-4AH00-2BA3	6GK5201-3BH00-2BA3	6GK5202-2BH00-2BA3
Product-type designation	SCALANCE X200-4P IRT	SCALANCE X201-3P IRT	SCALANCE X202-2P IRT
<b>Transmission rate</b>			
Transfer rate 1	10 Mbit/s	10 Mbit/s	10 Mbit/s
Transfer rate 2	100 Mbit/s	100 Mbit/s	100 Mbit/s
<b>Interfaces</b>			
Number of electrical/optical connections			
• for network components or terminal equipment maximum	4	4	4
Number of electrical connections			
• for network components and terminal equipment	-	1	2
• for signaling contact	1	1	1
• for power supply	1	1	1
• for redundant power supply	1	1	1
Design of electrical/optical connections for network components or terminal equipment	SC RJ	SC RJ	SC RJ
Design of electrical connection			
• for network components and terminal equipment	-	RJ45 port	RJ45 port
• for signaling contact	2-pole terminal block	2-pole terminal block	2-pole terminal block
• for power supply	4-pole terminal block	4-pole terminal block	4-pole terminal block
Number of optical interfaces for optical waveguide at 100 Mbit/s	4	3	2
Design of optical interface for optical waveguide at 100 Mbit/s	SC-RJ/POF port	SC-RJ/POF port	SC-RJ/POF port
Connectable optical power relative to 1 mW			
• of the transmitter output	-8 ... -2 dB	-8 ... -2 dB	-8 ... -2 dB
Optical sensitivity relative to 1 mW of the receiver input minimum	-25 dB	-25 dB	-25 dB
Attenuation of fiber-optic cable transmission link minimum necessary	0 dB	0 dB	0 dB
Range at the optical interface depending on the optical fiber used	0 ... 0.05 km	0 ... 0.05 km	0 ... 0.05 km
Design of the removable storage C-PLUG	Yes	Yes	Yes
<b>Signal-Inputs/outputs</b>			
Operating voltage of signaling contacts at DC rated value	24 V	24 V	24 V
Operating current of signaling contacts at DC maximum	0.1 A	0.1 A	0.1 A
<b>Supply voltage, current consumption, power loss</b>			
Type of supply voltage	DC	DC	DC
Supply voltage external	24 V	24 V	24 V
• minimum	18 V	18 V	18 V
• maximum	32 V	32 V	32 V
Product component fusing at power supply input	Yes	Yes	Yes
Type of fusing at input for supply voltage	1.1 A / 33 V	1.1 A / 33 V	1.1 A / 33 V
Consumed current maximum	0.4 A	0.35 A	0.3 A
Active power loss at 24 V for DC	9.6 W	8.4 W	7.2 W

## PROFINET/Industrial Ethernet

### Industrial Ethernet Switches

#### SCALANCE X-200IRT managed

#### Technical specifications (continued)

Article No.	6GK5200-4AH00-2BA3	6GK5201-3BH00-2BA3	6GK5202-2BH00-2BA3
Product-type designation	SCALANCE X200-4P IRT	SCALANCE X201-3P IRT	SCALANCE X202-2P IRT
<b>Permitted ambient conditions</b>			
Ambient temperature			
• during operating	-25 ... +40 °C	-25 ... +50 °C	-25 ... +60 °C
• during storage	-40 ... +70 °C	-40 ... +70 °C	-40 ... +70 °C
• during transport	-40 ... +70 °C	-40 ... +70 °C	-40 ... +70 °C
Relative humidity at 25 °C without condensation during operating maximum	95 %	95 %	95 %
Protection class IP	IP30	IP30	IP30
<b>Design, dimensions and weight</b>			
Design	compact	compact	compact
Width	60 mm	60 mm	60 mm
Height	125 mm	125 mm	125 mm
Depth	124 mm	124 mm	124 mm
Net weight	0.78 kg	0.78 kg	0.78 kg
Mounting type			
• 35 mm DIN rail mounting	Yes	Yes	Yes
• wall mounting	Yes	Yes	Yes
• S7-300 rail mounting	Yes	Yes	Yes
<b>Product properties, functions, components general</b>			
Cascading in the case of a redundant ring at reconfiguration time of < 0.3 s	50	50	50
Cascading in cases of star structuring	Any (depending only on signal propagation time)	Any (depending only on signal propagation time)	Any (depending only on signal propagation time)
<b>Product functions management, configuration</b>			
Product function			
• CLI	Yes	Yes	Yes
• web-based management	Yes	Yes	Yes
• MIB support	Yes	Yes	Yes
• TRAPs via email	Yes	Yes	Yes
• Configuration with STEP 7	Yes	Yes	Yes
• SMTP server	-	-	-
• Port mirroring	No	No	No
• for IRT PROFINET IO switch	Yes	Yes	Yes
• PROFINET IO diagnosis	Yes	Yes	Yes
• switch-managed	Yes	Yes	Yes
Protocol is supported			
• Telnet	Yes	Yes	Yes
• HTTP	Yes	Yes	Yes
• HTTPS	Yes	Yes	Yes
• TFTP	Yes	Yes	Yes
• FTP	Yes	Yes	Yes
• BOOTP	No	No	No
• SNMP v1	Yes	Yes	Yes
• SNMP v2	Yes	Yes	Yes
• SNMP v3	Yes	Yes	Yes
• DCP	Yes	Yes	Yes
• LLDP	Yes	Yes	Yes
Identification & maintenance function			
• I&M0 - device-specific information	Yes	Yes	Yes
• I&M1 - higher level designation/location designation	Yes	Yes	Yes

## Technical specifications (continued)

Article No.	6GK5200-4AH00-2BA3	6GK5201-3BH00-2BA3	6GK5202-2BH00-2BA3
Product-type designation	SCALANCE X200-4P IRT	SCALANCE X201-3P IRT	SCALANCE X202-2P IRT
<b>Product functions Diagnosis</b>			
Product function			
• Port diagnostics	Yes	Yes	Yes
• Statistics packet size	Yes	Yes	Yes
• Statistics packet type	Yes	Yes	Yes
• Error statistics	Yes	Yes	Yes
<b>Product functions DHCP</b>			
Product function DHCP client	Yes	Yes	Yes
<b>Product functions Redundancy</b>			
Product function			
• Ring redundancy	Yes	Yes	Yes
• Redundancy manager	Yes	Yes	Yes
• Standby redundancy	Yes	Yes	Yes
• High Speed Redundancy Protocol (HRP)	Yes	Yes	Yes
• Media Redundancy Protocol (MRP)	Yes	Yes	Yes
• Parallel Redundancy Protocol (PRP)	No	No	No
• Passive listening	Yes	Yes	Yes
Protocol is supported PRP	Yes	Yes	Yes
<b>Product functions Security</b>			
Protocol is supported SSH	Yes	Yes	Yes
<b>Product functions Time</b>			
Product function SICLOCK support	Yes	Yes	Yes
Protocol is supported			
• NTP	No	No	No
• SNTP	Yes	Yes	Yes
<b>Standards, specifications, approvals</b>			
Standard			
• for EMC from FM	FM3611: Class 1, Division 2, Group A, B, C, D / T4, CL.1, Zone 2, GP. IIC, T4	FM3611: Class 1, Division 2, Group A, B, C, D / T4, CL.1, Zone 2, GP. IIC, T4	FM3611: Class 1, Division 2, Group A, B, C, D / T4, CL.1, Zone 2, GP. IIC, T4
• for hazardous zone	EN 60079-0 : 2006, EN 60079-15: 2005, II 3 G Ex nA II T4 KEMA 07 ATEX 0145X	EN 60079-0 : 2006, EN 60079-15: 2005, II 3 G Ex nA II T4 KEMA 07 ATEX 0145X	EN 60079-0 : 2006, EN 60079-15: 2005, II 3 G Ex nA II T4 KEMA 07 ATEX 0145X
• for safety of CSA and UL	UL 60950-1, CSA C22.2 No. 60950-1	UL 60950-1, CSA C22.2 No. 60950-1	UL 60950-1, CSA C22.2 No. 60950-1
• for hazardous area of CSA and UL	ANSI / ISA 12.12.01, CSA C22.2 No. 213-M1987, CL. 1 / Div. 2 / GP. A, B, C, D T4, CL. 1 / Zone 2 / GP. IIC, T4	ANSI / ISA 12.12.01, CSA C22.2 No. 213-M1987, CL. 1 / Div. 2 / GP. A, B, C, D T4, CL. 1 / Zone 2 / GP. IIC, T4	ANSI / ISA 12.12.01, CSA C22.2 No. 213-M1987, CL. 1 / Div. 2 / GP. A, B, C, D T4, CL. 1 / Zone 2 / GP. IIC, T4
• for emitted interference	EN 61000-6-4:2001	EN 61000-6-4 (Class A)	EN 61000-6-4:2001 (Class A)
• for interference immunity	EN 61000-6-2:2001	EN 61000-6-2	EN 61000-6-4:2001
Verification of suitability	EN 61000-6-2:2001, EN 61000-6-4:2001	EN 61000-6-2, EN 61000-6-4	EN 61000-6-4:2001
• CE mark	Yes	Yes	Yes
• C-Tick	Yes	Yes	Yes
• KC approval	Yes	Yes	Yes
• Railway application in accordance with EN 50155	No	No	No
• Railway application in accordance with EN 50124-1	No	No	No
Marine classification association			
• American Bureau of Shipping Europe Ltd. (ABS)	No	No	No
• Bureau Veritas (BV)	No	No	No
• Det Norske Veritas (DNV)	No	No	No
• Germanische Lloyd (GL)	No	No	No
• Lloyds Register of Shipping (LRS)	No	No	No
• Nippon Kaiji Kyokai (NK)	No	No	No
• Polski Rejestr Statkow (PRS)	No	No	No

## PROFINET/Industrial Ethernet

### Industrial Ethernet Switches

#### SCALANCE X-200IRT managed

#### Technical specifications (continued)

Article No.	6GK5202-2BB00-2BA3	6GK5204-0BA00-2BA3
Product-type designation	SCALANCE X202-2IRT	SCALANCE X204IRT
<b>Transmission rate</b>		
Transfer rate 1	10 Mbit/s	10 Mbit/s
Transfer rate 2	100 Mbit/s	100 Mbit/s
<b>Interfaces</b>		
Number of electrical/optical connections		
• for network components or terminal equipment maximum	4	4
Number of electrical connections		
• for network components and terminal equipment	2	4
• for signaling contact	1	1
• for power supply	1	1
• for redundant power supply	1	1
Design of electrical connection		
• for network components and terminal equipment	RJ45 port	RJ45 port
• for signaling contact	2-pole terminal block	2-pole terminal block
• for power supply	4-pole terminal block	4-pole terminal block
Number of optical interfaces for optical waveguide at 100 Mbit/s	2	-
Design of optical interface for optical waveguide at 100 Mbit/s	BFOC sockets (multimode up to 5 km)	-
Connectable optical power relative to 1 mW		
• of the transmitter output	-19 ... -14 dB	-
Optical sensitivity relative to 1 mW of the receiver input minimum	-34 dB	-
Attenuation of fiber-optic cable transmission link minimum necessary	0 dB	-
Range at the optical interface depending on the optical fiber used	0 ... 0.05 km	-
Design of the removable storage C-PLUG	Yes	Yes
<b>Signal-Inputs/outputs</b>		
Operating voltage of signaling contacts at DC rated value	24 V	24 V
Operating current of signaling contacts at DC maximum	0.1 A	0.1 A
<b>Supply voltage, current consumption, power loss</b>		
Type of supply voltage	DC	DC
Supply voltage external	24 V	24 V
• minimum	18 V	18 V
• maximum	32 V	32 V
Product component fusing at power supply input	Yes	Yes
Type of fusing at input for supply voltage	0.6 A / 60 V	0.6 A / 60 V
Consumed current maximum	0.3 A	0.2 A
Active power loss at 24 V for DC	6 W	4.8 W

**Technical specifications (continued)**

Article No.	6GK5202-2BB00-2BA3	6GK5204-0BA00-2BA3
Product-type designation	SCALANCE X202-2IRT	SCALANCE X204IRT
<b>Permitted ambient conditions</b>		
Ambient temperature		
• during operating	-40 ... +60 °C	-40 ... +70 °C
• during storage	-40 ... +70 °C	-40 ... +70 °C
• during transport	-40 ... +70 °C	-40 ... +70 °C
• Comment	-	-
Relative humidity at 25 °C without condensation during operating maximum	95 %	95 %
Protection class IP	IP30	IP30
<b>Design, dimensions and weight</b>		
Design	compact	compact
Width	60 mm	60 mm
Height	125 mm	125 mm
Depth	124 mm	124 mm
Net weight	0.78 kg	0.78 kg
Mounting type		
• 35 mm DIN rail mounting	Yes	Yes
• wall mounting	Yes	Yes
• S7-300 rail mounting	Yes	Yes
<b>Product properties, functions, components general</b>		
Cascading in the case of a redundant ring at reconfiguration time of < 0.3 s	50	50
Cascading in cases of star structuring	Any (depending only on signal propagation time)	Any (depending only on signal propagation time)
<b>Product functions management, configuration</b>		
Product function		
• CLI	Yes	Yes
• web-based management	Yes	Yes
• MIB support	Yes	Yes
• TRAPs via email	Yes	Yes
• Configuration with STEP 7	Yes	Yes
• SMTP server	-	-
• Port mirroring	No	No
• for IRT PROFINET IO switch	Yes	Yes
• PROFINET IO diagnosis	Yes	Yes
• switch-managed	Yes	Yes
Protocol is supported		
• Telnet	Yes	Yes
• HTTP	Yes	Yes
• HTTPS	Yes	Yes
• TFTP	Yes	Yes
• FTP	Yes	Yes
• BOOTP	No	No
• SNMP v1	Yes	Yes
• SNMP v2	Yes	Yes
• SNMP v3	Yes	Yes
• DCP	Yes	Yes
• LLDP	Yes	Yes
Identification & maintenance function		
• I&M0 - device-specific information	Yes	Yes
• I&M1 - higher level designation/location designation	Yes	Yes

## PROFINET/Industrial Ethernet

### Industrial Ethernet Switches

#### SCALANCE X-200IRT managed

#### Technical specifications (continued)

Article No.	6GK5202-2BB00-2BA3	6GK5204-0BA00-2BA3
Product-type designation	SCALANCE X202-2IRT	SCALANCE X204IRT
<b>Product functions Diagnosis</b>		
Product function		
• Port diagnostics	Yes	Yes
• Statistics packet size	Yes	Yes
• Statistics packet type	Yes	Yes
• Error statistics	Yes	Yes
<b>Product functions DHCP</b>		
Product function DHCP client	Yes	Yes
<b>Product functions Redundancy</b>		
Product function		
• Ring redundancy	Yes	Yes
• Redundancy manager	Yes	Yes
• Standby redundancy	Yes	Yes
• High Speed Redundancy Protocol (HRP)	Yes	Yes
• Media Redundancy Protocol (MRP)	Yes	Yes
• Parallel Redundancy Protocol (PRP)	No	No
• Passive listening	Yes	Yes
Protocol is supported PRP	Yes	Yes
<b>Product functions Security</b>		
Protocol is supported SSH	Yes	Yes
<b>Product functions Time</b>		
Product function SICLOCK support	Yes	Yes
Protocol is supported		
• NTP	No	No
• SNTP	Yes	Yes
<b>Standards, specifications, approvals</b>		
Standard		
• for EMC from FM	FM3611: Class 1, Division 2, Group A, B, C, D / T4, CL.1, Zone 2, GP. IIC, T4	FM3611: Class 1, Division 2, Group A, B, C, D / T4, CL.1, Zone 2, GP. IIC, T4
• for hazardous zone	EN 60079-0: 2006, EN 60079-15: 2005, II 3 (2) G Ex nA [op is] IIC T4, KEMA 07 ATEX 0145 X	EN 60079-0 : 2006, EN 60079-15: 2005, II 3 G Ex nA II T4 KEMA 07 ATEX 0145X
• for safety of CSA and UL	UL 60950-1, CSA C22.2 No. 60950-1	UL 60950-1, CSA C22.2 No. 60950-1
• for hazardous area of CSA and UL	ANSI / ISA 12.12.01, CSA C22.2 No. 213-M1987, CL. 1 / Div. 2 / GP. A, B, C, D T4, CL. 1 / Zone 2 / GP. IIC, T4	ANSI / ISA 12.12.01, CSA C22.2 No. 213-M1987, CL. 1 / Div. 2 / GP. A, B, C, D T4, CL. 1 / Zone 2 / GP. IIC, T4
• for emitted interference	EN 61000-6-4:2001 (Class A)	EN 61000-6-4:2001 (Class A)
• for interference immunity	EN 61000-6-4:2001	EN 61000-6-4:2001
Verification of suitability	EN 61000-6-4:2001	EN 61000-6-4:2001
• CE mark	Yes	Yes
• C-Tick	Yes	Yes
• KC approval	Yes	Yes
• Railway application in accordance with EN 50155	No	No
• Railway application in accordance with EN 50124-1	No	No
Marine classification association		
• American Bureau of Shipping Europe Ltd. (ABS)	Yes	Yes
• Bureau Veritas (BV)	No	Yes
• Det Norske Veritas (DNV)	Yes	Yes
• Germanische Lloyd (GL)	Yes	Yes
• Lloyds Register of Shipping (LRS)	Yes	Yes
• Nippon Kaiji Kyokai (NK)	Yes	Yes
• Polski Rejestr Statkow (PRS)	No	No



**Technical specifications (continued)**

Article No.	6GK5204-0JA00-2BA6	6GK5202-2JR00-2BA6	6GK5201-3JR00-2BA6
Product-type designation	SCALANCE X204IRT PRO	SCALANCE X202-2P IRT PRO	SCALANCE X201-3P IRT PRO
<b>Transmission rate</b>			
Transfer rate 1	10 Mbit/s	10 Mbit/s	10 Mbit/s
Transfer rate 2	100 Mbit/s	100 Mbit/s	100 Mbit/s
<b>Interfaces</b>			
Number of electrical/optical connections			
• for network components or terminal equipment maximum	4	4	4
Number of electrical connections			
• for network components and terminal equipment	4	2	1
• for signaling contact	1	1	1
• for power supply	1	1	1
Design of electrical/optical connections for network components or terminal equipment	-	SC RJ push-pull	SC RJ push-pull
Design of electrical connection			
• for network components and terminal equipment	RJ45 push-pull plug PRO	RJ45 push-pull plug PRO	RJ45 push-pull plug PRO
• for signaling contact	5-pin M12 socket	5-pin M12 socket	5-pin M12 socket
• for power supply	5-pin push-pull plug PRO socket	5-pin push-pull plug PRO socket	5-pin push-pull plug PRO socket
Number of optical interfaces for optical waveguide at 100 Mbit/s	-	2	3
Design of optical interface for optical waveguide at 100 Mbit/s	-	SC-RJ/POF push-pull plug PRO port	SC-RJ/POF push-pull plug PRO port
Connectable optical power relative to 1 mW			
• of the transmitter output	--	-8 ... -2 dB	-8 ... -2 dB
Optical sensitivity relative to 1 mW of the receiver input minimum	-	-25 dB	-25 dB
Attenuation of fiber-optic cable transmission link minimum necessary	-	0 dB	0 dB
Range at the optical interface depending on the optical fiber used	--	0 ... 0.05 km	0 ... 0.05 km
Design of the removable storage C-PLUG	Yes	Yes	Yes
<b>Signal-Inputs/outputs</b>			
Operating voltage of signaling contacts at DC rated value	24 V	24 V	24 V
Operating current of signaling contacts at DC maximum	0.1 A	0.1 A	0.1 A
<b>Supply voltage, current consumption, power loss</b>			
Type of supply voltage	DC	DC	DC
Supply voltage external	24 V	24 V	24 V
• minimum	18 V	18 V	18 V
• maximum	32 V	32 V	32 V
Product component fusing at power supply input	Yes	Yes	Yes
Type of fusing at input for supply voltage	0.6 A / 60 V	1.1 A / 33 V	1.1 A / 33 V
Consumed current maximum	0.2 A	0.3 A	0.33 A
Active power loss at 24 V for DC	4.8 W	7.2 W	7.92 W

## PROFINET/Industrial Ethernet

### Industrial Ethernet Switches

#### SCALANCE X-200IRT managed

#### Technical specifications (continued)

Article No.	6GK5204-0JA00-2BA6	6GK5202-2JR00-2BA6	6GK5201-3JR00-2BA6
Product-type designation	SCALANCE X204IRT PRO	SCALANCE X202-2P IRT PRO	SCALANCE X201-3P IRT PRO
<b>Permitted ambient conditions</b>			
Ambient temperature			
• during operating	-25 ... +70 °C	-25 ... +60 °C	-25 ... +60 °C
• during storage	-40 ... +70 °C	-40 ... +70 °C	-40 ... +70 °C
• during transport	-40 ... +70 °C	-40 ... +70 °C	-40 ... +70 °C
• Comment	-	-	-
Relative humidity at 25 °C without condensation during operating maximum	95 %	95 %	95 %
Protection class IP	IP67	IP67	IP67
<b>Design, dimensions and weight</b>			
Design	compact	compact	compact
Width	90 mm	90 mm	90 mm
Height	125 mm	125 mm	125 mm
Depth	124 mm	124 mm	124 mm
Net weight	1 kg	1 kg	1 kg
Mounting type			
• 35 mm DIN rail mounting	Yes	Yes	Yes
• wall-mounting	Yes	Yes	Yes
• S7-300 rail mounting	Yes	Yes	Yes
<b>Product properties, functions, components general</b>			
Cascading in the case of a redundant ring at reconfiguration time of < 0.3 s	50	50	50
Cascading in cases of star structuring	Any (depending only on signal propagation time)	Any (depending only on signal propagation time)	Any (depending only on signal propagation time)
<b>Product functions management, configuration</b>			
Product function			
• CLI	Yes	Yes	Yes
• web-based Management	Yes	Yes	Yes
• MIB support	Yes	Yes	Yes
• TRAPs via email	Yes	Yes	Yes
• Configuration with STEP 7	Yes	Yes	Yes
• Port mirroring	No	No	No
• for IRT PROFINET IO switch	Yes	Yes	Yes
• PROFINET IO diagnosis	Yes	Yes	Yes
• switch-managed	Yes	Yes	Yes
Protocol is supported			
• Telnet	Yes	Yes	Yes
• HTTP	Yes	Yes	Yes
• HTTPS	Yes	Yes	Yes
• TFTP	Yes	Yes	Yes
• FTP	Yes	Yes	Yes
• BOOTP	No	No	No
• SNMP v1	Yes	Yes	Yes
• SNMP v2	Yes	Yes	Yes
• SNMP v3	Yes	Yes	Yes
• DCP	Yes	Yes	Yes
• LLDP	Yes	Yes	Yes
Identification & maintenance function			
• I&M0 - device specific information	Yes	Yes	Yes
• I&M1 - higher level designation/location designation	Yes	Yes	Yes

## Technical specifications (continued)

Article No.	6GK5204-0JA00-2BA6	6GK5202-2JR00-2BA6	6GK5201-3JR00-2BA6
Product-type designation	SCALANCE X204IRT PRO	SCALANCE X202-2P IRT PRO	SCALANCE X201-3P IRT PRO
<b>Product functions Diagnosis</b>			
Product function			
• Port diagnostics	Yes	Yes	Yes
• Statistics packet size	Yes	Yes	Yes
• Statistics packet type	Yes	Yes	Yes
• Error Statistics	Yes	Yes	Yes
<b>Product functions DHCP</b>			
Product function DHCP client	Yes	Yes	Yes
<b>Product functions Redundancy</b>			
Product function			
• Ring redundancy	Yes	Yes	Yes
• Redundancy manager	Yes	Yes	Yes
• Standby redundancy	Yes	Yes	Yes
• High Speed Redundancy Protocol (HRP)	Yes	Yes	Yes
• Media Redundancy Protocol (MRP)	Yes	Yes	Yes
• Parallel Redundancy Protocol (PRP)	No	No	No
• Passive listening	Yes	Yes	Yes
Protocol is supported PRP	Yes	Yes	Yes
<b>Product functions Security</b>			
Protocol is supported SSH	Yes	Yes	Yes
<b>Product functions Time</b>			
Product function SICLOCK support	Yes	Yes	Yes
Protocol is supported			
• NTP	No	No	No
• SNTP	Yes	Yes	Yes
<b>Standards, specifications, approvals</b>			
Standard			
• for EMC from FM	FM3611: Class 1, Division 2, Group A, B, C, D / T4, CL.1, Zone 2, GP. IIC, T4	FM3611: Class 1, Division 2, Group A, B, C, D / T4, CL.1, Zone 2, GP. IIC, T4	FM3611: Class 1, Division 2, Group A, B, C, D / T4, CL.1, Zone 2, GP. IIC, T4
• for hazardous zone	EN 60079-0 : 2006, EN 60079-15: 2005, II 3 G Ex nA II T4 KEMA 07 ATEX 0145X	EN 60079-0 : 2006, EN 60079-15: 2005, II 3 G Ex nA II T4 KEMA 07 ATEX 0145X	EN 60079-0 : 2006, EN 60079-15: 2005, II 3 G Ex nA II T4 KEMA 07 ATEX 0145X
• for safety of CSA and UL	UL 60950-1, CSA C22.2 No. 60950-1	UL 60950-1, CSA C22.2 No. 60950-1	UL 60950-1, CSA C22.2 No. 60950-1
• for hazardous area of CSA and UL	ANSI / ISA 12.12.01, CSA C22.2 No. 213-M1987, CL. 1 / Div. 2 / GP. A, B, C, D T4, CL. 1 / Zone 2 / GP. IIC, T4	ANSI / ISA 12.12.01, CSA C22.2 No. 213-M1987, CL. 1 / Div. 2 / GP. A, B, C, D T4, CL. 1 / Zone 2 / GP. IIC, T4	ANSI / ISA 12.12.01, CSA C22.2 No. 213-M1987, CL. 1 / Div. 2 / GP. A, B, C, D T4, CL. 1 / Zone 2 / GP. IIC, T4
• for emitted interference	EN 61000-6-4:2001 (Class A)	EN 61000-6-4:2001 (Class A)	EN 61000-6-4:2001 (Class A)
• for interference immunity	EN 61000-6-4:2001	EN 61000-6-4:2001	EN 61000-6-4:2001
Verification of suitability	EN 61000-6-4:2001	EN 61000-6-4:2001	EN 61000-6-4:2001
• CE-mark	Yes	Yes	Yes
• C-Tick	Yes	Yes	Yes
• KC approval	Yes	Yes	Yes
• Railway application in accordance with EN 50155	No	No	No
• Railway application in accordance with EN 50124-1	No	No	No
Marine classification association			
• American Bureau of Shipping Europe Ltd. (ABS)	No	No	No
• Bureau Veritas (BV)	Yes	No	No
• Det Norske Veritas (DNV)	Yes	No	No
• Germanische Lloyd (GL)	Yes	No	No
• Lloyds Register of Shipping (LRS)	Yes	No	No
• Nippon Kaiji Kyokai (NK)	Yes	No	No
• Polski Rejestr Statkow (PRS)	No	No	No

# PROFINET/Industrial Ethernet

## Industrial Ethernet Switches

### SCALANCE X-200IRT managed

#### Ordering data

#### Article No.

#### Article No.

#### Industrial Ethernet Switches SCALANCE X-200IRT

Managed Industrial Ethernet switches;  
Isochronous Real-Time, LED diagnostics, fault signaling contact with SET button, redundant power supply; incl. operating instructions, Industrial Ethernet network manual and configuration software on CD-ROM

- **SCALANCE X204IRT;**  
4 x 10/100 Mbit/s RJ45 ports
- **SCALANCE X204IRT PRO;**  
4 x 10/100 Mbit/s RJ45 push-pull ports
- **SCALANCE X202-2IRT;**  
2 x 10/100 Mbit/s RJ45 ports,  
2 x 100 Mbit/s
- Multimode BFOC ports
- **SCALANCE X202-2P IRT;**  
2 x 10/100 Mbit/s RJ45 ports,  
2 x 100 Mbit/s  
POF/PCF SC RJ ports
- **SCALANCE X202-2P IRT PRO;**  
2 x 10/100 Mbit/s  
RJ45 push-pull ports,  
2 x 100 Mbit/s  
POF/PCF SC RJ push-pull ports
- **SCALANCE X201-3P IRT;**  
1 x 10/100 Mbit/s RJ45 port,  
3 x 100 Mbit/s  
POF/PCF SC RJ ports
- **SCALANCE X201-3P IRT PRO;**  
1 x 10/100 Mbit/s RJ45 port,  
3 x 100 Mbit/s  
POF/PCF SC RJ ports
- **SCALANCE X200-4P IRT;**  
4 x 100 Mbit/s POF/PCF SC RJ

**6GK5204-0BA00-2BA3**

**6GK5204-0JA00-2BA6**

**6GK5202-2BB00-2BA3**

**6GK5202-2BH00-2BA3**

**6GK5202-2JR00-2BA6**

**6GK5201-3BH00-2BA3**

**6GK5201-3JR00-2BA6**

**6GK5200-4AH00-2BA3**

#### Accessories

#### Industrial Ethernet media converter SCALANCE X-100

Industrial Ethernet media converters, LED diagnostics, fault signaling contact with SET key, redundant power supply, PROFINET-compatible securing collars

- **SCALANCE X101-1POF;**  
1 X 10/100 Mbit/s RJ45 port,  
1 X 100 Mbit/s POF SC RJ port

**6GK5101-1BH00-2AA3**

#### IE FC TP Standard Cable GP 2 x 2 (Type A)

4-core, shielded TP installation cable for connection to IE FC RJ45 outlet / IE FC RJ45 plug; PROFINET-compliant; with UL approval; sold by the meter; max. length 1 000 m, minimum order 20 m

**6XV1840-2AH10**

#### FO Standard Cable GP 50/125/1400<sup>1)2)</sup>

Multimode cable, sold by the meter; max. length 1 000 m; minimum order 20 m;

**6XV1873-2A**

<sup>1)</sup> Special fiber-optic cables, lengths and accessories available on request

<sup>2)</sup> Special tools and trained personnel are required for pre-assembling glass fiber-optic cables

#### POF Standard Cable GP 980/1000

POF standard cable for fixed routing indoors with PVC sheath; sold by the meter; max. length 1 000 m; minimum order 20 m

**6XV1874-2A**

#### PCF Standard Cable GP 200/230

Standard cable, segmentable, sold by the meter; max. length 2 000 m; minimum order 20 m;

**6XV1861-2A**

#### IE FC RJ45 Plug 180 2 x 2

RJ45 plug-in connector for Industrial Ethernet with a rugged metal enclosure and integrated insulation displacement contacts for connecting Industrial Ethernet FC installation cables; with 180° cable outlet; for network components and CPs/CPUs with Industrial Ethernet interface

- 1 pack = 1 unit
- 1 pack = 10 units
- 1 pack = 50 units

**6GK1901-1BB10-2AA0**

**6GK1901-1BB10-2AB0**

**6GK1901-1BB10-2AE0**

#### IE FC RJ45 Plug PRO

FastConnect RJ45 plug-in connector; plastic housing, insulation displacement technology, for SCALANCE X-200IRT PRO switches and SIMATIC ET 200pro; 1 connector (IP65/67) suitable for on-site assembly

**6GK1901-1BB20-6AA0**

#### SC RJ POF Plug

20 plugs for on-site assembly

**6GK1900-0MB00-0AC0**

#### SC RJ POF Plug PRO

1 plug (IP65/67) for on-site assembly

**6GK1900-0MB00-6AA0**

#### SC RJ PCF Plug

10 plugs for on-site assembly

**6GK1900-0NB00-0AC0**

#### SC RJ PCF Plug PRO

1 plug (IP65/67) for on-site assembly

**6GK1900-0NB00-6AA0**

#### Termination Kit SC RJ POF Plug

Assembly case for on-site installation of SC RJ POF connectors; consisting of stripping tool, Kevlar cutters, SC RJ grinding plate, grinding paper, grinding base and microscope

**6GK1900-0ML00-0AA0**

#### Termination Kit SC RJ PCF Plug

Assembly case for local assembly of SC RJ PCF connectors, comprising a stripping tool, buffer stripping tool, Kevlar cutters, fiber breaking tool and microscope

**6GK1900-0NL00-0AA0**

**Ordering data**
**Article No.**
*Accessories (continued)*
**Power Plug PRO**

1 plug (IP65/67)  
for on-site assembly (5-core)

**6GK1907-0AB10-6AA0**
**SIMATIC RF600 connecting cable**

Preassembled connecting cable  
(10 m) with RJ45 Plug PRO and  
RJ45 Plug

**6GT2891-1HN10**
**SITOP compact 24 V/ 0.6 A**

1-phase power supply  
with wide-range input  
85 – 264 V AC/110 – 300 V DC,  
stabilized output voltage 24 V,  
rated output current value 0.6 A,  
slim design

**6EP1331-5BA00**
**C-PLUG**

Swap medium for simple  
replacement of devices in the event  
of a fault; for storing configuration or  
engineering and application data;  
can be used for SIMATIC NET  
products with C-PLUG slot

**6GK1900-0AB00**
**More information**
**Selection tool:**

To assist in selecting the right Industrial Ethernet switches as well as configuration of modular variants, the SIMATIC NET Selection Tool and the TIA Selection Tool are available at:

SIMATIC NET Selection Tool:

- Online version:  
<http://www.siemens.com/snst>
- Offline version:  
<http://www.siemens.com/snst-download>

TIA Selection Tool:

<http://www.siemens.com/tia-selection-tool>

## PROFINET/Industrial Ethernet

### Industrial Ethernet Switches

#### SCALANCE XF-200IRT managed

#### Overview

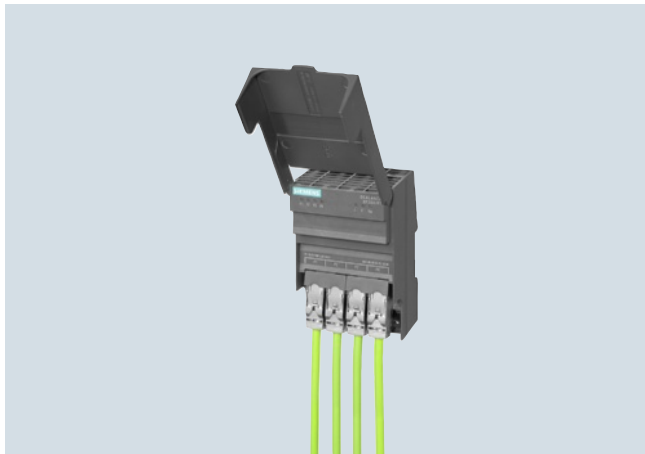

The SCALANCE XF204IRT Industrial Ethernet switch is suitable for the construction of deterministic and isochronous real-time Industrial Ethernet networks, at data transfer rates of 10/100 Mbit/s, in line, star, and ring topologies.

- Connection of up to four terminal units possible
- Enclosure in ET 200S format (slim design, 75 mm width) for space-saving use in small control boxes
- Integrated redundancy manager for constructing Fast Ethernet ring topologies with fast media redundancy
- PROFINET diagnostics, SNMP access, integrated web server and automatic e-mail transmission function for remote diagnostics and signaling via the network

#### Product versions

##### SCALANCE XF204IRT

- For setting up electrical Industrial Ethernet line, star or ring topologies with four electrical ports (ET 200S design)

#### Benefits

**get** Designed for Industry

- Optimized startup behavior (link setup, data forwarding) of PROFINET network components and IO Devices through fast start-up functionality
- Lower susceptibility to failure and higher availability of the plant networking due to latching of the RJ45 FastConnect connectors in the sleeve of the RJ45 ports
- Simple connection and disconnection of the RJ45 plug by means of easily accessible RJ45 sockets angled downward on the device
- High network availability in ring topologies, without reconfiguration times, when using the PROFINET-compliant MRPD process (**M**edia **R**edundancy for **P**lanned **D**uplication according to IEC 61158)
- Protection of investment through integration into existing network management systems, such as SINEMA Server, by means of standardized SNMP access
- Time savings during engineering, commissioning and in the operating phase of a plant by using the configuration and diagnostics integrated in STEP 7

#### Application

The SCALANCE XF204IRT Industrial Ethernet switch permits the construction of isochronous real-time (IRT) Industrial Ethernet line and star topologies. Thanks to innovative switching technology, the special requirements of automation with regard to line topology, isochronous mode for motion control applications, and unlimited IT openness are satisfied within a single technology based on the PROFINET standard.

#### Features:

- Device diagnostics with LEDs (power, link status, data communication)
- Remote diagnostics is possible through signaling contact (signal mask can be set locally using buttons), PROFINET, SNMP, and web browser
- Automatic e-mail send function
- The RJ45 sockets are designed to be industry-compatible with additional sleeves, for connection of the IE FC RJ45 Plug 180

#### Real-Time Ethernet

- Interfacing of the PROFINET IO Devices to the PROFINET IO Controller through high-performance, optimized data transmission
- Coexistence of isochronous mode for motion control applications and IT openness: Reaction-free transmission of real-time and non-real-time communication on the same line

#### Additionally through isochronous real-time (IRT) Ethernet

- Isochronous real-time communication based on the transmission procedure of the IEEE 802 standard by combining the switching mechanisms "Cut Through" and "Store and Forward"
- For drive controls, PROFINET with isochronous real-time is the best performing system worldwide with regard to its isochronous and deterministic response. For example, with a cycle time of 1 ms, axes can be controlled in isochronous mode while 50% of the bandwidth is available at the same time for IT communication without restriction.

#### Design

The SCALANCE XF-204IRT managed Industrial Ethernet switch is designed for mounting on a standard mounting rail. With its enclosure in ET 200S format (slim design), the device is optimally suited for integration in automation solutions in small control boxes together with the ET200S.

The switch with degree of protection IP30 features:

- 2 x 2-pole terminal block for connecting the redundant supply voltage (2 x 24 V DC)
- A row of LEDs to indicate the status information (power, link status, data traffic, power supply, signaling contact)
- A 2-pole terminal block for connecting the isolated signaling contact
- A SET button for on-site configuration of the signaling contact

The SCALANCE XF204IRT switch is available with the following port types:

- **10/100BaseTX, RJ45 connection;**  
RJ45 socket, automatic detection of the data rate (10 or 100 Mbit/s), with Autosensing and Autocrossover functions for connecting IE FC cables using the IE FC RJ45 Plug 180.

#### Function

- Configuration of electrical Industrial Ethernet line, star and ring topologies
- Integral redundancy manager for setting up ring topologies
- Integral standby function for redundant coupling of two rings
- Extremely short cycle times with highly accurate clock-pulse rates thanks to integrated real-time functions
- Bumpless ring redundancy by sending message frames twice in the ring, by means of PROFINET-compliant MRPD procedure (**M**edia **R**edundancy for **P**lanned **D**uplication according to IEC 61158)
- System-wide clock accuracy (deviation less than 1 ms)
- Uncrossed connecting cables can be used due to Autocrossover function integrated in the ports
- Easy diagnostics using signaling contact, SNMP and Web browser
- Integration into the diagnostics of a PROFINET IO Controller by means of real-time communication (RT) according to the PROFINET standard
- Fast device replacement in the event of a fault by using the optional C-PLUG swap medium (not included in scope of supply)

#### Network topology and network configuration

The SCALANCE XF204IRT Industrial Ethernet switch with IP30 degree of protection is installed in a control cabinet together with the stations to be connected. It can be combined electrically in star, line and ring topologies.

When configuring the network, it is necessary to observe the following boundary conditions:

- Length of the TP cable between two SCALANCE XF switches:  
- Max. 100 m with IE FC cable and IE FC RJ45 Plug 180
- IP Address:  
The IP address is assigned using the DHCP (Dynamic Host Configuration Protocol) mechanism. If there is no corresponding server in the network, the IP address can be assigned using the supplied software tool PST (Primary Setup Tool) or STEP 7. The device and real-time configuration of the SCALANCE XF204IRT switch is performed via STEP 7.

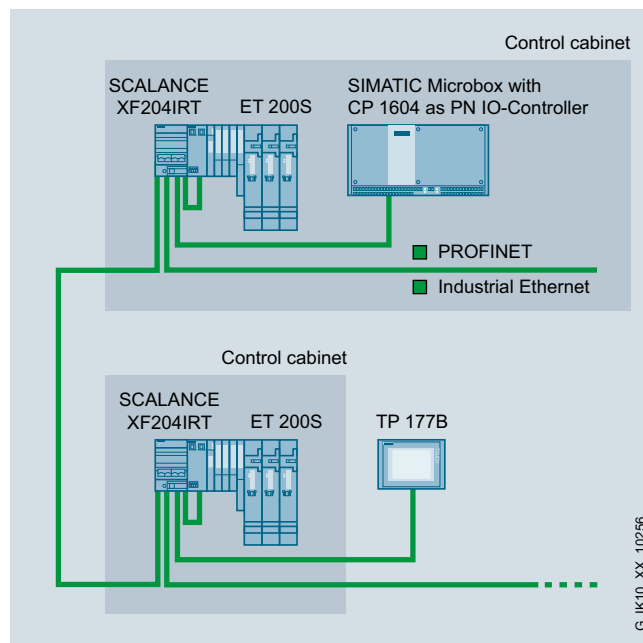

SCALANCE XF204IRT with ET 200S and SIMATIC Microbox in compact control cabinets or boxes

#### Commissioning and diagnosis

PROFINET diagnostic interrupts from SCALANCE XF204IRT can be displayed with the appropriate SIMATIC Engineering Tools and processed in the controller with expanded diagnostics function. The engineering outlay for the PLC and HMI have been drastically reduced due to the complete integration in the SIMATIC concept for system error messages.

The SCALANCE XF204IRT Industrial Ethernet switch can also be integrated into a network management system, e.g. SINEMA Server, through the standardized Simple Network Management Protocol (SNMP). In the event of a fault in the device, error messages (SNMP traps) can be sent to a network system or as e-mail to a specified network administrator.

The integral Web server enables configuration and diagnostics settings to be made using a standard browser (e.g. port configuration). Statistical information can also be read out over the Web server (e.g. port capacity utilization).

The following information is displayed by LEDs on site:

- Power
- Port status
- Data traffic
- Signaling contact
- Redundancy manager function

# PROFINET/Industrial Ethernet

## Industrial Ethernet Switches

### SCALANCE XF-200IRT managed

#### Technical specifications

Article No.	6GK5204-0BA00-2BF2
Product-type designation	SCALANCE XF204IRT
<b>Transmission rate</b>	
Transfer rate 1	10 Mbit/s
Transfer rate 2	100 Mbit/s
<b>Interfaces</b>	
Number of electrical/optical connections	
• for network components or terminal equipment maximum	4
Number of electrical connections	
• for network components and terminal equipment	4
• for signaling contact	1
• for power supply	1
• for redundant power supply	1
Design of electrical connection	
• for network components and terminal equipment	RJ45 port
• for signaling contact	2-pole terminal block
• for power supply	4-pole terminal block
Design of the removable storage C-PLUG	Yes
<b>Signal-Inputs/outputs</b>	
Operating voltage of signaling contacts at DC rated value	24 V
Operating current of signaling contacts at DC maximum	0.1 A
<b>Supply voltage, current consumption, power loss</b>	
Type of supply voltage	DC
Supply voltage external	24 V
• minimum	18 V
• maximum	32 V
Product component fusing at power supply input	Yes
Type of fusing at input for supply voltage	0,6 A / 60 V
Consumed current maximum	0.2 A
Active power loss at 24 V for DC	4.8 W

Article No.	6GK5204-0BA00-2BF2
Product-type designation	SCALANCE XF204IRT
<b>Permitted ambient conditions</b>	
Ambient temperature	
• during operating	-40 ... +60 °C
• during storage	-40 ... +60 °C
• during transport	-40 ... +60 °C
• Comment	If the IE switch XF 200 is installed horizontally a maximum ambient temperature of +40 °C is permitted
Relative humidity at 25 °C without condensation during operating maximum	95 %
Protection class IP	IP20
<b>Design, dimensions and weight</b>	
Design	Flat
Width	75 mm
Height	125 mm
Depth	73 mm
Net weight	0.25 kg
Mounting type	
• 35 mm DIN rail mounting	Yes
• wall mounting	No
• S7-300 rail mounting	No
<b>Product properties, functions, components general</b>	
Cascading in the case of a redundant ring at reconfiguration time of < 0.3 s	50
Cascading in cases of star structuring	Any (depending only on signal propagation time)

2



**Technical specifications (continued)**

Article No.	6GK5204-0BA00-2BF2	Article No.	6GK5204-0BA00-2BF2
Product-type designation	SCALANCE XF204IRT	Product-type designation	SCALANCE XF204IRT
<b>Product functions management, configuration</b>		<b>Product functions Security</b>	
Product function		Protocol is supported SSH	Yes
• CLI	Yes	<b>Product functions Time</b>	
• web-based management	Yes	Product function SICLOCK support	Yes
• MIB support	Yes	Protocol is supported	
• TRAPs via email	Yes	• NTP	No
• Configuration with STEP 7	Yes	• SNTP	Yes
• Port mirroring	No	<b>Standards, specifications, approvals</b>	
• for IRT PROFINET IO switch	Yes	Standard	
• PROFINET IO diagnosis	Yes	• for EMC from FM	FM3611: Class 1, Division 2, Group A, B, C, D / T4, CL.1, Zone 2, GP. IIC, T4
• switch-managed	Yes	• for hazardous zone	EN 60079-0: 2006, EN 60079-15: 2005, II 3 G Ex nA II T4, KEMA 07 ATEX 0145 X
Protocol is supported		• for safety of CSA and UL	UL 60950-1, CSA C22.2 No. 60950-1
• Telnet	Yes	• for hazardous area of CSA and UL	ANSI / ISA 12.12.01, CSA C22.2 N o. 213-M1987, CL. 1 / Div. 2 / GP. A, B, C, D T4, CL. 1 / Zone 2 / GP. IIC, T4
• HTTP	Yes	• for emitted interference	EN 61000-6-4:2001 (Class A)
• HTTPS	Yes	• for interference immunity	EN 61000-6-4:2001
• TFTP	Yes	Verification of suitability	EN 61000-6-4:2001
• FTP	Yes	• CE mark	Yes
• BOOTP	No	• C-Tick	Yes
• SNMP v1	Yes	• KC approval	No
• SNMP v2	Yes	• Railway application in accordance with EN 50155	No
• SNMP v3	Yes	• Railway application in accordance with EN 50124-1	No
• DCP	Yes	Marine classification association	
• LLDP	Yes	• American Bureau of Shipping Europe Ltd. (ABS)	No
Identification & maintenance function		• Bureau Veritas (BV)	No
• I&M0 - device-specific information	Yes	• Det Norske Veritas (DNV)	No
• I&M1 - higher level designation/location designation	Yes	• Germanische Lloyd (GL)	No
<b>Product functions Diagnosis</b>		• Lloyds Register of Shipping (LRS)	No
Product function		• Nippon Kaiji Kyokai (NK)	No
• Port diagnostics	Yes	• Polski Rejestr Statkow (PRS)	No
• Statistics packet size	Yes		
• Statistics packet type	Yes		
• Error statistics	Yes		
<b>Product functions DHCP</b>			
Product function DHCP client	Yes		
<b>Product functions Redundancy</b>			
Product function			
• Ring redundancy	Yes		
• Redundancy manager	Yes		
• Standby redundancy	Yes		
• High Speed Redundancy Protocol (HRP)	Yes		
• Media Redundancy Protocol (MRP)	Yes		
• Parallel Redundancy Protocol (PRP)	No		
• Passive listening	Yes		
Protocol is supported PRP	Yes		

## PROFINET/Industrial Ethernet

### Industrial Ethernet Switches

#### SCALANCE XF-200IRT managed

##### Ordering data

##### Article No.

###### Industrial Ethernet Switches SCALANCE XF-200IRT

Managed Industrial Ethernet Switches for setting up line, star and ring topologies; Isochronous Real Time, LED diagnostics, fault signaling contact with SET button, redundant power supply; incl. operating instructions, Industrial Ethernet network manual and configuration software on CD-ROM

- **SCALANCE XF204IRT**  
4 x 10/100 Mbit/s  
RJ45 electrical port;

**6GK5204-0BA00-2BF2**

###### Accessories

###### IE FC TP Standard Cable GP 2 x 2 (Type A)

4-core, shielded TP installation cable for connection to IE FC RJ45 outlet / IE FC RJ45 plug; PROFINET-compliant; with UL approval; sold by the meter; max. quantity 1 000 m, minimum order 20 m

**6XV1840-2AH10**

###### IE FC RJ45 Plug 180 2 x 2

RJ45 plug-in connector for Industrial Ethernet with a rugged metal enclosure and integrated insulation displacement contacts for connecting Industrial Ethernet FC installation cables; with 180° cable outlet; for network components and CPs/CPU's with Industrial Ethernet interface

- 1 pack = 1 unit
- 1 pack = 10 units
- 1 pack = 50 units

**6GK1901-1BB10-2AA0**

**6GK1901-1BB10-2AB0**

**6GK1901-1BB10-2AE0**

###### IE FC stripping tool

Preadjusted stripping tool for fast stripping of the Industrial Ethernet FC cables

**6GK1901-1GA00**

###### SITOP compact 24 V/ 0.6 A

1-phase power supply with wide-range input 85 – 264 V AC/110 – 300 V DC, stabilized output voltage 24 V, rated output current value 0.6 A, slim design

**6EP1331-5BA00**

###### C-PLUG

Swap medium for simple replacement of devices in the event of a fault; for storing configuration or engineering and application data; can be used for SIMATIC NET products with C-PLUG slot

**6GK1900-0AB00**

##### More information

###### Selection tool:

To assist in selecting the right Industrial Ethernet switches as well as configuration of modular variants, the SIMATIC NET Selection Tool and the TIA Selection Tool are available at:

SIMATIC NET Selection Tool:

- Online version:  
<http://www.siemens.com/snst>
- Offline version:  
<http://www.siemens.com/snst-download>

TIA Selection Tool:

<http://www.siemens.com/tia-selection-tool>

**Overview**



SCALANCE X-300	Type of device	Hardware																
		Connection to S7 backplane bus	Format module S7	PC module	Flat type of construction	Box type of construction	19" type of construction	Rugged, compact housing	Modular design	10 Gigabit Ethernet	Gigabit Ethernet	PoE (Power over Ethernet)	LED diagnosis	SIMATIC environment	Redundant power supply (2 x 24 V DC)	External supply for integrated switch	Signal contact	Local display (SET pushbutton)
X302-7EEC							•			•		•	•	•		•	•	•
X304-2FE							•					•	•	•		•	•	•
X306-1LD FE							•					•	•	•		•	•	•
X307-2EEC							•			•		•	•	•		•	•	•
X307-3							•			•		•	•	•		•	•	•
X307-3LD							•			•		•	•	•		•	•	•
X308-2							•			•		•	•	•		•	•	•
X308-2LD							•			•		•	•	•		•	•	•
X308-2LH							•			•		•	•	•		•	•	•
X308-2LH+							•			•		•	•	•		•	•	•
X308-2M							•	•		•		•	•	•		•	•	•
X308-2M PoE							•	•		•	•	•	•	•		•	•	•
X308-2M TS							•	•		•		•	•	•		•	•	•
X310							•			•		•	•	•		•	•	•
X310FE							•					•	•	•		•	•	•
X320-1FE							•					•	•	•		•	•	•
X320-3LD FE							•					•	•	•		•	•	•
XR324-12M						•		•		•		•	•	•		•	•	•
XR324-4M PoE						•		•		•	•	•	•	•		•	•	•
XR324-4M EEC						•		•		•		•	•	•		•	•	•
XR324-4M PoE TS						•		•		•	•	•	•	•		•	•	•
XR324-12M TS						•		•		•		•	•	•		•	•	•

• applies

G\_IK10\_XX\_10310

Function overview SCALANCE X-300 managed: Hardware

# PROFINET/Industrial Ethernet

## Industrial Ethernet Switches

### SCALANCE X-300 managed

#### Overview (continued)

2

SCALANCE X-300	Type of device	Software																												
		Security Integrated (Firewall/VPN)	PROFINET diagnosis	Topology support (LLDP)	Command Line Interface / Telnet	Web based Management	Configuration with STEP 7 / TIA	SNMP	Ring redundancy incl. RM-functionality	Standby redundancy	IRT capability	VLAN (Virtual Local Area Network)	GVRP (Generic VLAN Registration Protocol)	STP/ RSTP (Spanning Tree Protocol/ Rapid Spanning Tree Protocol)	Passive Listening	IGMP Snooping/Querier (Internet Group Management Protocol)	GMRP (Generic Multicast Protocol)	Broadcast/ Multicast/ Unicast Limiter	Broadcast blocking	DHCP Option 82 (Dynamic Host Configuration Protocol)	Access Control List (IP)	Access Control List (MAC)	IEEE 802.1x (Radius)	Link Aggregation	Static Routing	RIPv2 (Dynamic Routing)	OSPFv2 (Dynamic Routing)	VRPP, Router Redundancy (Virtual Router Redundancy Protocol)		
X302-7EEC		•	•	•	•	•	•	•	•		•	•	•	•	•	•	•	•	•	•		•	•	•	•					
X304-2FE		•	•	•	•	•	•	•	•		•	•	•	•	•	•	•	•	•	•	•		•	•	•	•				
X306-1LD FE		•	•	•	•	•	•	•	•		•	•	•	•	•	•	•	•	•	•	•		•	•	•	•				
X307-2EEC		•	•	•	•	•	•	•	•		•	•	•	•	•	•	•	•	•	•	•		•	•	•	•				
X307-3		•	•	•	•	•	•	•	•		•	•	•	•	•	•	•	•	•	•	•		•	•	•	•				
X307-3LD		•	•	•	•	•	•	•	•		•	•	•	•	•	•	•	•	•	•	•		•	•	•	•				
X308-2		•	•	•	•	•	•	•	•		•	•	•	•	•	•	•	•	•	•	•		•	•	•	•				
X308-2LD		•	•	•	•	•	•	•	•		•	•	•	•	•	•	•	•	•	•	•		•	•	•	•				
X308-2LH		•	•	•	•	•	•	•	•		•	•	•	•	•	•	•	•	•	•	•		•	•	•	•				
X308-2LH+		•	•	•	•	•	•	•	•		•	•	•	•	•	•	•	•	•	•	•		•	•	•	•				
X308-2M		•	•	•	•	•	•	•	•		•	•	•	•	•	•	•	•	•	•	•		•	•	•	•				
X308-2M PoE		•	•	•	•	•	•	•	•		•	•	•	•	•	•	•	•	•	•	•		•	•	•	•				
X308-2M TS		•	•	•	•	•	•	•	•		•	•	•	•	•	•	•	•	•	•	•		•	•	•	•				
X310		•	•	•	•	•	•	•	•		•	•	•	•	•	•	•	•	•	•	•		•	•	•	•				
X310FE		•	•	•	•	•	•	•	•		•	•	•	•	•	•	•	•	•	•	•		•	•	•	•				
X320-1FE		•	•	•	•	•	•	•	•		•	•	•	•	•	•	•	•	•	•	•		•	•	•	•				
X320-3LD FE		•	•	•	•	•	•	•	•		•	•	•	•	•	•	•	•	•	•	•		•	•	•	•				
XR324-12M		•	•	•	•	•	•	•	•		•	•	•	•	•	•	•	•	•	•	•		•	•	•	•				
XR324-4M PoE		•	•	•	•	•	•	•	•		•	•	•	•	•	•	•	•	•	•	•		•	•	•	•				
XR324-4M EEC		•	•	•	•	•	•	•	•		•	•	•	•	•	•	•	•	•	•	•		•	•	•	•				
XR324-4M PoE TS		•	•	•	•	•	•	•	•		•	•	•	•	•	•	•	•	•	•	•		•	•	•	•				
XR324-12M TS		•	•	•	•	•	•	•	•		•	•	•	•	•	•	•	•	•	•	•		•	•	•	•				

• applies

G\_IK10\_XX\_10311

Function overview SCALANCE X-300 managed: Software

## Overview



The SCALANCE X-300 product line comprises compact Industrial Ethernet switches for constructing electrical and/or optical line, star and ring topologies operating at data transfer rates of 10/100/1 000 Mbit/s.

- SCALANCE X-300 is available
  - with integrated electrical and optical Ethernet ports
  - as a partially modular version with four integrated electrical Ethernet ports and two modular slots for 2-port media modules
- High-speed media redundancy through integral redundancy manager both for Gigabit Ethernet (SCALANCE X-300, X-400) and Fast Ethernet (e.g. in combination with SCALANCE X-200 switches)
- Seamless integration of automation networks into existing corporate networks thanks to support for a host of IT standards: Establishment of virtual networks (VLANs)
- Redundant integration into higher-level networks thanks to support for standardized redundancy procedures (Rapid Spanning Tree Protocol)
- PROFINET diagnostics, SNMP access, integrated web server and automatic e-mail transmission function for remote diagnostics and signaling via the network

## Benefits

g e t **get** Designed for Industry

- High availability of the network thanks to:
  - Redundant power supply
  - Redundant network structures based on fiber-optic or twisted pair cables (redundancy manager, standby function, and RSTP are integrated)
  - Easy device replacement by means of plug-in C-PLUG swap medium
  - Very fast reconfiguration of the network in the event of a fault
- Lower susceptibility to failure and higher availability of the plant networking due to latching of the RJ45 FastConnect connectors in the sleeve of the RJ45 ports
- Protection of investment due to integration into existing network management systems by means of standardized SNMP access
- Time savings during engineering, commissioning and in the operating phase of a plant by using the configuration and diagnostics integrated in STEP 7
- Simple adaptation to different network topologies, and reduction in stock keeping costs through flexibility of the partially modular versions

## PROFINET/Industrial Ethernet

### Industrial Ethernet Switches

#### SCALANCE X-300 managed

#### Application

SCALANCE X-300 products enable the establishment of switched networks both at the field level and at the control level where high data transfer rates are required in addition to high network availability and extensive diagnostics facilities. The switches are designed in degree of protection IP30 for installation in control cabinets.

The main area of application is found in high-performance plant networks with interfaces to the corporate network.

The X308-2M TS is suitable for use in railway applications due to its specification according to EN 50155.

#### Product versions

Switches with Fast Ethernet and Gigabit Ethernet ports

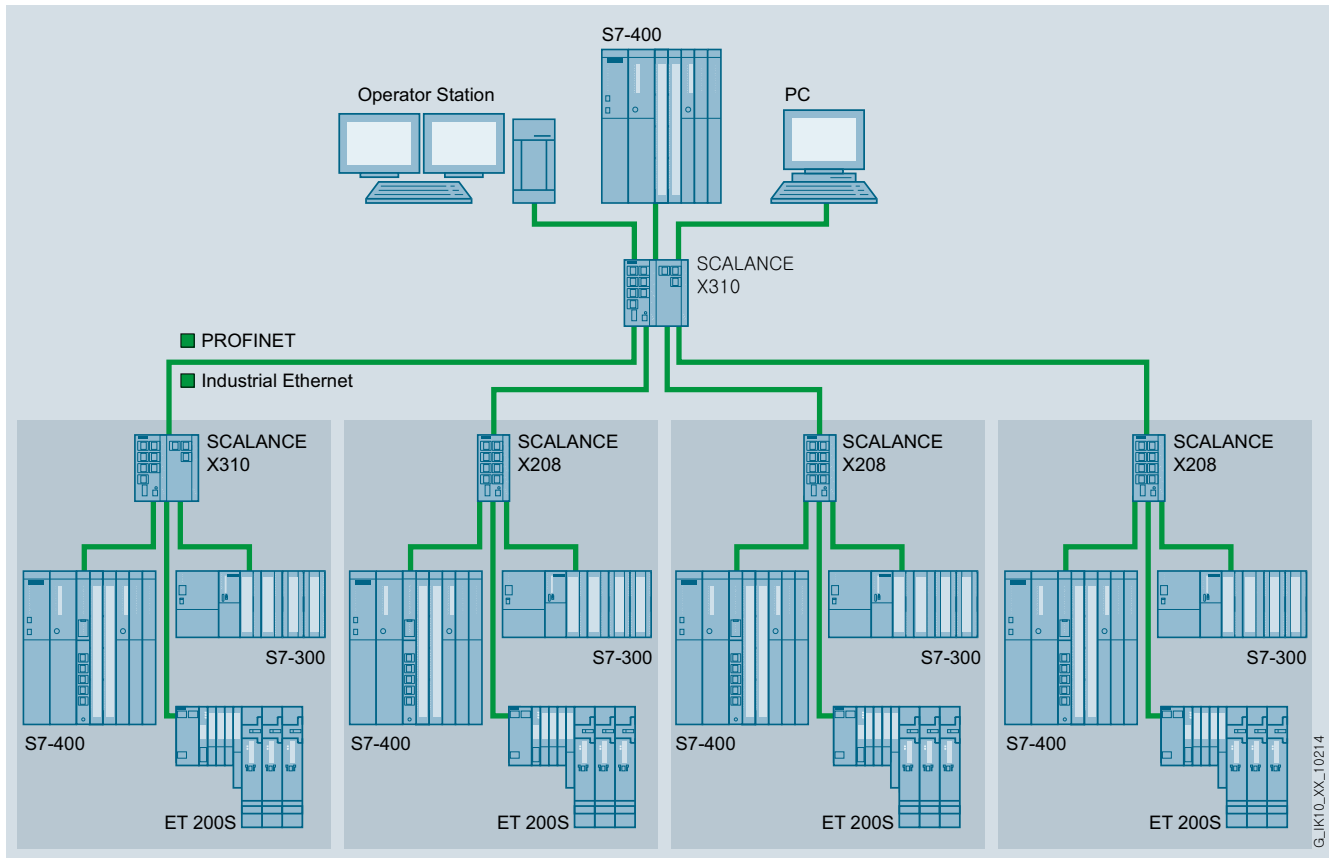

Electrical star topology with SCALANCE X310

#### **SCALANCE X310, SCALANCE X308-2, SCALANCE X308-2LD, SCALANCE X308-2LH, SCALANCE X308-2LH+, SCALANCE X307-3, SCALANCE X307-3LD**

- For configuring electrical Industrial Ethernet line, star or ring structures
  - **SCALANCE X310;**  
3 x 10/100/1 000 Mbit/s RJ45 ports, electrical  
7 x 10/100 Mbit/s RJ45 ports, electrical
  - **SCALANCE X308-2;**  
1 x 10/100/1 000 Mbit/s RJ45 ports, electrical  
7 x 10/100 Mbit/s RJ45 ports, electrical  
2 x 1 000 Mbit/s SC ports, optical, for glass FOC (multimode) up to 750 m
  - **SCALANCE X307-3;**  
7 x 10/100 Mbit/s RJ45 ports, electrical  
3 x 1 000 Mbit/s SC ports, optical, for glass FOC (multimode) up to 750 m
  - **SCALANCE X308-2LD;**  
1 x 10/100/1 000 Mbit/s RJ45 ports, electrical  
7 x 10/100 Mbit/s RJ45 ports, electrical  
2 x 1 000 Mbit/s SC ports, optical, for glass FOC (singlemode) up to 10 km

- **SCALANCE X307-3LD;**  
7 x 10/100 Mbit/s RJ45 ports, electrical  
3 x 1 000 Mbit/s SC ports, optical, for glass FOC (singlemode) up to 10 km
- **SCALANCE X308-2LH;**  
1 x 10/100/1 000 Mbit/s RJ45 ports, electrical  
7 x 10/100 Mbit/s RJ45 ports, electrical  
2 x 1 000 Mbit/s SC ports, optical, for glass FOC (singlemode) up to 40 km
- **SCALANCE X308-2LH+;**  
1 x 10/100/1 000 Mbit/s RJ45 ports, electrical  
7 x 10/100 Mbit/s RJ45 ports, electrical  
2 x 1 000 Mbit/s SC ports, optical, for glass FOC (singlemode) up to 70 km

- The RJ45 ports are designed to be industry-standard with additional holding collars for connection of the IE FC RJ45 Plug 180

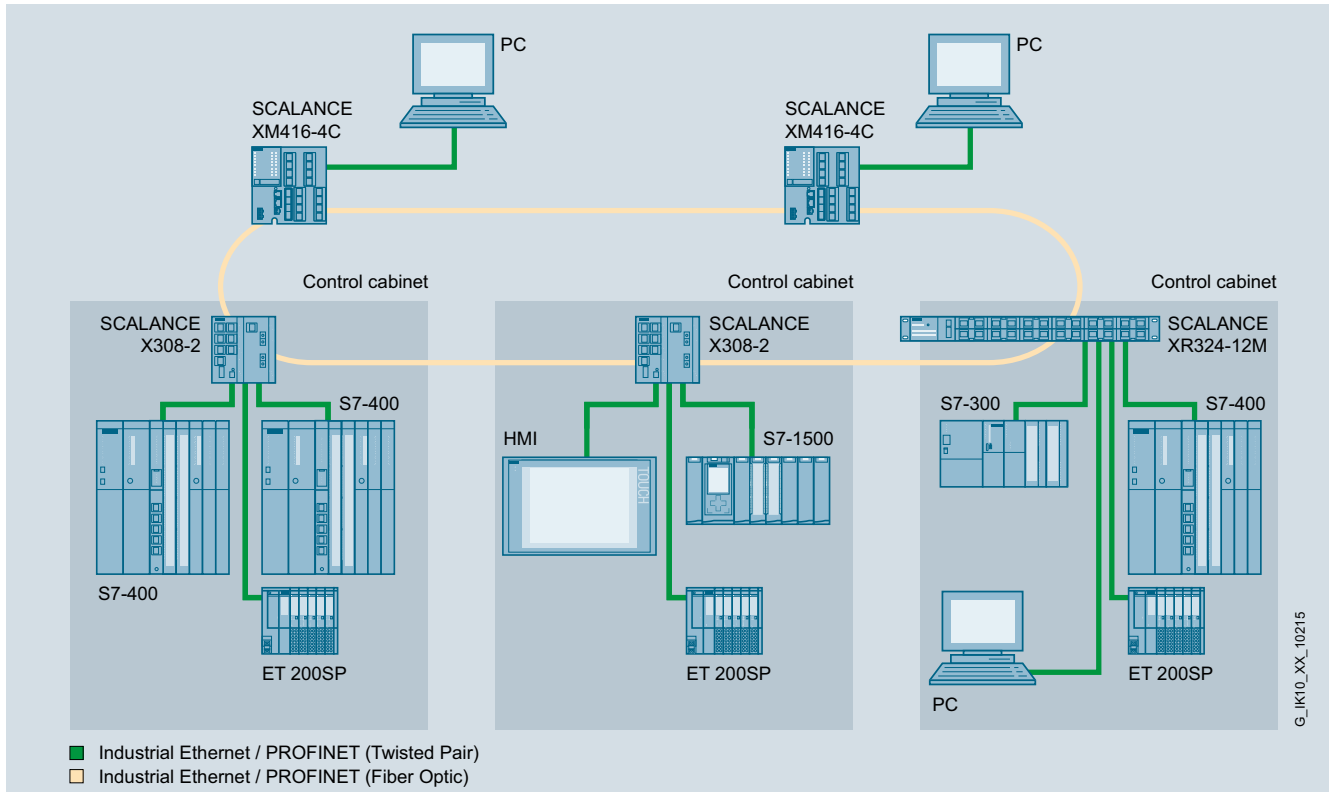
**Application** (continued)

Connection of control cabinets with SCALANCE X308-2 in an optical gigabit ring

**Fast Ethernet switches**

**SCALANCE X310FE**  
**SCALANCE X304-2FE**  
**SCALANCE X306-1LD FE**  
**SCALANCE X320-1FE**  
**SCALANCE X320-3 LD FE**

- For configuring electrical and/or optical Industrial Ethernet line, star or ring structures
  - **SCALANCE X310FE**;  
10 x 10/100 Mbit/s RJ45 ports, electrical
  - **SCALANCE X304-2FE**;  
4 x 10/100 Mbit/s RJ45 ports, electrical  
2 x 100 Mbit/s SC ports, optical, for glass FOC (multimode) up to 5 km
  - **SCALANCE X306-1LD FE**;  
6 x 10/100 Mbit/s RJ45 ports, electrical  
1 x 100 Mbit/s SC port, optical, for glass FOC (singlemode) up to 26 km
  - **SCALANCE X320-1FE**;  
20 x 10/100 Mbit/s RJ45 ports, electrical  
1 x 100 Mbit/s SC port, optical, for glass FOC (multimode) up to 5 km
  - **SCALANCE X320-3LD FE**;  
20 x 10/100 Mbit/s RJ45 ports, electrical  
1 x 100 Mbit/s SC port, optical, for glass FOC (multimode) up to 5 km  
2 x 100 Mbit/s SC ports, optical, for glass FOC (singlemode), up to 26 km
- The RJ45 ports are designed to be industry-standard with additional holding collars for connection of the IE FC RJ45 Plug 180

## PROFINET/Industrial Ethernet

### Industrial Ethernet Switches

#### SCALANCE X-300 managed

#### Application (continued)

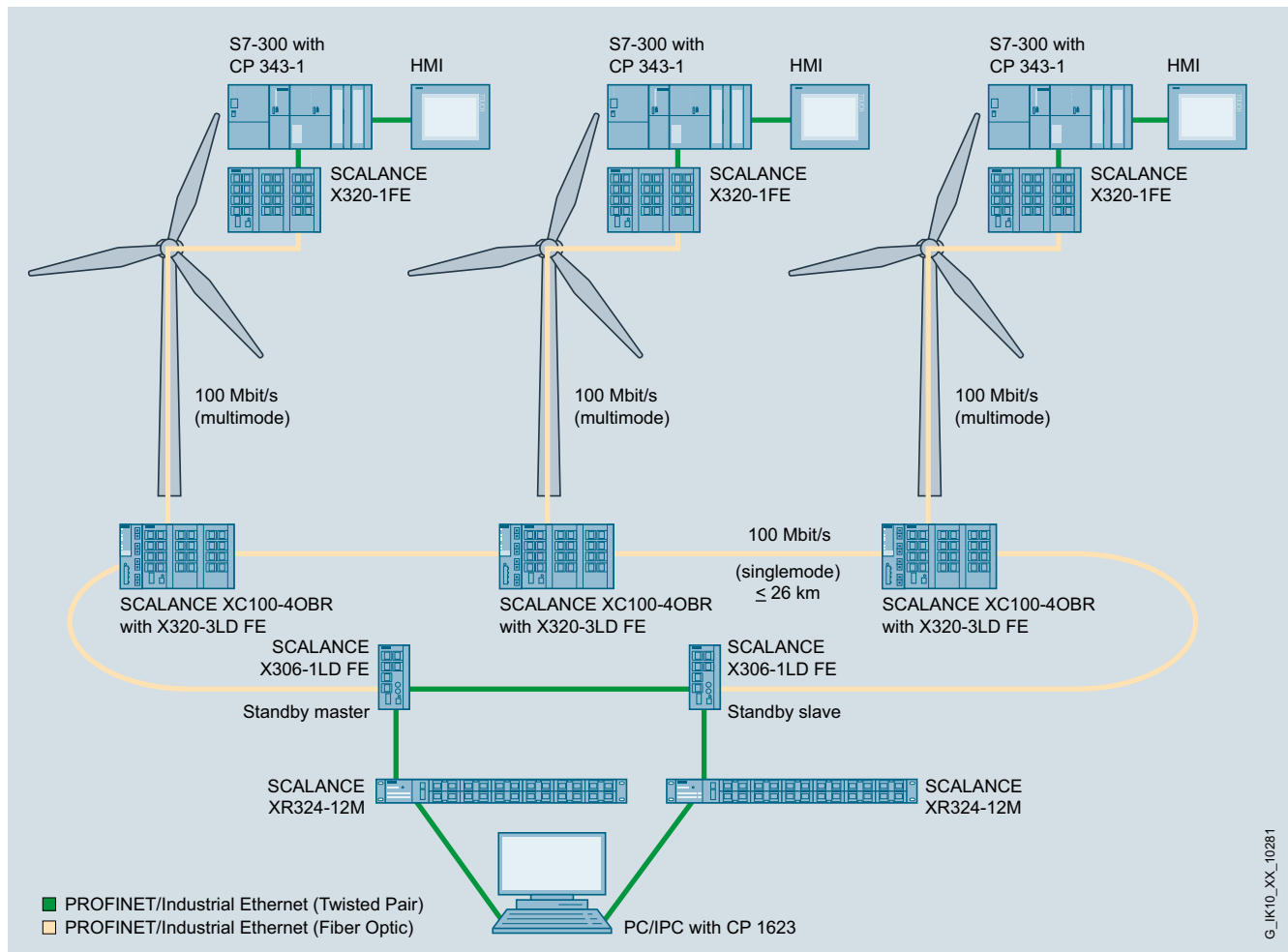

Redundant ring topology with SCALANCE X for wind farms

#### Full Gigabit switches

#### SCALANCE X308-2M SCALANCE X308-2M TS

- For setting up optical line, ring or star network structures with
  - Four integrated electrical Gigabit Ethernet ports and
  - Four modular slots for equipping with any 2-port media modules (see "Media modules for SCALANCE X-300")
- Star hubs in the plant bus (redundant connection possible)
- SCALANCE X308-2M;
  - 4 x 10/100/1 000 Mbit/s RJ45 ports, electrical
  - 2 x free module slots for 4 x 10/100/1 000 Mbit/s media modules (electrical or optical)
- SCALANCE X308-2M TS (TS = Transportation Systems);
  - 4 x 10/100/1 000 Mbit/s RJ45 ports, electrical
  - 2 x free module slots for 4 x 10/100/1 000 Mbit/s media modules (electrical or optical)
  - is suitable for use in railway applications due to its specification according to EN 50155



### Design

The SCALANCE X-300 Industrial Ethernet switches with rugged metal housing are optimized for mounting on a standard DIN rail and the S7-300 rail. Direct wall mounting in various positions is also possible. Thanks to the S7-300 housing dimensions, the devices are suitable for integration into an automation solution with S7-300 components.

The switches have:

- a 4-pin terminal block for connecting the redundant power supply (2 x 24 V DC)
- Row of LEDs for indicating the status information (power, link status, data traffic, fault, redundancy manager, standby manager)
- A 2-pin terminal block for connecting the isolated signaling contact
- SELECT/SET key for on-site configuration of the signaling contact
- Slot for optional C-PLUG swap medium on the rear of the device for easy replacement in the event of a fault

The SCALANCE X-300 switches are available with the following port types:

- **10/100BaseTX, RJ45 connection;**  
RJ45 socket, automatic detection of the data rate (10 or 100 Mbit/s), with Autosensing and Autocrossover function for the connection of IE FC cables via IE FC RJ45 Plug 180 to 100 m.
- **10/100/1000BaseTX, RJ45 connection;**  
RJ45 socket, automatic detection of the data rate (10 or 100 or 1 000 Mbit/s), with Autosensing and Autocrossover function for the connection of
  - IE FC cables 2x2 for 100 Mbit/s via IE FC RJ45 Plug 180 up to 100 m
  - IE FC cables 4x2 for 1 000 Mbit/s via TP Cord and IE FC RJ45 Modular Outlet up to 100 m
  - IE FC cables 4x2 for 1 000 Mbit/s via IE FC RJ45 Plug 4x2 up to 100 m
- **1000BaseSX, SC connections;**  
SC ports for direct connection to the Industrial Ethernet glass fiber-optic cable up to 750 m (multimode)
- **1000BaseSX, SC connections;**  
SC ports for direct connection to the Industrial Ethernet glass fiber-optic cable up to 10 km (singlemode)
- **1000BaseLX, SC connections;**  
SC ports for direct connection to the Industrial Ethernet glass fiber-optic cable up to 40 km (singlemode)
- **1000BaseLX, SC connections;**  
SC ports for direct connection to the Industrial Ethernet glass fiber-optic cable up to 70 km (singlemode)

### Function

- Increase of the network performance; by filtering the data traffic on the basis of the Ethernet (MAC) address of the data terminals, data traffic remains local; only data intended for users of another subnetwork is forwarded by the switch.
- Simple network configuration and network expansion; the switch saves the data received at the ports and forwards it automatically to the destination address. Collision detection (CSMA/CD method) does not restrict the expansion of the network beyond the port.
- Limitation of the error propagation to the affected subnetwork; the SCALANCE X-300 switches only forward data with a valid checksum (CRC).
- Integration of existing subnetworks with 10 Mbit/s into Fast Ethernet networks with 100 Mbit/s; at the twisted-pair ports, the SCALANCE X-300 switch automatically recognizes the conductor pairs for transmission and reception (Autocrossover), the data transfer rate of 10 or 100 or 1 000 Mbit/s, as well as full-duplex and half-duplex mode (Autonegotiation).
- High-performance connection of SCALANCE X-300 switches with 1 Gbit/s; SCALANCE X-300 switches have Gigabit Ethernet ports for connecting the switches to each other or with other Gigabit-Ethernet-enabled components (e.g. SCALANCE X-400, X-500)
- Integrated redundancy manager for constructing Fast Ethernet and Gigabit Ethernet ring topologies with high-speed media redundancy.
- High-speed standby redundancy; several network segments such as rings can be interconnected redundantly with SCALANCE X-300 by means of the integrated standby function. Two X-300 switches are configured in a ring as a master and slave and are connected via two links to the other ring. The redundant connection can be made at 1 000 Mbit/s.
- Redundant interfacing to higher-level networks; SCALANCE X-300 switches support the standardized redundancy procedures Spanning Tree Protocol (STP) and Rapid Spanning Tree Protocol (RSTP). This enables a subnetwork to be connected redundantly to a higher-level network with reduced requirements for the reconfiguration time (in the order of seconds). By supporting the Multiple Spanning Tree Protocol (MSTP), a network can also be split into multiple sub-segments.
- Support of virtual networks (VLAN); for structuring Industrial Ethernet networks with a fast growing number of users, a physically existing network can be divided into several virtual networks.
- Load limiting when multicast protocols (e.g. video transmission) are used; through learning the multicast sources and targets (IGMP Snooping, IGMP Querier), SCALANCE X-300 switches can also filter multicast data traffic and therefore limit the load in the network.
- Configuration of the ports for terminals that support authentication in accordance with IEEE 802.1x. Authentication is by means of a RADIUS server that must be configured appropriately and must be accessible via the network.
- Support of the DHCP Option 82, 66, 67 (Dynamic Host Configuration Protocol); this facilitates the IP address assignment of a terminal depending on the connected switch port. The IP address is assigned via a DHCP Server, which has to be configured accordingly and must be able to be reached via the network.

## PROFINET/Industrial Ethernet

### Industrial Ethernet Switches

#### SCALANCE X-300 managed

##### Function (continued)

- Support from the Access Control List (ACL); if this function is activated for one port, the switch forwards the message frames received to this port if its source address is present in the address table. All connected nodes can be automatically entered in the ACL.
- Syslog; Syslog compliant with RFC 3164 is used in the IP network for transmitting short, unencrypted text messages via UDP. This requires the use of a Syslog server that must be configured appropriately and must be accessible via the network.
- Time synchronization; diagnostic messages (log table entries, e-mails) are time-stamped. The local time is standardized throughout the network by means of synchronization with a SICLOCK time transmitter, SNTP or NTP server or via IEEE1588, thereby simplifying the assignment of diagnostic messages of several devices.
- Fast replacement of devices in event of failure, by means of the C-PLUG switching medium

##### Network topology and network configuration

The SCALANCE X-300 Industrial Ethernet switches with degree of protection IP30 are typically accommodated in a control cabinet along with the nodes to be connected. Electrical and optical versions can be installed together in star, line and ring topologies.

The following network structures and combinations of structures can be implemented:

- Fast Ethernet and Gigabit Ethernet rings with fast media redundancy; to increase network availability, as many as 50 X-200, X-300, X-400 or X-500 switches can be cascaded in line can be connected into a ring
- Several rings can be redundantly linked through the standby function
- At the same time, SCALANCE X-300 supports redundant connection of the ring structure to the corporate network with Rapid Spanning Tree.
- Star topology with SCALANCE X-300 switches: The SCALANCE X-300 switch represents a star point which can interconnect several nodes or subnets electrically or optically.

When configuring the network, it is necessary to observe the following boundary conditions:

- Maximum line length between two modules for multi-mode fiber-optic conductors:
  - 750 m at 1 Gbit/s
  - 5 km at 100 Mbit/s
- Maximum line length between two modules for single-mode fiber-optic conductors:
  - 10 to 70 km at 1 Gbit/s
  - 26 km at 100 Mbit/s
- Maximum cable length of the TP cable between two SCALANCE X switches:
  - Max. 100 m with IE FC cable 2x2 and IE FC RJ45 Plug 180
  - Max. 100 m at 1 Gbit/s with IE FC standard cable 4x2 (90 m), IE FC RJ45 modular outlet and patch cable (10 m)
  - Max. 10 m using patches with TP cord

##### Commissioning and diagnostics

Setting options on the device itself:

- Redundancy manager RM; to establish a ring, a SCALANCE X-300 is switched to RM mode. The Gigabit ports (electrical or optical) are preferably used as ring ports.
- Signal mask; the signal mask is set to the current status of the SCALANCE X-300 (setpoint) by pushbutton operation. The signal mask defines which ports and which power supplies are to be monitored. The signaling contact only reports an error when a monitored port or a monitored feeder fails (deviation of setpoint/actual status).
- IP address; the IP address is assigned via DHCP (Dynamic Host Configuration Protocol). If there is no corresponding server in the network, the IP address can be assigned using an enclosed software tool.

Diagnostic options on site:

- The following status information is displayed by LEDs on site:
  - Port status
  - Port mode (10/100/1 000 Mbit/s, full/half-duplex)
  - Status of the two power supplies
  - Signaling contact status
  - Signal mask (setpoint status)
  - RM mode
  - Standby mode
- The status of the signaling contact is routed externally by means of floating relay contacts. This enables, for example, the module to be monitored via an input module from a controller.
- Monitoring via the Industrial Ethernet network; the following possibilities are available:
  - Remote via standard browser (Web-based management): Selection of SCALANCE X-300 switches via the network from a PC with browser
  - Remote via SNMP V1, V2c, V3: Secure integration of SCALANCE X-300 switches via the network into a network management system, e.g. SINEMA Server
  - Remote via PROFINET IO diagnostics: PROFINET diagnostic alarms from SCALANCE X-300 switches can be displayed using the relevant SIMATIC engineering tools and they can also be processed in the controller. The engineering outlay for the PLC and HMI have been drastically reduced due to the complete integration in the SIMATIC concept for system error messages.

**Function** (continued)

**Network management**

The network management provides the following functions:

- Password-protected dial-up for "Administrator" (read and write authorization) and "User" (read only)
- Read-out of version and status information
- Setting the signal and standby mask and address information
- Fixed parameterization of the ports (data rates, half/full duplex)
- Setting parameters of the VLANs and multicast services
- Parameterization of the standby connections for a redundant ring link
- Setting of Rapid Spanning Tree parameters
- Parameterization of the web management services
- Security
  - Ports can be connected or disconnected
  - Authentication in accordance with IEEE 802.1x
  - Support from Access Control List (ACL)
- Parameterization of user administration of SNMP V1, V2c, V3
- Output of statistics information
- Diagnosis of data traffic by means of a parameterizable mirror port with a standard commercial network analyzer
- Loading of new firmware versions or of the configuration data via the network by a TFTP server or directly via HTTP/HTTPS using a Web browser
- Saving the configuration data or log table via the network on a TFTP server

If faults occur in the network, the SCALANCE X-300 switch can independently send error messages (traps) to a network management system or also e-mails to a predefined network administrator.

Remote monitoring (RMON) provides the following functions: The SCALANCE X-300 switch can collect statistics information according to the RMON groups 1 through 4. These include, for example, fault statistics that are kept for each port. This information can be read out through web-based management in the statistics sub-area.

**Technical specifications**

Article No.	6GK5304-2BD00-2AA3	6GK5306-1BF00-2AA3	6GK5307-3BL00-2AA3	6GK5307-3BM00-2AA3
Product-type designation	SCALANCE X304-2FE	SCALANCE X306-1LD FE	SCALANCE X307-3	SCALANCE X307-3LD
<b>Transmission rate</b>				
Transfer rate 1	10 Mbit/s	10 Mbit/s	10 Mbit/s	10 Mbit/s
Transfer rate 2	100 Mbit/s	100 Mbit/s	100 Mbit/s	100 Mbit/s
Transfer rate 3	-	-	1 000 Mbit/s	1 000 Mbit/s
<b>Interfaces</b>				
Number of electrical/optical connections for network components or terminal equipment maximum	6	7	10	10
Number of electrical connections				
• for network components and terminal equipment	4	6	7	7
• for operator console	-	-	-	-
• for signaling contact	1	1	1	1
• for media module	-	-	-	-
• for power supply	1	1	1	1
• for redundant power supply	2	2	2	2
Design of electrical connection				
• for network components and terminal equipment	RJ45 port	RJ45 port	RJ45 port	RJ45 port
• for operator console	-	-	-	-
• for signaling contact	2-pole terminal block	2-pole terminal block	2-pole terminal block	2-pole terminal block
• for power supply	4-pole terminal block	4-pole terminal block	4-pole terminal block	4-pole terminal block
Number of optical interfaces for optical waveguide				
• at 100 Mbit/s	2	1	-	-
• at 1 000 Mbit/s	-	-	3	3

# PROFINET/Industrial Ethernet

## Industrial Ethernet Switches

### SCALANCE X-300 managed

#### Technical specifications (continued)

Article No.	6GK5304-2BD00-2AA3	6GK5306-1BF00-2AA3	6GK5307-3BL00-2AA3	6GK5307-3BM00-2AA3
Product-type designation	SCALANCE X304-2FE	SCALANCE X306-1LD FE	SCALANCE X307-3	SCALANCE X307-3LD
Design of optical interface for optical waveguide				
• at 100 Mbit/s	SC port (multimode up to 5 km)	SC port (singlemode up to 26 km)	-	-
• at 1 000 Mbit/s	-	-	SC port (multimode up to 0.75 km)	SC port (singlemode up to 10 km)
Connectable optical power relative to 1 mW				
• of the transmitter output	-19 ... -14 dB	-15 ... -8 dB	-9.5 ... -4 dB	-9.5 ... -3 dB
• of the receiver input maximum	-3 dB	-3 dB	-3 dB	-3 dB
Optical sensitivity relative to 1 mW of the receiver input minimum	-32 dB	-34 dB	-17 dB	-21 dB
Attenuation of fiber-optic cable transmission link minimum necessary	0 dB	0 dB	0 dB	0 dB
Range at the optical interface depending on the optical fiber used	0 ... 5 km	0 ... 26 km	0 ... 0.75 km	0 ... 10 km
Design of the removable storage C-PLUG	Yes	Yes	Yes	Yes
<b>Signal-Inputs/outputs</b>				
Operating voltage of signaling contacts at DC rated value	24 V	24 V	24 V	24 V
Operating current of signaling contacts at DC maximum	0.1 A	0,1 A	0.1 A	0.1 A
<b>Supply voltage, current consumption, power loss</b>				
Type of supply voltage redundant power supply unit	No	No	No	No
Type of supply voltage	DC	DC	DC	DC
Supply voltage external	24 V	24 V	24 V	24 V
• minimum	18 V	18 V	18 V	18 V
• maximum	32 V	32 V	32 V	32 V
Product component fusing at power supply input	Yes	Yes	Yes	Yes
Type of fusing at input for supply voltage	F 3 A / 32 V	F 3 A / 32 V	F 3 A / 32 V	F 3 A / 32 V
Consumed current maximum	0.26 A	0.2 A	0.4 A	0.4 A
Active power loss				
• at 24 V for DC	6.2 W	4.8 W	9.6 W	9.6 W
<b>Permitted ambient conditions</b>				
Ambient temperature				
• during operating	-40 ... +60 °C	-40 ... +60 °C	-10 ... +60 °C	-40 ... +60 °C
• during storage	-40 ... +70 °C	-40 ... +70 °C	-40 ... +70 °C	-40 ... +70 °C
• during transport	-40 ... +70 °C	-40 ... +70 °C	-40 ... +70 °C	-40 ... +70 °C
Relative humidity at 25 °C without condensation during operating maximum	95 %	95 %	95 %	95 %
Protection class IP	IP30	IP30	IP30	IP30
<b>Design, dimensions and weight</b>				
Design	compact	compact	compact	compact
Width	60 mm	60 mm	120 mm	120 mm
Height	125 mm	125 mm	125 mm	125 mm
Depth	123 mm	123 mm	123 mm	123 mm
Net weight	0.7 kg	0.7 kg	1.4 kg	1.4 kg
Mounting type				
• 19-inch installation	No	No	No	No
• 35 mm DIN rail mounting	Yes	Yes	Yes	Yes
• wall mounting	Yes	Yes	Yes	Yes
• S7-300 rail mounting	Yes	Yes	Yes	Yes
Mounting type	When used in shipbuilding, installation on a 35 mm standard mounting rail is not permitted.	When used in shipbuilding, installation on a 35 mm standard mounting rail is not permitted.	When used in shipbuilding, installation on a 35 mm standard mounting rail is not permitted.	When used in shipbuilding, installation on a 35 mm standard mounting rail is not permitted.

**Technical specifications (continued)**

Article No.	6GK5304-2BD00-2AA3	6GK5306-1BF00-2AA3	6GK5307-3BL00-2AA3	6GK5307-3BM00-2AA3
Product-type designation	SCALANCE X304-2FE	SCALANCE X306-1LD FE	SCALANCE X307-3	SCALANCE X307-3LD
<b>Product properties, functions, components general</b>				
Cascading in the case of a redundant ring at reconfiguration time of < 0.3 s	50	50	50	50
Cascading in cases of star structuring	Any (depending only on signal propagation time)	Any (depending only on signal propagation time)	Any (depending only on signal propagation time)	Any (depending only on signal propagation time)
<b>Product functions management, configuration</b>				
Product function				
• CLI	Yes	Yes	Yes	Yes
• web-based management	Yes	Yes	Yes	Yes
• MIB support	Yes	Yes	Yes	Yes
• TRAPs via email	Yes	Yes	Yes	Yes
• Configuration with STEP 7	Yes	Yes	Yes	Yes
• RMON	Yes	Yes	Yes	Yes
• Port mirroring	Yes	Yes	Yes	Yes
• CoS	Yes	Yes	Yes	Yes
• PROFINET IO diagnosis	Yes	Yes	Yes	Yes
• switch-managed	Yes	Yes	Yes	Yes
Protocol is supported				
• Telnet	Yes	Yes	Yes	Yes
• HTTP	Yes	Yes	Yes	Yes
• HTTPS	Yes	Yes	Yes	Yes
• TFTP	Yes	Yes	Yes	Yes
• FTP	Yes	Yes	Yes	Yes
• BOOTP	Yes	Yes	Yes	Yes
• SNMP v1	Yes	Yes	Yes	Yes
• SNMP v2	Yes	Yes	Yes	Yes
• SNMP v3	Yes	Yes	Yes	Yes
• IGMP (snooping/querier)	Yes	Yes	Yes	Yes
• GMRP	Yes	Yes	Yes	Yes
• DCP	Yes	Yes	Yes	Yes
• LLDP	Yes	Yes	Yes	Yes
Identification & maintenance function				
• I&M0 - device-specific information	Yes	Yes	Yes	Yes
• I&M1 - higher level designation/location designation	Yes	Yes	Yes	Yes
<b>Product functions Diagnosis</b>				
Product function				
• Port diagnostics	Yes	Yes	Yes	Yes
• Statistics packet size	Yes	Yes	Yes	Yes
• Statistics packet type	Yes	Yes	Yes	Yes
• Error statistics	Yes	Yes	Yes	Yes
• SysLog	Yes	Yes	Yes	Yes
<b>Product functions VLAN</b>				
Product function				
• VLAN - port based	Yes	Yes	Yes	Yes
• VLAN dynamic	Yes	Yes	Yes	Yes
Number of VLANs maximum	255	255	255	255
Number of VLANs - dynamic maximum	255	255	255	255
Protocol is supported GVRP	Yes	Yes	Yes	Yes
<b>Product functions DHCP</b>				
Product function				
• DHCP client	Yes	Yes	Yes	Yes
• DHCP Option 82	Yes	Yes	Yes	Yes
• DHCP Option 66	Yes	Yes	Yes	Yes
• DHCP Option 67	Yes	Yes	Yes	Yes

# PROFINET/Industrial Ethernet

## Industrial Ethernet Switches

### SCALANCE X-300 managed

#### Technical specifications (continued)

Article No.	6GK5304-2BD00-2AA3	6GK5306-1BF00-2AA3	6GK5307-3BL00-2AA3	6GK5307-3BM00-2AA3
Product-type designation	SCALANCE X304-2FE	SCALANCE X306-1LD FE	SCALANCE X307-3	SCALANCE X307-3LD
<b>Product functions Redundancy</b>				
Product function				
• Ring redundancy	Yes	Yes	Yes	Yes
• Redundancy manager	Yes	Yes	Yes	Yes
• Standby redundancy	Yes	Yes	Yes	Yes
• High Speed Redundancy Protocol (HRP)	Yes	Yes	Yes	Yes
• Media Redundancy Protocol (MRP)	Yes	Yes	Yes	Yes
• redundancy procedure STP	Yes	Yes	Yes	Yes
• RSTP redundancy protocol	Yes	Yes	Yes	Yes
• redundancy procedure MSTP	Yes	Yes	Yes	Yes
• Passive listening	Yes	Yes	Yes	Yes
Protocol is supported				
• STP/RSTP	Yes	Yes	Yes	Yes
• STP	Yes	Yes	Yes	Yes
• RSTP	Yes	Yes	Yes	Yes
• RSTP big network support	Yes	Yes	Yes	Yes
• LACP	Yes	Yes	Yes	Yes
<b>Product functions Security</b>				
Product function				
• ACL - port/MAC-based	Yes	Yes	Yes	Yes
• IEEE 802.1x (radius)	Yes	Yes	Yes	Yes
• Broadcast/Multicast/Unicast Limiter	Yes	Yes	Yes	Yes
• broadcast blocking	Yes	Yes	Yes	Yes
Protocol is supported SSH	Yes	Yes	Yes	Yes
<b>Product functions Time</b>				
Product function SICLOCK support	Yes	Yes	Yes	Yes
Protocol is supported				
• NTP	Yes	Yes	Yes	Yes
• SNTP	Yes	Yes	Yes	Yes
• MSTP	No	No	No	No
• IEEE 1588 profile default	No	No	No	No
<b>Standards, specifications, approvals</b>				
Standard				
• for EMC from FM	FM3611: Class 1, Division 2, Group A, B, C, D / T4, Class 1, Zone 2, Group IIC, T4	FM3611: Class 1, Division 2, Group A, B, C, D / T4, Class 1, Zone 2, Group IIC, T4	FM3611: Class 1, Division 2, Group A, B, C, D / T4, Class 1, Zone 2, Group IIC, T4	FM3611: Class 1, Division 2, Group A, B, C, D / T4, Class 1, Zone 2, Group IIC, T4
• for hazardous zone	EN 60079-0 : 2006, EN 60079-15: 2005, II 3 G Ex nA II T4 KEMA 07 ATEX 0145X	EN 60079-0 : 2006, EN 60079-15: 2005, II 3 G Ex nA II T4 KEMA 07 ATEX 0145X	EN 60079-0 : 2006, EN 60079-15: 2005, II 3 G Ex nA II T4 KEMA 07 ATEX 0145X	EN 60079-0 : 2006, EN 60079-15: 2005, II 3 G Ex nA II T4 KEMA 07 ATEX 0145X
• for safety of CSA and UL	UL 60950-1, CSA C22.2 No. 60950-1	UL 60950-1, CSA C22.2 No. 60950-1	UL 60950-1, CSA C22.2 No. 60950-1	UL 60950-1, CSA C22.2 No. 60950-1
• for hazardous area of CSA and UL	UL 1604 and UL 2279-15 (Hazardous Location), CSA C22.2 No. 213-M1987, Class 1 / Division 2 / Group A, B, C, D / T4, Class 1 / Zone 2 / Group IIC / T4	UL 1604 and UL 2279-15 (Hazardous Location), CSA C22.2 No. 213-M1987, Class 1 / Division 2 / Group A, B, C, D / T4, Class 1 / Zone 2 / Group IIC / T4	UL 1604 and UL 2279-15 (Hazardous Location), CSA C22.2 No. 213-M1987, Class 1 / Division 2 / Group A, B, C, D / T4, Class 1 / Zone 2 / Group IIC / T4	UL 1604 and UL 2279-15 (Hazardous Location), CSA C22.2 No. 213-M1987, Class 1 / Division 2 / Group A, B, C, D / T4, Class 1 / Zone 2 / Group IIC / T4
• for emitted interference	EN 61000-6-4:2007 (Class A)	EN 61000-6-4:2007 (Class A)	EN 61000-6-4:2007 (Class A)	EN 61000-6-4:2007 (Class A)
• for interference immunity	EN 61000-6-2:2005	EN 61000-6-2:2005	EN 61000-6-2:2005	EN 61000-6-2:2005
Verification of suitability	EN 61000-6-2:2005, EN 61000-6-4:2007	EN 61000-6-2:2005, EN 61000-6-4:2007	EN 61000-6-2:2005, EN 61000-6-4:2007	EN 61000-6-2:2005, EN 61000-6-4:2007
• CE mark	Yes	Yes	Yes	Yes
• C-Tick	Yes	Yes	Yes	Yes
• KC approval	Yes	Yes	Yes	Yes
• Railway application in accordance with EN 50155	No	No	No	No
Marine classification association				
• American Bureau of Shipping Europe Ltd. (ABS)	-	-	Yes	Yes
• Bureau Veritas (BV)	-	-	Yes	Yes
• Det Norske Veritas (DNV)	-	-	Yes	Yes
• Germanische Lloyd (GL)	-	-	Yes	Yes
• Lloyds Register of Shipping (LRS)	-	-	Yes	Yes
• Nippon Kaiji Kyokai (NK)	-	-	Yes	Yes

**Technical specifications (continued)**

Article No.	6GK5308-2FL00-2AA3	6GK5308-2FM00-2AA3	6GK5308-2FN00-2AA3	6GK5308-2FP00-2AA3
Product-type designation	SCALANCE X308-2	SCALANCE X308-2LD	SCALANCE X308-2LH	SCALANCE X308-2LH+
<b>Transmission rate</b>				
Transfer rate 1	10 Mbit/s	10 Mbit/s	10 Mbit/s	10 Mbit/s
Transfer rate 2	100 Mbit/s	100 Mbit/s	100 Mbit/s	100 Mbit/s
Transfer rate 3	1 000 Mbit/s	1 000 Mbit/s	1 000 Mbit/s	1 000 Mbit/s
<b>Interfaces</b>				
Number of electrical/optical connections for network components or terminal equipment maximum	10	10	10	10
Number of electrical connections				
• for network components and terminal equipment	8	8	8	8
• for signaling contact	1	1	1	1
• for power supply	1	1	1	1
• for redundant power supply	2	2	2	2
Design of electrical connection				
• for network components and terminal equipment	RJ45 port (1 x 1GE, 7 x FE)	RJ45 port (1 x 1GE, 7 x FE)	RJ45 port (1 x 1GE, 7 x FE)	RJ45 port (1 x 1GE, 7 x FE)
• for signaling contact	2-pole terminal block	2-pole terminal block	2-pole terminal block	2-pole terminal block
• for power supply	4-pole terminal block	4-pole terminal block	4-pole terminal block	4-pole terminal block
Number of optical interfaces for optical waveguide				
• at 1 000 Mbit/s	2	2	2	2
Design of optical interface for optical waveguide				
• at 1 000 Mbit/s	SC port (multimode up to 0.75 km)	SC port (singlemode up to 10 km)	SC port (singlemode up to 40 km)	SC port (singlemode up to 70 km)
Connectable optical power relative to 1 mW				
• of the transmitter output	-9.5 ... -4 dB	-9.5 ... -3 dB	-6 ... +0 dB	0 ... 5 dB
• of the receiver input maximum	-3 dB	-3 dB	-3 dB	-3 dB
Optical sensitivity relative to 1 mW of the receiver input minimum	-17 dB	-21 dB	-23 dB	-23 dB
Attenuation of fiber-optic cable transmission link minimum necessary	0 dB	0 dB	3 dB	8 dB
Range at the optical interface depending on the optical fiber used	0 ... 0.75 km	0 ... 10 km	8 ... 40 km	30 ... 70 km
Design of the removable storage C-PLUG	Yes	Yes	Yes	Yes
<b>Signal-Inputs/outputs</b>				
Operating voltage of signaling contacts at DC rated value	24 V	24 V	24 V	24 V
Operating current of signaling contacts at DC maximum	0.1 A	0.1 A	0.1 A	0.1 A
<b>Supply voltage, current consumption, power loss</b>				
Type of supply voltage redundant power supply unit	No	No	No	No
Type of supply voltage	DC	DC	DC	DC
Supply voltage external	24 V	24 V	24 V	24 V
• minimum	18 V	18 V	18 V	18 V
• maximum	32 V	32 V	32 V	32 V
Product component fusing at power supply input	Yes	Yes	Yes	Yes
Type of fusing at input for supply voltage	F 3 A / 32 V	F 3 A / 32 V	F 3 A / 32 V	F 3 A / 32 V
Consumed current maximum	0.4 A	0.4 A	0.4 A	0.4 A
Active power loss				
• at 24 V for DC	9.6 W	9.6 W	9.6 W	9.6 W

# PROFINET/Industrial Ethernet

## Industrial Ethernet Switches

### SCALANCE X-300 managed

#### Technical specifications (continued)

Article No.	6GK5308-2FL00-2AA3	6GK5308-2FM00-2AA3	6GK5308-2FN00-2AA3	6GK5308-2FP00-2AA3
Product-type designation	SCALANCE X308-2	SCALANCE X308-2LD	SCALANCE X308-2LH	SCALANCE X308-2LH+
<b>Permitted ambient conditions</b>				
Ambient temperature				
• during operating	-10 ... +60 °C	-40 ... +60 °C	-40 ... +60 °C	-40 ... +60 °C
• during storage	-40 ... +70 °C	-40 ... +70 °C	-40 ... +70 °C	-40 ... +70 °C
• during transport	-40 ... +70 °C	-40 ... +70 °C	-40 ... +70 °C	-40 ... +70 °C
Relative humidity at 25 °C without condensation during operating maximum	95 %	95 %	95 %	95 %
Protection class IP	IP30	IP30	IP30	IP30
<b>Design, dimensions and weight</b>				
Design	compact	compact	compact	compact
Width	120 mm	120 mm	120 mm	120 mm
Height	125 mm	125 mm	125 mm	125 mm
Depth	123 mm	123 mm	123 mm	123 mm
Net weight	1.4 kg	1.4 kg	1.4 kg	1.4 kg
Mounting type				
• 19-inch installation	No	No	No	No
• 35 mm DIN rail mounting	Yes	Yes	Yes	Yes
• wall mounting	Yes	Yes	Yes	Yes
• S7-300 rail mounting	Yes	Yes	Yes	Yes
Mounting type	When used in shipbuilding, installation on a 35 mm standard mounting rail is not permitted.	When used in shipbuilding, installation on a 35 mm standard mounting rail is not permitted.	When used in shipbuilding, installation on a 35 mm standard mounting rail is not permitted.	When used in shipbuilding, installation on a 35 mm standard mounting rail is not permitted.
<b>Product properties, functions, components general</b>				
Cascading in the case of a redundant ring at reconfiguration time of < 0.3 s	50	50	50	50
Cascading in cases of star structuring	Any (depending only on signal propagation time)	Any (depending only on signal propagation time)	Any (depending only on signal propagation time)	Any (depending only on signal propagation time)
<b>Product functions management, configuration</b>				
Product function				
• CLI	Yes	Yes	Yes	Yes
• web-based management	Yes	Yes	Yes	Yes
• MIB support	Yes	Yes	Yes	Yes
• TRAPs via email	Yes	Yes	Yes	Yes
• Configuration with STEP 7	Yes	Yes	Yes	Yes
• RMON	Yes	Yes	Yes	Yes
• SMTP server	-	-	-	-
• Port mirroring	Yes	Yes	Yes	Yes
• CoS	Yes	Yes	Yes	Yes
• for IRT PROFINET IO switch	-	-	-	-
• PROFINET IO diagnosis	Yes	Yes	Yes	Yes
• switch-managed	Yes	Yes	Yes	Yes
Protocol is supported				
• Telnet	Yes	Yes	Yes	Yes
• HTTP	Yes	Yes	Yes	Yes
• HTTPS	Yes	Yes	Yes	Yes
• TFTP	Yes	Yes	Yes	Yes
• FTP	Yes	Yes	Yes	Yes
• BOOTP	Yes	Yes	Yes	Yes
• SNMP v1	Yes	Yes	Yes	Yes
• SNMP v2	Yes	Yes	Yes	Yes
• SNMP v3	Yes	Yes	Yes	Yes
• IGMP (snooping/querier)	Yes	Yes	Yes	Yes
• GMRP	Yes	Yes	Yes	Yes
• DCP	Yes	Yes	Yes	Yes
• LLDP	Yes	Yes	Yes	Yes
Identification & maintenance function				
• I&M0 - device-specific information	Yes	Yes	Yes	Yes
• I&M1 - higher level designation/location designation	Yes	Yes	Yes	Yes



**Technical specifications (continued)**

Article No.	6GK5308-2FL00-2AA3	6GK5308-2FM00-2AA3	6GK5308-2FN00-2AA3	6GK5308-2FP00-2AA3
Product-type designation	SCALANCE X308-2	SCALANCE X308-2LD	SCALANCE X308-2LH	SCALANCE X308-2LH+
<b>Product functions Diagnosis</b>				
Product function				
• Port diagnostics	Yes	Yes	Yes	Yes
• Statistics packet size	Yes	Yes	Yes	Yes
• Statistics packet type	Yes	Yes	Yes	Yes
• Error statistics	Yes	Yes	Yes	Yes
• SysLog	Yes	Yes	Yes	Yes
<b>Product functions VLAN</b>				
Product function				
• VLAN - port based	Yes	Yes	Yes	Yes
• VLAN dynamic	Yes	Yes	Yes	Yes
Number of VLANs maximum	255	255	255	255
Number of VLANs - dynamic maximum	255	255	255	255
Protocol is supported GVRP	Yes	Yes	Yes	Yes
<b>Product functions DHCP</b>				
Product function				
• DHCP client	Yes	Yes	Yes	Yes
• DHCP Option 82	Yes	Yes	Yes	Yes
• DHCP Option 66	Yes	Yes	Yes	Yes
• DHCP Option 67	Yes	Yes	Yes	Yes
<b>Product functions Redundancy</b>				
Product function				
• Ring redundancy	Yes	Yes	Yes	Yes
• Redundancy manager	Yes	Yes	Yes	Yes
• Standby redundancy	Yes	Yes	Yes	Yes
• High Speed Redundancy Protocol (HRP)	Yes	Yes	Yes	Yes
• Media Redundancy Protocol (MRP)	Yes	Yes	Yes	Yes
• redundancy procedure STP	Yes	Yes	Yes	Yes
• RSTP redundancy protocol	Yes	Yes	Yes	Yes
• redundancy procedure MSTP	Yes	Yes	Yes	Yes
• Passive listening	Yes	Yes	Yes	Yes
Protocol is supported				
• STP/RSTP	Yes	Yes	Yes	Yes
• STP	Yes	Yes	Yes	Yes
• RSTP	Yes	Yes	Yes	Yes
• RSTP big network support	Yes	Yes	Yes	Yes
• LACP	Yes	Yes	Yes	Yes
<b>Product functions Security</b>				
Product function				
• ACL - port/MAC-based	Yes	Yes	Yes	Yes
• IEEE 802.1x (radius)	Yes	Yes	Yes	Yes
• Broadcast/Multicast/Unicast Limiter	Yes	Yes	Yes	Yes
• broadcast blocking	Yes	Yes	Yes	Yes
Protocol is supported SSH	Yes	Yes	Yes	Yes
<b>Product functions Time</b>				
Product function SICLOCK support	Yes	Yes	Yes	Yes
Protocol is supported				
• NTP	Yes	Yes	Yes	Yes
• SNTP	Yes	Yes	Yes	Yes
• IEEE 1588 profile default	No	No	No	No

## PROFINET/Industrial Ethernet

### Industrial Ethernet Switches

#### SCALANCE X-300 managed

#### Technical specifications (continued)

Article No.	6GK5308-2FL00-2AA3	6GK5308-2FM00-2AA3	6GK5308-2FN00-2AA3	6GK5308-2FP00-2AA3
Product-type designation	SCALANCE X308-2	SCALANCE X308-2LD	SCALANCE X308-2LH	SCALANCE X308-2LH+
<b>Standards, specifications, approvals</b>				
Standard				
• for EMC from FM	FM3611: Class 1, Division 2, Group A, B, C, D / T4, Class 1, Zone 2, Group IIC, T4	FM3611: Class 1, Division 2, Group A, B, C, D / T4, Class 1, Zone 2, Group IIC, T4	FM3611: Class 1, Division 2, Group A, B, C, D / T4, Class 1, Zone 2, Group IIC, T4	FM3611: Class 1, Division 2, Group A, B, C, D / T4, Class 1, Zone 2, Group IIC, T4
• for hazardous zone	EN 60079-0 : 2006, EN 60079-15: 2005, II 3 G Ex nA II T4 KEMA 07 ATEX 0145X	EN 60079-0 : 2006, EN 60079-15: 2005, II 3 G Ex nA II T4 KEMA 07 ATEX 0145X	EN 60079-0 : 2006, EN 60079-15: 2005, II 3 G Ex nA II T4 KEMA 07 ATEX 0145X	EN 60079-0 : 2006, EN 60079-15: 2005, II 3 G Ex nA II T4 KEMA 07 ATEX 0145X
• for safety of CSA and UL	UL 60950-1, CSA C22.2 No. 60950-1	UL 60950-1, CSA C22.2 No. 60950-1	UL 60950-1, CSA C22.2 No. 60950-1	UL 60950-1, CSA C22.2 No. 60950-1
• for hazardous area of CSA and UL	UL 1604 and UL 2279-15 (Hazardous Location), CSA C22.2 No. 213-M1987, Class 1 / Division 2 / Group A, B, C, D / T4, Class 1 / Zone 2 / Group IIC / T4	UL 1604 and UL 2279-15 (Hazardous Location), CSA C22.2 No. 213-M1987, Class 1 / Division 2 / Group A, B, C, D / T4, Class 1 / Zone 2 / Group IIC / T4	UL 1604 and UL 2279-15 (Hazardous Location), CSA C22.2 No. 213-M1987, Class 1 / Division 2 / Group A, B, C, D / T4, Class 1 / Zone 2 / Group IIC / T4	UL 1604 and UL 2279-15 (Hazardous Location), CSA C22.2 No. 213-M1987, Class 1 / Division 2 / Group A, B, C, D / T4, Class 1 / Zone 2 / Group IIC / T4
• for emitted interference	EN 61000-6-4:2007 (Class A)	EN 61000-6-4:2007 (Class A)	EN 61000-6-4:2007 (Class A)	EN 61000-6-4:2007 (Class A)
• for interference immunity	EN 61000-6-2:2005	EN 61000-6-2:2005	EN 61000-6-2:2005	EN 61000-6-2:2005
Verification of suitability	EN 61000-6-2:2005, EN 61000-6-4:2007	EN 61000-6-2:2005, EN 61000-6-4:2007	EN 61000-6-2:2005, EN 61000-6-4:2007	EN 61000-6-2:2005, EN 61000-6-4:2007
• CE mark	Yes	Yes	Yes	Yes
• C-Tick	Yes	Yes	Yes	Yes
• KC approval	Yes	Yes	Yes	Yes
• Railway application in accordance with EN 50155	No	No	No	No
Marine classification association				
• American Bureau of Shipping Europe Ltd. (ABS)	Yes	Yes	Yes	Yes
• Bureau Veritas (BV)	Yes	Yes	Yes	Yes
• Det Norske Veritas (DNV)	Yes	Yes	Yes	Yes
• Germanische Lloyd (GL)	Yes	Yes	Yes	Yes
• Lloyds Register of Shipping (LRS)	Yes	Yes	Yes	Yes
• Nippon Kaiji Kyokai (NK)	Yes	Yes	Yes	Yes

**Technical specifications (continued)**

Article No.	6GK5310-0BA00-2AA3	6GK5310-0FA00-2AA3	6GK5320-1BD00-2AA3	6GK5320-3BF00-2AA3
Product type designation	SCALANCE X310FE	SCALANCE X310	SCALANCE X320-1FE	SCALANCE X320-3LD FE
<b>Transmission rate</b>				
Transfer rate 1	10 Mbit/s	10 Mbit/s	10 Mbit/s	10 Mbit/s
Transfer rate 2	100 Mbit/s	100 Mbit/s	100 Mbit/s	100 Mbit/s
Transfer rate 3	-	1 000 Mbit/s	-	-
<b>Interfaces</b>				
Number of electrical/optical connections for network components or terminal equipment maximum	10	10	21	23
Number of electrical connections	10	10	20	20
• for network components and terminal equipment				
• for signaling contact	1	1	1	1
• for media module	-	-	-	-
• for power supply	1	1	1	1
• for redundant power supply	2	2	2	2
Design of electrical connection				
• for network components and terminal equipment	RJ45 port	RJ45 port (3 x 1GE, 7 x FE)	RJ45 port	RJ45 port
• for signaling contact	2-pole terminal block	2-pole terminal block	2-pole terminal block	2-pole terminal block
• for power supply	4-pole terminal block	4-pole terminal block	4-pole terminal block	4-pole terminal block
Number of optical interfaces for optical waveguide				
• at 100 Mbit/s	-	-	1	3
Design of optical interface for optical waveguide				
• at 100 Mbit/s	-	-	SC port (multimode up to 5 km)	SC port (1 x multimode up to 5 km, 2 x singlemode up to 26 km)
Connectable optical power relative to 1 mW				
• of the transmitter output	-	-	-19 ... -14 dB	-15 ... -8 dB
• of the receiver input maximum	-	-	-3 dB	-3 dB
Optical sensitivity relative to 1 mW of the receiver input minimum	-	-	-32 dB	-34 dB
Attenuation of fiber-optic cable transmission link minimum necessary	-	-	0 dB	0 dB
Range at the optical interface depending on the optical fiber used	-	-	0 ... 5 km	0 ... 26 km
Design of the removable storage C-PLUG	Yes	Yes	Yes	Yes
<b>Signal-Inputs/outputs</b>				
Operating voltage of signaling contacts at DC rated value	24 V	24 V	24 V	24 V
Operating current of signaling contacts at DC maximum	0.1 A	0.1 A	0.1 A	0.1 A
<b>Supply voltage, current consumption, power loss</b>				
Type of supply voltage redundant power supply unit	No	No	No	No
Type of supply voltage	DC	DC	DC	DC
Supply voltage external	24 V	24 V	24 V	24 V
• minimum	18 V	18 V	18 V	18 V
• maximum	32 V	32 V	32 V	32 V
Product component fusing at power supply input	Yes	Yes	Yes	Yes
Type of fusing at input for supply voltage	F 3 A / 32 V	F 3 A / 32 V	F 3 A / 32 V	F 3 A / 32 V
Consumed current maximum	0.4 A	0.4 A	0.4 A	0.5 A
Active power loss				
• at 24 V for DC	9.6 W	9.6 W	9.6 W	12 W

## PROFINET/Industrial Ethernet

### Industrial Ethernet Switches

#### SCALANCE X-300 managed

#### Technical specifications (continued)

Article No.	6GK5310-0BA00-2AA3	6GK5310-0FA00-2AA3	6GK5320-1BD00-2AA3	6GK5320-3BF00-2AA3
Product type designation	SCALANCE X310FE	SCALANCE X310	SCALANCE X320-1FE	SCALANCE X320-3LD FE
<b>Permitted ambient conditions</b>				
Ambient temperature				
• during operating	-40 ... +60 °C	-40 ... +60 °C	-40 ... +60 °C	-40 ... +60 °C
• during storage	-40 ... +70 °C	-40 ... +70 °C	-40 ... +70 °C	-40 ... +70 °C
• during transport	-40 ... +70 °C	-40 ... +70 °C	-40 ... +70 °C	-40 ... +70 °C
Relative humidity at 25 °C without condensation during operating maximum	95 %	95 %	95 %	95 %
Protection class IP	IP30	IP30	IP30	IP30
<b>Design, dimensions and weight</b>				
Design	Compact	Compact	Compact	Compact
Width	120 mm	120 mm	180 mm	180 mm
Height	125 mm	125 mm	125 mm	125 mm
Depth	123 mm	123 mm	123 mm	123 mm
Net weight	1.4 kg	1.4 kg	1.65 kg	1.65 kg
Mounting type				
• 19-inch installation	No	No	No	No
• 35 mm DIN rail mounting	Yes	Yes	Yes	Yes
• wall mounting	Yes	Yes	Yes	Yes
• S7-300 rail mounting	Yes	Yes	Yes	Yes
Mounting type	When used in shipbuilding, installation on a 35 mm standard mounting rail is not permitted.	When used in shipbuilding, installation on a 35 mm standard mounting rail is not permitted.	When used in shipbuilding, installation on a 35 mm standard mounting rail is not permitted.	When used in shipbuilding, installation on a 35 mm standard mounting rail is not permitted.
<b>Product properties, functions, components general</b>				
Cascading in the case of a redundant ring at reconfiguration time of < 0.3 s	50	50	50	50
Cascading in cases of star structuring	Any (depending only on signal propagation time)	Any (depending only on signal propagation time)	Any (depending only on signal propagation time)	Any (depending only on signal propagation time)
<b>Product functions management, configuration</b>				
Product function				
• CLI	Yes	Yes	Yes	Yes
• web-based management	Yes	Yes	Yes	Yes
• MIB support	Yes	Yes	Yes	Yes
• TRAPs via email	Yes	Yes	Yes	Yes
• Configuration with STEP 7	Yes	Yes	Yes	Yes
• RMON	Yes	Yes	Yes	Yes
• SMTP server	-	-	-	-
• Port mirroring	Yes	Yes	Yes	Yes
• CoS	Yes	Yes	Yes	Yes
• PROFINET IO diagnosis	Yes	Yes	Yes	Yes
• switch-managed	Yes	Yes	Yes	Yes
Protocol is supported				
• Telnet	Yes	Yes	Yes	Yes
• HTTP	Yes	Yes	Yes	Yes
• HTTPS	Yes	Yes	Yes	Yes
• TFTP	Yes	Yes	Yes	Yes
• FTP	Yes	Yes	Yes	Yes
• BOOTP	Yes	Yes	Yes	Yes
• SNMP v1	Yes	Yes	Yes	Yes
• SNMP v2	Yes	Yes	Yes	Yes
• SNMP v3	Yes	Yes	Yes	Yes
• IGMP (snooping/querier)	Yes	Yes	Yes	Yes
• GMRP	Yes	Yes	Yes	Yes
• DCP	Yes	Yes	Yes	Yes
• LLDP	Yes	Yes	Yes	Yes
Identification & maintenance function				
• I&M0 - device-specific information	Yes	Yes	Yes	Yes
• I&M1 - higher level designation/location designation	Yes	Yes	Yes	Yes

**Technical specifications (continued)**

Article No.	6GK5310-0BA00-2AA3	6GK5310-0FA00-2AA3	6GK5320-1BD00-2AA3	6GK5320-3BF00-2AA3
Product type designation	SCALANCE X310FE	SCALANCE X310	SCALANCE X320-1FE	SCALANCE X320-3LD FE
<b>Product functions Diagnosis</b>				
Product function				
• Port diagnostics	Yes	Yes	Yes	Yes
• Statistics packet size	Yes	Yes	Yes	Yes
• Statistics packet type	Yes	Yes	Yes	Yes
• Error statistics	Yes	Yes	Yes	Yes
• SysLog	Yes	Yes	Yes	Yes
<b>Product functions VLAN</b>				
Product function				
• VLAN - port based	Yes	Yes	Yes	Yes
• VLAN dynamic	Yes	Yes	Yes	Yes
Number of VLANs maximum	255	255	255	255
Number of VLANs - dynamic maximum	255	255	255	255
Protocol is supported GVRP	Yes	Yes	Yes	Yes
<b>Product functions DHCP</b>				
Product function				
• DHCP client	Yes	Yes	Yes	Yes
• DHCP Option 82	Yes	Yes	Yes	Yes
• DHCP Option 66	Yes	Yes	Yes	Yes
• DHCP Option 67	Yes	Yes	Yes	Yes
<b>Product functions Redundancy</b>				
Product function				
• Ring redundancy	Yes	Yes	Yes	Yes
• Redundancy manager	Yes	Yes	Yes	Yes
• Standby redundancy	Yes	Yes	Yes	Yes
• High Speed Redundancy Protocol (HRP)	Yes	Yes	Yes	Yes
• Media Redundancy Protocol (MRP)	Yes	Yes	Yes	Yes
• redundancy procedure STP	Yes	Yes	Yes	Yes
• RSTP redundancy protocol	Yes	Yes	Yes	Yes
• redundancy procedure MSTP	Yes	Yes	Yes	Yes
• Passive listening	Yes	Yes	Yes	Yes
Protocol is supported				
• STP/RSTP	Yes	Yes	Yes	Yes
• STP	Yes	Yes	Yes	Yes
• RSTP	Yes	Yes	Yes	Yes
• RSTP big network support	Yes	Yes	Yes	Yes
• LACP	Yes	Yes	Yes	Yes
<b>Product functions Security</b>				
Product function				
• ACL - port/MAC-based	Yes	Yes	Yes	Yes
• IEEE 802.1x (radius)	Yes	Yes	Yes	Yes
• Broadcast/Multicast/Unicast Limiter	Yes	Yes	Yes	Yes
• broadcast blocking	Yes	Yes	Yes	Yes
Protocol is supported SSH	Yes	Yes	Yes	Yes
<b>Product functions Time</b>				
Product function SICLOCK support	Yes	Yes	Yes	Yes
Protocol is supported				
• NTP	No	No	No	No
• SNTP	Yes	Yes	Yes	Yes
• MSTP	Yes	Yes	Yes	Yes
• IEEE 1588 profile default	No	No	No	No

## PROFINET/Industrial Ethernet

### Industrial Ethernet Switches

#### SCALANCE X-300 managed

#### Technical specifications (continued)

Article No.	6GK5310-0BA00-2AA3	6GK5310-0FA00-2AA3	6GK5320-1BD00-2AA3	6GK5320-3BF00-2AA3
Product type designation	SCALANCE X310FE	SCALANCE X310	SCALANCE X320-1FE	SCALANCE X320-3LD FE
<b>Standards, specifications, approvals</b>				
Standard				
• for EMC from FM	FM3611: Class 1, Division 2, Group A, B, C, D / T4, Class 1, Zone 2, Group IIC, T4	FM3611: Class 1, Division 2, Group A, B, C, D / T4, Class 1, Zone 2, Group IIC, T4	FM3611: Class 1, Division 2, Group A, B, C, D / T4, Class 1, Zone 2, Group IIC, T4	FM3611: Class 1, Division 2, Group A, B, C, D / T4, Class 1, Zone 2, Group IIC, T4
• for hazardous zone	EN 60079-0 : 2006, EN 60079-15: 2005, II 3 G Ex nA II T4 KEMA 07 ATEX 0145X	EN 60079-0 : 2006, EN 60079-15: 2005, II 3 G Ex nA II T4 KEMA 07 ATEX 0145X	EN 60079-0 : 2006, EN 60079-15: 2005, II 3 G Ex nA II T4 KEMA 07 ATEX 0145X	EN 60079-0 : 2006, EN 60079-15: 2005, II 3 G Ex nA II T4 KEMA 07 ATEX 0145X
• for safety of CSA and UL	UL 60950-1, CSA C22.2 No. 60950-1	UL 60950-1, CSA C22.2 No. 60950-1	UL 60950-1, CSA C22.2 No. 60950-1	UL 60950-1, CSA C22.2 No. 60950-1
• for hazardous area of CSA and UL	UL 1604 and UL 2279-15 (Hazardous Location), CSA C22.2 No. 213-M1987, Class 1 / Division 2 / Group A, B, C, D / T4, Class 1 / Zone 2 / Group IIC / T4	UL 1604 and UL 2279-15 (Hazardous Location), CSA C22.2 No. 213-M1987, Class 1 / Division 2 / Group A, B, C, D / T4, Class 1 / Zone 2 / Group IIC / T4	UL 1604 and UL 2279-15 (Hazardous Location), CSA C22.2 No. 213-M1987, Class 1 / Division 2 / Group A, B, C, D / T4, Class 1 / Zone 2 / Group IIC / T4	UL 1604 and UL 2279-15 (Hazardous Location), CSA C22.2 No. 213-M1987, Class 1 / Division 2 / Group A, B, C, D / T4, Class 1 / Zone 2 / Group IIC / T4
• for emitted interference	EN 61000-6-4:2007 (Class A)	EN 61000-6-4:2007 (Class A)	EN 61000-6-4:2007 (Class A)	EN 61000-6-4:2007 (Class A)
• for interference immunity	EN 61000-6-2:2005	EN 61000-6-2:2005	EN 61000-6-2:2005	EN 61000-6-2:2005
Verification of suitability	EN 61000-6-2:2005, EN 61000-6-4:2007	EN 61000-6-2:2005, EN 61000-6-4:2007	EN 61000-6-2:2005, EN 61000-6-4:2007	EN 61000-6-2:2005, EN 61000-6-4:2007
• CE mark	Yes	Yes	Yes	Yes
• C-Tick	Yes	Yes	Yes	Yes
• KC approval	Yes	Yes	Yes	Yes
• Railway application in accordance with EN 50155	No	No	No	No
Marine classification association				
• American Bureau of Shipping Europe Ltd. (ABS)	Yes	Yes	-	-
• Bureau Veritas (BV)	Yes	Yes	-	-
• Det Norske Veritas (DNV)	Yes	Yes	-	-
• Germanische Lloyd (GL)	Yes	Yes	-	-
• Lloyds Register of Shipping (LRS)	Yes	Yes	-	-
• Nippon Kaiji Kyokai (NK)	Yes	Yes	-	-

**Technical specifications (continued)**

Article No.	6GK5308-2GG00-2AA2	6GK5308-2GG00-2CA2
Product-type designation	SCALANCE X308-2M	SCALANCE X308-2M TS
<b>Transmission rate</b>		
Transfer rate 1	10 Mbit/s	10 Mbit/s
Transfer rate 2	100 Mbit/s	100 Mbit/s
Transfer rate 3	1 000 Mbit/s	1 000 Mbit/s
<b>Interfaces</b>		
Number of electrical/optical connections for network components or terminal equipment maximum	8	8
Number of electrical connections		
• for network components and terminal equipment	4	4
• for signaling contact	1	1
• for media module	2	2
• for power supply	1	1
• for redundant power supply	1	1
Design of electrical connection		
• for network components and terminal equipment	RJ45 port	RJ45 port
• for signaling contact	2-pole terminal block	2-pole terminal block
• for power supply	4-pole terminal block	4-pole terminal block
Design of optical interface for optical waveguide		
• at 100 Mbit/s	Dependent on selected media modules	Dependent on selected media modules
• at 1 000 Mbit/s	Dependent on selected media modules	Dependent on selected media modules
Design of the removable storage C-PLUG	Yes	Yes
<b>Signal-Inputs/outputs</b>		
Operating voltage of signaling contacts at DC rated value	24 V	24 V
Operating current of signaling contacts at DC maximum	0.1 A	0.1 A
<b>Supply voltage, current consumption, power loss</b>		
Type of supply voltage redundant power supply unit	No	No
Type of supply voltage	DC	DC
Supply voltage external	24 V	12 V
• minimum	18 V	20 V
• maximum	32 V	30 V
Product component fusing at power supply input	Yes	Yes
Type of fusing at input for supply voltage	F 3 A / 32 V	F 3 A / 32 V
Consumed current maximum	0.7 A	0.7 A
Active power loss		
• at 24 V for DC	16.6 W	16.6 W
<b>Permitted ambient conditions</b>		
Ambient temperature		
• during operating	-40 ... +70 °C	-40 ... +70 °C
• during storage	-40 ... +70 °C	-40 ... +70 °C
• during transport	-40 ... +70 °C	-40 ... +70 °C
• Comment	Reduced operating temperature through the use of media modules (-40 °C to +70 °C) or SFP plug-in transceivers (-40 °C to +60 °C). If the device is installed in the vertical position, the maximum operating temperature is reduced to +50 °C.	Reduced operating temperature through the use of media modules (-40 °C to +70 °C) or SFP plug-in transceivers (-40 °C to +60 °C). If the device is installed in the vertical position, the maximum operating temperature is reduced to +50 °C.
Relative humidity at 25 °C without condensation during operating maximum	95 %	95 %
Ambient condition for (standard) operation mode	-	Conformal coating, no
Protection class IP	IP20	IP20

## PROFINET/Industrial Ethernet

### Industrial Ethernet Switches

#### SCALANCE X-300 managed

#### Technical specifications (continued)

Article No.	6GK5308-2GG00-2AA2	6GK5308-2GG00-2CA2
Product-type designation	SCALANCE X308-2M	SCALANCE X308-2M TS
<b>Design, dimensions and weight</b>		
Design	compact	compact
Width	120 mm	120 mm
Height	125 mm	125 mm
Depth	124 mm	124 mm
Net weight	1.4 kg	1.4 kg
Mounting type		
• 19-inch installation	No	No
• 35 mm DIN rail mounting	Yes	Yes
• wall mounting	Yes	Yes
• S7-300 rail mounting	Yes	Yes
Mounting type	When used in shipbuilding, installation on a 35 mm standard mounting rail is not permitted.	When used in shipbuilding, installation on a 35 mm standard mounting rail is not permitted.
<b>Product properties, functions, components general</b>		
Cascading in the case of a redundant ring at reconfiguration time of < 0.3 s	50	50
Cascading in cases of star structuring	Any (depending only on signal propagation time)	Any (depending only on signal propagation time)
<b>Product functions management, configuration</b>		
Product function		
• CLI	Yes	Yes
• web-based management	Yes	Yes
• MIB support	Yes	Yes
• TRAPs via email	Yes	Yes
• Configuration with STEP 7	Yes	Yes
• RMON	Yes	Yes
• SMTP server	-	-
• Port mirroring	Yes	Yes
• CoS	Yes	Yes
• for IRT PROFINET IO switch	-	-
• PROFINET IO diagnosis	Yes	Yes
• switch-managed	Yes	Yes
Protocol is supported		
• Telnet	Yes	Yes
• HTTP	Yes	Yes
• HTTPS	Yes	Yes
• TFTP	Yes	Yes
• FTP	Yes	Yes
• BOOTP	Yes	Yes
• SNMP v1	Yes	Yes
• SNMP v2	Yes	Yes
• SNMP v3	Yes	Yes
• IGMP (snooping/querier)	Yes	Yes
• GMRP	Yes	Yes
• DCP	Yes	Yes
• LLDP	Yes	Yes
Identification & maintenance function		
• I&M0 - device-specific information	Yes	Yes
• I&M1 -higher level designation/location designation	Yes	Yes
<b>Product functions Diagnosis</b>		
Product function		
• Port diagnostics	Yes	Yes
• Statistics packet size	Yes	Yes
• Statistics packet type	Yes	Yes
• Error statistics	Yes	Yes
• SysLog	Yes	Yes



**Technical specifications (continued)**

Article No.	6GK5308-2GG00-2AA2	6GK5308-2GG00-2CA2
Product-type designation	SCALANCE X308-2M	SCALANCE X308-2M TS
<b>Product functions VLAN</b>		
Product function		
• VLAN - port based	Yes	Yes
• VLAN dynamic	Yes	Yes
Number of VLANs maximum	255	255
Number of VLANs - dynamic maximum	255	255
Protocol is supported GVRP	Yes	Yes
<b>Product functions DHCP</b>		
Product function		
• DHCP client	Yes	Yes
• DHCP Option 82	Yes	Yes
• DHCP Option 66	Yes	Yes
• DHCP Option 67	Yes	Yes
<b>Product functions Redundancy</b>		
Product function		
• Ring redundancy	Yes	Yes
• Redundancy manager	Yes	Yes
• Standby redundancy	Yes	Yes
• High Speed Redundancy Protocol (HRP)	Yes	Yes
• Media Redundancy Protocol (MRP)	Yes	Yes
• redundancy procedure STP	Yes	Yes
• RSTP redundancy protocol	Yes	Yes
• redundancy procedure MSTP	Yes	Yes
• Passive listening	Yes	Yes
Protocol is supported		
• STP/RSTP	Yes	Yes
• STP	Yes	Yes
• RSTP	Yes	Yes
• RSTP big network support	Yes	Yes
• LACP	Yes	Yes
<b>Product functions Security</b>		
Product function		
• ACL - port/MAC-based	Yes	Yes
• IEEE 802.1x (radius)	Yes	Yes
• Broadcast/Multicast/Unicast Limiter	Yes	Yes
• broadcast blocking	Yes	Yes
Protocol is supported SSH	Yes	Yes
<b>Product functions Time</b>		
Product function SICLOCK support	Yes	Yes
Protocol is supported		
• NTP	No	No
• SNTP	Yes	Yes
• MSTP	Yes	Yes
• IEEE 1588 profile default	Yes	Yes
<b>Standards, specifications, approvals</b>		
Standard		
• for EMC from FM	FM3611: Class 1, Division 2, Group A, B, C, D / T4, Class 1, Zone 2, Group IIC, T4	FM3611: Class 1, Division 2, Group A, B, C, D / T4, Class 1, Zone 2, Group IIC, T4
• for hazardous zone	EN 60079-0 : 2006, EN 60079-15: 2005, II 3 G Ex nA II T4 KEMA 07 ATEX 0145X	EN 60079-0 : 2006, EN 60079-15: 2005, II 3 G Ex nA II T4 KEMA 07 ATEX 0145X
• for safety of CSA and UL	UL 60950-1, CSA C22.2 No. 60950-1	UL 60950-1, CSA C22.2 No. 60950-1
• for hazardous area of CSA and UL	UL 1604 and UL 2279-15 (Hazardous Location), CSA C22.2 No. 213-M1987, Class 1 / Division 2 / Group A, B, C, D / T4, Class 1 / Zone 2 / Group IIC / T4	UL 1604 and UL 2279-15 (Hazardous Location), CSA C22.2 No. 213-M1987, Class 1 / Division 2 / Group A, B, C, D / T4, Class 1 / Zone 2 / Group IIC / T4
• for emitted interference	EN 61000-6-4:2007 (Class A)	EN 61000-6-4
• for interference immunity	EN 61000-6-2:2005	EN 61000-6-2
Verification of suitability	EN 61000-6-2:2005, EN 61000-6-4:2007	EN 61000-6-2, EN 61000-6-4
• CE mark	Yes	Yes
• C-Tick	Yes	Yes
• KC approval	Yes	Yes
• Railway application in accordance with EN 50155	No	Yes

# PROFINET/Industrial Ethernet

## Industrial Ethernet Switches

### SCALANCE X-300 managed

#### Ordering data

#### Article No.

#### Article No.

#### SCALANCE X-300 Industrial Ethernet switches

Industrial Ethernet switches for setting up electrical and/or optical Industrial Ethernet networks; integrated redundancy manager, IT functions (RSTP, VLAN, etc.), network management via SNMP and web server; incl. operating instructions, Industrial Ethernet network manual and configuration software on CD-ROM; C-PLUG included in the scope of delivery

- **SCALANCE X310;**  
3 x 10/100/1 000 Mbit/s  
RJ45 ports, electrical  
7 x 10/100 Mbit/s  
RJ45 ports, electrical
- **SCALANCE X308-2;**  
2 x 1 000 Mbit/s  
SC ports, optical  
(multimode, glass), up to 750 m  
1 x 10/100/1 000 Mbit/s  
RJ45 port, electrical  
7 x 10/100 Mbit/s  
RJ45 ports, electrical;
- **SCALANCE X308-2LD;**  
2 x 1 000 Mbit/s  
SC ports, optical  
(single-mode, glass), up to 10 km  
1 x 10/100/1 000 Mbit/s  
RJ45 port, electrical,  
7 x 10/100 Mbit/s  
RJ45 ports, electrical;
- **SCALANCE X308-2LH;**  
2 x 1 000 Mbit/s  
SC ports, optical  
(single-mode, glass), up to 40 km  
1 x 10/100/1 000 Mbit/s  
RJ45 port, electrical,  
7 x 10/100 Mbit/s  
RJ45 ports, electrical
- **SCALANCE X308-2LH+;**  
2 x 1 000 Mbit/s  
SC ports, optical  
(single-mode, glass), up to 70 km  
1 x 10/100/1 000 Mbit/s  
RJ45 port, electrical,  
7 x 10/100 Mbit/s  
RJ45 ports, electrical
- **SCALANCE X307-3;**  
3 x 1 000 Mbit/s  
SC ports, optical  
(multi-mode, glass), up to 750 m  
7 x 10/100 Mbit/s  
RJ45 ports, electrical
- **SCALANCE X307-3LD;**  
3 x 1 000 Mbit/s  
SC ports, optical  
(single-mode, glass), up to 10 km  
7 x 10/100 Mbit/s  
RJ45 ports, electrical

6GK5310-0FA00-2AA3

6GK5308-2FL00-2AA3

6GK5308-2FM00-2AA3

6GK5308-2FN00-2AA3

6GK5308-2FP00-2AA3

6GK5307-3BL00-2AA3

6GK5307-3BM00-2AA3

#### Fast Ethernet switches

- **SCALANCE X310FE;**  
10 x 10/100 Mbit/s  
RJ45 ports, electrical
- **SCALANCE X304-2FE;**  
2 x 100 Mbit/s  
SC port, optical (multimode,  
glass), up to 5 km  
4 x 10/100 Mbit/s  
RJ45 ports, electrical
- **SCALANCE X306-1LD FE;**  
1 x 100 Mbps  
SC port, optical  
(single-mode, glass), up to 5 km  
6 x 10/100 Mbps  
RJ45 ports, electrical
- **SCALANCE X320-1FE;**  
1 x 100 Mbps  
SC port, optical  
(multi-mode, glass), up to 5 km  
20 x 10/100 Mbps  
RJ45 ports, electrical
- **SCALANCE X320-3LD FE;**  
1 x 100 Mbps  
SC port, optical  
(multi-mode, glass), up to 5 km  
2 x 100 Mbps  
SC port, optical  
(single-mode, glass), up to 26 km  
20 x 10/100 Mbps  
RJ45 ports, electrical

6GK5310-0BA00-2AA3

6GK5304-2BD00-2AA3

6GK5306-1BF00-2AA3

6GK5320-1BD00-2AA3

6GK5320-3BF00-2AA3

#### Full Gigabit Ethernet switches

- **SCALANCE X308-2M;**  
4 x 10/100/1 000 Mbps RJ45  
ports, electrical  
2 x 10/100/1 000 Mbps slots for 2-  
port media modules, electrical or  
optical
- **SCALANCE X308-2M TS;**  
4 x 10/100/1 000 Mbps RJ45  
ports, electrical  
2 x 10/100/1 000 Mbps slots for 2-  
port media modules, electrical or  
optical,  
with extended temperature range  
and EN 50155 approval for railway  
applications

6GK5308-2GG00-2AA2

6GK5308-2GG00-2CA2

#### Media modules

See "Media modules for modular  
SCALANCE X-300 managed"

#### Accessories

##### IE FC TP Standard Cable GP 2 x 2 (Type A)

4-core, shielded TP installation  
cable for connection to  
IE FC RJ45 outlet / IE FC RJ45 plug;  
PROFINET-compliant;  
with UL approval;  
sold by the meter;  
max. quantity 1 000 m,  
minimum order 20 m

6XV1840-2AH10

##### IE FC TP Standard Cable GP 4 x 2

8-core, shielded TP installation  
cable for connection to  
IE FC RJ45 Modular Outlet  
for universal application;  
with UL approval;  
sold by the meter;  
max quantity 1 000 m,  
minimum order 20 m

6XV1870-2E

##### IE TP Cord RJ45/RJ45

TP cable 4 x 2  
with two RJ45 connectors

- 0.5 m
- 1 m
- 2 m
- 6 m
- 10 m

6XV1870-3QE50

6XV1870-3QH10

6XV1870-3QH20

6XV1870-3QH60

6XV1870-3QN10

Ordering data	Article No.	Article No.
<b>FO Standard Cable GP 50/125/1400<sup>2)</sup></b> Multimode cable, sold by the meter; max. length 1 000 m; minimum order 20 m	6XV1873-2A	
<b>FO Robust Cable GP 4E9/125/90</b> Singlemode cable, sold by the meter; max. length 1 000 m; minimum order 20 m	6XV1843-2R	
<b>Glass fiber-optic cable, pre-assembled with 4 SC connectors<sup>1)</sup></b> <ul style="list-style-type: none"> <li>• 80 m</li> <li>• 100 m</li> <li>• 150 m</li> <li>• 200 m</li> <li>• 300 m</li> </ul>	6XV1873-6AN80 6XV1873-6AT10 6XV1873-6AT15 6XV1873-6AT20 6XV1873-6AT30	
<b>FC FO Standard Cable GP 62.5/200/230</b> FC FO standard cable for fixed routing indoors with PVC sheath; sold by the meter; max. length 1 000 m; minimum order 20 m	6XV1847-2A	
<b>IE FC RJ45 Plug 180 2 x 2</b> RJ45 plug-in connector for Industrial Ethernet with a rugged metal enclosure and integrated insulation displacement contacts for connecting Industrial Ethernet FC installation cables; with 180° cable outlet; for network components and CPs/CPU's with Industrial Ethernet interface <ul style="list-style-type: none"> <li>• 1 pack = 1 unit</li> <li>• 1 pack = 10 units</li> <li>• 1 pack = 50 units</li> </ul>	6GK1901-1BB10-2AA0 6GK1901-1BB10-2AB0 6GK1901-1BB10-2AE0	
		<b>IE FC RJ45 Plug 4 x 2</b> RJ45 plug connector for Industrial Ethernet (10/100/1 000 Mbps) with a rugged metal enclosure and integrated insulation displacement contacts for connecting Industrial Ethernet FC installation cables; 180° cable outlet; for network components and CPs/CPU's with Industrial Ethernet interface <ul style="list-style-type: none"> <li>• 1 pack = 1 unit</li> <li>• 1 pack = 10 units</li> <li>• 1 pack = 50 units</li> </ul>
		<b>FC SC Plug</b> Screw connector for on-site assembly on FC fiber-optic cable; (1 pack = 10 Duplex Plugs + cleaning cloths)
		<b>IE FC stripping tool</b> Preadjusted stripping tool for fast stripping of Industrial Ethernet FC cables
		<b>FC FO termination kit</b> Assembly case for local assembly of FC SC and FC BFOC connectors to FC FO standard cable, comprising a stripping tool, Kevlar cutters, fiber breaking tool and microscope
		<b>SITOP compact 24 V/ 0.6 A</b> 1-phase power supply with wide-range input 85 – 264 V AC/110 – 300 V DC, stabilized output voltage 24 V, rated output current value 0.6 A, slim design
		<b>IE FC RJ45 Modular Outlet</b> FastConnect RJ45 outlet for Industrial Ethernet with interface for replaceable insert; <ul style="list-style-type: none"> <li>• <b>With insert 2FE;</b> replaceable insert for 2 x 100 Mbit/s interfaces</li> <li>• <b>With insert 1GE;</b> replaceable insert for 1 x 1 000 Mbps interfaces</li> </ul>
		6GK1901-1BB11-2AA0 6GK1901-1BB11-2AB0 6GK1901-1BB11-2AE0  6GK1900-1LB00-0AC0  6GK1901-1GA00  6GK1900-1GL00-0AA0  6EP1331-5BA00

<sup>1)</sup> Special fiber-optic cables, lengths and accessories available on request

<sup>2)</sup> Special tools and trained personnel are required for pre-assembling glass fiber-optic cables

## More information

### Selection tool:

To assist in selecting the right Industrial Ethernet switches as well as configuration of modular variants, the SIMATIC NET Selection Tool and the TIA Selection Tool are available at:

SIMATIC NET Selection Tool:

- Online version:  
<http://www.siemens.com/snst>
- Offline version:  
<http://www.siemens.com/snst-download>

TIA Selection Tool:

<http://www.siemens.com/tia-selection-tool>

## PROFINET/Industrial Ethernet

### Industrial Ethernet Switches

#### SCALANCE XR-300 managed

#### Overview



The SCALANCE XR-300 Industrial Ethernet switches are fully modular, high-performance, industry-standard switches for the construction of electrical and optical line, ring and star topologies with data transfer rates of 10/100/1 000 Mbit/s, designed for installation in 19" control cabinets.

- As many as 24 electrical and/or optical interfaces (10/100/1 000 Mbit/s); up to 12 electrical and/or optical 2-port media modules can be inserted at any position in the basic unit
- High-speed media redundancy through integral redundancy manager both for Gigabit Ethernet (with SCALANCE X-300, X-400) and Fast Ethernet (e.g. in combination with SCALANCE X-200 switches)
- Seamless integration of automation networks into existing corporate networks thanks to support for a host of IT standard functions (VLANs, IGMP-Snooping/Querier, STP/RSTP, Link Aggregation, Quality of Service)
- Redundant integration into higher-level networks thanks to support for standardized redundancy procedures (Spanning Tree Protocol/Rapid Reconfiguration Spanning Tree Protocol/ MRP)
- Remote diagnostics by means of PROFINET diagnostics, Web browser, CLI, or SNMP

#### Benefits

get **Designed for Industry**

- Unlimited flexibility during network expansions (e.g. more terminals) or conversion (e.g. switching from copper to fiber-optic cable) and reduction of the storage costs due to the modular construction using port modules
- High availability of the network thanks to:
  - Redundant power supply
  - Redundant network structures based on fiber-optic or twisted pair cables (redundancy manager, standby function, and STP/RSTP are integrated)
  - Easy device replacement by means of plug-in C-PLUG swap medium
  - Very fast reconfiguration of the network in the event of a fault
- Lower susceptibility to failure and higher availability of the plant networking due to latching of the RJ45 FastConnect connectors in the sleeve of the RJ45 port modules
- Protection of investment due to integration into existing network management systems by means of standardized SNMP access
- Time saving during engineering, commissioning and in the operating phase of a plant by using the integrated configuration and diagnostics in STEP 7, without additional software
- Space savings in control cabinet due to flexible cable outlet on the front or rear of the device

#### Application

The SCALANCE XR-300 is ideal for use in plant networks and for integrating the industrial network into an existing corporate network. Both at the field level and the control level, the switch performs the network with the distributed field devices and ensures high plant availability with extensive diagnostics options and high transmission speeds. The modularity permits perfect adaptation to the respective application through the use of electrical and also optical media modules

The SCALANCE XR-300 switch is suitable for establishing electrical and optical Industrial Ethernet line, star or ring topologies with 24 ports that can be optionally equipped with electrical and/or optical 2-port media modules. It can also be used as a hub in the plant bus (redundant connection is possible).

The SCALANCE XR324-12M TS (TS = Transportation Systems) is suitable for use in railway applications due to its specification according to EN 50155.

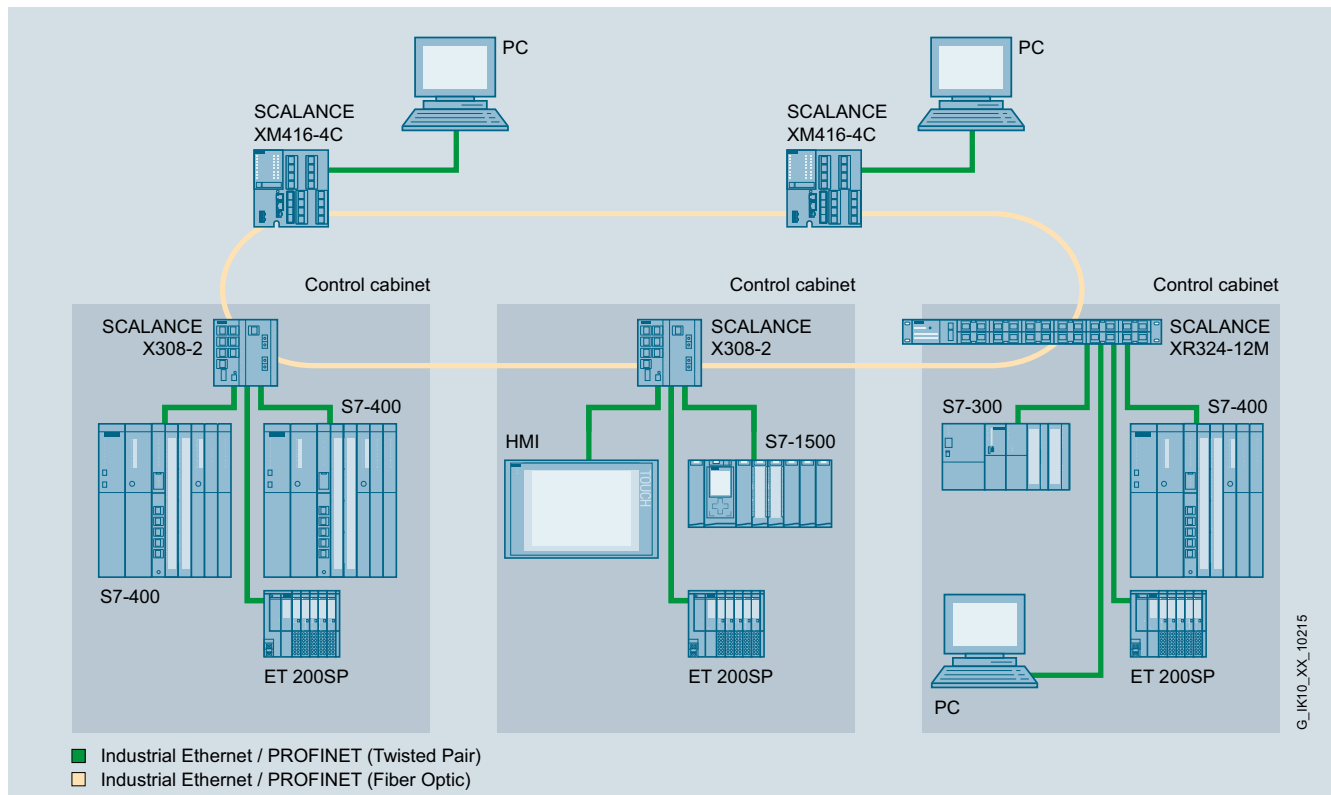
**Design** (continued)

Integration of control cabinets with SCALANCE X-300 in an optical Gigabit ring

The use of media modules in partly and fully modular versions of the SCALANCE X-300 switches supports:

- The extension of networks by subsequent insertion of additional media modules in unused media module slots
- The changing of cabling technology, e.g. conversion from copper to fiber-optic cables, or from multimode to single-mode FOC

**Design**

The SCALANCE XR-300 Industrial Ethernet switches with rugged metal enclosure with IP30 degree of protection are optimized for installation in the 19" control cabinet. Versions are available with 24 V DC or 230 V AC connection. The connection of the power supply and the data cable outlet are located optionally either at the front or rear of the device.

The switches have:

- 4-pin terminal block for redundant voltage feed for protection against voltage failure in 24 V DC version
- 3-pin terminal block for voltage feed in 230 V AC version
- 2-pin terminal block for connecting the isolated signaling contact for simple display of faults
- Row of LEDs for indicating status information (power, link status, data transfer, power supply, signaling contact)
- SELECT/SET pushbutton for easy setting of the fault signaling contact on the device
- Slot for optional C-PLUG swap medium on the side of the device for easy replacement in the event of a fault
- Console port (serial interface) for on-site parameterization/diagnostics (RJ11 cable to RS232 (9-pin) included in scope of delivery)

The SCALANCE XR-300 switches are available with the following port types:

- 12 slots for electrical or optical 2-port media modules for multi-mode or single-mode connections; the optical media modules are available in various connection technologies
- The RJ45 sockets are designed to be industry-compatible with additional sleeves, for connection of the Industrial Ethernet FC RJ45 Plug 180
- All electrical Ethernet interfaces support 10/100/1 000 Mbit/s, all optical Ethernet interfaces support 100 or 1 000 Mbit/s
- The SCALANCE XR-300 switches support Gigabit Ethernet (1 000 Mbit/s) at all ports. The 24 ports are divided into three groups of eight ports each (Gigabit Ethernet Blocking). Gigabit Ethernet is supported with full wire speed within each group, but not between the groups.

## PROFINET/Industrial Ethernet

### Industrial Ethernet Switches

#### SCALANCE XR-300 managed

#### Design (continued)

##### Product versions

##### SCALANCE XR324-12M (12 media module slots)

Versions are available with

- LEDs, power supply connection and data cable outlet on the front
- LEDs on the front, power supply connection and data cable outlet at the rear

All versions have twelve media module slots and

- 1 x 24 V DC power supply unit
- 1 x 230 V AC power supply

##### SCALANCE XR324-12M TS (12 media module slots)

A variant is available with

- LEDs, power supply connection and data cable outlet on the front

The SCALANCE XR324-12M TS has twelve media module slots and

- 1 x 24 V DC power supply unit

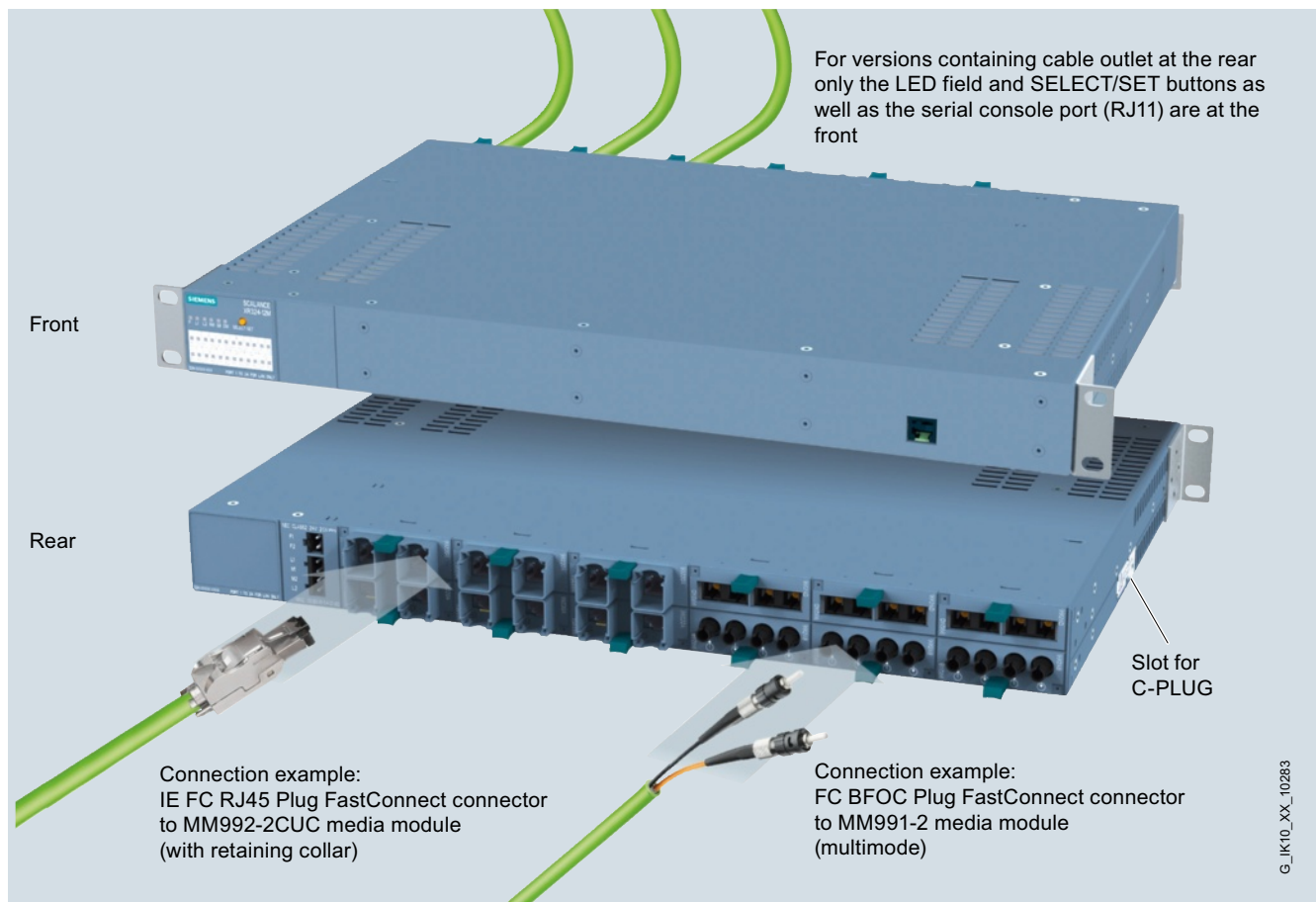

SCALANCE XR-300 with cable outlet at rear

**Function**

- Integrated redundancy manager for constructing Fast Ethernet and Gigabit Ethernet ring topologies with high-speed media redundancy. Reliable communication is achieved by closing an optical or electrical line with SCALANCE X-400, X-300 or X-200 switches to form a ring. The redundancy manager (RM) integrated in the SCALANCE XR-300 switch monitors the function of the network. It recognizes the failure of a transmission link or of SCALANCE X switch in the ring and activates the substitute path within a maximum of 0.2 seconds.
- Redundant interfacing to company networks; SCALANCE XR-300 switches support the standardized redundancy procedures Spanning Tree Protocol (STP) and Rapid Spanning Tree Protocol (RSTP). This enables a subnetwork to be connected redundantly to a higher level corporate network with reduced requirements for the reconfiguration time (in the order of seconds). By supporting the Multiple Spanning Tree Protocol (MSTP), a network can also be split into multiple sub-segments.
- Support of virtual networks (VLAN); for structuring Industrial Ethernet networks with a fast growing number of users, a physically existing network can be divided into several virtual networks.
- Load limiting when multicast protocols (e.g. video transmission) are used; through learning the multicast sources and targets (IGMP Snooping, IGMP Querier), SCALANCE XR-300 switches can also filter multicast data traffic and therefore limit the load in the network. Multicast and broadcast traffic can be limited.
- Time synchronization; diagnostic messages (log table entries, e-mails) are time-stamped. The local time is standardized throughout the network by means of synchronization with a SICKLOCK time transmitter, SNTP or NTP server or via IEEE1588, thereby simplifying the assignment of diagnostic messages of several devices.
- Fast replacement of devices in event of failure, by means of the C-PLUG switching medium
- Link aggregation (IEEE 802.1q) for bundling data streams
- Quality of Service (IEEE 802.1p) for prioritization of network traffic

**Network topology and network configuration**

The network topology can easily be adapted to the structure of the plant using SCALANCE XR-300 Industrial Ethernet switches.

The following network structures and combinations of structures can be implemented:

- Fast Ethernet with fast media redundancy; to increase network availability, as many as 50 X-200, X-300, X-400 or X-500 switches cascaded in line can be connected into a ring.
- Several rings can be redundantly linked through the standby function
- In addition, SCALANCE XR-300 supports redundant connection of the ring structure to the corporate network with a rapid spanning tree.
- Star topology with SCALANCE XR-300 switches: Each SCALANCE XR-300 switch represents a neutral point that can connect up to 24 nodes or subnets with each other electrically.

When configuring the network, it is necessary to observe the following boundary conditions:

- Maximum line length between two modules for multi-mode fiber-optic conductors:
  - 5 km at 100 Mbit/s
  - 750 m at 1 Gbit/s
- Maximum line length between two modules for single-mode fiber-optic conductors:
  - 26 km to 70 km at 100 Mbps
  - 10 to 120 km at 1 Gbit/s
- Maximum cable length of the TP cable between two SCALANCE X switches:
  - Max. 100 m with IE FC cable 2x2 and IE FC RJ45 Plug 180
  - Max. 100 m at 1 Gbit/s with IE FC Standard Cable 4x2 (90 m), IE FC RJ45 Modular Outlet and patch cable (10 m)
  - Max. 10 m using patches with TP cord

## PROFINET/Industrial Ethernet

### Industrial Ethernet Switches

#### SCALANCE XR-300 managed

#### Function (continued)

##### Commissioning and diagnostics

Setting options on the device itself:

- Redundancy manager RM; to establish a ring, a SCALANCE XR-300 is switched to RM mode. The Gigabit ports (electrical or optical) are preferably used as ring ports. The non-ring ports of the RM can be used freely for the connection of data terminals and networks. If the redundancy procedure MRP standardized by PROFINET is used, the RM is adjusted automatically.
- Signal mask; the signal mask is set to the current status of the SCALANCE XR-300 (setpoint) by pushbutton operation. The signal mask defines which ports and which power supplies are to be monitored. The signaling contact only reports an error when a monitored port or a monitored feeder fails (deviation of setpoint/actual status).
- IP address; the IP address is assigned via DHCP (Dynamic Host Configuration Protocol). If there is no corresponding server in the network, the IP address can be assigned using an enclosed software tool.

Diagnostic options on site:

- The following status information is displayed by LEDs on site:
  - Port status
  - Port mode (10/100/1 000 Mbit/s, full/half-duplex)
  - Status of the two power supplies
  - Signaling contact status
  - Signal mask (setpoint status)
  - RM mode
  - Standby mode
- The status of the signaling contact is routed externally by means of floating relay contacts. This enables, for example, the module to be monitored via an input module from a controller.
- Monitoring via the Industrial Ethernet network; the following possibilities are available:
  - Remote via standard browser (Web-based management): Selection of SCALANCE XR-300 switches via the network from a PC with browser
  - Remote via SNMP V1, V2c, V3: Secure integration of SCALANCE XR-300 switches via the network into a network management system, e.g. SINEMA Server
  - Remote via PROFINET IO diagnostics: PROFINET diagnostic alarms from SCALANCE X-300 switches can be displayed using the relevant SIMATIC engineering tools and they can also be processed in the controller. The engineering outlay for the PLC and HMI have been drastically reduced due to the complete integration in the SIMATIC concept for system error messages.

##### Network management

The network management provides the following functions:

- Password-protected dial-up for "Administrator" (read and write authorization) and "User" (read only)
- Read-out of version and status information
- Setting the signal and standby mask and address information
- Fixed parameterization of the ports (data rates, half/full duplex)
- Setting of Spanning/Rapid Spanning Tree parameters
- Parameterization of the web management services
- Security
  - Ports can be connected or disconnected
  - Port-based network access control according to IEEE 802.1x
  - Authentication in accordance with IEEE 802.1x (available soon)
  - Support of Access Control List (ACL) (available soon)
- Output of statistics information
- Diagnosis of data traffic by means of a parameterizable mirror port with a standard commercial network analyzer
- Loading of new firmware versions or of the configuration data via the network by a TFTP server or directly via HTTP/HTTPS using a Web browser
- Saving the configuration data or log table via the network on a TFTP server

If faults occur in the network, the SCALANCE XR-300 switch can independently send error messages (traps) to a network management system or also e-mails to a predefined network administrator.

Remote monitoring (RMON) provides the following functions: The SCALANCE XR-300 switch can collect statistics information according to the RMON groups 1 through 4. These include, for example, fault statistics that are kept for each port. This information can be read out through web-based management in the statistics sub-area.



**Technical specifications**

Article No.	6GK5324-0GG00-1AR2	6GK5324-0GG00-1HR2	6GK5324-0GG00-1CR2
Product-type designation	SCALANCE XR324-12M	SCALANCE XR324-12M	SCALANCE XR324-12M TS
<b>Transmission rate</b>			
Transfer rate 1	10 Mbit/s	10 Mbit/s	10 Mbit/s
Transfer rate 2	100 Mbit/s	100 Mbit/s	100 Mbit/s
Transfer rate 3	1 000 Mbit/s	1 000 Mbit/s	1 000 Mbit/s
<b>Interfaces</b>			
Number of electrical/optical connections for network components or terminal equipment maximum	24	24	24
Number of electrical connections			
• for operator console	1	1	1
• for signaling contact	1	1	1
• for media module	12	12	12
• for power supply	1	1	1
• for redundant power supply	1	1	1
Design of electrical connection			
• for network components and terminal equipment	Dependent on selected media modules	Dependent on selected media modules	Dependent on selected media modules
• for operator console	RJ11 port	RJ11 port	RJ11 port
• for signaling contact	2-pole terminal block	2-pole terminal block	2-pole terminal block
• for power supply	4-pole terminal block	4-pole terminal block	4-pole terminal block
Design of optical interface for optical waveguide			
• at 100 Mbit/s	Dependent on selected media modules	Dependent on selected media modules	Dependent on selected media modules
• at 1 000 Mbit/s	Dependent on selected media modules	Dependent on selected media modules	Dependent on selected media modules
design of the removable storage C-PLUG	Yes	Yes	Yes
<b>Signal-Inputs/outputs</b>			
Operating voltage of signaling contacts at DC rated value	24 V	24 V	24 V
Operating current of signaling contacts at DC maximum	0.1 A	0.1 A	0.1 A
<b>Supply voltage, current consumption, power loss</b>			
Type of supply voltage redundant power supply unit	No	No	No
Type of supply voltage	DC	DC	DC
Supply voltage external	24 V	24 V	24 V
• minimum	19.2 V	19.2 V	19.2 V
• maximum	28.8 V	28.8 V	28.8 V
Product component fusing at power supply input	Yes	Yes	Yes
Type of fusing at input for supply voltage	F 5 A / 125 V	F 5 A / 125 V	F 5 A / 125 V
Consumed current maximum	1.8 A	1.8 A	1.8 A
Active power loss			
• at 24 V for DC	44 W	44 W	44 W

## PROFINET/Industrial Ethernet

### Industrial Ethernet Switches

#### SCALANCE XR-300 managed

#### Technical specifications (continued)

Article No.	6GK5324-0GG00-1AR2	6GK5324-0GG00-1HR2	6GK5324-0GG00-1CR2
Product-type designation	SCALANCE XR324-12M	SCALANCE XR324-12M	SCALANCE XR324-12M TS
<b>Permitted ambient conditions</b>			
Ambient temperature			
• during operating	-40 ... +70 °C	-40 ... +70 °C	-40 ... +70 °C
• during storage	-40 ... +85 °C	-40 ... +85 °C	-40 ... +85 °C
• during transport	-40 ... +85 °C	-40 ... +85 °C	-40 ... +85 °C
• Comment	Reduced operating temperature through the use of media modules (-40 °C to +70 °C) or SFP plug-in transceivers (-40 °C to +60 °C). If the device is installed in the vertical position, the maximum operating temperature is reduced to +50 °C.	Reduced operating temperature through the use of media modules (-40 °C to +70 °C) or SFP plug-in transceivers (-40 °C to +60 °C). If the device is installed in the vertical position, the maximum operating temperature is reduced to +50 °C.	Reduced operating temperature through the use of media modules (-40 °C to +70 °C) or SFP plug-in transceivers (-40 °C to +60 °C). If the device is installed in the vertical position, the maximum operating temperature is reduced to +50 °C.
Relative humidity at 25 °C without condensation during operating maximum	95 %	95 %	95 %
Ambient condition for (standard) operation mode	Conformal coating, no	Conformal coating, no	Conformal coating, yes
Protection class IP	IP20	IP20	IP20
<b>Design, dimensions and weight</b>			
Design	19" rack	19" rack	19" rack
Width	483 mm	483 mm	483 mm
Height	44 mm	44 mm	44 mm
Depth	305 mm	305 mm	305 mm
Net weight	5.5 kg	5.5 kg	5.5 kg
Mounting type			
• 19-inch installation	Yes	Yes	Yes
• 35 mm DIN rail mounting	No	No	No
• wall mounting	No	No	No
• S7-300 rail mounting	No	No	No
Mounting type	When used in shipbuilding, the device must be secured in the 19" rack at four points	When used in shipbuilding, the device must be secured in the 19" rack at four points	When used in shipbuilding, the device must be secured in the 19" rack at four points
<b>Product properties, functions, components general</b>			
Cascading in the case of a redundant ring at reconfiguration time of < 0.3 s	50	50	50
Cascading in cases of star structuring	Any (depending only on signal propagation time)	Any (depending only on signal propagation time)	Any (depending only on signal propagation time)
<b>Product functions management, configuration</b>			
Product function			
• CLI	Yes	Yes	Yes
• web-based management	Yes	Yes	Yes
• MIB support	Yes	Yes	Yes
• TRAPs via email	Yes	Yes	Yes
• Configuration with STEP 7	Yes	Yes	Yes
• RMON	Yes	Yes	Yes
• SMTP server	-	-	-
• Port mirroring	Yes	Yes	Yes
• CoS	Yes	Yes	Yes
• PROFINET IO diagnosis	Yes	Yes	Yes
• switch-managed	Yes	Yes	Yes

**Technical specifications (continued)**

Article No.	6GK5324-0GG00-1AR2	6GK5324-0GG00-1HR2	6GK5324-0GG00-1CR2
Product-type designation	SCALANCE XR324-12M	SCALANCE XR324-12M	SCALANCE XR324-12M TS
Protocol is supported			
• Telnet	Yes	Yes	Yes
• HTTP	Yes	Yes	Yes
• HTTPS	Yes	Yes	Yes
• TFTP	Yes	Yes	Yes
• FTP	Yes	Yes	Yes
• BOOTP	Yes	Yes	Yes
• SNMP v1	Yes	Yes	Yes
• SNMP v2	Yes	Yes	Yes
• SNMP v3	Yes	Yes	Yes
• IGMP (snooping/querier)	Yes	Yes	Yes
• GMRP	Yes	Yes	Yes
• DCP	Yes	Yes	Yes
• LLDP	Yes	Yes	Yes
Identification & maintenance function			
• I&M0 - device-specific information	Yes	Yes	Yes
• I&M1 - higher level designation/location designation	Yes	Yes	Yes
<b>Product functions Diagnosis</b>			
Product function			
• Port diagnostics	Yes	Yes	Yes
• Statistics packet size	Yes	Yes	Yes
• Statistics packet type	Yes	Yes	Yes
• Error statistics	Yes	Yes	Yes
• SysLog	Yes	Yes	Yes
<b>Product functions VLAN</b>			
Product function			
• VLAN - port based	Yes	Yes	Yes
• VLAN dynamic	Yes	Yes	Yes
Number of VLANs maximum	255	255	255
Number of VLANs - dynamic maximum	255	255	255
Protocol is supported GVRP	Yes	Yes	Yes
<b>Product functions DHCP</b>			
Product function			
• DHCP client	Yes	Yes	Yes
• DHCP Option 82	Yes	Yes	Yes
• DHCP Option 66	Yes	Yes	Yes
• DHCP Option 67	Yes	Yes	Yes
<b>Product functions Redundancy</b>			
Product function			
• Ring redundancy	Yes	Yes	Yes
• Redundancy manager	Yes	Yes	Yes
• Standby redundancy	Yes	Yes	Yes
• High Speed Redundancy Protocol (HRP)	Yes	Yes	Yes
• Media Redundancy Protocol (MRP)	Yes	Yes	Yes
• redundancy procedure STP	Yes	Yes	Yes
• RSTP redundancy protocol	Yes	Yes	Yes
• redundancy procedure MSTP	Yes	Yes	Yes
• Passive listening	Yes	Yes	Yes
Protocol is supported			
• STP/RSTP	Yes	Yes	Yes
• STP	Yes	Yes	Yes
• RSTP	Yes	Yes	Yes
• RSTP big network support	Yes	Yes	Yes
• LACP	Yes	Yes	Yes

# PROFINET/Industrial Ethernet

## Industrial Ethernet Switches

### SCALANCE XR-300 managed

#### Technical specifications (continued)

Article No.	6GK5324-0GG00-1AR2	6GK5324-0GG00-1HR2	6GK5324-0GG00-1CR2
Product-type designation	SCALANCE XR324-12M	SCALANCE XR324-12M	SCALANCE XR324-12M TS
<b>Product functions Security</b>			
Product function			
• ACL - port/MAC-based	Yes	Yes	Yes
• IEEE 802.1x (radius)	Yes	Yes	Yes
• Broadcast/Multicast/Unicast Limiter	Yes	Yes	Yes
• Broadcast blocking	Yes	Yes	Yes
Protocol is supported SSH	Yes	Yes	Yes
<b>Product functions Time</b>			
Product function SICLOCK support	Yes	Yes	Yes
Protocol is supported			
• NTP	No	No	No
• SNTP	Yes	Yes	Yes
• MSTP	Yes	Yes	Yes
• IEEE 1588 profile default	Yes	Yes	Yes
<b>Standards, specifications, approvals</b>			
Standard			
• for EMC from FM	FM3611: Class 1, Division 2, Group A, B, C, D / T4, Class 1, Zone 2, Group IIC, T4	FM3611: Class 1, Division 2, Group A, B, C, D / T4, Class 1, Zone 2, Group IIC, T4	FM3611: Class 1, Division 2, Group A, B, C, D / T4, Class 1, Zone 2, Group IIC, T4
• for hazardous zone	EN 60079-0 : 2006, EN 60079-15: 2005, II 3 G Ex nA II T4 KEMA 07 ATEX 0145X	EN 60079-0 : 2006, EN 60079-15: 2005, II 3 G Ex nA II T4 KEMA 07 ATEX 0145X	EN 60079-0 : 2006, EN 60079-15: 2005, II 3 G Ex nA II T4 KEMA 07 ATEX 0145X
• for safety of CSA and UL	UL 60950-1, CSA C22.2 No. 60950-1-03	UL 60950-1, CSA C22.2 No. 60950-1-03	UL 60950-1, CSA C22.2 No. 60950-1-03
• for hazardous area of CSA and UL	UL 1604 and UL 2279-15 (Hazardous Location), CSA C22.2 No. 213-M1987, Class 1 / Division 2 / Group A, B, C, D / T4, Class 1 / Zone 2 / Group IIC / T4	UL 1604 and UL 2279-15 (Hazardous Location), CSA C22.2 No. 213-M1987, Class 1 / Division 2 / Group A, B, C, D / T4, Class 1 / Zone 2 / Group IIC / T4	UL 1604 and UL 2279-15 (Hazardous Location), CSA C22.2 No. 213-M1987, Class 1 / Division 2 / Group A, B, C, D / T4, Class 1 / Zone 2 / Group IIC / T4
• for emitted interference	EN 61000-6-4:2007 (Class A)	EN 61000-6-4:2007 (Class A)	EN 61000-6-4:2007 (Class A)
• for interference immunity	EN 61000-6-2:2005	EN 61000-6-2:2005	EN 61000-6-2:2005
Verification of suitability	EN 61000-6-2:2005, EN 61000-6-4:2007	EN 61000-6-2:2005, EN 61000-6-4:2007	EN 61000-6-2:2005, EN 61000-6-4:2007
• CE mark	Yes	Yes	Yes
• C-Tick	Yes	Yes	Yes
• KC approval	Yes	Yes	Yes
• Railway application in accordance with EN 50155	No	No	Yes

**Technical specifications (continued)**

Article No.	6GK5324-0GG00-3AR2	6GK5324-0GG00-3HR2
Product-type designation	SCALANCE XR324-12M	SCALANCE XR324-12M
<b>Transmission rate</b>		
Transfer rate 1	10 Mbit/s	10 Mbit/s
Transfer rate 2	100 Mbit/s	100 Mbit/s
Transfer rate 3	1 000 Mbit/s	1 000 Mbit/s
<b>Interfaces</b>		
Number of electrical/optical connections for network components or terminal equipment maximum	24	24
Number of electrical connections		
• for operator console	1	1
• for signaling contact	1	1
• for media module	12	12
• for power supply	1	1
• for redundant power supply	0	0
Design of electrical connection		
• for network components and terminal equipment	Dependent on selected media modules	Dependent on selected media modules
• for operator console	RJ11 port	RJ11 port
• for signaling contact	2-pole terminal block	2-pole terminal block
• for power supply	2-pole terminal block	2-pole terminal block
Design of optical interface for optical waveguide		
• at 100 Mbit/s	Dependent on selected media modules	Dependent on selected media modules
• at 1 000 Mbit/s	Dependent on selected media modules	Dependent on selected media modules
Design of the removable storage C-PLUG	Yes	Yes
<b>Signal-Inputs/outputs</b>		
Operating voltage of signaling contacts at DC rated value	24 V	24 V
Operating current of signaling contacts at DC maximum	0.1 A	0.1 A
<b>Supply voltage, current consumption, power loss</b>		
Type of supply voltage redundant power supply unit	No	No
Type of supply voltage	AC	AC
Supply voltage external	230 V	230 V
• minimum	85 V	85 V
• maximum	264 V	264 V
Product component fusing at power supply input	Yes	Yes
Type of fusing at input for supply voltage	3.15 A / 250 V	3.15 A / 250 V
Consumed current maximum	0.8 A	0.8 A
Active power loss		
• at 230 V AC	50 W	50 W

# PROFINET/Industrial Ethernet

## Industrial Ethernet Switches

### SCALANCE XR-300 managed

#### Technical specifications (continued)

Article No.	6GK5324-0GG00-3AR2	6GK5324-0GG00-3HR2
Product-type designation	SCALANCE XR324-12M	SCALANCE XR324-12M
<b>Permitted ambient conditions</b>		
Ambient temperature		
• during operating	-40 ... +70 °C	-40 ... +70 °C
• during storage	-40 ... +85 °C	-40 ... +85 °C
• during transport	-40 ... +85 °C	-40 ... +85 °C
• Comment	Reduced operating temperature through the use of media modules (-40 °C to +70 °C) or SFP plug-in transceivers (-40 °C to +60 °C). If the device is installed in the vertical position, the maximum operating temperature is reduced to +50 °C.	Reduced operating temperature through the use of media modules (-40 °C to +70 °C) or SFP plug-in transceivers (-40 °C to +60 °C). If the device is installed in the vertical position, the maximum operating temperature is reduced to +50 °C.
Relative humidity at 25 °C without condensation during operating maximum	95 %	95 %
Ambient condition for (standard) operation mode	Conformal coating, no	Conformal coating, no
Protection class IP	IP20	IP20
<b>Design, dimensions and weight</b>		
Design	19" rack	19" rack
Width	483 mm	483 mm
Height	44 mm	44 mm
Depth	305 mm	305 mm
Net weight	5.9 kg	5.9 kg
Mounting type		
• 19-inch installation	Yes	Yes
• 35 mm DIN rail mounting	No	No
• wall mounting	No	No
• S7-300 rail mounting	No	No
Mounting type	When used in shipbuilding, the device must be secured in the 19" rack at four points	When used in shipbuilding, the device must be secured in the 19" rack at four points
<b>Product properties, functions, components general</b>		
Cascading in the case of a redundant ring at reconfiguration time of < 0.3 s	50	50
Cascading in cases of star structuring	Any (depending only on signal propagation time)	Any (depending only on signal propagation time)
<b>Product functions management, configuration</b>		
Product function		
• CLI	Yes	Yes
• web-based management	Yes	Yes
• MIB support	Yes	Yes
• TRAPs via email	Yes	Yes
• Configuration with STEP 7	Yes	Yes
• RMON	Yes	Yes
• SMTP server	-	-
• Port mirroring	Yes	Yes
• CoS	Yes	Yes
• for IRT PROFINET IO switch	-	-
• PROFINET IO diagnosis	Yes	Yes
• switch-managed	Yes	Yes

**Technical specifications (continued)**

Article No.	6GK5324-0GG00-3AR2	6GK5324-0GG00-3HR2
Product-type designation	SCALANCE XR324-12M	SCALANCE XR324-12M
Protocol is supported		
• Telnet	Yes	Yes
• HTTP	Yes	Yes
• HTTPS	Yes	Yes
• TFTP	Yes	Yes
• FTP	Yes	Yes
• BOOTP	Yes	Yes
• SNMP v1	Yes	Yes
• SNMP v2	Yes	Yes
• SNMP v3	Yes	Yes
• IGMP (snooping/querier)	Yes	Yes
• GMRP	Yes	Yes
• DCP	Yes	Yes
• LLDP	Yes	Yes
Identification & maintenance function		
• I&M0 - device-specific information	Yes	Yes
• I&M1 - higher level designation/location designation	Yes	Yes
<b>Product functions Diagnosis</b>		
Product function		
• Port diagnostics	Yes	Yes
• Statistics packet size	Yes	Yes
• Statistics packet type	Yes	Yes
• Error statistics	Yes	Yes
• SysLog	Yes	Yes
<b>Product functions VLAN</b>		
Product function		
• VLAN - port based	Yes	Yes
• VLAN dynamic	Yes	Yes
Number of VLANs maximum	255	255
Number of VLANs - dynamic maximum	255	255
Protocol is supported GVRP	Yes	Yes
<b>Product functions DHCP</b>		
Product function		
• DHCP client	Yes	Yes
• DHCP Option 82	Yes	Yes
• DHCP Option 66	Yes	Yes
• DHCP Option 67	Yes	Yes
<b>Product functions Redundancy</b>		
Product function		
• Ring redundancy	Yes	Yes
• Redundancy manager	Yes	Yes
• Standby redundancy	Yes	Yes
• High Speed Redundancy Protocol (HRP)	Yes	Yes
• Media Redundancy Protocol (MRP)	Yes	Yes
• redundancy procedure STP	Yes	Yes
• RSTP redundancy protocol	Yes	Yes
• redundancy procedure MSTP	Yes	Yes
• Passive listening	Yes	Yes
Protocol is supported		
• STP/RSTP	Yes	Yes
• STP	Yes	Yes
• RSTP	Yes	Yes
• RSTP big network support	Yes	Yes
• LACP	Yes	Yes

## PROFINET/Industrial Ethernet

### Industrial Ethernet Switches

#### SCALANCE XR-300 managed

#### Technical specifications (continued)

Article No.	6GK5324-0GG00-3AR2	6GK5324-0GG00-3HR2
Product-type designation	SCALANCE XR324-12M	SCALANCE XR324-12M
<b>Product functions Security</b>		
Product function		
• ACL - port/MAC-based	Yes	Yes
• IEEE 802.1x (radius)	Yes	Yes
• Broadcast/Multicast/Unicast Limiter	Yes	Yes
• broadcast blocking	Yes	Yes
Protocol is supported SSH	Yes	Yes
<b>Product functions Time</b>		
Product function SICLOCK support	Yes	Yes
Protocol is supported		
• NTP	No	No
• SNTP	Yes	Yes
• MSTP	Yes	Yes
• IEEE 1588 profile default	Yes	Yes
<b>Standards, specifications, approvals</b>		
Standard		
• for EMC from FM	No	No
• for hazardous zone	No	No
• for safety of CSA and UL	UL 508, CSA C22.2 No. 142-M1987	UL 508, CSA C22.2 No. 142-M1987
• for hazardous area of CSA and UL	No	No
• for emitted interference	EN 61000-6-4:2007 (Class A)	EN 61000-6-4:2007 (Class A)
• for interference immunity	EN 61000-6-2:2005	EN 61000-6-2:2005
Verification of suitability	EN 61000-6-2:2005, EN 61000-6-4:2007	EN 61000-6-2:2005, EN 61000-6-4:2007
• CE mark	Yes	Yes
• C-Tick	Yes	Yes
• KC approval	Yes	Yes
• Railway application in accordance with EN 50155	No	No



**Ordering data**
**Article No.**
**SCALANCE XR324 Industrial Ethernet switches**

Fully modular 19" Industrial Ethernet switches for setting up electrical and/or optical Industrial Ethernet networks; all ports can optionally be equipped with optical or electrical 2-port media modules); all ports support Gigabit Ethernet (blocking), integrated redundancy manager, RSTP, RMON, IGMP-Snooping/Querier, network management via SNMP, PROFINET, and web server 12 x 10/100/1 000 Mbit/s slots for 2-port media modules, electrical or optical

**SCALANCE XR324-12M**

24 V DC power supply

- Data cable outlet at front
- Data cable outlet at rear

**6GK5324-0GG00-1AR2**  
**6GK5324-0GG00-1HR2**

110 ... 230 V AC power supply

- Data cable outlet at front
- Data cable outlet at rear

**6GK5324-0GG00-3AR2**  
**6GK5324-0GG00-3HR2**

**SCALANCE XR324-12M TS**

for railway applications (approval in accordance with EN 50155);

24 V DC power supply

- Data cable outlet at front

**6GK5324-0GG00-1CR2**

**Media modules**

See "Media modules for modular SCALANCE X-300 managed"

**SITOP compact, 2.5 A**

**6EP1332-5BA00**

1-phase power supply with wide-range input 85 – 264 V AC, regulated output voltage 24 V, output current rated value 2.5 A

**More information**
**Selection tool:**

To assist in selecting the right Industrial Ethernet switches as well as configuration of modular variants, the SIMATIC NET Selection Tool and the TIA Selection Tool are available at:

SIMATIC NET Selection Tool:

- Online version:  
<http://www.siemens.com/snst>
- Offline version:  
<http://www.siemens.com/snst-download>

TIA Selection Tool:

<http://www.siemens.com/tia-selection-tool>

## PROFINET/Industrial Ethernet

### Industrial Ethernet Switches

#### SCALANCE X-300PoE managed

##### Overview



The SCALANCE X-300PoE product line comprises compact Industrial Ethernet switches for constructing electrical and/or optical line, star and ring topologies operating at data transfer rates of 10/100/1 000 Mbit/s.

- Partially modular version with four integrated electrical, PoE-enabled Ethernet ports and two slots for 2-port media modules
- High-speed media redundancy through integral redundancy manager both for Gigabit Ethernet (SCALANCE X-300, X-400) and Fast Ethernet (e.g. in combination with SCALANCE X-200 switches)
- Seamless integration of automation networks into existing corporate networks thanks to support for a host of IT standards: Establishment of virtual networks (VLANs)
- Redundant integration into higher-level networks thanks to support for standardized redundancy procedures (Rapid Spanning Tree Protocol)
- PROFINET diagnostics, SNMP access, integrated web server and automatic e-mail transmission function for remote diagnostics and signaling via the network

##### Product version

###### Full Gigabit switches

###### **SCALANCE X308-2M PoE** (Power over Ethernet)

- For the construction of electrical and/or optical line, ring and star topologies with
  - four integrated electrical, PoE-compatible Gigabit Ethernet Ports and two slots for any 2-port media modules (see "Media modules for SCALANCE X-300")
- Star coupler in the plant bus (redundant connection is possible)

##### Benefits



- Unlimited flexibility during network expansions (e.g. more terminals) or conversion (e.g. switching from copper to fiber-optic cable) and reduction of the storage costs due to the modular construction using port modules
- Saving of additional power supply units and cabling for terminals by means of PoE voltage supply
- High availability of the network due to
  - redundant voltage feed
  - Redundant network structures based on fiber-optic or twisted pair cables (redundancy manager, standby function, and RSTP are integrated)
  - easy device replacement by means of plug-in C-PLUG swap medium
  - very fast reconfiguration of the network in event of a fault
- Lower susceptibility to failure and higher availability of the plant networking due to latching of the RJ45 FastConnect connectors in the sleeve of the RJ45 ports
- Protection of investment through integration into existing network management systems by means of standardized SNMP access
- Time saving during engineering, commissioning and in the operating phase of a plant due to the use of configuration and diagnostics integrated in STEP 7

## Application

SCALANCE X-300 products enable the establishment of switched networks both at the field level and at the control level where high data transfer rates are required in addition to high network availability and extensive diagnostics facilities. The SCALANCE X308-2M PoE switch supplies PoE-compatible devices, such as IWLAN access points SCALANCE W,

IP cameras and IP telephones, with energy over the data cable. The switch is designed with IP20 degree of protection for installation in control cabinets.

The main area of application is found in high-performance plant networks with interfaces to the corporate network.

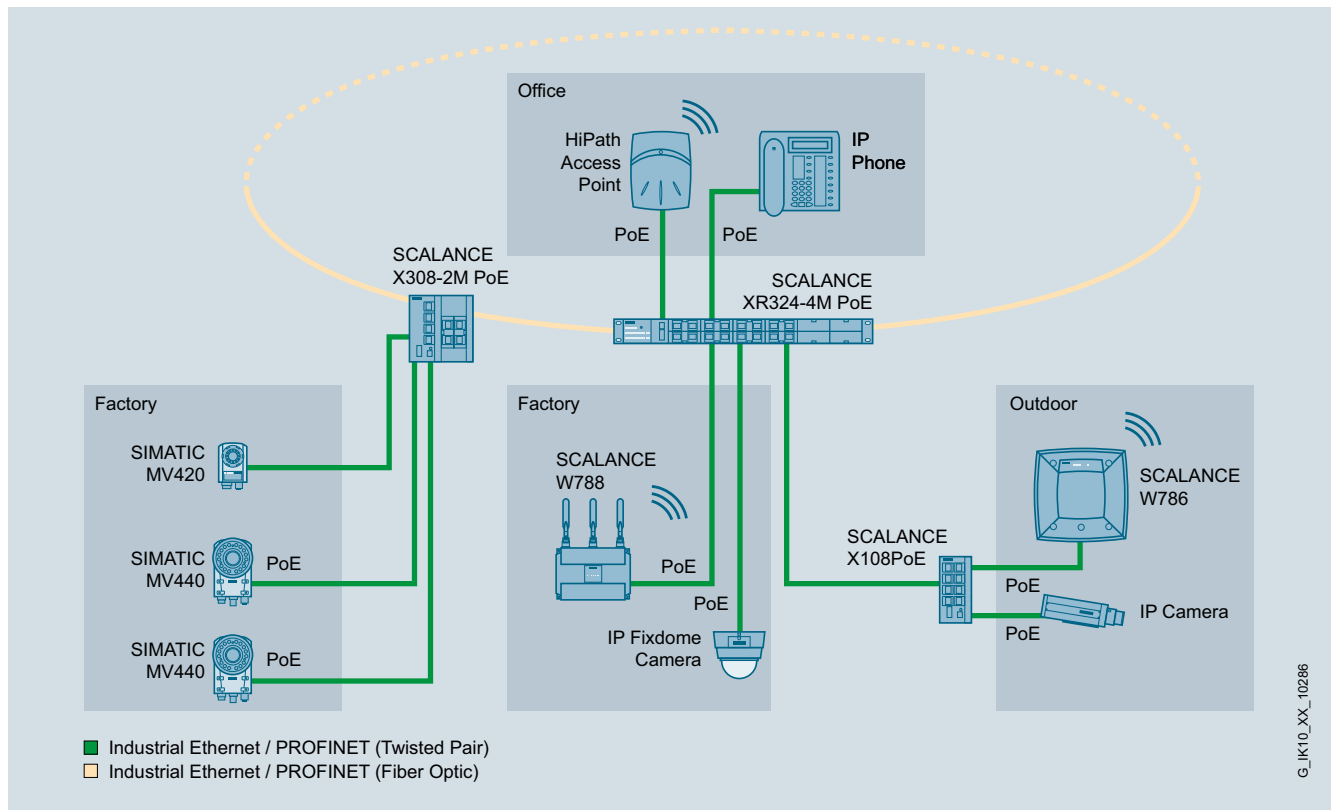

Supply of terminal devices with PoE by means of PoE-compatible switches

## Design

The SCALANCE X-300 Industrial Ethernet switches with their robust metal enclosure are optimized for mounting on a standard DIN rail and the S7-300 mounting rail. Direct wall mounting in different positions is also possible. Due to the S7-300 enclosure dimensions, the devices are ideally suited for integration in an automation system using S7-300 components.

The switches have:

- 4-pin terminal block for connection of the redundant power supply (2 x 24 V DC)
- Row of LEDs for indicating status information (power, link status, data transfer, error indication, redundancy manager, standby manager)
- 2-pin terminal block for connecting the isolated signaling contact
- SELECT/SET pushbutton for on-site configuration of the signaling contact
- Slot for optional C-PLUG swap medium on the rear of the device for the easy replacement of the device in the event of a fault
- SCALANCE X308-2M PoE has four integrated electrical, PoE-compatible Ethernet ports and two slots for accommodating 2-port media modules

## PROFINET/Industrial Ethernet

### Industrial Ethernet Switches

#### SCALANCE X-300PoE managed

#### Function

- Support of Power over Ethernet (PoE) according to IEEE 802.3at Type 1 (corresponds to IEEE 802.3af)
- Increase of the network performance; by filtering the data traffic on the basis of the Ethernet (MAC) address of the data terminals, data traffic remains local; only data intended for users of another subnetwork is forwarded by the switch.
- Simple network configuration and network expansion; the switch saves the data received at the ports and forwards it automatically to the destination address. The limitation of the network expansion by collision detection (CSMA/CD procedure) terminates at the port.
- Limitation of the error propagation to the affected subnetwork; the SCALANCE X-300 switches only forward data with a valid checksum (CRC).
- Integration of existing subnetworks with 10 Mbit/s into Fast Ethernet networks with 100 Mbit/s; at the twisted-pair ports, the SCALANCE X-300 switches automatically recognize the conductor pairs for transmission and reception (autocrossover), the data transfer rate of 10 or 100 or 1 000 Mbit/s, as well as full-duplex and half-duplex mode (autonegotiation).
- High-performance connection of SCALANCE X-300 switches with 1 Gbit/s; SCALANCE X-300 PoE switches have up to eight Gigabit Ethernet ports for connecting the switches to each other or with other Gigabit-Ethernet-enabled components (e.g. SCALANCE X-400, X-500)
- Integrated redundancy manager for constructing Fast Ethernet and Gigabit Ethernet ring topologies with high-speed media redundancy.
- High-speed standby redundancy; several network segments such as rings can be interconnected redundantly with SCALANCE X-300 by means of the integrated standby function. Two X-300 switches are configured in a ring as a master and slave and are connected via two links to the other ring. The redundant link can be implemented at 1 000 Mbit/s.
- Redundant interfacing to higher-level networks; SCALANCE X-300 switches support the standardized redundancy procedures Spanning Tree Protocol (STP) and Rapid Spanning Tree Protocol (RSTP). This enables a subnetwork to be connected redundantly to a higher-level network with reduced requirements for the reconfiguration time (in the order of seconds). By supporting the Multiple Spanning Tree Protocol (MSTP), a network can also be split into multiple sub-segments.
- Support of virtual networks (VLAN); for structuring Industrial Ethernet networks with a fast growing number of users, a physically existing network can be divided into several virtual networks.
- Load limiting when multicast protocols (e.g. video transmission) are used; through learning the multicast sources and targets (IGMP Snooping, IGMP Querier), SCALANCE X-300 switches can also filter multicast data traffic and therefore limit the load in the network.
- Configuration of the ports for terminals that support authentication in accordance with IEEE 802.1x. Authentication is by means of a RADIUS server that must be configured appropriately and must be accessible via the network.
- Support of the DHCP Option 82, 66, 67 (Dynamic Host Configuration Protocol); this facilitates the IP address assignment of a terminal depending on the connected switch port. The IP address is assigned via a DHCP Server, which has to be configured accordingly and must be able to be reached via the network.
- Support of Access Control List (ACL); if this function is activated for a port, the switch only forwards message frames received at this port if their source address is listed in the address table. All connected nodes can be automatically entered in the ACL.
- Syslog; Syslog compliant with RFC 3164 is used in the IP network for transmitting short, unencrypted text messages via UDP. This requires the use of a Syslog server that must be configured appropriately and must be accessible via the network.
- Time synchronization; diagnostic messages (log table entries, e-mails) are time-stamped. The local time is standardized throughout the network by means of synchronization with a SICLOCK time transmitter, SNTP or NTP server or via IEEE1588, thereby simplifying the assignment of diagnostic messages of several devices.

#### Network topology and network configuration

The SCALANCE X-300 Industrial Ethernet switches are typically accommodated together with the nodes to be connected in one control cabinet. Electrical and optical versions can be installed together in star, line and ring topologies.

The following network structures and combinations of structures can be implemented:

- Fast Ethernet and Gigabit Ethernet rings with fast media redundancy; to increase network availability, as many as 50 X-200, X-300, X-400 or X-500 switches can be cascaded in line can be connected into a ring.
- Several rings can be redundantly linked through the standby function.
- At the same time, SCALANCE X-300 supports redundant connection of the ring structure to the corporate network with Rapid Spanning Tree.
- Star topology with SCALANCE X300PoE switches: The SCALANCE X-308-2M PoE switch represents a neutral point that can connect up to eight nodes or subnets with each other electrically or optically.

When configuring the network, it is necessary to observe the following boundary conditions:

- Maximum line length between two modules for multi-mode fiber-optic conductors:
  - 750 m at 1 Gbit/s
  - 5 km at 100 Mbit/s
- Maximum line length between two modules for single-mode fiber-optic conductors:
  - 10 to 120 km at 1 Gbit/s
  - 26 to 70 km at 100 Mbps
- Maximum cable length of the TP cable between two SCALANCE X switches:
  - Max. 100 m at 10/100 Mbit/s with IE FC Cable 2x2 and IE FC RJ45 Plug 180
  - Max. 100 m at 1 Gbit/s with IE FC Standard Cable 4x2 (90 m), IE FC RJ45 Modular Outlet and patch cable (10 m)
  - Max. 10 m using patches with TP cord

**Function** (continued)

**Commissioning and diagnostics**

Setting options on the device itself:

- Redundancy manager RM; to establish a ring, a SCALANCE X-300 is switched to RM mode. The Gigabit ports (electrical or optical) are preferably used as ring ports.
- Signal mask; the signal mask is set to the current status of the SCALANCE X-300 (setpoint) by pushbutton operation. The signal mask defines which ports and which power supplies are to be monitored. The signaling contact only reports an error when a monitored port or a monitored feeder fails (deviation of setpoint/actual status).
- IP address; the IP address is assigned via DHCP (Dynamic Host Configuration Protocol). If there is no corresponding server in the network, the IP address can be assigned using an enclosed software tool.

Diagnostic options on site:

- The following status information is displayed by LEDs on site:
  - Port status
  - Port mode (10/100/1 000 Mbit/s, full/half-duplex)
  - Status of the two power supplies
  - Signaling contact status
  - Signal mask (setpoint status)
  - RM mode
  - Standby mode
- The status of the signaling contact is routed externally by means of floating relay contacts. This enables, for example, the module to be monitored via an input module from a controller.
- Monitoring via the Industrial Ethernet network; the following possibilities are available:
  - Remote via standard browser (Web-based management): Selection of SCALANCE X-300 switches via the network from a PC with browser
  - Remote via SNMP V1, V2c, V3: Secure integration of SCALANCE X-300 switches via the network into a network management system, e.g. SINEMA Server
  - Remote via PROFINET IO diagnostics: PROFINET diagnostic alarms from SCALANCE X-300 switches can be displayed using the relevant SIMATIC engineering tools and they can also be processed in the controller. The engineering outlay for the PLC and HMI have been drastically reduced due to the complete integration in the SIMATIC concept for system error messages.

**Network management**

The network management provides the following functions:

- Password-protected dial-up for "Administrator" (read and write authorization) and "User" (read only)
- Read-out of version and status information
- Setting the signal and standby mask and address information
- Fixed parameterization of the ports (data rates, half/full duplex)
- Setting parameters of the VLANs and multicast services
- Parameterization of the standby connections for a redundant ring link
- Setting of Rapid Spanning Tree parameters
- Parameterization of the web management services
- Security
  - Ports can be connected or disconnected
  - Authentication in accordance with IEEE 802.1x
  - Support of Access Control List (ACL)
- Parameterization of user administration of SNMP V1, V2c, V3:
- Output of statistics information
- Diagnosis of data traffic by means of a parameterizable mirror port with a standard commercial network analyzer
- Loading of new firmware versions or of the configuration data via the network by a TFTP server or directly via HTTP/HTTPS using a Web browser
- Saving the configuration data or log table via the network on a TFTP server

If faults occur in the network, the SCALANCE X-300 switch can independently send error messages (traps) to a network management system or also e-mails to a predefined network administrator.

Remote monitoring (RMON) provides the following functions: The SCALANCE X-300 switches can collect statistics information according to the RMON groups 1 through 4. These include, for example, fault statistics that are kept for each port. This information can be read out through web-based management in the statistics sub-area.

# PROFINET/Industrial Ethernet

## Industrial Ethernet Switches

### SCALANCE X-300PoE managed

#### Technical specifications

Article No.	6GK5308-2QG00-2AA2
Product-type designation	SCALANCE X308-2M POE
<b>Transmission rate</b>	
Transfer rate 1	10 Mbit/s
Transfer rate 2	100 Mbit/s
Transfer rate 3	1 000 Mbit/s
<b>Interfaces</b>	
Number of electrical/optical connections for network components or terminal equipment maximum	8
Number of electrical connections	
• for network components and terminal equipment	4
• for Power-over-Ethernet for network components or terminal equipment	4
• for operator console	-
• for signaling contact	1
• for media module	2
• for power supply	1
• for redundant power supply	1
Design of electrical connection	
• for network components and terminal equipment	RJ45 port
• for Power-over-Ethernet for network components or terminal equipment	RJ45 port
• for signaling contact	2-pole terminal block
• for power supply	4-pole terminal block
Design of optical interface for optical waveguide	
• at 100 Mbit/s	Dependent on selected media modules
• at 1 000 Mbit/s	Dependent on selected media modules
Design of the removable storage C-PLUG	Yes
<b>Signal-Inputs/outputs</b>	
Operating voltage of signaling contacts at DC rated value	24 V
Operating current of signaling contacts at DC maximum	0.1 A
<b>Supply voltage, current consumption, power loss</b>	
Type of supply voltage redundant power supply unit	No
Type of supply voltage	DC
Supply voltage external	24 V
• minimum	19.2 V
• maximum	28.8 V
Product component fusing at power supply input	Yes
Type of fusing at input for supply voltage	F 3 A / 32 V
Consumed current maximum	2 A
Active power loss	
• at 24 V for DC	17 W

Article No.	6GK5308-2QG00-2AA2
Product-type designation	SCALANCE X308-2M POE
<b>Permitted ambient conditions</b>	
Ambient temperature	
• during operating	-40 ... +60 °C
• during storage	-40 ... +70 °C
• during transport	-40 ... +70 °C
• Comment	If the device is installed in the vertical position, the maximum operating temperature is reduced to 60 °C.
Relative humidity at 25 °C without condensation during operating maximum	95 %
Ambient condition for (standard) operation mode	-
Protection class IP	IP20
<b>Design, dimensions and weight</b>	
Design	compact
Width	120 mm
Height	125 mm
Depth	124 mm
Net weight	1.15 kg
Mounting type	
• 19-inch installation	No
• 35 mm DIN rail mounting	Yes
• wall mounting	Yes
• S7-300 rail mounting	Yes
Mounting type	When using SFP plug transceivers, only horizontal mounting is permitted; when used in shipbuilding, installation on a 35 mm standard mounting rail is not permitted
<b>Product properties, functions, components general</b>	
Cascading in the case of a redundant ring at reconfiguration time of < 0.3 s	50
Cascading in cases of star structuring	Any (depending only on signal propagation time)
<b>Product functions management, configuration</b>	
Product function	
• CLI	Yes
• web-based management	Yes
• MIB support	Yes
• TRAPs via email	Yes
• Configuration with STEP 7	Yes
• RMON	Yes
• SMTP server	-
• Port mirroring	Yes
• CoS	Yes
• for IRT PROFINET IO switch	-
• PROFINET IO diagnosis	Yes
• switch-managed	Yes

**Technical specifications (continued)**

Article No.	6GK5308-2QG00-2AA2	Article No.	6GK5308-2QG00-2AA2
Product-type designation	SCALANCE X308-2M POE	Product-type designation	SCALANCE X308-2M POE
Protocol is supported		<b>Product functions Security</b>	
• Telnet	Yes	Product function	
• HTTP	Yes	• ACL - port/MAC-based	Yes
• HTTPS	Yes	• IEEE 802.1x (radius)	Yes
• TFTP	Yes	• Broadcast/Multicast/Unicast Limiter	Yes
• FTP	Yes	• broadcast blocking	Yes
• BOOTP	Yes	Protocol is supported SSH	Yes
• SNMP v1	Yes	<b>Product functions Time</b>	
• SNMP v2	Yes	Product function SICLOCK support	Yes
• SNMP v3	Yes	Protocol is supported	
• IGMP (snooping/querier)	Yes	• NTP	Yes
• GMRP	Yes	• SNTP	Yes
• DCP	Yes	• IEEE 1588 profile default	Yes
• LLDP	Yes	<b>Standards, specifications, approvals</b>	
Identification & maintenance function		Standard	
• I&M0 - device-specific information	Yes	• for EMC from FM	FM3611: Class 1, Division 2, Group A, B, C, D / T4, Class 1, Zone 2, Group IIC, T4
• I&M1 - higher level designation/location designation	Yes	• for hazardous zone	EN 60079-0 : 2006, EN 60079-15: 2005, II 3 G Ex nA II T4 KEMA 07 ATEX 0145X
<b>Product functions Diagnosis</b>		• for safety of CSA and UL	UL 60950-1, CSA C22.2 No. 60950-1
Product function		• for hazardous area of CSA and UL	UL 1604 and UL 2279-15 (Hazardous Location), CSA C22.2 No. 213-M1987, Class 1 / Division 2 / Group A, B, C, D / T4, Class 1 / Zone 2 / Group IIC / T4
• Port diagnostics	Yes	• for emitted interference	EN 61000-6-4:2007 (Class A)
• Statistics packet size	Yes	• for interference immunity	EN 61000-6-2:2005
• Statistics packet type	Yes	Verification of suitability	EN 61000-6-2:2005, EN 61000-6-4:2007
• Error statistics	Yes	• CE mark	Yes
• SysLog	Yes	• C-Tick	Yes
<b>Product functions VLAN</b>		• KC approval	No
Product function		• Railway application in accordance with EN 50155	No
• VLAN - port based	Yes	• Railway application in accordance with EN 50124-1	-
• VLAN dynamic	Yes	Marine classification association	
Number of VLANs maximum	255	• American Bureau of Shipping Europe Ltd. (ABS)	-
Number of VLANs - dynamic maximum	255	• Bureau Veritas (BV)	-
Protocol is supported GVRP	Yes	• Det Norske Veritas (DNV)	-
<b>Product functions DHCP</b>		• Germanische Lloyd (GL)	-
Product function		• Lloyds Register of Shipping (LRS)	-
• DHCP client	Yes	• Nippon Kaiji Kyokai (NK)	-
• DHCP Option 82	Yes		
• DHCP Option 66	Yes		
• DHCP Option 67	Yes		
<b>Product functions Redundancy</b>			
Product function			
• Ring redundancy	Yes		
• Redundancy manager	Yes		
• Standby redundancy	Yes		
• High Speed Redundancy Protocol (HRP)	Yes		
• Media Redundancy Protocol (MRP)	Yes		
• redundancy procedure STP	Yes		
• RSTP redundancy protocol	Yes		
• redundancy procedure MSTP	Yes		
• Passive listening	Yes		
Protocol is supported			
• STP/RSTP	Yes		
• STP	Yes		
• RSTP	Yes		
• RSTP big network support	Yes		
• LACP	Yes		

# PROFINET/Industrial Ethernet

## Industrial Ethernet Switches

### SCALANCE X-300PoE managed

#### Ordering data

#### Article No.

#### Article No.

##### SCALANCE X-300PoE Industrial Ethernet switches

PoE-compatible Industrial Ethernet Switches for setting up electrical and/or optical Industrial Ethernet networks; integrated redundancy manager, IT functions (RSTP, VLAN, ...), network management via SNMP and web server; incl. operating instructions, Industrial Ethernet manual and configuration software on CD-ROM; C-PLUG included in scope of supply

##### Full Gigabit Ethernet switches

- **SCALANCE X308-2M PoE;** 4 x 10/100/1 000 Mbit/s RJ45 ports with PoE, electrical; 2 x 10/100/1 000 Mbit/s slots for 2-port media modules, electrical or optical

**6GK5308-2QG00-2AA2**

##### Media modules

See "Media modules for modular SCALANCE X-300 managed"

##### Accessories

##### IE FC TP Standard Cable GP 2 x 2 (Type A)

4-core, shielded TP installation cable for connection to IE FC outlet RJ45/IE FC RJ45 plug; PROFINET-compatible; with UL approval; sold by the meter; max. quantity 1 000 m, minimum order 20 m

**6XV1840-2AH10**

##### IE FC TP Standard Cable GP 4 x 2

8-core, shielded TP installation cable for connection to IE FC RJ45 modular outlet for universal use; with UL approval; sold by the meter; max. quantity 1 000 m, minimum order 20 m

**6XV1870-2E**

##### IE TP Cord RJ45/RJ45

TP cable 4 x 2 with two RJ45 plugs

- 0.5 m
- 1 m
- 2 m
- 6 m
- 10 m

**6XV1870-3QE50**  
**6XV1870-3QH10**  
**6XV1870-3QH20**  
**6XV1870-3QH60**  
**6XV1870-3QN10**

##### IE FC RJ45 Plug 180 2 x 2

RJ45 plug-in connector for Industrial Ethernet with a rugged metal enclosure and integrated insulation displacement contacts for connecting Industrial Ethernet FC installation cables; with 180° cable outlet; for network components and CPs/CPUs with Industrial Ethernet interface

- 1 package = 1 unit
- 1 package = 10 units
- 1 package = 50 units

**6GK1901-1BB10-2AA0**  
**6GK1901-1BB10-2AB0**  
**6GK1901-1BB10-2AE0**

##### Accessories

##### IE FC RJ45 Plug 4 x 2

RJ45 plug-in connector for Industrial Ethernet (10/100/1 000 Mbit/s) with a rugged metal enclosure and integrated insulation displacement contacts for connecting Industrial Ethernet FC installation cables; 180° cable outlet; for network components and CPs/CPUs with Industrial Ethernet interface

- 1 pack = 1 unit
- 1 pack = 10 units
- 1 pack = 50 units

**6GK1901-1BB11-2AA0**  
**6GK1901-1BB11-2AB0**  
**6GK1901-1BB11-2AE0**

##### FC SC Plug

Screw connector for on-site assembly on FC fiber-optic cable; (1 pack = 10 Duplex Plugs + cleaning cloths)

**6GK1900-1LB00-0AC0**

##### IE FC Stripping Tool

Preadjusted stripping tool for fast stripping of the Industrial Ethernet FC cables

**6GK1901-1GA00**

##### FC FO termination kit

Assembly case for local assembly of FC SC and FC BFOC connectors to FC FO standard cable, comprising a stripping tool, Kevlar cutters, fiber breaking tool and microscope

**6GK1900-1GL00-0AA0**

##### IE FC RJ45 Modular Outlet

FastConnect RJ45 outlet for Industrial Ethernet with interface for insertion of a replacement insert;

- **with insert 2FE** ; replacement insert for 2 x 100 Mbit/s interface
- **with insert 1GE** ; replacement insert for 1 x 1 000 Mbit/s interface

**6GK1901-1BE00-0AA1**

**6GK1901-1BE00-0AA2**

##### SITOP compact PSU100C 24 V/1.3 A

1-phase power supply with wide-range input 85 ... 264 VAC/110 ... 300 V DC, stabilized output voltage 24 V, rated output current value 1.3 A, slim design

**6EP1331-5BA10**

2



**More information****Selection tool:**

To assist in selecting the right Industrial Ethernet switches as well as configuration of modular variants, the SIMATIC NET Selection Tool and the TIA Selection Tool are available at:

SIMATIC NET Selection Tool:

- Online version:  
<http://www.siemens.com/snst>
- Offline version:  
<http://www.siemens.com/snst-download>

TIA Selection Tool:

<http://www.siemens.com/tia-selection-tool>

## PROFINET/Industrial Ethernet

### Industrial Ethernet Switches

#### SCALANCE XR-300PoE managed

##### Overview



The SCALANCE XR-300PoE Industrial Ethernet switches are partly modular, high-performance, industry-standard switches for the construction of electrical and/or optical line, ring and star topologies at data transfer rates of 10/100/1 000 Mbit/s, designed for installation in 19" control cabinets

- As many as 24 electrical and/or optical interfaces (10/100/1 000 Mbit/s), of which 16 are integrated RJ45 ports, eight of which are PoE-compatible; up to four electrical and/or optical 2-port media modules can additionally be inserted in the media module slots of the basic unit
- High-speed media redundancy through integral redundancy manager both for Gigabit Ethernet (with SCALANCE X-300, X-400) and Fast Ethernet (e.g. in combination with SCALANCE X-200 switches)
- Seamless integration of automation networks into existing corporate networks thanks to support for a host of IT standard functions (VLANs, IGMP-Snooping/Querier, STP/RSTP, Link Aggregation, Quality of Service)
- Redundant integration into higher-level networks thanks to support for standardized redundancy procedures (Spanning Tree Protocol/Rapid Reconfiguration Spanning Tree Protocol/ MRP)
- Remote diagnostics by means of PROFINET diagnostics, Web browser, CLI, or SNMP

##### Benefits



- Unlimited flexibility during network expansions (e.g. more terminals) or conversion (e.g. switching from copper to fiber-optic cable) and reduction of the storage costs due to the modular construction using port modules
- Saving of additional power supply units and cabling for terminals by means of PoE voltage supply
- High availability of the network due to
  - redundant voltage feed
  - redundant network structures based on FOC or Twisted Pair (redundancy manager, standby function and STP/RSTP integrated)
  - easy device replacement by means of plug-in C-PLUG swap medium
  - very fast reconfiguration of the network in event of a fault
- lower susceptibility to faults and higher availability of the plant networking by latching the RJ45 FastConnect plug in the retaining collar of the RJ45 port modules
- Protection of investment through integration into existing network management systems by means of standardized SNMP access
- Time saving during engineering, commissioning and in the operating phase of a plant due to integrated configuration and diagnostics in STEP 7, without additional software
- Space savings in control cabinet due to flexible cable outlet on the front or rear of the device

##### Application

The SCALANCE XR-300PoE is ideal for use in plant networks and for integrating the industrial network into an existing corporate network. Both at the field level and the control level, the switch performs the network with the distributed field devices and ensures high plant availability with extensive diagnostics options and high transmission speeds. The modularity permits perfect adaptation to the respective application through the use of electrical and also optical media modules.

The SCALANCE XR-300PoE supplies PoE-compatible devices, such as IWLAN access points SCALANCE W, IP cameras and IP telephones, with energy over the data cable and is suitable for constructing electrical and/or optical Industrial Ethernet linear, star or ring structures with up to 24 ports, of which 16 RJ45 ports are pre-assigned. Eight of these support PoE. The switch can be optionally equipped with four electrical and/or optical 2-port media modules. It can also be used as a hub in the plant bus (redundant connection is possible).

The SCALANCE XR324-4M PoE TS (**T**ransportation **S**ystems) is suitable for use in railway applications due to its EN 50155 specification. Media modules that have been approved for train applications must be used.

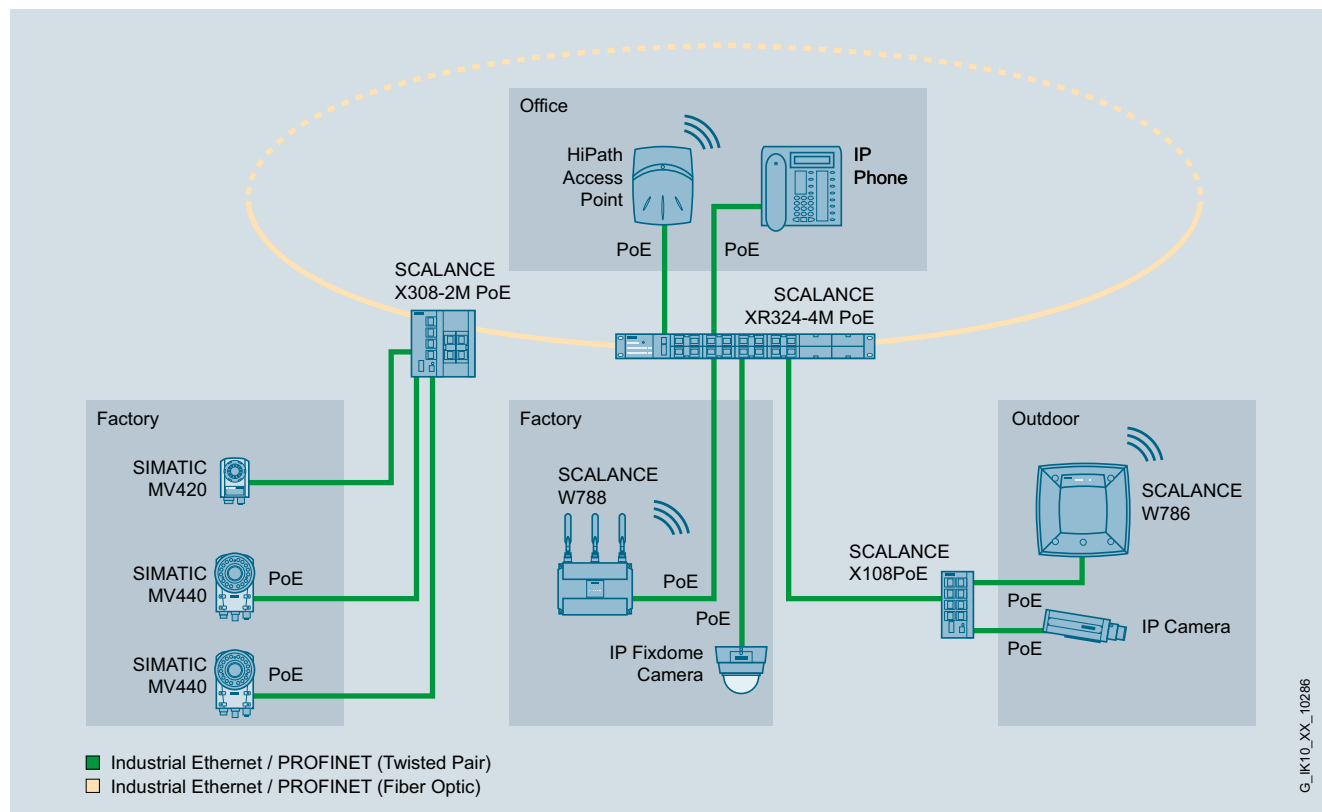
**Application** (continued)

Supply of terminal devices with PoE by means of PoE-compatible switches

The use of media modules in partly and fully modular versions of the SCALANCE X-300 switches supports:

- The extension of networks by subsequent insertion of additional media modules in unused media module slots
- The changing of cabling technology, e.g. conversion from copper to fiber-optic cables, or from multimode to single-mode FOC

**Design**

The SCALANCE XR-300PoE Industrial Ethernet switches with rugged metal enclosure with IP20 degree of protection are optimized for installation in the 19" control cabinet. Versions are available with either 24 V DC or 100 - 240 V AC connections. The connection of the power supply and the data cable outlet are located optionally either at the front or rear of the device.

The switches have:

- 4-pin terminal block for redundant voltage feed to protected against power failure at 24 V DC
- 2-pin terminal block for voltage feed at 100 - 240 V AC
- 2-pin terminal block for connecting the isolated signaling contact for simple display of faults
- Row of LEDs for indicating status information (power, link status, data transfer, power supply, signal contact)
- SELECT/SET pushbutton for easy setting of the fault signal contact on the device
- Slot for optional C-PLUG swap medium on the side of the device for easy replacement of the device in the event of a fault
- Console port (serial interface) for on-site parameterization/diagnostics (RJ11 cable to RS232 (9-pin) included in scope of delivery)

The SCALANCE XR-300PoE switches are available with the following types of port:

- 16 integrated RJ45 ports, eight RJ45 ports supporting PoE;
- The RJ45 sockets are designed to industry standards with additional retaining collars for the connection of the Industrial Ethernet FC RJ45 Plug 180
- All electrical Ethernet interfaces support 10/100/1 000 Mbit/s, all optical Ethernet interfaces support 100 or 1 000 Mbit/s
- The SCALANCE XR-300 switches support Gigabit Ethernet (1 000 Mbit/s) at all ports. The 24 ports are divided into three groups of eight ports each (Gigabit Ethernet Blocking). Gigabit Ethernet is supported with full wire speed within each group, but not between the groups.

## PROFINET/Industrial Ethernet

### Industrial Ethernet Switches

#### SCALANCE XR-300PoE managed

##### Design (continued)

##### Product versions

##### SCALANCE XR324-4M PoE (4 media module slots)

Versions are available with

- LEDs, power supply connection and data cable outlet at the front
- LEDs at the front, power supply connection and data cable outlet at the rear

All versions have twelve media module slots and

- 1 x 24 V DC power supply unit
- 1 x 100 - 240 V AC power supply unit

##### SCALANCE XR324-4M PoE TS(4 media module slots)

A version is available with

- LEDs, power supply connection and data cable outlet on the front;

All versions have four media module slots and

- 1 x 24 V DC power supply unit

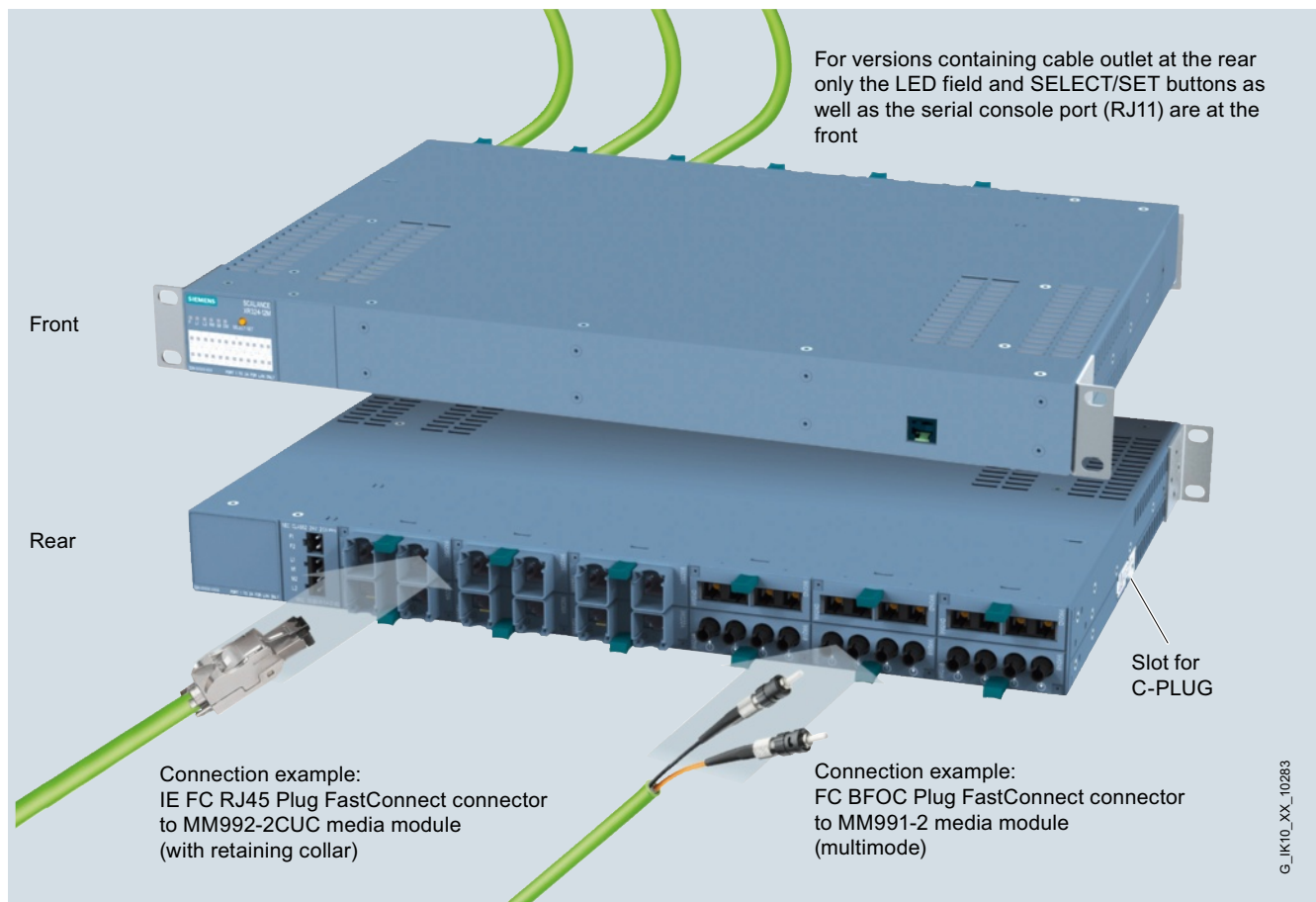

SCALANCE XR-300 with cable outlet at rear

**Function**

- Support of Power over Ethernet (PoE) to IEEE 802.3at Type1 (corresponds to IEEE 802.3af)
- Integrated redundancy manager for constructing Fast Ethernet and Gigabit Ethernet ring topologies with high-speed media redundancy. Reliable communication is achieved by closing an optical or electrical line with SCALANCE X-400, X-300 or X-200 switches to form a ring. The redundancy manager (RM) integrated in the SCALANCE XR-300 switch monitors the function of the network. It recognizes the failure of a transmission link or of SCALANCE X switch in the ring and activates the substitute path within a maximum of 0.2 seconds.
- Redundant interfacing to company networks; SCALANCE XR-300 switches support the standardized redundancy procedures Spanning Tree Protocol (STP) and Rapid Spanning Tree Protocol (RSTP). This enables a subnetwork to be connected redundantly to a higher level corporate network with reduced requirements for the reconfiguration time (in the order of seconds). By supporting the Multiple Spanning Tree Protocol (MSTP), a network can also be split into multiple sub-segments.
- Support of virtual networks (VLAN); for structuring Industrial Ethernet networks with a fast growing number of users, a physically existing network can be divided into several virtual networks.
- Load limiting when multicast protocols (e.g. video transmission) are used; through learning the multicast sources and targets (IGMP Snooping, IGMP Querier), SCALANCE XR-300 switches can also filter multicast data traffic and therefore limit the load in the network. Multicast and broadcast traffic can be limited.
- Time synchronization; diagnostic messages (log table entries, e-mails) are time-stamped. The local time is standardized throughout the network by means of synchronization with a SICLOCK, or SNTP / NTP time transmitter or via IEEE1588, thereby simplifying the assignment of diagnostic messages of multiple devices.
- Link aggregation (IEEE 802.1q) for bundling data streams
- Quality of Service (IEEE 802.1p) for prioritization of network traffic

**Network topology and network configuration**

The network topology can easily be adapted to the structure of the plant using SCALANCE XR-300 Industrial Ethernet switches.

The following network structures and combinations of structures can be implemented:

- Fast Ethernet with fast media redundancy; to increase network availability, as many as 50 X-200, X-300, X-400 or X-500 switches cascaded in line can be connected into a ring.
- Several rings can be redundantly linked through the standby function
- In addition, SCALANCE XR-300 supports redundant connection of the ring structure to the corporate network with a rapid spanning tree.
- Star topology with SCALANCE XR-300 switches: Each SCALANCE XR-300 switch represents a neutral point that can connect up to 24 nodes or subnets with each other electrically.

When configuring the network, it is necessary to observe the following boundary conditions:

- Maximum line length between two modules for multi-mode fiber-optic conductors:
  - 5 km at 100 Mbit/s
  - 750 m at 1 Gbit/s
- Maximum line length between two modules for single-mode fiber-optic conductors:
  - 26 to 70 km at 100 Mbps
  - 10 to 120 km at 1 Gbit/s
- Maximum cable length of the TP cable between two SCALANCE X switches:
  - Max. 100 m at 10/100 Mbit/s with IE FC Cable 2x2 and IE FC RJ45 Plug 180
  - Max. 100 m at 1 Gbit/s with IE FC Standard Cable 4x2 (90 m), IE FC RJ45 Modular Outlet and patch cable (10 m)
  - Max. 10 m using patches with TP cord

## PROFINET/Industrial Ethernet

### Industrial Ethernet Switches

#### SCALANCE XR-300PoE managed

#### Function (continued)

##### Commissioning and diagnostics

Setting options on the device itself:

- Redundancy manager RM; to establish a ring, a SCALANCE XR-300 is switched to RM mode. The Gigabit ports (electrical or optical) are preferably used as ring ports. The non-ring ports of the RM can be used freely for the connection of data terminals and networks. If the redundancy procedure MRP standardized by PROFINET is used, the RM is adjusted automatically.
- Signal mask; the signal mask is set to the current status of the SCALANCE XR-300 (setpoint) by pushbutton operation. The signal mask defines which ports and which power supplies are to be monitored. The signaling contact only reports an error when a monitored port or a monitored feeder fails (deviation of setpoint/actual status).
- IP address; the IP address is assigned via DHCP (Dynamic Host Configuration Protocol). If there is no corresponding server in the network, the IP address can be assigned using an enclosed software tool.

Diagnostic options on site:

- The following status information is displayed by LEDs on site:
  - Port status
  - Port mode (10/100/1 000 Mbit/s, full/half-duplex)
  - Status of the two power supplies
  - Signaling contact status
  - Signal mask (setpoint status)
  - RM mode
  - Standby mode
- The status of the signaling contact is routed externally by means of floating relay contacts. This enables, for example, the module to be monitored via an input module from a controller.
- Monitoring via the Industrial Ethernet network; the following possibilities are available:
  - Remote via standard browser (Web-based management): Selection of SCALANCE XR-300 switches via the network from a PC with browser
  - Remote via SNMP V1, V2c, V3: Secure integration of SCALANCE XR-300 switches via the network into a network management system, e.g. SINEMA Server
  - Remote via PROFINET IO diagnostics: PROFINET diagnostic alarms from SCALANCE X-300 switches can be displayed using the relevant SIMATIC engineering tools and they can also be processed in the controller. The engineering outlay for the PLC and HMI have been drastically reduced due to the complete integration in the SIMATIC concept for system error messages.

##### Network management

The network management provides the following functions:

- Password-protected dial-up for "Administrator" (read and write authorization) and "User" (read only)
- Read-out of version and status information
- Setting the signal and standby mask and address information
- Fixed parameterization of the ports (data rates, half/full duplex)
- Setting of Spanning/Rapid Spanning Tree parameters
- Parameterization of the web management services
- Security
  - Ports can be connected or disconnected
  - Port-based network access control according to IEEE 802.1x
  - Authentication in accordance with IEEE 802.1x (available soon)
  - Support of Access Control List (ACL) (available soon)
- Output of statistics information
- Diagnosis of data traffic by means of a parameterizable mirror port with a standard commercial network analyzer
- Loading of new firmware versions or of the configuration data via the network by a TFTP server or directly via HTTP/HTTPS using a Web browser
- Saving the configuration data or log table via the network on a TFTP server

If faults occur in the network, the SCALANCE XR-300 switch can independently send error messages (traps) to a network management system or also e-mails to a predefined network administrator.

Remote monitoring (RMON) provides the following functions: The SCALANCE XR-300 switch can collect statistics information according to the RMON groups 1 through 4. These include, for example, fault statistics that are kept for each port. This information can be read out through web-based management in the statistics sub-area.

**Technical specifications**

Article No.	6GK5324-4QG00-1AR2	6GK5324-4QG00-1HR2	6GK5324-4QG00-1CR2
Product-type designation	SCALANCE XR324-4M POE	SCALANCE XR324-4M POE	SCALANCE XR324-4M POE TS
<b>Transmission rate</b>			
Transfer rate 1	10 Mbit/s	10 Mbit/s	10 Mbit/s
Transfer rate 2	100 Mbit/s	100 Mbit/s	100 Mbit/s
Transfer rate 3	1 000 Mbit/s	1 000 Mbit/s	1 000 Mbit/s
<b>Interfaces</b>			
Number of electrical/optical connections for network components or terminal equipment maximum	24	24	24
Number of electrical connections			
• for network components and terminal equipment	16	16	16
• for Power-over-Ethernet for network components or terminal equipment	8	8	8
• for operator console	1	1	1
• for signaling contact	1	1	1
• for media module	4	4	4
• for power supply	1	1	1
• for redundant power supply	1	1	0
Design of electrical connection			
• for network components and terminal equipment	RJ45 port	RJ45 port	RJ45 port
• for Power-over-Ethernet for network components or terminal equipment	RJ45 port	RJ45 port	RJ45 port
• for operator console	RJ11 port	RJ11 port	RJ11 port
• for signaling contact	2-pole terminal block	2-pole terminal block	2-pole terminal block
• for power supply	4-pole terminal block	4-pole terminal block	4-pole terminal block
Design of optical interface for optical waveguide			
• at 100 Mbit/s	Dependent on selected media modules	Dependent on selected media modules	Dependent on selected media modules
• at 1 000 Mbit/s	Dependent on selected media modules	Dependent on selected media modules	Dependent on selected media modules
design of the removable storage C-PLUG	Yes	Yes	Yes
<b>Signal-Inputs/outputs</b>			
Operating voltage of signaling contacts at DC rated value	24 V	24 V	24 V
Operating current of signaling contacts at DC maximum	0.1 A	0.1 A	0.1 A
<b>Supply voltage, current consumption, power loss</b>			
Type of supply voltage redundant power supply unit	No	No	No
Type of supply voltage	DC	DC	DC
Supply voltage external	24 V	24 V	24 V
• minimum	19.2 V	19.2 V	19.2 V
• maximum	28.8 V	28.8 V	28.8 V
Product component fusing at power supply input	Yes	Yes	Yes
Type of fusing at input for supply voltage	F 5 A / 250 V	F 5 A / 250 V	F 5 A / 250 V
Consumed current maximum	4.2 A	4.2 A	4.2 A
Active power loss			
• at 24 V for DC	46 W	46 W	46 W

## PROFINET/Industrial Ethernet

### Industrial Ethernet Switches

#### SCALANCE XR-300PoE managed

#### Technical specifications (continued)

Article No.	6GK5324-4QG00-1AR2	6GK5324-4QG00-1HR2	6GK5324-4QG00-1CR2
Product-type designation	SCALANCE XR324-4M POE	SCALANCE XR324-4M POE	SCALANCE XR324-4M POE TS
<b>Permitted ambient conditions</b>			
Ambient temperature			
• during operating	-40 ... +60 °C	-40 ... +60 °C	-40 ... +70 °C
• during storage	-40 ... +85 °C	-40 ... +85 °C	-40 ... +85 °C
• during transport	-40 ... +85 °C	-40 ... +85 °C	-40 ... +85 °C
• Comment	If the device is installed in the vertical position, the maximum operating temperature is reduced to 60 °C.	If the device is installed in the vertical position, the maximum operating temperature is reduced to 60 °C.	If the device is installed in the vertical position, the maximum operating temperature is reduced to 60 °C.
Relative humidity at 25 °C without condensation during operating maximum	95 %	95 %	95 %
Ambient condition for (standard) operation mode	-	-	Conformal coating, yes
Protection class IP	IP20	IP20	IP20
<b>Design, dimensions and weight</b>			
Design	19" rack	19" rack	19" rack
Width	449 mm	449 mm	449 mm
Height	43.6 mm	43.6 mm	43.6 mm
Depth	305 mm	305 mm	305 mm
Net weight	6.8 kg	6.8 kg	6.8 kg
Mounting type			
• 19-inch installation	Yes	Yes	Yes
• 35 mm DIN rail mounting	No	No	No
• wall mounting	No	No	No
• S7-300 rail mounting	No	No	No
Mounting type	When used in shipbuilding, the device must be secured in the 19" rack at four points	When used in shipbuilding, the device must be secured in the 19" rack at four points	When used in shipbuilding, the device must be secured in the 19" rack at four points
<b>Product properties, functions, components general</b>			
Cascading in the case of a redundant ring at reconfiguration time of < 0.3 s	50	50	50
Cascading in cases of star structuring	Any (depending only on signal propagation time)	Any (depending only on signal propagation time)	Any (depending only on signal propagation time)
<b>Product functions management, configuration</b>			
Product function			
• CLI	Yes	Yes	Yes
• web-based management	Yes	Yes	Yes
• MIB support	Yes	Yes	Yes
• TRAPs via email	Yes	Yes	Yes
• Configuration with STEP 7	Yes	Yes	Yes
• RMON	Yes	Yes	Yes
• Port mirroring	Yes	Yes	Yes
• CoS	Yes	Yes	Yes
• PROFINET IO diagnosis	Yes	Yes	Yes
• switch-managed	Yes	Yes	Yes



**Technical specifications (continued)**

Article No.	6GK5324-4QG00-1AR2	6GK5324-4QG00-1HR2	6GK5324-4QG00-1CR2
Product-type designation	SCALANCE XR324-4M POE	SCALANCE XR324-4M POE	SCALANCE XR324-4M POE TS
Protocol is supported			
• Telnet	Yes	Yes	Yes
• HTTP	Yes	Yes	Yes
• HTTPS	Yes	Yes	Yes
• TFTP	Yes	Yes	Yes
• FTP	Yes	Yes	Yes
• BOOTP	Yes	Yes	Yes
• SNMP v1	Yes	Yes	Yes
• SNMP v2	Yes	Yes	Yes
• SNMP v3	Yes	Yes	Yes
• IGMP (snooping/querier)	Yes	Yes	Yes
• GMRP	Yes	Yes	Yes
• DCP	Yes	Yes	Yes
• LLDP	Yes	Yes	Yes
Identification & maintenance function			
• I&M0 - device-specific information	Yes	Yes	Yes
• I&M1 - higher level designation/location designation	Yes	Yes	Yes
<b>Product functions Diagnosis</b>			
Product function			
• Port diagnostics	Yes	Yes	Yes
• Statistics packet size	Yes	Yes	Yes
• Statistics packet type	Yes	Yes	Yes
• Error statistics	Yes	Yes	Yes
• SysLog	Yes	Yes	Yes
<b>Product functions VLAN</b>			
Product function			
• VLAN - port based	Yes	Yes	Yes
• VLAN dynamic	Yes	Yes	Yes
Number of VLANs maximum	255	255	255
Number of VLANs - dynamic maximum	255	255	255
Protocol is supported GVRP	Yes	Yes	Yes
<b>Product functions DHCP</b>			
Product function			
• DHCP client	Yes	Yes	Yes
• DHCP Option 82	Yes	Yes	Yes
• DHCP Option 66	Yes	Yes	Yes
• DHCP Option 67	Yes	Yes	Yes
<b>Product functions Redundancy</b>			
Product function			
• Ring redundancy	Yes	Yes	Yes
• Redundancy manager	Yes	Yes	Yes
• Standby redundancy	Yes	Yes	Yes
• High Speed Redundancy Protocol (HRP)	Yes	Yes	Yes
• Media Redundancy Protocol (MRP)	Yes	Yes	Yes
• redundancy procedure STP	Yes	Yes	Yes
• RSTP redundancy protocol	Yes	Yes	Yes
• redundancy procedure MSTP	Yes	Yes	Yes
• Passive listening	Yes	Yes	Yes
Protocol is supported			
• STP/RSTP	Yes	Yes	Yes
• STP	Yes	Yes	Yes
• RSTP	Yes	Yes	Yes
• RSTP big network support	Yes	Yes	Yes
• LACP	Yes	Yes	Yes

## PROFINET/Industrial Ethernet

### Industrial Ethernet Switches

#### SCALANCE XR-300PoE managed

#### Technical specifications (continued)

Article No.	6GK5324-4QG00-1AR2	6GK5324-4QG00-1HR2	6GK5324-4QG00-1CR2
Product-type designation	SCALANCE XR324-4M POE	SCALANCE XR324-4M POE	SCALANCE XR324-4M POE TS
<b>Product functions Security</b>			
Product function			
• ACL - port/MAC-based	Yes	Yes	Yes
• IEEE 802.1x (radius)	Yes	Yes	Yes
• Broadcast/Multicast/Unicast Limiter	Yes	Yes	Yes
• broadcast blocking	Yes	Yes	Yes
Protocol is supported SSH	Yes	Yes	Yes
<b>Product functions Time</b>			
Product function SICLOCK support	Yes	Yes	Yes
Protocol is supported			
• NTP	Yes	Yes	Yes
• SNTP	Yes	Yes	Yes
• IEEE 1588 profile default	Yes	Yes	Yes
<b>Standards, specifications, approvals</b>			
Standard			
• for EMC from FM	FM3611: Class 1, Division 2, Group A, B, C, D / T4, Class 1, Zone 2, Group IIC, T4	FM3611: Class 1, Division 2, Group A, B, C, D / T4, Class 1, Zone 2, Group IIC, T4	FM3611: Class 1, Division 2, Group A, B, C, D / T4, Class 1, Zone 2, Group IIC, T4
• for hazardous zone	EN 60079-0 : 2006, EN 60079-15: 2005, II 3 G Ex nA II T4 KEMA 07 ATEX 0145X	EN 60079-0 : 2006, EN 60079-15: 2005, II 3 G Ex nA II T4 KEMA 07 ATEX 0145X	EN 60079-0 : 2006, EN 60079-15: 2005, II 3 G Ex nA II T4 KEMA 07 ATEX 0145X
• for safety of CSA and UL	UL 60950-1, CSA C22.2 No. 60950-1	UL 60950-1, CSA C22.2 No. 60950-1	UL 60950-1, CSA C22.2 No. 60950-1
• for hazardous area of CSA and UL	UL 1604 and UL 2279-15 (Hazardous Location), CSA C22.2 No. 213-M1987, Class 1 / Division 2 / Group A, B, C, D / T4, Class 1 / Zone 2 / Group IIC / T4	UL 1604 and UL 2279-15 (Hazardous Location), CSA C22.2 No. 213-M1987, Class 1 / Division 2 / Group A, B, C, D / T4, Class 1 / Zone 2 / Group IIC / T4	UL 1604 and UL 2279-15 (Hazardous Location), CSA C22.2 No. 213-M1987, Class 1 / Division 2 / Group A, B, C, D / T4, Class 1 / Zone 2 / Group IIC / T4
• for emitted interference	EN 61000-6-4:2007 (Class A)	EN 61000-6-4:2007 (Class A)	EN 61000-6-4:2007 (Class A)
• for interference immunity	EN 61000-6-2:2006	EN 61000-6-2:2006	EN 61000-6-2:2006
Verification of suitability	EN 61000-6-2:2006, EN 61000-6-4:2007	EN 61000-6-2:2006, EN 61000-6-4:2007	EN 61000-6-2:2006, EN 61000-6-4:2007
Verification of suitability			
• CE mark	Yes	Yes	Yes
• C-Tick	Yes	Yes	Yes
• KC approval	No	No	No
• Railway application in accordance with EN 50155	-	-	Yes

Article No.	6GK5324-4QG00-3AR2	6GK5324-4QG00-3HR2
Product-type designation	SCALANCE XR324-4M POE	SCALANCE XR324-4M POE
<b>Transmission rate</b>		
Transfer rate 1	10 Mbit/s	10 Mbit/s
Transfer rate 2	100 Mbit/s	100 Mbit/s
Transfer rate 3	1 000 Mbit/s	1 000 Mbit/s
<b>Interfaces</b>		
Number of electrical/optical connections for network components or terminal equipment maximum	24	24
Number of electrical connections		
• for network components and terminal equipment	16	16
• for Power-over-Ethernet for network components or terminal equipment	8	8
• for operator console	1	1
• for signaling contact	1	1
• for media module	4	4
• for power supply	1	1
• for redundant power supply	0	0

**Technical specifications (continued)**

Article No.	6GK5324-4QG00-3AR2	6GK5324-4QG00-3HR2
Product-type designation	SCALANCE XR324-4M POE	SCALANCE XR324-4M POE
Design of electrical connection		
• for network components and terminal equipment	RJ45 port	RJ45 port
• for Power-over-Ethernet for network components or terminal equipment	RJ45 port	RJ45 port
• for operator console	RJ11 port	RJ11 port
• for signaling contact	2-pole terminal block	2-pole terminal block
• for power supply	2-pole terminal block	2-pole terminal block
Design of optical interface for optical waveguide		
• at 100 Mbit/s	Dependent on selected media modules	Dependent on selected media modules
• at 1 000 Mbit/s	Dependent on selected media modules	Dependent on selected media modules
Design of the removable storage C-PLUG	Yes	Yes
<b>Signal-Inputs/outputs</b>		
Operating voltage of signaling contacts at DC rated value	24 V	24 V
Operating current of signaling contacts at DC maximum	0.1 A	0.1 A
<b>Supply voltage, current consumption, power loss</b>		
Type of supply voltage redundant power supply unit	No	No
Type of supply voltage	AC	AC
Supply voltage external	230 V	230 V
• minimum	85 V	85 V
• maximum	264 V	264 V
Product component fusing at power supply input	Yes	Yes
Consumed current maximum	1 A	1 A
Active power loss		
• at 230 V AC	46 W	46 W
<b>Permitted ambient conditions</b>		
Ambient temperature		
• during operating	-40 ... +70 °C	-40 ... +70 °C
• during storage	-40 ... +85 °C	-40 ... +85 °C
• during transport	-40 ... +85 °C	-40 ... +85 °C
• Comment	If the device is installed in the vertical position, the maximum operating temperature is reduced to 60 °C.	If the device is installed in the vertical position, the maximum operating temperature is reduced to 60 °C.
Relative humidity at 25 °C without condensation during operating maximum	95 %	95 %
Protection class IP	IP20	IP20
<b>Design, dimensions and weight</b>		
Design	19" rack	19" rack
Width	449 mm	449 mm
Height	43.6 mm	43.6 mm
Depth	305 mm	305 mm
Net weight	6.8 kg	6.8 kg
Mounting type		
• 19-inch installation	Yes	Yes
• 35 mm DIN rail mounting	No	No
• wall mounting	No	No
• S7-300 rail mounting	No	No
Mounting type	When used in shipbuilding, the device must be secured in the 19" rack at four points	When used in shipbuilding, the device must be secured in the 19" rack at four points

## PROFINET/Industrial Ethernet

### Industrial Ethernet Switches

#### SCALANCE XR-300PoE managed

#### Technical specifications (continued)

Article No.	6GK5324-4QG00-3AR2	6GK5324-4QG00-3HR2
Product-type designation	SCALANCE XR324-4M POE	SCALANCE XR324-4M POE
<b>Product properties, functions, components general</b>		
Cascading in the case of a redundant ring at reconfiguration time of < 0.3 s	50	50
Cascading in cases of star structuring	Any (depending only on signal propagation time)	Any (depending only on signal propagation time)
<b>Product functions management, configuration</b>		
Product function		
• CLI	Yes	Yes
• web-based management	Yes	Yes
• MIB support	Yes	Yes
• TRAPs via email	Yes	Yes
• Configuration with STEP 7	Yes	Yes
• RMON	Yes	Yes
• Port mirroring	Yes	Yes
• CoS	Yes	Yes
• PROFINET IO diagnosis	Yes	Yes
• switch-managed	Yes	Yes
Protocol is supported		
• Telnet	Yes	Yes
• HTTP	Yes	Yes
• HTTPS	Yes	Yes
• TFTP	Yes	Yes
• FTP	Yes	Yes
• BOOTP	Yes	Yes
• SNMP v1	Yes	Yes
• SNMP v2	Yes	Yes
• SNMP v3	Yes	Yes
• IGMP (snooping/querier)	Yes	Yes
• GMRP	Yes	Yes
• DCP	Yes	Yes
• LLDP	Yes	Yes
Identification & maintenance function		
• I&M0 - device-specific information	Yes	Yes
• I&M1 - higher level designation/location designation	Yes	Yes
<b>Product functions Diagnosis</b>		
Product function		
• Port diagnostics	Yes	Yes
• Statistics packet size	Yes	Yes
• Statistics packet type	Yes	Yes
• Error statistics	Yes	Yes
• SysLog	Yes	Yes
<b>Product functions VLAN</b>		
Product function		
• VLAN - port based	Yes	Yes
• VLAN dynamic	Yes	Yes
Number of VLANs maximum	255	255
Number of VLANs - dynamic maximum	255	255
Protocol is supported GVRP	Yes	Yes

**Technical specifications (continued)**

Article No.	6GK5324-4QG00-3AR2	6GK5324-4QG00-3HR2
Product-type designation	SCALANCE XR324-4M POE	SCALANCE XR324-4M POE
<b>Product functions DHCP</b>		
Product function		
• DHCP client	Yes	Yes
• DHCP Option 82	Yes	Yes
• DHCP Option 66	Yes	Yes
• DHCP Option 67	Yes	Yes
<b>Product functions Redundancy</b>		
Product function		
• Ring redundancy	Yes	Yes
• Redundancy manager	Yes	Yes
• Standby redundancy	Yes	Yes
• High Speed Redundancy Protocol (HRP)	Yes	Yes
• Media Redundancy Protocol (MRP)	Yes	Yes
• redundancy procedure STP	Yes	Yes
• RSTP redundancy protocol	Yes	Yes
• redundancy procedure MSTP	Yes	Yes
• Passive listening	Yes	Yes
Protocol is supported		
• STP/RSTP	Yes	Yes
• STP	Yes	Yes
• RSTP	Yes	Yes
• RSTP big network support	Yes	Yes
• LACP	Yes	Yes
<b>Product functions Security</b>		
Product function		
• ACL - port/MAC-based	Yes	Yes
• IEEE 802.1x (radius)	Yes	Yes
• Broadcast/Multicast/Unicast Limiter	Yes	Yes
• broadcast blocking	Yes	Yes
Protocol is supported SSH	Yes	Yes
<b>Product functions Time</b>		
Product function SICLOCK support	Yes	Yes
Protocol is supported		
• NTP	Yes	Yes
• SNTP	Yes	Yes
• IEEE 1588 profile default	Yes	Yes
<b>Standards, specifications, approvals</b>		
Standard		
• for EMC from FM	No	No
• for hazardous zone	No	No
• for safety of CSA and UL	UL 508, CSA C22.2 No. 142-M1987	UL 508, CSA C22.2 No. 142-M1987
• for hazardous area of CSA and UL	No	No
• for emitted interference	EN 61000-6-4:2007 (Class A)	EN 61000-6-4:2007 (Class A)
• for interference immunity	EN 61000-6-2:2006	EN 61000-6-2:2006
Verification of suitability	EN 61000-6-2:2006, EN 61000-6-4:2007	EN 61000-6-2:2006, EN 61000-6-4:2007
• CE mark	Yes	Yes
• C-Tick	Yes	Yes
• KC approval	No	No

## PROFINET/Industrial Ethernet

### Industrial Ethernet Switches

#### SCALANCE XR-300PoE managed

##### Ordering data

##### Article No.

###### *SCALANCE XR324-4M PoE Industrial Ethernet switches*

Partly modular 19" Industrial Ethernet switches for setting up electrical and optical Industrial Ethernet networks; eight PoE-compatible ports can optionally be equipped with optical or electrical 2-port media modules; all ports support Gigabit Ethernet (blocking), integrated redundancy manager, RSTP, RMON, IGMP-Snooping/Querier, network management via SNMP, PROFINET, and web server  
16 x 10/100/1 000 Mbit/s RJ45 ports, eight of which support PoE;  
4 x 10/100/1 000 Mbit/s slots for 2-port media modules, electrical or optical

###### **SCALANCE XR324-4M PoE**

24 V DC power supply

- Data cable outlet at front
- Data cable outlet at rear

**6GK5324-4QG00-1AR2**  
**6GK5324-4QG00-1HR2**

100 ... 240 V AC power supply

- Data cable outlet at front
- Data cable outlet at rear

**6GK5324-4QG00-3AR2**  
**6GK5324-4QG00-3HR2**

###### **SCALANCE XR324-4M PoE TS**

for railway applications (approval in accordance with EN 50155);  
24 V DC power supply

- Data cable outlet at front

**6GK5324-4QG00-1CR2**

###### *Media modules*

See "Media modules for modular SCALANCE X-300 managed"

###### **SITOP modular, 5 A**

Single-phase and 2-phase power supply with wide-range input  
85 ... 264 V / 176 V ... 550 V AC,  
regulated output voltage 24 V,  
output current rated value 5 A

**6EP1333-3BA00**

##### More information

###### **Selection tool:**

To assist in selecting the right Industrial Ethernet switches as well as configuration of modular variants, the SIMATIC NET Selection Tool and the TIA Selection Tool are available at:

SIMATIC NET Selection Tool:

- Online version:  
<http://www.siemens.com/snst>
- Offline version:  
<http://www.siemens.com/snst-download>

TIA Selection Tool:

<http://www.siemens.com/tia-selection-tool>

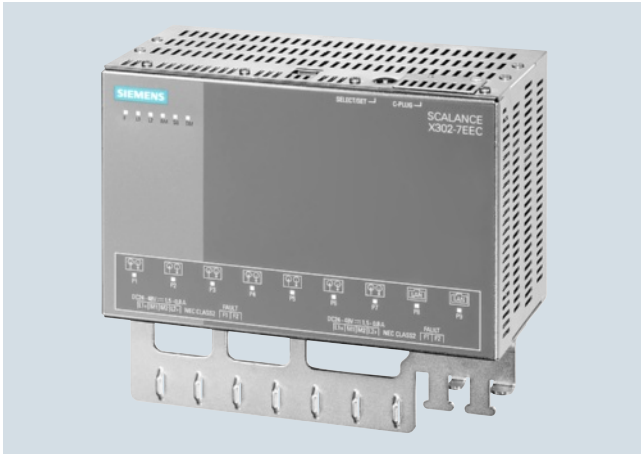
**Overview**

The SCALANCE X-300EEC (**E**nhanced **E**nvironmental **C**onditions) product line comprises compact Industrial Ethernet switches with IT functions for constructing electrical and/or optical line, star and ring topologies at data transfer rates of 10/100/1 000 Mbit/s.

- Suitable for use in extremely harsh industrial environments and in low-voltage and high-voltage switchgear thanks to:
  - Extended temperature range (-40 to +70 °C, briefly to +85 °C)
  - Special coating on PCBs (conformal coating)
  - Support for special protocols and standards (IEEE 1613 and IEC 61850-3)
  - Wide-range power supplies (60 to 250 V AC/DC)
- As many as nine integrated electrical and/or optical Ethernet interfaces (10/100/1 000 Mbit/s) support the interconnection of a number of switches, the construction of optical/electrical rings, or the connection of several Industrial Ethernet nodes
- High-speed media redundancy through integral redundancy manager both for Gigabit Ethernet and Fast Ethernet
- Seamless integration of automation networks into existing corporate networks thanks to support for a host of IT standard functions (VLANs, IGMP-Snooping/Querier, STP/RSTP)
- PROFINET diagnostics, SNMP access, integrated web server and CLI for remote diagnostics and signaling via the network

**Product versions**
**SCALANCE X307-2EEC**

- 5 x 10/100 Mbit/s RJ45 port, electrical
- 2 x 10/100/1 000 Mbit/s RJ45 port, electrical
- 2 x 100 Mbit/s LC Port optical (multi-mode, glass), up to 5 km

**SCALANCE X302-7EEC**

- 2 x 10/100/1 000 Mbit/s RJ45 port, electrical
- 7 x 100 Mbit/s LC Port optical (multi-mode, glass), up to 5 km

SCALANCE X307-2EEC and X302-7EEC are available in versions for

- 24 V DC (single or redundant) and
- with wide-range power supplies for 60 to 250 V DC / 100-240 V AC (single or redundant) as well as
- with or without PCB coating (conformal coating)

**Benefits**

get **Designed for Industry**

- Increased reliability of the network due to hardware and software functions specially geared to the particular requirements of power system plants and extreme environmental conditions
- High availability of the network thanks to:
  - Redundant power supply
  - Redundant network components (optional)
  - Redundant network structures based on fiber-optic or twisted pair cables (redundancy manager, standby function, MRP and RSTP are integrated)
  - Easy device replacement by means of plug-in C-PLUG swap medium
  - Very fast reconfiguration of the network in the event of a fault
- Lower susceptibility to failure and higher availability of the plant networking due to latching of the RJ45 FastConnect connectors in the sleeve of the RJ45 ports
- Protection of investment due to integration into existing network management systems by means of standardized SNMP access
- Time saving during engineering, commissioning and in the operating phase of a plant by using the integrated configuration and diagnostics in STEP 7, without additional software

**Application**

SCALANCE X-300EEC products enable the establishment of switched networks both at the field level and at the control level where high data transfer speeds are required in addition to high network availability and extensive diagnostics facilities. The switches are designed in degree of protection IP30 for installation in control cabinets.

The main area of application is found in high-performance plant networks with interfaces to the corporate network. Thanks to the immunity to electromagnetic interference of the SCALANCE X-300EEC switches, the devices can also be used in medium/high voltage substations under harsh industrial conditions.

Their compact, space-saving design (19"/2) also makes them ideal for installation in control cabinets. In addition, specially selected components permit the use of the devices over a wide temperature range (-40 °C to +70 °C, temporarily up to +85 °C). All versions are also available with specially protected printed-circuit boards (conformal coating) for use in environments subject to contamination.

## PROFINET/Industrial Ethernet

### Industrial Ethernet Switches

#### SCALANCE X-300EEC managed

#### Application (continued)

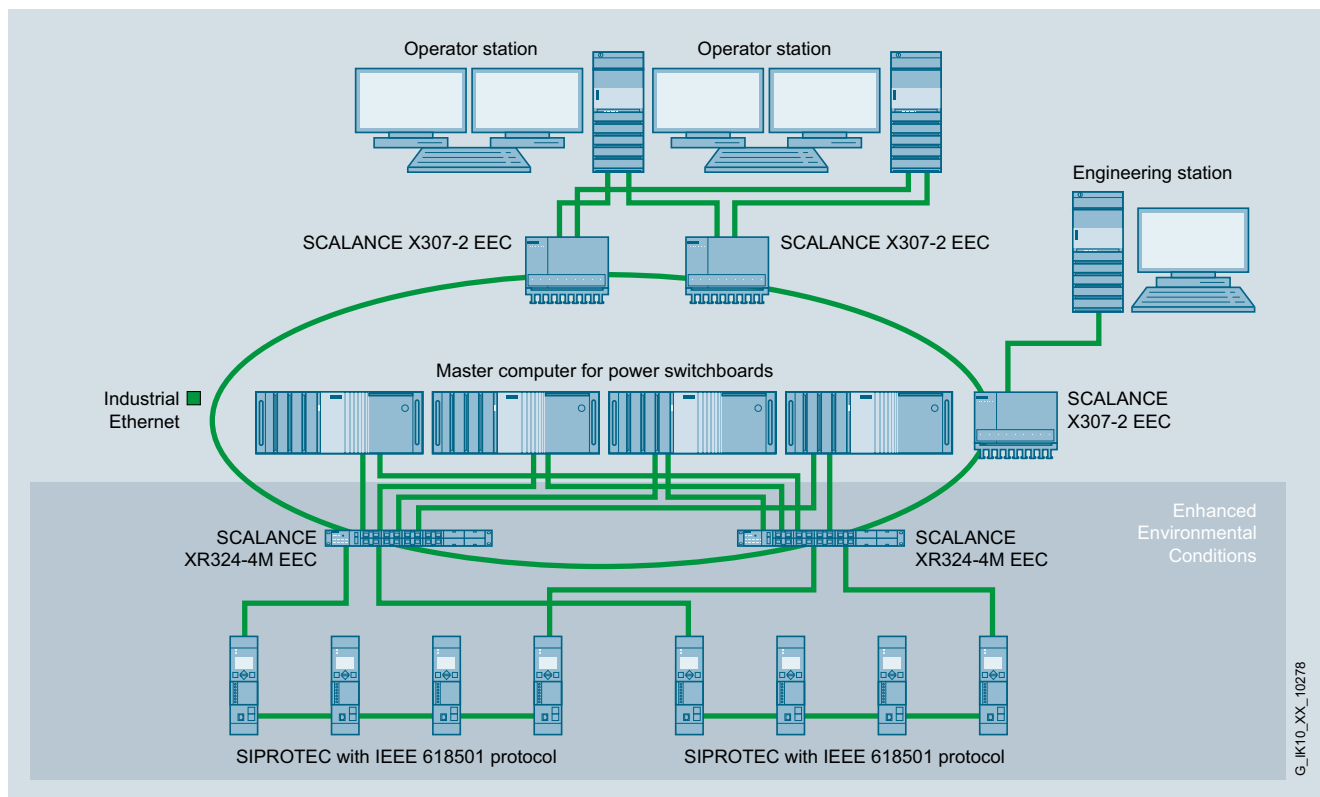

Electrical network structure in power switchgear with SCALANCE X-300EEC and XR324-4M EEC

#### Design

The SCALANCE X-300EEC Industrial Ethernet switches with rugged metal enclosure are optimized for mounting on a standard DIN rail. Thanks to the enclosure dimension 19 $\frac{1}{2}$ " (internal dimension), two devices can be mounted side by side in a 19" cabinet.

The switches have:

- a 4-pin terminal block for connecting the redundant power supply (2 x 24 V DC)
- A 2-pin terminal block for connecting the isolated signaling contact
- A row of LEDs to indicate the status information (power, link status, data traffic, power supply, signaling contact)
- SELECT/SET key for on-site configuration of the signaling contact
- Slot for optional C-PLUG swap medium on the top of the device for easy replacement in the event of a fault
- Guide rails for strain-relief attachment of the RJ45 and LC connection to the switch

The SCALANCE X-300EEC switches are available with the following port types:

- As many as seven integrated fiber-optic ports for connecting the SCALANCE X switches with one another (multimode). The Fast Ethernet fiber optic ports are designed using LC connection technology.
- Up to seven integrated twisted pair ports; the RJ45 sockets are designed to be industry-compatible with additional retaining mechanisms, for connection of the Industrial Ethernet FC RJ45 Plug 180.

G\_IK10\_XX\_10278



**Function**

- Integrated redundancy manager for constructing ring topologies with fast media redundancy Rings consisting of SCALANCE X-300 and X-400 switches can be operated at 1 000 Mbit/s. In rings with SCALANCE X-200 or OSM/ESM it is possible to integrate SCALANCE X-300EEC switches at 100 Mbit/s.
- Redundant interfacing to corporate networks; SCALANCE X-300EEC switches support the standardized redundancy procedures Spanning Tree Protocol (STP) and Rapid Spanning Tree Protocol (RSTP). This enables a subnetwork to be connected redundantly to a higher level corporate network with reduced requirements for the reconfiguration time (in the order of seconds). By supporting the Multiple Spanning Tree Protocol (MSTP), a network can also be split into multiple sub-segments.
- Support of virtual networks (VLAN); for structuring Industrial Ethernet networks with a fast growing number of users, a physically existing network can be divided into several virtual networks.
- Load limiting when multicast protocols (e.g. Querier, video transmission) are used; through learning the multicast sources and targets (IGMP Snooping, IGMP Querier), SCALANCE X-300EEC switches can also filter multicast data traffic and therefore limit the load in the network.
- Time synchronization; diagnostic messages (log table entries, e-mails) are time-stamped. The local time is standardized throughout the network by means of synchronization with a SICLOCK time transmitter, SNTP or NTP server or via IEEE1588, thereby simplifying the assignment of diagnostic messages of multiple devices.
- Fast replacement of devices in event of failure, by means of the C-PLUG switching medium

**Network topology and network configuration**

The SCALANCE X-300EEC Industrial Ethernet switches with degree of protection IP30 can be adapted to the structure of the plant in star, line and ring topologies.

The following network structures and combinations of structures can be implemented:

- Fast Ethernet rings with fast media redundancy; to increase network availability, as many as 50 X-200, X-300, or X-400 switches cascaded in line can be connected into a ring with a total length of up to 150 km. On the failure of a transmission link or of a SCALANCE X switch in the ring, the transmission path is reconfigured within 0.3 seconds (0.2 seconds for MRP).
- Several rings can be redundantly linked through the standby function
- Construction of interconnected network structures by means of rapid spanning tree protocol (RSTP)
- At the same time, SCALANCE X-300EEC supports redundant connection of the ring structure to the corporate network with a rapid spanning tree.
- Star topology with SCALANCE X-300EEC switches: The SCALANCE X-300EEC switch represents a neutral point that can connect up to nine nodes or subnets with each other.

When configuring the network, it is necessary to observe the following boundary conditions:

- Maximum line length between two modules for multi-mode fiber-optic conductors:
  - 5 000 m at 100 Mbit/s
- Maximum cable length of the TP cable between two SCALANCE X switches:
  - max. 100 m

## PROFINET/Industrial Ethernet

### Industrial Ethernet Switches

#### SCALANCE X-300EEC managed

#### Function (continued)

##### Commissioning and diagnostics

Setting options on the device itself:

- Redundancy manager RM; to establish a ring, a SCALANCE X-300EEC is switched to RM mode. The non-ring ports of the RM can be used freely for the connection of data terminals and networks. If the redundancy procedure MRP standardized by PROFINET is used, the RM is adjusted automatically.
- Signal mask; the signal mask is set to the current status of the SCALANCE X-300EEC (setpoint) by pushbutton operation. The signal mask defines which ports and which power supplies are to be monitored. The signaling contact only reports an error when a monitored port or a monitored feeder fails (deviation of setpoint/actual status).

Diagnostic options on site:

- The following status information is displayed by LEDs on site:
  - Port status
  - Port mode (10/100 Mbit/s, full/half-duplex)
  - Status of the two power supplies
  - Signaling contact status
  - Signal mask (setpoint status)
  - RM mode
  - Standby mode
- The status of the signaling contact is routed externally by means of floating relay contacts. This enables, for example, the module to be monitored via an input module from a controller.
- Monitoring via the Industrial Ethernet network; the following possibilities are available:
  - Remote via standard browser (Web-based management): Selection of SCALANCE X-300 switches via the network from a PC with browser
  - Remote via SNMP V1, V2c, V3: Secure connection of SCALANCE X-300EEC switches via the network to a network management station
  - Remote via PROFINET IO diagnostics: PROFINET diagnostic alarms from SCALANCE X-300EEC switches can be displayed using the relevant SIMATIC engineering tools and they can also be processed in the controller. The engineering outlay for the PLC and HMI have been drastically reduced due to the complete integration in the SIMATIC concept for system error messages.

##### Network management

The network management provides the following functions:

- Password-protected dial-up for "Administrator" (read and write authorization) and "User" (read only)
- Read-out of version and status information
- Setting the signal and standby mask and address information
- Parameterization of the web management services
- Setting of Rapid Spanning Tree parameters
- Fixed parameterization of the ports (data rates, half/full duplex)
- Security
  - Ports can be connected or disconnected
  - Authentication in accordance with IEEE 802.1x (available soon)
  - Support of Access Control List (ACL) (available soon)
- Parameterization of user administration of SNMP V1, V2c, V3
- Output of statistics information
- Diagnosis of data traffic by means of a parameterizable mirror port with a standard commercial network analyzer
- Loading new firmware updates or configuration data via the network from one TFTP server or directly via HTTP/HTTPS with an Internet or Web browser.
- Saving the configuration data or log table via the network on a TFTP server

If faults occur in the network, the SCALANCE X-300EEC switch can independently send error messages (traps) to a network management system or also e-mails to a predefined network administrator.

Remote monitoring (RMON) provides the following functions: The SCALANCE X-300EEC switch can collect statistics information according to the RMON groups 1 through 4. These include, for example, fault statistics that are kept for each port. This information can be read out through web-based management in the statistics sub-area.

**Technical specifications**

Article No.	6GK5302-7GD00-1EA3	6GK5302-7GD00-1GA3	6GK5302-7GD00-2EA3	6GK5302-7GD00-2GA3
Product-type designation	SCALANCE X302-7EEC	SCALANCE X302-7EEC	SCALANCE X302-7EEC	SCALANCE X302-7EEC
<b>Transmission rate</b>				
Transfer rate 1	10 Mbit/s	10 Mbit/s	10 Mbit/s	10 Mbit/s
Transfer rate 2	100 Mbit/s	100 Mbit/s	100 Mbit/s	100 Mbit/s
Transfer rate 3	1 000 Mbit/s	1 000 Mbit/s	1 000 Mbit/s	1 000 Mbit/s
<b>Interfaces</b>				
Number of electrical/optical connections for network components or terminal equipment maximum	9	9	9	9
Number of electrical connections				
• for network components and terminal equipment	2	2	2	2
• for operator console	-	-	-	-
• for signaling contact	1	1	2	2
• for media module	-	-	-	-
• for power supply	1	1	2	2
• for redundant power supply	1	1	2	2
Design of electrical connection				
• for network components and terminal equipment	RJ45 port	RJ45 port	RJ45 port	RJ45 port
• for signaling contact	2-pole terminal block	2-pole terminal block	2-pole terminal block	2-pole terminal block
• for power supply	4-pole terminal block	4-pole terminal block	2 x 4-pole terminal block	2 x 4-pole terminal block
Number of optical interfaces for optical waveguide				
• at 100 Mbit/s	7	7	7	7
Design of optical interface for optical waveguide				
• at 100 Mbit/s	LC port (multimode up to 5 km)	LC port (multimode up to 5 km)	LC port (multimode up to 5 km)	LC port (multimode up to 5 km)
Connectable optical power relative to 1 mW				
• of the transmitter output	-19 ... -14 dB	-19 ... -14 dB	-19 ... -14 dB	-19 ... -14 dB
• of the receiver input maximum	-14 dB	-14 dB	-14 dB	-14 dB
Optical sensitivity relative to 1 mW of the receiver input minimum	-32 dB	-32 dB	-32 dB	-32 dB
Attenuation of fiber-optic cable transmission link minimum necessary	0 dB	0 dB	0 dB	0 dB
Range at the optical interface depending on the optical fiber used	0 ... 5 km	0 ... 5 km	0 ... 5 km	0 ... 5 km
Design of the removable storage C-PLUG	Yes	Yes	Yes	Yes
<b>Signal-Inputs/outputs</b>				
Operating voltage of signaling contacts at DC rated value	24 V	24 V	24 V	24 V
Operating current of signaling contacts at DC maximum	0.1 A	0.1 A	0.1 A	0.1 A
<b>Supply voltage, current consumption, power loss</b>				
Type of supply voltage redundant power supply unit	No	No	Yes	Yes
Type of supply voltage	DC	DC	DC	DC
Type 2 of supply voltage	DC	DC	DC	DC
Supply voltage for DC	24 V	24 V	24 V	24 V
• rated value	19.2 ... 57.6 V	19.2 ... 57.6 V	19.2 ... 57.6 V	19.2 ... 57.6 V
Product component fusing at power supply input	Yes	Yes	Yes	Yes
Type of fusing at input for supply voltage	T 4 A / 125 V	T 4 A / 125 V	T 4 A / 125 V	T 4 A / 125 V
Consumed current maximum	0.75 A	0.75 A	0.75 A	0.75 A
Active power loss				
• at 24 V for DC	17 W	17 W	17 W	17 W

## PROFINET/Industrial Ethernet

### Industrial Ethernet Switches

#### SCALANCE X-300EEC managed

#### Technical specifications (continued)

Article No.	6GK5302-7GD00-1EA3	6GK5302-7GD00-1GA3	6GK5302-7GD00-2EA3	6GK5302-7GD00-2GA3
Product-type designation	SCALANCE X302-7EEC	SCALANCE X302-7EEC	SCALANCE X302-7EEC	SCALANCE X302-7EEC
<b>Permitted ambient conditions</b>				
Ambient temperature				
• during operating	-40 ... +70 °C	-40 ... +70 °C	-40 ... +70 °C	-40 ... +70 °C
• during storage	-40 ... +70 °C	-40 ... +70 °C	-40 ... +70 °C	-40 ... +70 °C
• during transport	-40 ... +70 °C	-40 ... +70 °C	-40 ... +70 °C	-40 ... +70 °C
• Comment	A maximum operating temperature of +85 °C is permissible for a duration of 16 hours	A maximum operating temperature of +85 °C is permissible for a duration of 16 hours	A maximum operating temperature of +85 °C is permissible for a duration of 16 hours	A maximum operating temperature of +85 °C is permissible for a duration of 16 hours
Relative humidity at 25 °C without condensation during operating maximum	95 %	95 %	95 %	95 %
Ambient condition for (standard) operation mode	Conformal coating, no	Conformal coating, yes	Conformal coating, no	Conformal coating, yes
Protection class IP	IP30	IP30	IP30	IP30
<b>Design, dimensions and weight</b>				
Design	compact	compact	compact	compact
Width	216 mm	216 mm	216 mm	216 mm
Height	143 mm	143 mm	143 mm	143 mm
Depth	110 mm	110 mm	110 mm	110 mm
Net weight	1.8 kg	1.8 kg	2.03 kg	1.8 kg
Mounting type				
• 19-inch installation	Yes	Yes	Yes	Yes
• 35 mm DIN rail mounting	Yes	Yes	Yes	Yes
• wall mounting	Yes	Yes	Yes	Yes
• S7-300 rail mounting	Yes	Yes	Yes	Yes
Mounting type	Wall mounting is possible only with an additional wall bracket; 19" mounting only with installation of two X-300EEC switches in pairs using a mounting plate	Wall mounting is possible only with an additional wall bracket; 19" mounting only with installation of two X-300EEC switches in pairs using a mounting plate	Wall mounting is possible only with an additional wall bracket; 19" mounting only with installation of two X-300EEC switches in pairs using a mounting plate	Wall mounting is possible only with an additional wall bracket; 19" mounting only with installation of two X-300EEC switches in pairs using a mounting plate
<b>Product properties, functions, components general</b>				
Cascading in the case of a redundant ring at reconfiguration time of < 0.3 s	50	50	50	50
Cascading in cases of star structuring	Any (depending only on signal propagation time)	Any (depending only on signal propagation time)	Any (depending only on signal propagation time)	Any (depending only on signal propagation time)
<b>Product functions management, configuration</b>				
Product function				
• CLI	Yes	Yes	Yes	Yes
• web-based management	Yes	Yes	Yes	Yes
• MIB support	Yes	Yes	Yes	Yes
• TRAPs via email	Yes	Yes	Yes	Yes
• Configuration with STEP 7	Yes	Yes	Yes	Yes
• RMON	Yes	Yes	Yes	Yes
• Port mirroring	Yes	Yes	Yes	Yes
• CoS	Yes	Yes	Yes	Yes
• for IRT PROFINET IO switch	No	No	No	No
• PROFINET IO diagnosis	Yes	Yes	Yes	Yes
• switch-managed	Yes	Yes	Yes	Yes

**Technical specifications (continued)**

Article No.	6GK5302-7GD00-1EA3	6GK5302-7GD00-1GA3	6GK5302-7GD00-2EA3	6GK5302-7GD00-2GA3
Product-type designation	SCALANCE X302-7EEC	SCALANCE X302-7EEC	SCALANCE X302-7EEC	SCALANCE X302-7EEC
Protocol is supported				
• Telnet	Yes	Yes	Yes	Yes
• HTTP	Yes	Yes	Yes	Yes
• HTTPS	Yes	Yes	Yes	Yes
• TFTP	Yes	Yes	Yes	Yes
• FTP	Yes	Yes	Yes	Yes
• BOOTP	Yes	Yes	Yes	Yes
• SNMP v1	Yes	Yes	Yes	Yes
• SNMP v2	Yes	Yes	Yes	Yes
• SNMP v3	Yes	Yes	Yes	Yes
• IGMP (snooping/querier)	Yes	Yes	Yes	Yes
• GMRP	Yes	Yes	Yes	Yes
• DCP	Yes	Yes	Yes	Yes
• LLDP	Yes	Yes	Yes	Yes
Identification & maintenance function				
• I&M0 - device-specific information	Yes	Yes	Yes	Yes
• I&M1 - higher level designation/location designation	Yes	Yes	Yes	Yes
<b>Product functions Diagnosis</b>				
Product function				
• Port diagnostics	Yes	Yes	Yes	Yes
• Statistics packet size	Yes	Yes	Yes	Yes
• Statistics packet type	Yes	Yes	Yes	Yes
• Error statistics	Yes	Yes	Yes	Yes
• SysLog	Yes	Yes	Yes	Yes
<b>Product functions VLAN</b>				
Product function				
• VLAN - port based	Yes	Yes	Yes	Yes
• VLAN dynamic	Yes	Yes	Yes	Yes
Number of VLANs maximum	255	255	255	255
Number of VLANs - dynamic maximum	255	255	255	255
Protocol is supported GVRP	Yes	Yes	Yes	Yes
<b>Product functions DHCP</b>				
Product function				
• DHCP client	Yes	Yes	Yes	Yes
• DHCP Option 82	Yes	Yes	Yes	Yes
• DHCP Option 66	Yes	Yes	Yes	Yes
• DHCP Option 67	Yes	Yes	Yes	Yes
<b>Product functions Redundancy</b>				
Product function				
• Ring redundancy	Yes	Yes	Yes	Yes
• Redundancy manager	Yes	Yes	Yes	Yes
• Standby redundancy	Yes	Yes	Yes	Yes
• High Speed Redundancy Protocol (HRP)	Yes	Yes	Yes	Yes
• Media Redundancy Protocol (MRP)	Yes	Yes	Yes	Yes
• Redundancy procedure STP	Yes	Yes	Yes	Yes
• RSTP redundancy protocol	Yes	Yes	Yes	Yes
• Redundancy procedure MSTP	Yes	Yes	Yes	Yes
• Passive listening	Yes	Yes	Yes	Yes
Protocol is supported				
• STP/RSTP	Yes	Yes	Yes	Yes
• STP	Yes	Yes	Yes	Yes
• RSTP	Yes	Yes	Yes	Yes
• RSTP big network support	Yes	Yes	Yes	Yes
• LACP	Yes	Yes	Yes	Yes

## PROFINET/Industrial Ethernet

### Industrial Ethernet Switches

#### SCALANCE X-300EEC managed

#### Technical specifications (continued)

Article No.	6GK5302-7GD00-1EA3	6GK5302-7GD00-1GA3	6GK5302-7GD00-2EA3	6GK5302-7GD00-2GA3
Product-type designation	SCALANCE X302-7EEC	SCALANCE X302-7EEC	SCALANCE X302-7EEC	SCALANCE X302-7EEC
<b>Product functions Security</b>				
Product function				
• ACL - port/MAC-based	Yes	Yes	Yes	Yes
• IEEE 802.1x (radius)	Yes	Yes	Yes	Yes
• Broadcast/Multicast/Unicast Limiter	Yes	Yes	Yes	Yes
• broadcast blocking	Yes	Yes	Yes	Yes
Protocol is supported SSH	Yes	Yes	Yes	Yes
<b>Product functions Time</b>				
Product function SICLOCK support	Yes	Yes	Yes	Yes
Protocol is supported				
• NTP	Yes	Yes	Yes	Yes
• SNTP	Yes	Yes	Yes	Yes
• IEEE 1588 profile default	Yes	Yes	Yes	Yes
<b>Standards, specifications, approvals</b>				
Standard				
• for EMC	IEC 61850, IEEE 1613	IEC 61850, IEEE 1613	IEC 61850, IEEE 1613	IEC 61850, IEEE 1613
• for EMC from FM	FM3611: Class 1, Division 2, Group A, B, C, D / T4, Class 1, Zone 2, Group IIC, T4	FM3611: Class 1, Division 2, Group A, B, C, D / T4, Class 1, Zone 2, Group IIC, T4	FM3611: Class 1, Division 2, Group A, B, C, D / T4, Class 1, Zone 2, Group IIC, T4	FM3611: Class 1, Division 2, Group A, B, C, D / T4, Class 1, Zone 2, Group IIC, T4
• for hazardous zone	EN 60079-0 : 2006, EN 60079-15: 2005, II 3 G Ex nA II T4	EN 60079-0 : 2006, EN 60079-15: 2005, II 3 G Ex nA II T4	EN 60079-0 : 2006, EN 60079-15: 2005, II 3 G Ex nA II T4	EN 60079-0 : 2006, EN 60079-15: 2005, II 3 G Ex nA II T4
• for safety of CSA and UL	UL 508	UL 508	UL 508	UL 508
• for hazardous area of CSA and UL	ANSI / ISA 12.12.01, CSA C22.2 No. 213-M1987, UL 1604 and 2279-15, CL. 1 / Div. 2 / GP. A, B, C, D T4, CL. 1 / Zone 2 / GP. IIC, T4	ANSI / ISA 12.12.01, CSA C22.2 No. 213-M1987, UL 1604 and 2279-15, CL. 1 / Div. 2 / GP. A, B, C, D T4, CL. 1 / Zone 2 / GP. IIC, T4	ANSI / ISA 12.12.01, CSA C22.2 No. 213-M1987, UL 1604 and 2279-15, CL. 1 / Div. 2 / GP. A, B, C, D T4, CL. 1 / Zone 2 / GP. IIC, T4	ANSI / ISA 12.12.01, CSA C22.2 No. 213-M1987, UL 1604 and 2279-15, CL. 1 / Div. 2 / GP. A, B, C, D T4, CL. 1 / Zone 2 / GP. IIC, T4
• for emitted interference	EN 61000-6-4:2007 (Class A)	EN 61000-6-4:2007 (Class A)	EN 61000-6-4:2007 (Class A)	EN 61000-6-4:2007 (Class A)
• for interference immunity	EN 61000-6-2:2005	EN 61000-6-2:2005	EN 61000-6-2:2005	EN 61000-6-2:2005
Verification of suitability	EN 61000-6-2:2005, EN 61000-6-4:2007	EN 61000-6-2:2005, EN 61000-6-4:2007	EN 61000-6-2:2005, EN 61000-6-4:2007	EN 61000-6-2:2005, EN 61000-6-4:2007
• CE mark	Yes	Yes	Yes	Yes
• C-Tick	Yes	Yes	Yes	Yes
• KC approval	Yes	Yes	Yes	Yes
• Railway application in accordance with EN 50155	No	No	No	No
• Railway application in accordance with EN 50124-1	No	No	No	No
• IEC 61850-3	Yes	Yes	Yes	Yes
Certificate of suitability IEEE 1613	Yes	Yes	Yes	Yes

**Technical specifications (continued)**

Article No.	6GK5302-7GD00-3EA3	6GK5302-7GD00-3GA3	6GK5302-7GD00-4EA3	6GK5302-7GD00-4GA3
Product-type designation	SCALANCE X302-7EEC	SCALANCE X302-7EEC	SCALANCE X302-7EEC	SCALANCE X302-7EEC
<b>Transmission rate</b>				
Transfer rate 1	10 Mbit/s	10 Mbit/s	10 Mbit/s	10 Mbit/s
Transfer rate 2	100 Mbit/s	100 Mbit/s	100 Mbit/s	100 Mbit/s
Transfer rate 3	1 000 Mbit/s	1 000 Mbit/s	1 000 Mbit/s	1 000 Mbit/s
<b>Interfaces</b>				
Number of electrical/optical connections for network components or terminal equipment maximum	9	9	9	9
Number of electrical connections				
• for network components and terminal equipment	2	2	2	2
• for signaling contact	1	1	2	2
• for power supply	1	1	1	1
• for redundant power supply	-	-	1	1
Design of electrical connection				
• for network components and terminal equipment	RJ45 port	RJ45 port	RJ45 port	RJ45 port
• for signaling contact	3-pole terminal block	3-pole terminal block	3-pole terminal block	3-pole terminal block
• for power supply	3-pole terminal block	3-pole terminal block	2 x 3-pole terminal block	2 x 3-pole terminal block
Number of optical interfaces for optical waveguide				
• at 100 Mbit/s	7	7	7	7
Design of optical interface for optical waveguide				
• at 100 Mbit/s	LC port (multimode up to 5 km)	LC port (multimode up to 5 km)	LC port (multimode up to 5 km)	LC port (multimode up to 5 km)
Connectable optical power relative to 1 mW				
• of the transmitter output	-19 ... -14 dB	-19 ... -14 dB	-19 ... -14 dB	-19 ... -14 dB
• of the receiver input maximum	-14 dB	-14 dB	-14 dB	-14 dB
Optical sensitivity relative to 1 mW of the receiver input minimum	-32 dB	-32 dB	-32 dB	-32 dB
Attenuation of fiber-optic cable transmission link minimum necessary	0 dB	0 dB	0 dB	0 dB
Range at the optical interface depending on the optical fiber used	0 ... 5 km	0 ... 5 km	0 ... 5 km	0 ... 5 km
Design of the removable storage C-PLUG	Yes	Yes	Yes	Yes
<b>Signal-Inputs/outputs</b>				
Operating voltage of signaling contacts at AC rated value	276 V	276 V	276 V	276 V
Operating current of signaling contacts at AC maximum	5 A	5 A	5 A	5 A
Operating voltage of signaling contacts at DC rated value	230 V	230 V	230 V	230 V
Operating current of signaling contacts at DC maximum	0.1 A	0.1 A	0.1 A	0.1 A

# PROFINET/Industrial Ethernet

## Industrial Ethernet Switches

### SCALANCE X-300EEC managed

#### Technical specifications (continued)

Article No.	6GK5302-7GD00-3EA3	6GK5302-7GD00-3GA3	6GK5302-7GD00-4EA3	6GK5302-7GD00-4GA3
Product-type designation	SCALANCE X302-7EEC	SCALANCE X302-7EEC	SCALANCE X302-7EEC	SCALANCE X302-7EEC
<b>Supply voltage, current consumption, power loss</b>				
Type of supply voltage redundant power supply unit	No	No	Yes	Yes
Type of supply voltage	AC	AC	AC	AC
Supply voltage at AC	230 V	230 V	230 V	230 V
• rated value	80 ... 276 V	80 ... 276 V	80 ... 276 V	80 ... 276 V
Type 2 of supply voltage	DC	DC	DC	DC
Supply voltage for DC	220 V	220 V	220 V	220 V
• rated value	46.25 ... 300 V	46.25 ... 300 V	46.25 ... 300 V	46.25 ... 300 V
Product component fusing at power supply input	Yes	Yes	Yes	Yes
Type of fusing at input for supply voltage	T 2 A / 250 V	T 2 A / 250 V	T 2 A / 250 V	T 2 A / 250 V
Consumed current maximum	0.08 A	0.08 A	0.08 A	0.08 A
Active power loss				
• at 230 V AC	18 W	18 W	18 W	18 W
• at 250 V with DC	18 W	18 W	18 W	18 W
<b>Permitted ambient conditions</b>				
Ambient temperature				
• during operating	-40 ... +70 °C	-40 ... +70 °C	-40 ... +70 °C	-40 ... +70 °C
• during storage	-40 ... +70 °C	-40 ... +70 °C	-40 ... +70 °C	-40 ... +70 °C
• during transport	-40 ... +70 °C	-40 ... +70 °C	-40 ... +70 °C	-40 ... +70 °C
• Comment	A maximum operating temperature of +85 °C is permissible for a duration of 16 hours	A maximum operating temperature of +85 °C is permissible for a duration of 16 hours	A maximum operating temperature of +85 °C is permissible for a duration of 16 hours	A maximum operating temperature of +85 °C is permissible for a duration of 16 hours
Relative humidity at 25 °C without condensation during operating maximum	95 %	95 %	95 %	95 %
Ambient condition for (standard) operation mode	Conformal coating, no	Conformal coating, yes	Conformal coating, no	Conformal coating, yes
Protection class IP	IP30	IP30	IP30	IP30
<b>Design, dimensions and weight</b>				
Design	compact	compact	compact	compact
Width	216 mm	216 mm	216 mm	216 mm
Height	143 mm	143 mm	143 mm	143 mm
Depth	110 mm	110 mm	110 mm	110 mm
Net weight	1.85 kg	1.85 kg	2.12 kg	2.12 kg
Mounting type				
• 19-inch installation	Yes	Yes	Yes	Yes
• 35 mm DIN rail mounting	Yes	Yes	Yes	Yes
• wall mounting	Yes	Yes	Yes	Yes
• S7-300 rail mounting	Yes	Yes	Yes	Yes
Mounting type	Wall mounting is possible only with an additional wall bracket; 19" mounting only with installation of two X-300EEC switches in pairs using a mounting plate	Wall mounting is possible only with an additional wall bracket; 19" mounting only with installation of two X-300EEC switches in pairs using a mounting plate	Wall mounting is possible only with an additional wall bracket; 19" mounting only with installation of two X-300EEC switches in pairs using a mounting plate	Wall mounting is possible only with an additional wall bracket; 19" mounting only with installation of two X-300EEC switches in pairs using a mounting plate
<b>Product properties, functions, components general</b>				
Cascading in the case of a redundant ring at reconfiguration time of < 0.3 s	50	50	50	50
Cascading in cases of star structuring	Any (depending only on signal propagation time)	Any (depending only on signal propagation time)	Any (depending only on signal propagation time)	Any (depending only on signal propagation time)



**Technical specifications (continued)**

Article No.	6GK5302-7GD00-3EA3	6GK5302-7GD00-3GA3	6GK5302-7GD00-4EA3	6GK5302-7GD00-4GA3
Product-type designation	SCALANCE X302-7EEC	SCALANCE X302-7EEC	SCALANCE X302-7EEC	SCALANCE X302-7EEC
<b>Product functions management, configuration</b>				
Product function				
• CLI	Yes	Yes	Yes	Yes
• web-based management	Yes	Yes	Yes	Yes
• MIB support	Yes	Yes	Yes	Yes
• TRAPs via email	Yes	Yes	Yes	Yes
• Configuration with STEP 7	Yes	Yes	Yes	Yes
• RMON	Yes	Yes	Yes	Yes
• SMTP server	-	-	-	-
• Port mirroring	Yes	Yes	Yes	Yes
• CoS	Yes	Yes	Yes	Yes
• for IRT PROFINET IO switch	No	No	No	No
• PROFINET IO diagnosis	Yes	Yes	Yes	Yes
• switch-managed	Yes	Yes	Yes	Yes
Protocol is supported				
• Telnet	Yes	Yes	Yes	Yes
• HTTP	Yes	Yes	Yes	Yes
• HTTPS	Yes	Yes	Yes	Yes
• TFTP	Yes	Yes	Yes	Yes
• FTP	Yes	Yes	Yes	Yes
• BOOTP	Yes	Yes	Yes	Yes
• SNMP v1	Yes	Yes	Yes	Yes
• SNMP v2	Yes	Yes	Yes	Yes
• SNMP v3	Yes	Yes	Yes	Yes
• IGMP (snooping/querier)	Yes	Yes	Yes	Yes
• GMRP	Yes	Yes	Yes	Yes
• DCP	Yes	Yes	Yes	Yes
• LLDP	Yes	Yes	Yes	Yes
Identification & maintenance function				
• I&M0 - device-specific information	Yes	Yes	Yes	Yes
• I&M1 - higher level designation/location designation	Yes	Yes	Yes	Yes
<b>Product functions Diagnosis</b>				
Product function				
• Port diagnostics	Yes	Yes	Yes	Yes
• Statistics packet size	Yes	Yes	Yes	Yes
• Statistics packet type	Yes	Yes	Yes	Yes
• Error statistics	Yes	Yes	Yes	Yes
• SysLog	Yes	Yes	Yes	Yes
<b>Product functions VLAN</b>				
Product function				
• VLAN - port based	Yes	Yes	Yes	Yes
• VLAN dynamic	Yes	Yes	Yes	Yes
Number of VLANs maximum	255	255	255	255
Number of VLANs - dynamic maximum	255	255	255	255
Protocol is supported				
• GVRP	Yes	Yes	Yes	Yes
<b>Product functions DHCP</b>				
Product function				
• DHCP client	Yes	Yes	Yes	Yes
• DHCP Option 82	Yes	Yes	Yes	Yes
• DHCP Option 66	Yes	Yes	Yes	Yes
• DHCP Option 67	Yes	Yes	Yes	Yes

# PROFINET/Industrial Ethernet

## Industrial Ethernet Switches

### SCALANCE X-300EEC managed

#### Technical specifications (continued)

Article No.	6GK5302-7GD00-3EA3	6GK5302-7GD00-3GA3	6GK5302-7GD00-4EA3	6GK5302-7GD00-4GA3
Product-type designation	SCALANCE X302-7EEC	SCALANCE X302-7EEC	SCALANCE X302-7EEC	SCALANCE X302-7EEC
<b>Product functions Redundancy</b>				
Product function				
• Ring redundancy	Yes	Yes	Yes	Yes
• Redundancy manager	Yes	Yes	Yes	Yes
• Standby redundancy	Yes	Yes	Yes	Yes
• High Speed Redundancy Protocol (HRP)	Yes	Yes	Yes	Yes
• Media Redundancy Protocol (MRP)	Yes	Yes	Yes	Yes
• Redundancy procedure STP	Yes	Yes	Yes	Yes
• RSTP redundancy protocol	Yes	Yes	Yes	Yes
• Redundancy procedure MSTP	Yes	Yes	Yes	Yes
• Passive listening	Yes	Yes	Yes	Yes
Protocol is supported				
• STP/RSTP	Yes	Yes	Yes	Yes
• STP	Yes	Yes	Yes	Yes
• RSTP	Yes	Yes	Yes	Yes
• RSTP big network support	Yes	Yes	Yes	Yes
• LACP	Yes	Yes	Yes	Yes
<b>Product functions Security</b>				
Product function				
• ACL - port/MAC-based	Yes	Yes	Yes	Yes
• IEEE 802.1x (radius)	Yes	Yes	Yes	Yes
• Broadcast/Multicast/Unicast Limiter	Yes	Yes	Yes	Yes
• Broadcast blocking	Yes	Yes	Yes	Yes
Protocol is supported SSH	Yes	Yes	Yes	Yes
<b>Product functions Time</b>				
Product function SICLOCK support	Yes	Yes	Yes	Yes
Protocol is supported				
• NTP	Yes	Yes	Yes	Yes
• SNTP	Yes	Yes	Yes	Yes
• IEEE 1588 profile default	Yes	Yes	Yes	Yes
<b>Standards, specifications, approvals</b>				
Standard				
• for EMC	IEC 61850, IEEE 1613	IEC 61850, IEEE 1613	IEC 61850, IEEE 1613	IEC 61850, IEEE 1613
• for safety of CSA and UL	UL 508, CSA C22.2 No. 142-M1987	UL 508, CSA C22.2 No. 142-M1987	UL 508, CSA C22.2 No. 142-M1987	UL 508, CSA C22.2 No. 142-M1987
• for emitted interference	EN 61000-6-4:2007 (Class A)	EN 61000-6-4:2007 (Class A)	EN 61000-6-4:2007 (Class A)	EN 61000-6-4:2007 (Class A)
• for interference immunity	EN 61000-6-2:2005	EN 61000-6-2:2005	EN 61000-6-2:2005	EN 61000-6-2:2005
Verification of suitability	EN 61000-6-2:2005, EN 61000-6-4:2007	EN 61000-6-2:2005, EN 61000-6-4:2007	EN 61000-6-2:2005, EN 61000-6-4:2007	EN 61000-6-2:2005, EN 61000-6-4:2007
• CE mark	Yes	Yes	Yes	Yes
• C-Tick	Yes	Yes	Yes	Yes
• KC approval	Yes	Yes	Yes	Yes
• Railway application in accordance with EN 50155	No	No	No	No
• Railway application in accordance with EN 50124-1	No	No	No	No
• IEC 61850-3	Yes	Yes	Yes	Yes
certificate of suitability IEEE 1613	Yes	Yes	Yes	Yes

**Technical specifications (continued)**

Article No.	6GK5307-2FD00-1EA3	6GK5307-2FD00-1GA3	6GK5307-2FD00-2EA3	6GK5307-2FD00-2GA3
Product-type designation	SCALANCE X307-2EEC	SCALANCE X307-2EEC	SCALANCE X307-2EEC	SCALANCE X307-2EEC
<b>Transmission rate</b>				
Transfer rate 1	10 Mbit/s	10 Mbit/s	10 Mbit/s	10 Mbit/s
Transfer rate 2	100 Mbit/s	100 Mbit/s	100 Mbit/s	100 Mbit/s
Transfer rate 3	1 000 Mbit/s	1 000 Mbit/s	1 000 Mbit/s	1 000 Mbit/s
<b>Interfaces</b>				
Number of electrical/optical connections for network components or terminal equipment maximum	9	9	9	9
Number of electrical connections				
• for network components and terminal equipment	7	7	7	7
• for signaling contact	1	1	2	2
• for power supply	1	1	2	2
• for redundant power supply	1	1	2	2
Design of electrical connection				
• for network components and terminal equipment	RJ45 port	RJ45 port	RJ45 port	RJ45 port
• for signaling contact	2-pole terminal block	2-pole terminal block	2-pole terminal block	2-pole terminal block
• for power supply	4-pole terminal block	4-pole terminal block	2 x 4-pole terminal block	2 x 4-pole terminal block
Number of optical interfaces for optical waveguide				
• at 100 Mbit/s	2	2	2	2
Design of optical interface for optical waveguide				
• at 100 Mbit/s	LC port (multimode up to 5 km)	LC port (multimode up to 5 km)	LC port (multimode up to 5 km)	LC port (multimode up to 5 km)
Connectable optical power relative to 1 mW				
• of the transmitter output	-19 ... -14 dB	-19 ... -14 dB	-19 ... -14 dB	-19 ... -14 dB
• of the receiver input maximum	-14 dB	-14 dB	-14 dB	-14 dB
Optical sensitivity relative to 1 mW of the receiver input minimum	-32 dB	-32 dB	-32 dB	-32 dB
Attenuation of fiber-optic cable transmission link minimum necessary	0 dB	0 dB	0 dB	0 dB
Range at the optical interface depending on the optical fiber used	0 ... 5 km	0 ... 5 km	0 ... 5 km	0 ... 5 km
Design of the removable storage C-PLUG	Yes	Yes	Yes	Yes
<b>Signal-Inputs/outputs</b>				
Operating voltage of signaling contacts at DC rated value	24 V	24 V	24 V	24 V
Operating current of signaling contacts at DC maximum	0.1 A	0.1 A	0.1 A	0.1 A
<b>Supply voltage, current consumption, power loss</b>				
Type of supply voltage redundant power supply unit	No	No	Yes	Yes
Type of supply voltage	DC	DC	DC	DC
Type 2 of supply voltage	DC	DC	DC	DC
Supply voltage for DC	24 V	24 V	24 V	24 V
• rated value	19.2 ... 57.6 V	19.2 ... 57.6 V	19.2 ... 57.6 V	19.2 ... 57.6 V
Product component fusing at power supply input	Yes	Yes	Yes	Yes
Type of fusing at input for supply voltage	T 4 A / 125 V	T 4 A / 125 V	T 4 A / 125 V	T 4 A / 125 V
Consumed current maximum	0.75 A	0.75 A	0.75 A	0.75 A
Active power loss				
• at 24 V for DC	12 W	12 W	12 W	12 W

# PROFINET/Industrial Ethernet

## Industrial Ethernet Switches

### SCALANCE X-300EEC managed

#### Technical specifications (continued)

Article No.	6GK5307-2FD00-1EA3	6GK5307-2FD00-1GA3	6GK5307-2FD00-2EA3	6GK5307-2FD00-2GA3
Product-type designation	SCALANCE X307-2EEC	SCALANCE X307-2EEC	SCALANCE X307-2EEC	SCALANCE X307-2EEC
<b>Permitted ambient conditions</b>				
Ambient temperature				
• during operating	-40 ... +70 °C	-40 ... +70 °C	-40 ... +70 °C	-40 ... +70 °C
• during storage	-40 ... +70 °C	-40 ... +70 °C	-40 ... +70 °C	-40 ... +70 °C
• during transport	-40 ... +70 °C	-40 ... +70 °C	-40 ... +70 °C	-40 ... +70 °C
• Comment	A maximum operating temperature of +85 °C is permissible for a duration of 16 hours	A maximum operating temperature of +85 °C is permissible for a duration of 16 hours	A maximum operating temperature of +85 °C is permissible for a duration of 16 hours	A maximum operating temperature of +85 °C is permissible for a duration of 16 hours
Relative humidity at 25 °C without condensation during operating maximum	95 %	95 %	95 %	95 %
Ambient condition for (standard) operation mode	Conformal coating, no	Conformal coating, yes	Conformal coating, no	Conformal coating, yes
Protection class IP	IP30	IP30	IP30	IP30
<b>Design, dimensions and weight</b>				
Design	compact	compact	compact	compact
Width	216 mm	216 mm	216 mm	216 mm
Height	143 mm	143 mm	143 mm	143 mm
Depth	110 mm	110 mm	110 mm	110 mm
Net weight	1.8 kg	1.8 kg	2.03 kg	2.03 kg
Mounting type				
• 19-inch installation	Yes	Yes	Yes	Yes
• 35 mm DIN rail mounting	Yes	Yes	Yes	Yes
• wall mounting	Yes	Yes	Yes	Yes
• S7-300 rail mounting	Yes	Yes	Yes	Yes
Mounting type	Wall mounting is possible only with an additional wall bracket; 19" mounting only with installation of two X-300EEC switches in pairs using a mounting plate	Wall mounting is possible only with an additional wall bracket; 19" mounting only with installation of two X-300EEC switches in pairs using a mounting plate	Wall mounting is possible only with an additional wall bracket; 19" mounting only with installation of two X-300EEC switches in pairs using a mounting plate	Wall mounting is possible only with an additional wall bracket; 19" mounting only with installation of two X-300EEC switches in pairs using a mounting plate
<b>Product properties, functions, components general</b>				
Cascading in the case of a redundant ring at reconfiguration time of < 0.3 s	50	50	50	50
Cascading in cases of star structuring	Any (depending only on signal propagation time)	Any (depending only on signal propagation time)	Any (depending only on signal propagation time)	Any (depending only on signal propagation time)
<b>Product functions management, configuration</b>				
Product function				
• CLI	Yes	Yes	Yes	Yes
• web-based management	Yes	Yes	Yes	Yes
• MIB support	Yes	Yes	Yes	Yes
• TRAPs via email	Yes	Yes	Yes	Yes
• Configuration with STEP 7	Yes	Yes	Yes	Yes
• RMON	Yes	Yes	Yes	Yes
• SMTP server	-	-	-	-
• Port mirroring	Yes	Yes	Yes	Yes
• CoS	Yes	Yes	Yes	Yes
• for IRT PROFINET IO switch	No	No	No	No
• PROFINET IO diagnosis	Yes	Yes	Yes	Yes
• switch-managed	Yes	Yes	Yes	Yes

**Technical specifications (continued)**

Article No.	6GK5307-2FD00-1EA3	6GK5307-2FD00-1GA3	6GK5307-2FD00-2EA3	6GK5307-2FD00-2GA3
Product-type designation	SCALANCE X307-2EEC	SCALANCE X307-2EEC	SCALANCE X307-2EEC	SCALANCE X307-2EEC
Protocol is supported				
• Telnet	Yes	Yes	Yes	Yes
• HTTP	Yes	Yes	Yes	Yes
• HTTPS	Yes	Yes	Yes	Yes
• TFTP	Yes	Yes	Yes	Yes
• FTP	Yes	Yes	Yes	Yes
• BOOTP	Yes	Yes	Yes	Yes
• SNMP v1	Yes	Yes	Yes	Yes
• SNMP v2	Yes	Yes	Yes	Yes
• SNMP v3	Yes	Yes	Yes	Yes
• IGMP (snooping/querier)	Yes	Yes	Yes	Yes
• GMRP	Yes	Yes	Yes	Yes
• DCP	Yes	Yes	Yes	Yes
• LLDP	Yes	Yes	Yes	Yes
Identification & maintenance function				
• I&M0 - device-specific information	Yes	Yes	Yes	Yes
• I&M1 - higher level designation/location designation	Yes	Yes	Yes	Yes
<b>Product functions Diagnosis</b>				
Product function				
• Port diagnostics	Yes	Yes	Yes	Yes
• Statistics packet size	Yes	Yes	Yes	Yes
• Statistics packet type	Yes	Yes	Yes	Yes
• Error statistics	Yes	Yes	Yes	Yes
• SysLog	Yes	Yes	Yes	Yes
<b>Product functions VLAN</b>				
Product function				
• VLAN - port based	Yes	Yes	Yes	Yes
• VLAN dynamic	Yes	Yes	Yes	Yes
Number of VLANs maximum	255	255	255	255
Number of VLANs - dynamic maximum	255	255	255	255
Protocol is supported GVRP	Yes	Yes	Yes	Yes
<b>Product functions DHCP</b>				
Product function				
• DHCP client	Yes	Yes	Yes	Yes
• DHCP Option 82	Yes	Yes	Yes	Yes
• DHCP Option 66	Yes	Yes	Yes	Yes
• DHCP Option 67	Yes	Yes	Yes	Yes
<b>Product functions Redundancy</b>				
Product function				
• Ring redundancy	Yes	Yes	Yes	Yes
• Redundancy manager	Yes	Yes	Yes	Yes
• Standby redundancy	Yes	Yes	Yes	Yes
• High Speed Redundancy Protocol (HRP)	Yes	Yes	Yes	Yes
• Media Redundancy Protocol (MRP)	Yes	Yes	Yes	Yes
• Redundancy procedure STP	Yes	Yes	Yes	Yes
• RSTP redundancy protocol	Yes	Yes	Yes	Yes
• Redundancy procedure MSTP	Yes	Yes	Yes	Yes
• Passive listening	Yes	Yes	Yes	Yes
Protocol is supported				
• STP/RSTP	Yes	Yes	Yes	Yes
• STP	Yes	Yes	Yes	Yes
• RSTP	Yes	Yes	Yes	Yes
• RSTP big network support	Yes	Yes	Yes	Yes
• LACP	Yes	Yes	Yes	Yes

## PROFINET/Industrial Ethernet

### Industrial Ethernet Switches

#### SCALANCE X-300EEC managed

#### Technical specifications (continued)

Article No.	6GK5307-2FD00-1EA3	6GK5307-2FD00-1GA3	6GK5307-2FD00-2EA3	6GK5307-2FD00-2GA3
Product-type designation	SCALANCE X307-2EEC	SCALANCE X307-2EEC	SCALANCE X307-2EEC	SCALANCE X307-2EEC
<b>Product functions Security</b>				
Product function				
• ACL - port/MAC-based	Yes	Yes	Yes	Yes
• IEEE 802.1x (radius)	Yes	Yes	Yes	Yes
• Broadcast/Multicast/Unicast Limiter	Yes	Yes	Yes	Yes
• broadcast blocking	Yes	Yes	Yes	Yes
Protocol is supported SSH	Yes	Yes	Yes	Yes
<b>Product functions Time</b>				
Product function SICLOCK support	Yes	Yes	Yes	Yes
Protocol is supported				
• NTP	Yes	Yes	Yes	Yes
• SNTP	Yes	Yes	Yes	Yes
• IEEE 1588 profile default	Yes	Yes	Yes	Yes
<b>Standards, specifications, approvals</b>				
Standard				
• for EMC	IEC 61850, IEEE 1613	IEC 61850, IEEE 1613	IEC 61850, IEEE 1613	IEC 61850, IEEE 1613
• for EMC from FM	FM3611: Class 1, Division 2, Group A, B, C, D / T4, Class 1, Zone 2, Group IIC, T4	FM3611: Class 1, Division 2, Group A, B, C, D / T4, Class 1, Zone 2, Group IIC, T4	FM3611: Class 1, Division 2, Group A, B, C, D / T4, Class 1, Zone 2, Group IIC, T4	FM3611: Class 1, Division 2, Group A, B, C, D / T4, Class 1, Zone 2, Group IIC, T4
• for hazardous zone	EN 60079-0 : 2006, EN 60079-15: 2005, II 3 G Ex nA II T4	EN 60079-0 : 2006, EN 60079-15: 2005, II 3 G Ex nA II T4	EN 60079-0 : 2006, EN 60079-15: 2005, II 3 G Ex nA II T4	EN 60079-0 : 2006, EN 60079-15: 2005, II 3 G Ex nA II T4
• for safety of CSA and UL	UL 508	UL 508	UL 508	UL 508
• for hazardous area of CSA and UL	ANSI / ISA 12.12.01, CSA C22.2 No. 213-M1987, UL 1604 and 2279-15, CL. 1 / Div. 2 / GP. A, B, C, D T4, CL. 1 / Zone 2 / GP. IIC, T4	ANSI / ISA 12.12.01, CSA C22.2 No. 213-M1987, UL 1604 and 2279-15, CL. 1 / Div. 2 / GP. A, B, C, D T4, CL. 1 / Zone 2 / GP. IIC, T4	ANSI / ISA 12.12.01, CSA C22.2 No. 213-M1987, UL 1604 and 2279-15, CL. 1 / Div. 2 / GP. A, B, C, D T4, CL. 1 / Zone 2 / GP. IIC, T4	ANSI / ISA 12.12.01, CSA C22.2 No. 213-M1987, UL 1604 and 2279-15, CL. 1 / Div. 2 / GP. A, B, C, D T4, CL. 1 / Zone 2 / GP. IIC, T4
• for emitted interference	EN 61000-6-4:2007 (Class A)	EN 61000-6-4:2007 (Class A)	EN 61000-6-4:2007 (Class A)	EN 61000-6-4:2007 (Class A)
• for interference immunity	EN 61000-6-2:2005	EN 61000-6-2:2005	EN 61000-6-2:2005	EN 61000-6-2:2005
Verification of suitability	EN 61000-6-2:2005, EN 61000-6-4:2007	EN 61000-6-2:2005, EN 61000-6-4:2007	EN 61000-6-2:2005, EN 61000-6-4:2007	EN 61000-6-2:2005, EN 61000-6-4:2007
• CE mark	Yes	Yes	Yes	Yes
• C-Tick	Yes	Yes	Yes	Yes
• KC approval	Yes	Yes	Yes	Yes
• Railway application in accordance with EN 50155	No	No	No	No
• Railway application in accordance with EN 50124-1	No	No	No	No
• IEC 61850-3	Yes	Yes	Yes	Yes

**Technical specifications (continued)**

Article No.	6GK5307-2FD00-3EA3	6GK5307-2FD00-3GA3	6GK5307-2FD00-4EA3	6GK5307-2FD00-4GA3
Product-type designation	SCALANCE X307-2EEC	SCALANCE X307-2EEC	SCALANCE X307-2EEC	SCALANCE X307-2EEC
<b>Transmission rate</b>				
Transfer rate 1	10 Mbit/s	10 Mbit/s	10 Mbit/s	10 Mbit/s
Transfer rate 2	100 Mbit/s	100 Mbit/s	100 Mbit/s	100 Mbit/s
Transfer rate 3	1 000 Mbit/s	1 000 Mbit/s	1 000 Mbit/s	1 000 Mbit/s
<b>Interfaces</b>				
Number of electrical/optical connections for network components or terminal equipment maximum	9	9	9	9
Number of electrical connections				
• for network components and terminal equipment	7	7	7	7
• for signaling contact	1	1	2	2
• for power supply	1	1	1	1
• for redundant power supply	-	-	1	1
Design of electrical connection				
• for network components and terminal equipment	RJ45 port	RJ45 port	RJ45 port	RJ45 port
• for signaling contact	3-pole terminal block	3-pole terminal block	3-pole terminal block	3-pole terminal block
• for power supply	3-pole terminal block	3-pole terminal block	2 x 3-pole terminal block	2 x 3-pole terminal block
Number of optical interfaces for optical waveguide				
• at 100 Mbit/s	2	2	2	2
Design of optical interface for optical waveguide				
• at 100 Mbit/s	LC port (multimode up to 5 km)	LC port (multimode up to 5 km)	LC port (multimode up to 5 km)	LC port (multimode up to 5 km)
Connectable optical power relative to 1 mW				
• of the transmitter output	-19 ... -14 dB	-19 ... -14 dB	-19 ... -14 dB	-19 ... -14 dB
• of the receiver input maximum	-14 dB	-14 dB	-14 dB	-14 dB
Optical sensitivity relative to 1 mW of the receiver input minimum	-32 dB	-32 dB	-32 dB	-32 dB
Attenuation of fiber-optic cable transmission link minimum necessary	0 dB	0 dB	0 dB	0 dB
Range at the optical interface depending on the optical fiber used	0 ... 5 km	0 ... 5 km	0 ... 5 km	0 ... 5 km
Design of the removable storage C-PLUG	Yes	Yes	Yes	Yes
<b>Signal-Inputs/outputs</b>				
Operating voltage of signaling contacts at AC rated value	276 V	276 V	276 V	276 V
Operating current of signaling contacts at AC maximum	5 A	5 A	5 A	5 A
Operating voltage of signaling contacts at DC rated value	230 V	230 V	230 V	230 V
Operating current of signaling contacts at DC maximum	0.1 A	0.1 A	0.1 A	0.1 A

## PROFINET/Industrial Ethernet

### Industrial Ethernet Switches

#### SCALANCE X-300EEC managed

#### Technical specifications (continued)

Article No.	6GK5307-2FD00-3EA3	6GK5307-2FD00-3GA3	6GK5307-2FD00-4EA3	6GK5307-2FD00-4GA3
Product-type designation	SCALANCE X307-2EEC	SCALANCE X307-2EEC	SCALANCE X307-2EEC	SCALANCE X307-2EEC
<b>Supply voltage, current consumption, power loss</b>				
Type of supply voltage redundant power supply unit	No	No	Yes	Yes
Type of supply voltage	AC	AC	AC	AC
Supply voltage at AC	230 V	230 V	230 V	230 V
• rated value	80 ... 276 V	80 ... 276 V	80 ... 276 V	80 ... 276 V
Type 2 of supply voltage	DC	DC	DC	DC
Supply voltage for DC	220 V	220 V	220 V	220 V
• rated value	46.25 ... 300 V	46.25 ... 300 V	46.25 ... 300 V	46.25 ... 300 V
Product component fusing at power supply input	Yes	Yes	Yes	Yes
Type of fusing at input for supply voltage	T 2 A / 250 V	T 2 A / 250 V	T 2 A / 250 V	T 2 A / 250 V
Consumed current maximum	0.08 A	0.08 A	0.08 A	0.08 A
Active power loss				
• at 230 V AC	18 W	18 W	18 W	18 W
• at 250 V with DC	18 W	18 W	18 W	18 W
<b>Permitted ambient conditions</b>				
Ambient temperature				
• during operating	-40 ... +70 °C	-40 ... +70 °C	-40 ... +70 °C	-40 ... +70 °C
• during storage	-40 ... +70 °C	-40 ... +70 °C	-40 ... +70 °C	-40 ... +70 °C
• during transport	-40 ... +70 °C	-40 ... +70 °C	-40 ... +70 °C	-40 ... +70 °C
• Comment	A maximum operating temperature of +85 °C is permissible for a duration of 16 hours	A maximum operating temperature of +85 °C is permissible for a duration of 16 hours	A maximum operating temperature of +85 °C is permissible for a duration of 16 hours	A maximum operating temperature of +85 °C is permissible for a duration of 16 hours
Relative humidity at 25 °C without condensation during operating maximum	95 %	95 %	95 %	95 %
Ambient condition for (standard) operation mode	Conformal coating, no	Conformal coating, yes	Conformal coating, no	Conformal coating, yes
Protection class IP	IP30	IP30	IP30	IP30
<b>Design, dimensions and weight</b>				
Design	compact	compact	compact	compact
Width	216 mm	216 mm	216 mm	216 mm
Height	143 mm	143 mm	143 mm	143 mm
Depth	110 mm	110 mm	110 mm	110 mm
Net weight	1.85 kg	1.85 kg	2.12 kg	2.12 kg
Mounting type				
• 19-inch installation	Yes	Yes	Yes	Yes
• 35 mm DIN rail mounting	Yes	Yes	Yes	Yes
• wall mounting	Yes	Yes	Yes	Yes
• S7-300 rail mounting	Yes	Yes	Yes	Yes
Mounting type	Wall mounting is possible only with an additional wall bracket; 19" mounting only with installation of two X-300EEC switches in pairs using a mounting plate	Wall mounting is possible only with an additional wall bracket; 19" mounting only with installation of two X-300EEC switches in pairs using a mounting plate	Wall mounting is possible only with an additional wall bracket; 19" mounting only with installation of two X-300EEC switches in pairs using a mounting plate	Wall mounting is possible only with an additional wall bracket; 19" mounting only with installation of two X-300EEC switches in pairs using a mounting plate
<b>Product properties, functions, components general</b>				
Cascading in the case of a redundant ring at reconfiguration time of < 0.3 s	50	50	50	50
Cascading in cases of star structuring	Any (depending only on signal propagation time)	Any (depending only on signal propagation time)	Any (depending only on signal propagation time)	Any (depending only on signal propagation time)



**Technical specifications (continued)**

Article No.	6GK5307-2FD00-3EA3	6GK5307-2FD00-3GA3	6GK5307-2FD00-4EA3	6GK5307-2FD00-4GA3
Product-type designation	SCALANCE X307-2EEC	SCALANCE X307-2EEC	SCALANCE X307-2EEC	SCALANCE X307-2EEC
<b>Product functions management, configuration</b>				
Product function				
• CLI	Yes	Yes	Yes	Yes
• web-based management	Yes	Yes	Yes	Yes
• MIB support	Yes	Yes	Yes	Yes
• TRAPs via email	Yes	Yes	Yes	Yes
• Configuration with STEP 7	Yes	Yes	Yes	Yes
• RMON	Yes	Yes	Yes	Yes
• Port mirroring	Yes	Yes	Yes	Yes
• CoS	Yes	Yes	Yes	Yes
• for IRT PROFINET IO switch	No	No	No	No
• PROFINET IO diagnosis	Yes	Yes	Yes	Yes
• switch-managed	Yes	Yes	Yes	Yes
Protocol is supported				
• Telnet	Yes	Yes	Yes	Yes
• HTTP	Yes	Yes	Yes	Yes
• HTTPS	Yes	Yes	Yes	Yes
• TFTP	Yes	Yes	Yes	Yes
• FTP	Yes	Yes	Yes	Yes
• BOOTP	Yes	Yes	Yes	Yes
• SNMP v1	Yes	Yes	Yes	Yes
• SNMP v2	Yes	Yes	Yes	Yes
• SNMP v3	Yes	Yes	Yes	Yes
• IGMP (snooping/querier)	Yes	Yes	Yes	Yes
• GMRP	Yes	Yes	Yes	Yes
• DCP	Yes	Yes	Yes	Yes
• LLDP	Yes	Yes	Yes	Yes
Identification & maintenance function				
• I&M0 - device-specific information	Yes	Yes	Yes	Yes
• I&M1 - higher level designation/location designation	Yes	Yes	Yes	Yes
<b>Product functions Diagnosis</b>				
Product function				
• Port diagnostics	Yes	Yes	Yes	Yes
• Statistics packet size	Yes	Yes	Yes	Yes
• Statistics packet type	Yes	Yes	Yes	Yes
• Error statistics	Yes	Yes	Yes	Yes
• SysLog	Yes	Yes	Yes	Yes
<b>Product functions VLAN</b>				
Product function				
• VLAN - port based	Yes	Yes	Yes	Yes
• VLAN dynamic	Yes	Yes	Yes	Yes
Number of VLANs maximum	255	255	255	255
Number of VLANs - dynamic maximum	255	255	255	255
Protocol is supported GVRP	Yes	Yes	Yes	Yes
<b>Product functions DHCP</b>				
Product function				
• DHCP client	Yes	Yes	Yes	Yes
• DHCP Option 82	Yes	Yes	Yes	Yes
• DHCP Option 66	Yes	Yes	Yes	Yes
• DHCP Option 67	Yes	Yes	Yes	Yes

# PROFINET/Industrial Ethernet

## Industrial Ethernet Switches

### SCALANCE X-300EEC managed

#### Technical specifications (continued)

Article No.	6GK5307-2FD00-3EA3	6GK5307-2FD00-3GA3	6GK5307-2FD00-4EA3	6GK5307-2FD00-4GA3
Product-type designation	SCALANCE X307-2EEC	SCALANCE X307-2EEC	SCALANCE X307-2EEC	SCALANCE X307-2EEC
<b>Product functions Redundancy</b>				
Product function				
• Ring redundancy	Yes	Yes	Yes	Yes
• Redundancy manager	Yes	Yes	Yes	Yes
• Standby redundancy	Yes	Yes	Yes	Yes
• High Speed Redundancy Protocol (HRP)	Yes	Yes	Yes	Yes
• Media Redundancy Protocol (MRP)	Yes	Yes	Yes	Yes
• redundancy procedure STP	Yes	Yes	Yes	Yes
• RSTP redundancy protocol	Yes	Yes	Yes	Yes
• redundancy procedure MSTP	Yes	Yes	Yes	Yes
• Passive listening	Yes	Yes	Yes	Yes
Protocol is supported				
• STP/RSTP	Yes	Yes	Yes	Yes
• STP	Yes	Yes	Yes	Yes
• RSTP	Yes	Yes	Yes	Yes
• RSTP big network support	Yes	Yes	Yes	Yes
• LACP	Yes	Yes	Yes	Yes
<b>Product functions Security</b>				
Product function				
• ACL - port/MAC-based	Yes	Yes	Yes	Yes
• IEEE 802.1x (radius)	Yes	Yes	Yes	Yes
• Broadcast/Multicast/Unicast Limiter	Yes	Yes	Yes	Yes
• broadcast blocking	Yes	Yes	Yes	Yes
Protocol is supported SSH	Yes	Yes	Yes	Yes
<b>Product functions Time</b>				
Product function SICLOCK support	Yes	Yes	Yes	Yes
Protocol is supported				
• NTP	Yes	Yes	Yes	Yes
• SNTP	Yes	Yes	Yes	Yes
• IEEE 1588 profile default	Yes	Yes	Yes	Yes
<b>Standards, specifications, approvals</b>				
Standard				
• for EMC	IEC 61850, IEEE 1613	IEC 61850, IEEE 1613	IEC 61850, IEEE 1613	IEC 61850, IEEE 1613
• for safety of CSA and UL	UL 508, CSA C22.2 No. 142-M1987	UL 508, CSA C22.2 No. 142-M1987	UL 508, CSA C22.2 No. 142-M1987	UL 508, CSA C22.2 No. 142-M1987
• for emitted interference	EN 61000-6-4:2007 (Class A)	EN 61000-6-4:2007 (Class A)	EN 61000-6-4:2007 (Class A)	EN 61000-6-4:2007 (Class A)
• for interference immunity	EN 61000-6-2:2005	EN 61000-6-2:2005	EN 61000-6-2:2005	EN 61000-6-2:2005
Verification of suitability	EN 61000-6-2:2005, EN 61000-6-4:2007	EN 61000-6-2:2005, EN 61000-6-4:2007	EN 61000-6-2:2005, EN 61000-6-4:2007	EN 61000-6-2:2005, EN 61000-6-4:2007
• CE mark	Yes	Yes	Yes	Yes
• C-Tick	Yes	Yes	Yes	Yes
• KC approval	Yes	Yes	Yes	Yes
• Railway application in accordance with EN 50155	No	No	No	No
• Railway application in accordance with EN 50124-1	No	No	No	No
• IEC 61850-3	Yes	Yes	Yes	Yes
Certificate of suitability IEEE 1613	Yes	Yes	Yes	Yes

**Ordering data**
**Article No.**
**Article No.**
**SCALANCE X-300EEC Industrial Ethernet switches**

Compact Industrial Ethernet switches for setting up electrical and/or optical Industrial Ethernet networks; RSTP, RMON, IGMP Snooping/Querier, management functionality via SNMP, PROFINET and web server, 24 V power supply

**SCALANCE X302-7EEC;**

2 x 10/100/1 000 Mbit/s  
 RJ45 ports, electrical;  
 7 x 100 Mbit/s LC ports, optical (multimode, glass)  
 up to 5 km

24 V DC power supply

- 1 power supply
- 2 power supplies
- 1 power supply with conformal coating
- 2 power supplies with conformal coating

100-240 AC / 60-250 V DC power supply

- 1 power supply
- 2 power supplies
- 1 power supply with conformal coating
- 2 power supplies with conformal coating

**SCALANCE X307-2EEC;**

5 x 10/100 Mbit/s  
 RJ45 ports, electrical;  
 2 x 10/100/1 000 Mbit/s  
 RJ45 ports, electrical  
 2 x 100 Mbit/s  
 LC ports, optical (multimode, glass)  
 up to 5 km

24 V DC power supply

- 1 power supply
- 2 power supplies
- 1 power supply with conformal coating
- 2 power supplies with conformal coating

100-240 AC/60-250 V DC power supply

- 1 power supply
- 2 power supplies
- 1 power supply with conformal coating
- 2 power supplies with conformal coating

**6GK5302-7GD00-1EA3**
**6GK5302-7GD00-2EA3**
**6GK5302-7GD00-1GA3**
**6GK5302-7GD00-2GA3**
**6GK5302-7GD00-3EA3**
**6GK5302-7GD00-4EA3**
**6GK5302-7GD00-3GA3**
**6GK5302-7GD00-4GA3**
**6GK5307-2FD00-1EA3**
**6GK5307-2FD00-2EA3**
**6GK5307-2FD00-1GA3**
**6GK5307-2FD00-2GA3**
**6GK5307-2FD00-3EA3**
**6GK5307-2FD00-4EA3**
**6GK5307-2FD00-3GA3**
**6GK5307-2FD00-4GA3**
**Accessories**
**IE FC TP Standard Cable GP 2 x 2 (Type A)**

4-core, shielded TP installation cable for connection to IE FC Outlet RJ45/IE FC RJ45 Plug; PROFINET compatible; with UL approval; sold by the meter; max. length 1 000 m, minimum order length 20 m

**6XV1840-2AH10**
**IE FC TP standard cable GP 4 x 2**

8-core, shielded TP installation cable for connection to IE FC RJ45 modular outlet for universal application; with UL approval; sold by the meter; max length 1 000 m, minimum order 20 m

- AWG 22, for connection to IE FC RJ45 Modular Outlet

**6XV1870-2E**

- AWG 24, for connection to IE FC RJ45 Plug 4 x 2

**6XV1878-2A**
**IE FC TP Flexible Cable GP 4 x 2**

8-core, shielded TP installation cable for occasional moving; with UL approval; sold by the meter; max. delivery unit 1 000 m, minimum order 20 m

- AWG 24, for connection to IE FC RJ45 Plug 4 x 2

**6XV1878-2B**
**IE TP Cord RJ45/RJ45**

TP cable 4 x 2 with two RJ45 plugs

- 0.5 m
- 1 m
- 2 m
- 6 m
- 10 m

**6XV1870-3QE50**
**6XV1870-3QH10**
**6XV1870-3QH20**
**6XV1870-3QH60**
**6XV1870-3QN10**

## PROFINET/Industrial Ethernet

### Industrial Ethernet Switches

#### SCALANCE X-300EEC managed

#### Ordering data

#### Article No.

##### Accessories (continued)

##### IE FC RJ45 Plug 180

RJ45 plug-in connector for Industrial Ethernet with a rugged metal enclosure and integrated insulation displacement contacts for connecting Industrial Ethernet FC installation cables; with 180° cable outlet; for network components and CPs/CPU with Industrial Ethernet interface

- 1 pack = 1 unit
- 1 pack = 10 units
- 1 pack = 50 units

**6GK1901-1BB10-2AA0**  
**6GK1901-1BB10-2AB0**  
**6GK1901-1BB10-2AE0**

##### IE FC RJ45 Plug 4 x 2

RJ45 plug connector for Industrial Ethernet (10/100/1 000 Mbit/s) with a rugged metal enclosure and integrated insulation displacement contacts for connecting Industrial Ethernet FC installation cables; 180° cable outlet; for network components and CPs/CPU with Industrial Ethernet interface

- 1 pack = 1 unit
- 1 pack = 10 units
- 1 pack = 50 units

**6GK1901-1BB11-2AA0**  
**6GK1901-1BB11-2AB0**  
**6GK1901-1BB11-2AE0**

##### IE FC Stripping Tool

Preadjusted stripping tool for fast stripping of Industrial Ethernet FC cables

**6GK1901-1GA00**

##### SIPLUS PS modular 5 A

Single-phase and 2-phase power supply with wide-range input 85 ... 264 V / 176 V ... 550 V AC, regulated output voltage 24 V, output current rated value 5 A, coating of the PCB and electronic components (conformal coating)

**6AG1933-3BA00-2AA0**

##### IE FC RJ45 Modular Outlet

FastConnect RJ45 outlet for Industrial Ethernet with interface for replaceable insert

- with insert 2FE ; replaceable insert for 2 x 100 Mbit/s interfaces
- with 1GE insert; replaceable insert for 1 x 1 000 Mbit/s interfaces

**6GK1901-1BE00-0AA1**  
  
**6GK1901-1BE00-0AA2**

#### More information

##### Selection tool:

To assist in selecting the right Industrial Ethernet switches as well as configuration of modular variants, the SIMATIC NET Selection Tool and the TIA Selection Tool are available at:

SIMATIC NET Selection Tool:

- Online version:  
<http://www.siemens.com/snst>
- Offline version:  
<http://www.siemens.com/snst-download>

TIA Selection Tool:

<http://www.siemens.com/tia-selection-tool>

## Overview



The SCALANCE XR-300EEC (**E**nhanced **E**nvironmental **C**onditions) industrial Ethernet switches are partly modular, high-performance, industry-standard switches for the construction of electrical and/or optical line, ring and star topologies at data transfer rates of 10/100/1 000 Mbit/s, designed for installation in 19" control cabinets.

- As many as 24 electrical and/or optical interfaces (10/100/1 000 Mbit/s), of which 16 are integral RJ45 ports; up to four electrical and/or optical 2-port media modules can also be inserted in the media module slots of the basic device
- Suitable for use in extremely harsh industrial environments and in low-voltage and high-voltage switchgear thanks to:
  - Extended temperature range (-40 to +70 °C, briefly to +85 °C)
  - Support for special protocols and standards (IEEE 1613 and IEC 61850-3)
  - Wide-range power supplies (60 to 250 V AC/DC)
- High-speed media redundancy through integral redundancy manager both for Gigabit Ethernet and Fast Ethernet
- Seamless integration of automation networks into existing corporate networks thanks to support for a host of IT standards (VLANs, IGMP-Snooping/Querier, STP/RSTP, Link Aggregation, Quality of Service)
- Remote diagnostics by means of PROFINET diagnostics, Web browser, CLI, or SNMP

### Product versions

#### SCALANCE XR324-4M EEC (4 media module slots)

Versions are available with

- LEDs, data cable outlet on the front and power supply connection at the rear
- LEDs, power supply connection on the front, data cable outlet at the rear

All versions have four media module slots and

- 1 x 24 V DC power supply
- 2 x 24 V DC power supplies
- 1 x 230 V AC power supply
- 2 x 230 V AC power supplies

## Benefits

get **Designed for Industry**

- Increased availability of the network due to hardware and software functions specially geared to the particular requirements of energy technology plants and extreme environmental conditions
- Unlimited flexibility during network expansions (e.g. more terminals) or conversion (e.g. switching from copper to fiber-optic cable) and reduction of the storage costs due to the modular construction using port modules
- High availability of the network thanks to:
  - Redundant power supply
  - Redundant network structures based on fiber-optic or twisted pair cables (redundancy manager, standby function, and STP/RSTP are integrated)
  - Easy device replacement by means of plug-in C-PLUG swap medium
  - Very fast reconfiguration of the network in the event of a fault
- Lower susceptibility to failure and higher availability of the plant networking due to latching of the RJ45 FastConnect connectors in the sleeve of the RJ45 port modules
- Protection of investment due to integration into existing network management systems by means of standardized SNMP access
- Time saving during engineering, commissioning and in the operating phase of a plant by using the integrated configuration and diagnostics in STEP 7, without additional software

## Application

The SCALANCE XR-300EEC is ideal for use in plant networks and for integrating the industrial network into an existing corporate network. Both at the field level and the control level, the switch performs the network with the distributed field devices and ensures high plant availability with extensive diagnostics options and high transmission speeds. The modularity permits perfect adaptation to the respective application through the use of electrical and/or optical media modules.

The main area of application is found in high-performance plant networks with interfaces to the corporate network. Thanks to the immunity to electromagnetic interference of the SCALANCE XR-300EEC switches, the devices can also be used in medium/high voltage substations.

The SCALANCE XR-300EEC switch is suitable for establishing optical Industrial Ethernet line, star or ring topologies with 24 ports, 16 of which are integrated RJ45 ports. Up to four electrical and/or optical 2-port media modules can also be inserted in the media module slots of the basic device. The switch can also be used as a hub in the plant bus (redundant connection is possible).

The use of media modules in partly and fully modular versions of the SCALANCE X-300 switches supports:

- Extension of networks by subsequent insertion of additional media modules in unused media module slots
- Changing of cabling technology, such as conversion from copper to fiber-optic cables, or from multimode to single-mode FOC

## PROFINET/Industrial Ethernet

### Industrial Ethernet Switches

#### SCALANCE XR-300EEC managed

#### Application (continued)

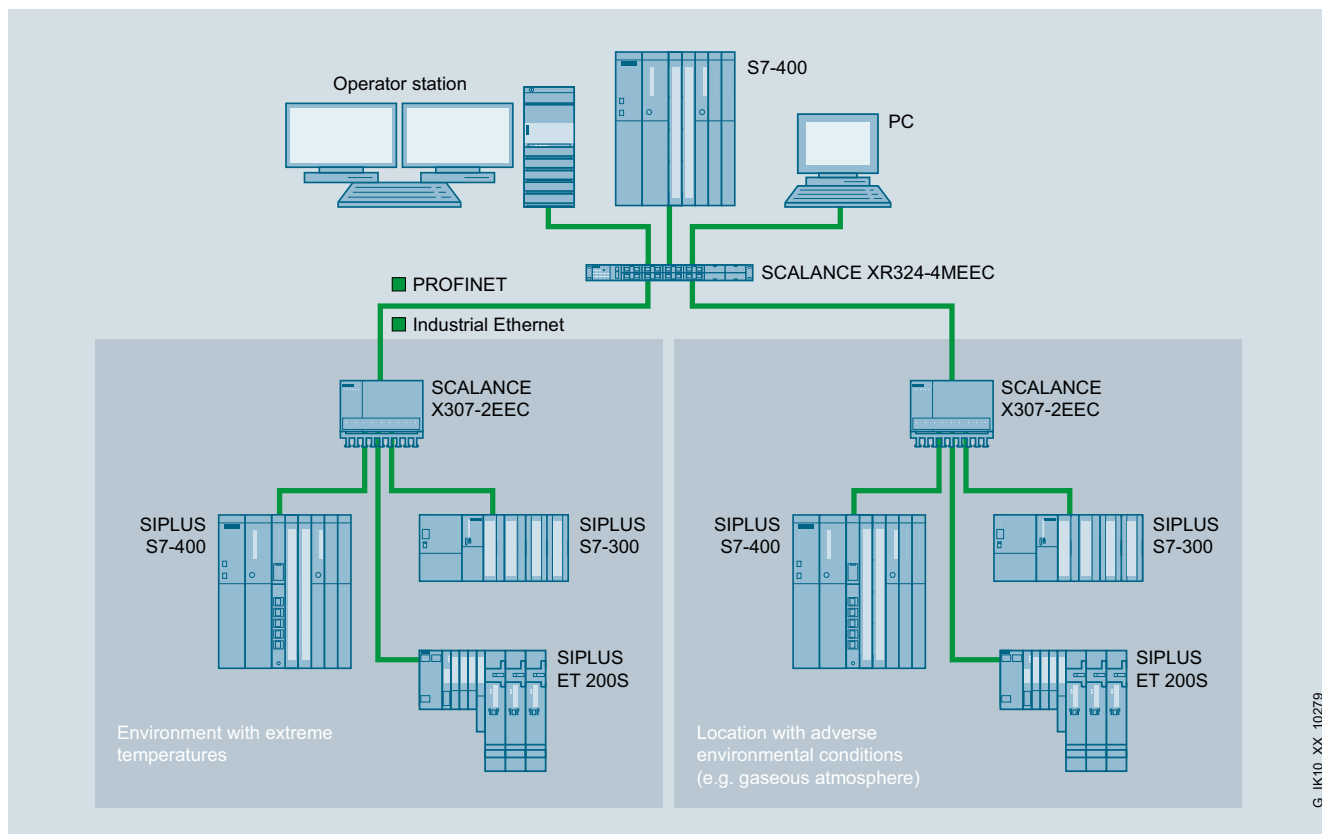

Star structure in switchgear under extreme ambient conditions with SCALANCE XR324-4M EEC and X-300EEC

#### Design

The SCALANCE XR-300EEC Industrial Ethernet switches with rugged metal enclosure with IP20 degree of protection are optimized for installation in the 19" cabinet.

The switches have:

- 4-pin terminal block for redundant voltage feed for protection against voltage failure in 24 V DC version
- 3-pin terminal block for voltage feed in 230 V AC version
- 2-pin terminal block for connecting the isolated signaling contact for simple display of faults
- A row of LEDs to indicate the status information (power, link status, data traffic, power supply, signaling contact)
- SELECT/SET pushbutton for simple adjustment of the fault signaling contact on the device
- Slot for optional C-PLUG swap medium on the side of the device for easy replacement in the event of a fault
- Console port (serial interface) for on-site parameterization/diagnostics (RJ11 cable to RS232 (9-pin) included in scope of delivery)

The SCALANCE XR-300EEC switches are available with the following port types:

- 16 integrated RJ45 ports;  
The RJ45 sockets are designed to be industry-compatible with additional sleeves, for connection of the Industrial Ethernet FC RJ45 Plug 180
- Four slots for electrical or optical 2-port media modules for multimode or single-mode connections; the optical media modules are available in various connection technologies
- All electrical Ethernet interfaces support 10/100/1 000 Mbit/s, all optical Ethernet interfaces support 100 or 1 000 Mbit/s
- The SCALANCE XR-300EEC switches support Gigabit Ethernet (1 000 Mbit/s) at all ports.  
The 24 ports are divided into three groups of eight ports each (Gigabit Ethernet Blocking). Gigabit Ethernet is supported with full wire speed within each group, but not between the groups.

G\_IK10\_XX\_10279

## Function

- Integrated redundancy manager for constructing Fast Ethernet and Gigabit Ethernet ring topologies with high-speed media redundancy. Reliable communication is achieved by closing an optical or electrical line with SCALANCE X-400, X-300 or X-200 switches to form a ring. The redundancy manager (RM) integrated in the SCALANCE XR-300 switch monitors the function of the network. It recognizes the failure of a transmission link or of SCALANCE X switch in the ring and activates the substitute path within a maximum of 0.2 seconds.
- Redundant interfacing to corporate networks; SCALANCE XR-300EEC switches support the standardized redundancy procedures Spanning Tree Protocol (STP) and Rapid Spanning Tree Protocol (RSTP). This enables a subnetwork to be connected redundantly to a higher level corporate network with reduced requirements for the reconfiguration time (in the order of seconds). By supporting the Multiple Spanning Tree Protocol (MSTP), a network can also be split into multiple sub-segments.
- Support of virtual networks (VLAN); for structuring Industrial Ethernet networks with a fast growing number of users, a physically existing network can be divided into several virtual networks.
- Load limiting when multicast protocols (e.g. video transmission) are used; through learning the multicast sources and targets (IGMP Snooping, IGMP Querier), SCALANCE XR-300EEC switches can also filter multicast data traffic and therefore limit the load in the network. Multicast and broadcast traffic can be limited.
- Time synchronization; diagnostic messages (log table entries, e-mails) are time-stamped. The local time is standardized throughout the network by means of synchronization with a SICKLOCK time transmitter, SNTP or NTP server or via IEEE1588, thereby simplifying the assignment of diagnostic messages of multiple devices.
- Fast replacement of devices in event of failure, by means of the C-PLUG switching medium
- Link aggregation (IEEE 802.1q) for bundling data streams
- Quality of Service (IEEE 802.1p) for prioritization of network traffic

## Network topology and network configuration

The network topology can easily be adapted to the structure of the plant using SCALANCE XR-300 Industrial Ethernet switches.

The following network structures and combinations of structures can be implemented:

- Fast Ethernet rings with fast media redundancy; to increase network availability, as many as 50 X-200, X-300, X-400 or X-500 switches cascaded in line can be connected into a ring.
- Several rings can be redundantly linked through the standby function
- At the same time, SCALANCE XR-300EEC supports redundant connection of the ring structure to the corporate network with a rapid spanning tree.
- Star topology with SCALANCE XR-300EEC switches: The SCALANCE XR-300EEC switch represents a neutral point that can interconnect up to 24 nodes or subnets electrically.

When configuring the network, it is necessary to observe the following boundary conditions:

- Maximum line length between two modules for multi-mode fiber-optic conductors:
  - 5 km at 100 Mbit/s
  - 750 m at 1 000 Mbit/s
- Maximum line length between two modules for single-mode fiber-optic conductors:
  - 26 to 70 km at 100 Mbit/s
  - 10 to 120 km at 1 000 Mbit/s
- Maximum cable length of the TP cable between two SCALANCE X switches:
  - Max. 100 m with IE FC cable 2x2 and IE FC RJ45 Plug 180
  - Max. 100 m at 1 000 Mbit/s with IE FC Standard Cable 4x2 (90 m), IE FC RJ45 Modular Outlet and patch cable (10 m)
  - Max. 10 m using patches with TP cord

## PROFINET/Industrial Ethernet

### Industrial Ethernet Switches

#### SCALANCE XR-300EEC managed

#### Function (continued)

##### Commissioning and diagnosis

Setting options on the device itself:

- Redundancy manager RM; to establish a ring, a SCALANCE XR-300EEC is switched to RM mode. The Gigabit ports (electrical or optical) are preferably used as ring ports. The non-ring ports of the RM can be used freely for the connection of data terminals and networks. If the redundancy procedure MRP standardized by PROFINET is used, the RM is adjusted automatically.
- Signal mask; the signal mask is set to the current status of the SCALANCE XR-300EEC (setpoint) by pushbutton operation. The signal mask defines which ports and which power supplies are to be monitored. The signaling contact only reports an error when a monitored port or a monitored feeder fails (deviation of setpoint/actual status).
- IP address; the IP address is assigned via DHCP (Dynamic Host Configuration Protocol). If there is no corresponding server in the network, the IP address can be assigned using an enclosed software tool.

Diagnostic options on site:

- The following status information is displayed by LEDs on site:
  - Port status
  - Port mode (10/100/1 000 Mbit/s, full/half-duplex)
  - Status of the two power supplies
  - Signaling contact status
  - Signal mask (setpoint status)
  - RM mode
  - Standby mode
- The status of the signaling contact is routed externally by means of floating relay contacts. This enables the module to be monitored via an input module from a controller.
- Monitoring via the Industrial Ethernet network; the following possibilities are available:
  - Remote via standard browser (Web-based management): Selection of SCALANCE XR-300EEC switches via the network from a PC with browser
  - Remote via SNMP V1, V2c, V3: Secure integration of SCALANCE XR-300EEC switches via the network to a network management system, e.g. SINEMA Server
  - Remote via PROFINET IO diagnostics: PROFINET diagnostic alarms from SCALANCE XR-300EEC switches can be displayed using the relevant SIMATIC engineering tools and they can also be processed in the controller. The engineering outlay for the PLC and HMI have been drastically reduced due to the complete integration in the SIMATIC concept for system error messages.

##### Network management

The network management provides the following functions:

- Password-protected dial-up for "Administrator" (read and write authorization) and "User" (read only)
- Read-out of version and status information
- Setting the signal and standby mask and address information
- Parameterization of the web management services
- Setting of Rapid Spanning Tree parameters
- Fixed parameterization of the ports (data rates, half/full duplex)
- Security
  - Ports can be connected or disconnected
  - Port-based network access control according to IEEE 802.1x (available soon)
  - Support of Access Control List (ACL) (available soon)
- Output of statistics information
- Diagnosis of data traffic by means of a parameterizable mirror port with a standard commercial network analyzer
- Loading of new firmware versions or of the configuration data via the network by a TFTP server or directly via HTTP/HTTPS using a Web browser
- Saving the configuration data or log table via the network on a TFTP server

If faults occur in the network, the SCALANCE XR-300EEC switch can independently send error messages (traps) to a network management system or also e-mails to a predefined network administrator.

Remote monitoring (RMON) provides the following functions: The SCALANCE X-300EEC switch can collect statistics information according to the RMON groups 1 through 4. These include, for example, fault statistics that are kept for each port. This information can be read out through web-based management in the statistics sub-area.



**Technical specifications**

Article No.	6GK5324-4GG00-1ER2	6GK5324-4GG00-1JR2	6GK5324-4GG00-2ER2	6GK5324-4GG00-2JR2
Product-type designation	SCALANCE XR324-4M EEC	SCALANCE XR324-4M EEC	SCALANCE XR324-4M EEC	SCALANCE XR324-4M EEC
<b>Transmission rate</b>				
Transfer rate 1	10 Mbit/s	10 Mbit/s	10 Mbit/s	10 Mbit/s
Transfer rate 2	100 Mbit/s	100 Mbit/s	100 Mbit/s	100 Mbit/s
Transfer rate 3	1 000 Mbit/s	1 000 Mbit/s	1 000 Mbit/s	1 000 Mbit/s
<b>Interfaces</b>				
Number of electrical/optical connections for network components or terminal equipment maximum	24	24	24	24
Number of electrical connections				
• for network components and terminal equipment	16	16	16	16
• for operator console	1	1	1	1
• for signaling contact	1	1	1	1
• for media module	4	4	4	4
• for power supply	1	1	2	2
• for redundant power supply	1	1	1	1
Design of electrical connection				
• for network components and terminal equipment	RJ45 port	RJ45 port	RJ45 port	RJ45 port
• for operator console	RJ11 port	RJ11 port	RJ11 port	RJ11 port
• for signaling contact	2-pole terminal block	2-pole terminal block	2 x 2-pole terminal block	2 x 2-pole terminal block
• for power supply	4-pole terminal block	4-pole terminal block	2 x 4-pole terminal block	2 x 4-pole terminal block
Design of optical interface for optical waveguide				
• at 100 Mbit/s	Dependent on selected media modules	Dependent on selected media modules	Dependent on selected media modules	Dependent on selected media modules
• at 1 000 Mbit/s	Dependent on selected media modules	Dependent on selected media modules	Dependent on selected media modules	Dependent on selected media modules
design of the removable storage C-PLUG	Yes	Yes	Yes	Yes
<b>Signal-Inputs/outputs</b>				
Operating voltage of signaling contacts at DC rated value	24 V	24 V	24 V	24 V
Operating current of signaling contacts at DC maximum	0.1 A	0.1 A	0.1 A	0.1 A
<b>Supply voltage, current consumption, power loss</b>				
Type of supply voltage redundant power supply unit	No	No	Yes	Yes
Type of supply voltage	DC	DC	DC	DC
Type 2 of supply voltage	DC	DC	DC	DC
Supply voltage for DC	24 V	24 V	24 V	24 V
• rated value	19.2 ... 57.6 V	19.2 ... 57.6 V	19.2 ... 57.6 V	19.2 ... 57.6 V
Product component fusing at power supply input	Yes	Yes	Yes	Yes
Type of fusing at input for supply voltage	T2H / 250 V	T2H / 250 V	T2H / 250 V	T2H / 250 V
Consumed current maximum	1.6 A	1.6 A	1.6 A	1.6 A
Active power loss				
• at 24 V for DC	40 W	40 W	40 W	40 W

## PROFINET/Industrial Ethernet

### Industrial Ethernet Switches

#### SCALANCE XR-300EEC managed

#### Technical specifications (continued)

Article No.	6GK5324-4GG00-1ER2	6GK5324-4GG00-1JR2	6GK5324-4GG00-2ER2	6GK5324-4GG00-2JR2
Product-type designation	SCALANCE XR324-4M EEC	SCALANCE XR324-4M EEC	SCALANCE XR324-4M EEC	SCALANCE XR324-4M EEC
<b>Permitted ambient conditions</b>				
Ambient temperature				
• during operating	-40 ... +70 °C	-40 ... +70 °C	-40 ... +70 °C	-40 ... +70 °C
• during storage	-40 ... +85 °C	-40 ... +85 °C	-40 ... +85 °C	-40 ... +85 °C
• during transport	-40 ... +85 °C	-40 ... +85 °C	-40 ... +85 °C	-40 ... +85 °C
• Comment	Extended temperature upper limit of +85° C permitted for 16 hours. Reduced operating temperature through the use of media modules (-40 °C to +70 °C) or SFP plug-in transceivers (-40 °C to +60 °C)	Extended temperature upper limit of +85° C permitted for 16 hours. Reduced operating temperature through the use of media modules (-40 °C to +70 °C) or SFP plug-in transceivers (-40 °C to +60 °C)	Extended temperature upper limit of +85° C permitted for 16 hours. Reduced operating temperature through the use of media modules (-40 °C to +70 °C) or SFP plug-in transceivers (-40 °C to +60 °C)	Extended temperature upper limit of +85° C permitted for 16 hours. Reduced operating temperature through the use of media modules (-40 °C to +70 °C) or SFP plug-in transceivers (-40 °C to +60 °C)
Relative humidity at 25 °C without condensation during operating maximum	95 %	95 %	95 %	95 %
Protection class IP	IP20	IP20	IP20	IP20
<b>Design, dimensions and weight</b>				
Design	19" rack	19" rack	19" rack	19" rack
Width	483 mm	483 mm	483 mm	483 mm
Height	44 mm	44 mm	44 mm	44 mm
Depth	305 mm	305 mm	305 mm	305 mm
Net weight	6.5 kg	6.5 kg	6.8 kg	6.8 kg
Mounting type				
• 19-inch installation	Yes	Yes	Yes	Yes
• 35 mm DIN rail mounting	No	No	No	No
• wall mounting	No	No	No	No
• S7-300 rail mounting	No	No	No	No
Mounting type	When used in shipbuilding, the device must be secured in the 19" rack at four points	When used in shipbuilding, the device must be secured in the 19" rack at four points	When used in shipbuilding, the device must be secured in the 19" rack at four points	When used in shipbuilding, the device must be secured in the 19" rack at four points
<b>Product properties, functions, components general</b>				
Cascading in the case of a redundant ring at reconfiguration time of < 0.3 s	50	50	50	50
Cascading in cases of star structuring	Any (depending only on signal propagation time)	Any (depending only on signal propagation time)	Any (depending only on signal propagation time)	Any (depending only on signal propagation time)
<b>Product functions management, configuration</b>				
Product function				
• CLI	Yes	Yes	Yes	Yes
• web-based management	Yes	Yes	Yes	Yes
• MIB support	Yes	Yes	Yes	Yes
• TRAPs via email	Yes	Yes	Yes	Yes
• Configuration with STEP 7	Yes	Yes	Yes	Yes
• RMON	Yes	Yes	Yes	Yes
• Port mirroring	Yes	Yes	Yes	Yes
• CoS	Yes	Yes	Yes	Yes
• for IRT PROFINET IO switch	-	-	-	-
• PROFINET IO diagnosis	Yes	Yes	Yes	Yes
• switch-managed	Yes	Yes	Yes	Yes

**Technical specifications (continued)**

Article No.	6GK5324-4GG00-1ER2	6GK5324-4GG00-1JR2	6GK5324-4GG00-2ER2	6GK5324-4GG00-2JR2
Product-type designation	SCALANCE XR324-4M EEC	SCALANCE XR324-4M EEC	SCALANCE XR324-4M EEC	SCALANCE XR324-4M EEC
Protocol is supported				
• Telnet	Yes	Yes	Yes	Yes
• HTTP	Yes	Yes	Yes	Yes
• HTTPS	Yes	Yes	Yes	Yes
• TFTP	Yes	Yes	Yes	Yes
• FTP	Yes	Yes	Yes	Yes
• BOOTP	Yes	Yes	Yes	Yes
• SNMP v1	Yes	Yes	Yes	Yes
• SNMP v2	Yes	Yes	Yes	Yes
• SNMP v3	Yes	Yes	Yes	Yes
• IGMP (snooping/querier)	Yes	Yes	Yes	Yes
• GMRP	Yes	Yes	Yes	Yes
• DCP	Yes	Yes	Yes	Yes
• LLDP	Yes	Yes	Yes	Yes
Identification & maintenance function				
• I&M0 - device-specific information	Yes	Yes	Yes	Yes
• I&M1 - higher level designation/location designation	Yes	Yes	Yes	Yes
<b>Product functions Diagnosis</b>				
Product function				
• Port diagnostics	Yes	Yes	Yes	Yes
• Statistics packet size	Yes	Yes	Yes	Yes
• Statistics packet type	Yes	Yes	Yes	Yes
• Error statistics	Yes	Yes	Yes	Yes
• SysLog	Yes	Yes	Yes	Yes
<b>Product functions VLAN</b>				
Product function				
• VLAN - port based	Yes	Yes	Yes	Yes
• VLAN dynamic	Yes	Yes	Yes	Yes
Number of VLANs maximum	255	255	255	255
Number of VLANs - dynamic maximum	255	255	255	255
Protocol is supported GVRP	Yes	Yes	Yes	Yes
<b>Product functions DHCP</b>				
Product function				
• DHCP client	Yes	Yes	Yes	Yes
• DHCP Option 82	Yes	Yes	Yes	Yes
• DHCP Option 66	Yes	Yes	Yes	Yes
• DHCP Option 67	Yes	Yes	Yes	Yes
<b>Product functions Redundancy</b>				
Product function				
• Ring redundancy	Yes	Yes	Yes	Yes
• Redundancy manager	Yes	Yes	Yes	Yes
• Standby redundancy	Yes	Yes	Yes	Yes
• High Speed Redundancy Protocol (HRP)	Yes	Yes	Yes	Yes
• Media Redundancy Protocol (MRP)	Yes	Yes	Yes	Yes
• redundancy procedure STP	Yes	Yes	Yes	Yes
• RSTP redundancy protocol	Yes	Yes	Yes	Yes
• redundancy procedure MSTP	Yes	Yes	Yes	Yes
• Passive listening	Yes	Yes	Yes	Yes
Protocol is supported				
• STP/RSTP	Yes	Yes	Yes	Yes
• STP	Yes	Yes	Yes	Yes
• RSTP	Yes	Yes	Yes	Yes
• RSTP big network support	Yes	Yes	Yes	Yes
• LACP	Yes	Yes	Yes	Yes

## PROFINET/Industrial Ethernet

### Industrial Ethernet Switches

#### SCALANCE XR-300EEC managed

#### Technical specifications (continued)

Article No.	6GK5324-4GG00-1ER2	6GK5324-4GG00-1JR2	6GK5324-4GG00-2ER2	6GK5324-4GG00-2JR2
Product-type designation	SCALANCE XR324-4M EEC	SCALANCE XR324-4M EEC	SCALANCE XR324-4M EEC	SCALANCE XR324-4M EEC
<b>Product functions Security</b>				
Product function				
• ACL - port/MAC-based	Yes	Yes	Yes	Yes
• IEEE 802.1x (radius)	Yes	Yes	Yes	Yes
• Broadcast/Multicast/Unicast Limiter	Yes	Yes	Yes	Yes
• broadcast blocking	Yes	Yes	Yes	Yes
Protocol is supported SSH	Yes	Yes	Yes	Yes
<b>Product functions Time</b>				
Product function SICLOCK support	Yes	Yes	Yes	Yes
Protocol is supported				
• NTP	Yes	Yes	Yes	Yes
• SNTP	Yes	Yes	Yes	Yes
• IEEE 1588 profile default	Yes	Yes	Yes	Yes
<b>Standards, specifications, approvals</b>				
Standard				
• for EMC	IEC 61850, IEEE 1613	IEC 61850, IEEE 1613	IEC 61850, IEEE 1613	IEC 61850, IEEE 1613
• for EMC from FM	FM3611: Class 1, Division 2, Group A, B, C, D / T4, Class 1, Zone 2, Group IIC, T4	FM3611: Class 1, Division 2, Group A, B, C, D / T4, Class 1, Zone 2, Group IIC, T4	FM3611: Class 1, Division 2, Group A, B, C, D / T4, Class 1, Zone 2, Group IIC, T4	FM3611: Class 1, Division 2, Group A, B, C, D / T4, Class 1, Zone 2, Group IIC, T4
• for hazardous zone	EN 60079-0 : 2006, EN 60079-15: 2005, II 3 G Ex nA II T4 KEMA 07 ATEX 0145X	EN 60079-0 : 2006, EN 60079-15: 2005, II 3 G Ex nA II T4 KEMA 07 ATEX 0145X	EN 60079-0 : 2006, EN 60079-15: 2005, II 3 G Ex nA II T4 KEMA 07 ATEX 0145X	EN 60079-0 : 2006, EN 60079-15: 2005, II 3 G Ex nA II T4 KEMA 07 ATEX 0145X
• for safety of CSA and UL	UL 60950-1, CSA C22.2 No. 60950-1-03	UL 60950-1, CSA C22.2 No. 60950-1-03	UL 60950-1, CSA C22.2 No. 60950-1-03	UL 60950-1, CSA C22.2 No. 60950-1-03
• for hazardous area of CSA and UL	ANSI / ISA 12.12.01, CSA C22.2 No. 142-M1987, CL. 1 / Div. 2 / GP. A, B, C, D T4, CL. 1 / Zone 2 / GP. IIC, T4	ANSI / ISA 12.12.01, CSA C22.2 No. 142-M1987, CL. 1 / Div. 2 / GP. A, B, C, D T4, CL. 1 / Zone 2 / GP. IIC, T4	ANSI / ISA 12.12.01, CSA C22.2 No. 142-M1987, CL. 1 / Div. 2 / GP. A, B, C, D T4, CL. 1 / Zone 2 / GP. IIC, T4	ANSI / ISA 12.12.01, CSA C22.2 No. 142-M1987, CL. 1 / Div. 2 / GP. A, B, C, D T4, CL. 1 / Zone 2 / GP. IIC, T4
• for emitted interference	EN 61000-6-4:2007 (Class A)	EN 61000-6-4:2007 (Class A)	EN 61000-6-4:2007 (Class A)	EN 61000-6-4:2007 (Class A)
• for interference immunity	EN 61000-6-2:2005	EN 61000-6-2:2005	EN 61000-6-2:2005	EN 61000-6-2:2005
Verification of suitability	EN 61000-6-2:2005, EN 61000-6-4:2007	EN 61000-6-2:2005, EN 61000-6-4:2007	EN 61000-6-2:2005, EN 61000-6-4:2007	EN 61000-6-2:2005, EN 61000-6-4:2007
• CE mark	Yes	Yes	Yes	Yes
• C-Tick	Yes	Yes	Yes	Yes
• KC approval	Yes	Yes	Yes	Yes
• IEC 61850-3	Yes	Yes	Yes	Yes

**Technical specifications (continued)**

Article No.	6GK5324-4GG00-3ER2	6GK5324-4GG00-3JR2	6GK5324-4GG00-4ER2	6GK5324-4GG00-4JR2
Product-type designation	SCALANCE XR324-4M EEC	SCALANCE XR324-4M EEC	SCALANCE XR324-4M EEC	SCALANCE XR324-4M EEC
<b>Transmission rate</b>				
Transfer rate 1	10 Mbit/s	10 Mbit/s	10 Mbit/s	10 Mbit/s
Transfer rate 2	100 Mbit/s	100 Mbit/s	100 Mbit/s	100 Mbit/s
Transfer rate 3	1 000 Mbit/s	1 000 Mbit/s	1 000 Mbit/s	1 000 Mbit/s
<b>Interfaces</b>				
Number of electrical/optical connections for network components or terminal equipment maximum	24	24	24	24
Number of electrical connections				
• for network components and terminal equipment	16	16	16	16
• for operator console	1	1	1	1
• for signaling contact	1	1	1	1
• for media module	4	4	4	4
• for power supply	1	1	2	2
• for redundant power supply	0	0	0	0
Design of electrical connection				
• for network components and terminal equipment	RJ45 port	RJ45 port	RJ45 port	RJ45 port
• for operator console	RJ11 port	RJ11 port	RJ11 port	RJ11 port
• for signaling contact	3-pole terminal block	3-pole terminal block	2 x 3-pole terminal block	2 x 3-pole terminal block
• for power supply	3-pole terminal block	3-pole terminal block	2 x 3-pole terminal block	2 x 3-pole terminal block
Design of optical interface for optical waveguide				
• at 100 Mbit/s	Dependent on selected media modules	Dependent on selected media modules	Dependent on selected media modules	Dependent on selected media modules
• at 1 000 Mbit/s	Dependent on selected media modules	Dependent on selected media modules	Dependent on selected media modules	Dependent on selected media modules
design of the removable storage C-PLUG	Yes	Yes	Yes	Yes
<b>Signal-Inputs/outputs</b>				
Operating voltage of signaling contacts at AC rated value	276 V	276 V	276 V	276 V
Operating current of signaling contacts at AC maximum	5 A	5 A	5 A	5 A
Operating voltage of signaling contacts at DC rated value	230 V	230 V	230 V	230 V
Operating current of signaling contacts at DC maximum	0.1 A	0.1 A	0.1 A	0.1 A
<b>Supply voltage, current consumption, power loss</b>				
Type of supply voltage redundant power supply unit	No	No	Yes	Yes
Type of supply voltage	AC	AC	AC	AC
Supply voltage at AC	230 V	230 V	230 V	230 V
• rated value	80 ... 276 V	80 ... 276 V	80 ... 276 V	80 ... 276 V
Type 2 of supply voltage	DC	DC	DC	DC
Supply voltage for DC	220 V	220 V	220 V	220 V
• rated value	48 ... 300 V	48 ... 300 V	48 ... 300 V	48 ... 300 V
Product component fusing at power supply input	Yes	Yes	Yes	Yes
Type of fusing at input for supply voltage				
Consumed current maximum	0.7 A	0.7 A	0.7 A	0.7 A
Active power loss				
• at 230 V AC	42 W	42 W	42 W	42 W
• at 250 V with DC	42 W	42 W	42 W	42 W

## PROFINET/Industrial Ethernet

### Industrial Ethernet Switches

#### SCALANCE XR-300EEC managed

#### Technical specifications (continued)

Article No.	6GK5324-4GG00-3ER2	6GK5324-4GG00-3JR2	6GK5324-4GG00-4ER2	6GK5324-4GG00-4JR2
Product-type designation	SCALANCE XR324-4M EEC	SCALANCE XR324-4M EEC	SCALANCE XR324-4M EEC	SCALANCE XR324-4M EEC
<b>Permitted ambient conditions</b>				
Ambient temperature				
• during operating	-40 ... +70 °C	-40 ... +70 °C	-40 ... +70 °C	-40 ... +70 °C
• during storage	-40 ... +85 °C	-40 ... +85 °C	-40 ... +85 °C	-40 ... +85 °C
• during transport	-40 ... +85 °C	-40 ... +85 °C	-40 ... +85 °C	-40 ... +85 °C
• Comment	Extended temperature upper limit of +85° C permitted for 16 hours. Reduced operating temperature through the use of media modules (-40 °C to +70 °C) or SFP plug-in transceivers (-40 °C to +60 °C)	Extended temperature upper limit of +85° C permitted for 16 hours. Reduced operating temperature through the use of media modules (-40 °C to +70 °C) or SFP plug-in transceivers (-40 °C to +60 °C)	Extended temperature upper limit of +85° C permitted for 16 hours. Reduced operating temperature through the use of media modules (-40 °C to +70 °C) or SFP plug-in transceivers (-40 °C to +60 °C)	Extended temperature upper limit of +85° C permitted for 16 hours. Reduced operating temperature through the use of media modules (-40 °C to +70 °C) or SFP plug-in transceivers (-40 °C to +60 °C)
Relative humidity at 25 °C without condensation during operating maximum	95 %	95 %	95 %	95 %
Protection class IP	IP20	IP20	IP20	IP20
<b>Design, dimensions and weight</b>				
Design	19" rack	19" rack	19" rack	19" rack
Width	483 mm	483 mm	483 mm	483 mm
Height	44 mm	44 mm	44 mm	44 mm
Depth	305 mm	305 mm	305 mm	305 mm
Net weight	6.6 kg	6.6 kg	7 kg	7 kg
Mounting type				
• 19-inch installation	Yes	Yes	Yes	Yes
• 35 mm DIN rail mounting	No	No	No	No
• wall mounting	No	No	No	No
• S7-300 rail mounting	No	No	No	No
Mounting type	When used in shipbuilding, the device must be secured in the 19" rack at four points	When used in shipbuilding, the device must be secured in the 19" rack at four points	When used in shipbuilding, the device must be secured in the 19" rack at four points	When used in shipbuilding, the device must be secured in the 19" rack at four points
<b>Product properties, functions, components general</b>				
Cascading in the case of a redundant ring at reconfiguration time of < 0.3 s	50	50	50	50
Cascading in cases of star structuring	Any (depending only on signal propagation time)	Any (depending only on signal propagation time)	Any (depending only on signal propagation time)	Any (depending only on signal propagation time)
<b>Product functions management, configuration</b>				
Product function				
• CLI	Yes	Yes	Yes	Yes
• web-based management	Yes	Yes	Yes	Yes
• MIB support	Yes	Yes	Yes	Yes
• TRAPs via email	Yes	Yes	Yes	Yes
• Configuration with STEP 7	Yes	Yes	Yes	Yes
• RMON	Yes	Yes	Yes	Yes
• SMTP server	-	-	-	-
• Port mirroring	Yes	Yes	Yes	Yes
• CoS	Yes	Yes	Yes	Yes
• for IRT PROFINET IO switch	-	-	-	-
• PROFINET IO diagnosis	Yes	Yes	Yes	Yes
• switch-managed	Yes	Yes	Yes	Yes

**Technical specifications (continued)**

Article No.	6GK5324-4GG00-3ER2	6GK5324-4GG00-3JR2	6GK5324-4GG00-4ER2	6GK5324-4GG00-4JR2
Product-type designation	SCALANCE XR324-4M EEC	SCALANCE XR324-4M EEC	SCALANCE XR324-4M EEC	SCALANCE XR324-4M EEC
Protocol is supported				
• Telnet	Yes	Yes	Yes	Yes
• HTTP	Yes	Yes	Yes	Yes
• HTTPS	Yes	Yes	Yes	Yes
• TFTP	Yes	Yes	Yes	Yes
• FTP	Yes	Yes	Yes	Yes
• BOOTP	Yes	Yes	Yes	Yes
• SNMP v1	Yes	Yes	Yes	Yes
• SNMP v2	Yes	Yes	Yes	Yes
• SNMP v3	Yes	Yes	Yes	Yes
• IGMP (snooping/querier)	Yes	Yes	Yes	Yes
• GMRP	Yes	Yes	Yes	Yes
• DCP	Yes	Yes	Yes	Yes
• LLDP	Yes	Yes	Yes	Yes
Identification & maintenance function				
• I&M0 - device-specific information	Yes	Yes	Yes	Yes
• I&M1 - higher level designation/location designation	Yes	Yes	Yes	Yes
<b>Product functions Diagnosis</b>				
Product function				
• Port diagnostics	Yes	Yes	Yes	Yes
• Statistics packet size	Yes	Yes	Yes	Yes
• Statistics packet type	Yes	Yes	Yes	Yes
• Error statistics	Yes	Yes	Yes	Yes
• SysLog	Yes	Yes	Yes	Yes
<b>Product functions VLAN</b>				
Product function				
• VLAN - port based	Yes	Yes	Yes	Yes
• VLAN dynamic	Yes	Yes	Yes	Yes
Number of VLANs maximum	255	255	255	255
Number of VLANs - dynamic maximum	255	255	255	255
Protocol is supported GVRP	Yes	Yes	Yes	Yes
<b>Product functions DHCP</b>				
Product function				
• DHCP client	Yes	Yes	Yes	Yes
• DHCP Option 82	Yes	Yes	Yes	Yes
• DHCP Option 66	Yes	Yes	Yes	Yes
• DHCP Option 67	Yes	Yes	Yes	Yes
<b>Product functions Redundancy</b>				
Product function				
• Ring redundancy	Yes	Yes	Yes	Yes
• Redundancy manager	Yes	Yes	Yes	Yes
• Standby redundancy	Yes	Yes	Yes	Yes
• High Speed Redundancy Protocol (HRP)	Yes	Yes	Yes	Yes
• Media Redundancy Protocol (MRP)	Yes	Yes	Yes	Yes
• Redundancy procedure STP	Yes	Yes	Yes	Yes
• RSTP redundancy protocol	Yes	Yes	Yes	Yes
• Redundancy procedure MSTP	Yes	Yes	Yes	Yes
• Passive listening	Yes	Yes	Yes	Yes
Protocol is supported				
• STP/RSTP	Yes	Yes	Yes	Yes
• STP	Yes	Yes	Yes	Yes
• RSTP	Yes	Yes	Yes	Yes
• RSTP big network support	Yes	Yes	Yes	Yes
• LACP	Yes	Yes	Yes	Yes

## PROFINET/Industrial Ethernet

### Industrial Ethernet Switches

#### SCALANCE XR-300EEC managed

#### Technical specifications (continued)

Article No.	6GK5324-4GG00-3ER2	6GK5324-4GG00-3JR2	6GK5324-4GG00-4ER2	6GK5324-4GG00-4JR2
Product-type designation	SCALANCE XR324-4M EEC	SCALANCE XR324-4M EEC	SCALANCE XR324-4M EEC	SCALANCE XR324-4M EEC
<b>Product functions Security</b>				
Product function				
• ACL - port/MAC-based	Yes	Yes	Yes	Yes
• IEEE 802.1x (radius)	Yes	Yes	Yes	Yes
• Broadcast/Multicast/Unicast Limiter	Yes	Yes	Yes	Yes
• Broadcast blocking	Yes	Yes	Yes	Yes
Protocol is supported SSH	Yes	Yes	Yes	Yes
<b>Product functions Time</b>				
Product function SICLOCK support	Yes	Yes	Yes	Yes
Protocol is supported				
• NTP	Yes	Yes	Yes	Yes
• SNTP	Yes	Yes	Yes	Yes
• MSTP	Yes	Yes	Yes	Yes
• IEEE 1588 profile default	Yes	Yes	Yes	Yes
<b>Standards, specifications, approvals</b>				
Standard				
• for EMC	IEC 61850, IEEE 1613	IEC 61850, IEEE 1613	IEC 61850, IEEE 1613	IEC 61850, IEEE 1613
• for EMC from FM	No	No	No	No
• for hazardous zone	No	No	No	No
• for safety of CSA and UL	UL 508, CSA C22.2 No. 142-M1987	UL 508, CSA C22.2 No. 142-M1987	UL 508, CSA C22.2 No. 142-M1987	UL 508, CSA C22.2 No. 142-M1987
• for hazardous area of CSA and UL	No	No	No	No
• for emitted interference	EN 61000-6-4:2007 (Class A)	EN 61000-6-4:2007 (Class A)	EN 61000-6-4:2007 (Class A)	EN 61000-6-4:2007 (Class A)
• for interference immunity	EN 61000-6-2:2005	EN 61000-6-2:2005	EN 61000-6-2:2005	EN 61000-6-2:2005
Verification of suitability	EN 61000-6-2:2005, EN 61000-6-4:2007	EN 61000-6-2:2005, EN 61000-6-4:2007	EN 61000-6-2:2005, EN 61000-6-4:2007	EN 61000-6-2:2005, EN 61000-6-4:2007
• CE mark	Yes	Yes	Yes	Yes
• C-Tick	Yes	Yes	Yes	Yes
• KC approval	Yes	Yes	Yes	Yes
• IEC 61850-3	Yes	Yes	Yes	Yes



**Ordering data**
**Article No.**
**Industrial Ethernet Switches SCALANCE XR324-4M EEC**

Partially modular 19" Industrial Ethernet switches for establishing electrical and optical Industrial Ethernet networks; all ports can be optionally equipped with optical or electrical 2-port media modules); All ports support Gigabit Ethernet (blocking), integrated redundancy manager, RSTP, RMON, IGMP snooping querier, network management via SNMP, PROFINET and Web server  
 16 x 10/100/1 000 Mbit/s RJ45 ports, electrical  
 4 x 10/100/1 000 Mbit/s slots for 2-port media modules, electrical or optical

**SCALANCE XR324-4M EEC**
Power supply 1 x 24 V DC

- Front data cable outlet, rear power supply
- Rear data cable outlet, front power supply

**6GK5324-4GG00-1ER2**
**6GK5324-4GG00-1JR2**
Power supply
1 x 100-240 AC / 60-250 V DC

- Front data cable outlet, rear power supply
- Rear data cable outlet, front power supply

**6GK5324-4GG00-3ER2**
**6GK5324-4GG00-3JR2**
Power supply 2 x 24 V DC

- Front data cable outlet, rear power supply
- Rear data cable outlet, front power supply

**6GK5324-4GG00-2ER2**
**6GK5324-4GG00-2JR2**
Power supply
2 x 100-240 AC / 60-250 V DC

- Front data cable outlet, rear power supply
- Rear data cable outlet, front power supply

**6GK5324-4GG00-4ER2**
**6GK5324-4GG00-4JR2**
**Media modules**

See "Media modules for modular SCALANCE X-300 managed"

**SIPLUS PS modular 5 A**
**6EP1933-3BA00**

1-phase and 2-phase power supply with wide-range input  
 85 ... 264 V / 176 V ... 550 V AC,  
 regulated output voltage 24 V,  
 output current rated value 5 A,  
 coating of the PCB and electronic components (conformal coating)

**More information**
**Selection tool:**

To assist in selecting the right Industrial Ethernet switches as well as configuration of modular variants, the SIMATIC NET Selection Tool and the TIA Selection Tool are available at:

SIMATIC NET Selection Tool:

- Online version:  
<http://www.siemens.com/snst>
- Offline version:  
<http://www.siemens.com/snst-download>

TIA Selection Tool:

<http://www.siemens.com/tia-selection-tool>

## PROFINET/Industrial Ethernet

### Industrial Ethernet Switches

#### Media modules for modular SCALANCE X-300 managed

##### Overview

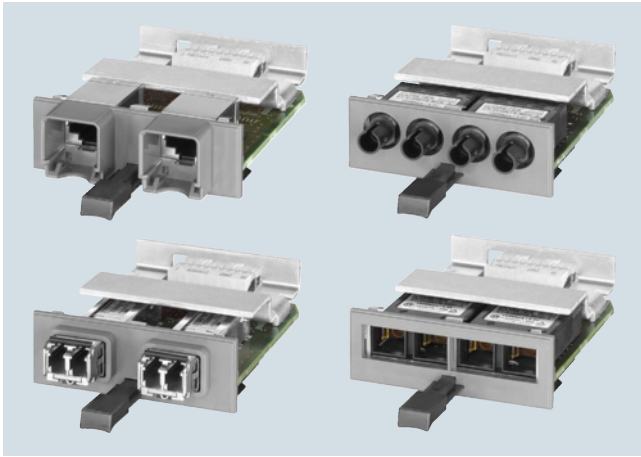

- 2-port media modules for flexible, 2-port-granular equipping of partly and fully modular versions of SCALANCE X-300 switches (e.g. SCALANCE X308-2M, SCALANCE XR324-12M) as well as the SCALANCE S627-2M
- Electrical versions with RJ45 ports are available as well as optical versions with BFOC and SC ports for the use of multimode and singlemode fiber-optic cables
- A 2-port SFP media module permits the optional use of fiber-optic SFP plug-in transceivers (**S**mall **F**orm-Factor **P**luggable) with LC connection technology. Versions with coated PCBs (conformal coating) for railway applications are also available.

##### Benefits

get **Designed for Industry**

- Unlimited flexibility in the case of network expansions (e.g. more terminals) or conversion (e.g. from copper to fiber-optic cables) due to modular design with media modules
- Reduction of storage costs and maintenance overhead by focusing on a few basic device versions

##### Application

The use of media modules in partly and fully modular versions of the SCALANCE X-300 switches or selected SCALANCE S devices supports:

- Extension of networks by subsequent insertion of additional media modules in unused media module slots
- Changing of the cabling technology (e.g. conversion from copper to fiber-optic cables, or from multi-mode to single-mode FOC)
- Bridging of longer cable runs or use of existing 2-wire cables (variable distance)

Media module MM992-2VD (in VD mode)		
IE FC TP Standard Cable GP 4x2 (AWG24) with IE FC RJ45 plug 4x2		0 ... 500 m at 100 Mbit/s
Standard IE FC TP cable GP 2x2 (AWG22/1) with IE FC RJ45 plug 2x2		0 ... 300 m at 100 Mbit/s
IE FC TP Standard Cable 2x2 (AWG22/1) with IE FC RJ45 plug 2x2		300 ... 500 m at 10 Mbit/s
PROFIBUS FC Standard Cable GP with IE FC RJ45 plug 4x2		100 ... 1 000 m at 10 Mbit/s
PROFIBUS FC Standard Cable GP with IE FC RJ45 plug 4x2		0 ... 100 m at 100 Mbit/s

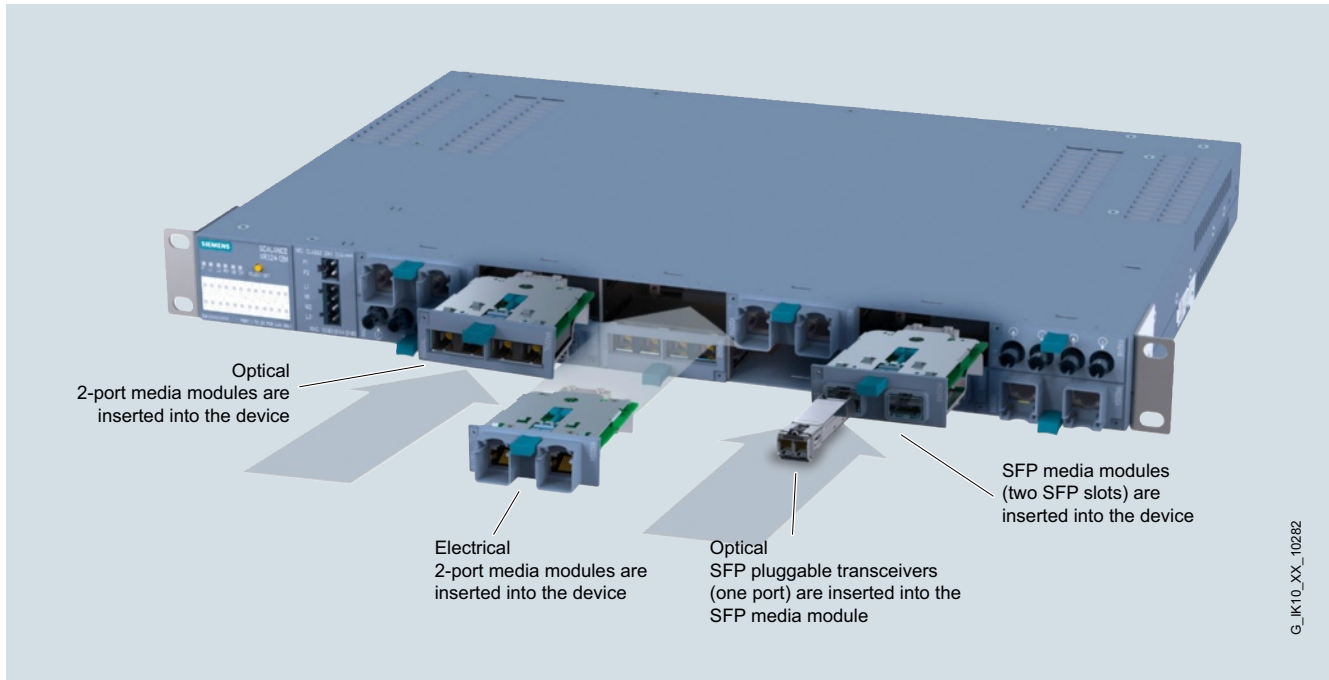
**Design**

Insertion of 2-port media modules in media module slot

**Product versions of media modules**
**Electrical media modules with  
2 x 10/100/1 000 Mbit/s RJ45 ports**

- MM992-2CUC with retaining sleeve
- MM992-2CUC with retaining sleeve and coated PCBs (conformal coating)
- MM992-2CU without retaining sleeve

**Electrical media modules with  
2 x 1/10/100/1 000 Mbit/s RJ45 ports**

- MM992-2VD with retaining collar and additional two-wire transmission function (variable distance) for establishing Ethernet connections via non-Ethernet conformant cables as well. Bridgeable distance, depending on the quality of the cable

**Electrical media modules with  
2 x 10/100/ 1 000 Mbit/s M12 ports**

- MM992-2 with M12 interface (x-coded) and coated PCBs

**Optical media modules with  
2 x 100 Mbit/s BFOC ports**

- MM991-2 multimode, glass, up to 5 km
- MM991-2LD singlemode, glass, up to 26 km

**Optical media modules with  
2 x 100 Mbit/s SC ports**

- MM991-2 multimode, glass, up to 5 km
- MM991-2LD singlemode, glass, up to 26 km
- MM991-2LH+ singlemode, glass, up to 70 km

**Optical media modules with  
2 x 1 000 Mbit/s SC ports**

- MM992-2 multimode, glass, up to 750 m
- MM992-2 multimode, glass, up to 750 m, coated PCBs (conformal coating)
- MM992-2LD singlemode, glass, up to 10 km
- MM992-2LH singlemode, glass, up to 40 km
- MM992-2LH+ singlemode, glass, up to 70 km
- MM992-2ELH singlemode, glass, up to 120 km

**Optical media modules with  
2 x 100/1 000 Mbit/s for SFP pluggable transceiver**

- MM992-2SFP for SFP plug-in transceivers with 1 x 100 Mbit/s or 1 x 1 000 Mbit/s multi-mode or single-mode, glass

## PROFINET/Industrial Ethernet

### Industrial Ethernet Switches

#### Media modules for modular SCALANCE X-300 managed

#### Design (continued)

##### Product versions of SFP pluggable transceivers

The SFP plug-in transceivers (**S**mall **F**orm-factor **P**luggable) can only be used together with the SFP media module MM992-2SFP.

##### Optical SFP pluggable transceivers with 1 x 100 Mbit/s LC port

- SFP991-1  
multimode, glass, up to 5 km
- SFP991-1LD  
singlemode, glass, up to 26 km
- SFP991-1LH+  
singlemode, glass, up to 70 km
- SFP991-1ELH200  
singlemode, glass, up to 200 km

##### Optical SFP pluggable transceivers with 1 x 1 000 Mbit/s LC port

- SFP992-1  
multimode, glass, up to 750 m
- SFP992-1LD  
singlemode, glass, up to 10 km
- SFP992-1LH  
singlemode, glass, up to 40 km
- SFP992-1LH+  
singlemode, glass, up to 70 km
- SFP992-1ELH  
singlemode, glass, up to 120 km

Type of module	Type and quantity of ports					Max. distance
	Gigabit Ethernet			Fast Ethernet		
	10 / 100 / 1000 Mbit/s	1000 Mbit/s		100 Mbit/s		
	Electrical	Optical		Optical		
Type of module	Twisted Pair	Multimode	Singlemode	Multimode	Singlemode	
<b>Media modules</b>						
MM992-2CUC	2x RJ45 <sup>1)</sup>					100 m
MM992-2CUC (C)	2x RJ45 <sup>1)</sup>					100 m
MM992-2CU	2x RJ45					100 m
MM992-2M12 (C)	2x M12 <sup>4)</sup>					100 m
MM992-2VD	2x RJ45					depending on cable *
MM991-2				2x BFOC		5 km
MM991-2LD					2x BFOC	26 km
MM991-2				2x SC		5 km
MM991-2LD					2x SC	26 km
MM991-2LH+					2x SC	70 km
MM992-2		2x SC				750 m
MM992-2 (C)		2x SC				750 m
MM992-2LD			2x SC			10 km
MM992-2LH			2x SC			40 km
MM992-2LH+			2x SC			70 km
MM992-2ELH			2x SC			120 km
MM992-2SFP		2x LC <sup>2)</sup>	2x LC <sup>2)</sup>	2x LC <sup>2)</sup>	2x LC <sup>2)</sup>	
<b>SFP modules <sup>3)</sup></b>						
SFP991-1				1x LC		5 km
SFP991-1LD					1x LC	26 km
SFP991-1LH+					1x LC	70 km
SFP991-1ELH200					1x LC	200 km
SFP992-1		1x LC				750 m
SFP992-1LD			1x LC			10 km
SFP992-1LH			1x LC			40 km
SFP992-1LH+			1x LC			70 km
SFP992-1ELH			1x LC			120 km
1) with retaining collars 2) The MM392-2SFP SFP slot module can accommodate up to two 1-port SFP modules 3) Can only be plugged into an MM392-2SFP slot module 4) M12 X-coded (C) Conformal Coating * see media modules manual						

Overview of media modules for SCALANCE X-300

G\_IK10\_XX\_10277

### Integration

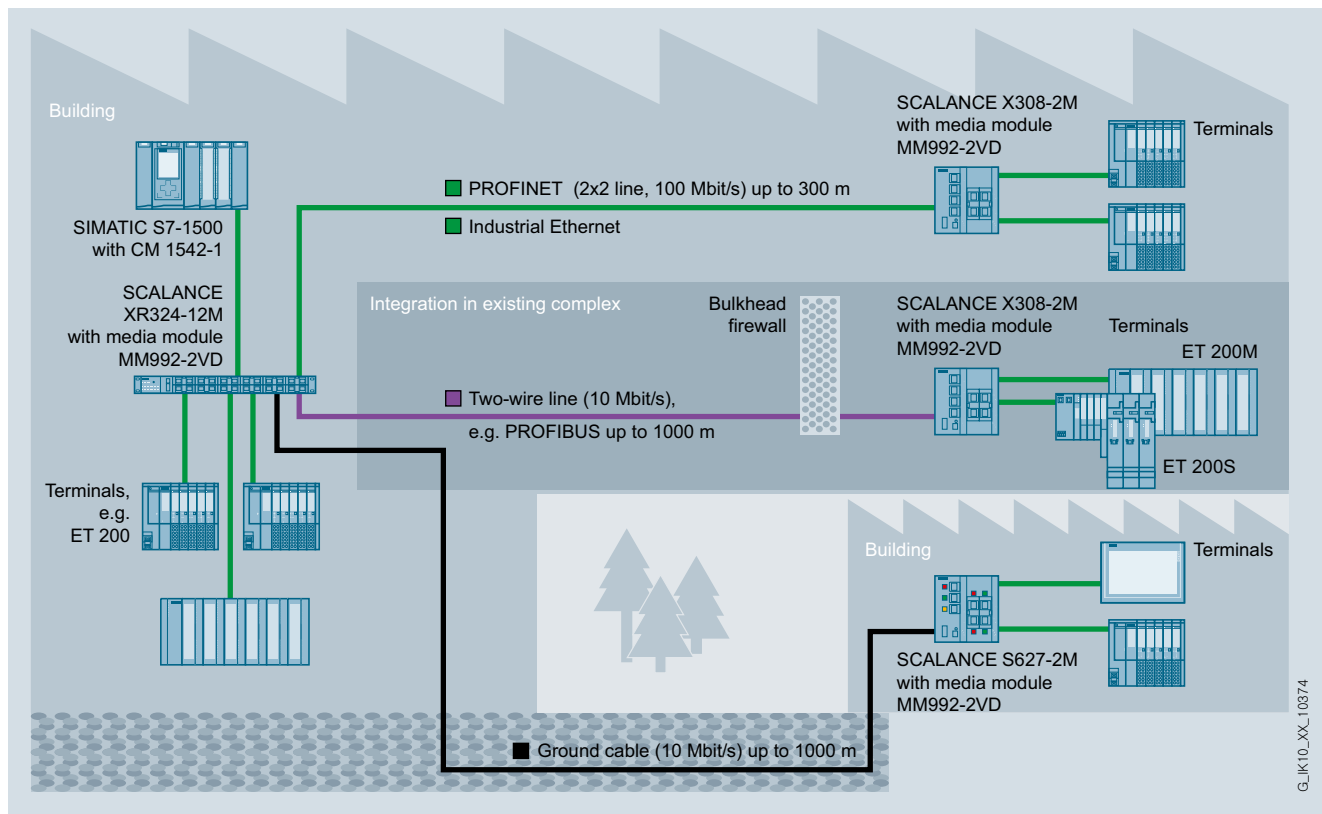

Ethernet communication with MM992-2VD media module

## PROFINET/Industrial Ethernet

### Industrial Ethernet Switches

#### Media modules for modular SCALANCE X-300 managed

#### Technical specifications

Article No.	6GK5992-2GA00-8AA0	6GK5992-2GA00-8FA0	6GK5992-2SA00-8AA0
Product-type designation	MM992-2CUC	MM992-2CUC	MM992-2CU
<b>Interfaces</b>			
Number of electrical/optical connections for network components or terminal equipment maximum	2	2	2
Number of 10/100/1 000 Mbit/s RJ45 ports	2	2	2
Design of electrical connection			
• for network components and terminal equipment	RJ45	RJ45	RJ45
<b>Permitted ambient conditions</b>			
Ambient temperature			
• during operating	-40 ... +70 °C	-40 ... +70 °C	-40 ... +70 °C
• during storage	-40 ... +70 °C	-40 ... +70 °C	-40 ... +70 °C
• during transport	-40 ... +70 °C	-40 ... +70 °C	-40 ... +70 °C
Relative humidity at 25 °C without condensation during operating maximum	95 %	95 %	95 %
Ambient condition for (standard) operation mode	-	Conformal coating, yes	-
Protection class IP	IP20	IP20	IP20
<b>Design, dimensions and weight</b>			
Design	Media module with retaining collar	Media module with retaining collar	Media module
Width	60 mm	60 mm	60 mm
Height	22 mm	22 mm	22 mm
Depth	100 mm	100 mm	100 mm
Net weight	0.08 kg	0.08 kg	0,08 kg
Mounting type Installation in media module slot	Yes	Yes	Yes
Mounting type	Latched	Latched	Latched
<b>Standards, specifications, approvals</b>			
Standard			
• for EMC from FM	FM3611: Class 1, Division 2, Group A, B, C, D / T4, Class 1, Zone 2, Group IIC, T4	FM3611: Class 1, Division 2, Group A, B, C, D / T4, Class 1, Zone 2, Group IIC, T4	FM3611: Class 1, Division 2, Group A, B, C, D / T4, Class 1, Zone 2, Group IIC, T4
• for hazardous zone	EN 60079-0: 2006, EN 60079-15: 2005, II 3 G Ex nA II T4, KEMA 07 ATEX 0145 X	EN 60079-0: 2006, EN 60079-15: 2005, II 3 G Ex nA II T4, KEMA 07 ATEX 0145 X	EN 60079-0: 2006, EN 60079-15: 2005, II 3 G Ex nA II T4, KEMA 07 ATEX 0145 X
• for safety of CSA and UL	UL 60950-1, CSA C22.2 No. 60950-1	UL 60950-1, CSA C22.2 No. 60950-1	UL 60950-1, CSA C22.2 No. 60950-1
• for hazardous area of CSA and UL	UL 1604 and UL 2279-15 (Hazardous Location), CSA C22.2 No. 213-M1987, Class 1 / Division 2 / Group A, B, C, D / T4, Class 1 / Zone 2 / Group IIC / T4	UL 1604 and UL 2279-15 (Hazardous Location), CSA C22.2 No. 213-M1987, Class 1 / Division 2 / Group A, B, C, D / T4, Class 1 / Zone 2 / Group IIC / T4	UL 1604 and UL 2279-15 (Hazardous Location), CSA C22.2 No. 213-M1987, Class 1 / Division 2 / Group A, B, C, D / T4, Class 1 / Zone 2 / Group IIC / T4
• for emitted interference	EN 61000-6-4:2007 (Class A)	EN 61000-6-4:2007 (Class A)	EN 61000-6-4:2007 (Class A)
• for interference immunity	EN 61000-6-2:2005	EN 61000-6-2:2005	EN 61000-6-2:2005
Verification of suitability	EN 61000-6-2:2005, EN 61000-6-4:2007	EN 61000-6-2:2005, EN 61000-6-4:2007	EN 61000-6-2:2005, EN 61000-6-4:2007
• CE mark	Yes	Yes	Yes
• C-Tick	Yes	Yes	Yes
• KC approval	Yes	Yes	Yes

**Technical specifications** (continued)

Article No.	6GK5992-2HA00-0AA0	6GK5992-2VA00-8AA0
Product-type designation	MM992-2 M12 GIGA	MM992-2VD (RJ45)
<b>Interfaces</b>		
Number of electrical/optical connections for network components or terminal equipment maximum	2	2
Number of 10/100/1 000 Mbit/s M12 ports	2	-
Number of 10/100/1 000 Mbit/s RJ45 ports	-	2
Design of electrical connection • for network components and terminal equipment	M12	RJ45
<b>Permitted ambient conditions</b>		
Ambient temperature • during operating • during storage • during transport	-40 ... +70 °C -40 ... +70 °C -40 ... +70 °C	-40 ... +70 °C -40 ... +70 °C -40 ... +70 °C
Relative humidity at 25 °C without condensation during operating maximum	95 %	95 %
Ambient condition for (standard) operation mode	Conformal coating, yes	-
Protection class IP	IP20	IP20
<b>Design, dimensions and weight</b>		
Design	Media module	Media module with retaining collar
Width	60 mm	60 mm
Height	22 mm	22 mm
Depth	100 mm	100 mm
Net weight	0.08 kg	0.08 kg
Mounting type Installation in media module slot	Yes	Yes
Mounting type	Latched	Latched
<b>Standards, specifications, approvals</b>		
Standard • for EMC from FM	-	FM3611: Class 1, Division 2, Group A, B, C, D / T4, Class 1, Zone 2, Group IIC, T4
• for hazardous zone	-	EN 60079-0: 2006, EN 60079-15: 2005, II 3 G Ex nA II T4, KEMA 07 ATEX 0145 X
• for safety of CSA and UL	-	UL 60950-1, CSA C22.2 No. 60950-1
• for hazardous area of CSA and UL	-	UL 1604 and UL 2279-15 (Hazardous Location), CSA C22.2 No. 213-M1987, Class 1 / Division 2 / Group A, B, C, D / T4, Class 1 / Zone 2 / Group IIC / T4
• for emitted interference	-	EN 61000-6-4:2007 (Class A)
• for interference immunity	-	EN 61000-6-2:2005
Verification of suitability	-	EN 61000-6-2:2005, EN 61000-6-4:2007
• CE mark	Yes	Yes
• C-Tick	Yes	Yes
• KC approval	Yes	Yes
• Railway application in accordance with EN 50155	Yes	-

## PROFINET/Industrial Ethernet

### Industrial Ethernet Switches

#### Media modules for modular SCALANCE X-300 managed

#### Technical specifications (continued)

Article No.	6GK5991-2AB00-8AA0	6GK5991-2AC00-8AA0
Product-type designation	MM991-2 (BFOC)	MM991-2LD (BFOC)
<b>Interfaces</b>		
Number of electrical/optical connections for network components or terminal equipment maximum	2	2
Number of 100 Mbit/s ST(BFOC) ports	2	2
Design of optical connections for network components or terminal devices	BFOC	BFOC
Connectable optical power relative to 1 mW		
• of the transmitter output	-19 ... -14 dB	-15 ... -8 dB
• of the receiver input maximum	-3 dB	-3 dB
Optical sensitivity relative to 1 mW of the receiver input minimum	-32 dB	-34 dB
Attenuation of fiber-optic cable transmission link minimum necessary	0 dB	0 dB
Range at the optical interface depending on the optical fiber used	0 ... 5 km	0 ... 26 km
<b>Permitted ambient conditions</b>		
Ambient temperature		
• during operating	-40 ... +70 °C	-40 ... +70 °C
• during storage	-40 ... +70 °C	-40 ... +70 °C
• during transport	-40 ... +70 °C	-40 ... +70 °C
Relative humidity at 25 °C without condensation during operating maximum	95 %	95 %
Protection class IP	IP20	IP20
<b>Design, dimensions and weight</b>		
Design	Media module	Media module
Width	60 mm	60 mm
Height	22 mm	22 mm
Depth	100 mm	100 mm
Net weight	0.08 kg	0.08 kg
Mounting type Installation in media module slot	Yes	Yes
Mounting type	Latched	Latched
<b>Standards, specifications, approvals</b>		
Standard		
• for EMC	-	-
• for EMC from FM	FM3611: Class 1, Division 2, Group A, B, C, D / T4, Class 1, Zone 2, Group IIC, T4	FM3611: Class 1, Division 2, Group A, B, C, D / T4, Class 1, Zone 2, Group IIC, T4
• for hazardous zone	EN 60079-0: 2006, EN 60079-15: 2005, II 3(2) G Ex nA [op is] IIC T4 DEKRA 11 ATEX 0060 X	EN 60079-0: 2006, EN 60079-15: 2005, II 3 G Ex nA II T4, KEMA 07 ATEX 0145 X
• for safety of CSA and UL	UL 60950-1, CSA C22.2 No. 60950-1	UL 60950-1, CSA C22.2 No. 60950-1
• for hazardous area of CSA and UL	UL 1604 and UL 2279-15 (Hazardous Location), CSA C22.2 No. 213-M1987, Class 1 / Division 2 / Group A, B, C, D / T4, Class 1 / Zone 2 / Group IIC / T4	UL 1604 and UL 2279-15 (Hazardous Location), CSA C22.2 No. 213-M1987, Class 1 / Division 2 / Group A, B, C, D / T4, Class 1 / Zone 2 / Group IIC / T4
• for emitted interference	EN 61000-6-4:2007 (Class A)	EN 61000-6-4:2007 (Class A)
• for interference immunity	EN 61000-6-2:2005	EN 61000-6-2:2005
Verification of suitability	EN 61000-6-2:2005, EN 61000-6-4:2007	EN 61000-6-2:2005, EN 61000-6-4:2007
• CE mark	Yes	Yes
• C-Tick	Yes	Yes
• KC approval	Yes	Yes



**Technical specifications (continued)**

Article No.	6GK5991-2AD00-8AA0	6GK5991-2AF00-8AA0	6GK5991-2AE00-8AA0
Product-type designation	MM991-2 (SC)	MM991-2LD (SC)	MM991-2LH+
<b>Interfaces</b>			
Number of electrical/optical connections for network components or terminal equipment maximum	2	2	2
Number of 100 Mbit/s SC ports	2	2	2
Design of optical connections for network components or terminal devices	SC	SC	SC
Connectable optical power relative to 1 mW			
• of the transmitter output	-19 ... -14 dB	-15 ... -8 dB	-5 ... +0 dB
• of the receiver input maximum	-3 dB	-3 dB	-3 dB
Optical sensitivity relative to 1 mW of the receiver input minimum	-34 dB	-32 dB	-34 dB
Attenuation of fiber-optic cable transmission link minimum necessary	0 dB	0 dB	3 dB
Range at the optical interface depending on the optical fiber used	0 ... 5 km	0 ... 26 km	12 ... 70 km
<b>Permitted ambient conditions</b>			
Ambient temperature			
• during operating	-40 ... +70 °C	-40 ... +70 °C	-40 ... +60 °C
• during storage	-40 ... +70 °C	-40 ... +70 °C	-40 ... +70 °C
• during transport	-40 ... +70 °C	-40 ... +70 °C	-40 ... +70 °C
Relative humidity at 25 °C without condensation during operating maximum	95 %	95 %	95 %
Protection class IP	IP20	IP20	IP20
<b>Design, dimensions and weight</b>			
Design	Media module	Media module	Media module
Width	60 mm	60 mm	60 mm
Height	22 mm	22 mm	22 mm
Depth	100 mm	100 mm	100 mm
Net weight	0.08 kg	0.08 kg	0.08 kg
Mounting type Installation in media module slot	Yes	Yes	Yes
Mounting type	Latched	Latched	Latched
<b>Standards, specifications, approvals</b>			
Standard	-	-	-
• for EMC			
• for EMC from FM	FM3611: Class 1, Division 2, Group A, B, C, D / T4, Class 1, Zone 2, Group IIC, T4	FM3611: Class 1, Division 2, Group A, B, C, D / T4, Class 1, Zone 2, Group IIC, T4	FM3611: Class 1, Division 2, Group A, B, C, D / T4, Class 1, Zone 2, Group IIC, T4
• for hazardous zone	EN 60079-0: 2006, EN 60079-15: 2005, II 3 G Ex nA II T4, KEMA 07 ATEX 0145 X	EN 60079-0: 2006, EN 60079-15: 2005, II 3 G Ex nA II T4, KEMA 07 ATEX 0145 X	EN 60079-0: 2006, EN 60079-15: 2005, II 3 G Ex nA II T4, KEMA 07 ATEX 0145 X
• for safety of CSA and UL	UL 60950-1, CSA C22.2 No. 60950-1	UL 60950-1, CSA C22.2 No. 60950-1	UL 60950-1, CSA C22.2 No. 60950-1
• for hazardous area of CSA and UL	UL 1604 and UL 2279-15 (Hazardous Location), CSA C22.2 No. 213-M1987, Class 1 / Division 2 / Group A, B, C, D / T4, Class 1 / Zone 2 / Group IIC / T4	UL 1604 and UL 2279-15 (Hazardous Location), CSA C22.2 No. 213-M1987, Class 1 / Division 2 / Group A, B, C, D / T4, Class 1 / Zone 2 / Group IIC / T4	UL 1604 and UL 2279-15 (Hazardous Location), CSA C22.2 No. 213-M1987, Class 1 / Division 2 / Group A, B, C, D / T4, Class 1 / Zone 2 / Group IIC / T4
• for emitted interference	EN 61000-6-4:2007 (Class A)	EN 61000-6-4:2007 (Class A)	EN 61000-6-4:2007 (Class A)
• for interference immunity	EN 61000-6-2:2005	EN 61000-6-2:2005	EN 61000-6-2:2005
Verification of suitability	EN 61000-6-2:2005, EN 61000-6-4:2007	EN 61000-6-2:2005, EN 61000-6-4:2007	EN 61000-6-2:2005, EN 61000-6-4:2007
• CE mark	Yes	Yes	Yes
• C-Tick	Yes	Yes	Yes
• KC approval	Yes	Yes	Yes

# PROFINET/Industrial Ethernet

## Industrial Ethernet Switches

### Media modules for modular SCALANCE X-300 managed

#### Technical specifications (continued)

Article No.	6GK5992-2AL00-8AA0	6GK5992-2AL00-8FA0	6GK5992-2AM00-8AA0	6GK5992-2AN00-8AA0
Product-type designation	MM992-2	MM992-2	MM992-2LD	MM992-2LH
<b>Interfaces</b>				
Number of electrical/optical connections for network components or terminal equipment maximum	2	2	2	2
Number of 1 000 Mbit/s SC ports (LX)	-	-	2	2
Number of 1 000 Mbit/s SC ports (SX)	2	2	-	-
Design of optical connections for network components or terminal devices	SC	SC	SC	SC
Connectable optical power relative to 1 mW				
• of the transmitter output	-9.5 ... -4 dB	-9.5 ... -4 dB	-9.5 ... -3 dB	-6 ... +0 dB
• of the receiver input maximum	-3 dB	-3 dB	-3 dB	-3 dB
Optical sensitivity relative to 1 mW of the receiver input minimum	-17 dB	-17 dB	-21 dB	-23 dB
Attenuation of fiber-optic cable transmission link minimum necessary	0 dB	0 dB	0 dB	3 dB
Range at the optical interface depending on the optical fiber used	0 ... 0.75 km	0 ... 0.75 km	0 ... 10 km	8 ... 40 km
<b>Permitted ambient conditions</b>				
Ambient temperature				
• during operating	-40 ... +70 °C	-40 ... +70 °C	-40 ... +70 °C	-40 ... +60 °C
• during storage	-40 ... +70 °C	-40 ... +70 °C	-40 ... +70 °C	-40 ... +70 °C
• during transport	-40 ... +70 °C	-40 ... +70 °C	-40 ... +70 °C	-40 ... +70 °C
Relative humidity at 25 °C without condensation during operating maximum	95 %	95 %	95 %	95 %
Ambient condition for (standard) operation mode	-	Conformal coating, yes	-	-
Protection class IP	IP20	IP20	IP20	IP20
<b>Design, dimensions and weight</b>				
Design	Media module	Media module	Media module	Media module
Width	60 mm	60 mm	60 mm	60 mm
Height	22 mm	22 mm	22 mm	22 mm
Depth	100 mm	100 mm	100 mm	100 mm
Net weight	0.08 kg	0.08 kg	0.08 kg	0.08 kg
Mounting type Installation in media module slot	Yes	Yes	Yes	Yes
Mounting type	Latched	Latched	Latched	Latched
<b>Standards, specifications, approvals</b>				
Standard				
• for EMC from FM	FM3611: Class 1, Division 2, Group A, B, C, D / T4, Class 1, Zone 2, Group IIC, T4	FM3611: Class 1, Division 2, Group A, B, C, D / T4, Class 1, Zone 2, Group IIC, T4	FM3611: Class 1, Division 2, Group A, B, C, D / T4, Class 1, Zone 2, Group IIC, T4	FM3611: Class 1, Division 2, Group A, B, C, D / T4, Class 1, Zone 2, Group IIC, T4
• for hazardous zone	EN 60079-0: 2006, EN 60079-15: 2005, II 3 G Ex nA II T4, KEMA 07 ATEX 0145 X	EN 60079-0: 2006, EN 60079-15: 2005, II 3 G Ex nA II T4, KEMA 07 ATEX 0145 X	EN 60079-0: 2006, EN 60079-15: 2005, II 3 G Ex nA II T4, KEMA 07 ATEX 0145 X	EN 60079-0: 2006, EN 60079-15: 2005, II 3 G Ex nA II T4, KEMA 07 ATEX 0145 X
• for safety of CSA and UL	UL 60950-1, CSA C22.2 No. 60950-1	UL 60950-1, CSA C22.2 No. 60950-1	UL 60950-1, CSA C22.2 No. 60950-1	UL 60950-1, CSA C22.2 No. 60950-1
• for hazardous area of CSA and UL	UL 1604 and UL 2279-15 (Hazardous Location), CSA C22.2 No. 213-M1987, Class 1 / Division 2 / Group A, B, C, D / T4, Class 1 / Zone 2 / Group IIC / T4	UL 1604 and UL 2279-15 (Hazardous Location), CSA C22.2 No. 213-M1987, Class 1 / Division 2 / Group A, B, C, D / T4, Class 1 / Zone 2 / Group IIC / T4	UL 1604 and UL 2279-15 (Hazardous Location), CSA C22.2 No. 213-M1987, Class 1 / Division 2 / Group A, B, C, D / T4, Class 1 / Zone 2 / Group IIC / T4	UL 1604 and UL 2279-15 (Hazardous Location), CSA C22.2 No. 213-M1987, Class 1 / Division 2 / Group A, B, C, D / T4, Class 1 / Zone 2 / Group IIC / T4
• for emitted interference	EN 61000-6-4:2007 (Class A)	EN 61000-6-4:2007 (Class A)	EN 61000-6-4:2007 (Class A)	EN 61000-6-4:2007 (Class A)
• for interference immunity	EN 61000-6-2:2005	EN 61000-6-2:2005	EN 61000-6-2:2005	EN 61000-6-2:2005
Verification of suitability	EN 61000-6-2:2005, EN 61000-6-4:2007	EN 61000-6-2:2005, EN 61000-6-4:2007	EN 61000-6-2:2005, EN 61000-6-4:2007	EN 61000-6-2:2005, EN 61000-6-4:2007
• CE mark	Yes	Yes	Yes	Yes
• C-Tick	Yes	Yes	Yes	Yes
• KC approval	Yes	Yes	Yes	Yes

**Technical specifications** (continued)

Article No.	6GK5992-2AP00-8AA0	6GK5992-2AQ00-8AA0	6GK5992-2AS00-8AA0
Product-type designation	MM992-2LH+	MM992-2ELH	MM992-2SFP
<b>Interfaces</b>			
Number of electrical/optical connections for network components or terminal equipment maximum	2	2	2
Number of electrical connections • for SFP+/SFP	-	-	2
Number of 1 000 Mbit/s SC ports (LX)	2	2	-
Design of optical connections for network components or terminal devices	SC	SC	-
Connectable optical power relative to 1 mW • of the transmitter output • of the receiver input maximum	0 ... 5 dB -3 dB	0 ... 5 dB -3 dB	- -
Optical sensitivity relative to 1 mW of the receiver input minimum	-23 dB	-30 dB	-
Attenuation of fiber-optic cable transmission link minimum necessary	8 dB	8 dB	-
Range at the optical interface depending on the optical fiber used	30 ... 70 km	37 ... 120 km	-
<b>Permitted ambient conditions</b>			
Ambient temperature • during operating • during storage • during transport	-40 ... +60 °C -40 ... +70 °C -40 ... +70 °C	-40 ... +60 °C -40 ... +70 °C -40 ... +70 °C	-40 ... +70 °C -40 ... +70 °C -40 ... +70 °C
Relative humidity at 25 °C without condensation during operating maximum	95 %	95 %	95 %
Protection class IP	IP20	IP20	IP20
<b>Design, dimensions and weight</b>			
Design	Media module	Media module	Media module
Width	60 mm	60 mm	60 mm
Height	22 mm	22 mm	22 mm
Depth	100 mm	100 mm	100 mm
Net weight	0.08 kg	0.08 kg	0.08 kg
Mounting type Installation in media module slot	Yes	Yes	Yes
Mounting type	Latched	Latched	Latched
<b>Standards, specifications, approvals</b>			
Standard • for EMC from FM	FM3611: Class 1, Division 2, Group A, B, C, D / T4, Class 1, Zone 2, Group IIC, T4	FM3611: Class 1, Division 2, Group A, B, C, D / T4, Class 1, Zone 2, Group IIC, T4	FM3611: Class 1, Division 2, Group A, B, C, D / T4, Class 1, Zone 2, Group IIC, T4
• for hazardous zone	EN 60079-0: 2006, EN 60079-15: 2005, II 3 G Ex nA II T4, KEMA 07 ATEX 0145 X	EN 60079-0: 2006, EN 60079-15: 2005, II 3 G Ex nA II T4, KEMA 07 ATEX 0145 X	EN 60079-0: 2006, EN 60079-15: 2005, II 3 G Ex nA II T4, KEMA 07 ATEX 0145 X
• for safety of CSA and UL • for hazardous area of CSA and UL	UL 60950-1, CSA C22.2 No. 60950-1 UL 1604 and UL 2279-15 (Hazardous Location), CSA C22.2 No. 213-M1987, Class 1 / Division 2 / Group A, B, C, D / T4, Class 1 / Zone 2 / Group IIC / T4	UL 60950-1, CSA C22.2 No. 60950-1 UL 1604 and UL 2279-15 (Hazardous Location), CSA C22.2 No. 213-M1987, Class 1 / Division 2 / Group A, B, C, D / T4, Class 1 / Zone 2 / Group IIC / T4	UL 60950-1, CSA C22.2 No. 60950-1 UL 1604 and UL 2279-15 (Hazardous Location), CSA C22.2 No. 213-M1987, Class 1 / Division 2 / Group A, B, C, D / T4, Class 1 / Zone 2 / Group IIC / T4
• for emitted interference • for interference immunity	EN 61000-6-4:2007 (Class A) EN 61000-6-2:2005	EN 61000-6-4:2007 (Class A) EN 61000-6-2:2005	EN 61000-6-4:2007 (Class A) EN 61000-6-2:2005
Verification of suitability	EN 61000-6-2:2005, EN 61000-6-4:2007	EN 61000-6-2:2005, EN 61000-6-4:2007	EN 61000-6-2:2005, EN 61000-6-4:2007
• CE mark	Yes	Yes	Yes
• C-Tick	Yes	Yes	Yes
• KC approval	Yes	Yes	Yes

## PROFINET/Industrial Ethernet

### Industrial Ethernet Switches

#### Media modules for modular SCALANCE X-300 managed

#### Technical specifications (continued)

Article No.	6GK5991-1AD00-8AA0	6GK5991-1AF00-8AA0	6GK5991-1AE00-8AA0	6GK5991-1AE30-8AA0
Product-type designation	SFP991-1	SFP991-1LD	SFP991-1LH+	SFP991-1ELH200
<b>Interfaces</b>				
Number of electrical/optical connections for network components or terminal equipment maximum	1	1	1	1
Number of 100 Mbit/s LC ports	1	1	1	1
Design of optical connections for network components or terminal devices	LC	LC	LC	LC
Connectable optical power relative to 1 mW				
• of the transmitter output	-19 ... -14 dB	-15 ... -8 dB	-5 ... +0 dB	1 ... 5 dB
• of the receiver input maximum	-3 dB	-3 dB	-3 dB	-9 dB
Optical sensitivity relative to 1 mW of the receiver input minimum	-32 dB	-34 dB	-34 dB	-42 dB
Attenuation of fiber-optic cable transmission link minimum necessary	0 dB	0 dB	3 dB	14 dB
Range at the optical interface depending on the optical fiber used	0 ... 5 km	0 ... 26 km	12 ... 70 km	61 ... 200 km
<b>Permitted ambient conditions</b>				
Ambient temperature				
• during operating	-40 ... +85 °C	-40 ... +85 °C	-40 ... +85 °C	-40 ... +85 °C
• during storage	-40 ... +85 °C	-40 ... +85 °C	-40 ... +85 °C	-40 ... +85 °C
• during transport	-40 ... +85 °C	-40 ... +85 °C	-40 ... +85 °C	-40 ... +85 °C
Relative humidity at 25 °C without condensation during operating maximum	95 %	95 %	95 %	95 %
Protection class IP	IP20	IP20	IP20	IP20
<b>Design, dimensions and weight</b>				
Design	SFP Module	SFP Module	SFP Module	SFP Module
Width	13.7 mm	13.7 mm	13.7 mm	13.7 mm
Height	11.9 mm	11.9 mm	11.9 mm	11.9 mm
Depth	56.5 mm	56.5 mm	56.5 mm	56.5 mm
Net weight	0.01 kg	0.01 kg	0.01 kg	0.01 kg
Mounting type	Latched	Latched	Latched	Latched
<b>Standards, specifications, approvals</b>				
Standard				
• for EMC from FM	FM3611: Class 1, Division 2, Group A, B, C, D / T4, Class 1, Zone 2, Group IIC, T4	FM3611: Class 1, Division 2, Group A, B, C, D / T4, Class 1, Zone 2, Group IIC, T4	FM3611: Class 1, Division 2, Group A, B, C, D / T4, Class 1, Zone 2, Group IIC, T4	FM3611: Class 1, Division 2, Group A, B, C, D / T4, Class 1, Zone 2, Group IIC, T4
• for hazardous zone	EN 60079-0: 2006, EN 60079-15: 2005, II 3 G Ex nA II T4, KEMA 07 ATEX 0145 X	EN 60079-0: 2006, EN 60079-15: 2005, II 3 G Ex nA II T4, KEMA 07 ATEX 0145 X	EN 60079-0: 2006, EN 60079-15: 2005, II 3 G Ex nA II T4, KEMA 07 ATEX 0145 X	EN 60079-0: 2006, EN 60079-15: 2005, II 3 G Ex nA II T4, KEMA 07 ATEX 0145 X
• for safety of CSA and UL	UL 60950-1, CSA C22.2 No. 60950-1-03	UL 60950-1, CSA C22.2 No. 60950-1-03	UL 60950-1, CSA C22.2 No. 60950-1-03	UL 60950-1, CSA C22.2 No. 60950-1-03
• for hazardous area of CSA and UL	-	-	-	-
• for emitted interference	EN 61000-6-4:2007 (Class A)	EN 61000-6-4:2007 (Class A)	EN 61000-6-4:2007 (Class A)	EN 61000-6-4:2007 (Class A)
• for interference immunity	EN 61000-6-2:2005	EN 61000-6-2:2005	EN 61000-6-2:2005	EN 61000-6-2:2005
Verification of suitability	EN 61000-6-2:2005, EN 61000-6-4:2007	EN 61000-6-2:2005, EN 61000-6-4:2007	EN 61000-6-2:2005, EN 61000-6-4:2007	EN 61000-6-2:2005, EN 61000-6-4:2007
• CE mark	Yes	Yes	Yes	Yes
• C-Tick	Yes	Yes	Yes	Yes
• KC approval	No	No	No	No

**Technical specifications (continued)**

Article No.	6GK5992-1AL00-8AA0	6GK5992-1AM00-8AA0	6GK5992-1AN00-8AA0
Product-type designation	SFP992-1	SFP992-1LD	SFP992-1LH
<b>Interfaces</b>			
Number of electrical/optical connections for network components or terminal equipment maximum	1	1	1
Number of 1 000 Mbit/s LC ports (LX)	-	1	1
Number of 1 000 Mbit/s LC ports (SX)	1	-	-
Design of optical connections for network components or terminal devices	LC	LC	LC
Connectable optical power relative to 1 mW			
• of the transmitter output	-9.5 ... -4 dB	-9.5 ... -3 dB	-6 ... +0 dB
• of the receiver input maximum	-3 dB	-3 dB	-3 dB
Optical sensitivity relative to 1 mW of the receiver input minimum	-17 dB	-21 dB	-23 dB
Attenuation of fiber-optic cable transmission link minimum necessary	0 dB	0 dB	3 dB
Range at the optical interface depending on the optical fiber used	0 ... 0.75 km	0 ... 10 km	8 ... 40 km
<b>Permitted ambient conditions</b>			
Ambient temperature			
• during operating	-40 ... +85 °C	-40 ... +85 °C	-40 ... +85 °C
• during storage	-40 ... +85 °C	-40 ... +85 °C	-40 ... +85 °C
• during transport	-40 ... +85 °C	-40 ... +85 °C	-40 ... +85 °C
Relative humidity at 25 °C without condensation during operating maximum	95 %	95 %	95 %
Protection class IP	IP20	IP20	IP20
<b>Design, dimensions and weight</b>			
Design	SFP Module	SFP Module	SFP Module
Width	13.7 mm	13.7 mm	13.7 mm
Height	11.9 mm	11.9 mm	11.9 mm
Depth	56.5 mm	56.5 mm	56.5 mm
Net weight	0.01 kg	0.01 kg	0.01 kg
Mounting type	Latched	Latched	Latched
<b>Standards, specifications, approvals</b>			
Standard			
• for EMC from FM	FM3611: Class 1, Division 2, Group A, B, C, D / T4, Class 1, Zone 2, Group IIC, T4	FM3611: Class 1, Division 2, Group A, B, C, D / T4, Class 1, Zone 2, Group IIC, T4	FM3611: Class 1, Division 2, Group A, B, C, D / T4, Class 1, Zone 2, Group IIC, T4
• for hazardous zone	EN 60079-0: 2006, EN 60079-15: 2005, II 3 G Ex nA II T4, KEMA 07 ATEX 0145 X	EN 60079-0: 2006, EN 60079-15: 2005, II 3 G Ex nA II T4, KEMA 07 ATEX 0145 X	EN 60079-0: 2006, EN 60079-15: 2005, II 3 G Ex nA II T4, KEMA 07 ATEX 0145 X
• for safety of CSA and UL	UL 60950-1, CSA C22.2 No. 60950-1-03	UL 60950-1, CSA C22.2 No. 60950-1-03	UL 60950-1, CSA C22.2 No. 60950-1-03
• for hazardous area of CSA and UL	-	-	-
• for emitted interference	EN 61000-6-4:2007 (Class A)	EN 61000-6-4:2007 (Class A)	EN 61000-6-4:2007 (Class A)
• for interference immunity	EN 61000-6-2:2005	EN 61000-6-2:2005	EN 61000-6-2:2005
Verification of suitability	EN 61000-6-2:2005, EN 61000-6-4:2007	EN 61000-6-2:2005, EN 61000-6-4:2007	EN 61000-6-2:2005, EN 61000-6-4:2007
• CE mark	Yes	Yes	Yes
• C-Tick	Yes	Yes	Yes
• KC approval	No	No	No

## PROFINET/Industrial Ethernet

### Industrial Ethernet Switches

#### Media modules for modular SCALANCE X-300 managed

#### Technical specifications (continued)

Article No.	6GK5992-1AP00-8AA0	6GK5992-1AQ00-8AA0
Product-type designation	SFP992-1LH+	SFP992-1ELH
<b>Interfaces</b>		
Number of electrical/optical connections for network components or terminal equipment maximum	1	1
Number of 1 000 Mbit/s LC ports (LX)	1	1
Design of optical connections for network components or terminal devices	LC	LC
Connectable optical power relative to 1 mW		
• of the transmitter output	0 ... 5 dB	0 ... 5 dB
• of the receiver input maximum	-3 dB	-8 dB
Optical sensitivity relative to 1 mW of the receiver input minimum	-23 dB	-32 dB
Attenuation of fiber-optic cable transmission link minimum necessary	8 dB	8 dB
Range at the optical interface depending on the optical fiber used	30 ... 70 km	37 ... 120 km
<b>Permitted ambient conditions</b>		
Ambient temperature		
• during operating	-40 ... +85 °C	-40 ... +85 °C
• during storage	-40 ... +85 °C	-40 ... +85 °C
• during transport	-40 ... +85 °C	-40 ... +85 °C
Relative humidity at 25 °C without condensation during operating maximum	95 %	95 %
Protection class IP	IP20	IP20
<b>Design, dimensions and weight</b>		
Design	SFP Module	SFP Module
Width	13.7 mm	13.7 mm
Height	11.9 mm	11.9 mm
Depth	56.5 mm	56.5 mm
Net weight	0.01 kg	0.01 kg
Mounting type	Latched	Latched
<b>Standards, specifications, approvals</b>		
Standard		
• for EMC from FM	FM3611: Class 1, Division 2, Group A, B, C, D / T4, Class 1, Zone 2, Group IIC, T4	FM3611: Class 1, Division 2, Group A, B, C, D / T4, Class 1, Zone 2, Group IIC, T4
• for hazardous zone	EN 60079-0: 2006, EN 60079-15: 2005, II 3 G Ex nA II T4, KEMA 07 ATEX 0145 X	EN 60079-0: 2006, EN 60079-15: 2005, II 3 G Ex nA II T4, KEMA 07 ATEX 0145 X
• for safety of CSA and UL	UL 60950-1, CSA C22.2 No. 60950-1-03	UL 60950-1, CSA C22.2 No. 60950-1-03
• for hazardous area of CSA and UL	-	-
• for emitted interference	EN 61000-6-4:2007 (Class A)	EN 61000-6-4:2007 (Class A)
• for interference immunity	EN 61000-6-2:2005	EN 61000-6-2:2005
Verification of suitability	EN 61000-6-2:2005, EN 61000-6-4:2007	EN 61000-6-2:2005, EN 61000-6-4:2007
• CE mark	Yes	Yes
• C-Tick	Yes	Yes
• KC approval	No	No

Ordering data	Article No.	Article No.
<i>Electrical media modules</i>		
<b>with 2 x 10/100/1 000 Mbit/s RJ45 ports, electrical</b> <ul style="list-style-type: none"> <li>MM992-2CUC with retaining sleeve</li> <li>MM992-2CUC with retaining sleeve and coated PCBs (conformal coating)</li> <li>MM992-2CU without retaining sleeve</li> </ul>	<b>6GK5992-2GA00-8AA0</b>  <b>6GK5992-2GA00-8FA0</b>  <b>6GK5992-2SA00-8AA0</b>	
<b>with 2 x 10/100/1 000 Mbit/s M12 ports, electrical</b> <ul style="list-style-type: none"> <li>MM992-2M12 interface (x-coded) and coated PCBs (conformal coating)</li> </ul>	<b>6GK5992-2HA00-0AA0</b>	
<b>with 2 x 1/10/100/1 000 Mbit/s RJ45 ports, electrical</b> <ul style="list-style-type: none"> <li>MM992-2VD</li> </ul>	<b>6GK5992-2VA00-8AA0</b>	
<i>Fiber optic modules</i>		
<b>with 2 x 100 Mbit/s BFOC ports, optical</b> <ul style="list-style-type: none"> <li>MM991-2 multimode, glass, up to 5 km</li> <li>MM991-2LD singlemode, glass, up to 26 km</li> </ul>	<b>6GK5991-2AB00-8AA0</b>  <b>6GK5991-2AC00-8AA0</b>	
<b>with 2 x 100 Mbit/s SC ports, optical</b> <ul style="list-style-type: none"> <li>MM991-2 multimode, glass, up to 5 km</li> <li>MM991-2LD singlemode, glass, up to 26 km</li> <li>MM991-2LH+ singlemode, glass, up to 70 km</li> </ul>	<b>6GK5991-2AD00-8AA0</b>  <b>6GK5991-2AF00-8AA0</b>  <b>6GK5991-2AE00-8AA0</b>	
<b>with 2 x 1 000 Mbit/s SC ports, optical</b> <ul style="list-style-type: none"> <li>MM992-2 multimode, glass, up to 750 m</li> <li>MM992-2 multimode, glass, up to 750 m, coated PCBs (conformal coating)</li> <li>MM992-2LD singlemode, glass, up to 10 km</li> <li>MM992-2LH singlemode, glass, up to 40 km</li> <li>MM992-2LH+ singlemode, glass, up to 70 km</li> <li>MM992-2ELH singlemode, glass, up to 120 km</li> </ul>	<b>6GK5992-2AL00-8AA0</b>  <b>6GK5992-2AL00-8FA0</b>  <b>6GK5992-2AM00-8AA0</b>  <b>6GK5992-2AN00-8AA0</b>  <b>6GK5992-2AP00-8AA0</b>  <b>6GK5992-2AQ00-8AA0</b>	
<b>with 2 x 100/1 000 Mbit/s for SFP pluggable transceiver, optical</b> <ul style="list-style-type: none"> <li>MM992-2SFP for SFP pluggable transceivers with 1 x 100 or 1 x 1 000 Mbit/s multimode or singlemode, glass</li> </ul>	<b>6GK5992-2AS00-8AA0</b>	
<i>SFP pluggable transceiver, optical</i>		
<b>with 1 x 100 Mbit/s LC port, optical</b> <ul style="list-style-type: none"> <li>SFP991-1 multimode, glass, up to 5 km</li> <li>SFP991-1LD singlemode, glass, up to 26 km</li> <li>SFP991-1LH+ singlemode, glass, up to 70 km</li> <li>SFP991-1ELH200 singlemode, glass, up to 200 m</li> </ul>		<b>6GK5991-1AD00-8AA0</b>  <b>6GK5991-1AF00-8AA0</b>  <b>6GK5991-1AE00-8AA0</b>  <b>6GK5991-1AE30-8AA0</b>
<b>with 1 x 1 000 Mbit/s LC port, optical</b> <ul style="list-style-type: none"> <li>SFP992-1 multimode, glass, up to 750 m</li> <li>SFP992-1LD singlemode, glass, up to 10 km</li> <li>SFP992-1LH singlemode, glass, up to 40 km</li> <li>SFP992-1LH+ singlemode, glass, up to 70 km</li> <li>SFP992-1ELH singlemode, glass, up to 120 km</li> </ul>		<b>6GK5992-1AL00-8AA0</b>  <b>6GK5992-1AM00-8AA0</b>  <b>6GK5992-1AN00-8AA0</b>  <b>6GK5992-1AP00-8AA0</b>  <b>6GK5992-1AQ00-8AA0</b>
<i>Accessories</i>		
<b>IE FC RJ45 Modular Outlet</b>  FastConnect RJ45 outlet for Industrial Ethernet with interface for replaceable insert <ul style="list-style-type: none"> <li>with insert 2FE; replaceable insert for 2 x 100 Mbit/s interfaces</li> <li>with 1GE insert; replaceable insert for 1 x 1 000 Mbit/s interfaces</li> </ul>		<b>6GK1901-1BE00-0AA1</b>  <b>6GK1901-1BE00-0AA2</b>
<b>IE FC TP Standard Cable GP 2 x 2 (Type A)</b>  4-core, shielded TP installation cable for connection to IE FC Outlet RJ45/IE FC RJ45 Plug; PROFINET-compatible; with UL approval; sold by the meter; max. length 1 000 m, minimum order quantity 20 m		<b>6XV1840-2AH10</b>
<b>IE FC TP Standard Cable GP 4 x 2</b>  8-core, shielded TP installation cable for connection to IE FC RJ45 modular outlet for universal application; with UL approval; sold by the meter; max length 1 000 m, minimum order 20 m		<b>6XV1870-2E</b>

## PROFINET/Industrial Ethernet

### Industrial Ethernet Switches

#### Media modules for modular SCALANCE X-300 managed

##### Ordering data

##### Article No.

###### Accessories (continued)

###### IE TP Cord RJ45/RJ45

TP cable 4 x 2  
with two RJ45 plugs

- 0.5 m
- 1 m
- 2 m
- 6 m
- 10 m

**6XV1870-3QE50**  
**6XV1870-3QH10**  
**6XV1870-3QH20**  
**6XV1870-3QH60**  
**6XV1870-3QN10**

###### IE FC RJ45 Plug 180

RJ45 plug connector for Industrial Ethernet with a rugged metal enclosure and integrated insulation displacement contacts for connecting Industrial Ethernet FC installation cables; with 180° cable outlet; for network components and CPs/CPU with Industrial Ethernet interface

- 1 pack = 1 unit
- 1 pack = 10 units
- 1 pack = 50 units

**6GK1901-1BB10-2AA0**  
**6GK1901-1BB10-2AB0**  
**6GK1901-1BB10-2AE0**

###### IE FC RJ45 Plug 4 x 2

RJ45 plug connector for Industrial Ethernet (10/100/1 000 Mbit/s) with a rugged metal enclosure and integrated insulation displacement contacts for connecting Industrial Ethernet FC installation cables; 180° cable outlet; for network components and CPs/CPU with Industrial Ethernet interface

- 1 pack = 1 unit
- 1 pack = 10 units
- 1 pack = 50 units

**6GK1901-1BB11-2AA0**  
**6GK1901-1BB11-2AB0**  
**6GK1901-1BB11-2AE0**

##### More information

###### Selection tool:

To assist in selecting the right Industrial Ethernet switches as well as configuration of modular variants, the SIMATIC NET Selection Tool and the TIA Selection Tool are available at:

SIMATIC NET Selection Tool:

- Online version:  
<http://www.siemens.com/snst>
- Offline version:  
<http://www.siemens.com/snst-download>

TIA Selection Tool:

<http://www.siemens.com/tia-selection-tool>





**Overview**

SCALANCE X-400		Hardware																										
		Type of device	Connection to S7 backplane bus	Format module S7	PC module	Flat type of construction	Box type of construction	19" type of construction	Rugged, compact housing	Modular design	10 Gigabit Ethernet	Gigabit Ethernet	PoE (Power over Ethernet)	LED diagnosis	SIMATIC environment	Redundant power supply (2 x 24 V DC)	External supply for integrated switch	Signal contact	Local display (SET pushbutton)	PLUG slot								
X408-2										•	•		•	•	•													
X414-3E										•	•		•	•	•													
XM416-4C			•							•	•		•	•	•													
XM408-8C			•							•	•		•	•	•													
XM408-4C			•							•	•		•	•	•													
PE408			•							•	•		•	•	•													
PE400-8SFP			•							•	•		•	•	•													
PE408 PoE			•							•	•		•	•	•													
SCALANCE X-400		Software																										
		Security Integrated (Firewall/VPN)	PROFINET diagnosis	Topology support (LLDP)	Command Line Interface / Teinet	Web based Management	Configuration with STEP 7 / TIA	SNMP	Ring redundancy incl. RM-functionality	Standby redundancy	IRT capability	VLAN (Virtual Local Area Network)	GVRP (Generic VLAN Registration Protocol)	STP/ RSTP (Spanning Tree Protocol/ Rapid Spanning Tree Protocol)	Passive Listening	IGMP Snooping/Querier (Internet Group Management Protocol)	GMRP (Generic Multicast Protocol)	Broadcast/ Multicast/ Unicast Limiter	Broadcast blocking	DHCP Option 82 (Dynamic Host Configuration Protocol)	Access Control List (IP)	Access Control List (MAC)	IEEE 802.1x (Radius)	Link Aggregation	Static Routing	RIPv2 (Dynamic Routing)	OSPFv2 (Dynamic Routing)	VRRP, Router Redundancy (Virtual Router Redundancy Protocol)
X408-2		•	•	•	•	•	•	•	•		•	•	•	•	•	•	•	•	•	•	•	•	•	•	•	•	•	•
X414-3E		•	•	•	•	•	•	•	•		•	•	•	•	•	•	•	•	•	•	•	•	•	•	•	•	•	•
XM416-4C		•	•	•	•	•	•	•	•		•	•	•	•	•	•	•	•	•	•	•	•	•	•	•	•	•	•
XM408-8C		•	•	•	•	•	•	•	•		•	•	•	•	•	•	•	•	•	•	•	•	•	•	•	•	•	•
XM408-4C		•	•	•	•	•	•	•	•		•	•	•	•	•	•	•	•	•	•	•	•	•	•	•	•	•	•

• applies

G\_IK10\_XX\_10309

Functional overview of SCALANCE X-400 managed and XM-400 managed

## PROFINET/Industrial Ethernet

### Industrial Ethernet Layer 3 Switches / Routers

#### SCALANCE X-400 managed

#### Overview



The SCALANCE X-400 product range comprises modular Industrial Ethernet switches expandable with various media modules and, in some cases, with extenders. It supports 10/100/1 000 Mbit technology for various transmission media (twisted pair, fiber optic) and increased port requirements. The main applications are high-performance plant networks (control level). Thanks to its partly modular design, the X-400 product line is also designed for future requirements and can be adapted to the relevant task.

- Two to four integral Gigabit Ethernet twisted pair interfaces (10/100/1 000 Mbit/s) for connecting several switches to each other; node connection via the Fast Ethernet twisted pair ports (10/100 Mbit/s) integrated into the basic unit
- **SCALANCE X414-3E;** another eight nodes can be connected to the basic unit via extender modules; the following extender modules are available:
  - Extenders with eight Fast Ethernet twisted-pair ports
  - Extenders with four media module slots for up to eight Fast Ethernet fiber optic ports
- High-speed media redundancy through integral redundancy manager even for large networks, for both Gigabit Ethernet and Fast Ethernet
- For the construction of optical Gigabit Ethernet rings, the integrated Gigabit Ethernet ports can be converted to fiber optic via a 2-port Gigabit Ethernet media module (MM).
- By means of pluggable 2-port Fast Ethernet media modules for multimode or alternatively single-mode fiber-optic cable, SCALANCE X-400 switches can also be integrated into 100 Mbit/s rings, e.g. with SCALANCE X204-2. In this way, even remote nodes can be connected optically.
- Remote diagnostics by means of PROFINET diagnostics, CLI, Web browser, or SNMP
- Seamless integration of automation networks into existing corporate networks thanks to support for a host of IT standards: Establishment of virtual networks (VLANs)
- Integration into higher-level enterprise networks thanks to support for standardized redundancy procedures (Rapid Spanning Tree Protocol)
- By learning the Multicast sources and targets (IGMP: Internet Group Management Protocol snooping), SCALANCE X-400 switches can also filter Multicast data traffic and therefore limit the load in the network.
- Creation of IP subnets and IP router communication by means of Layer 3 switching (IP routing) on SCALANCE X414-3E
  - Static routing
  - Dynamic routing OSPF (Open Shortest Path First) and RIPv2 (Routing Information Protocol)
  - Redundant routing VRRP (Virtual Router Redundancy Protocol)

#### SCALANCE X408-2/SCALANCE X414-3

##### Communication connections

- Integral Gigabit Ethernet twisted pair ports (10/100/1 000 Mbit/s, RJ45 sockets) for interconnecting the SCALANCE X-400 switches:
  - **SCALANCE X408-2:** 4 Gigabit Ethernet twisted pair ports
  - **SCALANCE X414-3E:** 2 Gigabit Ethernet twisted pair ports
- Integral Fast Ethernet twisted pair ports (10/100 Mbit/s, RJ45 sockets with retaining collars) for node connection
  - **SCALANCE X408-2:** 4 Fast Ethernet twisted pair ports
  - **SCALANCE X414-3E:** 12 Fast Ethernet twisted pair ports
- The Gigabit Ethernet ports can be converted to fiber-optic connections with optical Gigabit Ethernet media modules

##### Only for **SCALANCE X408-2**

- Two universal slots either for optical Fast Ethernet or Gigabit Ethernet media modules with two ports

##### Only for **SCALANCE X414-3E**

- Two slots for optical Fast Ethernet media modules with two ports
- One extender interface for expansion by 8 Fast Ethernet ports (twisted pair or fiber optic, depending on extender version). In this way, a maximum configuration of two Gigabit Ethernet Ports (electrical or optical) and up to 24 Fast Ethernet ports (of which between 2 and 12 can be optical) is possible. The maximum installation width including extender is 19".

##### Interfaces:

- Console port (serial interface) for on-site parameterization/diagnostics, for firmware update
- Slot for C-PLUG swap media for easy device replacement (included in scope of supply)
- Redundant 24 V DC supply; two feeds are available for protection against voltage failure
- One floating message output for simple display of faults

##### Only for **SCALANCE X414-3E**

- Additional out-band Ethernet port for on-site parameterization/diagnostics
- Eight floating inputs for recording digital status information such as signal contacts of PROFIBUS OLM or door contacts and forwarding via SCALANCE X-400 diagnostic paths (LED indicator, log table, trap or Email)

Extensive operating mode and status information is displayed via LEDs and selection buttons.

### Benefits



- Flexible construction of electrical or optical Industrial Ethernets; the network topology, type and number of ports can be adapted easily to the structure of the plant
- High availability of the network thanks to:
  - Redundant power supply
  - Redundant network structures based on fiber-optic or twisted pair cables (redundancy manager, standby function, RSTP and VRRP are integrated)
  - Replacement and extension of media and expansion modules during operation
  - Easy device replacement by means of plug-in C-PLUG swap medium
- Reliable communication thanks to very fast reconfiguration of the network in the event of a fault
- Simple fiber optic connection technology by means of SC sockets (Gigabit Ethernet), BFOC sockets (Fast Ethernet) and prefabricated fiber optic cables
- Twisted pair ports are readily accessible from the front, 10/100/1 000 Mbit/s; ports with sleeve for rugged, industry-compatible station connection for direct connections up to 100 m in conjunction with the PROFINET-compatible IE FC RJ45 Plug 180 or IE FC RJ45 Plug 145 connector
- Easy network configuration without runtime calculation also for extremely large networks
- Simple monitoring and diagnosis by means of signaling contact, digital inputs, SNMP, Syslog and e-mail; PROFINET IO diagnostics
- Reduced engineering expenditure for PLC/HMI due to integration into the SIMATIC system fault message concept SFM
- Thanks to the integrated Layer 3 function (IP routing) – static, dynamic and redundant – of SCALANCE X414-3E, networks can be divided into different subnets
- Investment protection for existing networks due to
  - Effortless connection of existing 10 bit/s data terminals or network segments to Fast Ethernet networks with 100 Mbit/s
  - Increase in performance through load decoupling and data transfer rates of 100 Mbit/s and 1 000 Mbit/s
  - Easy integration into existing network management infrastructures by means of SNMP
- Support of VLAN permits integration into Enterprise Security Policies
- Load limiting with use of Multicast protocols (e.g. video transmission) by means of IGMP (Internet Group Management Protocol) snooping or GMRP (GARP Multicast Registration Protocol)
- Protection of network against overload by setting of port thresholds
- Operating temperature range
  - **SCALANCE X414-3E:** -40 °C to + 70 °C
  - **SCALANCE X408-2:** 0 °C to + 60 °C
- Low-maintenance operation thanks to fanless construction

### Application

SCALANCE X-400 products permit the configuration of switched networks at the control level, which not only demands high availability of the network and extensive diagnostic options, but also a high number of ports, high transfer rate and the support of fiber optic and twisted-pair transmission media. SCALANCE X-400 products are designed with IP20 degree of protection for installation in control cabinets.

#### SCALANCE X408-2

- Control stations with a low concentration of devices
- Star hub in plant bus for applications with low concentration of devices
- High-speed backbone including high-speed media redundancy for process control systems
- In the high-speed backbone for coupling Gigabit network topologies

#### SCALANCE X414-3E

- Control stations with a high concentration of devices
- Star hub in plant bus for applications with high concentration of devices
- High-speed backbone including high-speed media redundancy for process control systems
- SCALANCE X414-3E equipped with Layer 3 for IP routing (static, dynamic, redundant)

### Design

#### SCALANCE X-400 media modules (MM)

SCALANCE X-400 switches can be equipped with 2-port media modules. Media modules are available for both multi-mode and single-mode optical fibers. They can be added or replaced during network operation. The operating temperature range is -40 to +70 °C. The SCALANCE X414-3E basic unit supports two optical Gigabit Ethernet ports and up to four additional optical Fast Ethernet ports.

On two media-module slots, SCALANCE X408-2 supports as many as four optical ports which can optionally be equipped with optical Gigabit Ethernet or Fast Ethernet media modules.

The following media modules are available:

- MM491-2; two fiber optic ports (BFOC sockets) 100 Mbit/s for distances up to 5 km with multi-mode fiber-optic conductors
- MM491-2LD; two fiber optic ports (BFOC sockets) 100 Mbit/s for distances up to 26 km with single-mode fiber-optic conductors
- MM491-2LH+; two fiber optic ports (SC sockets) 100 Mbit/s for distances up to 70 km with single-mode fiber-optic conductors
- MM492-2; two fiber optic ports (SC sockets) 1 Gbit/s for distances up to 750 m with multi-mode fiber-optic conductors (when using SIMATIC NET FO cable 50/125 µm)
- MM492-2LD; two fiber optic ports (SC sockets) 1 Gbit/s for distances up to 10 km with single-mode fiber-optic conductors
- MM492-2LH; two fiber optic ports (SC sockets) 1 Gbit/s for distances up to 40 km with single-mode fiber-optic conductors
- MM492-2LH+; two fiber optic ports (SC sockets) 1 Gbit/s for distances up to 70 km with single-mode fiber-optic conductors
- MM492-2ELH; two fiber-optic ports (SC sockets) 1 Gbit/s for distances up to 120 km with single-mode fiber-optic conductors

# PROFINET/Industrial Ethernet

## Industrial Ethernet Layer 3 Switches / Routers

### SCALANCE X-400 managed

#### Design (continued)

Plug-in media modules for Gigabit Ethernet convert the Gigabit Ethernet twisted pair-ports included in the switch to optical mode. The Gigabit ports can then be used as either twisted-pair or fiber-optic ports. In the case of the SCALANCE X414-3E basic device, optical media modules for Fast Ethernet each generate two additional ports per slot.

#### SCALANCE X-400 extender modules (EM)

(For SCALANCE X414-3E only)

An optional extender module with up to eight further Fast Ethernet ports can be mounted next to the expansion interface of the SCALANCE X414-3E. The operating temperature range is -40 to +70 °C.

#### Versions

- EM495-8; with 8 twisted pair ports (RJ45 sockets with sleeves) 10/100 Mbit/s; this enables the 12 onboard Fast Ethernet twisted pair ports of the SCALANCE X414-3E to be expanded to a total of 20 ports.
- EM496-4; with a further four media module slots for Fast Ethernet media modules for up to 8 optical Fast Ethernet ports

The structure of the SCALANCE X-400 product line offers the following advantages

- Simple user connection via twisted pair
- Gigabit Ethernet transfer rate between SCALANCE X-400 switches
- Fiber optic connection via fiber-optic media modules
- Reduced costs for spare parts inventories  
Electrical and optical variants are covered by a basic unit and fiber-optic media modules

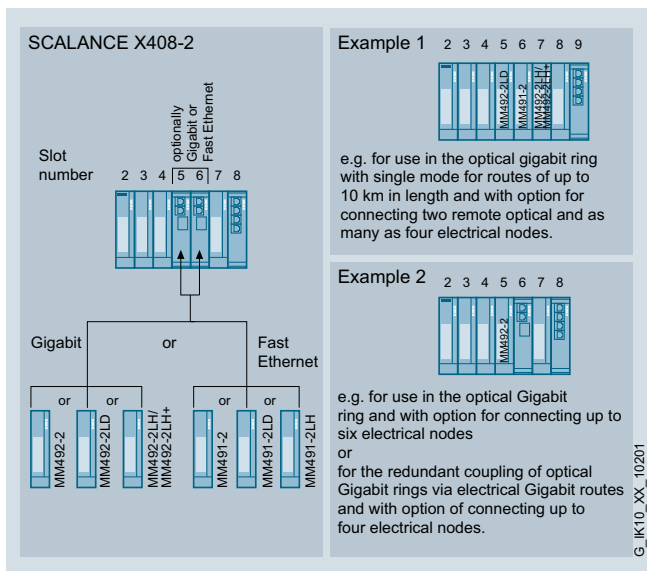

Possible applications of the media modules with SCALANCE X408-2

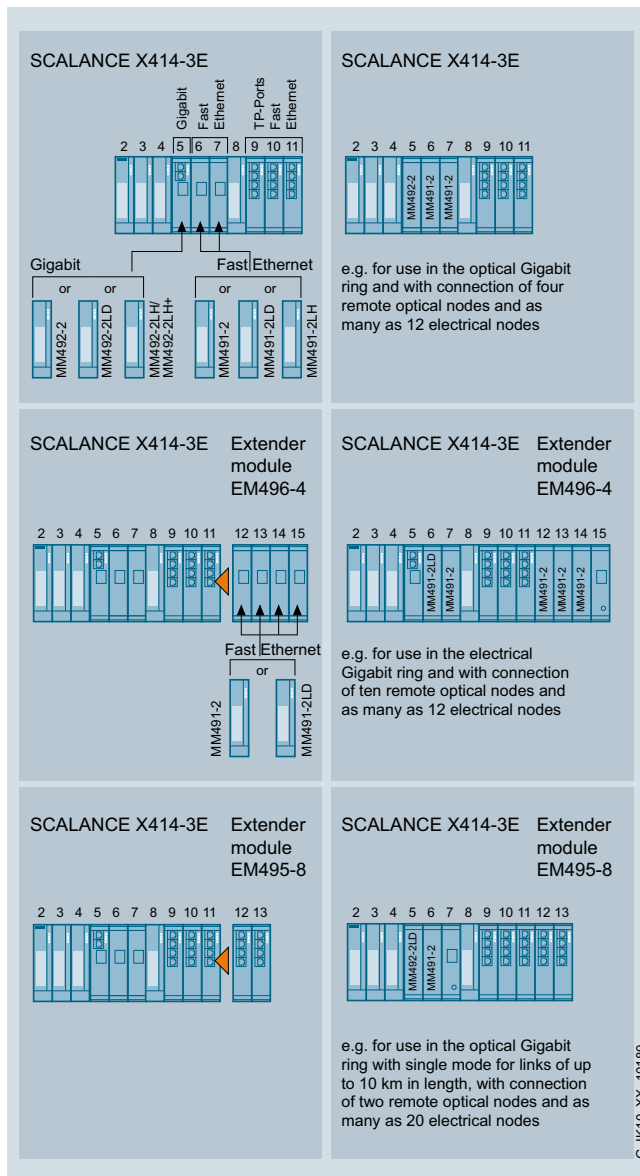

Possible applications of the media and extender modules with SCALANCE X414-3E

## Function

- Increasing the network performance; by filtering the data traffic on the basis of the Ethernet (MAC) address of the data terminals, the local data traffic remains local; only data intended for users of another subnetwork are forwarded by the switch.
- Simple network configuration and network expansion; the switch saves the data received at the ports and forwards it automatically to the destination address. The limitation of the network expansion by collision detection (CSMA/CD procedure) terminates at the port.
- Limitation of the error propagation to the affected subnetwork; the SCALANCE X-400 switches only forward data with a valid checksum (CRC).
- Integration of existing subnetworks with 10 Mbit/s into Fast Ethernet networks with 100 Mbit/s; at the twisted-pair ports, the SCALANCE X-400 switch automatically recognizes the conductor pairs for transmission and reception (autocrossover), the data transfer rate of 10 or 100 Mbit/s, as well as full-duplex and half-duplex operation (autonegotiation).
- High-performance connection of SCALANCE X-400 switches with 1 Gbit/s; SCALANCE X-400 switches have two (X414-3E) or four (X408-2) Gigabit Ethernet ports for connecting the switches to each other.
- Integrated redundancy manager for constructing Fast Ethernet and Gigabit Ethernet ring topologies with high-speed media redundancy.
- High-speed standby redundancy; several network segments such as rings can be inter-connected redundantly with SCALANCE X-400 by means of the integrated standby function. Two X-400 switches are configured in a ring as a master and slave and are connected via two links to the other ring. In the case of SCALANCE X408-2 or SCALANCE X-300, a high-performance redundant coupling at 1 000 Mbit/s is possible.
- Redundant interfacing to company networks; SCALANCE X-400 switches support the standardized redundancy procedures Spanning Tree Protocol (STP) and Rapid Spanning Tree Protocol (RSTP). This enables a subnetwork to be connected redundantly to a higher level corporate network with reduced requirements for the re-configuration time (in the order of seconds).
- Support of virtual networks (VLAN) for structuring Industrial Ethernet networks with a fast growing number of users, a physically existing network can be divided into several virtual networks.
- Integrated hardware Layer 3 Switching function (IP routing, only SCALANCE X414-3E); IP subnetworks can be created and interconnected, e.g. automation network with office network, enabling a structuring of the networks.
- Load limiting with use of Multicast protocols (e.g. video transmission); through learning the Multicast sources and targets (IGMP snooping), SCALANCE X-400 switches can also filter Multicast data traffic and therefore limit the load in the network.
- Time synchronization  
Diagnostic messages (log table entries, e-mails) are time-stamped. The local time is standardized throughout the network by means of synchronization with a SICLOCK or SNTP time transmitter, thereby simplifying the assignment of diagnostic messages to several devices.
- Fast replacement of devices in event of failure, by means of the C-PLUG switching medium

## PROFINET/Industrial Ethernet

### Industrial Ethernet Layer 3 Switches / Routers

#### SCALANCE X-400 managed

#### Function (continued)

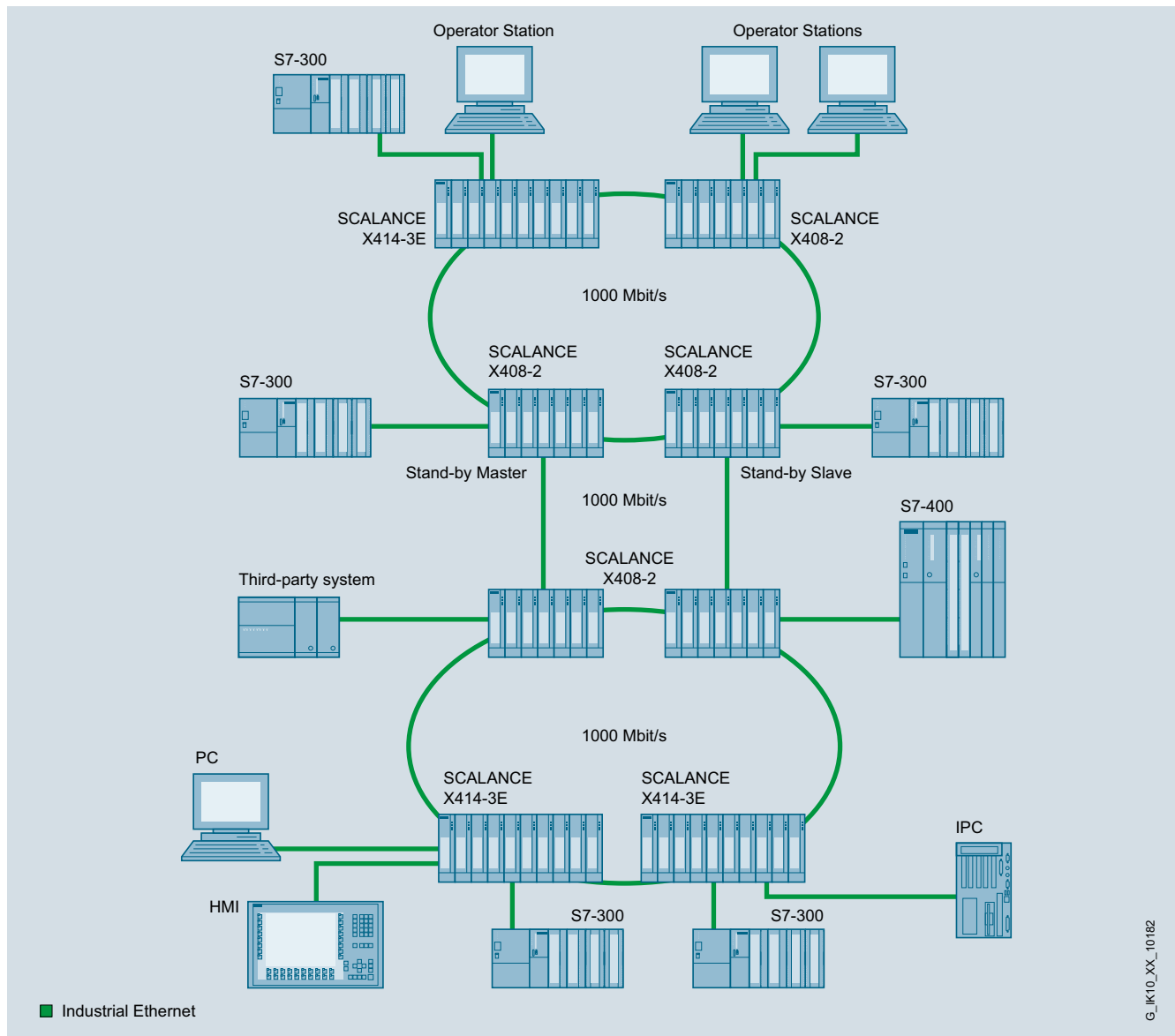

Optical redundant connection of two optical Gigabit subnets with SCALANCE X408-2 on Layer 2 and Layer 3

### Function (continued)

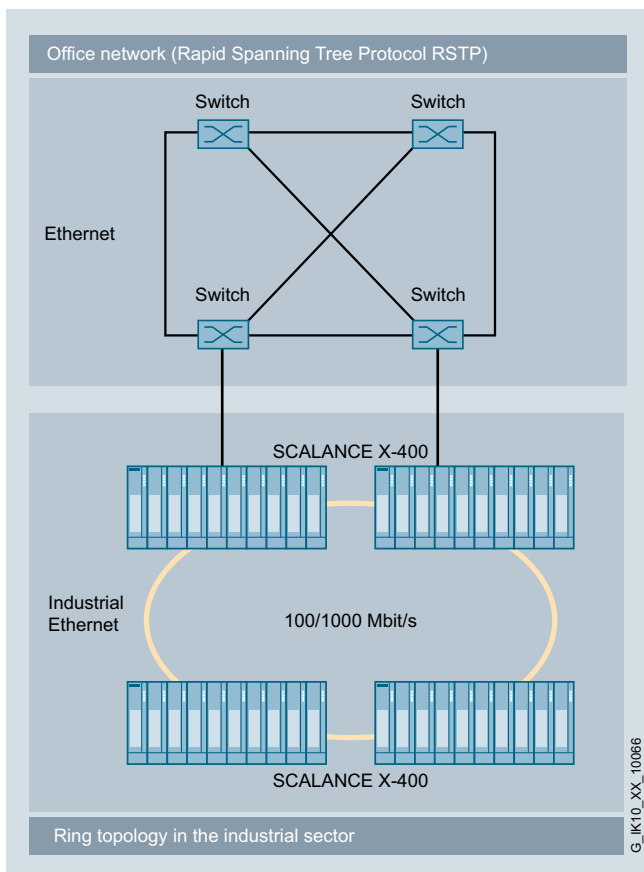

Redundant coupling with an Office network and industrial network on Layer 2 and Layer 3

### Network topology and network configuration

The network topology can easily be adapted to the structure of the plant with SCALANCE X-400 Industrial Ethernet switches. The following network structures and combinations of structures can be implemented:

- Fast Ethernet and Gigabit rings with fast media redundancy: To protect against failure of a transmission link or a switch, as many as 50 X-400 switches cascaded in line can be connected into a ring with a total length of up to 150 km using multi-mode or 6,000 km using single mode. On the failure of a transmission link or a SCALANCE X-400 switch in the ring, the transmission path is quickly reconfigured due to the media redundancy.
- Several rings can be redundantly linked through the standby function.
- At the same time, SCALANCE X-400 supports redundant connection of the ring structure to the corporate network with Rapid Spanning Tree.
- Star topology with SCALANCE X-400 switches: The SCALANCE X-414-3E switch represents a star point which can interconnect as many as 26 nodes or subnetworks electrically or optically; SCALANCE X408-2 can connect up to 8 nodes or subnetworks.

When configuring the network, it is necessary to observe the following boundary conditions:

- Maximum line length between two modules for multi-mode fiber-optic conductors:
  - 3 000 m at 100 Mbit/s
  - 750 m at 1 Gbit/s
- Maximum line length between two modules for single-mode fiber-optic conductors:
  - 70 km at 100 Mbit/s
  - 12 km at 1 Gbit/s
- Maximum length of installation cable:
  - 100 m at 100 Mbit/s with IE FC TP Cable 2 x 2 and IE FC Plug 180
  - Max. 90 m at 1 Gbit/s with IE FC TP cable 4 x 2, IE FC RJ45 modular outlet and patch cable (10 m)
  - 100 m at 1 000 Mbit/s with IE FC TP Cable 4 x 2 and IE FC Plug 4 x 2

### Commissioning and diagnosis

Setting options on the device itself:

- Redundancy manager RM; to establish a ring, a SCALANCE X-400 is switched to RM mode. The Gigabit ports (electrical or – with media module – optical) are preferably used as ring ports. When using in optical rings with 100 Mbit/s, the ring ports can be configured on one media module or on two media modules.
- Signal mask; the signal mask is set to the current status of the SCALANCE X-400 (setpoint) by pushbutton operation. It defines which ports and which voltage feeds are to be monitored. The signal contact only reports an error when a monitored port or a monitored feeder fails (deviation of setpoint/actual status).

Diagnostic options on site:

- The following status information is displayed by LEDs on site:
  - Port status
  - Port mode (10/100/1 000 Mbit/s, full/half-duplex)
  - Status of the two voltage feeders
  - Signal contact status
  - Signal mask (setpoint status)
  - RM mode
  - Standby mode
- The status of the signal contact is routed externally by means of floating relay contacts. This enables, for example, the module to be monitored via an input module from a controller.
- A PC or a programming device can be directly connected via a serial interface or, with the X414-3E, also via an Ethernet interface (out-band port). Operation is by means of commands (Command Line Interface (CLI)).
- Monitoring via the Industrial Ethernet network; the following possibilities are available:
  - Remote via standard browser (Web-based management): Selection of SCALANCE X-400 switches via the network from a PC with browser
  - Remote via SNMP V1, V2c, V3: Secure integration of SCALANCE X-400 switches via the network into a network management station
  - Remote via PROFINET IO diagnostics
  - Standard diagnostic alarms can be configured in an easy, familiar manner in STEP 7 and processed in SIMATIC. The engineering outlay is drastically reduced for the PLC and HMI through complete integration in the SIMATIC system error message concept SFM.

## PROFINET/Industrial Ethernet

### Industrial Ethernet Layer 3 Switches / Routers

#### SCALANCE X-400 managed

##### Function (continued)

##### Network management

The network management provides the following functions:

- Password-protected dial-up for "Administrator" (read and write authorization) and "User" (read only)
- Read-out of version and status information
- Setting the signal and standby mask and address information
- Fixed parameterization of the ports (data rates, half/full duplex)
- Setting parameters of the VLANs and multicast services
- Parameterization of the standby connections for a redundant ring link
- Setting of Rapid Spanning Tree parameters
- Parameterization of user administration of SNMP V1, V2c, V3:
- Output of statistics information

- Diagnosis of data traffic by means of a parameterizable mirror port with a standard commercial network analyzer
- Loading of new firmware or the configuration data via the network by a TFTP server
- Saving the configuration data or log table via the network on a TFTP server
- Only for SCALANCE X414-3E:  
Configuration of the IP routing function (static routing, dynamic routing, (OSPF, RIP v1/2) and redundant routing (VRRP))

If faults occur in the network, the SCALANCE X-400 switch can independently send error messages (traps) to a network management system or also e-mails to a predefined network administrator.

Remote monitoring (RMON) provides the following functions: The SCALANCE XM-400 switch can collect statistics information according to the RMON groups 1 through 4. These include, for example, fault statistics that are kept for each port. This information can be read out through Web-based management in the statistics sub-area.

##### Integration

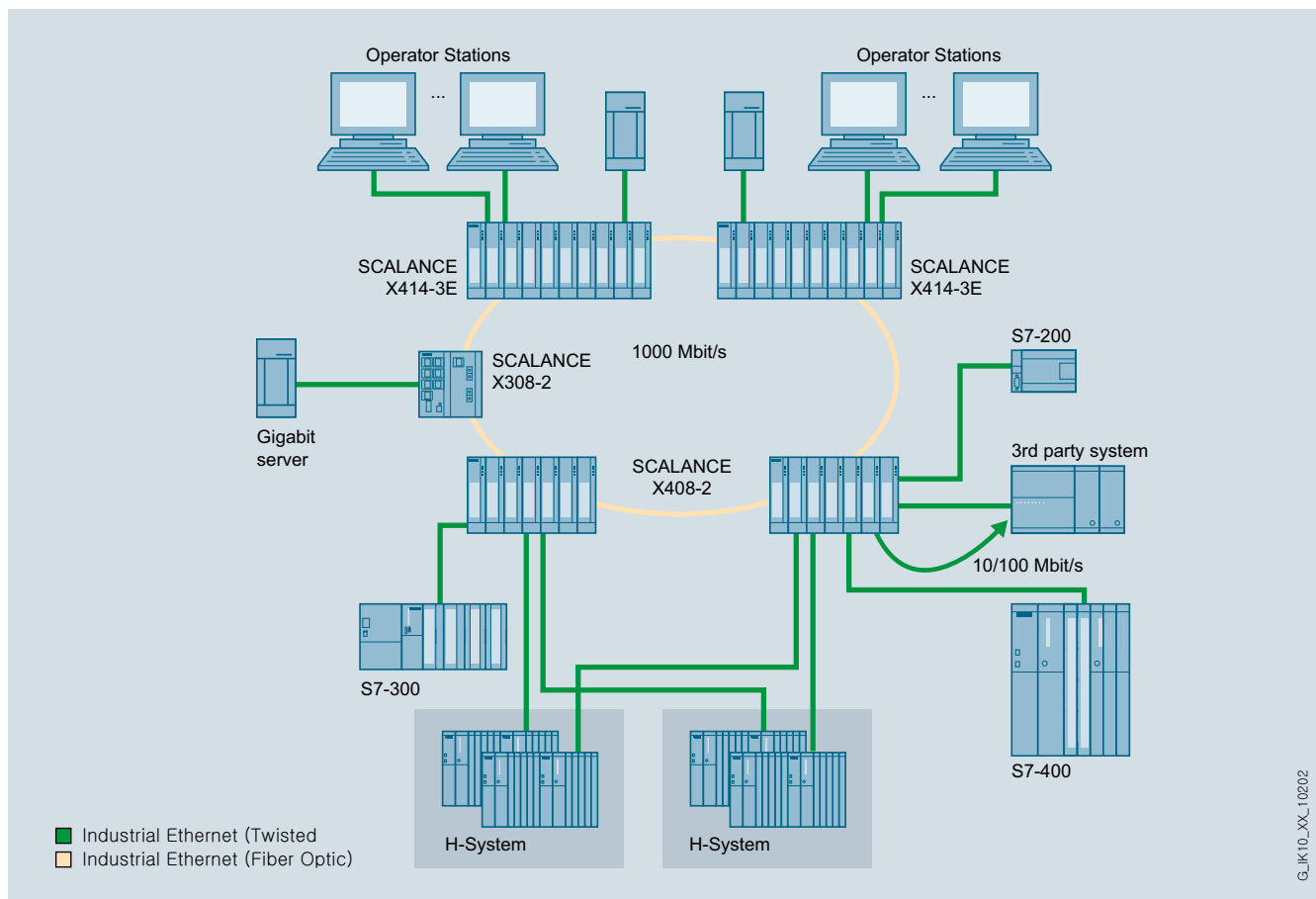

Fault-tolerant system with SCALANCE X-400



**Technical specifications**

Article No.	6GK5408-2FD00-2AA2	6GK5414-3FC00-2AA2
Product-type designation	SCALANCE X408-2	SCALANCE X414-3E
<b>Transmission rate</b>		
Transfer rate 1	10 Mbit/s	10 Mbit/s
Transfer rate 2	100 Mbit/s	100 Mbit/s
Transfer rate 3	1 000 Mbit/s	1 000 Mbit/s
<b>Interfaces</b>		
Number of electrical/optical connections for network components or terminal equipment maximum	12	26
Number of electrical connections for operator console	1	1
Design of electrical connection for operator console	RS232 port	RS232 port
Number of electrical connections		
• for network components and terminal equipment	8	14
• for network components and terminal equipment with extender modules	-	8
• for signaling contact	1	1
• for media module	2	3
• for power supply	1	1
• for redundant power supply	1	1
Design of electrical connection		
• for network components and terminal equipment	RJ45 port (4 x 1GE, 4 x FE)	RJ45 port (2 x 1GE, 12 x FE)
• for network components and terminal equipment with extender modules	-	RJ45 port via EM495-8
• for signaling contact	4-pole terminal block	4-pole terminal block
• for power supply	4-pole terminal block	4-pole terminal block
Number of optical interfaces for optical waveguide		
• at 100 Mbit/s	4	4
• at 1 000 Mbit/s	4	2
• with extender modules	-	8
Design of optical interface for optical waveguide		
• at 100 Mbit/s	BFOC or SC ports via media modules MM491-2, MM491-2LD, MM491-2LH+	BFOC or SC ports via media modules MM491-2, MM491-2LD, MM491-2LH+
• at 1 000 Mbit/s	SC ports via media modules MM492-2, MM492-2LD, MM492-2LH, MM492-2LH+	SC ports via media modules MM492-2, MM492-2LD, MM492-2LH, MM492-2LH+
• with extender modules	-	BFOC or SC ports via media modules MM491-2, MM491-2LD, MM491-2LH+, MM492-2, MM492-2LD, MM492-2LH, MM492-2LH+
Number of extender expansion interfaces	-	1
Design of the extender extension interface	-	EM495-8 or EM496-4
Design of the removable storage C-PLUG	Yes	Yes
<b>Signal-Inputs/outputs</b>		
Operating voltage of signaling contacts at DC rated value	24 V	24 V
Operating current of signaling contacts at DC maximum	0.1 A	0.1 A
Number of digital inputs	-	2
Number of electrical connections for digital input signals	-	2
Design of electrical connection for digital input signals	-	5-pole terminal block

## PROFINET/Industrial Ethernet

### Industrial Ethernet Layer 3 Switches / Routers

#### SCALANCE X-400 managed

#### Technical specifications (continued)

Article No.	6GK5408-2FD00-2AA2	6GK5414-3FC00-2AA2
Product-type designation	SCALANCE X408-2	SCALANCE X414-3E
<b>Supply voltage, current consumption, power loss</b>		
Type of supply voltage	DC	DC
Supply voltage external	24 V	24 V
• minimum	20.4 V	20.4 V
• maximum	28.8 V	28.8 V
Product component fusing at power supply input	Yes	Yes
Type of fusing at input for supply voltage	F 3 A / 32 V	F 3,15 A / 250 V
Consumed current maximum	0.7 A	2 A
Active power loss		
• at 24 V for DC	8 W	15 W
• maximum	48 W	48 W
<b>Permitted ambient conditions</b>		
Ambient temperature		
• during operating	0 ... 60 °C	-40 ... +70 °C
• during storage	-40 ... +80 °C	-40 ... +80 °C
• during transport	-40 ... +80 °C	-40 ... +80 °C
Relative humidity at 25 °C without condensation during operating maximum	95 %	95 %
Protection class IP	IP20	IP20
<b>Design, dimensions and weight</b>		
Design	Modular	Modular
Width	242 mm	344 mm
Height	145 mm	145 mm
Depth	117 mm	117 mm
Net weight	1.9 kg	3.07 kg
Mounting type		
• 35 mm DIN rail mounting	Yes	Yes
• wall mounting	No	No
• S7-300 rail mounting	Yes	Yes
Mounting type	-	-
<b>Product properties, functions, components general</b>		
Cascading in the case of a redundant ring at reconfiguration time of < 0.3 s	50	50
Cascading in cases of star structuring	Any (depending only on signal propagation time)	Any (depending only on signal propagation time)
<b>Product functions management, configuration</b>		
Product function		
• CLI	Yes	Yes
• web-based management	Yes	Yes
• MIB support	Yes	Yes
• TRAPs via email	Yes	Yes
• Configuration with STEP 7	Yes	Yes
• RMON	Yes	Yes
• Port mirroring	Yes	Yes
• CoS	Yes	Yes
• PROFINET IO diagnosis	Yes	Yes
• switch-managed	Yes	Yes

**Technical specifications** (continued)

Article No.	6GK5408-2FD00-2AA2	6GK5414-3FC00-2AA2
Product-type designation	SCALANCE X408-2	SCALANCE X414-3E
Protocol is supported		
• Telnet	Yes	Yes
• HTTP	Yes	Yes
• HTTPS	Yes	Yes
• TFTP	Yes	Yes
• FTP	Yes	Yes
• BOOTP	Yes	Yes
• SNMP v1	Yes	Yes
• SNMP v2	Yes	Yes
• SNMP v3	Yes	Yes
• IGMP (snooping/querier)	Yes	Yes
• GMRP	Yes	Yes
• DCP	Yes	Yes
• LLDP	Yes	Yes
Identification & maintenance function		
• I&M0 - device-specific information	Yes	Yes
• I&M1 - higher level designation/location designation	Yes	Yes
<b>Product functions Diagnosis</b>		
Product function		
• Port diagnostics	Yes	Yes
• Statistics packet size	Yes	Yes
• Statistics packet type	Yes	Yes
• Error statistics	Yes	Yes
• SysLog	Yes	Yes
<b>Product functions VLAN</b>		
Product function		
• VLAN - port based	Yes	Yes
• VLAN dynamic	Yes	Yes
Number of VLANs maximum	64	64
Number of VLANs - dynamic maximum	64	64
Protocol is supported GVRP	Yes	Yes
<b>Product functions DHCP</b>		
Product function		
• DHCP client	Yes	Yes
• DHCP Option 82	Yes	Yes
• DHCP Option 66	Yes	Yes
• DHCP Option 67	Yes	Yes
<b>Product functions Routing</b>		
Product function		
• static IP routing	No	Yes
• dynamic IP routing	No	Yes
Protocol is supported		
• RIPv2	No	Yes
• OSPFv2	No	Yes
• VRRP	No	Yes

## PROFINET/Industrial Ethernet

### Industrial Ethernet Layer 3 Switches / Routers

#### SCALANCE X-400 managed

#### Technical specifications (continued)

Article No.	6GK5408-2FD00-2AA2	6GK5414-3FC00-2AA2
Product-type designation	SCALANCE X408-2	SCALANCE X414-3E
<b>Product functions Redundancy</b>		
Product function		
• Ring redundancy	Yes	Yes
• Redundancy manager	Yes	Yes
• Standby redundancy	Yes	Yes
• High Speed Redundancy Protocol (HRP)	Yes	Yes
• Media Redundancy Protocol (MRP)	Yes	Yes
• Redundancy procedure STP	Yes	Yes
• RSTP redundancy protocol	Yes	Yes
• Redundancy procedure MSTP	Yes	No
• Passive listening	Yes	Yes
Protocol is supported		
• STP/RSTP	Yes	Yes
• STP	Yes	Yes
• RSTP	Yes	Yes
• RSTP big network support	Yes	Yes
• LACP	Yes	Yes
<b>Product functions Security</b>		
Product function		
• ACL - MAC-based	Yes	Yes
• ACL - port/MAC-based	Yes	Yes
• IEEE 802.1x (radius)	Yes	Yes
• Broadcast/Multicast/Unicast Limiter	Yes	Yes
• broadcast blocking	Yes	Yes
Protocol is supported SSH	Yes	Yes
<b>Product functions Time</b>		
Product function SICLOCK support	Yes	Yes
Protocol is supported		
• NTP	No	No
• SNTP	Yes	Yes
<b>Standards, specifications, approvals</b>		
Standard		
• for EMC from FM	FM3611: Class 1, Division 2, Group A, B, C, D / T4 A, Class 1, Zone 2, Group IIC, T4	FM3611: Class 1, Division 2, Group A, B, C, D / T4 A, Class 1, Zone 2, Group IIC, T4
• for hazardous zone	EN 60079-0: 2006, EN 60079-15: 2005, II 3 G Ex nA IIT4, KEMA 07 ATEX 0145 X	EN 60079-0: 2006, EN 60079-15: 2005, II 3 G Ex nA IIT4, KEMA 07 ATEX 0145 X
• for safety of CSA and UL	UL 60950-1, CSA C22.2 No. 60950-1-03	UL 60950-1, CSA C22.2 No. 60950-1-03
• for hazardous area of CSA and UL	UL 1604 and UL 2279-15 (Hazardous Location), Class 1 / Division 2 / Group A, B, C, D / T4, Class 1 / Zone 2 / Group IIC / T4	UL 1604 and UL 2279-15 (Hazardous Location), Class 1 / Division 2 / Group A, B, C, D / T4, Class 1 / Zone 2 / Group IIC / T4
• for emitted interference	EN 61000-6-4:2001 (Class A)	EN 61000-6-4:2001 (Class A)
• for interference immunity	EN 61000-6-2:2001	EN 61000-6-2:2001
Verification of suitability	EN 61000-6-2:2001, EN 61000-6-4:2001	EN 61000-6-2:2001, EN 61000-6-4:2001
• CE mark	Yes	Yes
• C-Tick	Yes	Yes
• KC approval	Yes	Yes
Marine classification association		
• American Bureau of Shipping Europe Ltd. (ABS)	Yes	Yes
• Bureau Veritas (BV)	Yes	Yes
• Det Norske Veritas (DNV)	Yes	Yes
• Germanische Lloyd (GL)	Yes	Yes
• Lloyds Register of Shipping (LRS)	Yes	Yes
• Nippon Kaiji Kyokai (NK)	Yes	Yes

**Technical specifications (continued)**

Article No.	6GK5492-2AL00-8AA2	6GK5492-2AM00-8AA2	6GK5492-2AN00-8AA2	6GK5492-2AP00-8AA2	6GK5492-2AQ00-8AA2
Product-type designation	MM492-2	MM492-2LD	MM492-2LH	MM492-2LH+	MM492-2ELH
<b>Interfaces</b>					
Number of electrical/optical connections for network components or terminal equipment maximum	2	2	2	2	2
Number of 1 000 Mbit/s SC ports (LX)	-	2	2	2	2
Number of 1 000 Mbit/s SC ports (SX)	2	-	-	-	-
Design of optical connections for network components or terminal devices	SC	SC	SC	SC	SC
Connectable optical power relative to 1 mW					
• of the transmitter output	-9.5 ... -4 dB	-9.5 ... -3 dB	-6 ... +0 dB	0 ... 5 dB	0 ... 5 dB
• of the receiver input maximum	-3 dB	-3 dB	-3 dB	-3 dB	-3 dB
Optical sensitivity relative to 1 mW of the receiver input minimum	-17 dB	-21 dB	-23 dB	-23 dB	-30 dB
Attenuation of fiber-optic cable transmission link minimum necessary	0 dB	0 dB	3 dB	8 dB	8 dB
Range at the optical interface depending on the optical fiber used	0 ... 0.75 km	0 ... 10 km	8 ... 40 km	30 ... 70 km	37 ... 120 km
<b>Permitted ambient conditions</b>					
Ambient temperature					
• during operating	-40 ... +70 °C	-40 ... +70 °C	-40 ... +70 °C	-40 ... +70 °C	-40 ... +70 °C
• during storage	-40 ... +80 °C	-40 ... +80 °C	-40 ... +80 °C	-40 ... +80 °C	-40 ... +80 °C
• during transport	-40 ... +80 °C	-40 ... +80 °C	-40 ... +80 °C	-40 ... +80 °C	-40 ... +80 °C
Relative humidity at 25 °C without condensation during operating maximum	95 %	95 %	95 %	95 %	95 %
Protection class IP	IP20	IP20	IP20	IP20	IP20
<b>Design, dimensions and weight</b>					
Design	Media module	Media module	Media module	Media module	Media module
Width	35 mm	35 mm	35 mm	35 mm	35 mm
Height	145 mm	145 mm	145 mm	145 mm	145 mm
Depth	90 mm	90 mm	90 mm	90 mm	90 mm
Net weight	0.25 kg	0.25 kg	0.25 kg	0.25 kg	0.25 kg
Mounting type	Yes	Yes	Yes	Yes	Yes
Installation in media module slot					
Mounting type	Latched	Latched	Latched	Latched	Latched
<b>Standards, specifications, approvals</b>					
Standard					
• for EMC	-	-	-	-	-
• for EMC from FM	FM3611: Class 1, Division 2, Group A, B, C, D / T4, Class 1, Zone 2, Group IIC, T4	FM3611: Class 1, Division 2, Group A, B, C, D / T4, Class 1, Zone 2, Group IIC, T4	FM3611: Class 1, Division 2, Group A, B, C, D / T4, Class 1, Zone 2, Group IIC, T4	FM3611: Class 1, Division 2, Group A, B, C, D / T4, Class 1, Zone 2, Group IIC, T4	FM3611: Class 1, Division 2, Group A, B, C, D / T4, Class 1, Zone 2, Group IIC, T4
• for hazardous zone	EN 60079-0: 2006, EN 60079-15: 2005, II 3 G Ex nA II T4, KEMA 07 ATEX 0145 X	EN 60079-0: 2006, EN 60079-15: 2005, II 3 G Ex nA II T4, KEMA 07 ATEX 0145 X	EN 60079-0: 2006, EN 60079-15: 2005, II 3 G Ex nA II T4, KEMA 07 ATEX 0145 X	EN 60079-0: 2006, EN 60079-15: 2005, II 3 G Ex nA II T4, KEMA 07 ATEX 0145 X	EN 60079-0: 2006, EN 60079-15: 2005, II 3 G Ex nA II T4, KEMA 07 ATEX 0145 X
• for safety of CSA and UL	UL 60950-1, CSA C22.2 No. 60950-1-03	UL 60950-1, CSA C22.2 No. 60950-1-03	UL 60950-1, CSA C22.2 No. 60950-1-03	UL 60950-1, CSA C22.2 No. 60950-1-03	UL 60950-1, CSA C22.2 No. 60950-1-03
• for hazardous area of CSA and UL	UL 1604 and UL 2279-15 (Hazardous Location), Class 1 / Division 2 / Group A, B, C, D / T4, Class 1 / Zone 2 / Group IIC / T4	UL 1604 and UL 2279-15 (Hazardous Location), Class 1 / Division 2 / Group A, B, C, D / T4, Class 1 / Zone 2 / Group IIC / T4	UL 1604 and UL 2279-15 (Hazardous Location), Class 1 / Division 2 / Group A, B, C, D / T4, Class 1 / Zone 2 / Group IIC / T4	UL 1604 and UL 2279-15 (Hazardous Location), Class 1 / Division 2 / Group A, B, C, D / T4, Class 1 / Zone 2 / Group IIC / T4	UL 1604 and UL 2279-15 (Hazardous Location), Class 1 / Division 2 / Group A, B, C, D / T4, Class 1 / Zone 2 / Group IIC / T4
• for emitted interference	EN 61000-6-4:2001 (Class A)	EN 61000-6-4:2001 (Class A)	EN 61000-6-4:2001 (Class A)	EN 61000-6-4:2001 (Class A)	EN 61000-6-4:2001 (Class A)
• for interference immunity	EN 61000-6-2:2001	EN 61000-6-2:2001	EN 61000-6-2:2001	EN 61000-6-2:2001	EN 61000-6-2:2001

## PROFINET/Industrial Ethernet

### Industrial Ethernet Layer 3 Switches / Routers

#### SCALANCE X-400 managed

#### Technical specifications (continued)

Article No.	6GK5492-2AL00-8AA2	6GK5492-2AM00-8AA2	6GK5492-2AN00-8AA2	6GK5492-2AP00-8AA2	6GK5492-2AQ00-8AA2
Product-type designation	MM492-2	MM492-2LD	MM492-2LH	MM492-2LH+	MM492-2ELH
Verification of suitability	EN 61000-6-2:2001, EN 61000-6-4:2001	EN 61000-6-2:2001, EN 61000-6-4:2001	EN 61000-6-2:2001, EN 61000-6-4:2001	EN 61000-6-2:2001, EN 61000-6-4:2001	EN 61000-6-2:2001, EN 61000-6-4:2001
• CE mark	Yes	Yes	Yes	Yes	-
• C-Tick	Yes	Yes	Yes	Yes	-
• KC approval	Yes	Yes	Yes	Yes	Yes
• Railway application in accordance with EN 50155	-	-	-	-	-
• Railway application in accordance with EN 50124-1	-	-	-	-	-
• IEC 61850-3	-	-	-	-	-
Marine classification association					
• American Bureau of Shipping Europe Ltd. (ABS)	Yes	Yes	Yes	Yes	Yes
• Bureau Veritas (BV)	Yes	Yes	Yes	Yes	Yes
• Det Norske Veritas (DNV)	Yes	Yes	Yes	Yes	Yes
• Germanische Lloyd (GL)	Yes	Yes	Yes	Yes	Yes
• Lloyds Register of Shipping (LRS)	Yes	Yes	Yes	Yes	Yes
• Nippon Kaiji Kyokai (NK)	Yes	Yes	Yes	Yes	Yes

Article No.	6GK5491-2AB00-8AA2	6GK5491-2AC00-8AA2	6GK5491-2AE00-8AA2
Product-type designation	MM491-2	MM491-2LD	MM491-2LH+
<b>Interfaces</b>			
Number of electrical/optical connections for network components or terminal equipment maximum	2	2	2
Number of 100 Mbit/s ST(BFOC) ports	2	2	-
Number of 100 Mbit/s SC ports	-	-	2
Design of optical connections for network components or terminal devices	BFOC	BFOC	SC
Connectable optical power relative to 1 mW			
• of the transmitter output	-19 ... -14 dB	-15 ... -8 dB	-5 ... +0 dB
• of the receiver input maximum	-3 dB	-3 dB	-3 dB
Optical sensitivity relative to 1 mW of the receiver input minimum	-32 dB	-34 dB	-34 dB
Attenuation of fiber-optic cable transmission link minimum necessary	0 dB	0 dB	3 dB
Range at the optical interface depending on the optical fiber used	0 ... 5 km	0 ... 26 km	12 ... 70 km
<b>Permitted ambient conditions</b>			
Ambient temperature			
• during operating	-40 ... +70 °C	-40 ... +70 °C	-40 ... +70 °C
• during storage	-40 ... +80 °C	-40 ... +80 °C	-40 ... +80 °C
• during transport	-40 ... +80 °C	-40 ... +80 °C	-40 ... +80 °C
Relative humidity at 25 °C without condensation during operating maximum	95 %	95 %	95 %
Protection class IP	IP20	IP20	IP20

### Technical specifications (continued)

Article No.	6GK5491-2AB00-8AA2	6GK5491-2AC00-8AA2	6GK5491-2AE00-8AA2
Product-type designation	MM491-2	MM491-2LD	MM491-2LH+
<b>Design, dimensions and weight</b>			
Design	Media module	Media module	Media module
Width	35 mm	35 mm	35 mm
Height	145 mm	145 mm	145 mm
Depth	90 mm	90 mm	90 mm
Net weight	0.26 kg	0.26 kg	0.26 kg
Mounting type	Yes	Yes	Yes
Installation in media module slot			
Mounting type	Latched	Latched	Latched
<b>Standards, specifications, approvals</b>			
Standard	-	-	-
• for EMC			
• for EMC from FM	FM3611: Class 1, Division 2, Group A, B, C, D / T4, Class 1, Zone 2, Group IIC, T4	FM3611: Class 1, Division 2, Group A, B, C, D / T4, Class 1, Zone 2, Group IIC, T4	FM3611: Class 1, Division 2, Group A, B, C, D / T4, Class 1, Zone 2, Group IIC, T4
• for hazardous zone	EN 60079-0: 2006, EN 60079-15: 2005, II 3 G Ex nA II T4, KEMA 07 ATEX 0145 X	EN 60079-0: 2006, EN 60079-15: 2005, II 3 G Ex nA II T4, KEMA 07 ATEX 0145 X	EN 60079-0: 2006, EN 60079-15: 2005, II 3 G Ex nA II T4, KEMA 07 ATEX 0145 X
• for safety of CSA and UL	UL 60950-1, CSA C22.2 No. 60950-1-03	UL 60950-1, CSA C22.2 No. 60950-1-03	UL 60950-1, CSA C22.2 No. 60950-1-03
• for hazardous area of CSA and UL	UL 1604 and UL 2279-15 (Hazardous Location), Class 1 / Division 2 / Group A, B, C, D / T4, Class 1 / Zone 2 / Group IIC / T4	UL 1604 and UL 2279-15 (Hazardous Location), Class 1 / Division 2 / Group A, B, C, D / T4, Class 1 / Zone 2 / Group IIC / T4	UL 1604 and UL 2279-15 (Hazardous Location), Class 1 / Division 2 / Group A, B, C, D / T4, Class 1 / Zone 2 / Group IIC / T4
• for emitted interference	EN 61000-6-4:2001 (Class A)	EN 61000-6-4:2001 (Class A)	EN 61000-6-4:2001 (Class A)
• for interference immunity	EN 61000-6-2:2001	EN 61000-6-2:2001	EN 61000-6-2:2001
Verification of suitability	EN 61000-6-2:2001, EN 61000-6-4:2001	EN 61000-6-2:2001, EN 61000-6-4:2001	EN 61000-6-2:2001, EN 61000-6-4:2001
• CE mark	Yes	Yes	Yes
• C-Tick	Yes	Yes	Yes
• KC approval	Yes	Yes	Yes
Marine classification association			
• American Bureau of Shipping Europe Ltd. (ABS)	Yes	Yes	Yes
• Bureau Veritas (BV)	Yes	Yes	Yes
• Det Norske Veritas (DNV)	Yes	Yes	Yes
• Germanische Lloyd (GL)	Yes	Yes	Yes
• Lloyds Register of Shipping (LRS)	Yes	Yes	Yes
• Nippon Kaiji Kyokai (NK)	Yes	Yes	Yes

## PROFINET/Industrial Ethernet

### Industrial Ethernet Layer 3 Switches / Routers

#### SCALANCE X-400 managed

#### Technical specifications (continued)

Article No.	6GK5495-8BA00-8AA2	6GK5496-4MA00-8AA2
Product-type designation	EM495-8	EM496-4
<b>Interfaces</b>		
Number of electrical/optical connections for network components or terminal equipment maximum	8	8
Number of electrical connections		
• for network components or terminal equipment maximum	8	-
• for media module	-	4
Number of 10/100 Mbit/s RJ45 ports	8	-
Design of electrical connection for network components and terminal equipment	RJ45	-
<b>Permitted ambient conditions</b>		
Ambient temperature		
• during operating	-40 ... +70 °C	-40 ... +70 °C
• during storage	-40 ... +80 °C	-40 ... +80 °C
• during transport	-40 ... +80 °C	-40 ... +80 °C
Relative humidity at 25 °C without condensation during operating maximum	95 %	95 %
Protection class IP	IP20	IP20
<b>Design, dimensions and weight</b>		
Design	Extender-Module	Extender-Module
Width	112.4 mm	112.4 mm
Height	86 mm	154 mm
Depth	145 mm	145 mm
Net weight	0.56 kg	0.98 kg
Mounting type	Latched	Latched
<b>Standards, specifications, approvals</b>		
Standard		
• for EMC	-	-
• for EMC from FM	FM3611: Class 1, Division 2, Group A, B, C, D / T4, Class 1, Zone 2, Group IIC, T4	FM3611: Class 1, Division 2, Group A, B, C, D / T4, Class 1, Zone 2, Group IIC, T4
• for hazardous zone	EN 60079-0: 2006, EN 60079-15: 2005, II 3 G Ex nA II T4, KEMA 07 ATEX 0145 X	EN 60079-0: 2006, EN 60079-15: 2005, II 3 G Ex nA II T4, KEMA 07 ATEX 0145 X
• for safety of CSA and UL	UL 60950-1, CSA C22.2 No. 60950-1-03	UL 60950-1, CSA C22.2 No. 60950-1-03
• for hazardous area of CSA and UL	UL 1604 and UL 2279-15 (Hazardous Location), Class 1 / Division 2 / Group A, B, C, D / T4, Class 1 / Zone 2 / Group IIC / T4	UL 1604 and UL 2279-15 (Hazardous Location), Class 1 / Division 2 / Group A, B, C, D / T4, Class 1 / Zone 2 / Group IIC / T4
• for emitted interference	EN 61000-6-4:2001 (Class A)	EN 61000-6-4:2001 (Class A)
• for interference immunity	EN 61000-6-2:2001	EN 61000-6-2:2001
Verification of suitability	EN 61000-6-2:2001, EN 61000-6-4:2001	EN 61000-6-2:2001, EN 61000-6-4:2001
• CE mark	Yes	Yes
• C-Tick	Yes	Yes
• KC approval	Yes	Yes
Marine classification association		
• American Bureau of Shipping Europe Ltd. (ABS)	Yes	Yes
• Bureau Veritas (BV)	Yes	Yes
• Det Norske Veritas (DNV)	Yes	Yes
• Germanische Lloyd (GL)	Yes	Yes
• Lloyds Register of Shipping (LRS)	Yes	Yes
• Nippon Kaiji Kyokai (NK)	Yes	Yes



## Ordering data

## Article No.

## Article No.

**Industrial Ethernet Switches SCALANCE X-400**

Modular Industrial Ethernet switches with integrated RJ45 ports for setting up electrical and/or optical Industrial Ethernet networks; integrated redundancy manager, IT functions (RSTP, VLAN, ...), PROFINET IO device, network management via SNMP and web server; incl. operating instructions, Industrial Ethernet network manual and configuration software on CD-ROM; C-PLUG included in the scope of delivery

- **SCALANCE X408-2;**  
4 x 10/100/1 000 Mbit/s and 4 x 10/100 Mbit/s RJ45 ports; 2 x Gigabit/Fast Ethernet media module slots
- **SCALANCE X414-3E;**  
8 x 10/100/1 000 Mbit/s, of which 8 x RJ45/SFP combo ports; 8 x 1 000 Mbit/s can be maximally used in the basic device  
24 x 1 000 Mbit/s maximum overall configuration by using port extenders

6GK5408-2FD00-2AA2

6GK5414-3FC00-2AA2

**MM491/MM492 media modules**

Media modules with 2 ports;  
1 Gbit/s

**MM492-2;**  
1000BaseSX, SC connection, multimode FOC up to 750 m

6GK5492-2AL00-8AA2

**MM492-2LD;**  
1000BaseLX, SC connection, single-mode FOC up to 10 km

6GK5492-2AM00-8AA2

**MM492-2LH;**  
1000BaseLX, SC connection, single-mode FOC up to 40 km

6GK5492-2AN00-8AA2

**MM492-2LH+;**  
1000BaseLX, SC connection, single-mode FOC up to 70 km

6GK5492-2AP00-8AA2

**MM492-2ELH;**  
1000BaseLX, SC connection, single-mode FOC up to 120 km

6GK5492-2AQ00-8AA2

Media modules with 2 ports;  
100 Mbit/s

**MM491-2;**  
100BaseLX, BFOC interface, multimode FOC up to 5 km

6GK5491-2AB00-8AA2

**MM491-2LD;**  
100BaseFX, BFOC interface, singlemode FOC up to 26 km

6GK5491-2AC00-8AA2

**MM491-2LH+;**  
100BaseFX, SC connection, single-mode FOC up to 70 km

6GK5491-2AE00-8AA2

**EM495/EM496 extender modules**

Extender modules  
for SCALANCE X414-3E

**EM495-8;**  
with 8 x 10/100 Mbit/s TP ports

6GK5495-8BA00-8AA2

**EM496-4;**  
with 4 slots for 100 Mbit/s media modules MM

6GK5496-4MA00-8AA2

**Accessories****IE FC TP Standard Cable GP 2 x 2 (Type A)**

6XV1840-2AH10

4-core, shielded TP installation cable for connection to IE FC Outlet RJ45/IE FC RJ45 Plug; PROFINET-compatible; with UL approval; sold by the meter; max. length 1 000 m, minimum order quantity 20 m

**IE FC TP Standard Cable GP 4 x 2**

6XV1870-2E

8-core, shielded TP installation cable for connection to IE FC RJ45 modular outlet for universal application; with UL approval; sold by the meter; max length 1 000 m, minimum order 20 m

**IE TP Cord RJ45/RJ45**

TP cable 4 x 2  
with two RJ45 connectors

- 0.5 m
- 1 m
- 2 m
- 6 m
- 10 m

6XV1870-3QE50  
6XV1870-3QH10  
6XV1870-3QH20  
6XV1870-3QH60  
6XV1870-3QN10

**FO standard cable GP 5 0/125/1400<sup>1) 2)</sup>**

6XV1873-2A

Multimode cable,  
sold by the meter;  
max. length 1 000 m;  
minimum order 20 m;

**FO robust cable GP 4E9/125/90**

6XV1843-2R

Single-mode cable,  
sold by the meter;  
max. length 1 000 m;  
minimum order 20 m

**FC FO standard cable GP 62.5/200/230**

6XV1847-2A

FC FO standard cable for fixed routing indoors with PVC sheath;  
sold by the meter  
max. length 1 000 m;  
minimum order 20 m

**IE FC RJ45 Plug 180 2 x 2**

RJ45 plug connector for Industrial Ethernet with a rugged metal enclosure and integrated insulation/displacement contacts for connecting Industrial Ethernet FC installation cables; with 180° cable outlet; for network components and CPs/CPUs with Industrial Ethernet interface

- 1 pack = 1 unit
- 1 pack = 10 units
- 1 pack = 50 units

6GK1901-1BB10-2AA0  
6GK1901-1BB10-2AB0  
6GK1901-1BB10-2AE0

<sup>1)</sup> Special fiber-optic cables, lengths and accessories available on request

<sup>2)</sup> Special tools and trained personnel are required for pre-assembling glass fiber-optic cables

## PROFINET/Industrial Ethernet

### Industrial Ethernet Layer 3 Switches / Routers

#### SCALANCE X-400 managed

##### Ordering data

##### Article No.

###### Accessories (continued)

###### IE FC RJ45 plug 4 x 2

RJ45 plug connector for Industrial Ethernet (10/100/1 000 Mbit/s) with a rugged metal enclosure and integrated insulation displacement contacts for connecting Industrial Ethernet FC installation cables; 180° cable outlet; for network components and CPs/CPUs with Industrial Ethernet interface

- 1 pack = 1 unit
- 1 pack = 10 units
- 1 pack = 50 units

**6GK1901-1BB11-2AA0**  
**6GK1901-1BB11-2AB0**  
**6GK1901-1BB11-2AE0**

###### FC BFOC Plug

Screw connector for on-site assembly on FC fiber-optic cable; (1 pack = 20 units + cleaning cloths)

**6GK1900-1GB00-0AC0**

###### FC SC plug

Screw connector for on-site assembly on FC fiber-optic cable; (1 pack = 10 Duplex Plugs + cleaning cloths)

**6GK1900-1LB00-0AC0**

###### IE FC stripping tool

Preadjusted stripping tool for fast stripping of the Industrial Ethernet FC cables

**6GK1901-1GA00**

###### FC FO termination kit

Assembly case for local assembly of FC SC and FC BFOC connectors to FC FO standard cable, comprising a stripping tool, Kevlar cutters, fiber breaking tool and microscope

**6GK1900-1GL00-0AA0**

###### IE FC RJ45 modular outlet

FastConnect RJ45 outlet for Industrial Ethernet with interface for a replaceable insert;

- **With insert 2FE;** replaceable insert for 2 x 100 Mbit/s interfaces
- **With insert 1GE;** replaceable insert for 1 x 1 000 Mbit/s interfaces

**6GK1901-1BE00-0AA1**

**6GK1901-1BE00-0AA2**

###### SITOP compact, 2.5 A

1-phase power supply with wide-range input 85 – 264 V AC, regulated output voltage 24 V, output current rated value 2.5 A

**6EP1332-5BA00**

###### Spare parts

###### CV490 cover set

consisting of covers for:  
 1 x Gbit submodule slot,  
 2 x 100 Mbit/s submodule slot,  
 3 x 10/100 Mbit/s TP slot, 1x cover

**6GK5490-0AA00-0AA2**

###### Labeling sheet

10 DIN A4 sheets, petrol blue, with 10 strips each, perforated, for printing using a standard laser printer

**6GK5498-0AA00-0AA0**

###### 4-pole and 5-pole terminal set

20-part, comprising 10x 4-pole and 10 x 5-pole terminals, straight, with latch

**6GK5498-1AA00-0AA0**

##### More information

###### Selection tools:

To assist in selecting the right Industrial Ethernet switches as well as configuration of modular variants, the SIMATIC NET Selection Tool and the TIA Selection Tool are available at:

SIMATIC NET Selection Tool:

- Online version:  
<http://www.siemens.com/snst>
- Offline version:  
<http://www.siemens.com/snst-download>

TIA Selection Tool:

<http://www.siemens.com/tia-selection-tool>

### Overview



The new SCALANCE XM-400 product range comprises modular Industrial Ethernet switches, expandable by various port extenders and plug-in transceivers for a maximum configuration with up to 24 ports. It supports 10/100/1 000 Mbit technology for various transmission media (twisted pair, fiber optic) and increased port requirements. The main applications are high-performance plant networks (control level). Thanks to the flexible, modular design, the XM-400 product line is also designed for future requirements and can be adapted to the relevant task.

The new XM-400 range replaces the previous X-400 range (X414-3E and X408-2).

- Combo ports for the flexible use of interfaces: A combo port consists of an electric port and an SFP slot. Only one of the two ports can ever be active. If an SFP plug-in transceiver is inserted, the electric port is deactivated
- Fast mobile diagnosis with smartphone/tablet thanks to WLAN and NFC: Fast access to the web-based management of the SCALANCE XM-400 via mobile websites. The function can be started using existing WLAN and NFC (Near Field Communication)
- High-speed media redundancy through integral redundancy manager even for large networks, for both Gigabit Ethernet and Fast Ethernet
- Remote diagnostics by means of PROFINET diagnostics, CLI, Web browser, or SNMP
- Integration into the TIA Portal including up/downloading of the configuration
- Seamless integration of automation networks into existing corporate networks thanks to support for a host of IT standards: Establishment of virtual networks (VLANs)
- Integration into higher-level enterprise networks thanks to support for standardized redundancy procedures (Rapid Spanning Tree Protocol, Link Aggregation)
- By learning the multicast sources and destinations (Internet Group Management Protocol (IGMP) Snooping), SCALANCE XM-400 switches can also filter multicast data traffic and thus limit the load on the network.
- Optional activation of the Layer 3 functions for IPv4 (IPv6 available soon) in connection with the KEY-PLUG XM-400. For a detailed description, see "Accessories for Layer 3 switches/routers"
- Creation of IP subnets and IP router communication by means of Layer 3 switching (IP routing)
  - Static routing
  - Dynamic routing OSPF (Open Shortest Path First) and RIPv2 (Routing Information Protocol)
  - Redundant routing VRRP (Virtual Router Redundancy Protocol)

### Product versions – basic devices

Basic devices with eight to 16 integrated Gigabit Ethernet twisted pair interfaces (10/100/1 000 Mbit/s)

#### XM416-4C

- 16 ports available in total, of which
  - up to 16 x 10/100/1 000 Mbit/s are RJ45 ports with retaining collars
  - up to 4 x SFP slots (combo ports), 100 or 1 000 Mbit/s
- A port extender with 8 ports can be connected to implement a maximum of 24 ports in one switch

#### XM408-8C

- 8 ports available in total, of which
  - up to 8 x 10/100/1 000 Mbit/s are RJ45 ports with retaining collars
  - up to 8 x SFP slots (combo ports), 100 or 1 000 Mbit/s
- Two port extenders with 8 ports each can be connected to implement a maximum of 24 ports in one switch

#### XM408-4C

- 8 ports available in total, of which
  - up to 8 x 10/100/1 000 Mbit/s are RJ45 ports with retaining collars
  - up to 4 x pluggable slots (combo ports) for SC connection method (1 000 Mbit/s) or BFOC connection method (100 Mbit/s)
- Two port extenders with 8 ports each can be connected to implement a maximum of 24 ports in one switch

## PROFINET/Industrial Ethernet

### Industrial Ethernet Layer 3 Switches / Routers

#### SCALANCE XM-400 managed

2



#### Product versions – port extender

Port extender for flexible expansion to up to 24 ports can be connected to the basic device.

##### PE408

- 8 x 10/100/1 000 Mbit/s RJ45 ports with retaining collars for expanding an XM-400 basic device to a maximum of 24 ports

##### PE400-8SFP

- 8 x SFP slots for expanding an XM-400 basic device to a maximum of 24 ports, 100 or 1 000 Mbit/s

##### PE408PoE

- 8 x 10/100/1 000 Mbit/s RJ45 ports with retaining collars with PoE according to IEEE 802.3at Type 2 for expanding an XM-400 basic device to a maximum of 24 ports
- Separate power supply required

#### Benefits

get Designed for Industry

- Modular system offers cost savings. The modular system allows the setup of electrical and optical Industrial Ethernet networks and the network topology and port type to easily be adapted to the plant structure and expanded at any time
- Integrated industrial network for data, speech, and video
- High performance due to up to 24 Gigabit ports
- Operational reliability in industrial environments, e.g. due to robust enclosure, redundancy, temperature range from - 40 °C to +70 °C
- Increased plant availability thanks to:
  - Redundant power supply
  - Redundant network structures based on fast media redundancy
  - Standby redundancy between ring topologies
  - Redundant switching through standard mechanisms STP, RSTP, MSTP
  - Redundant router operation through VRRP
  - Media modules can be replaced or expanded during operation
  - Easy device replacement due to plug-in KEY-PLUG/C-PLUG swap media
- Virtual LANs (VLAN) allow simple subdivision of large networks into smaller subnets with their own address space. Reasons for subdivision into subnets include separation of the Ethernet networks to reduce the broadcast load, separation of sensitive areas from the main network, and subdivision of the network into logical working groups. Communication between the VLANs can, however, be achieved with Layer-3-Switching (IP routing)
- Integrated and optional security functions offer protection against unauthorized network access and configuration
- Simple monitoring and diagnosis by means of signaling contact, SNMP traps, PROFINET diagnosis, and email function
- Reduced engineering expenditure for PLC/HMI due to integration into the SIMATIC system fault message concept
- Integrated configuration and diagnostics in the TIA Portal
- Fast mobile diagnostics with smartphone/tablet thanks to WLAN and NFC (Near Field Communication): Fast access to the web-based management of the SCALANCE XM-400 via mobile websites. The function can be started using existing WLAN and NFC.



### Benefits (continued)

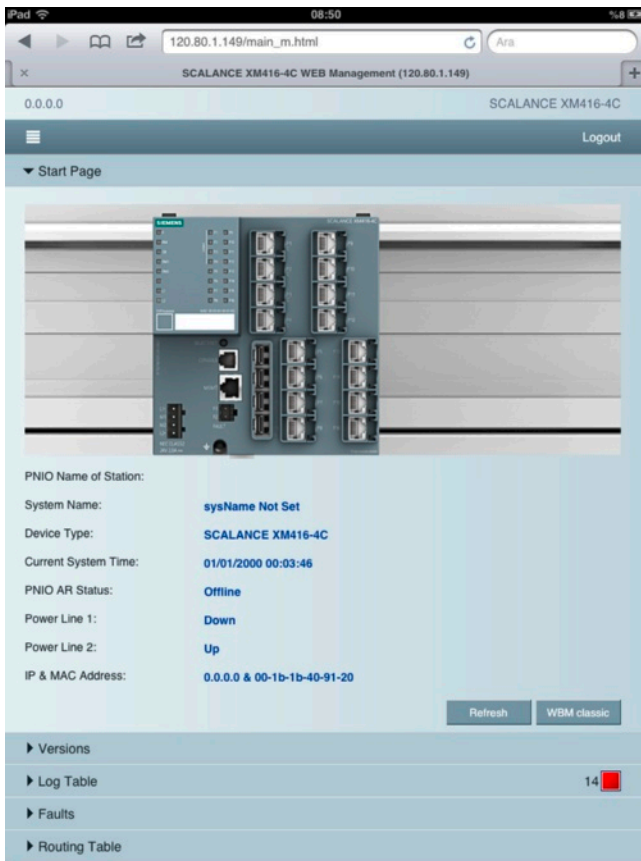

### Application

SCALANCE XM-400 products permit the configuration of switched networks at the control level, which not only demands high availability of the network and extensive diagnostic options, but also a high number of ports, high transfer rate, and the support of fiber-optic and copper cables and Power over Ethernet transmission.

Thanks to the scalability of the basic unit and the optionally available Layer 3 switching function, the network can be established specially for the relevant application or expanded at any time.

### Design

#### SCALANCE XM-400

SCALANCE XM-400 with up to 24 Gigabit ports is an Industrial Ethernet switch with robust, industry-standard enclosure, for mounting onto standard rails, and designed IP20 protection.

SCALANCE XM-400 basic devices offer the following additional interfaces

- Console port (serial interface RJ11) and management port (100 Mbit/s, RJ45) for on-site parameterization/diagnostics and firmware update
- Slot for optional C-PLUG swap medium for simple device replacement (included in scope of delivery) or KEY-PLUG for optional software expansion to Layer-3 Switching
- Floating signaling contact can be freely configured to indicate fault events, for example
- Extensive operating mode and status information is displayed via LEDs and selection pushbuttons
- Grounding bolts for defined ground connection
- Two infeeds are available for protection against voltage failure
- Connection for a port extender on the right (tool-free installation)

#### Product versions of SFP pluggable transceivers

The SFP (Small Formfactor Pluggable) plug-in transceivers can be used in the SFP slots.

##### Optical SFP pluggable transceivers with 1 x 100 Mbit/s LC port.

- SFP991-1 multimode, glass, up to 5 km
- SFP991-1LD singlemode, glass, up to 26 km
- SFP991-1LH+ singlemode, glass, up to 70 km
- SFP991-1ELH200 singlemode, glass, up to 200 km max.

##### Optical SFP pluggable transceivers with 1 x 1 000 Mbit/s LC port

- SFP992-1 multimode, glass, up to 750 m
- SFP992-1LD singlemode, glass, up to 10 km
- SFP992-1LH singlemode, glass, up to 40 km
- SFP992-1LH+ singlemode, glass, up to 70 km
- SFP992-1ELH singlemode, glass, up to 120 km

#### KEY-PLUG XM-400



- For activation of the Layer 3 function
- Integrated C-PLUG functionality (configuration memory)

## PROFINET/Industrial Ethernet

### Industrial Ethernet Layer 3 Switches / Routers

#### SCALANCE XM-400 managed

#### Function

- Fast redundancy in the ring;  
A redundant network structure is created by inter-connecting the ends of an optical line to form a ring. The SCALANCE XM-400 switches have an integral redundancy manager (RM) which monitors the function of the network continuously. It recognizes the failure of a transmission path or the failure of a SCALANCE XM-400 switch in the ring and then activates the substitute path. In rings with SCALANCE X-200 or OSM/ESM, it is possible to integrate XM-400 switches at 100 Mbit/s. In rings with SCALANCE X-300 and SCALANCE XR-500, it is possible to integrate XM-400 switches with Gigabit.
- Fast standby redundancy;  
The integrated standby function permits a reliable interconnection of several rings. Two transmission links are used to connect two XM-400 switches of a ring to the other ring
- Time synchronization;  
diagnostic messages (log table entries, e-mails) are time-stamped. The local time is standardized throughout the network by means of time synchronization with a time server, thereby simplifying the assignment of diagnostic messages of several devices.
- Load limiting when using multicast protocols (e.g. Voice over IP, Video)
- By learning the multicast receivers, XM-400 switches can also filter multicast data traffic and thus limit the load in the network.
- Redundant interfacing to company networks;  
XM-400 switches support the standardized redundancy procedures Spanning Tree Protocol (STP) and Rapid Spanning Tree Protocol (RSTP). This enables a subnetwork to be connected redundantly to a higher level corporate network with reduced requirements for the reconfiguration time (in the order of seconds).
- Support for virtual networks (VLAN);  
For structuring Industrial Ethernet networks with a fast growing number of users, a physically existing network can be divided into several virtual subnets, e.g. to divide the network into logical areas. In this way, very large Ethernet networks can be subdivided into smaller subnets with their own IP address space.
- Support for Quality of Service (QoS) through IP Type of Service (ToS) and prioritizing according to 802.1Q
- Link Aggregation (IEEE 802.3ad) for parallel use of ports to increase the transmission rate and fail-safety.
- Support for port prioritization
- Support for bandwidth limiting (Broadcast Limiter, Multicast Limiter, Unicast Limiter)
- Flow control
- Simple device replacement;  
All settings are automatically backed up on the C-PLUG plug-in swap medium (included in scope of delivery). If a switch of the SCALANCE XM-400 series has to be replaced, then these settings are simply transferred to the replacement device by plugging in the C-PLUG.

#### Additional function through Layer 3 KEY PLUG

- Layer 3 switching support
  - Static routing
  - Dynamic routing
  - Router redundancy
    - The integrated dynamic routing protocols OSPF (Open Shortest Path First) and RIPv2 (Routing Information Protocol) govern the communication to other IP routers in the network.
- Redundant Layer-3 switching (routing) is achieved with the integrated VRRP function (Virtual Router Redundancy Protocol).
- IPv6 support (available soon), support of dual-stack routing (IPv4 / IPv6)

#### Integrated security

- Port security
- Access Control to Agent
- Authentication 802.1X
- SSH
- HTTPS
- SNMPv3
- RADIUS

#### Network topology and network configuration

The network topology can easily be adapted to the structure of the plant with SCALANCE XM-400 Industrial Ethernet switches. The following network structures and combinations of structures can be implemented:

- Gigabit and Fast Ethernet rings with fast media redundancy:  
To protect against the failure of a transmission link or a switch, up to 50 linearly cascaded switches can be interconnected to form a ring. On the failure of a transmission link or of a switch in the ring, the transmission path is reconfigured within 300 milliseconds.
- Several rings can be redundantly linked through the standby function.
- In addition, SCALANCE XM-400 supports redundant connection of the ring structure to the corporate network with a rapid spanning tree.
- Star topology with SCALANCE XM-400 switches:  
The switch represents a neutral star point that can interconnect up to 24 nodes or subnets electrically or optically

When configuring the network, it is necessary to observe the following boundary conditions:

- Maximum line length between two modules for multi-mode fiber-optic conductors:
  - 5 000 m at 100 Mbit/s
  - 750 m at 1 Gbit/s
- Maximum line length between two modules for single-mode fiber-optic conductors:
  - 200 km at 100 Mbit/s
  - 120 km at 1 Gbit/s
- Maximum length of installation cable:
  - 100 m at 100 Mbit/s with IE FC TP Cable 2 x 2 and IE FC Plug 180
  - Max. 90 m at 1 Gbit/s with IE FC TP cable 4 x 2, IE FC RJ45 modular outlet and patch cable (10 m)
  - 100 m at 1 000 Mbit/s with IE FC TP Cable 4 x 2 and IE FC Plug 4 x 2

### Function (continued)

#### Commissioning and diagnosis

- Signal mask;
  - The signal mask is set to the current status of the SCALANCE XM-400 (setpoint state) by pushbutton operation. The signal mask defines which ports and which power supplies are to be monitored. The signal contact only reports an error when a monitored port or a monitored feeder fails (deviation of setpoint/actual status).
- Using a serial interface (RJ11), a PC or a programming device can be connected directly; operation is carried out using commands (Command Line Interface - CLI)
- IP address;
  - the IP address is assigned via DHCP (Dynamic Host Configuration Protocol). If there is no corresponding server in the network, the IP address can be assigned using an enclosed software tool or via the serial console interface (CLI).
- The following status information is displayed by LEDs on site:
  - Port status
  - Port mode (10/100/1 000 Mbit/s, full/half-duplex)
  - Status of the two voltage feeders
  - Signal contact status
  - Signal mask (setpoint status)
  - RM mode
  - Standby mode
- The status of the signal contact is routed externally by means of floating relay contacts. This enables, for example, the module to be monitored via an input module from a controller.
- Redundancy manager RM;
  - To establish a ring, a SCALANCE XM-400 is switched to the RM mode. The non-ring ports of the RM can be used freely for the connection of data terminals and networks. If the redundancy procedure MRP standardized by PROFINET is used, the RM is adjusted automatically.
- Monitoring via the Industrial Ethernet network;
  - the following possibilities are available:
    - via standard browser (Web-based management):
      - Selection of SCALANCE XM-400 switches via the network from a PC with browser
      - via the browser of a mobile device (Smartphone, Tablet)
      - Reading out the address of the mobile website of the XM-400 by means of NFC:
        - mobile terminal starts browser with this address
        - powerful diagnosis by means of an existing WLAN
      - via SNMP V1, V2c, V3:
        - Secure integration of SCALANCE X-400 switches via the network into a network management system, e.g. SINEMA Server
      - via PROFINET IO diagnostics:
        - Standard diagnostic alarms can be configured in an easy, familiar manner in STEP 7 and processed in SIMATIC. The engineering outlay is drastically reduced for the PLC and HMI through complete integration in the SIMATIC system error message concept SFM.

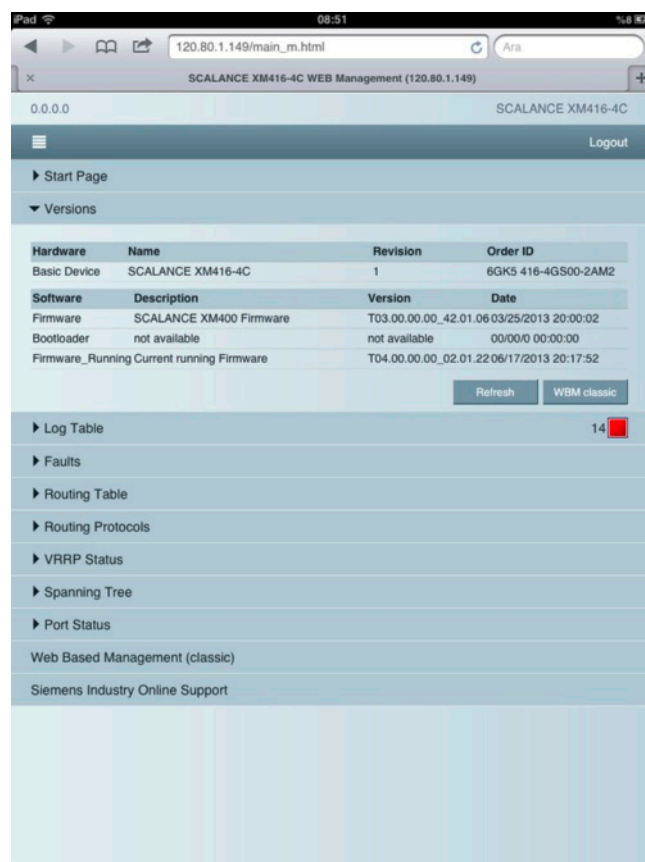
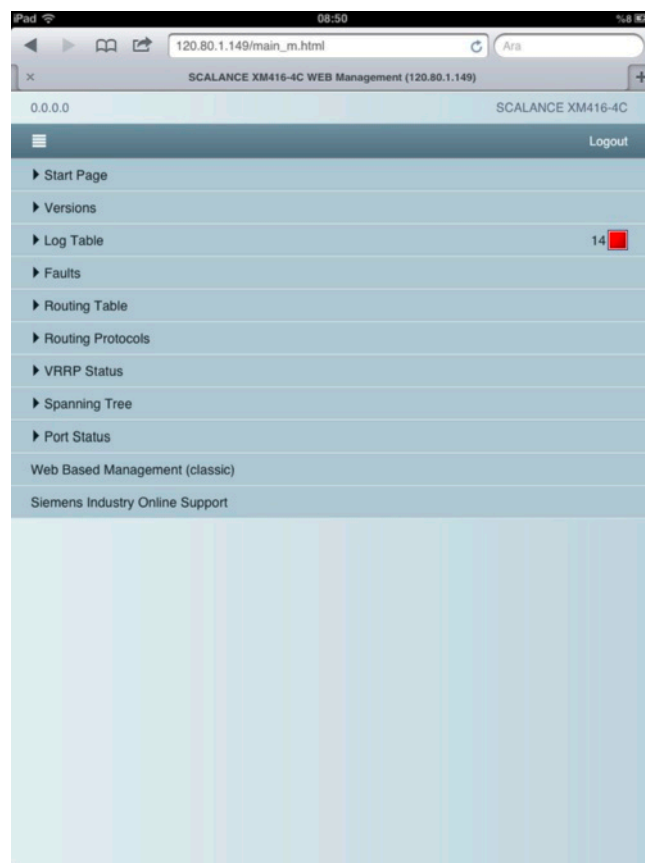

## PROFINET/Industrial Ethernet

### Industrial Ethernet Layer 3 Switches / Routers

#### SCALANCE XM-400 managed

#### Function (continued)

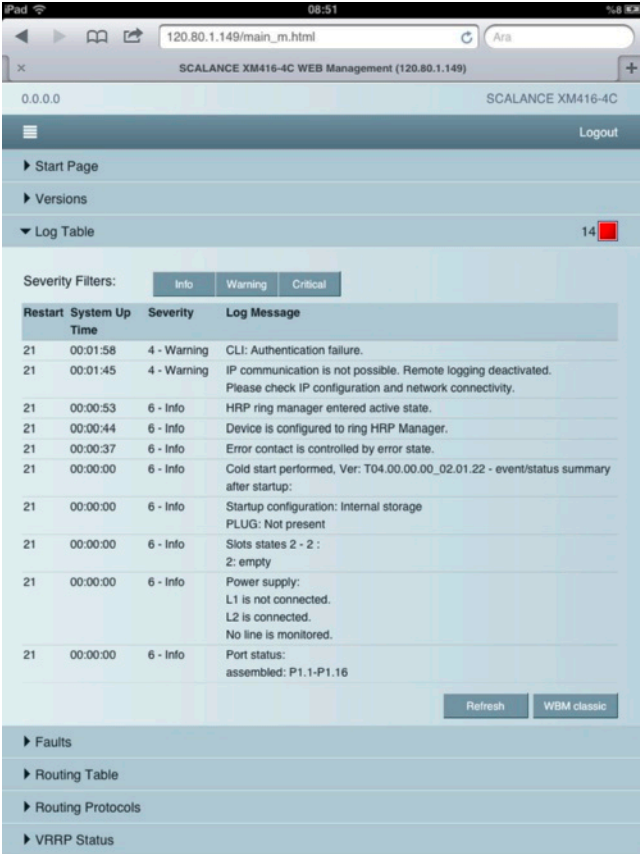

Restart Time	System Up Time	Severity	Log Message
21 00:01:58		4 - Warning	CLI: Authentication failure.
21 00:01:45		4 - Warning	IP communication is not possible. Remote logging deactivated. Please check IP configuration and network connectivity.
21 00:00:53		6 - Info	HRP ring manager entered active state.
21 00:00:44		6 - Info	Device is configured to ring HRP Manager.
21 00:00:37		6 - Info	Error contact is controlled by error state.
21 00:00:00		6 - Info	Cold start performed, Ver: T04.00.00.00_02.01.22 - event/status summary after startup:
21 00:00:00		6 - Info	Startup configuration: Internal storage PLUG: Not present
21 00:00:00		6 - Info	Slots states 2 - 2 : 2: empty
21 00:00:00		6 - Info	Power supply: L1 is not connected. L2 is connected. No line is monitored.
21 00:00:00		6 - Info	Port status: assembled: P1.1-P1.16

#### Network management

The network management provides the following functions:

- Password-protected dial-up for "Administrator" (read and write authorization) and "User" (read only)
- Access protection by means of access control list
- Encrypted HTTPS access
- Read-out of version and status information
- Setting the signal and standby mask and address information
- Fixed parameterization of the ports (data rates, half/full duplex)
- Setting parameters of the VLANs and multicast services
- Parameterization of the standby connections for a redundant ring link
- Setting of Rapid Spanning Tree parameters
- Defining a maximum load per port for load limiting (port thresholds)
- Output of statistics information
- Diagnosis of data traffic by means of a parameterizable mirror port with a standard commercial network analyzer
- Loading of new firmware or the configuration data via the network by a TFTP server
- Saving the configuration data or log table via the network on a TFTP server
- Configuration of the IP routing function after activation with KEY-PLUG (static routing, dynamic routing (OSPF, RIP v1/2), and redundant routing (VRRP))

If faults occur in the network, the SCALANCE XM-400 switch can independently send error messages (traps) to a network management system (e.g. SINEMA Server) or also e-mails to a predefined network administrator.

Remote monitoring (RMON) provides the following functions: The SCALANCE XM-400 switch can collect statistics information according to the RMON groups 1 through 4. These include, for example, fault statistics that are kept for each port. This information can be read out through Web-based management in the statistics sub-area.



**Integration**

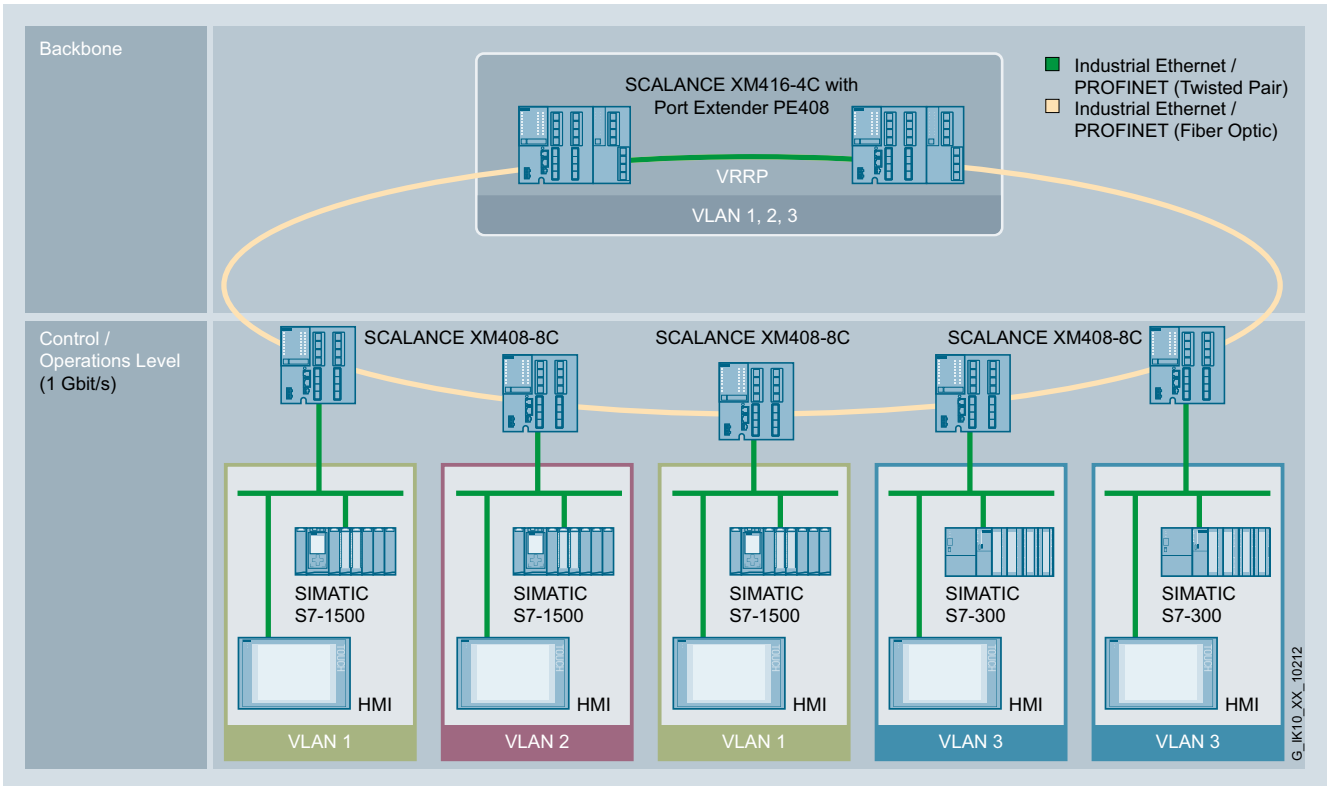

Network structuring through the routing of virtual LANs (a VLAN corresponds to an IP subnetwork)

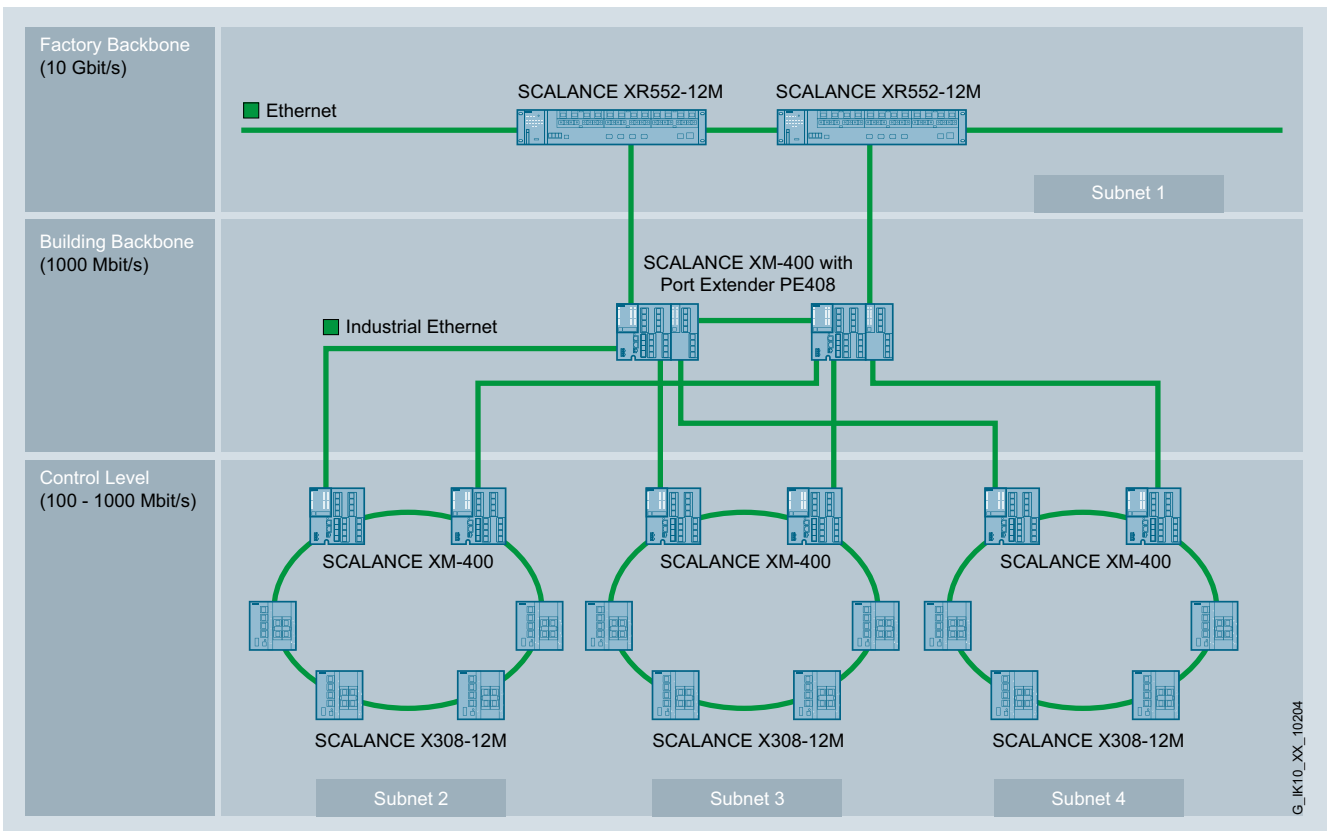

Subnetworks with SCALANCE X308-12M and SCALANCE XM-400 for increasing network availability

# PROFINET/Industrial Ethernet

## Industrial Ethernet Layer 3 Switches / Routers

### SCALANCE XM-400 managed

#### Integration (continued)

2

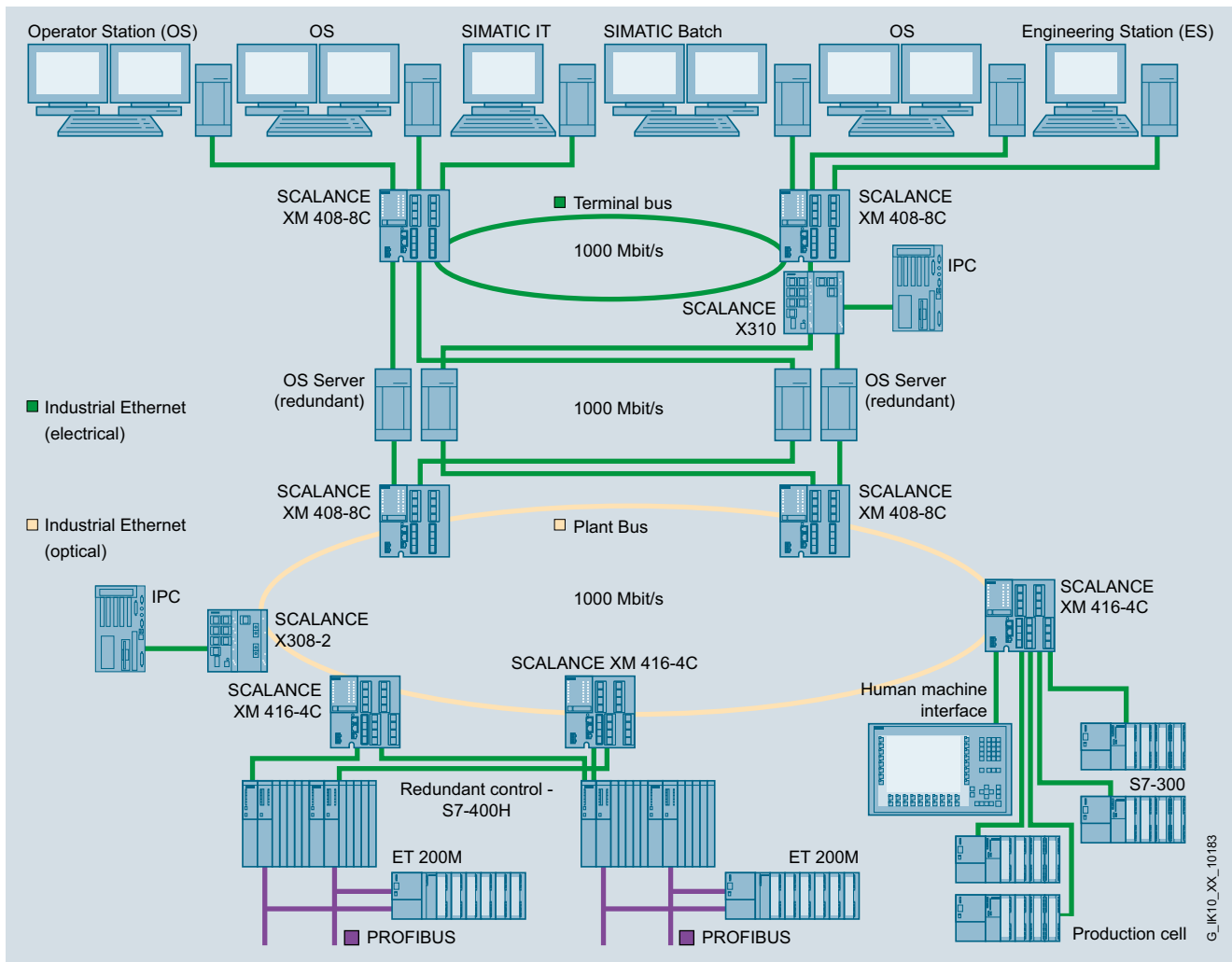

Use of the SCALANCE XM-400 switches in a process control system, e.g. PCS 7

G\_IK10\_XX\_10183

### Technical specifications

Article No.	6GK5416-4GS00-2AM2	6GK5408-8GS00-2AM2	6GK5408-4GP00-2AM2
Product-type designation	SCALANCE XM416-4C	SCALANCE XM408-8C	SCALANCE XM408-4C
<b>Transmission rate</b>			
Transfer rate 1	10 Mbit/s	10 Mbit/s	10 Mbit/s
Transfer rate 2	100 Mbit/s	100 Mbit/s	100 Mbit/s
Transfer rate 3	1 000 Mbit/s	1 000 Mbit/s	1 000 Mbit/s
<b>Interfaces</b>			
Number of electrical/optical connections for network components or terminal equipment maximum	24	24	24
Number of electrical connections for operator console	1	1	1
Design of electrical connection for operator console	RJ11 port	RJ11 port	RJ11 port
Number of electrical connections			
• for network components and terminal equipment	16	8	8
• for network components and terminal equipment with extender modules	8	16	16
• for signaling contact	1	1	1
• for media module	-	-	-
• for power supply	1	1	1
• for redundant power supply	1	1	1
Design of electrical connection			
• for network components and terminal equipment	RJ45 port	RJ45 port	RJ45 port
• for network components and terminal equipment with extender modules	RJ45 port	RJ45 port	RJ45 port
• for signaling contact	2-pole terminal block	2-pole terminal block	2-pole terminal block
• for power supply	4-pole terminal block	4-pole terminal block	4-pole terminal block
Number of optical interfaces for optical waveguide			
• at 100 Mbit/s	4	8	4
• at 1 000 Mbit/s	4	8	4
• with extender modules	8	16	16
Design of optical interface for optical waveguide			
• at 100 Mbit/s	SFP slot	SFP slot	SFP slot
• at 1 000 Mbit/s	SFP slot	SFP slot	SFP slot
• with extender modules	SFP slot	SFP slot	SFP slot
Number of extender expansion interfaces	2	2	2
<b>Signal-Inputs/outputs</b>			
Operating voltage of signaling contacts at DC rated value	24 V	24 V	24 V
Operating current of signaling contacts at DC maximum	0.1 A	0.1 A	0.1 A
<b>Supply voltage, current consumption, power loss</b>			
Type of supply voltage	DC	DC	DC
Supply voltage external	24 V	24 V	24 V
• minimum	19.2 V	19.2 V	19.2 V
• maximum	28.8 V	28.8 V	28.8 V
Product component fusing at power supply input	Yes	Yes	Yes
Type of fusing at input for supply voltage	F 15 A / 125 V	F 15 A / 125 V	F 15 A / 125 V
Consumed current maximum	2 A	2 A	2 A
Active power loss			
• at 24 V for DC	48 W	48 W	48 W

## PROFINET/Industrial Ethernet

### Industrial Ethernet Layer 3 Switches / Routers

#### SCALANCE XM-400 managed

#### Technical specifications (continued)

Article No.	6GK5416-4GS00-2AM2	6GK5408-8GS00-2AM2	6GK5408-4GP00-2AM2
Product-type designation	SCALANCE XM416-4C	SCALANCE XM408-8C	SCALANCE XM408-4C
<b>Permitted ambient conditions</b>			
Ambient temperature			
• during operating	-40 ... +70 °C	-40 ... +70 °C	-40 ... +70 °C
• during storage	-40 ... +85 °C	-40 ... +85 °C	-40 ... +85 °C
• during transport	-40 ... +85 °C	-40 ... +85 °C	-40 ... +85 °C
Relative humidity at 25 °C without condensation during operating maximum	95 %	95 %	95 %
Protection class IP	IP20	IP20	IP20
<b>Design, dimensions and weight</b>			
Design	SIMATIC S7-1500 device design	SIMATIC S7-1500 device design	SIMATIC S7-1500 device design
Width	140 mm	140 mm	140 mm
Height	147 mm	147 mm	147 mm
Depth	125 mm	125 mm	125 mm
Net weight	1.25 kg	1.15 kg	1.15 kg
Mounting type			
• 35 mm DIN rail mounting	Yes	Yes	Yes
• wall mounting	No	No	No
• S7-300 rail mounting	Yes	Yes	Yes
• S7-1500 rail mounting	Yes	Yes	Yes
<b>Product properties, functions, components general</b>			
Cascading in the case of a redundant ring at reconfiguration time of < 0.3 s			
Cascading in cases of star structuring	Any (depending only on signal propagation time)	Any (depending only on signal propagation time)	Any (depending only on signal propagation time)
<b>Product functions management, configuration</b>			
Product function			
• CLI	Yes	Yes	Yes
• web-based management	Yes	Yes	Yes
• MIB support	Yes	Yes	Yes
• TRAPs via email	Yes	Yes	Yes
• Configuration with STEP 7	Yes	Yes	Yes
• RMON	Yes	Yes	Yes
• Port mirroring	Yes	Yes	Yes
• CoS	Yes	Yes	Yes
• PROFINET IO diagnosis	Yes	Yes	Yes
• switch-managed	Yes	Yes	Yes
Protocol is supported			
• Telnet	Yes	Yes	Yes
• HTTP	Yes	Yes	Yes
• HTTPS	Yes	Yes	Yes
• TFTP	Yes	Yes	Yes
• FTP	Yes	Yes	Yes
• BOOTP	Yes	Yes	Yes
• SNMP v1	Yes	Yes	Yes
• SNMP v2	Yes	Yes	Yes
• SNMP v3	Yes	Yes	Yes
• IGMP (snooping/querier)	Yes	Yes	Yes
• GMRP	Yes	Yes	Yes
• DCP	Yes	Yes	Yes
• LLDP	Yes	Yes	Yes
Identification & maintenance function			
• I&M0 - device-specific information	Yes	Yes	Yes
• I&M1 - higher level designation/ location designation	Yes	Yes	Yes

**Technical specifications** (continued)

Article No.	6GK5416-4GS00-2AM2	6GK5408-8GS00-2AM2	6GK5408-4GP00-2AM2
Product-type designation	SCALANCE XM416-4C	SCALANCE XM408-8C	SCALANCE XM408-4C
<b>Product functions Diagnosis</b>			
Product function			
• Port diagnostics	Yes	Yes	Yes
• Statistics packet size	Yes	Yes	Yes
• Statistics packet type	Yes	Yes	Yes
• Error statistics	Yes	Yes	Yes
• SysLog	Yes	Yes	Yes
<b>Product functions VLAN</b>			
Product function			
• VLAN - port based	Yes	Yes	Yes
• VLAN dynamic	Yes	Yes	Yes
Number of VLANs maximum	255	255	255
Number of VLANs - dynamic maximum	255	255	255
Protocol is supported GVRP	Yes	Yes	Yes
<b>Product functions DHCP</b>			
Product function			
• DHCP client	Yes	Yes	Yes
• DHCP Option 82	Yes	Yes	Yes
• DHCP Option 66	Yes	Yes	Yes
• DHCP Option 67	Yes	Yes	Yes
<b>Product functions Routing</b>			
Service Routing Note	IP-Routing connection with KEY-PLUG XM-400	IP-Routing connection with KEY-PLUG XM-400	IP-Routing connection with KEY-PLUG XM-400
Product function			
• static IP routing	Yes	Yes	Yes
• dynamic IP routing	Yes	Yes	Yes
Protocol is supported			
• RIPv2	Yes	Yes	Yes
• OSPFv2	Yes	Yes	Yes
• VRRP	Yes	Yes	Yes
<b>Product functions Redundancy</b>			
Product function			
• Ring redundancy	Yes	Yes	Yes
• Redundancy manager	Yes	Yes	Yes
• Standby redundancy	Yes	Yes	Yes
• High Speed Redundancy Protocol (HRP)	Yes	Yes	Yes
• Media Redundancy Protocol (MRP)	Yes	Yes	Yes
• Redundancy procedure STP	Yes	Yes	Yes
• RSTP redundancy protocol	Yes	Yes	Yes
• Redundancy procedure MSTP	Yes	Yes	Yes
• Passive listening	Yes	Yes	Yes
Protocol is supported			
• STP	-	-	-
• RSTP	-	-	-
• RSTP big network support	-	-	-
• LACP	Yes	Yes	Yes
<b>Product functions Security</b>			
Product function			
• ACL - MAC-based	Yes	Yes	Yes
• ACL - port/MAC-based	Yes	Yes	Yes
• IEEE 802.1x (radius)	Yes	Yes	Yes
• Broadcast/Multicast/Unicast Limiter	Yes	Yes	Yes
• broadcast blocking	Yes	Yes	Yes
Protocol is supported SSH	Yes	Yes	Yes

## PROFINET/Industrial Ethernet

### Industrial Ethernet Layer 3 Switches / Routers

#### SCALANCE XM-400 managed

#### Technical specifications (continued)

Article No.	6GK5416-4GS00-2AM2	6GK5408-8GS00-2AM2	6GK5408-4GP00-2AM2
Product-type designation	SCALANCE XM416-4C	SCALANCE XM408-8C	SCALANCE XM408-4C
<b>Product functions Time</b>			
Product function SICLOCK support	Yes	Yes	Yes
Protocol is supported			
• NTP	Yes	Yes	Yes
• SNTP	Yes	Yes	Yes
<b>Standards, specifications, approvals</b>			
Standard			
• for hazardous area of CSA and UL	UL 60950-1, CSA C22.2 No. 60950-1	UL 60950-1, CSA C22.2 No. 60950-1	UL 60950-1, CSA C22.2 No. 60950-1
• for emitted interference	EN 61000-6-4 (Class A)	EN 61000-6-4 (Class A)	EN 61000-6-4 (Class A)
• for interference immunity	EN 61000-6-2	EN 61000-6-2	EN 61000-6-2
Verification of suitability	EN 61000-6-2, EN 61000-6-4	EN 61000-6-2, EN 61000-6-4	EN 61000-6-2, EN 61000-6-4
• CE mark	Yes	Yes	Yes
• C-Tick	Yes	Yes	Yes
• KC approval	Yes	Yes	Yes
Article No.	6GK5416-4GR00-2AM2	6GK5408-8GR00-2AM2	6GK5408-4GQ00-2AM2
Product-type designation	SCALANCE XM416-4C IP Routing integrated	SCALANCE XM408-8C IP Routing integrated	SCALANCE XM408-4C IP Routing integrated
<b>Transmission rate</b>			
Transfer rate 1	10 Mbit/s	10 Mbit/s	10 Mbit/s
Transfer rate 2	100 Mbit/s	100 Mbit/s	100 Mbit/s
Transfer rate 3	1 000 Mbit/s	1 000 Mbit/s	1 000 Mbit/s
<b>Interfaces</b>			
Number of electrical/optical connections for network components or terminal equipment maximum	24	24	24
Number of electrical connections for operator console	1	1	1
Design of electrical connection for operator console	RJ11 port	RJ11 port	RJ11 port
Number of electrical connections			
• for network components and terminal equipment	16	8	8
• for network components and terminal equipment with extender modules	8	16	16
• for signaling contact	1	1	1
• for media module	-	-	-
• for power supply	1	1	1
• for redundant power supply	1	1	1
Design of electrical connection			
• for network components and terminal equipment	RJ45 port	RJ45 port	RJ45 port
• for network components and terminal equipment with extender modules	RJ45 port	RJ45 port	RJ45 port
• for signaling contact	2-pole terminal block	2-pole terminal block	2-pole terminal block
• for power supply	4-pole terminal block	4-pole terminal block	4-pole terminal block
Number of optical interfaces for optical waveguide			
• at 100 Mbit/s	4	8	4
• at 1 000 Mbit/s	4	8	4
• with extender modules	8	16	16
Design of optical interface for optical waveguide			
• at 100 Mbit/s	SFP slot	SFP slot	SFP slot
• at 1 000 Mbit/s	SFP slot	SFP slot	SFP slot
• with extender modules	SFP slot	SFP slot	SFP slot
Number of extender expansion interfaces	2	2	2

**Technical specifications** (continued)

Article No.	6GK5416-4GR00-2AM2	6GK5408-8GR00-2AM2	6GK5408-4GQ00-2AM2
Product-type designation	SCALANCE XM416-4C IP Routing integrated	SCALANCE XM408-8C IP Routing integrated	SCALANCE XM408-4C IP Routing integrated
<b>Signal-Inputs/outputs</b>			
Operating voltage of signaling contacts at DC rated value	24 V	24 V	24 V
Operating current of signaling contacts at DC maximum	0.1 A	0.1 A	0.1 A
<b>Supply voltage, current consumption, power loss</b>			
Type of supply voltage	DC	DC	DC
Supply voltage external	24 V	24 V	24 V
• minimum	19.2 V	19.2 V	19.2 V
• maximum	28.8 V	28.8 V	28.8 V
Product component fusing at power supply input	Yes	Yes	Yes
Type of fusing at input for supply voltage	F 15 A / 125 V	F 15 A / 125 V	F 15 A / 125 V
Consumed current maximum	2 A	2 A	2 A
Active power loss			
• at 24 V for DC	48 W	48 W	48 W
<b>Permitted ambient conditions</b>			
Ambient temperature			
• during operating	-40 ... +70 °C	-40 ... +70 °C	-40 ... +70 °C
• during storage	-40 ... +85 °C	-40 ... +85 °C	-40 ... +85 °C
• during transport	-40 ... +85 °C	-40 ... +85 °C	-40 ... +85 °C
Relative humidity at 25 °C without condensation during operating maximum	95 %	95 %	95 %
Protection class IP	IP20	IP20	IP20
<b>Design, dimensions and weight</b>			
Design	SIMATIC S7-1500 device design	SIMATIC S7-1500 device design	SIMATIC S7-1500 device design
Width	140 mm	140 mm	140 mm
Height	147 mm	147 mm	147 mm
Depth	125 mm	125 mm	125 mm
Net weight	1.25 kg	1.15 kg	1.15 kg
Mounting type			
• 35 mm DIN rail mounting	Yes	Yes	Yes
• wall mounting	No	No	No
• S7-300 rail mounting	Yes	Yes	Yes
• S7-1500 rail mounting	Yes	Yes	Yes
<b>Product properties, functions, components general</b>			
Cascading in the case of a redundant ring at reconfiguration time of < 0.3 s			
Cascading in cases of star structuring	Any (depending only on signal propagation time)	Any (depending only on signal propagation time)	Any (depending only on signal propagation time)
<b>Product functions management, configuration</b>			
Product function			
• CLI	Yes	Yes	Yes
• web-based management	Yes	Yes	Yes
• MIB support	Yes	Yes	Yes
• TRAPs via email	Yes	Yes	Yes
• Configuration with STEP 7	Yes	Yes	Yes
• RMON	Yes	Yes	Yes
• Port mirroring	Yes	Yes	Yes
• CoS	Yes	Yes	Yes
• PROFINET IO diagnosis	Yes	Yes	Yes
• switch-managed	Yes	Yes	Yes

## PROFINET/Industrial Ethernet

### Industrial Ethernet Layer 3 Switches / Routers

#### SCALANCE XM-400 managed

#### Technical specifications (continued)

Article No.	6GK5416-4GR00-2AM2	6GK5408-8GR00-2AM2	6GK5408-4GQ00-2AM2
Product-type designation	SCALANCE XM416-4C IP Routing integrated	SCALANCE XM408-8C IP Routing integrated	SCALANCE XM408-4C IP Routing integrated
Protocol is supported			
• Telnet	Yes	Yes	Yes
• HTTP	Yes	Yes	Yes
• HTTPS	Yes	Yes	Yes
• TFTP	Yes	Yes	Yes
• FTP	Yes	Yes	Yes
• BOOTP	Yes	Yes	Yes
• SNMP v1	Yes	Yes	Yes
• SNMP v2	Yes	Yes	Yes
• SNMP v3	Yes	Yes	Yes
• IGMP (snooping/querier)	Yes	Yes	Yes
• GMRP	Yes	Yes	Yes
• DCP	Yes	Yes	Yes
• LLDP	Yes	Yes	Yes
Identification & maintenance function			
• I&M0 - device-specific information	Yes	Yes	Yes
• I&M1 - higher level designation/location designation	Yes	Yes	Yes
<b>Product functions Diagnosis</b>			
Product function			
• Port diagnostics	Yes	Yes	Yes
• Statistics packet size	Yes	Yes	Yes
• Statistics packet type	Yes	Yes	Yes
• Error statistics	Yes	Yes	Yes
• SysLog	Yes	Yes	Yes
<b>Product functions VLAN</b>			
Product function			
• VLAN - port based	Yes	Yes	Yes
• VLAN dynamic	Yes	Yes	Yes
Number of VLANs maximum	255	255	255
Number of VLANs - dynamic maximum	255	255	255
Protocol is supported GVRP	Yes	Yes	Yes
<b>Product functions DHCP</b>			
Product function			
• DHCP client	Yes	Yes	Yes
• DHCP Option 82	Yes	Yes	Yes
• DHCP Option 66	Yes	Yes	Yes
• DHCP Option 67	Yes	Yes	Yes
<b>Product functions Routing</b>			
Service Routing Note	IP-Routing integrated	IP-Routing integrated	IP-Routing integrated
Product function			
• static IP routing	Yes	Yes	Yes
• dynamic IP routing	Yes	Yes	Yes
Protocol is supported			
• RIPv2	Yes	Yes	Yes
• OSPFv2	Yes	Yes	Yes
• VRRP	Yes	Yes	Yes



**Technical specifications** (continued)

Article No.	6GK5416-4GR00-2AM2	6GK5408-8GR00-2AM2	6GK5408-4GQ00-2AM2
Product-type designation	SCALANCE XM416-4C IP Routing integrated	SCALANCE XM408-8C IP Routing integrated	SCALANCE XM408-4C IP Routing integrated
<b>Product functions Redundancy</b>			
Product function			
• Ring redundancy	Yes	Yes	Yes
• Redundancy manager	Yes	Yes	Yes
• Standby redundancy	Yes	Yes	Yes
• High Speed Redundancy Protocol (HRP)	Yes	Yes	Yes
• Media Redundancy Protocol (MRP)	Yes	Yes	Yes
• Redundancy procedure STP	Yes	Yes	Yes
• RSTP redundancy protocol	Yes	Yes	Yes
• Redundancy procedure MSTP	Yes	Yes	Yes
• Passive listening	Yes	Yes	Yes
Protocol is supported			
• STP	Yes	Yes	Yes
• RSTP	Yes	Yes	Yes
• RSTP big network support	Yes	Yes	Yes
• LACP	Yes	Yes	Yes
<b>Product functions Security</b>			
Product function			
• ACL - MAC-based	Yes	Yes	Yes
• ACL - port/MAC-based	Yes	Yes	Yes
• IEEE 802.1x (radius)	Yes	Yes	Yes
• Broadcast/Multicast/Unicast Limiter	Yes	Yes	Yes
• Broadcast blocking	Yes	Yes	Yes
Protocol is supported SSH	Yes	Yes	Yes
<b>Product functions Time</b>			
Product function SICLOCK support	Yes	Yes	Yes
Protocol is supported			
• NTP	Yes	Yes	Yes
• SNTP	Yes	Yes	Yes
<b>Standards, specifications, approvals</b>			
Standard			
• for safety of CSA and UL	UL 60950-1, CSA C22.2 No. 60950-1	UL 60950-1, CSA C22.2 No. 60950-1	UL 60950-1, CSA C22.2 No. 60950-1
• for hazardous area of CSA and UL	-	-	-
• for emitted interference	EN 61000-6-4 (Class A)	EN 61000-6-4 (Class A)	EN 61000-6-4 (Class A)
• for interference immunity	EN 61000-6-2	EN 61000-6-2	EN 61000-6-2
Verification of suitability	EN 61000-6-2, EN 61000-6-4	EN 61000-6-2, EN 61000-6-4	EN 61000-6-2, EN 61000-6-4
• CE mark	Yes	Yes	Yes
• C-Tick	Yes	Yes	Yes
• KC approval	Yes	Yes	Yes

## PROFINET/Industrial Ethernet

### Industrial Ethernet Layer 3 Switches / Routers

#### SCALANCE XM-400 managed

#### Technical specifications (continued)

Article No.	6GK5408-0GA00-8AP2	6GK5408-0PA00-8AP2	6GK5400-8AS00-8AP2
Product-type designation	SCALANCE PE408	SCALANCE PE408PoE	SCALANCE PE400-8SFP
<b>Transmission rate</b>			
Transfer rate 1	10 Mbit/s	10 Mbit/s	-
Transfer rate 2	100 Mbit/s	100 Mbit/s	100 Mbit/s
Transfer rate 3	1 000 Mbit/s	1 000 Mbit/s	1 000 Mbit/s
<b>Interfaces</b>			
Number of electrical/optical connections for network components or terminal equipment maximum	8	8	8
Number of electrical connections			
• for network components and terminal equipment	8	8	-
• for Power-over-Ethernet for network components or terminal equipment	-	8	-
• for SFP+/SFP	-	-	8
Design of electrical/optical connections for network components or terminal equipment	-	-	SFP
Design of electrical connection			
• for network components and terminal equipment	RJ45 port	RJ45 port	-
• for Power-over-Ethernet for network components or terminal equipment	-	RJ45 port	-
• for power supply	-	2-pole terminal block	-
Number of optical connections			
• for optical waveguide			
- at 100 Mbit/s	-	-	8
- at 1 000 Mbit/s	-	-	8
Design of optical interface for optical waveguide			
• at 100 Mbit/s	-	-	SFP slot
• at 1 000 Mbit/s	-	-	SFP slot
Number of extender expansion interfaces	2	2	2
<b>Supply voltage, current consumption, power loss</b>			
Type of supply voltage	-	DC	-
Supply voltage external	-	54 V	-
• minimum	-	51.3 V	-
• maximum	-	56.7 V	-
Product component fusing at power supply input	-	Yes	-
Type of fusing at input for supply voltage	-	-	-
Consumed current maximum	0.2 A	0.2 A	0.07 A
Active power loss at 24 V for DC	4.8 W	4.8 W	1.7 W
<b>Permitted ambient conditions</b>			
Ambient temperature			
• during operating	-40 ... +70 °C	-40 ... +60 °C	-40 ... +60 °C
• during storage	-40 ... +85 °C	-40 ... +85 °C	-40 ... +85 °C
• during transport	-40 ... +85 °C	-40 ... +85 °C	-40 ... +85 °C
Relative humidity at 25 °C without condensation during operating maximum	95 %	95 %	95 %
Protection class IP	IP20	IP20	IP20

### Technical specifications (continued)

Article No.	6GK5408-0GA00-8AP2	6GK5408-0PA00-8AP2	6GK5400-8AS00-8AP2
Product-type designation	SCALANCE PE408	SCALANCE PE408PoE	SCALANCE PE400-8SFP
<b>Design, dimensions and weight</b>			
Design	SIMATIC S7-1500 device design	SIMATIC S7-1500 device design	SIMATIC S7-1500 device design
Width	70 mm	70 mm	70 mm
Height	147 mm	147 mm	147 mm
Depth	125 mm	125 mm	125 mm
Net weight	0.6 kg	0.7 kg	0.6 kg
Mounting type			
• 19-inch installation	No	No	No
• 35 mm DIN rail mounting	Yes	Yes	Yes
• wall mounting	No	No	No
• S7-300 rail mounting	Yes	Yes	Yes
• S7-1500 rail mounting	Yes	Yes	Yes
• fixed-mounted	-	-	-
<b>Standards, specifications, approvals</b>			
Standard			
• for EMC from FM	available soon	available soon	available soon
• for hazardous zone	available soon	available soon	available soon
• for safety of CSA and UL	available soon	available soon	available soon
• for hazardous area of CSA and UL	available soon	available soon	available soon
• for emitted interference	EN 61000-6-4 (Class A)	EN 61000-6-4 (Class A)	EN 61000-6-4 (Class A)
• for interference immunity	EN 61000-6-2	EN 61000-6-2	EN 61000-6-2
Verification of suitability	EN 61000-6-2, EN 61000-6-4	EN 61000-6-2, EN 61000-6-4	EN 61000-6-2, EN 61000-6-4
• CE mark	Yes	Yes	Yes
• C-Tick	Yes	Yes	Yes
• KC approval	No	No	No
• E1 approval	No	No	No
• e1 approval	No	No	No

### Ordering data

#### SCALANCE XM-400 Industrial Ethernet switches

With eight to 16 integrated Gigabit Ethernet twisted-pair interfaces (10/100/1 000 Mbit/s); 24 x 1 000 Mbit/s maximum overall configuration by means of port extenders; integrated redundancy manager, IT functions (RSTP, VLAN, etc.), PROFINET IO Device, network management via SNMP and web server; incl. operating instructions, Industrial Ethernet network manual and configuration software on DVD-ROM; C-PLUG included in the scope of delivery

**SCALANCE XM416-4C;**  
16 x 10/100/1 000 Mbit/s, of which 4 x RJ45/SFP combo ports; 16 x 1 000 Mbit/s maximum basic device configuration

- IP routing in combination with KEY PLUG XM-400
- IP routing integrated

6GK5416-4GS00-2AM2

6GK5416-4GR00-2AM2

#### Article No.

**SCALANCE XM408-8C;**  
8 x 10/100/1 000 Mbit/s, of which 8 x RJ45/SFP combo ports; 8 x 1 000 Mbit/s maximum basic device configuration

- IP routing in combination with KEY PLUG XM-400
- IP routing integrated

6GK5408-8GS00-2AM2

6GK5408-8GR00-2AM2

**SCALANCE XM408-4C;**  
8 x 10/100/1 000 Mbit/s, of which 4 x RJ45/ST pluggable/SC pluggable combo ports; 8 x 1 000 Mbit/s maximum basic device configuration

- IP routing in combination with KEY PLUG XM-400
- IP routing integrated

6GK5408-4GP00-2AM2

6GK5408-4GQ00-2AM2

## PROFINET/Industrial Ethernet

### Industrial Ethernet Layer 3 Switches / Routers

#### SCALANCE XM-400 managed

#### Ordering data

##### Port extender

Port extender for SCALANCE XM-400 basic devices

- **PE408;** with 8 x 10/100/1 000 Mbit/s TP ports
- **PE400-8SFP;** with 8 slots for 100/1 000 Mbit/s SFP plug-in transceivers
- **PE408PoE;** with 8 x 10/100/1 000 Mbit/s TP ports  
Power over Ethernet according to 802.3at Type 1 and 2

#### Article No.

**6GK5408-0GA00-8AP2**

**6GK5400-8AS00-8AP2**

**6GK5408-0PA00-8AP2**

##### Plug-in transceiver

ST and SC plug-in transceivers for XM-400 basic device XM408-4C

**STP991-1**  
100 Mbit/s, ST/BFOC connection, multi-mode FOC up to 5 km

**6GK5991-1AB00-8AA0**

**STP991-1LD**  
100 Mbit/s, ST/BFOC connection, single-mode FOC up to 26 km

**6GK5991-1AC00-8AA0**

**SCP992-1**  
1 000 Mbit/s, SC connection, multi-mode FOC up to 750 m

**6GK5992-1AJ00-8AA0**

**SCP992-1LD**  
1 000 Mbit/s, SC connection, single-mode FOC up to 10 km

**6GK5992-1AK00-8AA0**

##### SFP plug-in transceivers for XM-400

see "Plug-in transceivers for SCALANCE XR-500"/  
"Media modules for modular SCALANCE X-500 managed"

#### Article No.

##### Accessories

##### KEY-PLUG XM-400

Swap medium for expansion of the device functions with IP routing (Layer 3), for integration of configuration data and for easy replacement of SCALANCE XM-400 in the event of a fault

**6GK5904-0PA00**

##### C-PLUG

Swap medium for simple replacement of devices in the event of a fault; for storing configuration or application data; can be used for SIMATIC NET products with C-PLUG slot

**6GK1900-0AB00**

##### Power supplies

**SIMATIC PM 1507 24 V**  
stabilized power supply for SIMATIC S7-1500

- Power supply S7-1500 PM1507 SIMATIC PM 1507 24 V/3 A stabilized power supply for SIMATIC S7-1500  
Input: 120/230 V AC  
Output: 24 V DC/3 A

**6EP1332-4BA00**

- Power supply S7-1500 PM1507 SIMATIC PM 1507 24 V/8 A stabilized power supply for SIMATIC S7-1500  
Input: 120/230 V AC  
Output: 24 V DC/8 A

**6EP1333-4BA00**

##### Miscellaneous accessories

##### 4-pole spring-loaded terminal block

Spring-type 4-pole terminal for power supply (24 V DC) for SCALANCE X/W/S/M; 1 pack = 5 items

**6GK5980-1DB10-0AA5**

##### 2-pole spring-loaded terminal block

Spring-type 2-pole terminal for signaling contact (24 V DC) for SCALANCE X/W/S/M; 1 pack = 5 items

**6GK5980-0BB10-0AA5**

##### Screw for fixing to S7-1500 and S7-300 rails

Mounting screw for SCALANCE X/W/S/M; 1 pack = 5 items

**6GK5980-4AA00-0AA5**

##### Connection cable (RJ11/RS232)

pre-assembled serial cable with RJ11 and RS323 connector, length: 5 m; 1 item per pack

**6GK5980-3BB00-0AA5**

#### More information

##### Selection tools:

To assist in selecting the right Industrial Ethernet switches as well as configuration of modular variants, the SIMATIC NET Selection Tool and the TIA Selection Tool are available at:

SIMATIC NET Selection Tool:

- Online version:  
<http://www.siemens.com/snst>
- Offline version:  
<http://www.siemens.com/snst-download>

TIA Selection Tool:

<http://www.siemens.com/tia-selection-tool>

Overview

SCALANCE X-500		Hardware																										
		Type of device	Connection to S7 backplane bus	Format module S7	PC module	Flat type of construction	Box type of construction	19" type of construction	Rugged, compact housing	Modular design	10 Gigabit Ethernet	Gigabit Ethernet	PoE (Power over Ethernet)	LED diagnosis	SIMATIC environment	Redundant power supply (2 x 24 V DC)	External supply	Signal contact	Local display (SET pushbutton)	PLUG slot								
XR552-12M/ XR528-6M							•		•	•	•	•	•	•	•	•	•	•	•	•								
XR524-8C							•		•		•	•	•	•	•	•		•	•	•								
SCALANCE X-500		Software																										
		Security Integrated (Firewall/VPN)	PROFINET diagnosis	Topology support (LLDP)	Command Line Interface / Teinet	Web based Management	Configuration with STEP 7 / TIA	SNMP	Ring redundancy incl. RM-functionality	Standby redundancy	IRT capability	VLAN (Virtual Local Area Network)	GVRP (Generic VLAN Registration Protocol)	STP/ RSTP (Spanning Tree Protocol/ Rapid Spanning Tree Protocol)	Passive Listening	IGMP Snooping/Querier (Internet Group Management Protocol)	GMRP (Generic Multicast Protocol)	Broadcast/ Multicast/ Unicast Limiter	Broadcast blocking	DHCP Option 82 (Dynamic Host Configuration Protocol)	Access Control List (IP)	Access Control List (MAC)	IEEE 802.1x (Radius)	Link Aggregation	Static Routing	RIPv2 (Dynamic Routing)	OSPFv2 (Dynamic Routing)	VRRP, Router Redundancy (Virtual Router Redundancy Protocol)
XR552-12M/ XR528-6M		•	•	•	•	•	•	•	•		•	•	•	•	•	•	•	•	•	•	•	•	•	•	•	•	•	•
XR524-8C		•	•	•	•	•	•	•	•		•	•	•	•	•	•	•	•	•	•	•	•	•	•	•	•	•	•

• applies

G\_1K10\_XX\_10308

Function overview SCALANCE X-500 managed

## PROFINET/Industrial Ethernet

### Industrial Ethernet Layer 3 Switches / Routers

#### SCALANCE XR-500 managed

#### Overview



The Layer 3-enabled SCALANCE XR-500 Industrial Ethernet switches are fully modular, high-performance, industry-standard switches for the construction of electrical and optical line, ring and star topologies with data transfer rates of up to 10 Gbit/s, designed for installation in 19" control cabinets.

- Four optical interfaces (10 Gbit/s) and up to 48 electrical and/or optical interfaces (10/100/1 000 Mbit/s), of which up to 12 electrical PoE interfaces; up to twelve electrical and/or optical 4-port media modules can be plugged into the basic unit at any point.
- Fast media redundancy due to the integrated redundancy manager: Redundant connection of rings by means of high-speed media redundancy is also possible with SCALANCE XR-500.
- Seamless integration of automation networks into existing corporate networks thanks to support for a host of IT standard functions (VLANs, IGMP-Snooping/Querier, STP/RSTP/MSTP, Link Aggregation, Quality of Service, 802.1X and optional static routing, RIP, OSPF, VRRP for IPv4 and IPv6)
- PROFINET diagnostics, Web browser, CLI and SNMP
- Redundant integration into higher-level networks through support for standardized redundancy procedures (Multiple Spanning Tree Protocol, Spanning Tree Protocol, Rapid Reconfiguration Spanning Tree Protocol, Media Redundancy Protocol) and standardized IP routing protocols or procedures (Routing Information Protocol, Open Shortest Path First, Virtual Router Redundancy Protocol)
- KEY-PLUG as the swap medium with which Layer 3 routing functions can be enabled.
  - For the automatic backup of configuration data. If a fault occurs, it allows fast and simple device replacement of SCALANCE X-500 components without a Field PG (contains the function of the C-PLUG)
  - Can be used in all Layer 2 variants of the SCALANCE XR552 and XR528
  - For a detailed description, see "SCALANCE Accessories for Layer 3 Switches / Routers"

#### Product versions

##### SCALANCE XR552-12M

- LEDs and ports on the front
- Alternatively: LEDs on the front and ports at the rear
- Connection of power supply unit at rear or above/below the switch
- Four SFP+ slots for equipping with 10 Gigabit Ethernet SFP+ plug-in transceivers or Gigabit SFP plug-in transceivers
- 12x 4-port media module slots
- Available with integrated IP routing functions or for the optional extension of the IP routing functions by means of KEY-PLUG

##### SCALANCE XR528-6M

- LEDs and ports on the front
- Alternatively: LEDs on the front and ports at the rear
- Connection of power supply unit at rear or above/below the switch
- Four SFP+ slots for equipping with 10 Gigabit Ethernet SFP+ plug-in transceivers or Gigabit SFP plug-in transceivers
- 6x 4-port media module slots
- Available with integrated IP routing functions or for the optional extension of the IP routing functions by means of KEY-PLUG

##### SCALANCE XR524-8C

- Eight combo-ports for optional use of optical or electrical interfaces with 10/100/1 000 Mbit/s optically or electrically via SFP plug-in transceiver
- 16 electrical ports operating at 10/100/1 000 Mbit/s
- In total, 24 ports can be used
- Power supply versions 24 V and 230 V (integrated)
- Available with integrated IP routing functions or for the optional extension of the IP routing functions by means of KEY-PLUG

#### Benefits



- Unlimited flexibility during network expansions (e.g. more terminals, higher data transfer rates, PoE ports) or conversion (e.g. switching from copper to fiber-optic cable) and reduction of the storage costs due to the fully modular construction using SFPplus/SFP and media modules
- Retrofitting the Layer 3 switching functions (IP routing) by means of a license on KEY-PLUG without replacing the existing hardware
- Changing the media modules during operation
- High availability of the network thanks to
  - redundant power supply
  - redundant network structures based on FOC or Twisted Pair (redundancy manager, standby function and STP/RSTP/MSTP integrated)
  - easy device replacement by means of plug-in C-PLUG/KEY-PLUG swap medium
  - very fast reconfiguration of the network in event of a fault
- Thanks to the support of the Dual Stack Routing function, IPv4 networks and IPv6 networks can overlap and be operated in parallel
- High flexibility thanks to variable mounting options of the power supply unit and device variants with ports on either the front or rear of the device.

### Application

The SCALANCE XR-500 switches are ideal for use in industrial networks and for integrating the industrial network into an existing corporate network. From the control level to the management level, the switch handles the networking of plant sections as well as distributed field devices and ensures high plant availability with extensive diagnostics options and high transmission speeds. Thanks to the scalability of the basic unit and the optionally available Layer 3 switching function, the network can be established specially for the relevant application, or adapted and expanded at any time.

The SCALANCE XR-500 switches are suitable for establishing electrical and optical Industrial Ethernet line, star or ring topologies with four integral SFP+ slots that can be optionally equipped with SFP+ plug-in transceivers (10 Gbit/s) or SFP plug-in transceivers (1 000 Mbit/s), and up to 12 media module slots that can be optionally equipped with electrical and/or optical 4-port media modules. Thanks to data transfer rates of up to 10 Gbit/s, the switches can be used as an Industrial Ethernet backbone switch and as a hub in the plant bus (redundant connection possible).

The use of media modules or SFP+/SFP enables the following:

- Extension of networks by subsequent insertion of additional media modules in unused media module slots
- Changing of cabling technology, e.g. conversion from copper to fiber-optic cables, or from multimode to singlemode FOC
- Changing of the data transfer rate, e.g. from 1 000 Mbit/s to 10 Gbit/s

### Design

The SCALANCE XR-500 Industrial Ethernet switches with robust metal enclosure with IP20 degree of protection are optimized for installation in the 19" control cabinet. The power supply unit (85 to 264 V AC) for power supply to the SCALANCE XR-500, which is also optimized for the 19" cabinet, can either be installed directly at the rear of the SCALANCE XR-500 or connected using connecting cables (installation of the power supply unit in a 19" rack). The data ports of the SCALANCE XR-500 are located optionally either at the front or rear of the device (depending on the device variant).

The switches have:

- 4-pole terminal block on the front for connecting the optionally available power supply unit (85 V to 264 V AC)
- 6-pole connector for assembly of the optionally available power supply unit (85 V to 264 V AC) on the rear
- 2-pole terminal block for connecting the isolated signaling contact for simple display of faults
- Row of LEDs for indicating status information (power, link status, data transfer, power supply, signaling contact)
- SELECT/SET pushbutton for easy setting of the fault signaling contact on the device
- Slot on the side of the device for the C-PLUG swap medium for simple device replacement in the event of a fault, or for the KEY-PLUG for adding IP routing to the device functionality
- Console port (RS 232 serial interface, RJ11 cable to Sub-D (9-pole) included in scope of delivery) and management port (Ethernet interface) for on-site parameter assignment/diagnostics

The SCALANCE XR-500 switches are available with the following port types:

- Four SFP+ slots for optical SFP+ or SFP plug-in transceivers (multimode and singlemode connections)
  - The SFP+ plug-in transceivers support 10 Gbps
  - The SFP plug-in transceivers support 1 000 Mbps
- Up to 12 slots for electrical 4-port media modules and electrical PoE 4-port media modules or optical 4-port media modules for multimode or singlemode connections; the optical media modules are available in various connection technologies
  - The RJ45 sockets are also available in industry-standard design with additional retaining collars for connection of the Industrial Ethernet FC RJ45 Plug 180
  - All electrical Ethernet interfaces support 10/100/1 000 Mbps, all optical Ethernet interfaces support 100 or 1 000 Mbps

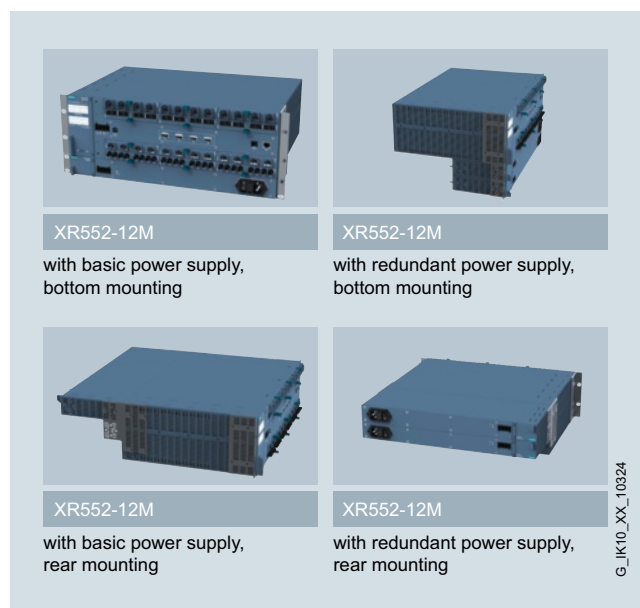

Options for mounting a single/redundant power supply unit to SCALANCE XR552-12M

## PROFINET/Industrial Ethernet

### Industrial Ethernet Layer 3 Switches / Routers

#### SCALANCE XR-500 managed

#### Function

- Integrated redundancy manager for constructing ring topologies with up to 10 Gbps and high-speed media redundancy. By interconnecting the ends of an optical or electrical line to form a ring, reliable communication can be achieved. The redundancy manager (RM) integrated in the SCALANCE XR-500 switch monitors the function of the network. It recognizes the failure of a transmission link or of a SCALANCE X switch in the ring and activates the substitute path within a maximum of 200 milliseconds.
- Redundant Layer 2 interfacing to company networks; SCALANCE XR-500 switches support the standardized redundancy procedures Multiple Spanning Tree Protocol (MSTP), Rapid Spanning Tree Protocol (RSTP), and Spanning Tree Protocol (STP). This enables a subnet to be connected redundantly to a higher-level corporate network with reduced requirements for the reconfiguration time (in the order of seconds).
- The Layer 3 switching functions (optional) enable simple subdivision of large networks into smaller subnets with their own address space. Reasons for subdivision into subnets include separation of the Ethernet network to reduce the broadcast load, separation of sensitive areas from the main network, and subdivision of the network into logical working groups.
- Redundant Layer 3 connection to corporate networks; SCALANCE XR-500 switches support the standardized routing protocols Open Shortest Path First (OSPF) and Routing Information Protocol (RIP), and the standardized routing procedure Virtual Router Redundancy Protocol (VRRP). This means industrial, routed subnets can also be connected redundantly to a higher-level corporate network.
- Thanks to support for the Dual Stack Routing function, both IPv4 addressing and IPv6 addressing can be operated in one network.
- Support of virtual networks (VLAN); for structuring Industrial Ethernet networks with a fast growing number of users, a physically existing network can be divided into several virtual networks. Port-based, protocol-based and IP-based VLANs are available for selection.
- Load limiting when multicast protocols (e.g. video transmission) are used; through learning the multicast receivers (IGMP Snooping, IGMP Querier), SCALANCE XR-500 switches can also filter multicast data traffic and therefore limit the load in the network. Multicast and broadcast traffic can be limited.
- Time synchronization; diagnostic messages (log table entries, e-mails) are time-stamped. The local time is standardized throughout the network by means of synchronization with a SICLOCK time transmitter or SNTP/NTP server, thereby simplifying the assignment of diagnostic messages of several devices.
- Link Aggregation (IEEE 802.3ad) for bundling data streams
- Quality of Service (IEEE 802.1Q) for prioritization of network traffic

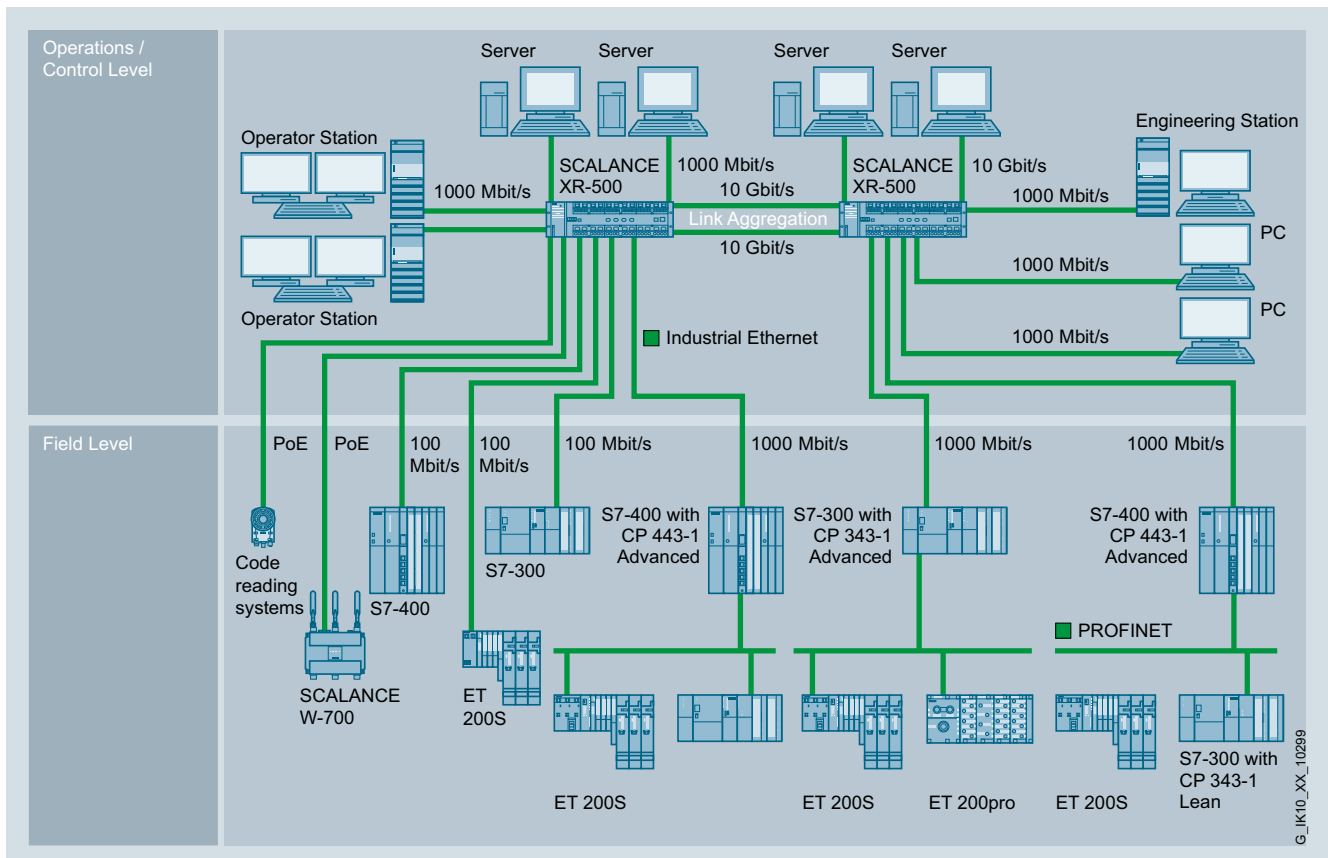

Increasing the transmission bandwidth by means of link aggregation



### Function (continued)

#### Network topology and network configuration

The network topology can easily be adapted to the structure of the plant using SCALANCE XR-500 Industrial Ethernet switches.

The following network structures and combinations of structures can be implemented:

- Ethernet with fast media redundancy; to increase network availability, as many as 50 X-200, X-300, X-400 or X-500 switches cascaded in line can be connected into a ring.
- Several rings can be redundantly linked through the standby function
- Star topology with SCALANCE XR-500 switches: Each SCALANCE XR-500 switch represents a neutral point that can connect up to 52 nodes or subnets with each other electrically.

2

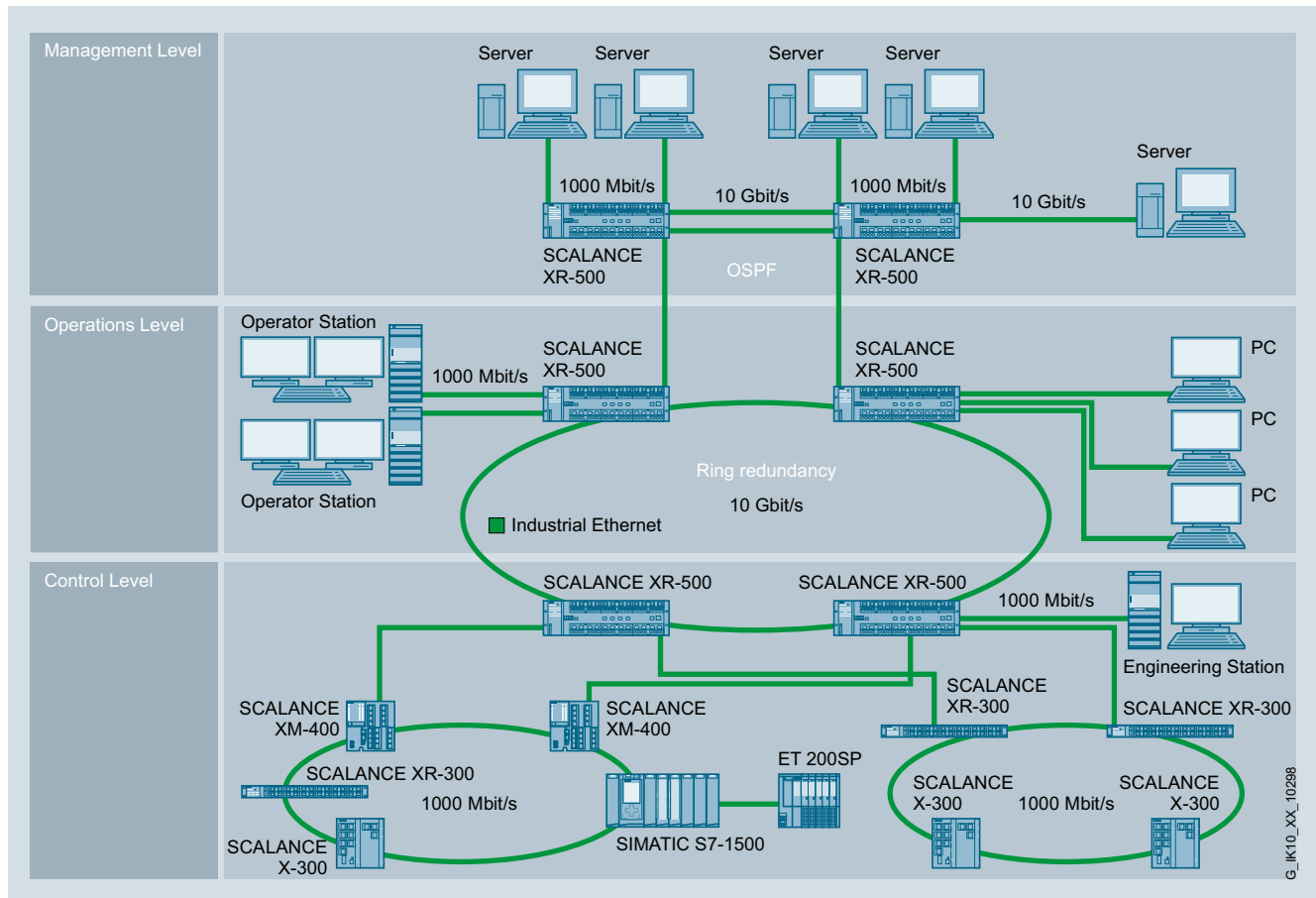

Use of SCALANCE XR-500 in redundant network topologies, e.g. with Rapid Spanning Tree Protocol (RSTP) and ring redundancy

When configuring the network, it is necessary to observe the following boundary conditions:

- Maximum line length between two modules for multi-mode fiber-optic conductors:
  - 5 km at 100 Mbit/s
  - 750 m at 1 000 Mbit/s
  - 300 m at 10 Gbit/s
- Maximum line length between two modules for single-mode fiber-optic conductors:
  - 26 to 200 km at 100 Mbit/s
  - 10 to 120 km at 1 000 Mbit/s
  - 10 to 40 km at 10 Gbit/s
- Maximum cable length of the TP cable between two SCALANCE X switches:
  - Max. 100 m with IE FC Cable 2 x 2 and IE FC RJ45 Plug 180
  - Max. 100 m at 1 Gbps with IE FC Standard Cable 4 x 2 (90 m), IE FC RJ45 Modular Outlet and patch cable (10 m)
  - Max. 10 m using patches with TP cord

## PROFINET/Industrial Ethernet

### Industrial Ethernet Layer 3 Switches / Routers

#### SCALANCE XR-500 managed

#### Function (continued)

##### Commissioning and diagnosis

Setting options on the device itself:

- Redundancy manager RM; to establish a ring, a SCALANCE XR-500 is switched to RM mode. The non-ring ports of the RM can be used freely for the connection of data terminals and networks. If the redundancy procedure MRP standardized by PROFINET is used, the RM is adjusted automatically.
- Signal mask; the signal mask is set to the current status of the SCALANCE XR-500 (setpoint) by pushbutton operation. The signal mask defines which ports and which power supplies are to be monitored. The signaling contact only reports an error when a monitored port or a monitored feeder fails (deviation of setpoint/actual status).
- IP address; the IP address is assigned by means of dynamic host configuration protocol (DHCP). If there is no corresponding server in the network, the IP address can be assigned using an enclosed software tool.

Diagnostic options on site:

- The following status information is displayed by LEDs on site:
  - Port status
  - Port mode (Mbps, full/half-duplex)
  - Status of the two power supplies
  - Signaling contact status
  - Signal mask (setpoint status)
  - RM mode
  - Standby mode
  - Via the browser of a mobile device (smartphone, tablet)

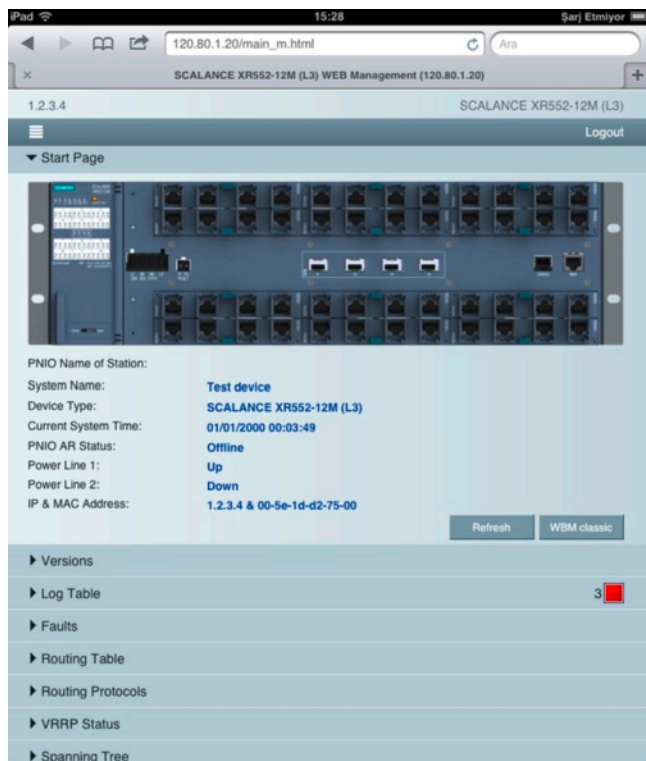

- The status of the signaling contact is routed externally by means of floating relay contacts. This enables, for example, the module to be monitored via an input module from a controller.
- Monitoring via the Industrial Ethernet network; the following possibilities are available:
  - Via standard browser (Web-based management): Selection of SCALANCE XR-500 switches via the network from a PC with browser
  - Via SNMP V1, V2c, V3: Secure integration of SCALANCE XR-500 switches via the network into a network management system, e.g. SINEMA Server
  - Via PROFINET IO diagnostics: PROFINET diagnostic alarms from SCALANCE XR-500 switches can be displayed using the relevant SIMATIC engineering tools and they can also be processed in the controller. The engineering outlay for the PLC and HMI have been drastically reduced due to the complete integration in the SIMATIC concept for system error messages.
- Via the browser of a mobile device (smartphone, tablet)

##### Network management

The network management provides the following functions:

- Password-protected dial-up for "Administrator" (read and write authorization) and "User" (read only)
- Read-out of version and status information
- Setting the signal and standby mask and address information
- Fixed parameterization of the ports (data rates, half/full duplex)
- Setting of Spanning/Rapid/Multiple Spanning Tree parameters
- Parameterization of the web management services
- Security
  - Ports can be connected or disconnected
  - Port-based network access control according to IEEE 802.1x
  - Authentication in accordance with IEEE 802.1x
  - Support of Access Control List (ACL)
- Output of statistics information
- Diagnosis of data traffic by means of a parameterizable mirror port with a standard commercial network analyzer
- Loading of new firmware versions or of the configuration data via the network by a TFTP server or directly via HTTP/HTTPS using a Web browser
- Saving the configuration data or log table via the network on a TFTP server

If faults occur in the network, the SCALANCE XR-500 switch can independently send error messages (traps) to a network management system, such as SINEMA Server, or also e-mails to a predefined network administrator.

Remote monitoring (RMON) provides the following functions: The SCALANCE XR-500 switch can collect statistics information according to the RMON groups 1 through 4. These include, for example, fault statistics that are kept for each port. This information can be read out through web-based management in the statistics sub-area.

### Technical specifications

Article No.	6GK5552-0AA00-2AR2 6GK5552-0AA00-2HR2	6GK5552-0AR00-2AR2 6GK5552-0AR00-2HR2	6GK5528-0AA00-2AR2 6GK5528-0AA00-2HR2	6GK5528-0AR00-2AR2 6GK5528-0AR00-2HR2
Product-type designation	SCALANCE XR552-12M	SCALANCE XR552-12M	SCALANCE XR528-6M	SCALANCE XR528-6M
<b>Transmission rate</b>				
Transfer rate 1	10 Mbit/s	10 Mbit/s	10 Mbit/s	10 Mbit/s
Transfer rate 2	100 Mbit/s	100 Mbit/s	100 Mbit/s	100 Mbit/s
Transfer rate 3	1 000 Mbit/s	1 000 Mbit/s	1 000 Mbit/s	1 000 Mbit/s
Transfer rate 4	10 Gbit/s	10 Gbit/s	10 Gbit/s	10 Gbit/s
<b>Interfaces</b>				
Number of electrical/optical connections for network components or terminal equipment maximum	52	52	28	28
Number of electrical connections				
• for SFP+/SFP	4	4	4	4
• for operator console	1	1	1	1
• for management purposes	1	1	1	1
• for signaling contact	1	1	1	1
• for media module	12	12	6	6
• for power supply	1	1	1	1
• for redundant power supply	1	1	1	1
Design of electrical connection				
• for network components and terminal equipment	Dependent on selected media modules	Dependent on selected media modules	Dependent on selected media modules	Dependent on selected media modules
• for Power-over-Ethernet for network components or terminal equipment	RJ45 port	RJ45 port	RJ45 port	RJ45 port
• for operator console	RJ11 port	RJ11 port	RJ11 port	RJ11 port
• for management purposes	RJ45 port	RJ45 port	RJ45 port	RJ45 port
• for signaling contact	2-pole terminal block	2-pole terminal block	2-pole terminal block	2-pole terminal block
• for power supply	4-pole terminal block	4-pole terminal block	4-pole terminal block	4-pole terminal block
Design of optical interface for optical waveguide				
• at 100 Mbit/s	Dependent on selected media modules	Dependent on selected media modules	Dependent on selected media modules	Dependent on selected media modules
• at 1 000 Mbit/s	Dependent on selected media modules	Dependent on selected media modules	Dependent on selected media modules	Dependent on selected media modules
Design of the removable storage C-PLUG/KEY-PLUG	Yes	Yes	Yes	Yes
<b>Signal-Inputs/outputs</b>				
Operating voltage of signaling contacts at DC rated value	24 V	24 V	24 V	24 V
Operating current of signaling contacts at DC maximum	0.1 A	0.1 A	0.1 A	0.1 A
<b>Supply voltage, current consumption, power loss</b>				
Type of supply voltage	DC	DC	DC	DC
Supply voltage external	24 V	24 V	24 V	24 V
• minimum	19.2 V	19.2 V	19.2 V	19.2 V
• maximum	28.8 V	28.8 V	28.8 V	28.8 V
Product component fusing at power supply input	Yes	Yes	Yes	Yes
Type of fusing at input for supply voltage	F 15 A / 125 V	F 15 A / 125 V	F 15 A / 125 V	F 15 A / 125 V

## PROFINET/Industrial Ethernet

### Industrial Ethernet Layer 3 Switches / Routers

#### SCALANCE XR-500 managed

#### Technical specifications (continued)

Article No.	6GK5552-0AA00-2AR2 6GK5552-0AA00-2HR2	6GK5552-0AR00-2AR2 6GK5552-0AR00-2HR2	6GK5528-0AA00-2AR2 6GK5528-0AA00-2HR2	6GK5528-0AR00-2AR2 6GK5528-0AR00-2HR2
Product-type designation	SCALANCE XR552-12M	SCALANCE XR552-12M	SCALANCE XR528-6M	SCALANCE XR528-6M
<b>Permitted ambient conditions</b>				
Ambient temperature				
• during operating	0 ... 60 °C	0 ... 60 °C	0 ... 60 °C	0 ... 60 °C
• during storage	-40 ... +70 °C	-40 ... +70 °C	-40 ... +70 °C	-40 ... +70 °C
• during transport	-40 ... +70 °C	-40 ... +70 °C	-40 ... +70 °C	-40 ... +70 °C
Relative humidity at 25 °C without condensation during operating maximum	95 %	95 %	95 %	95 %
Protection class IP	IP20	IP20	IP20	IP20
<b>Design, dimensions and weight</b>				
Design	19" rack	19" rack	19" rack	19" rack
Width	449 mm	449 mm	449 mm	449 mm
Height	130.8 mm	130.8 mm	87.2 mm	87.2 mm
Depth	305 mm	305 mm	305 mm	305 mm
Net weight	10 kg	10 kg	10 kg	10 kg
Mounting type 19-inch installation	Yes	Yes	Yes	Yes
Type of cable outlet	Cable outlet at front	Cable outlet at front	Cable outlet at front	Cable outlet at front
<b>Product properties, functions, components general</b>				
Cascading in the case of a redundant ring at reconfiguration time of < 0.3 s				
Cascading in cases of star structuring	Any (depending only on signal propagation time)	Any (depending only on signal propagation time)	Any (depending only on signal propagation time)	Any (depending only on signal propagation time)
<b>Product functions management, configuration</b>				
Product function				
• CLI	Yes	Yes	Yes	Yes
• web-based management	Yes	Yes	Yes	Yes
• MIB support	Yes	Yes	Yes	Yes
• TRAPs via email	Yes	Yes	Yes	Yes
• Configuration with STEP 7	Yes	Yes	Yes	Yes
• RMON	Yes	Yes	Yes	Yes
• Port mirroring	Yes	Yes	Yes	Yes
• CoS	Yes	Yes	Yes	Yes
• PROFINET IO diagnosis	Yes	Yes	Yes	Yes
• switch-managed	Yes	Yes	Yes	Yes
Protocol is supported				
• Telnet	Yes	Yes	Yes	Yes
• HTTP	Yes	Yes	Yes	Yes
• HTTPS	Yes	Yes	Yes	Yes
• TFTP	Yes	Yes	Yes	Yes
• FTP	Yes	Yes	Yes	Yes
• BOOTP	Yes	Yes	Yes	Yes
• SNMP v1	Yes	Yes	Yes	Yes
• SNMP v2	Yes	Yes	Yes	Yes
• SNMP v3	Yes	Yes	Yes	Yes
• IGMP (snooping/querier)	Yes	Yes	Yes	Yes
• GMRP	Yes	Yes	Yes	Yes
• DCP	Yes	Yes	Yes	Yes
• LLDP	Yes	Yes	Yes	Yes
Identification & maintenance function				
• I&M0 - device-specific information	Yes	Yes	Yes	Yes
• I&M1 - higher level designation/location designation	Yes	Yes	Yes	Yes

**Technical specifications (continued)**

Article No.	6GK5552-0AA00-2AR2 6GK5552-0AA00-2HR2	6GK5552-0AR00-2AR2 6GK5552-0AR00-2HR2	6GK5528-0AA00-2AR2 6GK5528-0AA00-2HR2	6GK5528-0AR00-2AR2 6GK5528-0AR00-2HR2
Product-type designation	SCALANCE XR552-12M	SCALANCE XR552-12M	SCALANCE XR528-6M	SCALANCE XR528-6M
<b>Product functions Diagnosis</b>				
Product function				
• Port diagnostics	Yes	Yes	Yes	Yes
• Statistics packet size	Yes	Yes	Yes	Yes
• Statistics packet type	Yes	Yes	Yes	Yes
• Error statistics	Yes	Yes	Yes	Yes
• SysLog	Yes	Yes	Yes	Yes
<b>Product functions VLAN</b>				
Product function				
• VLAN - port based	Yes	Yes	Yes	Yes
• VLAN - protocol-based	Yes	Yes	Yes	Yes
• VLAN - IP-based	Yes	Yes	Yes	Yes
• VLAN dynamic	Yes	Yes	Yes	Yes
Number of VLANs maximum	255	255	255	255
Number of VLANs - dynamic maximum	255	255	255	255
Protocol is supported GVRP	Yes	Yes	Yes	Yes
<b>Product functions DHCP</b>				
Product function				
• DHCP client	Yes	Yes	Yes	Yes
• DHCP Option 82	Yes	Yes	Yes	Yes
• DHCP Option 66	Yes	Yes	Yes	Yes
• DHCP Option 67	Yes	Yes	Yes	Yes
<b>Product functions Routing</b>				
Service Routing Note	IP routing in connection with KEY-PLUG, IPv6 available soon	IP routing integrated, IPv6 available soon	IP routing in connection with KEY-PLUG, IPv6 available soon	IP routing integrated, IPv6 available soon
Product function				
• static IP routing	-	Yes	-	Yes
• static IP routing IPv6	-	No	-	No
• dynamic IP routing	-	Yes	-	Yes
• dynamic IP routing IPv6	-	No	-	No
Protocol is supported				
• RIPv2	-	Yes	-	Yes
• RIPnG for IPv6	-	No	-	No
• OSPFv2	-	Yes	-	Yes
• OSPFv3 for IPv6	-	No	-	No
• VRRP	-	Yes	-	Yes
• VRRP for IPv6	-	No	-	No
<b>Product functions Redundancy</b>				
Product function				
• Ring redundancy	Yes	Yes	Yes	Yes
• Redundancy manager	Yes	Yes	Yes	Yes
• Standby redundancy	Yes	Yes	Yes	Yes
• High Speed Redundancy Protocol (HRP)	Yes	Yes	Yes	Yes
• Media Redundancy Protocol (MRP)	Yes	Yes	Yes	Yes
• Redundancy procedure STP	Yes	Yes	Yes	Yes
• RSTP redundancy protocol	Yes	Yes	Yes	Yes
• redundancy procedure MSTP	Yes	Yes	Yes	Yes
• Passive listening	Yes	Yes	Yes	Yes
Protocol is supported				
• STP	Yes	Yes	Yes	Yes
• RSTP	Yes	Yes	Yes	Yes
• MSTP	Yes	Yes	Yes	Yes
• RSTP big network support	Yes	Yes	Yes	Yes
• LACP	Yes	Yes	Yes	Yes

## PROFINET/Industrial Ethernet

### Industrial Ethernet Layer 3 Switches / Routers

#### SCALANCE XR-500 managed

#### Technical specifications (continued)

Article No.	6GK5552-0AA00-2AR2 6GK5552-0AA00-2HR2	6GK5552-0AR00-2AR2 6GK5552-0AR00-2HR2	6GK5528-0AA00-2AR2 6GK5528-0AA00-2HR2	6GK5528-0AR00-2AR2 6GK5528-0AR00-2HR2
Product-type designation	SCALANCE XR552-12M	SCALANCE XR552-12M	SCALANCE XR528-6M	SCALANCE XR528-6M
<b>Product functions Security</b>				
Product function				
• ACL - MAC-based	Yes	Yes	Yes	Yes
• ACL - port/MAC-based	Yes	Yes	Yes	Yes
• IEEE 802.1x (radius)	Yes	Yes	Yes	Yes
• Broadcast/Multicast/Unicast Limiter	Yes	Yes	Yes	Yes
• broadcast blocking	Yes	Yes	Yes	Yes
Protocol is supported SSH	Yes	Yes	Yes	Yes
<b>Product functions Time</b>				
Product function SICLOCK support	Yes	Yes	Yes	Yes
Protocol is supported				
• NTP	Yes	Yes	Yes	Yes
• SNTP	Yes	Yes	Yes	Yes
Type of time synchronization	IEEE 1588 available soon	IEEE 1588 available soon	IEEE 1588 available soon	IEEE 1588 available soon
<b>Standards, specifications, approvals</b>				
Standard				
• for safety of CSA and UL	UL 60950-1, CSA C22.2 No. 60950-1	UL 60950-1, CSA C22.2 No. 60950-1	UL 60950-1, CSA C22.2 No. 60950-1	UL 60950-1, CSA C22.2 No. 60950-1
• for emitted interference	EN 61000-6-4 (Class A)	EN 61000-6-4 (Class A)	EN 61000-6-4 (Class A)	EN 61000-6-4 (Class A)
• for interference immunity	EN 61000-6-2	EN 61000-6-2	EN 61000-6-2	EN 61000-6-2
Verification of suitability	EN 61000-6-2, EN 61000-6-4	EN 61000-6-2, EN 61000-6-4	EN 61000-6-2, EN 61000-6-4	EN 61000-6-2, EN 61000-6-4
• CE mark	Yes	Yes	Yes	Yes
• C-Tick	Yes	Yes	Yes	Yes

Article No.	6GK5524-8GS00-2AR2	6GK5524-8GS00-4AR2 6GK5524-8GS00-3AR2	6GK5524-8GR00-2AR2	6GK5524-8GR00-4AR2 6GK5524-8GR00-3AR2
Product-type designation	SCALANCE XR524-8C	SCALANCE XR524-8C	SCALANCE XR524-8C	SCALANCE XR524-8C
<b>Transmission rate</b>				
Transfer rate 1	10 Mbit/s	10 Mbit/s	10 Mbit/s	10 Mbit/s
Transfer rate 2	100 Mbit/s	100 Mbit/s	100 Mbit/s	100 Mbit/s
Transfer rate 3	1 000 Mbit/s	1 000 Mbit/s	1 000 Mbit/s	1 000 Mbit/s
Transfer rate 4	-	-	-	-
<b>Interfaces</b>				
Number of electrical/optical connections for network components or terminal equipment maximum	24	24	24	24
Number of electrical connections				
• for SFP+/SFP	8	8	8	8
• for operator console	1	1	1	1
• for management purposes	1	1	1	1
• for signaling contact	1	1	1	1
• for power supply	1	1	1	1
• for redundant power supply	1	1	1	1
Design of electrical connection				
• for network components and terminal equipment	RJ45 port	RJ45 port	RJ45 port	RJ45 port
• for operator console	RJ11 port	RJ11 port	RJ11 port	RJ11 port
• for management purposes	RJ45 port	RJ45 port	RJ45 port	RJ45 port
• for signaling contact	2-pole terminal block	2-pole terminal block	2-pole terminal block	2-pole terminal block
• for power supply	4-pole terminal block	4-pole terminal block	4-pole terminal block	4-pole terminal block
Design of optical interface for fibre optic cable				
• at 100 Mbit/s	SFP slot	SFP slot	SFP slot	SFP slot
• at 1 000 Mbit/s	SFP slot	SFP slot	SFP slot	SFP slot
Design of the removable storage C-PLUG/KEY-PLUG	Yes	Yes	Yes	Yes

**Technical specifications (continued)**

Article No.	6GK5524-8GS00-2AR2	6GK5524-8GS00-4AR2 6GK5524-8GS00-3AR2	6GK5524-8GR00-2AR2	6GK5524-8GR00-4AR2 6GK5524-8GR00-3AR2
Product-type designation	SCALANCE XR524-8C	SCALANCE XR524-8C	SCALANCE XR524-8C	SCALANCE XR524-8C
<b>Signal-Inputs/outputs</b>				
Operating voltage of signaling contacts at DC rated value	24 V	24 V	24 V	24 V
Operating current of signaling contacts at DC maximum	0.1 A	0.1 A	0.1 A	0.1 A
<b>Supply voltage, current consumption, power loss</b>				
Type of supply voltage	DC	AC	DC	AC
Supply voltage external	24 V	-	24 V	-
• minimum	19.2 V	-	19.2 V	-
• maximum	28.8 V	-	28.8 V	-
Product component fusing at power supply input	Yes	Yes	Yes	Yes
Type of fusing at input for supply voltage	3.15 A / 125 V	3.15 A / 250 V	3.15 A / 125 V	3.15 A / 250 V
<b>Permitted ambient conditions</b>				
Ambient temperature				
• during operating	0 ... 60 °C	0 ... 60 °C	0 ... 60 °C	0 ... 60 °C
• during storage	-40 ... +70 °C	-40 ... +70 °C	-40 ... +70 °C	-40 ... +70 °C
• during transport	-40 ... +70 °C	-40 ... +70 °C	-40 ... +70 °C	-40 ... +70 °C
Relative humidity at 25 °C without condensation during operating maximum	95 %	95 %	95 %	95 %
Protection class IP	IP20	IP20	IP20	IP20
<b>Design, dimensions and weight</b>				
Design	19" rack	19" rack	19" rack	19" rack
Width	449 mm	449 mm	449 mm	449 mm
Height	44 mm	44 mm	44 mm	44 mm
Depth	305 mm	305 mm	305 mm	305 mm
Net weight	5 kg	5.5 kg	5 kg	5.5 kg
Mounting type 19-inch installation	Yes	Yes	Yes	Yes
Type of cable outlet	Cable outlet at front	Cable outlet at front	Cable outlet at front	Cable outlet at front
<b>Product properties, functions, components general</b>				
Cascading in cases of star structuring	Any (depending only on signal propagation time)	Any (depending only on signal propagation time)	Any (depending only on signal propagation time)	Any (depending only on signal propagation time)
<b>Product functions management, configuration</b>				
Product function				
• CLI	Yes	Yes	Yes	Yes
• web-based management	Yes	Yes	Yes	Yes
• MIB support	Yes	Yes	Yes	Yes
• TRAPs via email	Yes	Yes	Yes	Yes
• Configuration with STEP 7	Yes	Yes	Yes	Yes
• RMON	Yes	Yes	Yes	Yes
• Port mirroring	Yes	Yes	Yes	Yes
• CoS	Yes	Yes	Yes	Yes
• PROFINET IO diagnosis	Yes	Yes	Yes	Yes
• switch-managed	Yes	Yes	Yes	Yes

## PROFINET/Industrial Ethernet

### Industrial Ethernet Layer 3 Switches / Routers

#### SCALANCE XR-500 managed

#### Technical specifications (continued)

Article No.	6GK5524-8GS00-2AR2	6GK5524-8GS00-4AR2 6GK5524-8GS00-3AR2	6GK5524-8GR00-2AR2	6GK5524-8GR00-4AR2 6GK5524-8GR00-3AR2
Product-type designation	SCALANCE XR524-8C	SCALANCE XR524-8C	SCALANCE XR524-8C	SCALANCE XR524-8C
Protocol is supported				
• Telnet	Yes	Yes	Yes	Yes
• HTTP	Yes	Yes	Yes	Yes
• HTTPS	Yes	Yes	Yes	Yes
• TFTP	Yes	Yes	Yes	Yes
• FTP	Yes	Yes	Yes	Yes
• BOOTP	Yes	Yes	Yes	Yes
• SNMP v1	Yes	Yes	Yes	Yes
• SNMP v2	Yes	Yes	Yes	Yes
• SNMP v3	Yes	Yes	Yes	Yes
• IGMP (snooping/querier)	Yes	Yes	Yes	Yes
• GMRP	Yes	Yes	Yes	Yes
• DCP	Yes	Yes	Yes	Yes
• LLDP	Yes	Yes	Yes	Yes
Identification & maintenance function				
• I&M0 - device-specific information	Yes	Yes	Yes	Yes
• I&M1 - higher level designation/location designation	Yes	Yes	Yes	Yes
<b>Product functions Diagnosis</b>				
Product function				
• Port diagnostics	Yes	Yes	Yes	Yes
• Statistics packet size	Yes	Yes	Yes	Yes
• Statistics packet type	Yes	Yes	Yes	Yes
• Error statistics	Yes	Yes	Yes	Yes
• SysLog	Yes	Yes	Yes	Yes
<b>Product functions VLAN</b>				
Product function				
• VLAN - port based	Yes	Yes	Yes	Yes
• VLAN - protocol-based	Yes	Yes	Yes	Yes
• VLAN - IP-based	Yes	Yes	Yes	Yes
• VLAN dynamic	Yes	Yes	Yes	Yes
Number of VLANs maximum	255	255	255	255
Number of VLANs - dynamic maximum	255	255	255	255
Protocol is supported GVRP	Yes	Yes	Yes	Yes
<b>Product functions DHCP</b>				
Product function				
• DHCP client	Yes	Yes	Yes	Yes
• DHCP Option 82	Yes	Yes	Yes	Yes
• DHCP Option 66	Yes	Yes	Yes	Yes
• DHCP Option 67	Yes	Yes	Yes	Yes
<b>Product functions Routing</b>				
Service Routing Note	IP routing in connection with KEY-PLUG	IP routing in connection with KEY-PLUG	IP routing in connection with KEY-PLUG	IP routing in connection with KEY-PLUG
Product function				
• static IP routing	-	-	Yes	Yes
• static IP routing IPv6	-	-	No	No
• dynamic IP routing	-	-	Yes	Yes
• dynamic IP routing IPv6	-	-	No	No
Protocol is supported				
• RIPv2	-	-	Yes	Yes
• RIPnG for IPv6	-	-	No	No
• OSPFv2	-	-	Yes	Yes
• OSPFv3 for IPv6	-	-	No	No
• VRRP	-	-	Yes	Yes
• VRRP for IPv6	-	-	No	No



### Technical specifications (continued)

Article No.	6GK5524-8GS00-2AR2	6GK5524-8GS00-4AR2 6GK5524-8GS00-3AR2	6GK5524-8GR00-2AR2	6GK5524-8GR00-4AR2 6GK5524-8GR00-3AR2
Product-type designation	SCALANCE XR524-8C	SCALANCE XR524-8C	SCALANCE XR524-8C	SCALANCE XR524-8C
<b>Product functions Redundancy</b>				
Product function				
• Ring redundancy	Yes	Yes	Yes	Yes
• Redundancy manager	Yes	Yes	Yes	Yes
• Standby redundancy	Yes	Yes	Yes	Yes
• High Speed Redundancy Protocol (HRP)	Yes	Yes	Yes	Yes
• Media Redundancy Protocol (MRP)	Yes	Yes	Yes	Yes
• Redundancy procedure STP	Yes	Yes	Yes	Yes
• RSTP redundancy protocol	Yes	Yes	Yes	Yes
• Redundancy procedure MSTP	Yes	Yes	Yes	Yes
• Passive listening	Yes	Yes	Yes	Yes
Protocol is supported				
• LACP	Yes	Yes	Yes	Yes
<b>Product functions Security</b>				
Product function				
• ACL - MAC-based	Yes	Yes	Yes	Yes
• ACL - port/MAC-based	Yes	Yes	Yes	Yes
• IEEE 802.1x (radius)	Yes	Yes	Yes	Yes
• Broadcast/Multicast/Unicast Limiter	Yes	Yes	Yes	Yes
• broadcast blocking	Yes	Yes	Yes	Yes
Protocol is supported SSH	Yes	Yes	Yes	Yes
<b>Product functions Time</b>				
Product function SICLOCK support	Yes	Yes	Yes	Yes
Protocol is supported				
• NTP	Yes	Yes	Yes	Yes
• SNTP	Yes	Yes	Yes	Yes
Type of time synchronization	IEEE 1588 available soon	IEEE 1588 available soon	IEEE 1588 available soon	IEEE 1588 available soon
<b>Standards, specifications, approvals</b>				
Standard				
• for hazardous area of CSA and UL	available soon	available soon	available soon	available soon
• for emitted interference	EN 61000-6-4 (Class A)	EN 61000-6-4 (Class A)	EN 61000-6-4 (Class A)	EN 61000-6-4 (Class A)
• for interference immunity	EN 61000-6-2	EN 61000-6-2	EN 61000-6-2	EN 61000-6-2
Verification of suitability				
	EN 61000-6-2, EN 61000-6-4	EN 61000-6-2, EN 61000-6-4	EN 61000-6-2, EN 61000-6-4	EN 61000-6-2, EN 61000-6-4
• CE mark	Yes	Yes	Yes	Yes
• C-Tick	Yes	Yes	Yes	Yes

## PROFINET/Industrial Ethernet

### Industrial Ethernet Layer 3 Switches / Routers

#### SCALANCE XR-500 managed

#### Ordering data

#### Article No.

#### Article No.

##### SCALANCE XR-500 Industrial Ethernet switches

Layer 3-enabled Industrial Ethernet switches for establishing electrical and/or optical Industrial Ethernet networks;  
with data transfer rates up to 10 Gbit/s, designed for installation in 19" control cabinets

##### SCALANCE XR552-12M

4 x integral 1/10 Gbps SFP+ slots for SFP or SFP+ plug-in transceivers  
12 x 10/100/1 000 Mbps slots for 4-port media modules, electrical or optical

Layer 2,  
upgrade to Layer 3 possible

- Ports at front
- Ports at rear

**6GK5552-0AA00-2AR2**  
**6GK5552-0AA00-2HR2**

##### Layer 3

- Ports at front
- Ports at rear

**6GK5552-0AR00-2AR2**  
**6GK5552-0AR00-2HR2**

##### SCALANCE XR528-6M

4 x integral 1/10 Gbps SFP+ slots for SFP or SFP+ plug-in transceivers  
6 x 10/100/1 000 Mbps slots for 4-port media modules, electrical or optical

Layer 2,  
upgrade to Layer 3 possible

- Ports at front
- Ports at rear

**6GK5528-0AA00-2AR2**  
**6GK5528-0AA00-2HR2**

##### Layer 3

- Ports at front
- Ports at rear

**6GK5528-0AR00-2AR2**  
**6GK5528-0AR00-2HR2**

##### SCALANCE XR524-8C

24 x 10/100/1 000 Mbit/s, of which 8 x RJ45/SFP combo ports;  
24 x 1 000 Mbit/s maximum usable

Layer 2,  
upgrade to Layer 3 possible

- Redundant 24 V DC voltage supply
- Redundant 230 V AC voltage supply

**6GK5524-8GA00-2AR2**  
**6GK5524-8GA00-4AR2**

##### Layer 3

- Redundant 24 V DC voltage supply
- Redundant 230 V AC voltage supply

**6GK5524-8GR00-2AR2**  
**6GK5524-8GR00-4AR2**

##### Accessories

##### FAN597-1

Replacement fan slide-in unit for SCALANCE XR552-12M

**6GK5597-1AA00-8AA0**

##### FAN597-2

Replacement fan slide-in unit for SCALANCE XR528-6M

**6GK5597-2AA00-8AA0**

##### KEY-PLUG X-500

Swap medium for expansion of the device functions with IP routing (Layer 3), for integration of configuration data and for easy replacement of SCALANCE X-500 in the event of a fault

**6GK5905-0PA00**

##### Media modules

See "Media modules for modular SCALANCE X-500 managed"

##### Power supply

See "Power supply for modular SCALANCE X-500 managed"

#### More information

##### Selection tool:

To assist in selecting the right Industrial Ethernet switches as well as configuration of modular variants, the SIMATIC NET Selection Tool and the TIA Selection Tool are available at:

SIMATIC NET Selection Tool:

- Online version:  
<http://www.siemens.com/snst>
- Offline version:  
<http://www.siemens.com/snst-download>

TIA Selection Tool:

<http://www.siemens.com/tia-selection-tool>

### Overview

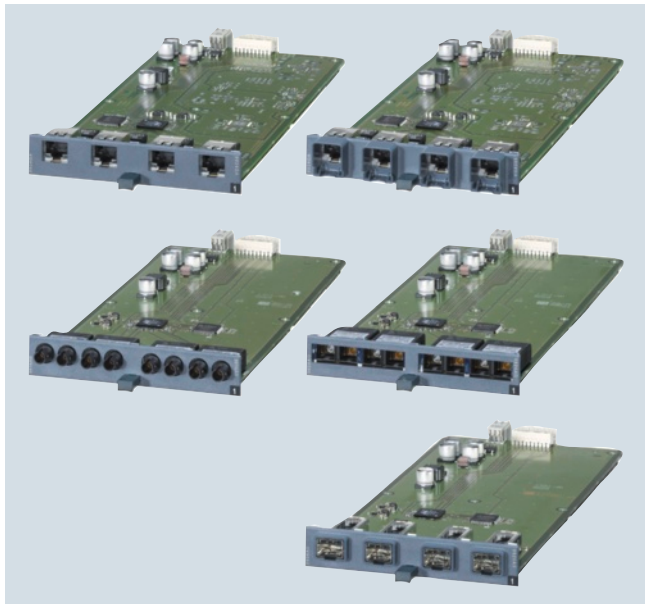

- 4-port media modules for flexible, 4-port-granular equipping of SCALANCE X-500 Industrial Ethernet switches
- Electrical versions with RJ45 ports are available as well as optical versions with BFOC and SC ports for the use of multi-mode and single-mode fiber-optic cables
- Using a 4-port SFP media module, the optional use of fiber-optic SFP plug-in transceivers (small form-factor pluggable) with LC connection technology is possible
- SFP+ and SFP plug-in transceivers for flexible equipping of the four integral SFP+ slots in SCALANCE X-500

### Benefits

get **Designed for Industry**

- Unlimited flexibility during network expansions (e.g. more terminal devices), conversion (e.g. switching from copper to fiber-optic cables), or performance enhancement (e.g. from Gigabit to 10 Gigabit) through modular construction using media modules and SFP+ or SFP plug-in transceivers
- Reduction of storage costs and maintenance overhead by focusing on a few basic device versions

### Application

Use of media modules in the SCALANCE X-500 switches enables:

- Extension of networks by subsequent insertion of additional media modules in unused media module slots (possible during operation)
- Extension of networks by subsequent insertion of additional SFP+ or SFP plug-in transceivers in unused SFP+ slots (possible during operation)
- Changing of cabling technology (e.g. conversion from copper to fiber-optic cables, or from multimode to singlemode FOC)
- Change of the data transfer rate (e.g. conversion from SFP plug-in transceivers (1 000 Mbit/s) to SFP+ plug-in transceivers (10 Gbit/s))

## PROFINET/Industrial Ethernet

### Industrial Ethernet Layer 3 Switches / Routers

#### Media modules for modular SCALANCE XR-500 managed

#### Design

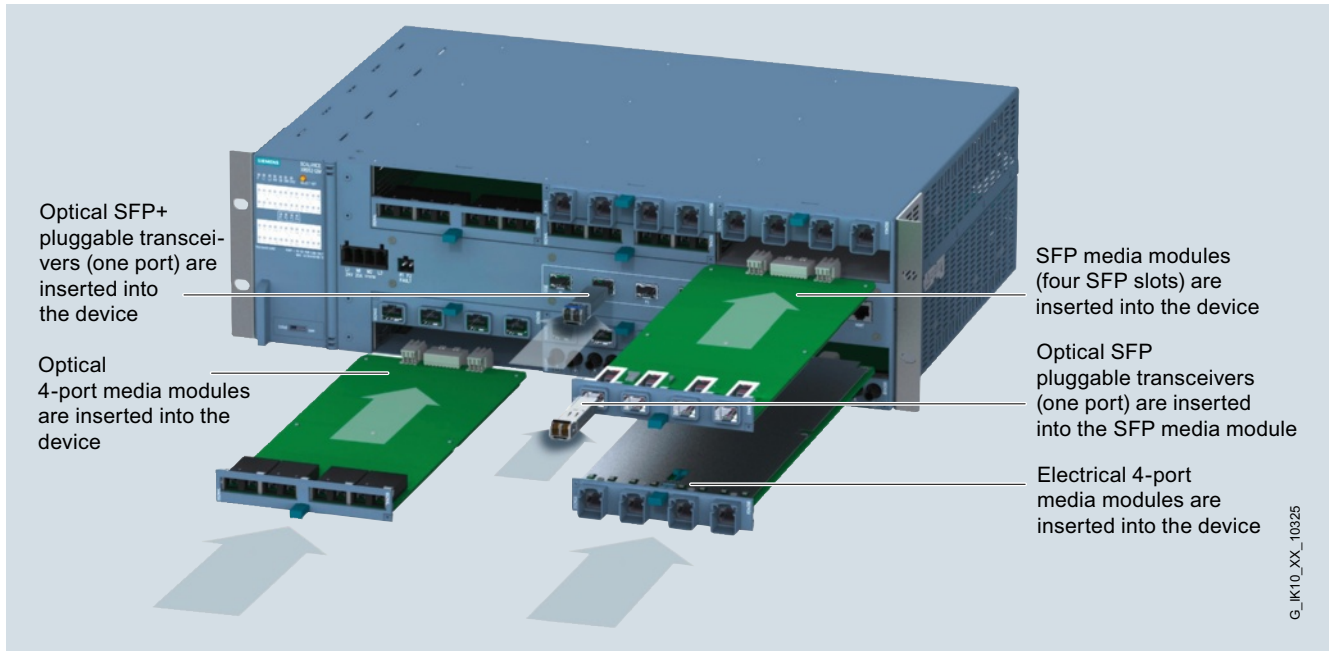

4-port media modules plugged into media module slot and SFP/SFP+ plug-in transceivers in SFP+ slots

#### Product versions of media modules

##### Electrical media modules with 4 x 10/100/1 000 Mbit/s RJ45 ports

- MM992-4CUC with retaining collar
- MM992-4CU without retaining collar

##### Electrical media modules with 4 x 10/100/1 000 Mbit/s RJ45 ports and PoE

- MM992-4PoEC with retaining collar
- MM992-4PoE without retaining collar

##### Optical media modules with 4 x 100 Mbit/s BFOC ports

- MM991-4 multimode, glass, up to 5 km
- MM991-4LD singlemode, glass, up to max. 26 km

##### Optical media modules with 4 x 1 000 Mbit/s SC ports

- MM992-4 multimode, glass, up to 750 m
- MM992-4LD single-mode, glass, up to 10 km

##### Optical media modules with 4 x 100/1 000 Mbit/s for SFP pluggable transceiver

- MM992-4SFP for SFP plug-in transceivers with 1 x 100 Mbit/s or 1 x 1 000 Mbit/s multimode or singlemode, glass

#### Product versions of SFP pluggable transceivers

The SFP plug-in transceivers (small form-factor pluggable) can be used together with the SFP media module MM992-4SFP, and in the integral SFP+ slots of the SCALANCE X-500.

##### Optical SFP pluggable transceivers with 1x 100 Mbit/s LC port

- SFP991-1 multimode, glass, up to 5 km
- SFP991-1LD singlemode, glass, up to 26 km
- SFP991-1LH+ singlemode, glass, up to 70 km
- SFP991-1ELH200 singlemode, glass, up to 200 km

##### Optical SFP pluggable transceivers with 1 x 1 000 Mbit/s LC port

- SFP992-1 multimode, glass, up to 750 m
- SFP992-1LD singlemode, glass, up to 10 km
- SFP992-1LH singlemode, glass, up to 40 km
- SFP992-1LH+ singlemode, glass, up to 70 km
- SFP992-1ELH singlemode, glass, up to 120 km

**Design** (continued)**Product versions of SFP+ pluggable transceivers**

The SFP+ pluggable transceivers (small form-factor pluggable) can only be used in the integral SFP+ slots of the SCALANCE X-500.

**Optical SFP+ pluggable transceivers with 1 x 10 Gbit/s LC ports**

- SFP993-1 multimode, glass, up to max 300 m
- SFP993-1LD single-mode, glass, up to 10 km
- SFP993-1LH singlemode, glass, up to max 40 km

**Electrically preassembled SFP+/SFP+****Connecting cable with 10 Gbit/s**

The IE connecting cable SFP+/SFP+ is preassembled at both ends and suitable for the transmission of 10 Gbit/s Ethernet. The cables have SFP+ connectors for use in the SFP+ slots of the SCALANCE X-500 series and therefore offer the possibility of connecting SCALANCE X-500 switches cost-effectively over short distances with a bandwidth of 10 Gbit/s. The SFP+/SFP+ connecting cables can only be used in the integrated SFP+ slots of the SCALANCE X-500.

- IE connecting cable SFP+/SFP+ 1 m; Twinax copper cable with a length of 1 m
- IE connecting cable SFP+/SFP+ 2 m; Twinax copper cable with a length of 2 m
- IE connecting cable SFP+/SFP+ 7 m; Twinax copper cable with a length of 7 m

Type of module	Type and quantity of ports								Max. distance
	10 Gigabit Ethernet		Gigabit Ethernet			Fast Ethernet			
	10000 Mbit/s		10 / 100 / 1000 Mbit/s	1000 Mbit/s		100 Mbit/s			
	Optical		Electrical	Optical		Optical			
	Multimode	Singlemode	Twisted Pair	Multimode	Singlemode	Multimode	Singlemode		
<b>Media modules</b>									
MM992-4CUC			4x RJ45 <sup>1)</sup>						100 m
MM992-4CU			4x RJ45						100 m
MM992-4PoEC			4x RJ45 <sup>1)</sup>						100 km
MM992-4PoE			4x RJ45						100 km
MM991-4						4x BFOC			5 km
MM991-4LD							4x BFOC		26 km
MM992-4				4x SC					5 km
MM992-4LD					4x SC				10 km
MM992-4SFP				4x LC <sup>2)</sup>	4x LC <sup>2)</sup>	4x LC <sup>2)</sup>	4x LC <sup>2)</sup>		
<b>SFP-Module</b>									
SFP991-1 <sup>3)</sup>						1x LC			5 km
SFP991-1LD <sup>3)</sup>							1x LC		26 km
SFP991-1LH <sup>3)</sup>							1x LC		70 km
SFP991-1ELH200 <sup>3)</sup>							1x LC		200 km
SFP992-1 <sup>3) 4)</sup>				1x LC					750 m
SFP992-1LD <sup>3) 4)</sup>					1x LC				10 km
SFP992-1LH <sup>3) 4)</sup>					1x LC				40 km
SFP992-1LH <sup>3) 4)</sup>					1x LC				70 km
SFP992-1ELH <sup>3) 4)</sup>					1x LC				120 km
<b>SFPplus-Module<sup>4)</sup></b>									
SFP993-1	1x LC								300 m
SFP993-1LD		1x LC							10 km
SFP993-1LH		1x LC							40 km

<sup>1)</sup> With retaining collars

<sup>2)</sup> The MM992-4SFP SFP slot module can accommodate up to four 1-port SFP modules

<sup>3)</sup> Can only be plugged into an MM992-4SFP slot module

<sup>4)</sup> Pluggable in XR-500 SFPplus slots only

Overview of media modules for SCALANCE X-500

## PROFINET/Industrial Ethernet

### Industrial Ethernet Layer 3 Switches / Routers

#### Media modules for modular SCALANCE XR-500 managed

#### Technical specifications

Article No.	6GK5992-4GA00-8AA0	6GK5992-4SA00-8AA0	6GK5992-4RA00-8AA0	6GK5992-4QA00-8AA0
Product-type designation	MM992-4CUC	MM992-4CU	MM992-4POEC	MM992-4POE
<b>Interfaces</b>				
Number of electrical/optical connections for network components or terminal equipment maximum	4	4	4	4
Number of 10/100/1 000 Mbit/s M12 ports	-	-	-	-
Number of 10/100/1 000 Mbit/s RJ45 ports	4	4	2	2
Number of electrical connections				
• for Power-over-Ethernet for network components or terminal equipment	-	-	4	4
• for SFP+/SFP	-	-	-	-
Design of electrical connection				
• for network components and terminal equipment	RJ45	RJ45	RJ45	RJ45
• for Power-over-Ethernet for network components or terminal equipment	-	-	-	-
Number of 100 Mbit/s ST(BFOC) ports	-	-	-	-
Number of 100 Mbit/s SC ports	-	-	-	-
Number of 100 Mbit/s LC ports	-	-	-	-
Number of 1 000 Mbit/s LC ports (LX)	-	-	-	-
Number of 1 000 Mbit/s LC ports (SX)	-	-	-	-
Number of 1 000 Mbit/s SC ports (LX)	-	-	-	-
Number of 1 000 Mbit/s SC ports (SX)	-	-	-	-
Number of 10 Gbit/s LC ports (LX)	-	-	-	-
Number of 10 Gbit/s LC ports (SX)	-	-	-	-
Design of optical connections for network components or terminal devices	-	-	-	-
Connectable optical power relative to 1 mW				
• of the transmitter output	-	-	-	-
• of the receiver input maximum	-	-	-	-
Optical sensitivity relative to 1 mW of the receiver input minimum	-	-	-	-
Attenuation of fiber-optic cable transmission link minimum necessary	-	-	-	-
Range at the optical interface depending on the optical fiber used	-	-	-	-
<b>Permitted ambient conditions</b>				
Ambient temperature				
• during operating	0 ... 60 °C	0 ... 60 °C	0 ... 60 °C	0 ... 60 °C
• during storage	-40 ... +70 °C	-40 ... +70 °C	-40 ... +70 °C	-40 ... +70 °C
• during transport	-40 ... +70 °C	-40 ... +70 °C	-40 ... +70 °C	-40 ... +70 °C
Relative humidity at 25 °C without condensation during operating maximum	95 %	95 %	95 %	95 %
Ambient condition for (standard) operation mode	-	-	-	-
Protection class IP	IP20	IP20	IP20	IP20

## PROFINET/Industrial Ethernet

### Industrial Ethernet Layer 3 Switches / Routers

#### Media modules for modular SCALANCE XR-500 managed

#### Technical specifications (continued)

Article No.	6GK5992-4GA00-8AA0	6GK5992-4SA00-8AA0	6GK5992-4RA00-8AA0	6GK5992-4QA00-8AA0
Product-type designation	MM992-4CUC	MM992-4CU	MM992-4POEC	MM992-4POE
<b>Design, dimensions and weight</b>				
Design	Media module	Media module	Media module	Media module
Width	120.3 mm	120.3 mm	120.3 mm	120.3 mm
Height	22.3 mm	22.3 mm	22.3 mm	22.3 mm
Depth	275.5 mm	275.5 mm	275.5 mm	275.5 mm
Net weight	0.3 kg	0.3 kg	0.3 kg	0.3 kg
Mounting type Installation in media module slot	Yes	Yes	Yes	Yes
Mounting type	Latched	Latched	Latched	Latched
<b>Standards, specifications, approvals</b>				
Standard				
• for EMC	-	-	-	-
• for EMC from FM	-	-	-	-
• for hazardous zone	-	-	-	-
• for safety of CSA and UL	UL 60950-1, CSA C22.2 No. 60950-4	UL 60950-1, CSA C22.2 No. 60950-7	UL 60950-1, CSA C22.2 No. 60950-6	UL 60950-1, CSA C22.2 No. 60950-5
• for hazardous area of CSA and UL	-	-	-	-
• for emitted interference	EN 61000-6-4 (Class A)	EN 61000-6-4 (Class A)	EN 61000-6-4 (Class A)	EN 61000-6-4 (Class A)
• for interference immunity	EN 61000-6-2	EN 61000-6-2	EN 61000-6-2	EN 61000-6-2
Verification of suitability	EN 61000-6-2, EN 61000-6-7	EN 61000-6-2, EN 61000-6-10	EN 61000-6-2, EN 61000-6-9	EN 61000-6-2, EN 61000-6-8
• CE mark	Yes	Yes	Yes	Yes
• C-Tick	Yes	Yes	Yes	Yes
• KC approval	Yes	Yes	No	No
• Railway application in accordance with EN 50155	-	-	-	-
• Railway application in accordance with EN 50124-1	-	-	-	-
• IEC 61850-3	-	-	-	-
Marine classification association				
• American Bureau of Shipping Europe Ltd. (ABS)	-	-	-	-
• Bureau Veritas (BV)	-	-	-	-
• Det Norske Veritas (DNV)	-	-	-	-
• Germanische Lloyd (GL)	-	-	-	-
• Lloyds Register of Shipping (LRS)	-	-	-	-
• Nippon Kaiji Kyokai (NK)	-	-	-	-

Article No.	6GK5991-4AB00-8AA0	6GK5991-4AC00-8AA0
Product-type designation	MM991-4	MM991-4LD
<b>Interfaces</b>		
Number of electrical/optical connections for network components or terminal equipment maximum	4	4
Number of 10/100/1 000 Mbit/s M12 ports	-	-
Number of 10/100/1 000 Mbit/s RJ45 ports	-	-
Number of electrical connections		
• for Power-over-Ethernet for network components or terminal equipment	-	-
• for SFP+/SFP	-	-
Design of electrical connection		
• for network components and terminal equipment	-	-
• for Power-over-Ethernet for network components or terminal equipment	-	-

## PROFINET/Industrial Ethernet

### Industrial Ethernet Layer 3 Switches / Routers

#### Media modules for modular SCALANCE XR-500 managed

#### Technical specifications (continued)

Article No.	6GK5991-4AB00-8AA0	6GK5991-4AC00-8AA0
Product-type designation	MM991-4	MM991-4LD
Number of 100 Mbit/s ST(BFOC) ports	4	4
Number of 100 Mbit/s SC ports	-	-
Number of 100 Mbit/s LC ports	-	-
Number of 1 000 Mbit/s LC ports (LX)	-	-
Number of 1 000 Mbit/s LC ports (SX)	-	-
Number of 1 000 Mbit/s SC ports (LX)	-	-
Number of 1 000 Mbit/s SC ports (SX)	-	-
Number of 10 Gbit/s LC ports (LX)	-	-
Number of 10 Gbit/s LC ports (SX)	-	-
Design of optical connections for network components or terminal devices	BFOC	BFOC
Connectable optical power relative to 1 mW		
• of the transmitter output	-19 ... -14 dB	-15 ... -8 dB
• of the receiver input	-3 dB	-3 dB
Optical sensitivity relative to 1 mW of the receiver input minimum	-32 dB	-34 dB
Attenuation of fiber-optic cable transmission link minimum necessary	0 dB	0 dB
Range at the optical interface depending on the optical fiber used	0 ... 5 km	0 ... 26 km
<b>Permitted ambient conditions</b>		
Ambient temperature		
• during operating	0 ... 60 °C	0 ... 60 °C
• during storage	-40 ... +70 °C	-40 ... +70 °C
• during transport	-40 ... +70 °C	-40 ... +70 °C
Relative humidity at 25 °C without condensation during operating maximum	95 %	95 %
Ambient condition for (standard) operation mode	-	-
Protection class IP	IP20	IP20
<b>Design, dimensions and weight</b>		
Design	Media module	Media module
Width	120.3 mm	120.3 mm
Height	22.3 mm	22.3 mm
Depth	275.5 mm	275.5 mm
Net weight	0.3 kg	0.3 kg
Mounting type Installation in media module slot	Yes	Yes
Mounting type	Latched	Latched
<b>Standards, specifications, approvals</b>		
Standard		
• for EMC	-	-
• for EMC from FM	-	-
• for hazardous zone	-	-
• for safety of CSA and UL	UL 60950-1, CSA C22.2 No. 60950-1	UL 60950-1, CSA C22.2 No. 60950-1
• for hazardous area of CSA and UL	-	-
• for emitted interference	EN 61000-6-4 (Class A)	EN 61000-6-4 (Class A)
• for interference immunity	EN 61000-6-2	EN 61000-6-2



### Technical specifications (continued)

Article No.	6GK5991-4AB00-8AA0	6GK5991-4AC00-8AA0
Product-type designation	MM991-4	MM991-4LD
Verification of suitability	EN 61000-6-2, EN 61000-6-4	EN 61000-6-2, EN 61000-6-4
• CE mark	Yes	Yes
• C-Tick	Yes	Yes
• KC approval	Yes	Yes
• Railway application in accordance with EN 50155	-	-
• Railway application in accordance with EN 50124-1	-	-
• IEC 61850-3	-	-
Marine classification association		
• American Bureau of Shipping Europe Ltd. (ABS)	-	-
• Bureau Veritas (BV)	-	-
• Det Norske Veritas (DNV)	-	-
• Germanische Lloyd (GL)	-	-
• Lloyds Register of Shipping (LRS)	-	-
• Nippon Kaiji Kyokai (NK)	-	-

Article No.	6GK5992-4AL00-8AA0	6GK5992-4AM00-8AA0	6GK5992-4AS00-8AA0
Product-type designation	MM992-4	MM992-4LD	MM992-4SFP
<b>Interfaces</b>			
Number of electrical/optical connections for network components or terminal equipment maximum	4	4	4
Number of 10/100/1 000 Mbit/s M12 ports	-	-	-
Number of 10/100/1 000 Mbit/s RJ45 ports	-	-	-
Number of electrical connections			
• for Power-over-Ethernet for network components or terminal equipment	-	-	-
• for SFP+/SFP	-	-	4
Design of electrical connection			
• for network components and terminal equipment	-	-	-
• for Power-over-Ethernet for network components or terminal equipment	-	-	-
Number of 100 Mbit/s ST(BFOC) ports	-	-	-
Number of 100 Mbit/s SC ports	-	-	-
Number of 100 Mbit/s LC ports	-	-	-
Number of 1 000 Mbit/s LC ports (LX)	-	-	-
Number of 1 000 Mbit/s LC ports (SX)	-	-	-
Number of 1 000 Mbit/s SC ports (LX)	-	4	-
Number of 1 000 Mbit/s SC ports (SX)	4	-	-
Number of 10 Gbit/s LC ports (LX)	-	-	-
Number of 10 Gbit/s LC ports (SX)	-	-	-
Design of optical connections for network components or terminal devices	SC	SC	-
Connectable optical power relative to 1 mW			
• of the transmitter output	-9.5 ... -4 dB	-9.5 ... -3 dB	--
• of the receiver input maximum	-3 dB	-3 dB	-
Optical sensitivity relative to 1 mW of the receiver input minimum	-17 dB	-21 dB	-
Attenuation of fiber-optic cable transmission link minimum necessary	0 dB	0 dB	-
Range at the optical interface depending on the optical fiber used	0 ... 0.75 km	0 ... 10 km	--

## PROFINET/Industrial Ethernet

### Industrial Ethernet Layer 3 Switches / Routers

#### Media modules for modular SCALANCE XR-500 managed

#### Technical specifications (continued)

Article No.	6GK5992-4AL00-8AA0	6GK5992-4AM00-8AA0	6GK5992-4AS00-8AA0
Product-type designation	MM992-4	MM992-4LD	MM992-4SFP
<b>Permitted ambient conditions</b>			
Ambient temperature			
• during operating	0 ... 60 °C	0 ... 60 °C	0 ... 60 °C
• during storage	-40 ... 70 °C	-40 ... 70 °C	-40 ... 70 °C
• during transport	-40 ... 70 °C	-40 ... 70 °C	-40 ... 70 °C
Relative humidity at 25 °C without condensation during operating maximum	95 %	95 %	95 %
Ambient condition for (standard) operation mode	-	-	-
Protection class IP	IP20	IP20	IP20
<b>Design, dimensions and weight</b>			
Design	Media module	Media module	Media module
Width	120.3 mm	120.3 mm	120.3 mm
Height	22.3 mm	22.3 mm	22.3 mm
Depth	275.5 mm	275.5 mm	275.5 mm
Net weight	0.3 kg	0.3 kg	0.3 kg
Mounting type Installation in media module slot	Yes	Yes	Yes
Mounting type	Latched	Latched	Latched
<b>Standards, specifications, approvals</b>			
Standard			
• for EMC	-	-	-
• for EMC from FM	-	-	-
• for hazardous zone	-	-	-
• for safety of CSA and UL	UL 60950-1, CSA C22.2 No. 60950-1	UL 60950-1, CSA C22.2 No. 60950-2	UL 60950-1, CSA C22.2 No. 60950-3
• for hazardous area of CSA and UL	-	-	-
• for emitted interference	EN 61000-6-4 (Class A)	EN 61000-6-4 (Class A)	EN 61000-6-4 (Class A)
• for interference immunity	EN 61000-6-2	EN 61000-6-2	EN 61000-6-2
Verification of suitability	EN 61000-6-2, EN 61000-6-4	EN 61000-6-2, EN 61000-6-5	EN 61000-6-2, EN 61000-6-6
• CE mark	Yes	Yes	Yes
• C-Tick	Yes	Yes	Yes
• KC approval	Yes	Yes	Yes
• Railway application in accordance with EN 50155	-	-	-
• Railway application in accordance with EN 50124-1	-	-	-
• IEC 61850-3	-	-	-
Marine classification association			
• American Bureau of Shipping Europe Ltd. (ABS)	-	-	-
• Bureau Veritas (BV)	-	-	-
• Det Norske Veritas (DNV)	-	-	-
• Germanische Lloyd (GL)	-	-	-
• Lloyds Register of Shipping (LRS)	-	-	-
• Nippon Kaiji Kyokai (NK)	-	-	-

#### Technical specifications (continued)

Article No.	6GK5991-1AD00-8AA0	6GK5991-1AF00-8AA0	6GK5991-1AE00-8AA0	6GK5991-1AE30-8AA0
Product-type designation	SFP991-1	SFP991-1LD	SFP991-1LH+	SFP991-1ELH200
<b>Interfaces</b>				
Number of electrical/optical connections for network components or terminal equipment maximum	1	1	1	1
Number of 10/100/1 000 Mbit/s M12 ports	-	-	-	-
Number of 10/100/1 000 Mbit/s RJ45 ports	-	-	-	-
Number of electrical connections				
• for Power-over-Ethernet for network components or terminal equipment	-	-	-	-
• for SFP+/SFP	-	-	-	-
Design of electrical connection				
• for network components and terminal equipment	-	-	-	-
• for Power-over-Ethernet for network components or terminal equipment	-	-	-	-
Number of 100 Mbit/s ST(BFOC) ports	-	-	-	-
Number of 100 Mbit/s SC ports	-	-	-	-
Number of 100 Mbit/s LC ports	1	1	1	1
Number of 1 000 Mbit/s LC ports (LX)	-	-	-	-
Number of 1 000 Mbit/s LC ports (SX)	-	-	-	-
Number of 1 000 Mbit/s SC ports (LX)	-	-	-	-
Number of 1 000 Mbit/s SC ports (SX)	-	-	-	-
Number of 10 Gbit/s LC ports (LX)	-	-	-	-
Number of 10 Gbit/s LC ports (SX)	-	-	-	-
Design of optical connections for network components or terminal devices	LC	LC	LC	LC
Connectable optical power relative to 1 mW				
• of the transmitter output	-19 ... -14 dB	-15 ... -8 dB	-5 ... +0 dB	1 ... 5 dB
• of the receiver input maximum	-3 dB	-3 dB	-3 dB	-9 dB
Optical sensitivity relative to 1 mW of the receiver input minimum	-32 dB	-34 dB	-34 dB	-42 dB
Attenuation of fiber-optic cable transmission link minimum necessary	0 dB	0 dB	3 dB	14 dB
Range at the optical interface depending on the optical fiber used	0 ... 5 km	0 ... 26 km	12 ... 70 km	61 ... 200 km
<b>Permitted ambient conditions</b>				
Ambient temperature				
• during operating	-40 ... +85 °C	-40 ... +85 °C	-40 ... +85 °C	-40 ... +85 °C
• during storage	-40 ... +85 °C	-40 ... +85 °C	-40 ... +85 °C	-40 ... +85 °C
• during transport	-40 ... +85 °C	-40 ... +85 °C	-40 ... +85 °C	-40 ... +85 °C
Relative humidity at 25 °C without condensation during operating maximum	95 %	95 %	95 %	95 %
Ambient condition for (standard) operation mode	-	-	-	-
Protection class IP	IP20	IP20	IP20	IP20

## PROFINET/Industrial Ethernet

### Industrial Ethernet Layer 3 Switches / Routers

#### Media modules for modular SCALANCE XR-500 managed

#### Technical specifications (continued)

Article No.	6GK5991-1AD00-8AA0	6GK5991-1AF00-8AA0	6GK5991-1AE00-8AA0	6GK5991-1AE30-8AA0
Product-type designation	SFP991-1	SFP991-1LD	SFP991-1LH+	SFP991-1ELH200
<b>Design, dimensions and weight</b>				
Design	SFP Module	SFP Module	SFP Module	SFP Module
Width	13.7 mm	13.7 mm	13.7 mm	13.7 mm
Height	11.9 mm	11.9 mm	11.9 mm	11.9 mm
Depth	56.5 mm	56.5 mm	56.5 mm	56.5 mm
Net weight	0.01 kg	0.01 kg	0.01 kg	0.01 kg
Mounting type Installation in media module slot	-	-	-	-
Mounting type	Latched	Latched	Latched	Latched
<b>Standards, specifications, approvals</b>				
Standard	-	-	-	-
• for EMC	-	-	-	-
• for EMC from FM	FM3611: Class 1, Division 2, Group A, B, C, D / T4, Class 1, Zone 2, Group IIC, T4	FM3611: Class 1, Division 2, Group A, B, C, D / T4, Class 1, Zone 2, Group IIC, T4	FM3611: Class 1, Division 2, Group A, B, C, D / T4, Class 1, Zone 2, Group IIC, T4	FM3611: Class 1, Division 2, Group A, B, C, D / T4, Class 1, Zone 2, Group IIC, T4
• for hazardous zone	EN 60079-0: 2006, EN 60079-15: 2005, II 3 G Ex nA II T4, KEMA 07 ATEX 0145 X	EN 60079-0: 2006, EN 60079-15: 2005, II 3 G Ex nA II T4, KEMA 07 ATEX 0145 X	EN 60079-0: 2006, EN 60079-15: 2005, II 3 G Ex nA II T4, KEMA 07 ATEX 0145 X	EN 60079-0: 2006, EN 60079-15: 2005, II 3 G Ex nA II T4, KEMA 07 ATEX 0145 X
• for safety of CSA and UL	UL 60950-1, CSA C22.2 No. 60950-1-03	UL 60950-1, CSA C22.2 No. 60950-1-03	UL 60950-1, CSA C22.2 No. 60950-1-03	UL 60950-1, CSA C22.2 No. 60950-1-03
• for hazardous area of CSA and UL	-	-	-	-
• for emitted interference	EN 61000-6-4:2007 (Class A)	EN 61000-6-4:2007 (Class A)	EN 61000-6-4:2007 (Class A)	EN 61000-6-4:2007 (Class A)
• for interference immunity	EN 61000-6-2:2005	EN 61000-6-2:2005	EN 61000-6-2:2005	EN 61000-6-2:2005
Verification of suitability	EN 61000-6-2:2005, EN 61000-6-4:2007	EN 61000-6-2:2005, EN 61000-6-4:2007	EN 61000-6-2:2005, EN 61000-6-4:2007	EN 61000-6-2:2005, EN 61000-6-4:2007
• CE mark	Yes	Yes	Yes	Yes
• C-Tick	Yes	Yes	Yes	Yes
• KC approval	No	No	No	No
• Railway application in accordance with EN 50155	-	-	-	-
• Railway application in accordance with EN 50124-1	-	-	-	-
• IEC 61850-3	-	-	-	-
Marine classification association	-	-	-	-
• American Bureau of Shipping Europe Ltd. (ABS)	-	-	-	-
• Bureau Veritas (BV)	-	-	-	-
• Det Norske Veritas (DNV)	-	-	-	-
• Germanische Lloyd (GL)	-	-	-	-
• Lloyds Register of Shipping (LRS)	-	-	-	-
• Nippon Kaiji Kyokai (NK)	-	-	-	-

Article No.	6GK5992-1AL00-8AA0	6GK5992-1AM00-8AA0	6GK5992-1AN00-8AA0
Product-type designation	SFP992-1	SFP992-1LD	SFP992-1LH
<b>Interfaces</b>			
Number of electrical/optical connections for network components or terminal equipment maximum	1	1	1
Number of 10/100/1 000 Mbit/s M12 ports	-	-	-
Number of 10/100/1 000 Mbit/s RJ45 ports	-	-	-
Number of electrical connections	-	-	-
• for Power-over-Ethernet for network components or terminal equipment	-	-	-
• for SFP+/SFP	-	-	-

### Technical specifications (continued)

Article No.	6GK5992-1AL00-8AA0	6GK5992-1AM00-8AA0	6GK5992-1AN00-8AA0
Product-type designation	SFP992-1	SFP992-1LD	SFP992-1LH
Design of electrical connection	-	-	-
• for network components and terminal equipment	-	-	-
• for Power-over-Ethernet for network components or terminal equipment	-	-	-
Number of 100 Mbit/s ST(BFOC) ports	-	-	-
Number of 100 Mbit/s SC ports	-	-	-
Number of 100 Mbit/s LC ports	-	-	-
Number of 1 000 Mbit/s LC ports (LX)	-	1	1
Number of 1 000 Mbit/s LC ports (SX)	1	-	-
Number of 1 000 Mbit/s SC ports (LX)	-	-	-
Number of 1 000 Mbit/s SC ports (SX)	-	-	-
Number of 10 Gbit/s LC ports (LX)	-	-	-
Number of 10 Gbit/s LC ports (SX)	-	-	-
Design of optical connections for network components or terminal devices	LC	LC	LC
Connectable optical power relative to 1 mW			
• of the transmitter output	-9.5 ... -4 dB	-9.5 ... -3 dB	-6 ... +0 dB
• of the receiver input maximum	-3 dB	-3 dB	-3 dB
Optical sensitivity relative to 1 mW of the receiver input minimum	-17 dB	-21 dB	-23 dB
Attenuation of fiber-optic cable transmission link minimum necessary	0 dB	0 dB	3 dB
Range at the optical interface depending on the optical fiber used	0 ... 0.75 km	0 ... 10 km	8 ... 40 km
<b>Permitted ambient conditions</b>			
Ambient temperature			
• during operating	-40 ... +85 °C	-40 ... +85 °C	-40 ... +85 °C
• during storage	-40 ... +85 °C	-40 ... +85 °C	-40 ... +85 °C
• during transport	-40 ... +85 °C	-40 ... +85 °C	-40 ... +85 °C
Relative humidity at 25 °C without condensation during operating maximum	95 %	95 %	95 %
Ambient condition for (standard) operation mode	-	-	-
Protection class IP	IP20	IP20	IP20
<b>Design, dimensions and weight</b>			
Design	SFP Module	SFP Module	SFP Module
Width	13.7 mm	13.7 mm	13.7 mm
Height	11.9 mm	11.9 mm	11.9 mm
Depth	56.5 mm	56.5 mm	56.5 mm
Net weight	0.01 kg	0.01 kg	0.01 kg
Mounting type Installation in media module slot	-	-	-
Mounting type	Latched	Latched	Latched

## PROFINET/Industrial Ethernet

### Industrial Ethernet Layer 3 Switches / Routers

#### Media modules for modular SCALANCE XR-500 managed

#### Technical specifications (continued)

Article No.	6GK5992-1AL00-8AA0	6GK5992-1AM00-8AA0	6GK5992-1AN00-8AA0
Product-type designation	SFP992-1	SFP992-1LD	SFP992-1LH
<b>Standards, specifications, approvals</b>			
Standard	-	-	-
• for EMC	-	-	-
• for EMC from FM	FM3611: Class 1, Division 2, Group A, B, C, D / T4, Class 1, Zone 2, Group IIC, T4	FM3611: Class 1, Division 2, Group A, B, C, D / T4, Class 1, Zone 2, Group IIC, T4	FM3611: Class 1, Division 2, Group A, B, C, D / T4, Class 1, Zone 2, Group IIC, T4
• for hazardous zone	EN 60079-0: 2006, EN 60079-15: 2005, II 3 G Ex nA II T4, KEMA 07 ATEX 0145 X	EN 60079-0: 2006, EN 60079-15: 2005, II 3 G Ex nA II T4, KEMA 07 ATEX 0145 X	EN 60079-0: 2006, EN 60079-15: 2005, II 3 G Ex nA II T4, KEMA 07 ATEX 0145 X
• for safety of CSA and UL	UL 60950-1, CSA C22.2 No. 60950-1-03	UL 60950-1, CSA C22.2 No. 60950-1-03	UL 60950-1, CSA C22.2 No. 60950-1-03
• for hazardous area of CSA and UL	-	-	-
• for emitted interference	EN 61000-6-4:2007 (Class A)	EN 61000-6-4:2007 (Class A)	EN 61000-6-4:2007 (Class A)
• for interference immunity	EN 61000-6-2:2005	EN 61000-6-2:2005	EN 61000-6-2:2005
Verification of suitability	EN 61000-6-2:2005, EN 61000-6-4:2007	EN 61000-6-2:2005, EN 61000-6-4:2007	EN 61000-6-2:2005, EN 61000-6-4:2007
• CE mark	Yes	Yes	Yes
• C-Tick	Yes	Yes	Yes
• KC approval	No	No	No
• Railway application in accordance with EN 50155	-	-	-
• Railway application in accordance with EN 50124-1	-	-	-
• IEC 61850-3	-	-	-
Marine classification association			
• American Bureau of Shipping Europe Ltd. (ABS)	-	-	-
• Bureau Veritas (BV)	-	-	-
• Det Norske Veritas (DNV)	-	-	-
• Germanische Lloyd (GL)	-	-	-
• Lloyds Register of Shipping (LRS)	-	-	-
• Nippon Kaiji Kyokai (NK)	-	-	-

Article No.	6GK5992-1AP00-8AA0	6GK5992-1AQ00-8AA0
Product-type designation	SFP992-1LH+	SFP992-1ELH
<b>Interfaces</b>		
Number of electrical/optical connections for network components or terminal equipment maximum	1	1
Number of 10/100/1 000 Mbit/s M12 ports	-	-
Number of 10/100/1 000 Mbit/s RJ45 ports	-	-
Number of electrical connections		
• for Power-over-Ethernet for network components or terminal equipment	-	-
• for SFP+/SFP	-	-
Design of electrical connection		
• for network components and terminal equipment	-	-
• for Power-over-Ethernet for network components or terminal equipment	-	-

**Technical specifications** (continued)

Article No.	6GK5992-1AP00-8AA0	6GK5992-1AQ00-8AA0
Product-type designation	SFP992-1LH+	SFP992-1ELH
Number of 100 Mbit/s ST(BFOC) ports	-	-
Number of 100 Mbit/s SC ports	-	-
Number of 100 Mbit/s LC ports	-	-
Number of 1 000 Mbit/s LC ports (LX)	1	1
Number of 1 000 Mbit/s LC ports (SX)	-	-
Number of 1 000 Mbit/s SC ports (LX)	-	-
Number of 1 000 Mbit/s SC ports (SX)	-	-
Number of 10 Gbit/s LC ports (LX)	-	-
Number of 10 Gbit/s LC ports (SX)	-	-
Design of optical connections for network components or terminal devices	LC	LC
Connectable optical power relative to 1 mW		
• of the transmitter output	0 ... 5 dB	0 ... 5 dB
• of the receiver input maximum	-3 dB	-8 dB
Optical sensitivity relative to 1 mW of the receiver input minimum	-23 dB	-32 dB
Attenuation of fiber-optic cable transmission link minimum necessary	8 dB	8 dB
Range at the optical interface depending on the optical fiber used	30 ... 70 km	37 ... 120 km
<b>Permitted ambient conditions</b>		
Ambient temperature		
• during operating	-40 ... +85 °C	-40 ... +85 °C
• during storage	-40 ... +85 °C	-40 ... +85 °C
• during transport	-40 ... +85 °C	-40 ... +85 °C
Relative humidity at 25 °C without condensation during operating maximum	95 %	95 %
Ambient condition for (standard) operation mode	-	-
Protection class IP	IP20	IP20
<b>Design, dimensions and weight</b>		
Design	SFP Module	SFP Module
Width	13.7 mm	13.7 mm
Height	11.9 mm	11.9 mm
Depth	56.5 mm	56.5 mm
Net weight	0.01 kg	0.01 kg
Mounting type Installation in media module slot	-	-
Mounting type	Latched	Latched

## PROFINET/Industrial Ethernet

### Industrial Ethernet Layer 3 Switches / Routers

#### Media modules for modular SCALANCE XR-500 managed

#### Technical specifications (continued)

Article No.	6GK5992-1AP00-8AA0	6GK5992-1AQ00-8AA0
Product-type designation	SFP992-1LH+	SFP992-1ELH
<b>Standards, specifications, approvals</b>		
Standard		
• for EMC	-	-
• for EMC from FM	FM3611: Class 1, Division 2, Group A, B, C, D / T4, Class 1, Zone 2, Group IIC, T4	FM3611: Class 1, Division 2, Group A, B, C, D / T4, Class 1, Zone 2, Group IIC, T4
• for hazardous zone	EN 60079-0: 2006, EN 60079-15: 2005, II 3 G Ex nA II T4, KEMA 07 ATEX 0145 X	EN 60079-0: 2006, EN 60079-15: 2005, II 3 G Ex nA II T4, KEMA 07 ATEX 0145 X
• for safety of CSA and UL	UL 60950-1, CSA C22.2 No. 60950-1-03	UL 60950-1, CSA C22.2 No. 60950-1-03
• for hazardous area of CSA and UL	-	-
• for emitted interference	EN 61000-6-4:2007 (Class A)	EN 61000-6-4:2007 (Class A)
• for interference immunity	EN 61000-6-2:2005	EN 61000-6-2:2005
Verification of suitability	EN 61000-6-2:2005, EN 61000-6-4:2007	EN 61000-6-2:2005, EN 61000-6-4:2007
• CE mark	Yes	Yes
• C-Tick	Yes	Yes
• KC approval	No	No
• Railway application in accordance with EN 50155	-	-
• Railway application in accordance with EN 50124-1	-	-
• IEC 61850-3	-	-
Marine classification association		
• American Bureau of Shipping Europe Ltd. (ABS)	-	-
• Bureau Veritas (BV)	-	-
• Det Norske Veritas (DNV)	-	-
• Germanische Lloyd (GL)	-	-
• Lloyds Register of Shipping (LRS)	-	-
• Nippon Kaiji Kyokai (NK)	-	-

Article No.	6GK5993-1AV00-8AA0	6GK5993-1AU00-8AA0	6GK5993-1AT00-8AA0
Product-type designation	SFP993-1LH	SFP993-1LD	SFP993-1
<b>Interfaces</b>			
Number of electrical/optical connections for network components or terminal equipment maximum	1	1	1
Number of 10/100/1 000 Mbit/s M12 ports	-	-	-
Number of 10/100/1 000 Mbit/s RJ45 ports	-	-	-
Number of electrical connections			
• for Power-over-Ethernet for network components or terminal equipment	-	-	-
• for SFP+/SFP	-	-	-
Design of electrical connection			
• for network components and terminal equipment	-	-	-
• for Power-over-Ethernet for network components or terminal equipment	-	-	-
Number of 100 Mbit/s ST(BFOC) ports	-	-	-
Number of 100 Mbit/s SC ports	-	-	-
Number of 100 Mbit/s LC ports	-	-	-
Number of 1 000 Mbit/s LC ports (LX)	-	-	-
Number of 1 000 Mbit/s LC ports (SX)	-	-	-
Number of 1 000 Mbit/s SC ports (LX)	-	-	-
Number of 1 000 Mbit/s SC ports (SX)	-	-	-
Number of 10 Gbit/s LC ports (LX)	1	1	-
Number of 10 Gbit/s LC ports (SX)	-	-	1



## PROFINET/Industrial Ethernet

### Industrial Ethernet Layer 3 Switches / Routers

#### Media modules for modular SCALANCE XR-500 managed

#### Technical specifications (continued)

Article No.	6GK5993-1AV00-8AA0	6GK5993-1AU00-8AA0	6GK5993-1AT00-8AA0
Product-type designation	SFP993-1LH	SFP993-1LD	SFP993-1
Design of optical connections for network components or terminal devices	LC	LC	LC
Connectable optical power relative to 1 mW			
• of the transmitter output	0 ... 5 dB	-8.2 ... +0.5 dB	-5 ... -1 dB
• of the receiver input maximum	0.5 dB	0.5 dB	-1 dB
Optical sensitivity relative to 1 mW of the receiver input minimum	-15 dB	-12.6 dB	-11.1 dB
Attenuation of fiber-optic cable transmission link minimum necessary	4.5 dB	0 dB	0 dB
Range at the optical interface depending on the optical fiber used	0 ... 40 km	0 ... 10 km	0 ... 0.3 km
<b>Permitted ambient conditions</b>			
Ambient temperature			
• during operating	0 ... 60 °C	0 ... 60 °C	0 ... 60 °C
• during storage	-40 ... +70 °C	-40 ... +70 °C	-40 ... +70 °C
• during transport	-40 ... +70 °C	-40 ... +70 °C	-40 ... +70 °C
Relative humidity at 25 °C without condensation during operating maximum	95 %	95 %	95 %
Ambient condition for (standard) operation mode	-	-	-
Protection class IP	IP20	IP20	IP20
<b>Design, dimensions and weight</b>			
Design	SFP Module	SFP Module	SFP Module
Width	13.7 mm	13.7 mm	13.7 mm
Height	11.9 mm	11.9 mm	11.9 mm
Depth	56.5 mm	56.5 mm	56.5 mm
Net weight	0.01 kg	0.01 kg	0.01 kg
Mounting type Installation in media module slot	-	-	-
Mounting type	Latched	Latched	Latched
<b>Standards, specifications, approvals</b>			
Standard			
• for EMC	-	-	-
• for EMC from FM	-	-	-
• for hazardous zone	-	-	-
• for safety of CSA and UL	UL 60950-1, CSA C22.2 No. 60950-10	UL 60950-1, CSA C22.2 No. 60950-9	UL 60950-1, CSA C22.2 No. 60950-8
• for hazardous area of CSA and UL	-	-	-
• for emitted interference	EN 61000-6-4 (Class A)	EN 61000-6-4 (Class A)	EN 61000-6-4 (Class A)
• for interference immunity	EN 61000-6-2	EN 61000-6-2	EN 61000-6-2
Verification of suitability	EN 61000-6-2, EN 61000-6-13	EN 61000-6-2, EN 61000-6-12	EN 61000-6-2, EN 61000-6-11
• CE mark	Yes	Yes	Yes
• C-Tick	Yes	Yes	Yes
• KC approval	No	No	No
• Railway application in accordance with EN 50155	-	-	-
• Railway application in accordance with EN 50124-1	-	-	-
• IEC 61850-3	-	-	-
Marine classification association			
• American Bureau of Shipping Europe Ltd. (ABS)	-	-	-
• Bureau Veritas (BV)	-	-	-
• Det Norske Veritas (DNV)	-	-	-
• Germanische Lloyd (GL)	-	-	-
• Lloyds Register of Shipping (LRS)	-	-	-
• Nippon Kaiji Kyokai (NK)	-	-	-

# PROFINET/Industrial Ethernet

## Industrial Ethernet Layer 3 Switches / Routers

### Media modules for modular SCALANCE XR-500 managed

Ordering data	Article No.	Article No.
<i>Electrical media modules</i>		<i>Accessories</i>
<b>with 4 x 10/100/1 000 Mbit/s RJ45 ports, electrical</b> <ul style="list-style-type: none"> <li>MM992-4CuC</li> <li>MM992-4CU</li> </ul> with power over Ethernet <ul style="list-style-type: none"> <li>MM992-4PoEC</li> <li>MM992-4PoE</li> </ul>	<b>6GK5992-4GA00-8AA0</b> <b>6GK5992-4SA00-8AA0</b>  <b>6GK5992-4RA00-8AA0</b> <b>6GK5992-4QA00-8AA0</b>	<b>IE FC RJ45 Modular Outlet</b>  FastConnect RJ45 Outlet for Industrial Ethernet with interface for replaceable insert <ul style="list-style-type: none"> <li>with 2FE insert; replaceable insert for 2 x 100 Mbit/s interfaces</li> <li>with 1GE insert; replaceable insert for 1 x 1 000 Mbit/s interfaces</li> </ul>
<b>with 4 x 100 Mbit/s BFOC ports, optical</b> <ul style="list-style-type: none"> <li>MM991-4 multi-mode, glass, up to 5 km</li> <li>MM991-4LD single-mode, glass, up to max. 26 km</li> </ul> <b>with 4 x 1 000 Mbit/s SC ports, optical</b> <ul style="list-style-type: none"> <li>MM992-4 multi-mode, glass, up to max. 750 m</li> <li>MM992-4LD single-mode, glass, up to max. 10 km</li> </ul> <b>with 4 x 100/1 000 Mbit/s for SFP pluggable transceiver, optical</b> <ul style="list-style-type: none"> <li>MM992-4SFP for SFP plug-in transceivers with 1 x 100 or 1 x 1 000 Mbit/s multi-mode or single-mode, glass</li> </ul>	<b>6GK5991-4AB00-8AA0</b> <b>6GK5991-4AC00-8AA0</b>  <b>6GK5992-4AL00-8AA0</b> <b>6GK5992-4AM00-8AA0</b>  <b>6GK5992-4AS00-8AA0</b>	<b>6GK1901-1BE00-0AA1</b>  <b>6GK1901-1BE00-0AA2</b>  <b>6XV1840-2AH10</b>  <b>6XV1870-2E</b>
<i>SFP pluggable transceiver, optical</i>  <b>with 1 x 100 Mbit/s LC port, optical</b> <ul style="list-style-type: none"> <li>SFP991-1 multi-mode, glass, up to max. 5 km</li> <li>SFP991-1LD single-mode, glass, up to max. 26 km</li> <li>SFP991-1LH+ single-mode, glass, up to max. 70 km</li> <li>SFP991-1ELH200 single-mode, glass, up to max. 200 km</li> </ul> <b>with 1 x 1 000 Mbit/s LC port, optical</b> <ul style="list-style-type: none"> <li>SFP992-1 multi-mode, glass, up to max. 750 m</li> <li>SFP992-1LD single-mode, glass, up to max. 10 km</li> <li>SFP992-1LH single-mode, glass, up to max. 40 km</li> <li>SFP992-1LH+ single-mode, glass, up to max. 70 km</li> <li>SFP992-1ELH single-mode, glass, up to max. 120 km</li> </ul> <b>with 1 x 10 Gbit/s LC port, optical</b> <ul style="list-style-type: none"> <li>SFP993-1 multi-mode, glass, up to max. 300 m</li> <li>SFP993-1LD single-mode, glass, up to max. 10 km</li> <li>SFP993-1LH single-mode, glass, up to max. 40 km</li> </ul>	<b>6GK5991-1AD00-8AA0</b> <b>6GK5991-1AF00-8AA0</b>  <b>6GK5991-1AE00-8AA0</b>  <b>6GK5991-1AE30-8AA0</b>  <b>6GK5992-1AL00-8AA0</b> <b>6GK5992-1AM00-8AA0</b>  <b>6GK5992-1AN00-8AA0</b>  <b>6GK5992-1AP00-8AA0</b>  <b>6GK5992-1AQ00-8AA0</b>  <b>6GK5993-1AT00-8AA0</b> <b>6GK5993-1AU00-8AA0</b>  <b>6GK5993-1AV00-8AA0</b>	<b>6XV1870-3QE50</b> <b>6XV1870-3QH10</b> <b>6XV1870-3QH20</b> <b>6XV1870-3QH60</b> <b>6XV1870-3QN10</b>  <b>IE FC RJ45 plug 180</b>  RJ45 plug connector for Industrial Ethernet with a rugged metal enclosure and integrated insulation/displacement contacts for connecting Industrial Ethernet FC installation cables; with 180° cable outlet; for network components and CPs/CPU's with Industrial Ethernet interface <ul style="list-style-type: none"> <li>1 pack = 1 unit</li> <li>1 pack = 10 units</li> <li>1 pack = 50 units</li> </ul>
<b>IE connecting cable SFP+/SFP+, electrical, 10 Gbit/s</b>  Twinax copper cables, length <ul style="list-style-type: none"> <li>1 m</li> <li>2 m</li> <li>7 m</li> </ul>	<b>6GK5980-3CB00-0AA1</b> <b>6GK5980-3CB00-0AA2</b> <b>6GK5980-3CB00-0AA7</b>	<b>IE FC RJ45 Plug 4 x 2</b>  RJ45 plug connector for Industrial Ethernet (10/100/1 000 Mbit/s) with a rugged metal enclosure and integrated insulation displacement contacts for connecting Industrial Ethernet FC installation cables; 180° cable outlet; for network components and CPs/CPU's with Industrial Ethernet interface <ul style="list-style-type: none"> <li>1 pack = 1 unit</li> <li>1 pack = 10 units</li> <li>1 pack = 50 units</li> </ul>

**More information****Selection tool:**

To assist in selecting the right Industrial Ethernet switches as well as configuration of modular variants, the SIMATIC NET Selection Tool and the TIA Selection Tool are available at:

SIMATIC NET Selection Tool:

- Online version:  
<http://www.siemens.com/snst>
- Offline version:  
<http://www.siemens.com/snst-download>

TIA Selection Tool:

<http://www.siemens.com/tia-selection-tool>

## PROFINET/Industrial Ethernet

### Industrial Ethernet Layer 3 Switches / Routers

#### Power supplies for SCALANCE X-500

##### Overview

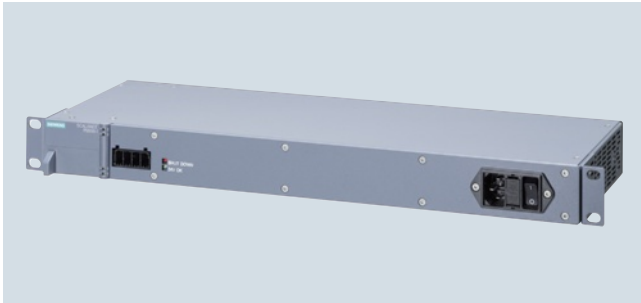

- The 24 V PS598 power supply is designed for installation in 19" control cabinets or for direct mounting on SCALANCE XR-500 Industrial Ethernet switches; it has degree of protection IP20.
- 300 W output power at an input voltage range of 85 V to 264 V AC and an operating temperature of 0 °C to +60 °C

##### Product versions

###### PS598-1 24 V power supply

- 300 W output power
- Input voltage range from 85 V to 264 V AC
- Output voltage 24 V DC
- Operating temperature from 0 °C to +60 °C
- Degree of protection IP20

##### Benefits



- Global use thanks to wide-range input (85 to 264 V AC)
- High reliability since it is short-circuit proof, secure against no-load operation, and able to bridge short breaks in the mains power

##### Design

- Non-heating apparatus socket for connecting to the AC network of 85 to 264 V AC (non-heating apparatus cable not included in the scope of delivery; can be ordered optionally on country-specific basis)
- Terminal block for universal supply of products with 24 V DC input
- Plug-in contact for direct connection on the rear of the SCALANCE XR-500 Industrial Ethernet switches (mounting kit included in scope of delivery of SCALANCE XR-500)
- Operating temperatures from 0°C to +60°C
- IP20 degree of protection
- Optimized for installation in 19" control cabinet or for direct mounting on SCALANCE XR-500 (SCALANCE XR-500 and power supply unit are mounted in the 19" control cabinet as a single unit)
- LEDs for indicating the status information (power, operating state)

##### Integration

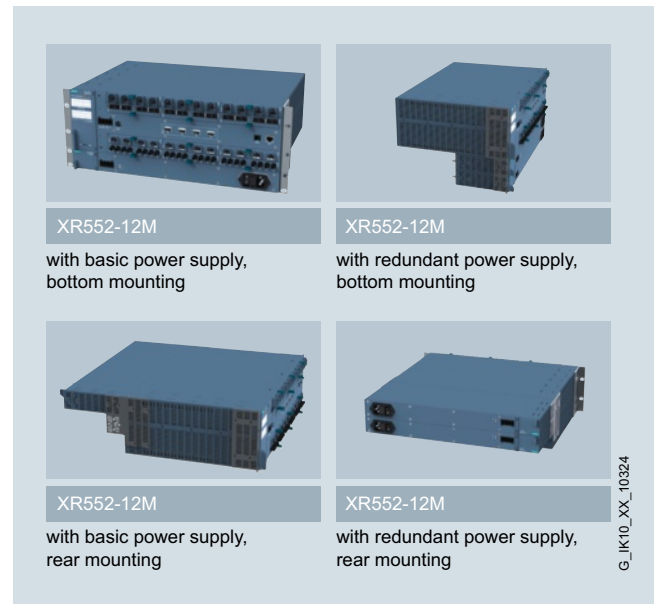

Options for mounting a single/redundant power supply unit to SCALANCE XR552-12M

**Technical specifications**

Article No.	6GK5598-1AA00-3AA0	Article No.	6GK5598-1AA00-3AA0
Product-type designation	POWER SUPPLY PS598-1	Product-type designation	POWER SUPPLY PS598-1
Type of current supply	300 W, input: 85 - 264 V, output: DC 24 V		
<b>Electrical data</b>			
<u>Electrical data</u>		<u>Electrical data</u>	
<u>Input</u>		<u>Closed-loop control</u>	
Form of voltage at the input	1-phase AC	Relative regulation accuracy of the output voltage	
Supply voltage		• with rapid fluctuation of the input voltage by +/- 15% typical	0.8 %
• for AC	85 ... 264 V	• load step of ohmic load 50/100/50 % typical	3.25 %
• 1 at AC nominal value	230 V	Setting time	
Type of input wide range input	Yes	• load step 50 to 100% typical	2 ms
Oversvoltage class	Category II (20 A rated branch circuit)	• load step 100 to 50% typical	2 ms
Stored energy time on nominal level of the output current: at mains power cut minimum	16 ms	<u>Electrical data</u>	
Line frequency		<u>Protection and monitoring</u>	
• 1 nominal value	50 Hz	Design of oversvoltage protection at output	< 37 V
• 2 nominal value	60 Hz	Pick-up level current limitation typical	1.15 A
• initial value	47 Hz	Characteristic feature of the output short-circuit protected	Yes
• ultimate value	63 Hz	Design of the short-circuit protection	Electronic shutdown, automatic restart
Input current at nominal level of the input voltage 230 V nominal value	1.8 A	Enduring short circuit current Effective level maximum	-
Current limiting of input current at 25 °C maximum	40 A	<u>Electrical data</u>	
Type of protection at input	replaceable	<u>Safety</u>	
<u>Electrical data</u>		Galvanic isolation between entrance and outlet	Yes
<u>Output</u>		Potential separation	Safety extra-low output voltage $U_{out}$ acc. to EN 60950-1 and EN 50178
Form of voltage secondary side	Controlled, isolated DC voltage	Operating resource protection class	Class I
Output voltage for DC nominal value	24 V	stray current	
Relative overall tolerance of the voltage	2 %	• maximum	3 mA
Relative regulation accuracy of the output voltage		• typical	0.858 mA
• On slow fluctuation of the input voltage	0.2 %	<b>Mechanical data</b>	
• on slow fluctuation of the ohm loading	0.4 %	Design of the electrical connection	
Residual ripple maximum	0.36 V	• at the input	IEC plug
Voltage peak maximum	240 V	• secondary side	for plugging into basic device or screw terminal in accordance with specification
Type of display for normal operation	Green LED for 24 V OK and fault LED	Width	446 mm
Behaviour of the output voltage on switching on	Overshoot of $U_a < 5 %$	Height	44 mm
Startup delay time maximum	1.5 s	Depth	140 mm
Voltage increase time of the output voltage maximum	15 ms	Net weight	1.7 kg
Output current		Product feature of the housing housing for side-by-side mounting	No
• nominal value	12.5 A	Type of mounting	
• nominal range	0 ... 12.5 A	• 19-inch installation	Yes
delivered active power typ.	300 W	• wall mounting	No
Product feature Bridging of channels	Yes	• standard rail mounting	No
Number of parallel-switched pieces of equipment for increasing the power	2	• S7-300 rail mounting	No
Efficiency in percentage	87 %	Mounting type	Plugged into the basic unit or rack mounted
Resistive loss	39 W		

## PROFINET/Industrial Ethernet

### Industrial Ethernet Layer 3 Switches / Routers

#### Power supplies for SCALANCE X-500

##### Technical specifications (continued)

<b>Article No.</b>	<b>6GK5598-1AA00-3AA0</b>
<b>Product-type designation</b>	<b>POWER SUPPLY PS598-1</b>
<b>Permitted ambient conditions</b>	
Ambient temperature	
• during operating	0 ... 60 °C
• during storage	-25 ... +70 °C
• during transport	-25 ... +70 °C
• Comment	Operation with integral fan, non-replaceable
Climatic class according to EN 60721	Climate class 3K3, without condensation
Protection class IP	IP20
<b>Standards, specifications, approvals</b>	
Standard	
• for EMC	-
• for EMC from FM	-
• for hazardous zone	-
• for safety of CSA and UL	UL 60950-1, CSA C22.2 Nr. 60950-1
• for hazardous area of CSA and UL	-
• for emitted interference	EN 55022 (Class B)
• for interference immunity	EN 61000-6-2
Verification of suitability	EN 55022, EN 61000-6-4
• CE mark	Yes
• C-Tick	Yes

##### Ordering data

##### Article No.

##### *Power supplies for SCALANCE X-500*

24 V power supplies are designed for installation in 19" control cabinets or for direct mounting on SCALANCE X-500 Industrial Ethernet switches; degree of protection IP20

##### **PS598-1**

300 W output power, input voltage range of 85 V to 264 V AC, operating temperature of 0 °C to +60 °C

**6GK5598-1AA00-3AA0**

##### *Accessories*

##### **Appliance cable**

- Grounded Continental European plug, region: D/F/NL/ESP/B/A/S/FIN
- Grounded British plug; region: UK
- Grounded Swiss plug; region: CH
- Grounded North American and Japanese plug; region: USA
- Grounded Italian plug; region: Italy
- Grounded Chinese plug; region: China

**6ES7900-0AA00-0XA0**

**6ES7900-0BA00-0XA0**

**6ES7900-0CA00-0XA0**

**6ES7900-0DA00-0XA0**

**6ES7900-0EA00-0XA0**

**6ES7900-0FA00-0XA0**

### Overview



- Swap medium with which Layer 3 Routing functions can be enabled
- For the automatic backup of configuration data. If a fault occurs, it allows fast and simple device replacement without a Field PG (contains the function of the C-PLUG)
- Can be used in all Layer 2 variants of the SCALANCE XR500 and in all variants of the SCALANCE XM-400 basic devices

### Benefits

- Fast and simple replacement of SCALANCE X-500 or SCALANCE XM-400 components without reconfiguration of the spare part
- The device can be replaced without the need for specially trained personnel or a programming device or PC
- The downtimes of network segments and connected Industrial Ethernet nodes can therefore be minimized if a fault occurs

### Application

The KEY-PLUG stores the configuration data of a SCALANCE X-500 or SCALANCE XM-400 component. Additional Layer 3 Routing functions can be enabled by inserting a KEY-PLUG.

In addition to this, if there is a fault on a module, the module can be replaced simply and quickly without needing to reconfigure the replacement device and without specially trained personnel. If a device needs to be replaced, the KEY-PLUG is simply removed from the failed component and plugged into the replacement device. The replacement device now starts up automatically with the device configuration of the failed device.

### Design

The KEY-PLUG has degree of protection IP20. Power is supplied by the terminal device.

The KEY-PLUG is plugged into the slot of the SCALANCE X-500 or SCALANCE XM-400 basic device provided for this purpose.

### Mode of operation

The device automatically backs up the configuration data on a KEY-PLUG (as delivered) upon start-up. Changes to the configuration during operation are also saved on the KEY-PLUG without any additional operator intervention being necessary.

During start-up, an unconfigured device automatically loads the configuration data from an inserted KEY-PLUG that has been written to provided the data was written by a compatible device type.

### Diagnostics

Incorrect use of the KEY-PLUG such as inserting a KEY-PLUG containing the configuration of a non-compatible device or general malfunctions of the KEY-PLUG are indicated by diagnostics mechanisms of the terminal device (LEDs, SNMP, Web based Management, etc.).

### Integration

#### Supported products

**SCALANCE X-500**

**SCALANCE XM-400**

### Technical specifications

#### KEY-PLUG

Supply voltage	via terminal device
Power loss	0.015 mW
Installation	Can be plugged into C-PLUG compartment
Construction	
• Dimensions (W x H x D) in mm	24.3 x 17 x 8.1
• Approx. weight	5 g
Memory capacity	256 MB
Degree of protection	IP20

### Ordering data

#### Article No.

#### KEY-PLUG X-500 Layer 3 Routing

KEY-PLUG XR-500, swap medium for enabling Layer 3 Routing Features for SCALANCE XR-500 and for easily replacing a device in the event of a failure as well as for recording configuration data.

- For SCALANCE XR552, SCALANCE XR528 and XR524

**6GK5905-0PA00**

#### KEY-PLUG XM-400 Layer 3 Routing

KEY-PLUG XM-400, swap medium for enabling Layer 3 Routing Features for SCALANCE XM-400 and for easily replacing a device in the event of a failure as well as for recording configuration data.

**6GK5904-0PA00**

## PROFINET/Industrial Ethernet SINAMICS drive system

### Overview

#### Overview

##### The SINAMICS range



- Totally integrated range of drives for any application and every industry
- Wide range of power ratings from 0.12 kW to 120 MW
- Broad functional scope from simple U/f control through to highly dynamic servo control
- Designed for problem-free interaction with other Siemens automation components
- Shared platform concept with uniform functionality, engineering, commissioning, operation as well as a uniform diagnostics concept and communication mechanisms

SINAMICS G						SINAMICS S			
G120C	G120P/ G120	G120		G110M	G120D		S110	S120	
Compact inverters	CU230P-2 Control Unit	CU240E-2 Control Unit	CU250S-2 Control Unit	CU240M Control Unit	CU240D-2 Control Unit	CU250D-2 Control Unit	CU305 Control Unit	CU310-2 Control Unit	CU320-2 Control Unit

#### Protocol

##### PROFINET

- PROFINET RT	✓	✓	✓	✓	✓	✓	✓	✓	✓
- PROFINET IRT (not isochronous)	✓	✓	✓	✓	✓	✓	✓	✓	✓
- PROFINET IRT isochronous	-	-	-	-	-	-	✓	✓	✓
- PROFINET Shared Device	✓	✓	✓	✓	✓	✓	✓	✓	✓
- PROFINET media redundancy MRP (surge prone)	✓	✓	✓	✓	✓	✓	✓	✓	✓
- PROFINET media redundancy MRPD (surge free)	✓	✓	✓	✓	✓	✓	✓	✓	✓
• Profile									
- PROFIsafe	✓	-	✓	✓	✓	✓	✓	✓	✓
- PROFInergy	✓	✓	✓	✓	✓	✓	-	✓	✓
- PROFIdrive	✓	✓	✓	✓	✓	✓	✓	✓	✓

##### SINAMICS G120P – the specialist for pumps, fans, and compressors



- Automatic switchover to mains-fed operation at rated speed
- Numerous functions for pumps, fans and compressors, e. g. energy-saving mode, auto ramping, Pt1000/LG-Ni1000 temperature sensor interface, cascade connection, real time clock, bypass, multi-zone control
- Communication: RS485, USS, Modbus RTU, BACnet MS/TP, PROFINET, EtherNet/IP, PROFIBUS DP, CANopen
- Integrated in the TIA Portal with SINAMICS Startdrive
- Energy efficient through minimal apparent power losses, automatic adaptation of the motor current to the actual load conditions with ECO mode

#### More information

- Catalog D 35
- Interactive Catalog CA 01
- Internet:  
[www.siemens.com/sinamics-g120p](http://www.siemens.com/sinamics-g120p)  
[www.siemens.com/industrymall](http://www.siemens.com/industrymall)



**Overview (continued)**
**SINAMICS G120D – the distributed single-motor drive for high-performance solutions**

- Positioning capability
- Power range from 0.75 kW to 7.5 kW
- Energy efficient thanks to regenerative feedback and low line harmonic distortion
- Safety Integrated: STO, SS1, SDI, SSM and SLS encoderless
- Thanks to the modular design, electronics stocks are minimal
- Interchangeable memory card
- Communication via PROFIBUS DP, PROFINET, EtherNet/IP
- Integrated in the TIA Portal with SINAMICS Startdrive

More information

- Catalog D 31
- Interactive Catalog CA 01
- Internet:  
[www.siemens.com/sinamics-g120d](http://www.siemens.com/sinamics-g120d)  
[www.siemens.com/industrymall](http://www.siemens.com/industrymall)

**SINAMICS G120C – the compact and versatile inverter with optimum functionality**

- Compact unit
- Highest power density in its class
- Power range from 0.55 kW to 18.5 kW
- Easy commissioning and maintenance
- With BOP-2 or IOP operator panel
- Safety Integrated: STO
- Available communication: PROFIBUS DP, CANopen, USS, Modbus RTU, PROFINET, EtherNet/IP
- Integrated in the TIA Portal with SINAMICS Startdrive

More information

- Catalog D 31
- Interactive Catalog CA 01
- Internet:  
[www.siemens.com/sinamics-g120c](http://www.siemens.com/sinamics-g120c)  
[www.siemens.com/industrymall](http://www.siemens.com/industrymall)

**SINAMICS G120 – the modular single-motor drive for low to medium power ratings**

- Power range from 0.37 kW to 250 kW
- Safety Integrated: STO, SS1, SBC, SLS, SDI and SSM encoderless
- Communication via PROFIBUS, PROFINET, EtherNet/IP, RS485, USS, Modbus RTU, CANopen, BACnet MS/TP
- Energy efficient thanks to regenerative feedback and low line harmonic distortion
- Parameter copy function for standard commissioning
- Integrated in the TIA Portal with SINAMICS Startdrive

More information

- Catalog D 31
- Interactive Catalog CA 01
- Internet:  
[www.siemens.com/sinamics-g120](http://www.siemens.com/sinamics-g120)  
[www.siemens.com/industrymall](http://www.siemens.com/industrymall)

## PROFINET/Industrial Ethernet SINAMICS drive system

### Overview

#### Overview (continued)

##### **SINAMICS G110M – the distributed inverter integrated in the motor**



- Power range from 0.37 kW to 4 kW
- Integrated safety functions (STO locally via F-DI or via PROFIsafe)
- Integrated communication: USS, Modbus RTU, PROFIBUS, PROFINET, EtherNet/IP
- Basic PLC functions and additional conveyor technology functions
- Local commissioning via DIP switch and potentiometer, memory card, USB interface or Intelligent Operator Panel (IOP)
- Integrated in the TIA Portal with SINAMICS Startdrive

#### More information

- Catalog D 31
- Interactive Catalog CA 01
- Internet:  
[www.siemens.com/sinamics-g110m](http://www.siemens.com/sinamics-g110m)  
[www.siemens.com/industrymall](http://www.siemens.com/industrymall)

##### **SINAMICS S110 – the specialist for simple positioning tasks**



- Servo control
- Power range from 0.12 kW to 90 kW
- Safety Integrated
- Integrated positioning functions
- Straightforward system interface with higher-level controllers (e.g. PLC) with PROFIBUS DP, PROFINET, CANopen

#### More information

- Catalog D 31
- Interactive Catalog CA 01
- Internet:  
[www.siemens.com/sinamics-s110](http://www.siemens.com/sinamics-s110)  
[www.siemens.com/industrymall](http://www.siemens.com/industrymall)

##### **SINAMICS S120 – the flexible, modular drive system for demanding single-axis and multi-axis applications from the low-end to the high-end performance range**



- Specially for motion control and vector control in single-axis and multi-axis applications in all areas of machine and plant manufacturing
- Servo/vector control, U/f control
- Power range from 0.12 kW to 1 200 kW, as Cabinet Modules up to 4 500 kW
- Various types of construction for different application areas
- Highly flexible due to, for example, modular system architecture, different cooling methods, support for a wide range of motors/encoders, easy expansion
- High degree of scalability with regard to performance, number of axes, functionality
- Integrated safety functions
- Comprehensive motion control functionality
- High availability and efficiency, even in unstable networks
- Automatic parameterization and easy drive commissioning/optimization.

#### More information

- Catalog PM 21, NC 61, NC 62, D 21.3
- Interactive Catalog CA 01
- Internet:  
[www.siemens.com/sinamics-s120](http://www.siemens.com/sinamics-s120)  
[www.siemens.com/industrymall](http://www.siemens.com/industrymall)

**Overview**

- Measuring systems are encoders for recording distances, angles of rotation, and velocities.
- Can be used on machines in various sectors, e.g. production machines, manipulators, machine tools, and special machines.
- Can be connected to SIMATIC, SINAMICS, SINUMERIK and SIMOTION.
- Accessories available for measuring systems: couplings, mounting material, connectors, and completely pre-assembled signal cables.
- External encoders are available as incremental or absolute-value encoders.
- Incremental encoders:
  - Interfaces RS422 (TTL), 1 V<sub>pp</sub> and HTL.
  - Operating voltage 5 V DC or 10 V to 30 V DC.
- Absolute-value encoders:
  - All absolute-value encoders are available in singleturn and multiturn versions.
  - Interface SSI (synchronous serial interface) or connection for EnDat, PROFIBUS DP, PROFINET IO with RT/IRT and DRIVE-CLiQ.
  - Encoders with PROFIBUS DP support Class 1 ... 3 profiles as well as isochronous mode, internode communication, and application-specific supplementary functions. They are parameterizable.
  - Encoders with PROFINET IO support Class 1 ... 4 profiles.
- All measuring systems are available in synchro flange and supported flange joint versions. The absolute encoders are available in a hollow shaft version.

**More information**

- Catalogs NC 62, NC 82, PM 21, D 31
- Interactive Catalog CA 01
- Internet:
  - [www.siemens.com/sensor-systems](http://www.siemens.com/sensor-systems)
  - [www.siemens.com/industryall](http://www.siemens.com/industryall)

## PROFINET/Industrial Ethernet

### Controllers / Modular controllers / SIMATIC S7-1200

#### CPU 1211C

#### Overview



- The clever compact solution
- With 10 integral input/outputs
- Expandable by:
  - 1 signal board (SB) or communication board (CB)
  - Max. 3 communication modules (CM)

#### Technical specifications

	6ES7211-1BE40-0XB0 CPU 1211C AC/DC/Relay	6ES7211-1AE40-0XB0 CPU 1211C DC/DC/DC	6ES7211-1HE40-0XB0 CPU 1211C DC/DC/Relay
<b>General information</b>			
Engineering with • Programming package	STEP 7 V13 or higher	STEP 7 V13 or higher	STEP 7 V13 or higher
<b>Supply voltage</b>			
24 V DC		Yes	Yes
120 V AC	Yes		
230 V AC	Yes		
<b>Power losses</b>			
Power loss, typ.	10 W	8 W	8 W
<b>Memory</b>			
Work memory • integrated	30 kbyte	30 kbyte	30 kbyte
Load memory • integrated • plug-in (SIMATIC Memory Card), max.	1 Mbyte 2 Gbyte; with SIMATIC Memory Card	1 Mbyte 2 Gbyte; with SIMATIC Memory Card	1 Mbyte 2 Gbyte; with SIMATIC Memory Card
Backup • without battery	Yes	Yes	Yes
<b>CPU processing times</b>			
for bit operations, typ.	0.085 µs; / Operation	0.085 µs; / Operation	0.085 µs; / Operation
for word operations, typ.	1.7 µs; / Operation	1.7 µs; / Operation	1.7 µs; / Operation
for floating point arithmetic, typ.	2.3 µs; / Operation	2.3 µs; / Operation	2.3 µs; / Operation
<b>Data areas and their retentivity</b>			
Flag • Number, max.	4 kbyte; Size of bit memory address area	4 kbyte; Size of bit memory address area	4 kbyte; Size of bit memory address area
<b>Address area</b>			
Process image • Inputs, adjustable • Outputs, adjustable	1 kbyte 1 kbyte	1 kbyte 1 kbyte	1 kbyte 1 kbyte
<b>Time of day</b>			
Clock • Hardware clock (real-time clock)	Yes	Yes	Yes

**Technical specifications** (continued)

	<b>6ES7211-1BE40-0XB0</b> <b>CPU 1211C AC/DC/Relay</b>	<b>6ES7211-1AE40-0XB0</b> <b>CPU 1211C DC/DC/DC</b>	<b>6ES7211-1HE40-0XB0</b> <b>CPU 1211C DC/DC/Relay</b>
<b>Digital inputs</b>			
Number of digital inputs • of which, inputs usable for technological functions	6; integrated 6; HSC (High Speed Counting)	6; integrated 6; HSC (High Speed Counting)	6; integrated 6; HSC (High Speed Counting)
<b>Digital outputs</b>			
Number of digital outputs • of which high-speed outputs	4; Relays	4 4; 100 kHz Pulse Train Output	4; Relays
<b>Analog inputs</b>			
Integrated channels (AI)	2; 0 to 10 V	2; 0 to 10 V	2; 0 to 10 V
Input ranges • Voltage	Yes	Yes	Yes
<b>1st interface</b>			
Interface type	PROFINET	PROFINET	PROFINET
Physics	Ethernet	Ethernet	Ethernet
Functionality • PROFINET IO Device • PROFINET IO Controller	Yes Yes	Yes Yes	Yes Yes
<b>Communication functions</b>			
S7 communication • supported	Yes	Yes	Yes
Open IE communication • TCP/IP • ISO-on-TCP (RFC1006) • UDP	Yes Yes Yes	Yes Yes Yes	Yes Yes Yes
Web server • supported	Yes	Yes	Yes
<b>Integrated Functions</b>			
Number of counters	6	6	6
Counter frequency (counter) max.	100 kHz	100 kHz	100 kHz
Frequency meter	Yes	Yes	Yes
Controlled positioning	Yes	Yes	Yes
PID controller	Yes	Yes	Yes
Number of alarm inputs	4	4	4
Number of pulse outputs		4	
Limit frequency (pulse)		100 kHz	
<b>Ambient conditions</b>			
Operating temperature • min. • max.	-20 °C 60 °C	-20 °C 60 °C	-20 °C 60 °C
<b>Configuration</b>			
programming • Programming language - LAD - FBD - SCL	Yes Yes Yes	Yes Yes Yes	Yes Yes Yes
<b>Dimensions</b>			
Width	90 mm	90 mm	90 mm
Height	100 mm	100 mm	100 mm
Depth	75 mm	75 mm	75 mm
<b>Weights</b>			
Weight, approx.	420 g	370 g	380 g

## PROFINET/Industrial Ethernet

### Controllers / Modular controllers / SIMATIC S7-1200

#### CPU 1211C

#### Ordering data

##### CPU 1211C

**Compact CPU, AC/DC/relay;**  
Integrated program/data memory  
25 KB, load memory 1 MB;  
Wide-range AC power supply  
85 ... 264 V AC;  
Boolean execution times 0.1 μs  
per operation;  
6 digital inputs,  
4 digital outputs (relays),  
2 analog inputs;  
Expandable with up to  
3 communication modules and  
1 signal board/communication  
board;  
Digital inputs can be used  
as HSC at 100 kHz

**Compact CPU, DC/DC/DC;**  
Integrated program/data memory  
25 KB, load memory 1 MB;  
Supply voltage 24 V DC;  
Boolean execution times 0.1 μs  
per operation;  
6 digital inputs,  
4 digital outputs,  
2 analog inputs;  
Expandable with up to  
3 communication modules and  
1 signal board/communication  
board;  
Digital inputs can be used  
as HSC at 100 kHz,  
24 V DC digital outputs can be  
used as pulse outputs (PTO) or as  
outputs with pulse width modulation  
(PWM) at 100 kHz

**Compact CPU, DC/DC/relay;**  
Integrated program/data memory  
25 KB, load memory 1 MB;  
Supply voltage 24 V DC;  
Boolean execution times 0.1 μs  
per operation;  
6 digital inputs,  
4 digital outputs (relays),  
2 analog inputs;  
Expandable with up to  
3 communication modules and  
1 signal board/communication  
board;  
Digital inputs can be used  
as HSC at 100 kHz

##### SB 1221 signal board

4 inputs, 5 V DC, 200 kHz  
4 inputs, 24 V DC, 200 kHz

##### SB 1222 signal board

4 outputs, 5 V DC, 0.1 A, 200 kHz  
4 outputs, 24 V DC, 0.1 A, 200 kHz

#### Article No.

6ES7211-1BE40-0XB0

6ES7211-1AE40-0XB0

6ES7211-1HE40-0XB0

6ES7221-3AD30-0XB0

6ES7221-3BD30-0XB0

6ES7222-1AD30-0XB0

6ES7222-1BD30-0XB0

#### Article No.

##### SB 1223 signal board

2 inputs, 24 V DC,  
IEC Type 1 sink input;  
2 transistor outputs 24 V DC,  
0.5 A, 5 W;  
Can be used as HSC  
at up to 30 kHz

2 inputs, 5 V DC, 200 kHz  
2 outputs, 5 V DC, 0.1 A, 200 kHz

2 inputs, 24 V DC, 200 kHz  
2 outputs, 24 V DC, 0.1 A, 200 kHz

##### SB 1231 signal board

1 analog input, ±10 V with 12 bits  
or 0 ... 20 mA with 11 bits

##### Thermocouple signal board SB 1231

1 input +/- 80 mV,  
resolution 15 bits + sign,  
thermocouples type J, K

##### RTD signal board SB 1231

1 input for resistance temperature  
sensors Pt 100, Pt 200, Pt 500,  
Pt 1000, resolution 15 bits + sign

##### SB 1232 signal board

1 analog output, ±10 V with 12 bits  
or 0 to 20 mA with 11 bits

##### Communication board CB 1241 RS485

for point-to-point connection,  
with 1 RS485 interface

##### Simulator (optional)

8 input switches,  
for CPU 1211C / CPU 1212C

##### SIMATIC Memory Card (optional)

4 MB

12 MB

24 MB

256 MB

2 GB

##### Terminal block (spare part)

for CPU 1211C/1212C

For DI, with 14 screws, tin-plated;  
4 units

For DO, with 8 screws, tin-plated;  
4 units

For AI, with 3 screws, tin-plated;  
4 units

##### RJ45 cable grip

4 units per pack

Single port

##### Front flap set (spare part)

for CPU 1211C/1212C

6ES7223-0BD30-0XB0

6ES7223-3AD30-0XB0

6ES7223-3BD30-0XB0

6ES7231-4HA30-0XB0

6ES7231-5QA30-0XB0

6ES7231-5PA30-0XB0

6ES7232-4HA30-0XB0

6ES7241-1CH30-1XB0

6ES7274-1XF30-0XA0

6ES7954-8LC02-0AA0

6ES7954-8LE02-0AA0

6ES7954-8LF02-0AA0

6ES7954-8LL02-0AA0

6ES7954-8LP01-0AA0

6ES7292-1AH30-0XA0

6ES7292-1AP30-0XA0

6ES7292-1BC30-0XA0

6ES7290-3AA30-0XA0

6ES7291-1AA30-0XA0

**Ordering data****Article No.****Article No.****S7-1200 automation system,  
System Manual**For SIMATIC S7-1200 and  
STEP 7 Basic

German

**6ES7298-8FA30-8AH0**

English

**6ES7298-8FA30-8BH0**

French

**6ES7298-8FA30-8CH0**

Spanish

**6ES7298-8FA30-8DH0**

Italian

**6ES7298-8FA30-8EH0**

Chinese

**6ES7298-8FA30-8KH0****S7-1200 automation system,  
Easy Book**

Brief instructions

German

**6ES7298-8FA30-8AQ0**

English

**6ES7298-8FA30-8BQ0**

French

**6ES7298-8FA30-8CQ0**

Spanish

**6ES7298-8FA30-8DQ0**

Italian

**6ES7298-8FA30-8EQ0**

Chinese

**6ES7298-8FA30-8KQ0****STEP 7 Professional / Basic V13***Target system:*SIMATIC S7-1200, S7-1500,  
S7-300, S7-400, WinAC*Requirement:*Windows 7 Professional SP1  
(64-bit),  
Windows 7 Enterprise SP1 (64-bit),  
Windows 7 Ultimate SP1 (64 bit),  
Windows 8.1 (64-bit),  
Windows 8.1 Professional (64-bit),  
Windows 8.1 Enterprise (64-bit),  
Windows Server 2008 R2 StdE  
(full installation),  
Windows Server 2012 StdE  
(full installation)*Type of delivery:*German, English, Chinese, Italian,  
French, SpanishSTEP 7 Professional V13,  
Floating License**6ES7822-1AA03-0YA5**STEP 7 Professional V13,  
Floating License,  
Software download  
incl. License Key<sup>1)</sup>**6ES7822-1AE03-0YA5**

E-mail address required for delivery

STEP 7 Basic V13,  
Floating License**6ES7822-0AA03-0YA5**STEP 7 Basic V13,  
Floating License  
Software download incl. License  
Key<sup>1)</sup>**6ES7822-0AE03-0YA5**

E-mail address required for delivery

**Accessories****CSM 1277  
compact switch module**Unmanaged switch for connecting  
a SIMATIC S7-1200 and up to  
three further nodes to Industrial  
Ethernet with 10/100 Mbit/s;  
4 x RJ45 ports;  
external 24 V DC power supply,  
diagnostics on LEDs,  
S7-1200 module including  
electronic manual on CD-ROM**6GK7277-1AA10-0AA0**<sup>1)</sup> For up-to-date information and download availability, see:  
<http://www.siemens.com/tia-online-software-delivery>

## PROFINET/Industrial Ethernet

### Controllers / Modular controllers / SIMATIC S7-1200

#### CPU 1212C

#### Overview



- The superior compact solution
- With 14 integral input/outputs
- Expandable by:
  - 1 signal board (SB) or communication board (CB)
  - 2 signal modules (SM)
  - Max. 3 communication modules (CM)

#### Technical specifications

	6ES7212-1BE40-0XB0 CPU 1212C AC/DC/Relay	6ES7212-1AE40-0XB0 CPU 1212C DC/DC/DC	6ES7212-1HE40-0XB0 CPU 1212C DC/DC/Relay
<b>General information</b>			
Engineering with • Programming package	STEP 7 V13 or higher	STEP 7 V13 or higher	STEP 7 V13 or higher
<b>Supply voltage</b>			
24 V DC		Yes	Yes
120 V AC	Yes		
230 V AC	Yes		
<b>Power losses</b>			
Power loss, typ.	11 W	9 W	9 W
<b>Memory</b>			
Work memory • integrated	50 kbyte	50 kbyte	50 kbyte
Load memory • integrated • plug-in (SIMATIC Memory Card), max.	1 Mbyte 2 Gbyte; with SIMATIC memory card	1 Mbyte 2 Gbyte; with SIMATIC memory card	1 Mbyte 2 Gbyte; with SIMATIC memory card
Backup • without battery	Yes	Yes	Yes
<b>CPU processing times</b>			
for bit operations, typ.	0.085 µs; / Operation	0.085 µs; / Operation	0.085 µs; / Operation
for word operations, typ.	1.7 µs; / Operation	1.7 µs; / Operation	1.7 µs; / Operation
for floating point arithmetic, typ.	2.3 µs; / Operation	2.3 µs; / Operation	2.3 µs; / Operation
<b>Data areas and their retentivity</b>			
Flag • Number, max.	4 kbyte; Size of bit memory address area	4 kbyte; Size of bit memory address area	4 kbyte; Size of bit memory address area
<b>Address area</b>			
Process image • Inputs, adjustable • Outputs, adjustable	1 kbyte 1 kbyte	1 kbyte 1 kbyte	1 kbyte 1 kbyte
<b>Time of day</b>			
Clock • Hardware clock (real-time clock)	Yes	Yes	Yes



**Technical specifications** (continued)

	<b>6ES7212-1BE40-0XB0</b> <b>CPU 1212C AC/DC/Relay</b>	<b>6ES7212-1AE40-0XB0</b> <b>CPU 1212C DC/DC/DC</b>	<b>6ES7212-1HE40-0XB0</b> <b>CPU 1212C DC/DC/Relay</b>
<b>Digital inputs</b>			
Number of digital inputs	8; integrated	8; integrated	8; integrated
• of which, inputs usable for technological functions	6; HSC (High Speed Counting)	6; HSC (High Speed Counting)	6; HSC (High Speed Counting)
<b>Digital outputs</b>			
Number of digital outputs	6; Relays	6	6; Relays
• of which high-speed outputs		4; 100 kHz Pulse Train Output	
<b>Analog inputs</b>			
Integrated channels (AI)	2; 0 to 10 V	2; 0 to 10 V	2; 0 to 10 V
Input ranges			
• Voltage	Yes	Yes	Yes
<b>1st interface</b>			
Interface type	PROFINET	PROFINET	PROFINET
Physics	Ethernet	Ethernet	Ethernet
Functionality			
• PROFINET IO Device	Yes	Yes	Yes
• PROFINET IO Controller	Yes	Yes	Yes
<b>Communication functions</b>			
S7 communication			
• supported	Yes	Yes	Yes
Open IE communication			
• TCP/IP	Yes	Yes	Yes
• ISO-on-TCP (RFC1006)	Yes	Yes	Yes
• UDP	Yes	Yes	Yes
Web server			
• supported	Yes	Yes	Yes
<b>Integrated Functions</b>			
Number of counters	4	6	6
Counter frequency (counter) max.	100 kHz	100 kHz	100 kHz
Frequency meter	Yes	Yes	Yes
Controlled positioning	Yes	Yes	Yes
PID controller	Yes	Yes	Yes
Number of alarm inputs	4	4	4
Number of pulse outputs	4	4	
Limit frequency (pulse)		100 kHz	
<b>Ambient conditions</b>			
Operating temperature			
• min.	-20 °C	-20 °C	-20 °C
• max.	60 °C	60 °C	60 °C
<b>Configuration</b>			
programming			
• Programming language			
- LAD	Yes	Yes	Yes
- FBD	Yes	Yes	Yes
- SCL	Yes	Yes	Yes
<b>Dimensions</b>			
Width	90 mm	90 mm	90 mm
Height	100 mm	100 mm	100 mm
Depth	75 mm	75 mm	75 mm
<b>Weights</b>			
Weight, approx.	425 g	370 g	385 g

# PROFINET/Industrial Ethernet

## Controllers / Modular controllers / SIMATIC S7-1200

### CPU 1212C

#### Ordering data

#### CPU 1212C

**Compact CPU, AC/DC/relay;**  
Integrated program/data memory  
25 KB, load memory 1 MB;  
Wide-range AC power supply  
85 ... 264 V AC;  
Boolean execution times 0.1 μs  
per operation;  
8 digital inputs,  
6 digital outputs (relays),  
2 analog inputs;  
Expandable with up to  
3 communication modules,  
2 signal modules and 1 signal  
board/communication board;  
Digital inputs can be used as HSC  
at 100 kHz

**6ES7212-1BE40-0XB0**

**Compact CPU, DC/DC/DC;**  
Integrated program/data memory  
25 KB, load memory 1 MB;  
Supply voltage 24 V DC;  
Boolean execution times 0.1 μs  
per operation;  
8 digital inputs, 6 digital outputs,  
2 analog inputs;  
Expandable with up to  
3 communication modules,  
2 signal modules and 1 signal  
board/communication board;  
Digital inputs can be used  
as HSC at 100 kHz,  
24 V DC digital outputs can be  
used as pulse outputs (PTO)  
or as outputs with pulse width  
modulation (PWM)  
at 100 kHz

**6ES7212-1AE40-0XB0**

**Compact CPU, DC/DC/relay;**  
Integrated program/data memory  
25 KB, load memory 1 MB;  
Supply voltage 24 V DC;  
Boolean execution times 0.1 μs  
per operation;  
8 digital inputs,  
6 digital outputs (relays),  
2 analog inputs;  
Expandable with up to  
3 communication modules,  
2 signal modules and 1 signal  
board/communication board;  
Digital inputs can be used as HSC  
at 100 kHz

**6ES7212-1HE40-0XB0**

#### SB 1221 signal board

4 inputs, 5 V DC, 200 kHz  
4 inputs, 24 V DC, 200 kHz

**6ES7221-3AD30-0XB0**

**6ES7221-3BD30-0XB0**

#### SB 1222 signal board

4 outputs, 5 V DC, 0.1 A, 200 kHz  
4 outputs, 24 V DC, 0.1 A, 200 kHz

**6ES7222-1AD30-0XB0**

**6ES7222-1BD30-0XB0**

#### SB 1223 signal board

2 inputs, 24 V DC,  
IEC Type 1 sink input;  
2 transistor outputs 24 V DC,  
0.5 A, 5 W;  
Can be used as HSC at  
up to 30 kHz

**6ES7223-0BD30-0XB0**

2 inputs, 5 V DC, 200 kHz  
2 outputs, 5 V DC, 0.1 A, 200 kHz

**6ES7223-3AD30-0XB0**

2 inputs, 24 V DC, 200 kHz  
2 outputs, 24 V DC, 0.1 A, 200 kHz

**6ES7223-3BD30-0XB0**

#### SB 1231 signal board

1 analog input, ±10 V with 12 bits  
or 0 ... 20 mA with 11 bits

**6ES7231-4HA30-0XB0**

#### Thermocouple signal board SB 1231

1 input +/- 80 mV,  
resolution 15 bits + sign,  
thermocouples type J, K

**6ES7231-5QA30-0XB0**

#### RTD signal board SB 1231

1 input for resistance temperature  
sensors Pt 100, Pt 200, Pt 500,  
Pt 1000, resolution 15 bits + sign

**6ES7231-5PA30-0XB0**

#### SB 1232 signal board

1 analog output, ±10 V with 12 bits  
or 0 to 20 mA with 11 bits

**6ES7232-4HA30-0XB0**

#### Communication board CB 1241 RS485

for point-to-point connection,  
with 1 RS485 interface

**6ES7241-1CH30-1XB0**

#### Simulator (optional)

8 input switches,  
for CPU 1211C / CPU 1212C

**6ES7274-1XF30-0XA0**

#### SIMATIC Memory Card (optional)

4 MB  
12 MB  
24 MB  
256 MB  
2 GB

**6ES7954-8LC02-0AA0**

**6ES7954-8LE02-0AA0**

**6ES7954-8LF02-0AA0**

**6ES7954-8LL02-0AA0**

**6ES7954-8LP01-0AA0**

#### Extension cable for two-tier configuration

For connecting digital/analog  
signal modules;  
2 m long

**6ES7290-6AA30-0XA0**

#### Starter box CPU 1212C AC/DC/relay

Complete offer SIMATIC S7-1200,  
starter box, comprising:  
CPU 1212C AC/DC/relay, simulator,  
STEP 7 BASIC CD, manual CD,  
info material, in Systainer

**6ES7212-1BD33-4YB0**

#### Terminal block (spare part)

for CPU 1211C/1212C  
  
For DI, with 14 screws, tin-plated;  
4 units  
  
For DO, with 8 screws, tin-plated;  
4 units  
  
For AI, with 3 screws, tin-plated;  
4 units

**6ES7292-1AH30-0XA0**

**6ES7292-1AP30-0XA0**

**6ES7292-1BC30-0XA0**

Ordering data	Article No.	Article No.
<b>RJ45 cable grip</b> 4 units per pack Single port	<b>6ES7290-3AA30-0XA0</b>	
<b>Front flap set (spare part)</b> for CPU 1211C/1212C	<b>6ES7291-1AA30-0XA0</b>	
<b>S7-1200 automation system, System Manual</b> For SIMATIC S7-1200 and STEP 7 Basic German English French Spanish Italian Chinese	<b>6ES7298-8FA30-8AH0</b> <b>6ES7298-8FA30-8BH0</b> <b>6ES7298-8FA30-8CH0</b> <b>6ES7298-8FA30-8DH0</b> <b>6ES7298-8FA30-8EH0</b> <b>6ES7298-8FA30-8KH0</b>	
<b>S7-1200 automation system, Easy Book</b> Brief instructions German English French Spanish Italian Chinese	<b>6ES7298-8FA30-8AQ0</b> <b>6ES7298-8FA30-8BQ0</b> <b>6ES7298-8FA30-8CQ0</b> <b>6ES7298-8FA30-8DQ0</b> <b>6ES7298-8FA30-8EQ0</b> <b>6ES7298-8FA30-8KQ0</b>	
<b>STEP 7 Professional / Basic V13</b> <i>Target system:</i> SIMATIC S7-1200, S7-1500, S7-300, S7-400, WinAC <i>Requirements:</i> Windows 7 Professional SP1 (64-bit), Windows 7 Enterprise SP1 (64-bit), Windows 7 Ultimate SP1 (64 bit), Windows 8.1 (64-bit), Windows 8.1 Professional (64-bit), Windows 8.1 Enterprise (64-bit), Windows Server 2008 R2 StdE (full installation), Windows Server 2012 StdE (full installation) <i>Type of delivery:</i> German, English, Chinese, Italian, French, Spanish STEP 7 Professional V13, Floating License STEP 7 Professional V13, Floating License, Software download incl. License Key <sup>1)</sup> E-mail address required for delivery STEP 7 Basic V13, Floating License STEP 7 Basic V13, Floating License, Software download incl. License Key <sup>1)</sup> E-mail address required for delivery	<b>6ES7822-1AA03-0YA5</b> <b>6ES7822-1AE03-0YA5</b> <b>6ES7822-0AA03-0YA5</b> <b>6ES7822-0AE03-0YA5</b>	<b>6GK7277-1AA10-0AA0</b> <b>CSM 1277 compact switch module</b> Unmanaged switch for connecting a SIMATIC S7-1200 and up to three further nodes to Industrial Ethernet with 10/100 Mbit/s; 4 x RJ45 ports; external 24 V DC power supply, diagnostics on LEDs, S7-1200 module including electronic manual on CD-ROM 1) For up-to-date information and download availability, see: <a href="http://www.siemens.com/tia-online-software-delivery">http://www.siemens.com/tia-online-software-delivery</a>

## PROFINET/Industrial Ethernet

### Controllers / Modular controllers / SIMATIC S7-1200

#### CPU 1214C

#### Overview



- The compact high-performance CPU
- With 24 integral input/outputs
- Expandable by:
  - 1 signal board (SB) or communication board (CB)
  - 8 signal modules (SM)
  - Max. 3 communication modules (CM)

#### Technical specifications

	6ES7214-1BG40-0XB0 CPU 1214C AC/DC/Relay	6ES7214-1AG40-0XB0 CPU 1214C DC/DC/DC	6ES7214-1HG40-0XB0 CPU 1214C DC/DC/Relay
<b>General information</b>			
Engineering with • Programming package	STEP 7 V13 or higher	STEP 7 V13 or higher	STEP 7 V13 or higher
<b>Supply voltage</b>			
24 V DC		Yes	Yes
120 V AC	Yes		
230 V AC	Yes		
<b>Power losses</b>			
Power loss, typ.	14 W	12 W	12 W
<b>Memory</b>			
Work memory • integrated	75 kbyte	75 kbyte	75 kbyte
Load memory • integrated • plug-in (SIMATIC Memory Card), max.	4 Mbyte 2 Gbyte; with SIMATIC memory card	4 Mbyte 2 Gbyte; with SIMATIC memory card	4 Mbyte 2 Gbyte; with SIMATIC memory card
Backup • without battery	Yes	Yes	Yes
<b>CPU processing times</b>			
for bit operations, typ.	0.085 µs; / Operation	0.085 µs; / Operation	0.085 µs; / Operation
for word operations, typ.	1.7 µs; / Operation	1.7 µs; / Operation	1.7 µs; / Operation
for floating point arithmetic, typ.	2.3 µs; / Operation	2.3 µs; / Operation	2.3 µs; / Operation
<b>Data areas and their retentivity</b>			
Flag • Number, max.	8 kbyte; Size of bit memory address area	8 kbyte; Size of bit memory address area	8 kbyte; Size of bit memory address area
<b>Address area</b>			
Process image • Inputs, adjustable • Outputs, adjustable	1 kbyte 1 kbyte	1 kbyte 1 kbyte	1 kbyte 1 kbyte
<b>Time of day</b>			
Clock • Hardware clock (real-time clock)	Yes	Yes	Yes

**Technical specifications** (continued)

	<b>6ES7214-1BG40-0XB0</b> <b>CPU 1214C AC/DC/Relay</b>	<b>6ES7214-1AG40-0XB0</b> <b>CPU 1214C DC/DC/DC</b>	<b>6ES7214-1HG40-0XB0</b> <b>CPU 1214C DC/DC/Relay</b>
<b>Digital inputs</b>			
Number of digital inputs • of which, inputs usable for technological functions	14; integrated 6; HSC (High Speed Counting)	14; integrated 6; HSC (High Speed Counting)	14; integrated 6; HSC (High Speed Counting)
<b>Digital outputs</b>			
Number of digital outputs • of which high-speed outputs	10; Relays	10 4; 100 kHz Pulse Train Output	10; Relays
<b>Analog inputs</b>			
Integrated channels (AI)	2; 0 to 10 V	2; 0 to 10 V	2; 0 to 10 V
Input ranges • Voltage	Yes	Yes	Yes
<b>1st interface</b>			
Interface type	PROFINET	PROFINET	PROFINET
Physics	Ethernet	Ethernet	Ethernet
Functionality • PROFINET IO Device • PROFINET IO Controller	Yes Yes	Yes Yes	Yes Yes
<b>Communication functions</b>			
S7 communication • supported	Yes	Yes	Yes
Open IE communication • TCP/IP • ISO-on-TCP (RFC1006) • UDP	Yes Yes Yes	Yes Yes Yes	Yes Yes Yes
Web server • supported	Yes	Yes	Yes
<b>Integrated Functions</b>			
Number of counters	6	6	6
Counter frequency (counter) max.	100 kHz	100 kHz	100 kHz
Frequency meter	Yes	Yes	Yes
Controlled positioning	Yes	Yes	Yes
PID controller	Yes	Yes	Yes
Number of alarm inputs	4	4	4
Number of pulse outputs	4	4	4
Limit frequency (pulse)		100 kHz	
<b>Ambient conditions</b>			
Operating temperature • min. • max.	-20 °C 60 °C	-20 °C 60 °C	-20 °C 60 °C
<b>Configuration</b>			
programming • Programming language - LAD - FBD - SCL	Yes Yes Yes	Yes Yes Yes	Yes Yes Yes
<b>Dimensions</b>			
Width	110 mm	110 mm	110 mm
Height	100 mm	100 mm	100 mm
Depth	75 mm	75 mm	75 mm
<b>Weights</b>			
Weight, approx.	475 g	415 g	435 g

## PROFINET/Industrial Ethernet

### Controllers / Modular controllers / SIMATIC S7-1200

#### CPU 1214C

#### Ordering data

##### CPU 1214C

**Compact CPU, AC/DC/relay;**  
Integrated program/data memory  
50 KB, load memory 2 MB;  
Wide-range AC power supply  
85 ... 264 V AC;  
Boolean execution times 0.1 μs  
per operation;  
14 digital inputs,  
10 digital outputs (relays),  
2 analog inputs;  
Expandable with up to  
3 communication modules,  
8 signal modules and 1 signal  
board/communication board;  
Digital inputs can be used as HSC  
at 100 kHz

**Compact CPU, DC/DC/DC;**  
Integrated program/data memory  
50 KB, load memory 2 MB;  
Supply voltage 24 V DC;  
Boolean execution times 0.1 μs  
per operation;  
14 digital inputs,  
10 digital outputs,  
2 analog inputs;  
Expandable with up to  
3 communication modules,  
8 signal modules and 1 signal  
board/communication board;  
Digital inputs can be used as HSC  
at 100 kHz,  
24 V DC digital outputs can be  
used as pulse outputs (PTO)  
or as outputs with pulse-width  
modulation (PWM)  
at 100 kHz

**Compact CPU, DC/DC/relay;**  
Integrated program/data memory  
50 KB, load memory 2 MB;  
Supply voltage 24 V DC;  
Boolean execution times 0.1 μs  
per operation;  
14 digital inputs,  
10 digital outputs (relays),  
2 analog inputs;  
Expandable with up to  
3 communication modules,  
8 signal modules and 1 signal  
board/communication board;  
Digital inputs can be used as HSC  
at 100 kHz

##### SB 1221 signal board

4 inputs, 5 V DC, 200 kHz  
4 inputs, 24 V DC, 200 kHz

##### SB 1222 signal board

4 outputs, 5 V DC, 0.1 A, 200 kHz  
4 outputs, 24 V DC, 0.1 A, 200 kHz

#### Article No.

6ES7214-1BG40-0XB0

6ES7214-1AG40-0XB0

6ES7214-1HG40-0XB0

6ES7221-3AD30-0XB0

6ES7221-3BD30-0XB0

6ES7222-1AD30-0XB0

6ES7222-1BD30-0XB0

#### Article No.

##### SB 1223 signal board

2 inputs, 24 V DC,  
IEC Type 1 sink input;  
2 transistor outputs 24 V DC,  
0.5 A, 5 W;  
Can be used as HSC at  
up to 30 kHz

2 inputs, 5 V DC, 200 kHz  
2 outputs, 5 V DC, 0.1 A, 200 kHz

2 inputs, 24 V DC, 200 kHz  
2 outputs, 24 V DC, 0.1 A, 200 kHz

##### SB 1231 signal board

1 analog input, ±10 V with 12 bits  
or 0 ... 20 mA with 11 bits

##### Thermocouple signal board SB 1231

1 input +/- 80 mV,  
resolution 15 bits + sign,  
thermocouples type J, K

##### RTD signal board SB 1231

1 input for resistance temperature  
sensors Pt 100, Pt 200, Pt 500,  
Pt 1000, resolution 15 bits + sign

##### SB 1232 signal board

1 analog output, ±10 V with 12 bits  
or 0 to 20 mA with 11 bits

##### Communication board CB 1241 RS485

for point-to-point connection,  
with 1 RS485 interface

##### Simulator (optional)

14 input switches, for CPU 1214C

##### SIMATIC Memory Card (optional)

4 MB

12 MB

24 MB

256 MB

2 GB

##### Extension cable for two-tier configuration

For connecting digital/analog  
signal modules;  
2 m long

##### Terminal block (spare part)

for CPU 1214C

For DI, with 20 screws, tin-plated;  
4 units

For DO, with 12 screws, tin-plated;  
4 units

For AI, with 3 screws, tin-plated;  
4 units

##### RJ45 cable grip

4 items per pack

Single port

##### Front flap set (spare part)

for CPU 1214C

6ES7223-0BD30-0XB0

6ES7223-3AD30-0XB0

6ES7223-3BD30-0XB0

6ES7231-4HA30-0XB0

6ES7231-5QA30-0XB0

6ES7231-5PA30-0XB0

6ES7232-4HA30-0XB0

6ES7241-1CH30-1XB0

6ES7274-1XH30-0XA0

6ES7954-8LC02-0AA0

6ES7954-8LE02-0AA0

6ES7954-8LF02-0AA0

6ES7954-8LL02-0AA0

6ES7954-8LP01-0AA0

6ES7290-6AA30-0XA0

6ES7292-1AV30-0XA0

6ES7292-1AM30-0XA0

6ES7292-1BC30-0XA0

6ES7290-3AA30-0XA0

6ES7291-1AB30-0XA0

Ordering data	Article No.	Article No.
<b>S7-1200 automation system, System Manual</b> For SIMATIC S7-1200 and STEP 7 Basic German English French Spanish Italian Chinese	<b>6ES7298-8FA30-8AH0</b> <b>6ES7298-8FA30-8BH0</b> <b>6ES7298-8FA30-8CH0</b> <b>6ES7298-8FA30-8DH0</b> <b>6ES7298-8FA30-8EH0</b> <b>6ES7298-8FA30-8KH0</b>	<b>6GK7277-1AA10-0AA0</b>
<b>S7-1200 automation system, Easy Book</b> Brief instructions German English French Spanish Italian Chinese	<b>6ES7298-8FA30-8AQ0</b> <b>6ES7298-8FA30-8BQ0</b> <b>6ES7298-8FA30-8CQ0</b> <b>6ES7298-8FA30-8DQ0</b> <b>6ES7298-8FA30-8EQ0</b> <b>6ES7298-8FA30-8KQ0</b>	
<b>STEP 7 Professional / Basic V13</b> <i>Target system:</i> SIMATIC S7-1200, S7-1500, S7-300, S7-400, WinAC <i>Requirement:</i> Windows 7 Professional SP1 (64-bit), Windows 7 Enterprise SP1 (64-bit), Windows 7 Ultimate SP1 (64 bit), Windows 8.1 (64-bit), Windows 8.1 Professional (64-bit), Windows 8.1 Enterprise (64-bit), Windows Server 2008 R2 StdE (full installation), Windows Server 2012 StdE (full installation) <i>Type of delivery:</i> German, English, Chinese, Italian, French, Spanish STEP 7 Professional V13, Floating License STEP 7 Professional V13, Floating License, Software download incl. License Key <sup>1)</sup> E-mail address required for delivery STEP 7 Basic V13, Floating License STEP 7 Basic V13, Floating License Software download incl. License Key <sup>1)</sup> E-mail address required for delivery	<b>6ES7822-1AA03-0YA5</b> <b>6ES7822-1AE03-0YA5</b> <b>6ES7822-0AA03-0YA5</b> <b>6ES7822-0AE03-0YA5</b>	<b>Accessories</b> <b>CSM 1277 compact switch module</b> Unmanaged switch for connecting a SIMATIC S7-1200 and up to three further nodes to Industrial Ethernet with 10/100 Mbit/s; 4 x RJ45 ports; external 24 V DC power supply, diagnostics on LEDs, S7-1200 module including electronic manual on CD-ROM 1) For up-to-date information and download availability, see: <a href="http://www.siemens.com/tia-online-software-delivery">http://www.siemens.com/tia-online-software-delivery</a>

## PROFINET/Industrial Ethernet

### Controllers / Modular controllers / SIMATIC S7-1200

#### CPU 1215C

#### Overview



- The compact high-performance CPU
- With 24 integral input/outputs
- Expandable by:
  - 1 signal board (SB) or communication board (CB)
  - 8 signal modules (SM)
  - Max. 3 communication modules (CM)

#### Technical specifications

	6ES7215-1BG40-0XB0 CPU 1215C AC/DC/Relay	6ES7215-1AG40-0XB0 CPU 1215C DC/DC/DC	6ES7215-1HG40-0XB0 CPU 1215C DC/DC/Relay
<b>General information</b>			
Engineering with • Programming package	STEP 7 V13 or higher	STEP 7 V13 or higher	STEP 7 V13 or higher
<b>Supply voltage</b>			
24 V DC		Yes	Yes
120 V AC	Yes		
230 V AC	Yes		
<b>Power losses</b>			
Power loss, typ.	14 W	12 W	12 W
<b>Memory</b>			
Work memory • integrated	100 kbyte	100 kbyte	100 kbyte
Load memory • integrated • plug-in (SIMATIC Memory Card), max.	4 Mbyte 2 Gbyte; with SIMATIC memory card	4 Mbyte 2 Gbyte; with SIMATIC memory card	4 Mbyte 2 Gbyte; with SIMATIC memory card
Backup • without battery	Yes	Yes	Yes
<b>CPU processing times</b>			
for bit operations, typ.	0.085 µs; / Operation	0.085 µs; / Operation	0.085 µs; / Operation
for word operations, typ.	1.7 µs; / Operation	1.7 µs; / Operation	1.7 µs; / Operation
for floating point arithmetic, typ.	2.3 µs; / Operation	2.3 µs; / Operation	2.3 µs; / Operation
<b>Data areas and their retentivity</b>			
Flag • Number, max.	8 kbyte; Size of bit memory address area	8 kbyte; Size of bit memory address area	8 kbyte; Size of bit memory address area
<b>Address area</b>			
Process image • Inputs, adjustable • Outputs, adjustable	1 kbyte 1 kbyte	1 kbyte 1 kbyte	1 kbyte 1 kbyte
<b>Time of day</b>			
Clock • Hardware clock (real-time clock)	Yes	Yes	Yes
<b>Digital inputs</b>			
Number of digital inputs • of which, inputs usable for technological functions	14; integrated 6; HSC (High Speed Counting)	14; integrated 6; HSC (High Speed Counting)	14; integrated 6; HSC (High Speed Counting)



**Technical specifications** (continued)

	<b>6ES7215-1BG40-0XB0</b> CPU 1215C AC/DC/Relay	<b>6ES7215-1AG40-0XB0</b> CPU 1215C DC/DC/DC	<b>6ES7215-1HG40-0XB0</b> CPU 1215C DC/DC/Relay
<b>Digital outputs</b>			
Number of digital outputs	10; Relays	10	10; Relays
• of which high-speed outputs		4; 100 kHz Pulse Train Output	
<b>Analog inputs</b>			
Integrated channels (AI)	2; 0 to 10 V	2; 0 to 10 V	2; 0 to 10 V
Input ranges			
• Voltage	Yes	Yes	Yes
<b>Analog outputs</b>			
Integrated channels (AO)	2; 0 to 20 mA	2; 0 to 20 mA	2; 0 to 20 mA
<b>1st interface</b>			
Interface type	PROFINET	PROFINET	PROFINET
Functionality			
• PROFINET IO Device	Yes	Yes	Yes
• PROFINET IO Controller	Yes	Yes	Yes
<b>Communication functions</b>			
S7 communication			
• supported	Yes	Yes	Yes
Open IE communication			
• TCP/IP	Yes	Yes	Yes
• ISO-on-TCP (RFC 1006)	Yes	Yes	Yes
• UDP	Yes	Yes	Yes
Web server			
• supported	Yes	Yes	Yes
<b>Integrated Functions</b>			
Number of counters	6	6	6
Counter frequency (counter) max.	100 kHz	100 kHz	100 kHz
Frequency meter	Yes	Yes	Yes
Controlled positioning	Yes	Yes	Yes
PID controller	Yes	Yes	Yes
Number of alarm inputs	4	4	4
Number of pulse outputs	4	4	4
Limit frequency (pulse)		100 kHz	
<b>Ambient conditions</b>			
Operating temperature			
• min.	-20 °C	-20 °C	-20 °C
• max.	60 °C	60 °C	60 °C
<b>Configuration</b>			
programming			
• Programming language			
- LAD	Yes	Yes	Yes
- FBD	Yes	Yes	Yes
- SCL	Yes	Yes	Yes
<b>Dimensions</b>			
Width	130 mm	130 mm	130 mm
Height	100 mm	100 mm	100 mm
Depth	75 mm	75 mm	75 mm
<b>Weights</b>			
Weight, approx.	585 g	520 g	550 g

# PROFINET/Industrial Ethernet

## Controllers / Modular controllers / SIMATIC S7-1200

### CPU 1215C

#### Ordering data

#### CPU 1215C

**Compact CPU, AC/DC/relay;**  
Integrated program/data memory  
100 KB, load memory 4 MB;  
Wide-range AC power supply  
85 ... 264 V AC;  
Boolean execution times 0.085 µs  
per operation;  
14 digital inputs,  
10 digital outputs (relays),  
2 analog inputs,  
2 analog outputs;  
Expandable with up to  
3 communication modules,  
8 signal modules and 1 signal  
board/communication board;  
Digital inputs can be used as HSC  
at 100 kHz

**Compact CPU, DC/DC/DC;**  
Integrated program/data memory  
100 KB, load memory 4 MB;  
Supply voltage 24 V DC;  
Boolean execution times 0.085 µs  
per operation;  
14 digital inputs, 10 digital outputs,  
2 analog inputs, 2 analog outputs;  
Expandable with up to  
3 communication modules,  
8 signal modules and 1 signal  
board/communication board;  
Digital inputs can be used as HSC  
at 100 kHz,  
24 V DC digital outputs can be  
used as pulse outputs (PTO)  
or as outputs with pulse width  
modulation (PWM)  
at 100 kHz

**Compact CPU, DC/DC/relay;**  
Integrated program/data memory  
100 KB, load memory 4 MB;  
Supply voltage 24 V DC;  
Boolean execution times 0.085 µs  
per operation;  
14 digital inputs,  
10 digital outputs (relays),  
2 analog inputs,  
2 analog outputs;  
Expandable with up to  
3 communication modules,  
8 signal modules and 1 signal  
board/communication board;  
Digital inputs can be used as HSC  
at 100 kHz

#### SB 1221 signal board

4 inputs, 5 V DC, 200 kHz  
4 inputs, 24 V DC, 200 kHz

#### SB 1222 signal board

4 outputs, 5 V DC, 0.1 A, 200 kHz  
4 outputs, 24 V DC, 0.1 A, 200 kHz

#### Article No.

6ES7215-1BG40-0XB0

6ES7215-1AG40-0XB0

6ES7215-1HG40-0XB0

6ES7221-3AD30-0XB0

6ES7221-3BD30-0XB0

6ES7222-1AD30-0XB0

6ES7222-1BD30-0XB0

#### Article No.

#### SB 1223 signal board

2 inputs, 24 V DC,  
IEC Type 1 sink input;  
2 transistor outputs 24 V DC,  
0.5 A, 5 W;  
Can be used as HSC at  
up to 30 kHz

2 inputs, 5 V DC, 200 kHz  
2 outputs, 5 V DC, 0.1 A, 200 kHz

2 inputs, 24 V DC, 200 kHz  
2 outputs, 24 V DC, 0.1 A, 200 kHz

#### SB 1231 signal board

1 analog input, ±10 V with 12 bits or  
0 ... 20 mA with 11 bits

#### Thermocouple signal board SB 1231

1 input +/- 80 mV,  
resolution 15 bits + sign,  
thermocouples type J, K

#### RTD signal board SB 1231

1 input for resistance temperature  
sensors Pt 100, Pt 200, Pt 500,  
Pt 1000, resolution 15 bits + sign

#### SB 1232 signal board

1 analog output, ±10 V with 12 bits  
or 0 to 20 mA with 11 bits

#### Communication board CB 1241 RS485

for point-to-point connection,  
with 1 RS485 interface

#### BB 1297 battery board

for long-term backup  
of real time clock;  
can be plugged into the signal  
board slot of an S7-1200 CPU  
in FW version 3.0 or higher;  
Battery (CR 1025) not included

#### Simulator (optional)

14 input switches, for CPU 1214C

#### SIMATIC Memory Card (optional)

4 MB

12 MB

24 MB

256 MB

2 GB

#### Extension cable for two-tier configuration

For connecting digital/analog  
signal modules;  
2 m long

#### Terminal block (spare part)

for CPU 1215C

For DI, with 20 screws, tin-plated;  
4 units

For DO, with 12 screws, tin-plated;  
4 units

For analog units, with 6 screws,  
gold-plated; 4 units

6ES7223-0BD30-0XB0

6ES7223-3AD30-0XB0

6ES7223-3BD30-0XB0

6ES7231-4HA30-0XB0

6ES7231-5QA30-0XB0

6ES7231-5PA30-0XB0

6ES7232-4HA30-0XB0

6ES7241-1CH30-1XB0

6ES7297-0AX30-0XA0

6ES7274-1XH30-0XA0

6ES7954-8LC02-0AA0

6ES7954-8LE02-0AA0

6ES7954-8LF02-0AA0

6ES7954-8LL02-0AA0

6ES7954-8LP01-0AA0

6ES7290-6AA30-0XA0

6ES7292-1AV30-0XA0

6ES7292-1AM30-0XA0

6ES7292-1BF30-0XB0

Ordering data	Article No.	Article No.
<b>Front flap set (spare part)</b> for CPU 1215C	<b>6ES7291-1AC30-0XA0</b>	
<b>RJ45 cable grip</b> 4 items per pack Single port	<b>6ES7290-3AA30-0XA0</b>	
Dual port	<b>6ES7290-3AB30-0XA0</b>	
<b>S7-1200 automation system, System Manual</b> For SIMATIC S7-1200 and STEP 7 Basic		
German	<b>6ES7298-8FA30-8AH0</b>	
English	<b>6ES7298-8FA30-8BH0</b>	
French	<b>6ES7298-8FA30-8CH0</b>	
Spanish	<b>6ES7298-8FA30-8DH0</b>	
Italian	<b>6ES7298-8FA30-8EH0</b>	
Chinese	<b>6ES7298-8FA30-8KH0</b>	
<b>S7-1200 automation system, Easy Book</b> Brief instructions		
German	<b>6ES7298-8FA30-8AQ0</b>	
English	<b>6ES7298-8FA30-8BQ0</b>	
French	<b>6ES7298-8FA30-8CQ0</b>	
Spanish	<b>6ES7298-8FA30-8DQ0</b>	
Italian	<b>6ES7298-8FA30-8EQ0</b>	
Chinese	<b>6ES7298-8FA30-8KQ0</b>	
<b>STEP 7 Professional / Basic V13</b> <i>Target system:</i> SIMATIC S7-1200, S7-1500, S7-300, S7-400, WinAC <i>Requirement:</i> Windows 7 Professional SP1 (64-bit), Windows 7 Enterprise SP1 (64-bit), Windows 7 Ultimate SP1 (64 bit), Windows 8.1 (64-bit), Windows 8.1 Professional (64-bit), Windows 8.1 Enterprise (64-bit), Windows Server 2008 R2 StdE (full installation), Windows Server 2012 StdE (full installation) <i>Type of delivery:</i> German, English, Chinese, Italian, French, Spanish		
STEP 7 Professional V13, Floating License	<b>6ES7822-1AA03-0YA5</b>	
STEP 7 Professional V13, Floating License, Software download incl. License Key <sup>1)</sup>	<b>6ES7822-1AE03-0YA5</b>	
E-mail address required for delivery		
STEP 7 Basic V13, Floating License	<b>6ES7822-0AA03-0YA5</b>	
STEP 7 Basic V13, Floating License, Software download incl. License Key <sup>1)</sup>	<b>6ES7822-0AE03-0YA5</b>	
E-mail address required for delivery		
<b>Accessories</b>		
<b>CSM 1277 compact switch module</b> Unmanaged switch for connecting a SIMATIC S7-1200 and up to three further nodes to Industrial Ethernet with 10/100 Mbit/s; 4 x RJ45 ports; external 24 V DC power supply, diagnostics on LEDs, S7-1200 module including electronic manual on CD-ROM		<b>6GK7277-1AA10-0AA0</b>
<sup>1)</sup> For up-to-date information and download availability, see: <a href="http://www.siemens.com/tia-online-software-delivery">http://www.siemens.com/tia-online-software-delivery</a>		

## PROFINET/Industrial Ethernet

### Controllers / Modular controllers / SIMATIC S7-1200

#### CPU 1217C

##### Overview

- The compact high-performance CPU
- With 24 integrated I/Os
- Expandable by:
  - 1 Signal Board (SB) or Communication Board (CB)
  - 8 signal modules (SM)
  - Max. 3 communication modules (CM)

##### Technical specifications

6ES7217-1AG40-0XB0 CPU 1217C DC/DC/DC	
<b>General information</b>	
Engineering with	
• Programming package	STEP 7 V13 or higher
<b>Supply voltage</b>	
24 V DC	Yes
<b>Power losses</b>	
Power loss, typ.	12 W
<b>Memory</b>	
Work memory	
• integrated	125 kbyte
Load memory	
• integrated	4 Mbyte
• plug-in (SIMATIC Memory Card), max.	2 Gbyte; with SIMATIC memory card
Backup	
• without battery	Yes
<b>CPU processing times</b>	
for bit operations, typ.	0.085 µs; / Operation
for word operations, typ.	1.7 µs; / Operation
for floating point arithmetic, typ.	2.3 µs; / Operation
<b>Data areas and their retentivity</b>	
Flag	
• Number, max.	8 kbyte; Size of bit memory address area
<b>Address area</b>	
Process image	
• Inputs, adjustable	1 kbyte
• Outputs, adjustable	1 kbyte
<b>Time of day</b>	
Clock	
• Hardware clock (real-time clock)	Yes
<b>Digital inputs</b>	
Number of digital inputs	14; integrated
• of which, inputs usable for technological functions	6; HSC (High Speed Counting)
<b>Digital outputs</b>	
Number of digital outputs	10
• of which high-speed outputs	4; 1 MHz Pulse Train Output

6ES7217-1AG40-0XB0 CPU 1217C DC/DC/DC	
<b>Analog inputs</b>	
Integrated channels (AI)	2; 0 to 10 V
Input ranges	
• Voltage	Yes
<b>Analog outputs</b>	
Integrated channels (AO)	2; 0 to 20 mA
<b>1st interface</b>	
Interface type	PROFINET
Functionality	
• PROFINET IO Device	Yes
• PROFINET IO Controller	Yes
<b>Communication functions</b>	
S7 communication	
• supported	Yes
Open IE communication	
• TCP/IP	Yes
• ISO-on-TCP (RFC1006)	Yes
• UDP	Yes
Web server	
• supported	Yes
<b>Integrated Functions</b>	
Number of counters	6
Counter frequency (counter) max.	1 MHz
Frequency meter	Yes
Controlled positioning	Yes
PID controller	Yes
Number of alarm inputs	4
Number of pulse outputs	4
Limit frequency (pulse)	1 MHz
<b>Ambient conditions</b>	
Operating temperature	
• min.	-20 °C
• max.	60 °C
<b>Configuration</b>	
programming	
• Programming language	
- LAD	Yes
- FBD	Yes
- SCL	Yes
<b>Dimensions</b>	
Width	150 mm
Height	100 mm
Depth	75 mm
<b>Weights</b>	
Weight, approx.	530 g

Ordering data	Article No.	Article No.
<b>CPU 1217C</b>		
<b>Compact CPU, DC/DC/DC;</b> Integrated program and data memory of 125 KB; load memory of 4 MB; Supply voltage 24 V DC; Boolean execution times 0.085 µs per operation; 14 digital inputs (10 digital 24 V DC inputs, 4 digital 1.5 V DC differential inputs), 10 digital outputs (6 digital 24 V DC outputs, 4 digital 1.5 V DC differential outputs), 2 analog inputs, 2 analog outputs; Expandable with up to 3 communication modules, 8 signal modules and 1 signal board/communication board; Digital inputs can be used as HSC at 1 MHz, 24 V DC digital outputs can be used as pulse outputs (PTO) or outputs with pulse width modulation (PWM) at 100 kHz	<b>6ES7217-1AG40-0XB0</b>	
<b>SB 1221 signal board</b> 4 inputs, 5 V DC, 200 kHz 4 inputs, 24 V DC, 200 kHz	<b>6ES7221-3AD30-0XB0</b> <b>6ES7221-3BD30-0XB0</b>	
<b>SB 1222 signal board</b> 4 outputs, 5 V DC, 0.1 A, 200 kHz 4 outputs, 24 V DC, 0.1 A, 200 kHz	<b>6ES7222-1AD30-0XB0</b> <b>6ES7222-1BD30-0XB0</b>	
<b>SB 1223 signal board</b> 2 inputs, 24 V DC, IEC Type 1 sink input; 2 transistor outputs 24 V DC, 0.5 A, 5 W; Can be used as HSC at up to 30 kHz  2 inputs, 5 V DC, 200 kHz 2 outputs, 5 V DC, 0.1 A, 200 kHz  2 inputs, 24 V DC, 200 kHz 2 outputs, 24 V DC, 0.1 A, 200 kHz	<b>6ES7223-0BD30-0XB0</b>  <b>6ES7223-3AD30-0XB0</b>  <b>6ES7223-3BD30-0XB0</b>	
<b>SB 1231 signal board</b> 1 analog input, ±10 V with 12 bits or 0 ... 20 mA with 11 bits	<b>6ES7231-4HA30-0XB0</b>	
<b>Thermocouple signal board SB 1231</b> 1 input +/- 80 mV, resolution 15 bits + sign, thermocouples type J, K	<b>6ES7231-5QA30-0XB0</b>	
<b>RTD signal board SB 1231</b> 1 input for resistance temperature sensors Pt 100, Pt 200, Pt 500, Pt 1000, resolution 15 bits + sign	<b>6ES7231-5PA30-0XB0</b>	
		<b>SB 1232 signal board</b> 1 analog output, ±10 V with 12 bits or 0 to 20 mA with 11 bits
		<b>Communication board CB 1241 RS485</b> for point-to-point connection, with 1 RS485 interface
		<b>BB 1297 battery board</b> for long-term backup of real time clock; can be plugged into the signal board slot of an S7-1200 CPU in FW version 3.0 or higher; Battery (CR 1025) not included
		<b>Simulator (optional)</b> digital, 14 input switches, for CPU 1217C analog, 2 potentiometer inputs
		<b>SIMATIC Memory Card (optional)</b> 4 MB 12 MB 24 MB 256 MB 2 GB
		<b>Extension cable for two-tier configuration</b> For connecting digital/analog signal modules; 2 m long
		<b>Terminal block (spare part)</b> for CPU 1217C for DI, with 10 screws, tin-plated; 4 units for DI, with 10 screws, tin-plated; 4 units for DO, with 18 screws, tin-plated; 4 units For analog units, with 6 screws, gold-plated; 4 units
		<b>RJ45 cable grip</b> 4 items per pack Dual port
		<b>6ES7232-4HA30-0XB0</b>
		<b>6ES7241-1CH30-1XB0</b>
		<b>6ES7297-0AX30-0XA0</b>
		<b>6ES7274-1XK30-0XA0</b>
		<b>6ES7274-1XA30-0XA0</b>
		<b>6ES7954-8LC02-0AA0</b>
		<b>6ES7954-8LE02-0AA0</b>
		<b>6ES7954-8LF02-0AA0</b>
		<b>6ES7954-8LL02-0AA0</b>
		<b>6ES7954-8LP01-0AA0</b>
		<b>6ES7290-6AA30-0XA0</b>
		<b>6ES7292-1AK30-0XA0</b>
		<b>6ES7292-1AR30-0XA0</b>
		<b>6ES7292-1AT30-0XA0</b>
		<b>6ES7292-1BF30-0XB0</b>
		<b>6ES7290-3AB30-0XA0</b>

# PROFINET/Industrial Ethernet

## Controllers / Modular controllers / SIMATIC S7-1200

### CPU 1217C

#### Ordering data

##### S7-1200 automation system, System Manual

For SIMATIC S7-1200  
and STEP 7 Basic

German	<b>6ES7298-8FA30-8AH0</b>
English	<b>6ES7298-8FA30-8BH0</b>
French	<b>6ES7298-8FA30-8CH0</b>
Spanish	<b>6ES7298-8FA30-8DH0</b>
Italian	<b>6ES7298-8FA30-8EH0</b>
Chinese	<b>6ES7298-8FA30-8KH0</b>

##### S7-1200 automation system, Easy Book

Brief instructions

German	<b>6ES7298-8FA30-8AQ0</b>
English	<b>6ES7298-8FA30-8BQ0</b>
French	<b>6ES7298-8FA30-8CQ0</b>
Spanish	<b>6ES7298-8FA30-8DQ0</b>
Italian	<b>6ES7298-8FA30-8EQ0</b>
Chinese	<b>6ES7298-8FA30-8KQ0</b>

##### STEP 7 Professional / Basic V13

*Target system:*

SIMATIC S7-1200, S7-1500,  
S7-300, S7-400, WinAC

*Requirement:*

Windows 7 Professional SP1  
(64-bit),  
Windows 7 Enterprise SP1 (64-bit),  
Windows 7 Ultimate SP1 (64 bit),  
Windows 8.1 (64-bit),  
Windows 8.1 Professional (64-bit),  
Windows 8.1 Enterprise (64-bit),  
Windows Server 2008 R2 StdE  
(full installation),  
Windows Server 2012 StdE  
(full installation)

*Type of delivery:*

German, English, Chinese, Italian,  
French, Spanish

STEP 7 Professional V13,  
Floating License **6ES7822-1AA03-0YA5**

STEP 7 Professional V13,  
Floating License,  
Software download  
incl. License Key<sup>1)</sup> **6ES7822-1AE03-0YA5**

E-mail address required for delivery

STEP 7 Basic V13,  
Floating License **6ES7822-0AA03-0YA5**

STEP 7 Basic V13,  
Floating License  
Software download  
incl. License Key<sup>1)</sup> **6ES7822-0AE03-0YA5**

E-mail address required for delivery

#### Article No.

##### Accessories

##### CSM 1277 compact switch module

Unmanaged switch for connecting  
a SIMATIC S7-1200 and up to  
three further nodes to Industrial  
Ethernet with 10/100 Mbit/s;  
4 x RJ45 ports;  
external 24 V DC power supply,  
diagnostics on LEDs,  
S7-1200 module including  
electronic manual on CD-ROM

**6GK7277-1AA10-0AA0**

<sup>1)</sup> For up-to-date information and download availability, see:  
<http://www.siemens.com/tia-online-software-delivery>

**Overview CPU 1511-1 PN**

- Entry-level CPU in the S7-1500 controller product range
- Suitable for applications with medium requirements for program scope and processing speed
- Used as central controller in production lines with central and distributed I/O
- PROFINET IO IRT interface with 2-port switch
- PROFINET IO Controller for operating distributed I/O on PROFINET
- PROFINET I-Device for connecting the CPU as an intelligent PROFINET device under a SIMATIC or non-Siemens PROFINET I/O controller
- Isochronous mode
- Integrated Motion Control functionalities for controlling speed-controlled and positioning axes, support for external encoders
- Integrated web server with the option of creating user-defined web pages
- SIMATIC memory card required for operation of the CPU

**Overview CPU 1513-1 PN**

- The CPU for applications with medium requirements for program/data storage in the S7-1500 controller product range
- Medium to high processing speed for binary and floating-point arithmetic
- Used as central controller in production lines with central and distributed I/O
- PROFINET IO IRT interface with 2-port switch
- PROFINET IO Controller for operating distributed I/O on PROFINET
- PROFINET I-Device for connecting the CPU as an intelligent PROFINET device under a SIMATIC or non-Siemens PROFINET I/O controller
- Isochronous mode
- Integrated Motion Control functionalities for controlling speed-controlled and positioning axes, support for external encoders
- Integrated web server with the option of creating user-defined web pages
- SIMATIC memory card required for operation of the CPU

**Overview CPU 1515-2 PN**

- The CPU for applications with medium to high requirements for program/data storage in the S7-1500 controller product range
- Medium to high processing speed for binary and floating-point arithmetic
- Used as central controller in production lines with central and distributed I/O
- PROFINET IO IRT interface with 2-port switch
- Additional PROFINET interface with separate IP address
- PROFINET IO Controller for operating distributed I/O on PROFINET
- PROFINET I-Device for connecting the CPU as an intelligent PROFINET device under a SIMATIC or non-Siemens PROFINET I/O controller
- Isochronous mode
- Integrated Motion Control functionalities for controlling speed-controlled and positioning axes, support for external encoders
- Integrated web server with the option of creating user-defined web pages
- SIMATIC memory card required for operation of the CPU

**PROFINET/Industrial Ethernet****Controllers / Modular controllers / SIMATIC S7-1500****Standard CPUs****Overview CPU 1516-3 PN/DP**

- The CPU with a large program and data memory in the S7-1500 controller product range for applications with high requirements regarding program scope and networking.
- High processing speed for binary and floating-point arithmetic
- Used as central controller in production lines with central and distributed I/O
- PROFINET IO IRT interface with 2-port switch
- Additional PROFINET interface with separate IP address
- PROFINET IO controller for operating distributed I/O on PROFINET.
- PROFINET I-Device for connecting the CPU as an intelligent PROFINET device under a SIMATIC or non-Siemens PROFINET IO controller.
- PROFIBUS DP master interface
- Isochronous mode on PROFIBUS and PROFINET
- Integrated Motion Control functionalities for controlling speed-controlled and positioning axes, support for external encoders
- Integrated web server with the option of creating user-defined web pages
- SIMATIC memory card required for operation of the CPU

**Overview CPU 1518-4 PN/DP**

- The CPU with a very large program and data memory in the S7-1500 controller product range for demanding applications with extremely high requirements regarding program scope, performance and networking
- Extremely high processing speed for binary and floating-point arithmetic
- For cross-industry automation tasks in series machine, special machine and plant construction
- Used as central controller in production lines with central and distributed I/O
- PROFINET IO IRT interface with 2-port switch
- Two additional PROFINET interfaces with separate IP address
- PROFINET IO controller for operating distributed I/O on PROFINET.
- PROFINET I-Device for connecting the CPU as an intelligent PROFINET device under a SIMATIC or non-Siemens PROFINET IO controller.
- PROFIBUS DP master interface
- Isochronous mode on PROFIBUS and PROFINET
- Integrated Motion Control functionalities for controlling speed-controlled and positioning axes, support for external encoders
- Integrated web server with the option of creating user-defined web pages
- SIMATIC memory card required for operation of the CPU



**Technical specifications**

	<b>6ES7511-1AK00-0AB0</b> <b>CPU 1511-1 PN</b>	<b>6ES7513-1AL00-0AB0</b> <b>CPU 1513-1 PN</b>	<b>6ES7515-2AM00-0AB0</b> <b>CPU 1515-2 PN</b>
<b>General information</b>			
Engineering with • STEP 7 TIA Portal can be configured/integrated as of version	V13	V13	V13
<b>Display</b>			
Screen diagonal (cm)	3.45 cm	3.45 cm	6.1 cm
<b>Supply voltage</b>			
Type of supply voltage	24 V DC	24 V DC	24 V DC
<b>Power losses</b>			
Power loss, typ.	5.7 W	5.7 W	6.3 W
<b>Memory</b>			
Work memory • integrated (for program) • integrated (for data)	150 kbyte 1 Mbyte	300 kbyte 1.5 Mbyte	500 kbyte 3 Mbyte
Load memory • Plug-in (SIMATIC Memory Card), max.	32 Gbyte	32 Gbyte	32 Gbyte
<b>CPU processing times</b>			
for bit operations, typ.	60 ns	40 ns	30 ns
for word operations, typ.	72 ns	48 ns	36 ns
for fixed point arithmetic, typ.	96 ns	64 ns	48 ns
for floating point arithmetic, typ.	384 ns	256 ns	192 ns
<b>Counters, timers and their retentivity</b>			
S7 counter • Number	2 048	2 048	2 048
IEC counter • Number	Any (only limited by the main memory)	Any (only limited by the main memory)	Any (only limited by the main memory)
S7 timer • Number	2 048	2 048	2 048
IEC timer • Number	Any (only limited by the main memory)	Any (only limited by the main memory)	Any (only limited by the main memory)
<b>Data areas and their retentivity</b>			
Flag • Number, max.	16 kbyte	16 kbyte	16 kbyte
<b>Address area</b>			
I/O address area • Inputs • Outputs	32 kbyte; All inputs are in the process image 32 kbyte; All outputs are in the process image	32 kbyte; All inputs are in the process image 32 kbyte; All outputs are in the process image	32 kbyte; All inputs are in the process image 32 kbyte; All outputs are in the process image
<b>Time of day</b>			
Clock • Type	Hardware clock	Hardware clock	Hardware clock

## PROFINET/Industrial Ethernet

### Controllers / Modular controllers / SIMATIC S7-1500

#### Standard CPUs

#### Technical specifications (continued)

	6ES7511-1AK00-0AB0 CPU 1511-1 PN	6ES7513-1AL00-0AB0 CPU 1513-1 PN	6ES7515-2AM00-0AB0 CPU 1515-2 PN
<b>Interfaces</b>			
1st interface			
• Interface types			
- Number of ports	2	2	2
- Integrated switch	Yes	Yes	Yes
- RJ 45 (Ethernet)	Yes	Yes	Yes
• Protocols			
- PROFINET IO Controller	Yes	Yes	Yes
- PROFINET IO Device	Yes	Yes	Yes
- SIMATIC communication	Yes	Yes	Yes
- Open IE communication	Yes	Yes	Yes
- Web server	Yes	Yes	Yes
- Media redundancy	Yes	Yes	Yes
2nd interface			
• Interface types			
- Number of ports			1
- Integrated switch			No
- RJ 45 (Ethernet)			Yes
• Protocols			
- PROFINET IO Controller			No
- PROFINET IO Device			No
- SIMATIC communication			Yes
- Open IE communication			Yes
- Web server			Yes
<b>Protocols</b>			
Number of connections			
• Number of connections, max.	96	128	192; via integrated interfaces of the CPU and connected CPs / CMs
PROFINET IO Controller			
• Services			
- Max. number of connectable IO devices for RT	128	128	256
- Number of IO Devices with IRT and the option "high performance", max.	64	64	64
<b>Isochronous mode</b>			
Isochronous operation (application synchronized up to terminal)			
	Yes	Yes	Yes
<b>Supported technology objects</b>			
Motion			
• Speed-controlled axis			
- Number of speed-controlled axes, max.	6; Up to 6 axes in total (speed-controlled, positioning axis, external encoders) are supported	6; Up to 6 axes in total (speed-controlled, positioning axis, external encoders) are supported	20; Up to 20 axes in total (speed-controlled, positioning axis, external encoders) are supported
• Positioning axis			
- Number of positioning axes, max.	6; Up to 6 axes in total (speed-controlled, positioning axis, external encoders) are supported	6; Up to 6 axes in total (speed-controlled, positioning axis, external encoders) are supported	20; Up to 20 axes in total (speed-controlled, positioning axis, external encoders) are supported
• External encoders			
- Number of external encoders, max.	6; Up to 6 axes in total (speed-controlled, positioning axis, external encoders) are supported	6; Up to 6 axes in total (speed-controlled, positioning axis, external encoders) are supported	20; Up to 20 axes in total (speed-controlled, positioning axis, external encoders) are supported
Controller			
• PID_Compact			
	Yes; Universal PID controller with integrated optimization	Yes; Universal PID controller with integrated optimization	Yes; Universal PID controller with integrated optimization
• PID_3Step			
	Yes; PID controller with integrated optimization for valves	Yes; PID controller with integrated optimization for valves	Yes; PID controller with integrated optimization for valves
Counting and measuring			
• High-speed counter			
	Yes	Yes	Yes

**Technical specifications** (continued)

	<b>6ES7511-1AK00-0AB0</b> <b>CPU 1511-1 PN</b>	<b>6ES7513-1AL00-0AB0</b> <b>CPU 1513-1 PN</b>	<b>6ES7515-2AM00-0AB0</b> <b>CPU 1515-2 PN</b>
<b>Ambient conditions</b>			
Operating temperature	0 °C	0 °C	0 °C
• horizontal installation, min.	60 °C;	60 °C;	60 °C;
• horizontal installation, max.	Display: 50 °C, at an operating temperature of typically 50 °C, the display is switched off	Display: 50 °C, at an operating temperature of typically 50 °C, the display is switched off	Display: 50 °C, at an operating temperature of typically 50 °C, the display is switched off
• vertical installation, min.	0 °C	0 °C	0 °C
• vertical installation, max.	40 °C;	40 °C;	40 °C;
	Display: 40 °C, at an operating temperature of typically 40 °C, the display is switched off	Display: 40 °C, at an operating temperature of typically 40 °C, the display is switched off	Display: 40 °C, at an operating temperature of typically 40 °C, the display is switched off
<b>Configuration</b>			
programming			
• Programming language			
- LAD	Yes	Yes	Yes
- FBD	Yes	Yes	Yes
- STL	Yes	Yes	Yes
- SCL	Yes	Yes	Yes
- GRAPH	Yes; from STEP 7 V12 SP1	Yes; from STEP 7 V12 SP1	Yes
<b>Know-how protection</b>			
• User program protection	Yes	Yes	Yes
• Copy protection	Yes	Yes	Yes
• Block protection	Yes	Yes	Yes
<b>Access protection</b>			
• Password for display	Yes	Yes	Yes
• Protection level: Write protection	Yes	Yes	Yes
• Protection level: Read/write protection	Yes	Yes	Yes
• Protection level: Complete protection	Yes	Yes	Yes
<b>Dimensions</b>			
Width	35 mm	35 mm	70 mm
Height	147 mm	147 mm	147 mm
Depth	129 mm	129 mm	129 mm
<b>Weights</b>			
Weight, approx.	430 g	430 g	830 g

	<b>6ES7516-3AN00-0AB0</b> <b>CPU 1516-3 PN/DP</b>	<b>6ES7518-4AP00-0AB0</b> <b>CPU 1518-4 PN/DP</b>
<b>General information</b>		
Engineering with		
• STEP 7 TIA Portal can be configured/integrated as of version	V13	V13
<b>Display</b>		
Screen diagonal (cm)	6.1 cm	6.1 cm
<b>Supply voltage</b>		
Type of supply voltage	24 V DC	24 V DC
<b>Power losses</b>		
Power loss, typ.	7 W	24 W
<b>Memory</b>		
Work memory		
• integrated (for program)	1 Mbyte	3 Mbyte
• integrated (for data)	5 Mbyte	10 Mbyte
Load memory		
• Plug-in (SIMATIC Memory Card), max.	32 Gbyte	32 Gbyte
<b>CPU processing times</b>		
for bit operations, typ.	10 ns	1 ns
for word operations, typ.	12 ns	2 ns
for fixed point arithmetic, typ.	16 ns	2 ns
for floating point arithmetic, typ.	64 ns	6 ns

## PROFINET/Industrial Ethernet

### Controllers / Modular controllers / SIMATIC S7-1500

#### Standard CPUs

#### Technical specifications (continued)

	6ES7516-3AN00-0AB0 CPU 1516-3 PN/DP	6ES7518-4AP00-0AB0 CPU 1518-4 PN/DP
<b>Counters, timers and their retentivity</b>		
S7 counter		
• Number	2 048	2 048
IEC counter		
• Number	Any (only limited by the main memory)	Any (only limited by the main memory)
S7 times		
• Number	2 048	2 048
IEC timer		
• Number	Any (only limited by the main memory)	Any (only limited by the main memory)
<b>Data areas and their retentivity</b>		
Flag		
• Number, max.	16 kbyte	16 kbyte
<b>Address area</b>		
I/O address area		
• Inputs	32 kbyte; All inputs are in the process image	32 kbyte; All inputs are in the process image
• Outputs	32 kbyte; All outputs are in the process image	32 kbyte; All outputs are in the process image
<b>Time of day</b>		
Clock		
• Type	Hardware clock	Hardware clock
<b>Interfaces</b>		
1st interface		
• Interface types		
- Number of ports	2	2
- Integrated switch	Yes	Yes
- RJ 45 (Ethernet)	Yes	Yes
• Protocols		
- PROFINET IO Controller	Yes	Yes
- PROFINET IO Device	Yes	Yes
- SIMATIC communication	Yes	Yes
- Open IE communication	Yes	Yes
- Web server	Yes	Yes
- Media redundancy	Yes	Yes
2nd interface		
• Interface types		
- Number of ports	1	1
- Integrated switch	No	No
- RJ 45 (Ethernet)	Yes	Yes
• Protocols		
- PROFINET IO Controller	No	No
- PROFINET IO Device	No	No
- SIMATIC communication	Yes	Yes
- Open IE communication	Yes	Yes
- Web server	Yes	Yes
3rd interface		
• Interface types		
- Number of ports	1	1
- Integrated switch		No
- RJ 45 (Ethernet)		Yes
- RS 485	Yes	
• Protocols		
- PROFINET IO Controller		No
- PROFINET IO Device		No
- SIMATIC communication	Yes	Yes
- Open IE communication		Yes
- Web server		Yes
- PROFIBUS DP master	Yes	
- PROFIBUS DP slave	No	
4th interface		
• Interface types		
- Number of ports		1
- RS 485		Yes
• Protocols		
- SIMATIC communication		Yes
- PROFIBUS DP master		Yes
- PROFIBUS DP slave		No

### Technical specifications (continued)

	<b>6ES7516-3AN00-0AB0</b> <b>CPU 1516-3 PN/DP</b>	<b>6ES7518-4AP00-0AB0</b> <b>CPU 1518-4 PN/DP</b>
<b>Protocols</b>		
Number of connections		
• Number of connections, max.	256	384; via integrated interfaces of the CPU and connected CPs / CMs
<b>PROFINET IO Controller</b>		
• Services		
- Max. number of connectable IO devices for RT	256	512
- Number of IO Devices with IRT and the option "high performance", max.	64	64
<b>PROFIBUS</b>		
• Services		
- Number of DP slaves	125; In total, up to 768 distributed I/O devices can be connected via PROFIBUS or PROFINET	125; In total, up to 768 distributed I/O devices can be connected via PROFIBUS or PROFINET
<b>Isochronous mode</b>		
Isochronous operation (application synchronized up to terminal)	Yes	Yes
<b>Supported technology objects</b>		
Motion		
• Speed-controlled axis	Yes	Yes
- Number of speed-controlled axes, max.	20; Up to 20 axes in total (speed-controlled, positioning axis, external encoders) are supported	128; Up to 128 axes in total (speed-controlled, positioning axis, external encoders) are supported
• Positioning axis	Yes	Yes
- Number of positioning axes, max.	20; Up to 20 axes in total (speed-controlled, positioning axis, external encoders) are supported	128; Up to 128 axes in total (speed-controlled, positioning axis, external encoders) are supported
• External encoders	Yes	Yes
- Number of external encoders, max.	20; Up to 20 axes in total (speed-controlled, positioning axis, external encoders) are supported	128; Up to 128 axes in total (speed-controlled, positioning axis, external encoders) are supported
Controller		
• PID_Compact	Yes; Universal PID controller with integrated optimization	Yes; Universal PID controller with integrated optimization
• PID_3Step	Yes; PID controller with integrated optimization for valves	Yes; PID controller with integrated optimization for valves
Counting and measuring		
• High-speed counter	Yes	Yes
<b>Ambient conditions</b>		
Operating temperature		
• horizontal installation, min.	0 °C	0 °C
• horizontal installation, max.	60 °C; Display: 50 °C, at an operating temperature of typically 50 °C, the display is switched off	60 °C; Display: 50 °C, at an operating temperature of typically 50 °C, the display is switched off
• vertical installation, min.	0 °C	0 °C
• vertical installation, max.	40 °C; Display: 40 °C, at an operating temperature of typically 40 °C, the display is switched off	40 °C; Display: 40 °C, at an operating temperature of typically 40 °C, the display is switched off
<b>Configuration</b>		
programming		
• Programming language		
- LAD	Yes	Yes
- FBD	Yes	Yes
- STL	Yes	Yes
- SCL	Yes	Yes
- GRAPH	Yes; STEP 7 V12 SP1 or higher	Yes
Know-how protection		
• User program protection	Yes	Yes
• Copy protection	Yes	Yes
• Block protection	Yes	Yes
Access protection		
• Password for display	Yes	Yes
• Protection level: Write protection	Yes	Yes
• Protection level: Read/write protection	Yes	Yes
• Protection level: Complete protection	Yes	Yes
<b>Dimensions</b>		
Width	70 mm	175 mm
Height	147 mm	147 mm
Depth	129 mm	129 mm
<b>Weights</b>		
Weight, approx.	845 g	1 988 g

## PROFINET/Industrial Ethernet

### Controllers / Modular controllers / SIMATIC S7-1500

#### Standard CPUs

Ordering data	Article No.	Article No.
<b>CPU 1511-1 PN</b> Work memory 150 KB for program, 1 MB for data, PROFINET IO IRT interface, SIMATIC memory card required	<b>6ES7511-1AK00-0AB0</b>	<b>Load power supply</b> 24 V DC/3A 24 V DC/8A <b>Power supply connector</b> Spare part; for connecting the 24 V DC supply voltage • with push-in terminals
<b>CPU 1513-1 PN</b> Work memory 300 KB for program, 1.5 MB for data, PROFINET IO IRT interface, SIMATIC memory card required	<b>6ES7513-1AL00-0AB0</b>	<b>6EP1332-4BA00</b> <b>6EP1333-4BA00</b> <b>6ES7193-4JB00-0AA0</b>
<b>CPU 1515-2 PN</b> Work memory 500 KB for program, 3 MB for data, PROFINET IO IRT interface, PROFINET interface; SIMATIC memory card required	<b>6ES7515-2AM00-0AB0</b>	<b>IE FC RJ45 plugs</b> RJ45 plug connector for Industrial Ethernet with a rugged metal enclosure and integrated insulation displacement contacts for connecting Industrial Ethernet FC installation cables
<b>CPU 1516-3 PN/DP</b> 1 MB RAM for program, 5 MB for data, PROFINET IO IRT interface, PROFINET/PROFIBUS interface; SIMATIC memory card required	<b>6ES7516-3AN00-0AB0</b>	<b>IE FC RJ45 Plug 180</b> 180° cable outlet 1 unit 10 units 50 units
<b>CPU 1518-4 PN/DP</b> Work memory 3 MB for program, 10 MB for data, PROFINET IO IRT interface, 2 PROFINET/PROFIBUS interfaces; SIMATIC memory card required	<b>6ES7518-4AP00-0AB0</b>	<b>IE FC TP Standard Cable GP 2x2</b> 4-core, shielded TP installation cable for connection to IE FC Outlet RJ45/ IE FC RJ45 Plug; PROFINET-compatible; with UL approval; Sold by the meter, max. length 1 000 m, minimum order quantity 20 m
<b>Accessories</b>		
<b>SIMATIC memory card</b> 4 MB 12 MB 24 MB 256 MB 2 GB	<b>6ES7954-8LC02-0AA0</b> <b>6ES7954-8LE02-0AA0</b> <b>6ES7954-8LF02-0AA0</b> <b>6ES7954-8LL02-0AA0</b> <b>6ES7954-8LP01-0AA0</b>	<b>IE FC TP Trailing Cable 2 x 2 (Type C)</b> 4-core, shielded TP installation cable for connection to IE FC Outlet RJ45/ IE FC RJ45 Plug 180/90 for cable carrier use; PROFINET-compatible; with UL approval; Sold by the meter, max. length 1 000 m, minimum order quantity 20 m
<b>SIMATIC S7-1500 mounting rail</b> Fixed lengths, with grounding elements • 160 mm • 482 mm • 530 mm • 830 mm For cutting to length by customer, without drill holes; grounding elements must be ordered separately • 2 000 mm	<b>6ES7590-1AB60-0AA0</b> <b>6ES7590-1AE80-0AA0</b> <b>6ES7590-1AF30-0AA0</b> <b>6ES7590-1AJ30-0AA0</b>  <b>6ES7590-1BC00-0AA0</b>	<b>IE FC TP Marine Cable 2 x 2 (Type B)</b> 4-core, shielded TP installation cable for connection to IE FC Outlet RJ45/ IE FC RJ45 Plug 180/90 marine certified, Sold by the meter, max. length 1 000 m, minimum order quantity 20 m
<b>PE connection element for mounting rail 2 000 mm</b> 20 units	<b>6ES7590-5AA00-0AA0</b>	<b>IE FC Stripping Tool</b> Preadjusted stripping tool for fast stripping of Industrial Ethernet FC cables
<b>Power supply</b> For supplying the backplane bus of the S7-1500 24 V DC input voltage, power 25 W 24/48/60 V DC input voltage, power 60 W 120/230 V AC input voltage, power 60 W	<b>6ES7505-0KA00-0AB0</b> <b>6ES7505-0RA00-0AB0</b>  <b>6ES7507-0RA00-0AB0</b>	<b>Displays</b> • for CPU 1511-1 PN and CPU 1513-1 PN; spare part • for CPU 1515-2 PN, CPU 1516-3 PN/DP and CPU 1518-4 PN/DP; spare part
<b>Power connector</b> With coding element for power supply module; spare part, 10 units	<b>6ES7590-8AA00-0AA0</b>	<b>6GK1901-1BB10-2AA0</b> <b>6GK1901-1BB10-2AB0</b> <b>6GK1901-1BB10-2AE0</b> <b>6XV1840-2AH10</b> <b>6XV1840-3AH10</b> <b>6XV1840-4AH10</b> <b>6GK1901-1GA00</b> <b>6ES7591-1AA00-0AA0</b> <b>6ES7591-1BA00-0AA0</b>

**Ordering data****Article No.****SIMATIC S7-1500 Starter Kit****6ES7511-1AK01-4YB5**

Consisting of:  
 CPU 1511-1 PN,  
 SIMATIC memory card 4 MB,  
 digital input DI 16 x 24 V DC HF,  
 digital output DO 16 x 24 V DC/  
 0.5 A ST, 160 mm mounting rail,  
 front connector,  
 STEP 7 Professional V12,  
 365-day license,  
 power supply 60 W AC 120/230 V,  
 Standard Ethernet CAT 5 cable  
 (2 m), screwdriver,  
 documentation

**STEP 7 Professional V13***Target system:*

SIMATIC S7-1200, S7-1500,  
 S7-300, S7-400, WinAC

*Requirement:*

Windows 7 Professional SP1  
 (64-bit),  
 Windows 7 Enterprise SP1 (64-bit),  
 Windows 7 Ultimate SP1 (64 bit),  
 Windows 8.1 (64-bit),  
 Windows 8.1 Professional (64-bit),  
 Windows 8.1 Enterprise (64-bit),  
 Windows Server 2008 R2 StdE  
 (full installation),  
 Windows Server 2012 StdE  
 (full installation)

*Type of delivery:*

German, English, Chinese, Italian,  
 French, Spanish

STEP 7 Professional V13,  
 Floating License

**6ES7822-1AA03-0YA5**

STEP 7 Professional V13,  
 Floating License,  
 Software download  
 incl. License Key <sup>1)</sup>

**6ES7822-1AE03-0YA5**

E-mail address required for delivery

<sup>1)</sup> For up-to-date information and download availability, see:  
<http://www.siemens.com/tia-online-software-delivery>

**More information*****Further information and downloads***Manuals

The SIMATIC S7-1500 manuals can be downloaded free of charge from the Internet (SIMATIC Customer Support).

<http://support.automation.siemens.com/WWW/view/en/86140384>

SIMATIC S7-1500 Display Simulator

Using the Display Simulator of the S7-1500, you can become familiar in advance with the different setting options and functions on the display.

[http://www.automation.siemens.com/salesmaterial-as/interactive-manuals/getting-started\\_simatic-s7-1500/disp\\_tool/start\\_en.html](http://www.automation.siemens.com/salesmaterial-as/interactive-manuals/getting-started_simatic-s7-1500/disp_tool/start_en.html)

General information

<http://www.siemens.com/S7-1500>

SIMATIC Selection Tool

<http://www.siemens.com/tia-selection-tool>

Brochures

Information material for downloading can be found on the Internet:

<http://www.siemens.com/simatic/printmaterial>

## PROFINET/Industrial Ethernet

### Controllers / Modular controllers / SIMATIC S7-1500

#### Fail-safe CPUs

##### Overview CPU 1516F-3 PN/DP

- The CPU with a large program and data memory in the S7-1500 controller product range for fail-safe applications with high requirements regarding program scope and networking.
- High processing speed for binary and floating-point arithmetic
- Used as central controller in production lines with central and distributed I/O.
- Supports PROFIsafe in centralized and distributed configuration.
- PROFINET IO IRT interface with 2-port switch.
- Additional PROFINET interface with separate IP address.
- PROFINET IO controller for operating distributed I/O on PROFINET.
- PROFINET I-Device for connecting the CPU as an intelligent PROFINET device under a SIMATIC or non-Siemens PROFINET IO controller.
- PROFIBUS DP master interface.
- Isochronous mode on PROFIBUS and PROFINET.
- Integrated Motion Control functionalities for controlling speed-controlled and positioning axes, support for external encoders.
- Integrated Web server with the option of creating user-defined Web pages.

Note:

SIMATIC Memory Card required for operation of the CPU.

##### Overview CPU 1518F-4 PN/DP

- The CPU with a very large program and data memory in the S7-1500 controller product range for fail-safe applications with highest requirements regarding program scope and networking.
- Extremely high processing speed for binary and floating-point arithmetic.
- For cross-industry automation tasks in series machine, special machine and plant construction
- Used as central controller in production lines with central and distributed I/O.
- Supports PROFIsafe in centralized and distributed configuration.
- PROFINET IO IRT interface with 2-port switch.
- Two additional PROFINET interfaces with separate IP addresses.
- PROFINET IO controller for operating distributed I/O on PROFINET.
- PROFINET I-Device for connecting the CPU as an intelligent PROFINET device under a SIMATIC or non-Siemens PROFINET IO controller.
- PROFIBUS DP master interface.
- Isochronous mode on PROFIBUS and PROFINET.
- Integrated Motion Control functionalities for controlling speed-controlled and positioning axes, support for external encoders
- Integrated Web server with the option of creating user-defined Web pages.

Note:

SIMATIC Memory Card required for operation of the CPU.

#### Technical specifications

	6ES7516-3FN00-0AB0 CPU 1516F-3 PN/DP	6ES7518-4FP00-0AB0 CPU 1518F-4PN/DP
<b>General information</b> Engineering with • STEP 7 TIA Portal can be configured/integrated as of version	V13	V13
<b>Display</b> Screen diagonal (cm)	6.1 cm	6.1 cm
<b>Supply voltage</b> Type of supply voltage	24 V DC	24 V DC
<b>Power losses</b> Power loss, typ.	7 W	24 W
<b>Memory</b> Work memory • integrated (for program) • integrated (for data)	1.5 Mbyte 5 Mbyte	4.5 Mbyte 10 Mbyte
Load memory • Plug-in (SIMATIC Memory Card), max.	32 Gbyte	32 Gbyte
<b>CPU processing times</b> for bit operations, typ.	10 ns	1 ns
for word operations, typ.	12 ns	2 ns
for fixed point arithmetic, typ.	16 ns	2 ns
for floating point arithmetic, typ.	64 ns	6 ns



**Technical specifications** (continued)

	<b>6ES7516-3FN00-0AB0</b> <b>CPU 1516F-3 PN/DP</b>	<b>6ES7518-4FP00-0AB0</b> <b>CPU 1518F-4PN/DP</b>
<b>Counters, timers and their retentivity</b>		
S7 counter		
• Number	2 048	2 048
IEC counter		
• Number	Any (only limited by the main memory)	Any (only limited by the main memory)
S7 times		
• Number	2 048	2 048
IEC timer		
• Number	Any (only limited by the main memory)	Any (only limited by the main memory)
<b>Data areas and their retentivity</b>		
Flag		
• Number, max.	16 kbyte	16 kbyte
<b>Address area</b>		
I/O address area		
• Inputs	32 kbyte; All inputs are in the process image	32 kbyte; All inputs are in the process image
• Outputs	32 kbyte; All outputs are in the process image	32 kbyte; All outputs are in the process image
<b>Time of day</b>		
Clock		
• Type	Hardware clock	Hardware clock
<b>Interfaces</b>		
1st interface		
• Interface types		
- Number of ports	2	2
- Integrated switch	Yes	Yes
- RJ 45 (Ethernet)	Yes	Yes
• Protocols		
- PROFINET IO Controller	Yes	Yes
- PROFINET IO Device	Yes	Yes
- SIMATIC communication	Yes	Yes
- Open IE communication	Yes	Yes
- Web server	Yes	Yes
- Media redundancy	Yes	Yes
2nd interface		
• Interface types		
- Number of ports	1	1
- Integrated switch	No	No
- RJ 45 (Ethernet)	Yes	Yes
• Protocols		
- PROFINET IO Controller	No	No
- PROFINET IO Device	No	No
- SIMATIC communication	Yes	Yes
- Open IE communication	Yes	Yes
- Web server	Yes	Yes
3rd interface		
• Interface types		
- Number of ports	1	1
- Integrated switch		No
- RJ 45 (Ethernet)		Yes
- RS 485	Yes	
• Protocols		
- PROFINET IO Controller		No
- PROFINET IO Device		No
- SIMATIC communication	Yes	Yes
- Open IE communication		Yes
- Web server		Yes
- PROFIBUS DP master	Yes	
- PROFIBUS DP slave	No	
4th interface		
• Interface types		
- Number of ports		1
- RS 485		Yes
• Protocols		
- SIMATIC communication		Yes
- PROFIBUS DP master		Yes
- PROFIBUS DP slave		No

## PROFINET/Industrial Ethernet

### Controllers / Modular controllers / SIMATIC S7-1500

#### Fail-safe CPUs

#### Technical specifications (continued)

	6ES7516-3FN00-0AB0 CPU 1516F-3 PN/DP	6ES7518-4FP00-0AB0 CPU 1518F-4PN/DP
<b>Protocols</b>		
Number of connections		
• Number of connections, max.	256; via integrated interfaces of the CPU and connected CPs / CMs	384; via integrated interfaces of the CPU and connected CPs / CMs
<b>PROFINET IO Controller</b>		
• Services		
- Max. number of connectable IO devices for RT	256	512
- Number of IO Devices with IRT and the option "high performance", max.	64	64
<b>PROFIBUS</b>		
• Services		
- Number of DP slaves	125; In total, up to 768 distributed I/O devices can be connected via CPs/CMs via PROFIBUS or PROFINET	125; In total, up to 768 distributed I/O devices can be connected via CPs/CMs via PROFIBUS or PROFINET
<b>Isochronous mode</b>		
Isochronous operation (application synchronized up to terminal)	Yes	Yes
<b>supported technology objects</b>		
<b>Motion</b>		
• Speed-controlled axis		
- Number of speed-controlled axes, max.	20; Up to 20 axes in total (speed-controlled, positioning axis, external encoders) are supported	128; Up to 128 axes in total (speed-controlled, positioning axis, external encoders) are supported
• Positioning axis		
- Number of positioning axes, max.	20; Up to 20 axes in total (speed-controlled, positioning axis, external encoders) are supported	128; Up to 128 axes in total (speed-controlled, positioning axis, external encoders) are supported
• External encoders		
- Number of external encoders, max.	20; Up to 20 axes in total (speed-controlled, positioning axis, external encoders) are supported	128; Up to 128 axes in total (speed-controlled, positioning axis, external encoders) are supported
<b>Controller</b>		
• PID_Compact	Yes; Universal PID controller with integrated optimization	Yes; Universal PID controller with integrated optimization
• PID_3Step	Yes; PID controller with integrated optimization for valves	Yes; PID controller with integrated optimization for valves
<b>Counting and measuring</b>		
• High-speed counter	Yes	Yes
<b>Ambient conditions</b>		
<b>Operating temperature</b>		
• horizontal installation, min.	0 °C	0 °C
• horizontal installation, max.	60 °C; Display: 50 °C, at an operating temperature of typically 50 °C, the display is switched off	60 °C; Display: 50 °C, at an operating temperature of typically 50 °C, the display is switched off
• vertical installation, min.	0 °C	0 °C
• vertical installation, max.	40 °C; Display: 40 °C, at an operating temperature of typically 40 °C, the display is switched off	40 °C; Display: 40 °C, at an operating temperature of typically 40 °C, the display is switched off
<b>Configuration</b>		
programming		
• Programming language		
- LAD	Yes; incl. Failsafe	Yes; incl. Failsafe
- FBD	Yes; incl. Failsafe	Yes; incl. Failsafe
- STL	Yes	Yes
- SCL	Yes	Yes
- GRAPH	Yes	Yes
<b>Know-how protection</b>		
• User program protection	Yes	Yes
• Copy protection	Yes	Yes
• Block protection	Yes	Yes
<b>Access protection</b>		
• Password for display	Yes	Yes
• Protection level: Write protection	Yes	Yes
• Protection level: Read/write protection	Yes	Yes
• Protection level: Complete protection	Yes	Yes
<b>Dimensions</b>		
Width	70 mm	175 mm
Height	147 mm	147 mm
Depth	129 mm	129 mm
<b>Weights</b>		
Weight, approx.	845 g	1 988 g

Ordering data	Article No.	Article No.	
<b>CPU 1516F-3 PN/DP</b> Fail-safe CPU, 1.5 MB RAM for program, 5 MB for data, PROFINET IO IRT interface, PROFINET/PROFIBUS interface; SIMATIC memory card required	6ES7516-3FN00-0AB0	<b>PROFIBUS FC Standard Cable GP</b> Standard type with special design for fast mounting, 2-wire, shielded; Sold by the meter, max. length 1 000 m, minimum order quantity 20 m	6XV1830-0EH10
<b>CPU 1518F-4 PN/DP</b> Fail-safe CPU, 4.5 MB RAM for program, 10 MB for data, PROFINET IO IRT interface, 2 PROFINET interfaces, PROFIBUS interface; SIMATIC Memory Card required	6ES7518-4FP00-0AB0	<b>PROFIBUS FC Robust Cable</b> 2-wire, shielded; Sold by the meter, max. length 1 000 m, minimum order quantity 20 m	6XV1830-0JH10
<b>Accessories</b>		<b>PROFIBUS FC Flexible Cable</b> 2-wire, shielded; Sold by the meter, max. length 1 000 m, minimum order quantity 20 m	6XV1831-2K
<b>SIMATIC memory card</b> 4 MB 12 MB 24 MB 256 MB 2 GB	6ES7954-8LC02-0AA0 6ES7954-8LE02-0AA0 6ES7954-8LF02-0AA0 6ES7954-8LL02-0AA0 6ES7954-8LP01-0AA0	<b>PROFIBUS FC Trailing Cable</b> 2-wire, shielded; Sold by the meter, max. length 1 000 m, minimum order quantity 20 m	
<b>SIMATIC S7-1500 mounting rail</b> Fixed lengths, with grounding elements <ul style="list-style-type: none"> <li>• 160 mm</li> <li>• 482 mm</li> <li>• 530 mm</li> <li>• 830 mm</li> </ul> For cutting to length by customer, without drill holes; grounding elements must be ordered separately <ul style="list-style-type: none"> <li>• 2 000 mm</li> </ul>	6ES7590-1AB60-0AA0 6ES7590-1AE80-0AA0 6ES7590-1AF30-0AA0 6ES7590-1AJ30-0AA0  6ES7590-1BC00-0AA0	Sheath color: Petrol Sheath color: Violet	6XV1830-3EH10 6XV1831-2L
<b>PE connection element for mounting rail 2 000 mm</b> 20 units	6ES7590-5AA00-0AA0	<b>PROFIBUS FC Food Cable</b> 2-wire, shielded; Sold by the meter, max. length 1 000 m, minimum order quantity 20 m	6XV1830-0GH10
<b>Power supply</b> For supplying the backplane bus of the S7-1500 24 V DC input voltage, power 25 W 24/48/60 V DC input voltage, power 60 W 120/230 V AC input voltage, power 60 W	6ES7505-0KA00-0AB0 6ES7505-0RA00-0AB0 6ES7507-0RA00-0AB0	<b>PROFIBUS FC Ground Cable</b> 2-wire, shielded; Sold by the meter, max. length 1 000 m, minimum order quantity 20 m	6XV1830-3FH10
<b>Power connector</b> With coding element for power supply module; spare part, 10 units	6ES7590-8AA00-0AA0	<b>PROFIBUS FC FRNC Cable GP</b> 2-wire, shielded, flame-retardant, with copolymer outer sheath FRNC; Sold by the meter, max. length 1 000 m, minimum order quantity 20 m	6XV1830-0LH10
<b>Load current supply</b> 24 V DC/3 A 24 V DC/8 A	6EP1332-4BA00 6EP1333-4BA00	<b>PROFIBUS FastConnect Stripping Tool</b> Preadjusted stripping tool for fast stripping of PROFIBUS FastConnect bus cables	6GK1905-6AA00
<b>Power supply connector</b> Spare part; for connecting the 24 V DC supply voltage <ul style="list-style-type: none"> <li>• with push-in terminals</li> </ul>	6ES7193-4JB00-0AA0	<b>IE FC RJ45 plugs</b> RJ45 plug connector for Industrial Ethernet with a rugged metal enclosure and integrated insulation displacement contacts for connecting Industrial Ethernet FC installation cables	
<b>PROFIBUS FastConnect bus connector RS485 with 90° cable outlet</b> with insulation displacement, max. transmission rate 12 Mbps without programming device interface, grounding via control cabinet contact surface; 1 unit with programming device interface, grounding via control cabinet contact surface; 1 unit	6ES7972-0BA70-0XA0 6ES7972-0BB70-0XA0	<b>IE FC RJ45 Plug 180</b> 180° cable outlet 1 unit 10 units 50 units	6GK1901-1BB10-2AA0 6GK1901-1BB10-2AB0 6GK1901-1BB10-2AE0
		<b>IE FC TP Standard Cable GP 2x2</b> 4-core, shielded TP installation cable for connection to IE FC Outlet RJ45/IE FC RJ45 Plug; PROFINET-compatible; with UL approval; Sold by the meter, max. length 1 000 m, minimum order quantity 20 m	6XV1840-2AH10

## PROFINET/Industrial Ethernet

### Controllers / Modular controllers / SIMATIC S7-1500

#### Fail-safe CPUs

Ordering data	Article No.	Article No.
<b>IE FC TP Trailing Cable 2 x 2 (Type C)</b> 4-core, shielded TP installation cable for connection to IE FC Outlet RJ45/ IE FC RJ45 Plug 180/90 for cable carrier use; PROFINET-compatible; with UL approval; Sold by the meter, max. length 1 000 m, minimum order quantity 20 m	<b>6XV1840-3AH10</b>	
<b>IE FC TP Marine Cable 2 x 2 (Type B)</b> 4-core, shielded TP installation cable for connection to IE FC Outlet RJ45/ IE FC RJ45 Plug 180/90 marine certified, Sold by the meter, max. length 1 000 m, minimum order quantity 20 m	<b>6XV1840-4AH10</b>	
<b>IE FC Stripping Tool</b> Preadjusted stripping tool for fast stripping of Industrial Ethernet FC cables	<b>6GK1901-1GA00</b>	
<b>Display</b> for CPU 1516-3 PN/DP; spare part	<b>6ES7591-1BA00-0AA0</b>	
		<b>STEP 7 Professional V13</b> <i>Target system:</i> SIMATIC S7-1200, S7-1500, S7-300, S7-400, WinAC <i>Requirement:</i> Windows 7 Professional SP1 (64-bit), Windows 7 Enterprise SP1 (64-bit), Windows 7 Ultimate SP1 (64 bit), Windows 8.1 (64-bit), Windows 8.1 Professional (64-bit), Windows 8.1 Enterprise (64-bit), Windows Server 2008 R2 StdE (full installation), Windows Server 2012 StdE (full installation) <i>Type of delivery:</i> German, English, Chinese, Italian, French, Spanish  STEP 7 Professional V13, Floating License  STEP 7 Professional V13, Floating License, Software download incl. License Key <sup>1)</sup>  E-mail address required for delivery
		<b>6ES7822-1AA03-0YA5</b>  <b>6ES7822-1AE03-0YA5</b>
		<b>STEP 7 Safety Advanced V13</b> <i>Task:</i> Engineering tool for configuring fail-safe user programs for SIMATIC S7-1500F, S7-300F, S7-400F, WinAC RTX F, ET200SP, ET 200S, ET 200M, ET 200iSP, ET 200pro, ET 200eco <i>Requirement:</i> STEP 7 Professional V13  Floating License for 1 user  Floating License for 1 user, License Key download without software and documentation <sup>1)</sup> ; E-mail address required for delivery
		<b>6ES7833-1FA13-0YA5</b>  <b>6ES7833-1FA13-0YH5</b>

<sup>1)</sup> For up-to-date information and download availability, see: <http://www.siemens.com/tia-online-software-delivery>

**Overview CPU 315-2 PN/DP**

- The CPU with mid-range program memory and quantity frameworks
- High processing power in binary and floating-point arithmetic
- Used as central controller in production lines with central and distributed I/O
- PROFINET interface with 2-port switch
- PROFINET I/O Controller for operating distributed I/O on PROFINET
- PROFINET I-Device for connecting the CPU as intelligent PROFINET device under a SIMATIC or third-party PROFINET I/O Controller
- Component Based Automation (CBA) on PROFINET
- PROFINET proxy for intelligent devices on PROFIBUS DP in Component Based Automation (CBA)
- Integrated web server with the option of creating user-defined web pages
- Combined MPI/PROFIBUS DP master/slave interface
- Isochronous mode on PROFIBUS and PROFINET

*SIMATIC Micro Memory Card required for operation of CPU.*

**Overview CPU 317-2 PN/DP**

- The CPU with a large program memory and quantity framework for demanding applications
- For cross-industry automation tasks in series machine, special machine and plant construction
- Used as central controller in production lines with central and distributed I/O
- High processing power in binary and floating-point arithmetic
- PROFINET interface with 2-port switch
- PROFINET I/O Controller for operating distributed I/O on PROFINET
- PROFINET I-Device for connecting the CPU as intelligent PROFINET device under a SIMATIC or third-party PROFINET I/O Controller
- Distributed intelligence in Component Based Automation (CBA) on PROFINET
- PROFINET proxy for intelligent devices on PROFIBUS DP in Component Based Automation (CBA)
- Integrated web server with the option of creating user-defined web pages
- Combined MPI/PROFIBUS DP master/slave interface
- Isochronous mode on PROFIBUS and PROFINET
- Optionally supports the use of SIMATIC engineering tools

*SIMATIC Micro Memory Card required for operation of CPU.*

## PROFINET/Industrial Ethernet

### Controllers / Modular controllers / SIMATIC S7-300

#### Standard CPUs

#### Overview CPU 319-3 PN/DP



- The CPU with high command processing performance, large program memory and quantity framework for demanding applications
- For cross-industry automation tasks in series machine, special machine and plant construction
- Used as central controller in production lines with central and distributed I/O on PROFIBUS and PROFINET
- PROFINET I/O controller for operating distributed I/O on PROFINET
- PROFINET I-Device for connecting the CPU as an intelligent PROFINET device under a SIMATIC or non-Siemens PROFINET I/O controller
- PROFINET interface with 2-port switch
- Isochronous mode on PROFIBUS or PROFINET
- Integrated web server with the option of creating user-defined web pages
- Distributed intelligence in Component Based Automation (CBA) on PROFINET
- PROFINET proxy for intelligent devices on PROFIBUS DP in Component Based Automation (CBA)
- Optionally supports the use of SIMATIC engineering tools

*SIMATIC Micro Memory Card required for operation of the CPU.*

#### Technical specifications

	6ES7315-2EH14-0AB0 CPU 315-2 PN/DP	6ES7317-2EK14-0AB0 CPU 317-2 PN/DP	6ES7318-3EL01-0AB0 CPU 319-3 PN/DP
<b>General information</b>			
Engineering with			
• Programming package	STEP7 V 5.5 or higher	STEP7 V 5.5 or higher	STEP7 V 5.5 or higher
<b>Supply voltage</b>			
24 V DC	Yes	Yes	Yes
<b>Power losses</b>			
Power loss, typ.	4.65 W	4.65 W	14 W
<b>Memory</b>			
Work memory			
• integrated	384 kbyte	1 024 kbyte	2 048 kbyte
• Size of retentive memory for retentive data blocks	128 kbyte	256 kbyte	700 kbyte
Load memory			
• pluggable (MMC), max.	8 Mbyte	8 Mbyte	8 Mbyte
<b>CPU processing times</b>			
for bit operations, typ.	0.05 µs	0.025 µs	0.004 µs
for word operations, typ.	0.09 µs	0.03 µs	0.01 µs
for fixed point arithmetic, typ.	0.12 µs	0.04 µs	0.01 µs
for floating point arithmetic, typ.	0.45 µs	0.16 µs	0.04 µs
<b>Counters, timers and their retentivity</b>			
S7 counter			
• Number	256	512	2 048
IEC counter			
• present	Yes	Yes	Yes
S7 times			
• Number	256	512	2 048
IEC timer			
• present	Yes	Yes	Yes
<b>Data areas and their retentivity</b>			
Flag			
• Number, max.	2 048 byte	4 096 byte	8 192 byte

**Technical specifications** (continued)

	<b>6ES7315-2EH14-0AB0 CPU 315-2 PN/DP</b>	<b>6ES7317-2EK14-0AB0 CPU 317-2 PN/DP</b>	<b>6ES7318-3EL01-0AB0 CPU 319-3 PN/DP</b>
<b>Address area</b>			
I/O address area			
• Inputs	2 048 byte	8 192 byte	8 192 byte
• Outputs	2 048 byte	8 192 byte	8 192 byte
<b>Process image</b>			
• Inputs, adjustable	2 048 byte	8 192 byte	8 192 byte
• Outputs, adjustable	2 048 byte	8 192 byte	8 192 byte
<b>Time of day</b>			
Clock			
• Hardware clock (real-time clock)	Yes	Yes	Yes
Operating hours counter			
• Number	1	4	4
<b>1st interface</b>			
Interface type	Integrated RS 485 interface	Integrated RS 485 interface	Integrated RS 485 interface
Physics	RS 485	RS 485	RS 485
Functionality			
• MPI	Yes	Yes	Yes
• DP master	Yes	Yes	Yes
• DP slave	Yes	Yes	Yes; A DP slave at both interfaces simultaneously is not possible
• Point-to-point connection	No	No	No
DP master			
• Number of DP slaves, max.	124	124	124
<b>2nd interface</b>			
Interface type	PROFINET	PROFINET	Integrated RS 485 interface
Physics	Ethernet RJ45	Ethernet RJ45	RS 485
Number of ports	2	2	
Functionality			
• MPI	No	No	No
• DP master	No	No	Yes
• DP slave	No	No	Yes; A DP slave at both interfaces simultaneously is not possible
• PROFINET IO Controller	Yes; Also simultaneously with IO-Device functionality	Yes; Also simultaneously with IO-Device functionality	No
• PROFINET IO Device	Yes; Also simultaneously with IO Controller functionality	Yes; Also simultaneously with IO Controller functionality	No
• PROFINET CBA	Yes	Yes	No
DP master			
• Number of DP slaves, max.			124
PROFINET IO Controller			
• Max. number of connectable IO devices for RT	128	128	
• Number of IO devices with IRT and the option "high flexibility"	128	128	
• Number of IO Devices with IRT and the option "high performance", max.	64	64	
<b>3rd interface</b>			
Interface type			PROFINET
Physics			Ethernet RJ45
Number of ports			2
Functionality			
• MPI			No
• DP master			No
• DP slave			No
• PROFINET IO Controller			Yes; Also simultaneously with I-Device functionality
• PROFINET IO Device			Yes; Also simultaneously with IO Controller functionality
• PROFINET CBA			Yes

## PROFINET/Industrial Ethernet

### Controllers / Modular controllers / SIMATIC S7-300

#### Standard CPUs

#### Technical specifications (continued)

	6ES7315-2EH14-0AB0 CPU 315-2 PN/DP	6ES7317-2EK14-0AB0 CPU 317-2 PN/DP	6ES7318-3EL01-0AB0 CPU 319-3 PN/DP
PROFINET IO Controller			
• Max. number of connectable IO devices for RT			256
• Number of IO devices with IRT and the option "high flexibility"			256
• Number of IO Devices with IRT and the option "high performance", max.			64
<b>Isochronous mode</b>			
Isochronous operation (application synchronized up to terminal)	Yes; Via PROFIBUS DP or PROFINET interface	Yes; Via PROFIBUS DP or PROFINET interface	Yes; Via 2nd PROFIBUS DP or PROFINET interface
<b>Communication functions</b>			
PG/OP communication	Yes	Yes	Yes
Data record routing	Yes	Yes	Yes
Global data communication			
• supported	Yes	Yes	Yes
S7 basic communication			
• supported	Yes	Yes	Yes
S7 communication			
• supported	Yes	Yes	Yes
S5-compatible communication			
• supported	Yes; Via CP and loadable FC	Yes; Via CP and loadable FC	Yes; Via CP and loadable FC
Open IE communication			
• TCP/IP	Yes; Via integrated PROFINET interface and loadable FBs	Yes; Via integrated PROFINET interface and loadable FBs	Yes; Via integrated PROFINET interface and loadable FBs
- Number of connections, max.	8	16	32
• ISO-on-TCP (RFC1006)	Yes; Via integrated PROFINET interface and loadable FBs	Yes; Via integrated PROFINET interface and loadable FBs	Yes; Via integrated PROFINET interface and loadable FBs
- Number of connections, max.	8	16	32
• UDP	Yes; Via integrated PROFINET interface and loadable FBs	Yes; Via integrated PROFINET interface and loadable FBs	Yes; Via integrated PROFINET interface and loadable FBs
- Number of connections, max.	8	16	32
Web server			
• supported	Yes	Yes	Yes
Number of connections			
• overall	16	32	32
<b>Ambient conditions</b>			
Operating temperature			
• min.	0 °C	0 °C	0 °C
• max.	60 °C	60 °C	60 °C
<b>Configuration</b>			
Programming			
• Programming language			
- LAD	Yes	Yes	Yes
- FBD	Yes	Yes	Yes
- STL	Yes	Yes	Yes
- SCL	Yes	Yes	Yes
- CFC	Yes	Yes	Yes
- GRAPH	Yes	Yes	Yes
- HiGraph®	Yes	Yes	Yes
Know-how protection			
• User program protection/password protection	Yes	Yes	Yes
• Block encryption	Yes; With S7 block Privacy	Yes; With S7 block Privacy	Yes; With S7 block Privacy
<b>Dimensions</b>			
Width	40 mm	40 mm	120 mm
Height	125 mm	125 mm	125 mm
Depth	130 mm	130 mm	130 mm
<b>Weights</b>			
Weight, approx.	340 g	340 g	1 250 g



Ordering data	Article No.	Article No.	
<b>CPU 315-2 PN/DP</b> 384 KB main memory, 24 V DC power supply, combined MPI/PROFIBUS DP master/slave interface, Ethernet/PROFINET interface with 2-port switch; MMC required	<b>6ES7315-2EH14-0AB0</b>	<b>SIMATIC Manual Collection            update service for 1 year</b> Current "Manual Collection" DVD and the three subsequent updates	<b>6ES7998-8XC01-8YE2</b>
<b>CPU 317-2 PN/DP</b> 1 MB main memory, 24 V DC power supply, combined MPI/PROFIBUS DP master/slave interface, Ethernet/PROFINET interface with 2-port switch; MMC required	<b>6ES7317-2EK14-0AB0</b>	<b>Power supply connector</b> 10 units, spare part	<b>6ES7391-1AA00-0AA0</b>
<b>CPU 319-3 PN/DP</b> Main memory 2 MB, power supply 24 V DC, combined MPI/PROFIBUS DP master/slave interface, PROFIBUS DP master/slave interface, Ethernet/PROFINET interface with 2-port switch; MMC required	<b>6ES7318-3EL01-0AB0</b>	<b>SIMATIC S7 training case</b> With mounting components for mounting S7-200 and S7-300	<b>6ES7910-3AA00-0XA0</b>
<b>SIMATIC Micro Memory Card</b> 64 KB 128 KB 512 KB 2 MB 4 MB 8 MB	<b>6ES7953-8LF30-0AA0</b> <b>6ES7953-8LG30-0AA0</b> <b>6ES7953-8LJ30-0AA0</b> <b>6ES7953-8LL31-0AA0</b> <b>6ES7953-8LM31-0AA0</b> <b>6ES7953-8LP31-0AA0</b>	<b>USB A2 PC adapter</b> for connecting a PG/PC or Notebook to PROFIBUS or MPI; USB cable included in scope of delivery	<b>6GK1571-0BA00-0AA0</b>
<b>MPI cable</b> for connection of SIMATIC S7 and PG via MPI; 5 m in length	<b>6ES7901-0BF00-0AA0</b>	<b>PROFIBUS bus components</b> <b>PROFIBUS DP bus connector            RS 485</b> <ul style="list-style-type: none"> <li>with 90° cable outlet, max. transfer              rate 12 Mbit/s             <ul style="list-style-type: none"> <li>without PG interface</li> <li>with PG interface</li> </ul> </li> <li>with 90° cable outlet for              FastConnect connection system,              max. transfer rate 12 Mbit/s             <ul style="list-style-type: none"> <li>without PG interface, 1 unit</li> <li>without PG interface, 100 units</li> <li>with PG interface, 1 unit</li> <li>with PG interface, 100 units</li> </ul> </li> <li>with axial cable outlet for              SIMATIC OP, for connecting to              PPI, MPI, PROFIBUS           </li> </ul>	<b>6ES7972-0BA12-0XA0</b> <b>6ES7972-0BB12-0XA0</b>  <b>6ES7972-0BA52-0XA0</b> <b>6ES7972-0BA52-0XB0</b> <b>6ES7972-0BB52-0XA0</b> <b>6ES7972-0BB52-0XB0</b> <b>6GK1500-0EA02</b>
<b>Slot number plates</b>	<b>6ES7912-0AA00-0AA0</b>	<b>PROFIBUS FastConnect            bus cable</b> Standard type with special design for quick mounting, 2-core, shielded, sold by the meter, max. delivery unit 1 000 m, minimum ordering quantity 20 m	<b>6XV1830-0EH10</b>
<b>S7-300 manual</b> Design, CPU data, module data, instruction list German English	<b>6ES7398-8FA10-8AA0</b> <b>6ES7398-8FA10-8BA0</b>	<b>RS 485 repeater for PROFIBUS</b> Transmission rate up to 12 Mbit/s; 24 V DC; IP20 enclosure	<b>6ES7972-0AA02-0XA0</b>
<b>SIMATIC Manual Collection</b> Electronic manuals on DVD, multilingual: LOGO!, SIMADYN, SIMATIC bus components, SIMATIC C7, SIMATIC distributed I/O, SIMATIC HMI, SIMATIC Sensors, SIMATIC NET, SIMATIC PC Based Automation, SIMATIC PCS 7, SIMATIC PG/PC, SIMATIC S7, SIMATIC Software, SIMATIC TDC	<b>6ES7998-8XC01-8YE0</b>		

**PROFINET/Industrial Ethernet****Controllers / Modular controllers / SIMATIC S7-300****Standard CPUs****Ordering data****Article No.****Article No.***PROFINET bus components***IE FC TP standard cable GP 2x2****6XV1840-2AH10**

4-core, shielded TP installation cable for connection to IE FC Outlet RJ45/IE FC RJ45 Plug; PROFINET-compatible; with UL approval; Sold by the meter

**FO Standard Cable GP (50/125)****6XV1873-2A**

Standard cable, splittable, UL approval, sold by the meter

**SCALANCE X204-2 Industrial Ethernet Switch****6GK5204-2BB10-2AA3**

Industrial Ethernet Switches with integral SNMP access, Web diagnostics, copper cable diagnostics and PROFINET diagnostics for configuring line, star and ring topologies; four 10/100 Mbit/s RJ45 ports and two FO ports

**Compact Switch Module CSM 377****6GK7377-1AA00-0AA0**

Unmanaged switch for connecting a SIMATIC S7-300, ET 200M and up to three other stations to Industrial Ethernet with 10/100 Mbit/s; 4 x RJ45 ports; external 24 V DC power supply, LED diagnostics, S7-300 module incl. electronic manual on CD-ROM

**IE FC RJ45 plugs**

RJ45 plug connector for Industrial Ethernet with a rugged metal enclosure and integrated insulation displacement contacts for connecting Industrial Ethernet FC installation cables

**IE FC RJ45 plug 145**

145° cable outlet

1 unit

**6GK1901-1BB30-0AA0**

10 units

**6GK1901-1BB30-0AB0**

50 units

**6GK1901-1BB30-0AE0****IE FC RJ45 plug 180**

180° cable outlet

1 unit

**6GK1901-1BB10-2AA0**

10 units

**6GK1901-1BB10-2AB0**

50 units

**6GK1901-1BB10-2AE0**

**Overview CPU 314C-2 PN/DP**

- The compact CPU with integral digital and analog inputs/outputs and technological functions
- High processing performance in binary and floating-point arithmetic
- For connecting distributed I/O via PROFIBUS and PROFINET
- Combined MPI/PROFIBUS DP master/slave interface
- PROFINET interface with 2-port switch
- PROFINET IO Controller for operating distributed I/O on PROFINET
- PROFINET I-Device for connecting the CPU as intelligent PROFINET device under a SIMATIC or third-party PROFINET I/O controller
- Component based Automation (CBA) on PROFINET
- PROFINET proxy for intelligent devices on PROFIBUS DP in Component based Automation (CBA)
- Integrated Web server with the option of creating user-defined web pages
- Isochronous mode on PROFINET

*SIMATIC Micro Memory Card required for operation of CPU.*

**Technical specifications**

CPU 314C-2 PN/DP	6ES7314-6EH04-0AB0
<b>General information</b>	
Hardware product version	01
Firmware version	V3.3
<b>Supply voltage</b>	
24 V DC	Yes
<b>Power losses</b>	
Power loss, typ.	14 W
<b>Memory</b>	
Work memory	
• integrated	192 kbyte
• expandable	No
• Size of retentive memory for retentive data blocks	64 kbyte
Load memory	
• pluggable (MMC), max.	8 Mbyte
<b>CPU processing times</b>	
for bit operations, typ.	0.06 $\mu$ s
for word operations, typ.	0.12 $\mu$ s
for fixed point arithmetic, typ.	0.16 $\mu$ s
for floating point arithmetic, typ.	0.59 $\mu$ s
<b>Counters, timers and their retentivity</b>	
S7 counter	
• Number	256
IEC counter	
• present	Yes
S7 times	
• Number	256
IEC timer	
• present	Yes
<b>Data areas and their retentivity</b>	
Flag	
• Number, max.	256 byte
<b>Address area</b>	
I/O address area	
• Inputs	2 048 byte
• Outputs	2 048 byte
Process image	
• Inputs, adjustable	2 048 byte
• Outputs, adjustable	2 048 byte

CPU 314C-2 PN/DP	6ES7314-6EH04-0AB0
<b>Time of day</b>	
Clock	
• Hardware clock (real-time clock)	Yes
Operating hours counter	
• Number	1
<b>Digital inputs</b>	
integrated channels (DI)	24
<b>Digital outputs</b>	
integrated channels (DO)	16
<b>Analog inputs</b>	
Integrated channels (AI)	5; 4 x current/voltage, 1 x resistance
Input ranges	
• Voltage	Yes; $\pm 10$ V / 100 k $\Omega$ ; 0 V to 10 V / 100 k $\Omega$
• Current	Yes; $\pm 20$ mA / 100 $\Omega$ ; 0 mA to 20 mA / 100 $\Omega$ ; 4 mA to 20 mA / 100 $\Omega$
• Resistance thermometer	Yes; Pt 100 / 10 M $\Omega$
• Resistance	Yes; 0 $\Omega$ to 600 $\Omega$ / 10 M $\Omega$
<b>Analog outputs</b>	
Integrated channels (AO)	2
Output ranges, voltage	
• 0 to 10 V	Yes
• -10 to +10 V	Yes
Output ranges, current	
• 0 to 20 mA	Yes
• -20 to +20 mA	Yes
• 4 to 20 mA	Yes
<b>1st interface</b>	
Interface type	Integrated RS 485 interface
Physics	RS 485
Functionality	
• MPI	Yes
• DP master	Yes
• DP slave	Yes
• Point-to-point connection	No
DP master	
• Number of DP slaves, max.	124

# PROFINET/Industrial Ethernet

## Controllers / Modular controllers / SIMATIC S7-300

### Compact CPUs

#### Technical specifications (continued)

CPU 314C-2 PN/DP	6ES7314-6EH04-0AB0
<b>2nd interface</b>	
Interface type	PROFINET
Physics	Ethernet RJ45
Number of ports	2
Functionality	
• MPI	No
• DP master	No
• DP slave	No
• PROFINET IO Controller	Yes; Also simultaneously with IO-Device functionality
• PROFINET IO Device	Yes; Also simultaneously with IO Controller functionality
• PROFINET CBA	Yes
PROFINET IO Controller	
• Number of connectable IO devices, max.	128
• Max. number of connectable IO devices for RT	128
• Number of IO devices with IRT and the option "high flexibility"	128
• Number of IO Devices with IRT and the option "high performance", max.	64
<b>Isochronous mode</b>	
Isochronous operation (application synchronized up to terminal)	Yes; For PROFINET only
<b>Communication functions</b>	
PG/OP communication	Yes
Data record routing	Yes
Global data communication	
• supported	Yes
S7 basic communication	
• supported	Yes
S7 communication	
• supported	Yes
S5-compatible communication	
• supported	Yes; Via CP and loadable FC
Open IE communication	
• TCP/IP	Yes; Via integrated PROFINET interface and loadable FBs
- Number of connections, max.	8
• ISO-on-TCP (RFC1006)	Yes; Via integrated PROFINET interface and loadable FBs
- Number of connections, max.	8
• UDP	Yes; Via integrated PROFINET interface and loadable FBs
- Number of connections, max.	8
Web server	
• supported	Yes
Number of connections	
• overall	12

CPU 314C-2 PN/DP	6ES7314-6EH04-0AB0
<b>Integrated Functions</b>	
Number of counters	4; See "Technological Functions" manual
Counter frequency (counter) max.	60 kHz
Frequency measurement	Yes
Number of frequency meters	4; up to 60 kHz (see "Technological Functions" manual)
Controlled positioning	Yes
Integrated function blocks (closed-loop control)	Yes; PID controller (see "Technological Functions" manual)
PID controller	Yes
Number of pulse outputs	4; Pulse width modulation up to 2.5 kHz (see "Technological Functions" Manual)
Limit frequency (pulse)	2.5 kHz
<b>Ambient conditions</b>	
Operating temperature	
• Min.	0 °C
• max.	60 °C
<b>Configuration</b>	
Configuration software	
• STEP 7 programming	Yes; V5.5 or higher
- LAD	Yes
- FBD	Yes
- STL	Yes
- SCL	Yes
- CFC	Yes
- GRAPH	Yes
- HiGraph®	Yes
Know-how protection	
• User program protection/password protection	Yes
• Block encryption	Yes; With S7 block Privacy
<b>Dimensions</b>	
Width	120 mm
Height	125 mm
Depth	130 mm
<b>Weights</b>	
Weight, approx.	730 g

#### Ordering data

CPU 314C-2 PN/DP	6ES7314-6EH04-0AB0
Compact CPU, 192 KB main memory, 24 V DC power supply, 24 DI/16 DO/4 AI/2 AO integrated, integrated functions, MPI; PROFIBUS DP master/slave interface; PROFINET IO Controller/I-Device interface, MMC is required	

SIMATIC Micro Memory Card	Article No.
64 KB	6ES7953-8LF30-0AA0
128 KB	6ES7953-8LG30-0AA0
512 KB	6ES7953-8LJ30-0AA0
2 MB	6ES7953-8LL31-0AA0
4 MB	6ES7953-8LM31-0AA0
8 MB	6ES7953-8LP31-0AA0
<b>MPI cable</b>	6ES7901-0BF00-0AA0
for connection of SIMATIC S7 and PG via MPI; 5 m in length	

Ordering data	Article No.	Article No.
<b>Front connector (1 unit)</b> For compact CPUs 40-pin, with screw contacts <ul style="list-style-type: none"> <li>• 1 unit</li> <li>• 100 units</li> </ul> 40-pin, with spring-loaded contacts <ul style="list-style-type: none"> <li>• 1 unit</li> <li>• 100 units</li> </ul>	<b>6ES7392-1AM00-0AA0</b> <b>6ES7392-1AM00-1AB0</b>  <b>6ES7392-1BM01-0AA0</b> <b>6ES7392-1BM01-1AB0</b>	<b>PROFIBUS DP bus connector RS 485</b> <ul style="list-style-type: none"> <li>• with 90° cable outlet, max. transfer rate 12 Mbit/s               <ul style="list-style-type: none"> <li>- without PG interface</li> <li>- with PG interface</li> </ul> </li> <li>• with 90° cable outlet for FastConnect connection system, max. transfer rate 12 Mbit/s               <ul style="list-style-type: none"> <li>- without PG interface, 1 unit</li> <li>- without PG interface, 100 units</li> <li>- with PG interface, 1 unit</li> <li>- with PG interface, 100 units</li> </ul> </li> <li>• with axial cable outlet for SIMATIC OP, for connecting to PPI, MPI, PROFIBUS</li> </ul>
<b>SIMATIC TOP connect</b>	see page ; for information about which components can be used for the respective module, see A&D Mall or Catalog KT 10.2	<b>6ES7972-0BA12-0XA0</b> <b>6ES7972-0BB12-0XA0</b>  <b>6ES7972-0BA52-0XA0</b> <b>6ES7972-0BA52-0XB0</b> <b>6ES7972-0BB52-0XA0</b> <b>6ES7972-0BB52-0XB0</b> <b>6GK1500-0EA02</b>
<b>Front door, elevated design</b> For compact CPUs; for connecting 1.3 mm <sup>2</sup> /16 AWG wires; wiring diagram and labels in petrol	<b>6ES7328-7AA20-0AA0</b>	<b>PROFIBUS Fast Connect bus cable</b> Standard type with special design for quick mounting, 2-core, shielded, sold by the meter, max. delivery unit 1 000 m, minimum ordering quantity 20 m
<b>Slot number plates</b>	<b>6ES7912-0AA00-0AA0</b>	<b>RS 485 repeater for PROFIBUS</b> Transmission rate up to 12 Mbit/s; 24 V DC; IP20 enclosure
<b>S7-300 manual</b> Design, CPU data, module data, instruction list German English	<b>6ES7398-8FA10-8AA0</b> <b>6ES7398-8FA10-8BA0</b>	<b>6XV1830-0EH10</b>  <b>6ES7972-0AA02-0XA0</b>
<b>SIMATIC Manual Collection</b> Electronic manuals on DVD, multilingual: LOGO!, SIMADYN, SIMATIC bus components, SIMATIC C7, SIMATIC distributed I/O, SIMATIC HMI, SIMATIC Sensors, SIMATIC NET, SIMATIC PC Based Automation, SIMATIC PCS 7, SIMATIC PG/PC, SIMATIC S7, SIMATIC software, SIMATIC TDC	<b>6ES7998-8XC01-8YE0</b>	<b>PROFINET bus components</b>
<b>SIMATIC Manual Collection update service for 1 year</b> Current "Manual Collection" DVD and the three subsequent updates	<b>6ES7998-8XC01-8YE2</b>	<b>IE FC TP Standard Cable GP 2x2</b> 4-core, shielded TP installation cable for connection to IE FC Outlet RJ45/IE FC RJ45 Plug; PROFINET-compatible; with UL approval; Sold by the meter
<b>Power supply connector</b> 10 units, spare part	<b>6ES7391-1AA00-0AA0</b>	<b>FO standard cable GP (50/125)</b> Standard cable, splittable, UL approval, sold by the meter
<b>Labeling strips</b> 10 units, spare part	<b>6ES7392-2XX00-0AA0</b>	<b>SCALANCE X204-2 Industrial Ethernet switch</b> Industrial Ethernet Switches with integral SNMP access, Web diagnostics, copper cable diagnostics and PROFINET diagnostics for configuring line, star and ring topologies; four 10/100 Mbit/s RJ45 ports and two FO ports
<b>Label cover</b> 10 units, spare part	<b>6ES7392-2XY00-0AA0</b>	<b>Compact Switch Module CSM 377</b> Unmanaged switch for connecting a SIMATIC S7-300, ET 200M and up to three other stations to Industrial Ethernet with 10/100 Mbit/s; 4 x RJ45 ports; external 24 V DC power supply, LED diagnostics, S7-300 module incl. electronic manual on CD-ROM
<b>Labeling sheets for machine inscription</b> for modules with 40-pin front connector, DIN A4, for printing with laser printer; 10 units Petrol Light-beige Yellow Red	<b>6ES7392-2AX10-0AA0</b> <b>6ES7392-2BX10-0AA0</b> <b>6ES7392-2CX10-0AA0</b> <b>6ES7392-2DX10-0AA0</b>	<b>IE FC RJ45 Plugs</b> RJ45 plug connector for Industrial Ethernet with a rugged metal enclosure and integrated insulation displacement contacts for connecting Industrial Ethernet FC installation cables
<b>USB A2 PC adapter</b> for connecting a PG/PC or Notebook to PROFIBUS or MPI; USB cable included in scope of delivery	<b>6GK1571-0BA00-0AA0</b>	<b>IE FC RJ45 plug 180</b> 180° cable outlet 1 unit 10 units 50 units
		<b>6GK1901-1BB10-2AA0</b> <b>6GK1901-1BB10-2AB0</b> <b>6GK1901-1BB10-2AE0</b>

## PROFINET/Industrial Ethernet

### Controllers / Modular controllers / SIMATIC S7-300

#### Fail-safe CPUs

##### Overview CPU 315F-2 PN/DP



- Based on CPU 315-2 PN/DP
- The CPU with medium-sized program memory and quantity structures for setting up a fail-safe automation system in plants with increased safety requirements
- Complies with safety requirements to SIL 3 acc. to IEC 61508 and PL e acc. to ISO 13849.1
- Fail-safe I/O modules in distributed stations can be connected through the integrated PROFINET interface (PROFIsafe) and/or through the integrated PROFIBUS DP interface (PROFIsafe);
- Fail-safe I/O modules of the ET 200M range can also be centrally connected
- Central and distributed use of standard modules for non safety-relevant applications
- Component based Automation (CBA) on PROFINET
- PROFINET IO Controller for operating distributed I/O on PROFINET
- PROFINET interface with 2-port switch
- PROFINET proxy for intelligent devices on PROFIBUS DP in Component Based Automation (CBA)

*SIMATIC Micro Memory Card required for operation of CPU.*

##### Overview CPU 317F-2 PN/DP



- Based on CPU 317-2 PN/DP
- The fail-safe CPU with a large program memory and quantity framework for demanding applications; for setting up a fail-safe automation system in plants with increased safety requirements.

- Complies with safety requirements to SIL 3 acc. to IEC 61508 and PL e acc. to ISO 13849.1
- Fail-safe I/O modules in distributed stations can be connected through the integrated PROFINET interface (PROFIsafe) and/or through the integrated PROFIBUS DP interface (PROFIsafe)
- Fail-safe I/O modules of the ET 200M range can also be centrally connected
- Central and distributed use of standard modules for non safety-relevant applications
- Component based Automation (CBA) on PROFINET
- PROFINET IO Controller for operating distributed I/O on PROFINET
- PROFINET interface with 2-port switch
- PROFINET proxy for intelligent devices on PROFIBUS DP in Component Based Automation (CBA)

*SIMATIC Micro Memory Card required for operation of CPU.*

##### Overview CPU 319F-3 PN/DP



- The fail-safe CPU with high-performance command processing, large program memory and large quantity structure for demanding applications
- For constructing a fail-safe automation system for plants with increased safety requirements
- Complies with safety requirements to SIL 3 acc. to IEC 61508 and PL e acc. to 13849.1
- Fail-safe I/O modules can be connected decentralized over the integrated PROFINET interface (PROFIsafe) and/or over the integrated PROFIBUS DP interface (PROFIsafe);
- Fail-safe I/O modules of ET 200M can also be connected centrally
- Standard modules for non-safety-related applications can be operated centrally and decentralized
- Distributed intelligence in Component Based Automation (CBA) on PROFINET
- Isochronous mode on PROFIBUS
- PROFINET proxy for intelligent devices on PROFIBUS DP in Component based Automation (CBA)

*SIMATIC Micro Memory Card required for operation of CPU.*

**Technical specifications**

	<b>6ES7315-2FJ14-0AB0</b> <b>CPU 315F-2 PN/DP</b>	<b>6ES7317-2FK14-0AB0</b> <b>CPU 317F-2 PN/DP</b>	<b>6ES7318-3FL01-0AB0</b> <b>CPU 319F-3 PN/DP</b>
<b>General information</b>			
Engineering with • Programming package	STEP 7 V 5.5 or higher, Distributed Safety V 5.4 SP4	STEP 7 V 5.5 or higher, Distributed Safety V 5.4 SP4	STEP 7 V 5.5 or higher, Distributed Safety V 5.4 SP4
<b>Supply voltage</b>			
24 V DC	Yes	Yes	Yes
<b>Power losses</b>			
Power loss, typ.	4.65 W	4.65 W	14 W
<b>Memory</b>			
Work memory • integrated	512 kbyte	1 536 kbyte	2 560 kbyte
• Size of retentive memory for retentive data blocks	128 kbyte	256 kbyte	700 kbyte
Load memory • pluggable (MMC), max.	8 Mbyte	8 Mbyte	8 Mbyte
<b>CPU processing times</b>			
for bit operations, typ.	0.05 µs	0.025 µs	0.004 µs
for word operations, typ.	0.09 µs	0.03 µs	0.01 µs
for fixed point arithmetic, typ.	0.12 µs	0.04 µs	0.01 µs
for floating point arithmetic, typ.	0.45 µs	0.16 µs	0.04 µs
<b>Counters, timers and their retentivity</b>			
S7 counter • Number	256	512	2 048
IEC counter • present	Yes	Yes	Yes
S7 timer • Number	256	512	2 048
IEC timer • present	Yes	Yes	Yes
<b>Data areas and their retentivity</b>			
Flag • Number, max.	2 048 byte	4 096 byte	8 192 byte
<b>Address area</b>			
I/O address area • Inputs	2 048 byte	8 192 byte	8 192 byte
• Outputs	2 048 byte	8 192 byte	8 192 byte
Process image • Inputs, adjustable	2 048 byte	8 192 byte	8 192 byte
• Outputs, adjustable	2 048 byte	8 192 byte	8 192 byte
<b>Time of day</b>			
Clock • Hardware clock (real-time clock)	Yes	Yes	Yes
Operating hours counter • Number	1	4	4
<b>1st interface</b>			
Interface type	Integrated RS 485 interface	Integrated RS 485 interface	Integrated RS 485 interface
Physics	RS 485	RS 485	RS 485
Functionality • MPI	Yes	Yes	Yes
• DP master	Yes	Yes	Yes
• DP slave	Yes	Yes	Yes; A DP slave at both interfaces simultaneously is not possible
• Point-to-point connection	No	No	No
DP master • Number of DP slaves, max.	124	124	124

## PROFINET/Industrial Ethernet

### Controllers / Modular controllers / SIMATIC S7-300

#### Fail-safe CPUs

#### Technical specifications (continued)

	6ES7315-2FJ14-0AB0 CPU 315F-2 PN/DP	6ES7317-2FK14-0AB0 CPU 317F-2 PN/DP	6ES7318-3FL01-0AB0 CPU 319F-3 PN/DP
<b>2nd interface</b>			
Interface type	PROFINET	PROFINET	Integrated RS 485 interface
Physics	Ethernet RJ45	Ethernet RJ45	RS 485
Number of ports	2	2	
Functionality			
• MPI	No	No	No
• DP master	No	No	Yes
• DP slave	No	No	Yes; A DP slave at both interfaces simultaneously is not possible
• PROFINET IO Controller	Yes; Also simultaneously with IO-Device functionality	Yes; Also simultaneously with IO-Device functionality	No
• PROFINET IO Device	Yes; Also simultaneously with IO Controller functionality	Yes; Also simultaneously with IO Controller functionality	No
• PROFINET CBA	Yes	Yes	No
DP master			
• Number of DP slaves, max.			124
PROFINET IO Controller			
• Max. number of connectable IO devices for RT	128	128	
• Number of IO devices with IRT and the option "high flexibility"	128	128	
• Number of IO Devices with IRT and the option "high performance", max.	64	64	
<b>3rd interface</b>			
Interface type			PROFINET
Physics			Ethernet RJ45
Number of ports			2
Functionality			
• MPI			No
• DP master			No
• DP slave			No
• PROFINET IO Controller			Yes; Also simultaneously with I-Device functionality
• PROFINET IO Device			Yes; Also simultaneously with IO Controller functionality
• PROFINET CBA			Yes
PROFINET IO Controller			
• Max. number of connectable IO devices for RT			256
• Number of IO devices with IRT and the option "high flexibility"			256
• Number of IO Devices with IRT and the option "high performance", max.			64
<b>Isochronous mode</b>			
Isochronous operation (application synchronized up to terminal)	Yes; Via PROFIBUS DP or PROFINET interface	Yes; Via PROFIBUS DP or PROFINET interface	Yes; Via 2nd PROFIBUS DP or PROFINET interface



### Technical specifications (continued)

	6ES7315-2FJ14-0AB0 CPU 315F-2 PN/DP	6ES7317-2FK14-0AB0 CPU 317F-2 PN/DP	6ES7318-3FL01-0AB0 CPU 319F-3 PN/DP
<b>Communication functions</b>			
PG/OP communication	Yes	Yes	Yes
Data record routing	Yes	Yes	Yes
Global data communication • supported	Yes	Yes	Yes
S7 basic communication • supported	Yes	Yes	Yes
S7 communication • supported	Yes	Yes	Yes
S5-compatible communication • supported	Yes; Via CP and loadable FC	Yes; Via CP and loadable FC	Yes; Via CP and loadable FC
Open IE communication • TCP/IP	Yes; Via integrated PROFINET interface and loadable FBs	Yes; Via integrated PROFINET interface and loadable FBs	Yes; Via integrated PROFINET interface and loadable FBs
- Number of connections, max.	8	16	32
• ISO-on-TCP (RFC 1006)	Yes; Via integrated PROFINET interface and loadable FBs	Yes; Via integrated PROFINET interface and loadable FBs	Yes; Via integrated PROFINET interface and loadable FBs
- Number of connections, max.	8	16	32
• UDP	Yes; Via integrated PROFINET interface and loadable FBs	Yes; Via integrated PROFINET interface and loadable FBs	Yes; Via integrated PROFINET interface and loadable FBs
- Number of connections, max.	8	16	32
Web server • supported	Yes; only read function	Yes	Yes
Number of connections • overall	16	32	32
<b>Ambient conditions</b>			
Operating temperature			
• min.	0 °C	0 °C	0 °C
• max.	60 °C	60 °C	60 °C
<b>Configuration</b>			
programming			
• Programming language			
- LAD	Yes	Yes	Yes
- FBD	Yes	Yes	Yes
- STL	Yes	Yes	Yes
- SCL	Yes	Yes	Yes
- CFC	Yes	Yes	Yes
- GRAPH	Yes	Yes	Yes
- HiGraph®	Yes	Yes	Yes
Know-how protection			
• User program protection/password protection	Yes	Yes	Yes
• Block encryption	Yes; With S7 block Privacy	Yes; With S7 block Privacy	Yes; With S7 block Privacy
<b>Dimensions</b>			
Width	40 mm	40 mm	120 mm
Height	125 mm	125 mm	125 mm
Depth	130 mm	130 mm	130 mm
<b>Weights</b>			
Weight, approx.	340 g	340 g	1 250 g

## PROFINET/Industrial Ethernet

### Controllers / Modular controllers / SIMATIC S7-300

#### Fail-safe CPUs

##### Ordering data

##### CPU 315F-2 PN/DP

CPU for SIMATIC S7-300F;  
512 KB main memory,  
24 V DC power supply,  
MPI/PROFIBUS DP master/slave  
interface, Industrial Ethernet/  
PROFINET interface;  
incl. slot number labels;  
MMC required

**6ES7315-2FJ14-0AB0**

##### CPU 317F-2 PN/DP

Main memory 1.5 MB,  
24 V DC power supply,  
MPI/PROFIBUS DP master/slave  
interface, Industrial Ethernet/  
PROFINET interface;  
MMC required

**6ES7317-2FK14-0AB0**

##### CPU 319F-3 PN/DP

Main memory 2.5 MB,  
power supply 24 V DC,  
combined MPI/PROFIBUS DP  
master/slave interface,  
PROFIBUS DP master/slave  
interface,  
Ethernet/PROFINET interface  
MMC required

**6ES7318-3FL01-0AB0**

##### S7 Distributed Safety V5.4 programming tool

*Task:*  
Configuration software for  
configuring fail-safe user programs  
for SIMATIC S7-300F, S7-400F,  
WinAC RTX F, ET 200S, ET 200M,  
ET 200iSP, ET 200pro, ET 200eco  
*Requirement:*  
STEP 7 V5.3 SP3 and higher

Floating license

**6ES7833-1FC02-0YA5**

Floating license for 1 user,  
license key download without  
software or documentation<sup>1)</sup>;  
email address required for delivery

**6ES7833-1FC02-0YH5**

##### S7 Distributed Safety upgrade

From V5.x to V5.4;  
Floating license for 1 user

**6ES7833-1FC02-0YE5**

##### STEP 7 Safety Advanced V13

*Task:*  
Engineering tool for configuring  
fail-safe user programs for  
SIMATIC S7-1500F, S7-300F,  
S7-400F, WinAC RTX F, ET 200SP,  
ET 200S, ET 200M, ET 200iSP,  
ET 200pro, ET 200eco  
*Requirement:*  
STEP 7 Professional V13

Floating license for 1 user

**6ES7833-1FA13-0YA5**

Floating license for 1 user,  
license key download without  
software or documentation<sup>1)</sup>;  
email address required for delivery

**6ES7833-1FA13-0YH5**

##### SIMATIC Micro Memory Card

64 KB

**6ES7953-8LF30-0AA0**

128 KB

**6ES7953-8LG30-0AA0**

512 KB

**6ES7953-8LJ30-0AA0**

2 MB

**6ES7953-8LL31-0AA0**

4 MB

**6ES7953-8LM31-0AA0**

8 MB

**6ES7953-8LP31-0AA0**

##### MPI cable

for connection of SIMATIC S7 and  
PG via MPI; 5 m in length

**6ES7901-0BF00-0AA0**

##### Slot number plates

**6ES7912-0AA00-0AA0**

##### S7-300 manual

Design, CPU data, module data,  
instruction list

German

**6ES7398-8FA10-8AA0**

English

**6ES7398-8FA10-8BA0**

##### SIMATIC Manual Collection

Electronic manuals on DVD,  
multilingual: LOGO!, SIMADYN,  
SIMATIC bus components,  
SIMATIC C7,  
SIMATIC distributed I/O,  
SIMATIC HMI, SIMATIC Sensors,  
SIMATIC NET,  
SIMATIC PC Based Automation,  
SIMATIC PCS 7, SIMATIC PG/PC,  
SIMATIC S7, SIMATIC Software,  
SIMATIC TDC

**6ES7998-8XC01-8YE0**

##### SIMATIC Manual Collection update service for 1 year

Current "Manual Collection" DVD  
and the three subsequent updates

**6ES7998-8XC01-8YE2**

Ordering data	Article No.	Article No.
<b>Power supply connector</b> 10 units, spare part	<b>6ES7391-1AA00-0AA0</b>	
<b>USB A2 PC adapter</b> for connecting a PG/PC or Notebook to PROFIBUS or MPI; USB cable included in scope of delivery	<b>6GK1571-0BA00-0AA0</b>	
<b>PROFIBUS DP bus connector RS 485</b> <ul style="list-style-type: none"> <li>With 90° cable outlet, max. transfer rate 12 Mbit/s               <ul style="list-style-type: none"> <li>Without PG interface</li> <li>With PG interface</li> </ul> </li> <li>With 90° cable outlet for FastConnect connection system, max. transfer rate 12 Mbit/s               <ul style="list-style-type: none"> <li>Without PG interface, 1 unit</li> <li>Without PG interface, 100 units</li> <li>With PG interface, 1 unit</li> <li>With PG interface, 100 units</li> </ul> </li> <li>With axial cable outlet for SIMATIC OP, for connecting to PPI, MPI, PROFIBUS</li> </ul>	<b>6ES7972-0BA12-0XA0</b> <b>6ES7972-0BB12-0XA0</b>  <b>6ES7972-0BA52-0XA0</b> <b>6ES7972-0BA52-0XB0</b> <b>6ES7972-0BB52-0XA0</b> <b>6ES7972-0BB52-0XB0</b> <b>6GK1500-0EA02</b>	<b>PROFINET bus components</b> <b>IE FC TP standard cable GP 2x2</b> 4-core, shielded TP installation cable for connection to IE FC Outlet RJ45/IE FC RJ45 Plug; PROFINET-compatible; with UL approval; sold by the meter <b>FO standard cable GP (50/125)</b> Standard cable, splittable, UL approval, sold by the meter <b>SCALANCE X204-2 Industrial Ethernet Switch</b> Industrial Ethernet Switches with integral SNMP access, Web diagnostics, copper cable diagnostics and PROFINET diagnostics for configuring line, star and ring topologies; four 10/100 Mbit/s RJ45 ports and two FO ports <b>Compact Switch Module CSM 377</b> Unmanaged switch for connecting a SIMATIC S7-300, ET 200M and up to three other stations to Industrial Ethernet with 10/100 Mbit/s; 4 x RJ45 ports; external 24 V DC power supply, LED diagnostics, S7-300 module incl. electronic manual on CD-ROM
<b>PROFIBUS FastConnect bus cable</b> Standard type with special design for quick mounting, 2-core, shielded, sold by the meter, max. delivery unit 1 000 m, minimum ordering quantity 20 m	<b>6XV1830-0EH10</b>	<b>6XV1840-2AH10</b>
<b>RS 485 repeater for PROFIBUS</b> Transmission rate up to 12 Mbit/s; 24 V DC; IP20 enclosure	<b>6ES7972-0AA02-0XA0</b>	<b>6XV1873-2A</b>
		<b>6GK5204-2BB10-2AA3</b>
		<b>6GK7377-1AA00-0AA0</b>
		<b>IE FC RJ45 Plugs</b> RJ45 plug connector for Industrial Ethernet with a rugged metal enclosure and integrated insulation displacement contacts for connecting Industrial Ethernet FC installation cables <b>IE FC RJ45 plug 145</b> 145° cable outlet 1 unit 10 units 50 units <b>IE FC RJ45 plug 180</b> 180° cable outlet 1 unit 10 units 50 units
		<b>6GK1901-1BB30-0AA0</b> <b>6GK1901-1BB30-0AB0</b> <b>6GK1901-1BB30-0AE0</b>  <b>6GK1901-1BB10-2AA0</b> <b>6GK1901-1BB10-2AB0</b> <b>6GK1901-1BB10-2AE0</b>

<sup>1)</sup> For up-to-date information and download availability, see: <http://www.siemens.com/tia-online-software-delivery>

**PROFINET/Industrial Ethernet****Controllers / Modular controllers / SIMATIC S7-400****Standard CPUs****Overview CPU 412-2PN**

- The low-cost starter solution for the medium performance range
- Can be used in small and medium-sized systems with requirements of the medium performance range

**Overview CPU 416-3 PN/DP**

- High-performance CPUs in the high-end performance range
- Applicable for plants with high requirements in the high-end performance range
- Integrated PROFINET functions in CPU 416-3 PN/DP

**Overview CPU 414-3 PN/DP**

- CPUs for high demands in the mid-level performance range
- Applicable for plants with additional demands on programming scope and processing speed
- Integrated PROFINET functions in CPU 414-3 PN/DP

### Technical specifications

	6ES7412-2EK06-0AB0 CPU 412-2 PN	6ES7414-3EM06-0AB0 CPU 414-3 PN/DP	6ES7416-3ES06-0AB0 CPU 416-3 PN/DP
<b>General information</b>			
Engineering with • Programming package	STEP 7 V 5.5 or higher / IMap V3.0 or higher + iMap-STEP 7 Addon V3.0 SP5	STEP 7 V 5.5 or higher / IMap V3.0 or higher + iMap-STEP 7 Addon V3.0 SP5	STEP 7 V 5.5 or higher / IMap V3.0 or higher + iMap-STEP 7 Addon V3.0 SP5
<b>Supply voltage</b>			
24 V DC	No; Power supply via system power supply	No; Power supply via system power supply	No; Power supply via system power supply
<b>Power losses</b>			
Power loss, typ.	5.5 W	6.5 W	6.5 W
<b>Memory</b>			
Work memory			
• integrated	1 Mbyte	4 Mbyte	16 Mbyte
• integrated (for program)	0.5 Mbyte	2 Mbyte	8 Mbyte
• integrated (for data)	0.5 Mbyte	2 Mbyte	8 Mbyte
Load memory			
• expandable FEPRM, max.	64 Mbyte	64 Mbyte	64 Mbyte
• integrated RAM, max.	512 kbyte	512 kbyte	1 Mbyte
• expandable RAM, max.	64 Mbyte	64 Mbyte	64 Mbyte
<b>CPU processing times</b>			
for bit operations, typ.	75 ns	45 ns	30 ns
for word operations, typ.	75 ns	45 ns	30 ns
for fixed point arithmetic, typ.	75 ns	45 ns	30 ns
for floating point arithmetic, typ.	225 ns	135 ns	90 ns
<b>Counters, timers and their retentivity</b>			
S7 counter			
• Number	2 048	2 048	2 048
IEC counter			
• present	Yes	Yes	Yes
S7 times			
• Number	2 048	2 048	2 048
IEC timer			
• present	Yes	Yes	Yes
<b>Data areas and their retentivity</b>			
Flag			
• Number, max.	4 kbyte; Size of bit memory address area	8 kbyte; Size of bit memory address area	16 kbyte; Size of bit memory address area
<b>Address area</b>			
I/O address area			
• Inputs	4 kbyte	8 kbyte	16 kbyte
• Outputs	4 kbyte	8 kbyte	16 kbyte
Process image			
• Inputs, adjustable	4 kbyte	8 kbyte	16 kbyte
• Outputs, adjustable	4 kbyte	8 kbyte	16 kbyte
<b>Hardware configuration</b>			
Slots			
• Required slots	1	2	2
<b>Time of day</b>			
Clock			
• Hardware clock (real-time clock)	Yes	Yes	Yes
Operating hours counter			
• Number	16	16	16
<b>1st interface</b>			
Interface type	integrated	integrated	integrated
Physics	RS 485 / PROFIBUS + MPI	RS 485 / PROFIBUS + MPI	RS 485 / PROFIBUS + MPI
Functionality			
• MPI	Yes	Yes	Yes
• DP master	Yes	Yes	Yes
• DP slave	Yes	Yes	Yes
DP master			
• Number of DP slaves, max.	32	32	32

## PROFINET/Industrial Ethernet

### Controllers / Modular controllers / SIMATIC S7-400

#### Standard CPUs

#### Technical specifications (continued)

	6ES7412-2EK06-0AB0 CPU 412-2 PN	6ES7414-3EM06-0AB0 CPU 414-3 PN/DP	6ES7416-3ES06-0AB0 CPU 416-3 PN/DP
<b>2nd interface</b>			
Interface type	PROFINET	PROFINET	PROFINET
Physics	Ethernet RJ45	Ethernet RJ45	Ethernet RJ45
Number of ports	2	2	2
Functionality			
• DP master	No	No	No
• DP slave	No	No	No
• PROFINET IO Controller	Yes	Yes	Yes
• PROFINET IO Device	Yes	Yes	Yes
• PROFINET CBA	Yes	Yes	Yes
DP master			
• Number of DP slaves, max.			
PROFINET IO Controller			
• Max. number of connectable IO devices for RT	256	256	256
• Number of IO devices with IRT and the option "high flexibility"	256	256	256
• Number of IO Devices with IRT and the option "high performance", max.	64	64	64
<b>3rd interface</b>			
Interface type		Pluggable interface module (IF)	Pluggable interface module (IF)
Plug-in interface modules		IF 964-DP (MLFB: 6ES7964-2AA04-0AB0)	IF 964-DP (MLFB: 6ES7964-2AA04-0AB0)
Physics		RS 485 / PROFIBUS	RS 485 / PROFIBUS
Functionality			
• MPI		No	No
• DP master		Yes	Yes
• DP slave		Yes	Yes
DP master			
• Number of DP slaves, max.		96	125
<b>Isochronous mode</b>			
Isochronous operation (application synchronized up to terminal)	Yes; Via PROFIBUS DP or PROFINET interface	Yes; Via PROFIBUS DP or PROFINET interface	Yes; Via PROFIBUS DP or PROFINET interface
<b>Communication functions</b>			
PG/OP communication	Yes	Yes	Yes
Data record routing	Yes	Yes	Yes
Global data communication			
• supported	Yes	Yes	Yes
S7 basic communication			
• supported	Yes	Yes	Yes
S7 communication			
• supported	Yes	Yes	Yes
S5-compatible communication			
• supported	Yes; Via FC AG_SEND and AG_RECV, max. via 10 CP 443-1 or 443-5	Yes; Via FC AG_SEND and AG_RECV, max. via 10 CP 443-1 or 443-5	Yes; Via FC AG_SEND and AG_RECV, max. via 10 CP 443-1 or 443-5
Standard communication (FMS)			
• supported	Yes; Via CP and loadable FB	Yes; Via CP and loadable FB	Yes; Via CP and loadable FB
Open IE communication			
• TCP/IP	Yes; Via integrated PROFINET interface and loadable FBs	Yes; Via integrated PROFINET interface and loadable FBs	Yes; Via integrated PROFINET interface and loadable FBs
- Number of connections, max.	46	62	94
• ISO-on-TCP (RFC1006)	Yes; Via integrated PROFINET interface or CP 443-1 Adv. and loadable FBs	Yes; Via integrated PROFINET interface or CP 443-1 Adv. and loadable FBs	Yes; Via integrated PROFINET interface or CP 443-1 and loadable FBs
- Number of connections, max.	46	62	94
• UDP	Yes; Via integrated PROFINET interface and loadable FBs	Yes; Via integrated PROFINET interface and loadable FBs	Yes; Via integrated PROFINET interface and loadable FBs
- Number of connections, max.	46	62	94
Web server			
• supported	Yes	Yes	Yes
Number of connections			
• overall	48	64	96

### Technical specifications (continued)

	6ES7412-2EK06-0AB0 CPU 412-2 PN	6ES7414-3EM06-0AB0 CPU 414-3 PN/DP	6ES7416-3ES06-0AB0 CPU 416-3 PN/DP
<b>Configuration</b>			
programming			
• Programming language			
- LAD	Yes	Yes	Yes
- FBD	Yes	Yes	Yes
- STL	Yes	Yes	Yes
- SCL	Yes	Yes	Yes
- CFC	Yes	Yes	Yes
- GRAPH	Yes	Yes	Yes
- HiGraph®	Yes	Yes	Yes
Know-how protection			
• User program protection/password protection	Yes	Yes	Yes
• Block encryption	Yes; With S7 block Privacy	Yes; With S7 block Privacy	Yes; With S7 block Privacy
<b>Dimensions</b>			
Width	25 mm	50 mm	50 mm
Height	290 mm	290 mm	290 mm
Depth	219 mm	219 mm	219 mm
<b>Weights</b>			
Weight, approx.	750 g	900 g	900 g

### Ordering data

Ordering data	Article No.	Ordering data	Article No.
<b>CPU 412-2 PN</b>	<b>6ES7412-2EK06-0AB0</b>	<b>FEPROM memory card</b>	
Main memory 1 MB, power supply 24 V DC, MPI/PROFIBUS DP master inter- face, PROFINET interface, slot for memory card, incl. slot number labels		64 KB	<b>6ES7952-0KF00-0AA0</b>
		256 KB	<b>6ES7952-0KH00-0AA0</b>
		1 MB	<b>6ES7952-1KK00-0AA0</b>
		2 MB	<b>6ES7952-1KL00-0AA0</b>
		4 MB	<b>6ES7952-1KM00-0AA0</b>
		8 MB	<b>6ES7952-1KP00-0AA0</b>
		16 MB	<b>6ES7952-1KS00-0AA0</b>
		32 MB	<b>6ES7952-1KT00-0AA0</b>
		64 MB	<b>6ES7952-1KY00-0AA0</b>
<b>CPU 414-3 PN/DP</b>	<b>6ES7414-3EM06-0AB0</b>	<b>MPI cable</b>	<b>6ES7901-0BF00-0AA0</b>
Main memory 4 MB, power supply 24 V DC, MPI/PROFIBUS DP master inter- face, PROFINET interface, slot for memory card, module slot for 1 IF module, incl. slot number labels		for connection of SIMATIC S7 and PG via MPI; 5 m in length	
<b>CPU 416-3 PN/DP</b>	<b>6ES7416-3ES06-0AB0</b>	<b>IF 964-DP interface module</b>	<b>6ES7964-2AA04-0AB0</b>
Main memory 16 MB, power supply 24 V DC, MPI/PROFIBUS DP master inter- face, PROFINET interface, module slot for 1 IF submodule, slot for memory card, incl. slot number labels		To connect an additional DP line; for CPU 414-3, CPU 414-3 PN/DP, CPU 416-3, CPU 416-3 PN/DP, CPU 417-4	
<b>Memory card RAM</b>		<b>Slot number plates</b>	<b>6ES7912-0AA00-0AA0</b>
64 KB	<b>6ES7952-0AF00-0AA0</b>	1 set (spare part)	
256 KB	<b>6ES7952-1AH00-0AA0</b>	<b>SIMATIC Manual Collection</b>	<b>6ES7998-8XC01-8YE0</b>
1 MB	<b>6ES7952-1AK00-0AA0</b>	Electronic manuals on DVD, multilingual: LOGO!, SIMADYN, SIMATIC bus components, SIMATIC C7, SIMATIC distributed I/O, SIMATIC HMI, SIMATIC Sensors, SIMATIC NET, SIMATIC PC Based Automation, SIMATIC PCS 7, SIMATIC PG/PC, SIMATIC S7, SIMATIC Software, SIMATIC TDC	
2 MB	<b>6ES7952-1AL00-0AA0</b>	<b>SIMATIC Manual Collection update service for 1 year</b>	<b>6ES7998-8XC01-8YE2</b>
4 MB	<b>6ES7952-1AM00-0AA0</b>	Current "Manual Collection" DVD and the three subsequent updates	
8 MB	<b>6ES7952-1AP00-0AA0</b>		
16 MB	<b>6ES7952-1AS00-0AA0</b>		
64 MB	<b>6ES7952-1AY00-0AA0</b>		

## PROFINET/Industrial Ethernet

### Controllers / Modular controllers / SIMATIC S7-400

#### Standard CPUs

Ordering data	Article No.	Article No.
<b>RS 485 bus connector with 90° cable outlet</b> Max. transfer rate 12 Mbit/s Without PG interface With PG interface	<b>6ES7972-0BA12-0XA0</b> <b>6ES7972-0BB12-0XA0</b>	<b>PROFINET bus components</b> <b>IE FC TP standard cable GP 2x2</b> 4-core, shielded TP installation cable for connection to IE FC Outlet RJ45/IE FC RJ45 Plug; PROFINET-compatible; with UL approval; Sold by the meter <b>FO Standard Cable GP (50/125)</b> Standard cable, splittable, UL approval, sold by the meter
<b>RS 485 bus connector with angled cable outlet</b> Max. transfer rate 12 Mbit/s Without PG interface With PG interface	<b>6ES7972-0BA42-0XA0</b> <b>6ES7972-0BB42-0XA0</b>	
<b>RS 485 bus connector with 90° cable outlet for FastConnect connection system</b> Max. transfer rate 12 Mbit/s Without PG interface <ul style="list-style-type: none"> <li>• 1 unit</li> <li>• 100 units</li> </ul> With PG interface <ul style="list-style-type: none"> <li>• 1 unit</li> <li>• 100 units</li> </ul>	<b>6ES7972-0BA52-0XA0</b> <b>6ES7972-0BA52-0XB0</b> <b>6ES7972-0BB52-0XA0</b> <b>6ES7972-0BB52-0XB0</b>	<b>SCALANCE X204-2 Industrial Ethernet switch</b> Industrial Ethernet Switches with integral SNMP access, web diagnostics, copper cable diagnostics and PROFINET diagnostics for configuring line, star and ring topologies; four 10/100 Mbit/s RJ45 ports and two FO ports
<b>RS 485 bus connector with axial cable outlet</b> For SIMATIC OP, for connection to PPI, MPI, PROFIBUS	<b>6GK1500-0EA02</b>	<b>IE FC RJ45 plugs</b> RJ45 plug connector for Industrial Ethernet with a rugged metal enclosure and integrated insulation displacement contacts for connecting Industrial Ethernet FC installation cables
<b>PROFIBUS FastConnect bus cable</b> Standard type with special design for quick mounting, 2-core, shielded, sold by the meter, max. delivery unit 1 000 m, minimum ordering quantity 20 m	<b>6XV1830-0EH10</b>	<b>IE FC RJ45 plug 180</b> 180° cable outlet 1 unit 10 units 50 units
<b>RS 485 repeater for PROFIBUS</b> Transmission rate up to 12 Mbit/s; 24 V DC; IP20 enclosure	<b>6ES7972-0AA02-0XA0</b>	<b>6GK1901-1BB10-2AA0</b> <b>6GK1901-1BB10-2AB0</b> <b>6GK1901-1BB10-2AE0</b>

#### More information

##### Brochures

Information material for downloading can be found in the Internet:

<http://www.automation.siemens.com/infocenter>



**Overview CPU 414F-3 PN/DP**

- For constructing a fail-safe automation system for plants with increased safety requirements
- CPUs for high demands in the mid-level performance range
- Applicable for plants with additional demands on programming scope and processing speed
- Complies with safety requirements to SIL 3 acc. to IEC 61508 and PL e acc. to ISO 13849.1
- Standard and safety-related tasks can be performed with a single CPU
- Integrated PROFINET functions in CPU 414F-3 PN/DP
- Multi-processor mode is possible
- Safety-related communication with distributed I/O devices over PROFIBUS DP or PROFINET IO with PROFIsafe profile
- Fail-safe I/O modules can be connected in a distributed manner via the integrated interfaces (DP and PN with CPU 416F-3 PN/DP) and/or through communication modules (CP 443-5 Extended and CP 443-1 Adv.)
- Central and distributed use of standard modules for non-safety-oriented applications

**Overview CPU 416F-3 PN/DP**

- For constructing a fail-safe automation system for plants with increased safety requirements
- High-performance CPU in the top-end performance range
- Complies with safety requirements to SIL 3 acc. to IEC 61508 and PL e acc. to ISO 13849.1
- Standard and safety-related tasks can be performed with a single CPU
- Multi-processor mode is possible
- Safety-related communication with distributed I/O devices over PROFIBUS DP with the PROFIsafe profile
- Fail-safe I/O modules can be connected decentralized over the integrated interfaces (DP and PN with CPU 416F-3 PN/DP) and/or through communication modules (CP 443-5 Ext. and CP 443-1 Adv.)
- Standard modules for non-safety-related applications can be operated centrally and decentralized

**Technical specifications**

	<b>6ES7414-3FM06-0AB0</b> <b>CPU 414F-3 PN/DP</b>	<b>6ES7416-3FS06-0AB0</b> <b>CPU 416F-3 PN/DP</b>
<b>General information</b>		
Engineering with		
• Programming package	STEP 7 V 5.5 or higher / IMap V3.0 or higher + iMap- STEP 7 Addon V3.0 SP5	STEP 7 V 5.5 or higher / IMap V3.0 or higher + iMap- STEP 7 Addon V3.0 SP5
<b>Supply voltage</b>		
24 V DC	No; Power supply via system power supply	No; Power supply via system power supply
<b>Power losses</b>		
Power loss, typ.	6.5 W	6.5 W
<b>Memory</b>		
Work memory		
• integrated	4 Mbyte	16 Mbyte
• integrated (for program)	2 Mbyte	8 Mbyte
• integrated (for data)	2 Mbyte	8 Mbyte
Load memory		
• expandable FEPRAM, max.	64 Mbyte	64 Mbyte
• integrated RAM, max.	512 kbyte	1 Mbyte
• expandable RAM, max.	64 Mbyte	64 Mbyte

## PROFINET/Industrial Ethernet

### Controllers / Modular controllers / SIMATIC S7-400

#### Fail-safe CPUs

#### Technical specifications (continued)

	6ES7414-3FM06-0AB0 CPU 414F-3 PN/DP	6ES7416-3FS06-0AB0 CPU 416F-3 PN/DP
<b>CPU processing times</b>		
for bit operations, typ.	45 ns	30 ns
for word operations, typ.	45 ns	30 ns
for fixed point arithmetic, typ.	45 ns	30 ns
for floating point arithmetic, typ.	135 ns	90 ns
<b>Counters, timers and their retentivity</b>		
S7 counter		
• Number	2 048	2 048
IEC counter		
• present	Yes	Yes
S7 times		
• Number	2 048	2 048
IEC timer		
• present	Yes	Yes
<b>Data areas and their retentivity</b>		
Flag		
• Number, max.	8 kbyte; Size of bit memory address area	16 kbyte; Size of bit memory address area
<b>Address area</b>		
I/O address area		
• Inputs	8 kbyte	16 kbyte
• Outputs	8 kbyte	16 kbyte
Process image		
• Inputs, adjustable	8 kbyte	16 kbyte
• Outputs, adjustable	8 kbyte	16 kbyte
<b>Hardware configuration</b>		
Slots		
• Required slots	2	2
<b>Time of day</b>		
Clock		
• Hardware clock (real-time clock)	Yes	Yes
Operating hours counter		
• Number	16	16
<b>1st interface</b>		
Interface type	integrated	integrated
Physics	RS 485 / PROFIBUS + MPI	RS 485 / PROFIBUS + MPI
Functionality		
• MPI	Yes	Yes
• DP master	Yes	Yes
• DP slave	Yes	Yes
DP master		
• Number of DP slaves, max.	32	32
<b>2nd interface</b>		
Interface type	PROFINET	PROFINET
Physics	Ethernet RJ45	Ethernet RJ45
Number of ports	2	2
Functionality		
• DP master	No	No
• DP slave	No	No
• PROFINET IO Controller	Yes	Yes
• PROFINET IO Device	Yes	Yes
• PROFINET CBA	Yes	Yes
DP master		
• Number of DP slaves, max.		
PROFINET IO Controller		
• Max. number of connectable IO devices for RT	256	256
• Number of IO devices with IRT and the option "high flexibility"	256	256
• Number of IO Devices with IRT and the option "high performance", max.	64	64

**Technical specifications** (continued)

	<b>6ES7414-3FM06-0AB0</b> <b>CPU 414F-3 PN/DP</b>	<b>6ES7416-3FS06-0AB0</b> <b>CPU 416F-3 PN/DP</b>
<b>3rd interface</b>		
Interface type	Pluggable interface module (IF)	Pluggable interface module (IF)
Plug-in interface modules	IF 964-DP (MLFB: 6ES7964-2AA04-0AB0)	IF 964-DP (MLFB: 6ES7964-2AA04-0AB0)
Physics	RS 485 / PROFIBUS	RS 485 / PROFIBUS
Functionality		
• MPI	No	No
• DP master	Yes	Yes
• DP slave	Yes	Yes
DP master		
• Number of DP slaves, max.	96	125
<b>Isochronous mode</b>		
Isochronous operation (application synchronized up to terminal)	Yes; Via PROFIBUS DP or PROFINET interface	Yes; Via PROFIBUS DP or PROFINET interface
<b>Communication functions</b>		
PG/OP communication	Yes	Yes
Data record routing	Yes	Yes
Global data communication		
• supported	Yes	Yes
S7 basic communication		
• supported	Yes	Yes
S7 communication		
• supported	Yes	Yes
S5-compatible communication		
• supported	Yes; Via FC AG_SEND and AG_RECV, max. via 10 CP 443-1 or 443-5	Yes; Via FC AG_SEND and AG_RECV, max. via 10 CP 443-1 or 443-5
Standard communication (FMS)		
• supported	Yes; Via CP and loadable FB	Yes; Via CP and loadable FB
Open IE communication		
• TCP/IP	Yes; via integrated PROFINET interface and loadable FBs 62	Yes; via integrated PROFINET interface and loadable FBs 94
• ISO-on-TCP (RFC1006)	Yes; Via integrated PROFINET interface or CP 443-1 Adv. and loadable FBs 62	Yes; Via integrated PROFINET interface or CP 443-1 and loadable FBs 94
• UDP	Yes; via integrated PROFINET interface and loadable FBs 62	Yes; via integrated PROFINET interface and loadable FBs 94
Web server		
• supported	Yes	Yes
Number of connections		
• overall	64	96
<b>Configuration</b>		
programming		
• Programming language		
- LAD	Yes	Yes
- FBD	Yes	Yes
- STL	Yes	Yes
- SCL	Yes	Yes
- CFC	Yes	Yes
- GRAPH	Yes	Yes
- HiGraph®	Yes	Yes
Know-how protection		
• User program protection/password protection	Yes	Yes
• Block encryption	Yes; With S7 block Privacy	Yes; With S7 block Privacy
<b>Dimensions</b>		
Width	50 mm	50 mm
Height	290 mm	290 mm
Depth	219 mm	219 mm
<b>Weights</b>		
Weight, approx.	900 g	900 g

## PROFINET/Industrial Ethernet

### Controllers / Modular controllers / SIMATIC S7-400

#### Fail-safe CPUs

#### Ordering data

##### CPU 414F-3 PN/DP

for setting up safety-related automation system  
Main memory 4 MB,  
power supply 24 V DC,  
MPI/PROFIBUS DP master interface, PROFINET interface,  
slot for memory card,  
module slot for 1 IF module,  
incl. slot number labels

**6ES7414-3FM06-0AB0**

##### CPU 416F-3 PN/DP

for configuring safety-related automation systems  
Main memory 16 MB,  
24 V DC power supply,  
MPI/PROFIBUS DP master interface, PROFINET interface,  
PROFIBUS DP master interface,  
receptacle for 1 IF submodule,  
slot for memory card,  
incl. slot number labels

**6ES7416-3FS06-0AB0**

##### Distributed Safety V5.4 programming tool

*Task:*  
Configuration software for configuring fail-safe user programs for SIMATIC S7-300F, S7-400F, WinAC RTX F, ET 200S, ET 200M, ET 200iSP, ET 200pro, ET 200eco

*Requirement:*  
STEP 7 V5.3 SP3 and higher

Floating license

**6ES7833-1FC02-0YA5**

Floating license for 1 user, license key download without software or documentation<sup>1)</sup>; email address required for delivery

**6ES7833-1FC02-0YH5**

##### Distributed Safety Upgrade

from V5.x to V5.4;  
Floating license for 1 user

**6ES7833-1FC02-0YE5**

##### STEP 7 Safety Advanced V13

*Task:*  
Engineering tool for configuring fail-safe user programs for SIMATIC S7-1500F, S7-300F, S7-400F, WinAC RTX F, ET 200SP, ET 200S, ET 200M, ET 200iSP, ET 200pro, ET 200eco

*Requirement:*  
STEP 7 Professional V13

Floating license for 1 user

**6ES7833-1FA13-0YA5**

Floating license for 1 user, license key download without software or documentation<sup>1)</sup>; email address required for delivery

**6ES7833-1FA13-0YH5**

##### Memory Card RAM

64 KB

**6ES7952-0AF00-0AA0**

256 KB

**6ES7952-1AH00-0AA0**

1 MB

**6ES7952-1AK00-0AA0**

2 MB

**6ES7952-1AL00-0AA0**

4 MB

**6ES7952-1AM00-0AA0**

8 MB

**6ES7952-1AP00-0AA0**

16 MB

**6ES7952-1AS00-0AA0**

64 MB

**6ES7952-1AY00-0AA0**

##### FEPRAM memory card

64 KB

**6ES7952-0KF00-0AA0**

256 KB

**6ES7952-0KH00-0AA0**

1 MB

**6ES7952-1KK00-0AA0**

2 MB

**6ES7952-1KL00-0AA0**

4 MB

**6ES7952-1KM00-0AA0**

8 MB

**6ES7952-1KP00-0AA0**

16 MB

**6ES7952-1KS00-0AA0**

32 MB

**6ES7952-1KT00-0AA0**

64 MB

**6ES7952-1KY00-0AA0**

##### MPI cable

**6ES7901-0BF00-0AA0**

for connection of SIMATIC S7 and PG via MPI;  
5 m in length

##### IF 964-DP interface module

**6ES7964-2AA04-0AB0**

for connecting an additional DP line

##### Slot number plates

**6ES7912-0AA00-0AA0**

1 set (spare part)

##### SIMATIC Manual Collection

**6ES7998-8XC01-8YE0**

Electronic manuals on DVD, multilingual: LOGO!, SIMADYN, SIMATIC bus components, SIMATIC C7, SIMATIC distributed I/O, SIMATIC HMI, SIMATIC Sensors, SIMATIC NET, SIMATIC PC Based Automation, SIMATIC PCS 7, SIMATIC PG/PC, SIMATIC S7, SIMATIC Software, SIMATIC TDC

##### SIMATIC Manual Collection update service for 1 year

**6ES7998-8XC01-8YE2**

Current "Manual Collection" DVD and the three subsequent updates

Ordering data	Article No.	Article No.	
<b>PROFIBUS bus components</b>		<b>PROFINET bus components</b>	
<b>RS 485 bus connector with 90° cable outlet</b> Max. transfer rate 12 Mbit/s Without PG interface With PG interface	 <b>6ES7972-0BA12-0XA0</b> <b>6ES7972-0BB12-0XA0</b>	<b>IE FC TP standard cable GP 2x2</b> 4-core, shielded TP installation cable for connection to IE FC Outlet RJ45/IE FC RJ45 Plug; PROFINET-compatible; with UL approval; Sold by the meter	<b>6XV1840-2AH10</b>
<b>RS 485 bus connector with angled cable outlet</b> Max. transfer rate 12 Mbit/s Without PG interface With PG interface	 <b>6ES7972-0BA42-0XA0</b> <b>6ES7972-0BB42-0XA0</b>	<b>FO Standard Cable GP (50/125)</b> Standard cable, splittable, UL approval, sold by the meter	<b>6XV1873-2A</b>
<b>RS 485 bus connector with 90° cable outlet for FastConnect system</b> Max. transfer rate 12 Mbit/s Without PG interface <ul style="list-style-type: none"> <li>• 1 unit</li> <li>• 100 units</li> </ul> With PG interface <ul style="list-style-type: none"> <li>• 1 unit</li> <li>• 100 units</li> </ul>	 <b>6ES7972-0BA52-0XA0</b> <b>6ES7972-0BA52-0XB0</b>  <b>6ES7972-0BB52-0XA0</b> <b>6ES7972-0BB52-0XB0</b>	<b>SCALANCE X204-2 Industrial Ethernet Switch</b> Industrial Ethernet Switches with integral SNMP access, Web diagnostics, copper cable diagnostics and PROFINET diagnostics for configuring line, star and ring topologies; four 10/100 Mbit/s RJ45 ports and two FO ports	<b>6GK5204-2BB10-2AA3</b>
<b>RS 485 bus connector with axial cable outlet</b> For SIMATIC OP, for connection to PPI, MPI, PROFIBUS	<b>6GK1500-0EA02</b>	<b>IE FC RJ45 plugs</b> RJ45 plug connector for Industrial Ethernet with a rugged metal enclosure and integrated insulation displacement contacts for connecting Industrial Ethernet FC installation cables	
<b>PROFIBUS FastConnect bus cable</b> Standard type with special design for quick mounting, 2-core, shielded, sold by the meter, max. delivery unit 1 000 m, minimum ordering quantity 20 m	<b>6XV1830-0EH10</b>	<b>IE FC RJ45 plug 180</b> 180° cable outlet 1 unit 10 units 50 units	 <b>6GK1901-1BB10-2AA0</b> <b>6GK1901-1BB10-2AB0</b> <b>6GK1901-1BB10-2AE0</b>
<b>RS 485 repeater for PROFIBUS</b> Transmission rate up to 12 Mbit/s; 24 V DC; IP20 enclosure	<b>6ES7972-0AA02-0XA0</b>		

<sup>1)</sup> For up-to-date information and download availability, see: <http://www.siemens.com/tia-online-software-delivery>

**PROFINET/Industrial Ethernet****Controllers / Modular controllers / SIMATIC S7-400****High-availability CPUs****Overview CPU 412-5H**

- CPU for SIMATIC S7-400H and S7-400F/FH
- Can be used in S7-400H high-availability systems
- Can be used with F runtime license as F-capable CPU in S7-400F/FH safety-related systems
- With integrated PROFIBUS DP master and combined MPI/PROFIBUS DP master interface
- With integrated PROFINET interface (2-port switch)
- Features 2 slots for sync modules

**Overview CPU 416-5H**

- CPU for SIMATIC S7-400H and S7-400F/FH
- Can be used in S7-400H high-availability systems
- Can be used with F runtime license as F-capable CPU in S7-400F/FH safety-related systems
- With integrated PROFIBUS DP master and combined MPI/PROFIBUS DP master interface
- With integrated PROFINET interface (2-port switch)
- Features 2 slots for sync modules

**Overview CPU 414-5H**

- CPU for SIMATIC S7-400H and S7-400F/FH
- Can be used in S7-400H high-availability systems
- Can be used with F runtime license as F-capable CPU in S7-400F/FH safety-related systems
- With integrated PROFIBUS DP master and combined MPI/PROFIBUS DP master interface
- With integrated PROFINET interface (2-port switch)
- Features 2 slots for sync modules

**Overview CPU 417-5H**

- CPU for SIMATIC S7-400H and S7-400F/FH
- Can be used in S7-400H high-availability systems
- Can be used with F runtime license as F-capable CPU in S7-400F/FH safety-related systems
- With integrated PROFIBUS DP master interface and combined MPI/PROFIBUS DP master interface
- With integrated PROFINET interface (2-port switch)
- Features 2 slots for sync modules

### Technical specifications

	6ES7412-5HK06-0AB0 CPU 412-5H PN/DP	6ES7414-5HM06-0AB0 CPU 414-5H PN/DP	6ES7416-5HS06-0AB0 CPU 416-5H PN/DP	6ES7417-5HT06-0AB0 CPU 417-5H PN/DP
<b>General information</b>				
Engineering with • Programming package	STEP 7 V 5.5 SP2 or higher with HF1	STEP 7 V 5.5 SP2 or higher with HF1	STEP 7 V 5.5 SP2 or higher with HF1	STEP 7 V 5.5 SP2 or higher with HF1
<b>Supply voltage</b>				
24 V DC	No; Power supply Via system power supply	No; Power supply Via system power supply	No; Power supply Via system power supply	No; Power supply Via system power supply
<b>Power losses</b>				
Power loss, typ.	7.5 W	7.5 W	7.5 W	7.5 W
<b>Memory</b>				
Work memory				
• integrated	1 Mbyte	4 Mbyte	16 Mbyte	32 Mbyte
• integrated (for program)	512 kbyte	2 Mbyte	6 Mbyte	16 Mbyte
• integrated (for data)	512 kbyte	2 Mbyte	10 Mbyte	16 Mbyte
Load memory				
• expandable FEPRAM, max.	64 Mbyte	64 Mbyte	64 Mbyte	64 Mbyte
• integrated RAM, max.	512 kbyte	512 kbyte	1 Mbyte	1 Mbyte
• expandable RAM, max.	64 Mbyte	64 Mbyte	64 Mbyte	64 Mbyte
<b>CPU processing times</b>				
for bit operations, typ.	31.25 ns	18.75 ns	12.5 ns	7.5 ns
for word operations, typ.	31.25 ns	18.75 ns	12.5 ns	7.5 ns
for fixed point arithmetic, typ.	31.25 ns	18.75 ns	12.5 ns	7.5 ns
for floating point arithmetic, typ.	62.5 ns	37.5 ns	25 ns	15 ns
<b>Counters, timers and their retentivity</b>				
S7 counter				
• Number	2 048	2 048	2 048	2 048
IEC counter				
• present	Yes	Yes	Yes	Yes
S7 times				
• Number	2 048	2 048	2 048	2 048
IEC timer				
• present	Yes	Yes	Yes	Yes
<b>Data areas and their retentivity</b>				
Flag				
• Number, max.	8 192 byte	8 192 byte	16 384 byte	16 384 byte
<b>Address area</b>				
I/O address area				
• Inputs	8 kbyte	8 kbyte	16 kbyte	16 kbyte
• Outputs	8 kbyte	8 kbyte	16 kbyte	16 kbyte
Process image				
• Inputs, adjustable	8 kbyte	8 kbyte	16 kbyte	16 kbyte
• Outputs, adjustable	8 kbyte	8 kbyte	16 kbyte	16 kbyte
<b>Hardware configuration</b>				
Slots				
• Required slots	2	2	2	2
<b>Time of day</b>				
Clock				
• Hardware clock (real-time clock)	Yes	Yes	Yes	Yes
Operating hours counter				
• Number	16	16	16	16
<b>1st interface</b>				
Interface type	integrated	integrated	integrated	integrated
Physics	RS 485 / PROFIBUS + MPI	RS 485 / PROFIBUS + MPI	RS 485 / PROFIBUS + MPI	RS 485 / PROFIBUS + MPI
Functionality				
• MPI	Yes	Yes	Yes	Yes
• DP master	Yes	Yes	Yes	Yes
• DP slave	No	No	No	No
DP master				
• Number of DP slaves, max.	32	32	32	32

## PROFINET/Industrial Ethernet

### Controllers / Modular controllers / SIMATIC S7-400

#### High-availability CPUs

#### Technical specifications (continued)

	6ES7412-5HK06-0AB0 CPU 412-5H PN/DP	6ES7414-5HM06-0AB0 CPU 414-5H PN/DP	6ES7416-5HS06-0AB0 CPU 416-5H PN/DP	6ES7417-5HT06-0AB0 CPU 417-5H PN/DP
<b>2nd interface</b>				
Interface type	PROFINET	PROFINET	PROFINET	PROFINET
Physics	Ethernet RJ45	Ethernet RJ45	Ethernet RJ45	Ethernet RJ45
Number of ports	2	2	2	2
Functionality				
• DP master	No	No	No	No
• DP slave	No	No	No	No
• PROFINET IO Controller	Yes	Yes	Yes	Yes
• PROFINET IO Device	No	No	No	No
• PROFINET CBA	No	No	No	No
PROFINET IO Controller				
• Max. number of connectable IO devices for RT	256	256	256	256
<b>3rd interface</b>				
Interface type	integrated	integrated	integrated	integrated
Physics	RS 485 / PROFIBUS	RS 485 / PROFIBUS	RS 485 / PROFIBUS	RS 485 / PROFIBUS
Functionality				
• DP master	Yes	Yes	Yes	Yes
• DP slave	No	No	No	No
DP master				
• Number of DP slaves, max.	64	96	125	125
<b>4th interface</b>				
Interface type	Pluggable synchronization submodule (FO)	Pluggable synchronization submodule (FO)	Pluggable synchronization submodule (FO)	Pluggable synchronization submodule (FO)
Plug-in interface modules	Synchronization modules 6ES7960-1AA06-0XA0 or 6ES7960-1AB06-0XA0	Synchronization modules 6ES7960-1AA06-0XA0 or 6ES7960-1AB06-0XA0	Synchronization modules 6ES7960-1AA06-0XA0 or 6ES7960-1AB06-0XA0	Synchronization modules 6ES7960-1AA06-0XA0 or 6ES7960-1AB06-0XA0
<b>5. Interface</b>				
Interface type	Pluggable synchronization submodule (FO)	Pluggable synchronization submodule (FO)	Pluggable synchronization submodule (FO)	Pluggable synchronization submodule (FO)
Plug-in interface modules	Synchronization modules 6ES7960-1AA06-0XA0 or 6ES7960-1AB06-0XA0	Synchronization modules 6ES7960-1AA06-0XA0 or 6ES7960-1AB06-0XA0	Synchronization modules 6ES7960-1AA06-0XA0 or 6ES7960-1AB06-0XA0	Synchronization modules 6ES7960-1AA06-0XA0 or 6ES7960-1AB06-0XA0
<b>Isochronous mode</b>				
Isochronous operation (application synchronized up to terminal)	No	No	No	No
<b>Communication functions</b>				
PG/OP communication	Yes	Yes	Yes	Yes
Data record routing	Yes	Yes	Yes	Yes
S7 routing	Yes	Yes	Yes	Yes
Global data communication				
• supported	No	No	No	No
S7 basic communication				
• supported	No	No	No	No
S7 communication				
• supported	Yes	Yes	Yes	Yes
S5-compatible communication				
• supported	Yes; (via CP max. 10 and FC AG_SEND and FC AG_RECV)	Yes; (via CP max. 10 and FC AG_SEND and FC AG_RECV)	Yes; (via CP max. 10 and FC AG_SEND and FC AG_RECV)	Yes; (via CP max. 10 and FC AG_SEND and FC AG_RECV)
Standard communication (FMS)				
• supported	Yes; Via CP and loadable FB	Yes; Via CP and loadable FB	Yes; Via CP and loadable FB	Yes; Via CP and loadable FB



### Technical specifications (continued)

	6ES7412-5HK06-0AB0 CPU 412-5H PN/DP	6ES7414-5HM06-0AB0 CPU 414-5H PN/DP	6ES7416-5HS06-0AB0 CPU 416-5H PN/DP	6ES7417-5HT06-0AB0 CPU 417-5H PN/DP
Open IE communication				
• TCP/IP	Yes; Via integrated PROFINET interface and loadable FBs	Yes; Via integrated PROFINET interface and loadable FBs	Yes; Via integrated PROFINET interface and loadable FBs	Yes; Via integrated PROFINET interface and loadable FBs
- Number of connections, max.	46	62	94	118
• ISO-on-TCP (RFC1006)	Yes; Via integrated PROFINET interface or CP 443-1 and loadable FBs	Yes; Via integrated PROFINET interface or CP 443-1 and loadable FBs	Yes; Via integrated PROFINET interface or CP 443-1 and loadable FBs	Yes; Via integrated PROFINET interface or CP 443-1 and loadable FBs
- Number of connections, max.	46	62	94	118
• UDP	Yes; Via integrated PROFINET interface and loadable FBs	Yes; Via integrated PROFINET interface and loadable FBs	Yes; Via integrated PROFINET interface and loadable FBs	Yes; Via integrated PROFINET interface and loadable FBs
- Number of connections, max.	46	62	94	118
Web server				
• supported	No	No	No	No
Number of connections				
• overall	48	64	96	120
<b>Configuration</b>				
programming				
• Programming language				
- LAD	Yes	Yes	Yes	Yes
- FBD	Yes	Yes	Yes	Yes
- STL	Yes	Yes	Yes	Yes
- SCL	Yes	Yes	Yes	Yes
- CFC	Yes	Yes	Yes	Yes
- GRAPH	Yes	Yes	Yes	Yes
- HiGraph®	Yes	Yes	Yes	Yes
Know-how protection				
• User program protection/password protection	Yes	Yes	Yes	Yes
• Block encryption	Yes; With S7 block Privacy	Yes; With S7 block Privacy	Yes; With S7 block Privacy	Yes; With S7 block Privacy
<b>Dimensions</b>				
Width	50 mm	50 mm	50 mm	50 mm
Height	290 mm	290 mm	290 mm	290 mm
Depth	219 mm	219 mm	219 mm	219 mm
<b>Weights</b>				
Weight, approx.	995 g	995 g	995 g	995 g

# PROFINET/Industrial Ethernet

## Controllers / Modular controllers / SIMATIC S7-400

### High-availability CPUs

Ordering data	Article No.	Article No.	
<b>CPU 412-5H</b> For S7-400H and S7-400F/FH; 1 MB RAM, 1 combined MPI/PROFIBUS DP master interface, 1 PROFIBUS DP interface, 2 PROFINET interfaces (switches), 2 slots for sync modules, slot for memory card, incl. slot number labels	<b>6ES7412-5HK06-0AB0</b>	<b>CPU 417-5H</b> For S7-400H and S7-400F/FH; 32 MB RAM, 1 combined MPI/PROFIBUS DP master interface, 1 PROFIBUS DP interface, 2 PROFINET interfaces (switches), 2 slots for sync modules, slot for memory card, incl. slot number labels	<b>6ES7417-5HT06-0AB0</b>
<b>CPU 412-5H system bundle</b> Not assembled, consisting of: UR2-H rack, 2 x PS 405/407 power supply units, 2 x CPU 412-5H, 4 x Sync modules (for max. 10 m), 2 x fiber optic cables for sync modules (1 m), 4 x backup batteries; additional two memory cards required (to be ordered separately)		<b>CPU 417-5H system bundle</b> Not assembled, consisting of: UR2-H rack, 2 x PS 405/407 power supply units, 2 x CPU 417-5H, 4 x Sync modules (for max. 10 m), 2 x fiber optic cables for sync modules (1 m), 4 x backup batteries; additional two memory cards required (to be ordered separately)	
<b>CPU 412-5H system bundle, 120/230 V AC, 10 A</b>	<b>6ES7400-0HR01-4AB0</b>	<b>CPU 417-5H system bundle, 120/230 V AC, 10 A</b>	<b>6ES7400-0HR04-4AB0</b>
<b>CPU 412-5H system bundle, 24/48/60 V DC, 10 A</b>	<b>6ES7400-0HR51-4AB0</b>	<b>CPU 417-5H system bundle, 24/48/60 V DC, 10 A</b>	<b>6ES7400-0HR54-4AB0</b>
<b>CPU 414-5H</b> For S7-400H and S7-400F/FH; 4 MB RAM, 1 combined MPI/PROFIBUS DP master interface, 1 PROFIBUS DP interface, 2 PROFINET interfaces (switches), 2 slots for sync modules, slot for memory card, incl. slot number labels	<b>6ES7414-5HM06-0AB0</b>	<b>Memory card RAM</b> 1 MB 2 MB 4 MB 8 MB 16 MB 64 MB	<b>6ES7952-1AK00-0AA0</b> <b>6ES7952-1AL00-0AA0</b> <b>6ES7952-1AM00-0AA0</b> <b>6ES7952-1AP00-0AA0</b> <b>6ES7952-1AS00-0AA0</b> <b>6ES7952-1AY00-0AA0</b>
<b>CPU 414-5H system bundle</b> Not assembled, consisting of: UR2-H rack, 2 x PS 405/407 power supply units, 2 x CPU 414-5H, 4 x Sync modules (for max. 10 m), 2 x fiber optic cables for sync modules (1 m), 4 x backup batteries; additional two memory cards required (to be ordered separately)		<b>FEPROM memory card</b> 1 MB 2 MB 4 MB 8 MB 16 MB 32 MB 64 MB	<b>6ES7952-1KK00-0AA0</b> <b>6ES7952-1KL00-0AA0</b> <b>6ES7952-1KM00-0AA0</b> <b>6ES7952-1KP00-0AA0</b> <b>6ES7952-1KS00-0AA0</b> <b>6ES7952-1KT00-0AA0</b> <b>6ES7952-1KY00-0AA0</b>
<b>CPU 414-5H system bundle, 120/230 V AC, 10 A</b>	<b>6ES7400-0HR02-4AB0</b>	<b>MPI cable</b> for connection of SIMATIC S7 and PG via MPI; 5 m in length	<b>6ES7901-0BF00-0AA0</b>
<b>CPU 414-5H system bundle, 24/48/60 V DC, 10 A</b>	<b>6ES7400-0HR52-4AB0</b>	<b>Slot number plates</b> 1 set (spare part)	<b>6ES7912-0AA00-0AA0</b>
<b>CPU 416-5H</b> For S7-400H and S7-400F/FH; 16 MB RAM, 1 combined MPI/PROFIBUS DP master interface, 1 PROFIBUS DP interface, 2 PROFINET interfaces (switches), 2 slots for sync modules, slot for memory card, incl. slot number labels	<b>6ES7416-5HS06-0AB0</b>	<b>S7 F Systems RT License</b> For processing safety-related user programs, for one S7-400H-based system each with CPU 412-5H, CPU 414-5H, CPU 416-5H or CPU 417-5H	<b>6ES7833-1CC00-6YX0</b>
<b>CPU 416-5H system bundle</b> Not assembled, consisting of: UR2-H rack, 2 x PS 405/407 power supply units, 2 x CPU 416-5H, 4 x Sync modules (for max. 10 m), 2 x fiber optic cables for sync modules (1 m), 4 x backup batteries; additional two memory cards required (to be ordered separately)		<b>S7 F Systems V6.1</b> Programming and configuring environment for creating and operating safety-related STEP 7 programs for an S7-400H-based target system, floating license for 1 user, runs under Windows XP Prof SP2, Windows XP Prof SP2/SP3, Windows Server 2003 SP2 2 languages (English, German) Type of delivery: Certificate of License as well as software and electronic documentation on CD	<b>6ES7833-1CC02-0YA5</b>
<b>CPU 416-5H system bundle, 120/230 V AC, 10 A</b>	<b>6ES7400-0HR03-4AB0</b>		
<b>CPU 416-5H system bundle, 24/48/60 V DC, 10 A</b>	<b>6ES7400-0HR53-4AB0</b>		

Ordering data	Article No.	Article No.
<b>S7 F systems upgrade from V5.x/V6.0 to V6.1</b> 2 languages (English, German), floating license for 1 user <i>Type of delivery:</i> Certificate of License as well as software and electronic documentation on CD	6ES7833-1CC02-0YE5	
<b>SIMATIC Manual Collection</b> Electronic manuals on DVD, multilingual: LOGO!, SIMADYN, SIMATIC bus components, SIMATIC C7, SIMATIC distributed I/O, SIMATIC HMI, SIMATIC Sensors, SIMATIC NET, SIMATIC PC Based Automation, SIMATIC PCS 7, SIMATIC PG/PC, SIMATIC S7, SIMATIC Software, SIMATIC TDC	6ES7998-8XC01-8YE0	
<b>SIMATIC Manual Collection update service for 1 year</b> Current "Manual Collection" DVD and the three subsequent updates	6ES7998-8XC01-8YE2	
<b>RS 485 bus connector with 90° cable outlet</b> Max. transfer rate 12 Mbit/s Without PG interface With PG interface	6ES7972-0BA12-0XA0 6ES7972-0BB12-0XA0	<b>RS 485 bus connector with angled cable outlet</b> Max. transfer rate 12 Mbit/s Without PG interface With PG interface Max. transfer rate 1.5 Mbit/s Without PG interface <b>Bus connector RS 485 with 90° cable outlet for FastConnect connection technology</b> Max. transfer rate 12 Mbit/s Without PG interface <ul style="list-style-type: none"> <li>• 1 unit</li> <li>• 100 units</li> </ul> With PG interface <ul style="list-style-type: none"> <li>• 1 unit</li> <li>• 100 units</li> </ul> <b>RS 485 bus connector with axial cable outlet</b> For SIMATIC OP, for connection to PPI, MPI, PROFIBUS
		6ES7972-0BA42-0XA0 6ES7972-0BB42-0XA0 6ES7972-0BA30-0XA0 6ES7972-0BA52-0XA0 6ES7972-0BA52-0XB0 6ES7972-0BB52-0XA0 6ES7972-0BB52-0XB0 6GK1500-0EA02 6XV1830-0EH10
		<b>PROFIBUS FastConnect bus cable</b> Standard type with special design for quick mounting, 2-core, shielded, sold by the meter, max. delivery unit 1000 m, minimum ordering quantity 20 m

# PROFINET/Industrial Ethernet Controllers / PC-based controllers

## SIMATIC WinAC RTX

### Overview

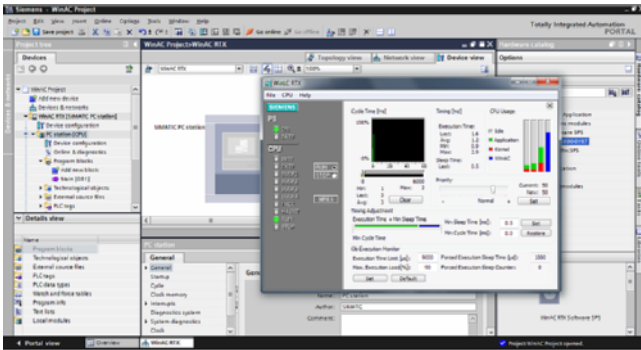

- SIMATIC WinAC RTX:  
Optimized for applications that require a high degree of flexibility and integration capability.
- The software solution for tasks that require hard deterministic behavior and high performance.
- With real-time expansion for assuring deterministic behavior for the control section.

New with WinAC RTX 2010 SP1:

- SIMATIC IPC427D and IPC477D are fully supported
  - Communication via onboard CP 5622
  - Retentive memory
  - LED display of the operating status
- Support for the new PROFIBUS CP 5612 (PCI) and CP 5622 (PCIe)

### Benefits

- Hard real time and maximum performance
- Implementation of fast, S7-compatible control solutions with low processor loading.  
Alongside the control task, sufficient processor capability is available for processing complex, demanding PC applications in parallel.

### Technical specifications

	6ES7671-0RC08-0YA0 SIMATIC WinAC RTX 2010
<b>General information</b>	
Firmware version	V4.6
<b>Memory</b>	
Type of memory	RAM
Work memory	
• integrated (for program)	4 Mbyte; Adjustable; depends on Non Paged Memory Pool
• integrated (for data)	4 Mbyte; Adjustable; depends on Non Paged Memory Pool
Load memory	
• integrated RAM, max.	8 Mbyte; Adjustable; depends on Non Paged Memory Pool
<b>CPU processing times</b>	
for bit operations, typ.	0.004 µs
for fixed point arithmetic, typ.	0.003 µs
for floating point arithmetic, typ.	0.004 µs
Reference platform	Pentium IV, 2.4 GHz
<b>CPU-blocks</b>	
DB	
• Number, max.	65 535
• Size, max.	64 kbyte
FB	
• Number, max.	65 536
• Size, max.	64 kbyte
FC	
• Number, max.	65 536; Limited only by RAM set for code
OB	
• Size, max.	64 kbyte
• Number of free cycle OBs	1
• Number of time alarm OBs	1
• Number of delay alarm OBs	1
• Number of time interrupt OBs	9
• Number of process alarm OBs	1
• Number of ODK OBs	3; OB 52-54
• Number of DPV1 alarm OBs	3; OB 55-57
• Number isochronous mode OBs	2; OB 61-62
• Number of startup OBs	2
• Number of asynchronous error OBs	7
• Number of synchronous error OBs	2

	6ES7671-0RC08-0YA0 SIMATIC WinAC RTX 2010
Nesting depth	
• per priority class	24
• additional within an error OB	24
<b>Counters, timers and their retentivity</b>	
S7 counter	
• Number	2 048
• Retentivity	
- adjustable	Yes
- lower limit	0
- upper limit	2 047
- preset	8
• Counting range	
- adjustable	Yes
- lower limit	0
- upper limit	999
IEC counter	
• present	Yes
• Type	SFB
• Number	Unlimited (limited only by RAM capacity)
S7 times	
• Number	2 048
• Retentivity	
- adjustable	Yes
- lower limit	0
- upper limit	2 047
• Time range	
- lower limit	10 ms
- upper limit	9 990 s
IEC timer	
• present	Yes
• Type	SFB
• Number	Unlimited (limited only by RAM capacity)

**Technical specifications (continued)**

	<b>6ES7671-0RC08-0YA0</b> <b>SIMATIC WinAC RTX 2010</b>	<b>6ES7671-0RC08-0YA0</b> <b>SIMATIC WinAC RTX 2010</b>
<b>Data areas and their retentivity</b>		
Retentivity without UPS and PS Extension Board	128 KB with SIMATIC IPC227D, IPC427C, IPC427D, HMI IPC277D, IPC477C, IPC477D; further SIMATIC IPCs on request	
Retentivity with UPS	all data	
Flag		
• Number, max.	16 kbyte	
• of which retentive	MB 0 to MB 16383	
• Retentivity preset	MB 0 to MB 15	
• Number of clock memories	8	
Data blocks		
• Number, max.	Limited only by available retentive memory (NVRAM, or file storage)	
• Size, max.	64 kbyte	
• Retentivity adjustable	Yes; via non-retain property on DB	
• Retentivity preset	Yes	
Local data		
• adjustable, max.	64 kbyte	
• preset	32 kbyte	
• per priority class, max.	61 440 byte	
<b>Address area</b>		
I/O address area		
• Inputs	16 kbyte	
• Outputs	16 kbyte	
• of which, distributed		
- DP interface, inputs	16 kbyte	
- DP interface, outputs	16 kbyte	
- PN interface, inputs	16 kbyte	
- PN interface, outputs	16 kbyte	
Process image		
• Inputs, adjustable	8 kbyte; 16 KB with STEP 7 V5.5 SP3 or higher	
• Outputs, adjustable	8 kbyte; 16 KB with STEP 7 V5.5 SP3 or higher	
• Inputs, default	512 byte	
• Outputs, default	512 byte	
Subprocess images		
• Number of subprocess images, max.	15	
Digital channels		
• Inputs	128 000	
• Outputs	128 000	
Analog channels		
• Inputs	8 000	
• Outputs	8 000	
<b>Hardware configuration</b>		
Submodules		
• Number of submodules, max	4	
• of which PROFIBUS, max.	4; Supported interfaces: see 1st and 2nd interface	
• of which Industrial Ethernet, max.	1; Supported interfaces: see 3rd and 4th interface	
Number of operable FMs and CPs (recommended)		
• FM	FM distributed: FM 350-1 / 350-2, FM 351, FM 352, FM 353, FM 355 / 355-2	
• CP, point-to-point	CP 340, CP 341 distributed	
• CP, LAN	Over PC CP	
<b>Time of day</b>		
Clock		
• Hardware clock (real-time clock)	Yes	
• battery-backed and synchronizable	Yes	
Operating hours counter		
• Number	8	
Clock synchronization		
• supported	Yes	
• to PC-CP, slave	Yes	
• on Ethernet via NTP	Yes	
<b>Interfaces</b>		
Number of USB interfaces	0	
<b>1st interface</b>		
Interface type	CP 5611, CP 5611-A2, CP 5612, CP 5621, CP 5622, integrated PROFIBUS interface of the SIMATIC PC	
Max. no. of simultaneously operable CPs	1	
Physics	RS 485 / PROFIBUS	
Isolated	Yes	
Power supply to interface (15 to 30 V DC), max.	does not exist	
Number of connection resources	8	
Functionality		
• MPI	No	
• DP master	Yes	
• DP slave	No	
DP master		
• Number of connections, max.	8	
• Transmission rate, max.	12 Mbit/s	
• Number of DP slaves, max.	64	
• Services		
- PG/OP communication	Yes	
- Routing	Yes	
- Global data communication	No	
- S7 basic communication	No	
- S7 communication	Yes	
- S7 communication, as client	Yes	
- S7 communication, as server	Yes	
- Equidistance mode support	Yes; Only in conjunction with isochronous mode	
- Isochronous mode	Yes	
- SYNC/FREEZE	Yes	
- Activation/deactivation of DP slaves	Yes	
- Direct data exchange (slave-to-slave communication)	Yes	
- DPV0	Yes	
- DPV1	Yes	
• Address area		
- Inputs, max.	16 kbyte	
- Outputs, max.	16 kbyte	
• User data per DP slave		
- Inputs, max.	244 byte	
- Outputs, max.	244 byte	

## PROFINET/Industrial Ethernet Controllers / PC-based controllers

### SIMATIC WinAC RTX

#### Technical specifications (continued)

	<b>6ES7671-0RC08-0YA0 SIMATIC WinAC RTX 2010</b>
<b>2nd interface</b>	
Interface type	CP 5613, CP 5613-A2, CP 5603, CP 5623
Max. no. of simultaneously operable CPs	4
Physics	RS 485 / PROFIBUS
Isolated	Yes
Functionality	
• MPI	No
• DP master	Yes
• DP slave	No
DP master	
• Number of connections, max.	50
• Transmission rate, max.	12 Mbit/s
• Number of DP slaves, max.	125
• Services	
- PG/OP communication	Yes
- Routing	Yes
- Global data communication	No
- S7 basic communication	No
- S7 communication	Yes
- S7 communication, as client	Yes
- S7 communication, as server	Yes
- Equidistance mode support	Yes; Only in conjunction with isochronous mode
- Isochronous mode	Yes
- SYNC/FREEZE	Yes
- Activation/deactivation of DP slaves	Yes
- Direct data exchange (slave-to-slave communication)	Yes
- DPV0	Yes
- DPV1	Yes
• Address area	
- Inputs, max.	16 kbyte
- Outputs, max.	16 kbyte
• User data per DP slave	
- Inputs, max.	244 byte
- Outputs, max.	244 byte
<b>3rd interface</b>	
Interface type	PROFINET
Max. no. of simultaneously operable CPs	1; Intel Pro/1000 (82573L, 82574L, 82541PI; non-shared IRQ required); integrated IE interface SIMATIC PC 4x7B, 6x7B, 8x7B, IPC4x7C, IPC6x7C, IPC8x7C, IPC2x7D, IPC4x7D
Physics	Ethernet
Isolated	Yes
Integrated switch	No
Number of ports	1
Automatic detection of transmission speed	Yes; 10/100 Mbit/s
Autonegotiation	Yes
Autocrossing	Yes
Media redundancy	
• supported	No
Functionality	
• PROFINET IO Controller	Yes
• PROFINET IO Device	No
• PROFINET CBA	Yes
• Open IE communication	Yes

	<b>6ES7671-0RC08-0YA0 SIMATIC WinAC RTX 2010</b>
PROFINET IO Controller	
• Transmission rate, min.	100 Mbit/s
• Transmission rate, max.	100 Mbit/s
• Max. number of connectable IO devices for RT	128
- of which in line, max.	128
• IRT, supported	No
• Prioritized startup supported	Yes
- Number of IO Devices, max.	32
• Activation/deactivation of IO Devices	Yes
- Maximum number of IO devices that can be activated/deactivated at the same time.	8
• IO Devices changing during operation (partner ports), supported	Yes
• Device replacement without swap medium	Yes
• Send cycles	1 ms
• Updating time	1 - 512 ms (minimum value depends on communication share set for PROFINET I/O, on the number of I/O devices, and on the volume of configured user data)
• Services	
- PG/OP communication	Yes
- Routing	Yes; S7 routing
- S7 communication	Yes
- Isochronous mode	No
- Open IE communication	Yes
• Address area	
- Inputs, max.	16 kbyte
- Outputs, max.	16 kbyte
- User data per address area, max.	2 kbyte
- User data consistency, max.	254 byte
PROFINET CBA	
• acyclic transmission	Yes
• Cyclic transmission	Yes
SIMATIC communication	
• PG/OP communication	Yes
• S7 routing	Yes
• S7 communication	Yes
• Number of connections, max.	16
Open IE communication	
• Open IE communication, supported	Yes
• Number of connections, max.	32
• Local port numbers used at the system end	0, 20, 21, 23, 25, 80, 102, 135, 161, 443, 8080, 34962, 34963, 34964, 65532, 65533, 65534, 65535
• Keep-alive function, supported	Yes
<b>4th interface</b>	
Interface type	PROFINET
Max. no. of simultaneously operable CPs	1
Physics	Ethernet
Isolated	Yes
Integrated switch	Yes
Number of ports	3
Automatic detection of transmission speed	Yes; 10/100 Mbit/s
Autonegotiation	Yes
Autocrossing	Yes
Change of IP address at runtime, supported	Yes
Number of connection resources	32

**Technical specifications (continued)**

6ES7671-0RC08-0YA0 SIMATIC WinAC RTX 2010	
Media redundancy	
• supported	Yes
• Switchover time on line break, typically	200 ms
• Number of stations in the ring, max.	50
Functionality	
• PROFINET IO Controller	Yes
• PROFINET IO Device	No
• PROFINET CBA	Yes
• Open IE communication	Yes
• Web server	Yes
PROFINET IO Controller	
• Transmission rate, max.	100 Mbit/s
• Max. number of connectable IO devices for RT	256
- of which in line, max.	256
• Number of IO devices with IRT and the option "high flexibility"	64
- of which in line, max.	32
• Number of IO Devices with IRT and the option "high performance", max.	64
- of which in line, max.	32
• IRT, supported	Yes
• Prioritized startup supported	Yes
- Number of IO Devices, max.	32
• Activation/deactivation of IO Devices	Yes
- Maximum number of IO devices that can be activated/deactivated at the same time.	8
• IO Devices changing during operation (partner ports), supported	Yes
• Device replacement without swap medium	Yes
• Send cycles	250 µs, 500 µs, 1 ms
• Updating time	0.25...512 depending on the send cycle
• Services	
- PG/OP communication	Yes
- Routing	Yes; S7 routing
- S7 communication	Yes
- Isochronous mode	Yes
- Open IE communication	Yes
• Address area	
- Inputs, max.	16 kbyte
- Outputs, max.	16 kbyte
- User data per address area, max.	2 kbyte
- User data consistency, max.	254 byte
SIMATIC communication	
• PG/OP communication	Yes
• S7 routing	Yes
• S7 communication	Yes
• Number of connections, max.	32
Open IE communication	
• Open IE communication, supported	Yes
• Number of connections, max.	32
• Local port numbers used at the system end	0, 20, 21, 25, 80, 102, 135, 161, 34962, 34963, 34964, 65532, 65533, 65534, 65535
<b>Isochronous mode</b>	
Isochronous operation (application synchronized up to terminal)	Yes
Number of DP masters with isochronous mode	2
User data per isochronous slave, max.	128 byte
equidistance	Yes
shortest clock pulse	2.2 ms; 2.2 ms without partial process image; 2.2 ms with partial process image

6ES7671-0RC08-0YA0 SIMATIC WinAC RTX 2010	
<b>Communication functions</b>	
PG/OP communication	Yes
Data record routing	Yes; Only with CP 5611 or integrated PROFIBUS interface of the SIMATIC PC
Global data communication	
• supported	No
S7 basic communication	
• supported	No
S7 communication	
• supported	Yes
• as server	Yes
• As client	Yes
• User data per job, max.	64 kbyte; When using BSEND/USEND
Open IE communication	
• TCP/IP	Yes
- Number of connections, max.	32
- Data length for connection type 01H, max.	Not supported
- Data length for connection type 11H, max.	65 534 byte
- Data length, max.	65 534 byte
• ISO-on-TCP (RFC1006)	Yes
- Number of connections, max.	32
- Data length, max.	65 534 byte
• UDP	Yes
- Number of connections, max.	32
- Data length, max.	1 472 byte
Web server	
• supported	Yes
• Number of HTTP clients	2
• User-defined websites	No
PROFINET CBA (at set setpoint communication load)	
• Setpoint for the CPU communication load	20 %
• Number of remote interconnection partners	64
• Number of functions, master/slave	30
• Total of all Master/Slave connections	1 000
• Data length of all incoming connections master/slave, max.	6 800 byte
• Data length of all outgoing connections master/slave, max.	6 800 byte
• Number of device-internal and PROFIBUS interconnections	500
• Data length of device-internal and PROFIBUS interconnections, max.	4 000 byte
• Data length per connection, max.	1 400 byte
• Remote interconnections with acyclic transmission	
- Sampling frequency: Sampling time, min.	500 ms
- Number of incoming interconnections	100
- Number of outgoing interconnections	100
- Data length of all incoming interconnections, max.	2 000 byte
- Data length of all outgoing interconnections, max.	2 000 byte
- Data length per connection, max.	1 400 byte

# PROFINET/Industrial Ethernet Controllers / PC-based controllers

## SIMATIC WinAC RTX

### Technical specifications (continued)

6ES7671-0RC08-0YAO SIMATIC WinAC RTX 2010	
• Remote interconnections with cyclic transmission	
- Transmission frequency: Transmission interval, min.	10 ms
- Number of incoming interconnections	200
- Number of outgoing interconnections	200
- Data length of all incoming interconnections, max.	4 800 byte
- Data length of all outgoing interconnections, max.	4 800 byte
- Data length per connection, max.	250 byte
• HMI variables via PROFINET (acyclic)	
- Number of stations that can log on for HMI variables (PN OPC/IMap)	3
- HMI variable updating	500 ms
- Number of HMI variables	200
- Data length of all HMI variables, max.	2 000 byte
• PROFIBUS proxy functionality	
- supported	Yes
- Number of linked PROFIBUS devices	16
- Data length per connection, max.	240 byte; Slave-dependent
Number of connections	
• overall	96
• usable for PG communication	
- reserved for PG communication	1
• usable for OP communication	
- reserved for OP communication	1
<b>S7 message functions</b>	
Number of login stations for message functions, max.	62
SCAN procedure	No
Process diagnostic messages	Yes; ALARM_S, ALARM_SQ, ALARM_D, ALARM_DQ
simultaneously active Alarm-S blocks, max.	20; of a total of 20 for all SFCs
Alarm 8-blocks	Yes
• Number of instances for alarm 8 and S7 communication blocks, max.	4 000
Process control messages	No
Number of archives that can log on simultaneously (SFB 37 AR_SEND)	32
<b>Test commissioning functions</b>	
Status block	Yes
Single step	Yes
Number of breakpoints	20
Status/control	
• Status/control variable	Yes
Forcing	
• Forcing	No
Diagnostic buffer	
• present	Yes
• Number of entries, max.	
- adjustable	Yes
- preset	120
<b>Hardware requirements</b>	
Hardware required	PC with color monitor, keyboard, mouse or pointing device for Windows
Main memory, min.	1 Gbyte; WES7: 2 GB
Required memory on hard disk, min.	100 Mbyte
Processor	Intel Celeron M, 900 MHz or compatible
• Multi-processor system	Yes; Dual Pentium, CoreDuo, Core2Duo or compatible
• Hyper-threading	Yes

6ES7671-0RC08-0YAO SIMATIC WinAC RTX 2010	
<b>Operating systems</b>	
Windows CE	No
Windows NT 4.0	No
Windows 2000	No
Windows XP	Yes; Professional, SP2 and SP3
Windows XP embedded	Yes; With the delivery image of the SIMATIC PC
• Supported HAL types under Windows XP	ACPI uniprocessor PC, ACPI multiprocessor PC, MPS multiprocessor PC
Windows Vista	No
Windows 7	Yes; Professional, Enterprise, Ultimate (only 32 bits)
Windows embedded Standard 7	Yes; With the delivery image of the SIMATIC PC
<b>Configuration</b>	
Configuration software	
• STEP 7	Yes; V5.5 and higher, Engineering Tools (optional)
programming	
• Nesting levels	8
• Programming language	
- LAD	Yes
- FBD	Yes
- STL	Yes
- SCL	Yes
- CFC	Yes
- GRAPH	Yes
- HiGraph®	Yes
• Software libraries	
- Easy Motion Control	Yes
- Software redundancy	Yes; As of V1.2, only operation of WinAC RTX with WinAC RTX
• Number of simultaneously active SFCs	
- DPSYC_FR	20; of a total of 20 for all SFCs
- D_ACT_DP	20; of a total of 20 for all SFCs
- RD_REC	20; of a total of 20 for all SFCs
- WR_REC	20; of a total of 20 for all SFCs
- WR_PARM	20; of a total of 20 for all SFCs
- PARM_MOD	20; of a total of 20 for all SFCs
- WR_DPARM	20; of a total of 20 for all SFCs
- DPNRM_DG	20; of a total of 20 for all SFCs
- RDSYSST	20; of a total of 20 for all SFCs
• Number of simultaneously active SFBs	
- RD_REC	20; of a total of 20 for all SFBs
- WR_REC	20; of a total of 20 for all SFBs
Know-how protection	
• User program protection/password protection	Yes
• Block encryption	No
Open Development interfaces	
• CCX (Custom Code Extension)	Yes; WinAC ODK V4.2 or higher
• CMI (Controller Management Interface)	Yes; WinAC ODK V4.2 or higher
• SMX (Shared Memory Extension)	Yes; WinAC ODK V4.2 or higher
- Inputs	4 kbyte
- Outputs	4 kbyte
<b>I/O/Options</b>	
I/O devices	none
• Printer	No
<b>Weights</b>	
Weight, approx.	100 g; Weight incl. packaging



Ordering data	Article No.
<b>SIMATIC WinAC RTX 2010</b> Software PLC for PC-based automation tasks with stringent deterministic requirements; PROFIBUS and PROFINET; CD-ROM with electronic documentation d, e, f; single license, executable under Windows XP SP2 and SP3 as well as Windows 7 (32 bit)	<b>6ES7671-0RC08-0YA0</b>
<b>SIMATIC WinAC RTX 2010 Upgrade</b> For upgrading from basic/RTX V3.x, V4.0, V4.1 2005, 2008 and 2009; single license, executable under Windows XP SP2 and SP3 and Windows 7 (32 bit)	<b>6ES7671-0RC08-0YE0</b>
<b>CP 5612 communications processor</b> PCI card (32 bit) for connection of a programming device or PC to PROFIBUS	<b>6GK1561-2AA00</b>
<b>CP 5622 communications processor</b> PCI Express x1 card (32 bit) for connection of a programming device or PC to PROFIBUS	<b>6GK1562-2AA00</b>
<b>CP 5603 Microbox Package</b> Comprising CP 5603 module and Microbox expansion rack	<b>6GK1560-3AU00</b>
<b>CP 5613 A2 communications processor</b> PCI card (32 bit; 3.3 V/5 V) for connection to PROFIBUS incl. DP-Base software with NCM PC; DP-RAM interface for DP master, incl. PG and FDL protocol; single license for 1 installation, runtime software, software and electronic manual on CD-ROM, Class A, for 32 bit Windows 2000 Professional/Server, Windows XP Professional, German/English	<b>6GK1561-3AA01</b>
<b>CP 5623 communications processor</b> PCI Express x1 card (32 bit) for connection to PROFIBUS incl. DP-Base software with NCM PC; DP-RAM interface for DP master or DP slave, incl. PG and FDL protocols; single license for 1 installation, runtime software, software and electronic manual on CD-ROM, Class A, for operating system support see SIMATIC NET software; German/English	<b>6GK1562-3AA00</b>
<b>CP 1616 communications processor</b> PCI Card (32 bit; 3.3/5 V universal key) with ASIC ERTEC 400 for connecting PCs to PROFINET IO with 4-port real-time switch (RJ45); incl. IO-Base software for PROFINET IO controller (RT operation) and NCM PC; single license for one installation, runtime software, software and electronic manual on CD-ROM, Class A, for 32 bit Windows XP Professional; German/English	<b>6GK1161-6AA02</b>

## More information

### Add-ons for SIMATIC WinAC

PC-based Competence Center Cologne

Our add-ons supplement the WinAC RTX soft PLC by useful functions which have arisen in the context of projects. You can thus fully utilize the advantages of PC-based automation.

The applications are available in the form of function blocks and are easy to use without special programming knowledge.

Detailed information and prices can be obtained from your Siemens contact or from:

Contact:

Siemens AG  
 Competence Center Cologne  
 E-mail: [CCCologne@siemens.com](mailto:CCCologne@siemens.com)

Application	Function
WinAC serial driver	Communication over serial interfaces
WinAC PC IO driver	Access to central I/O expansion PC IO including interrupt handling
WinAC SQL	Access to SQL databases
WinAC TCP/IP driver	Data exchange between WinAC and other communication partners over Windows interface using TCP/IP, UDP, or ISO-on-TCP
WinAC OPC Client	Access to various OPC servers
WinAC Shutdown	Controlled shutdown of WinAC and PC system
WinAC File-I/O	Reading and writing of DBs as file on the PC system
WinAC Command	Calling of batch commands from WinAC
WinAC Access-DB	High-performance access to DBs, bit memories or I/O image
WinAC SMX Cover	Provision of SMX functions, e.g. for Delphi or VB
WinAC CMI Wrapper	Simple program-based operation of WinAC

### Brochures

Information material for downloading can be found in the Internet:

<http://www.siemens.com/simatic/printmaterial>

## PROFINET/Industrial Ethernet Controllers / PC-based controllers

### SIMATIC WinAC RTX F

#### Overview



- SIMATIC WinAC RTX F: Optimized for applications that demand a high degree of flexibility and integration capability and that must also satisfy safety requirements up to SIL 3 (IEC 61508).
- The software solution for tasks that require hard deterministic behavior and high performance.
- With real-time expansion for assuring deterministic behavior for the control section.
- Distributed I/O can be connected over PROFIBUS and/or PROFINET, also safety-related over PROFI-safe.

New:

- SIMATIC IPC427D and IPC477D are fully supported
  - Communication via onboard CP 5622
  - Retentive memory
  - LED display of the operating status
- Support for the new PROFIBUS CP 5612 (PCI) and CP 5622 (PCIe)

#### Benefits

- Hard real-time and maximum performance up to SIL 3 according to IEC 61508/62061 or according to EN ISO 13849-1 up to PL e
- Implementation of fast, S7-compatible control solutions with low processor loading. Alongside the control task, sufficient processor capability is available for processing complex, demanding PC applications in parallel.

#### Technical specifications

	6ES7671-1RC08-0YA0 SIMATIC WinAC RTX F 2010
<b>General information</b>	
Hardware product version	-
Firmware version	V4.6
Engineering with	
• Programming package	STEP 7 V5.5 or higher + hardware update / iMap V3.0 SP1 / option package S7 Distributed Safety V5.4 + SP5 / S7 F Configuration Pack V5.5 + SP6 + HF1
<b>Memory</b>	
Type of memory	RAM
Work memory	
• integrated (for program)	4 Mbyte; Adjustable; depends on Non Paged Memory Pool
• integrated (for data)	4 Mbyte; Adjustable; depends on Non Paged Memory Pool
Load memory	
• integrated RAM, max.	Adjustable; depends on Non Paged Memory Pool
<b>CPU processing times</b>	
for bit operations, typ.	0.004 µs
for fixed point arithmetic, typ.	0.003 µs
for floating point arithmetic, typ.	0.004 µs
Reference platform	Pentium IV, 2.4 GHz
<b>CPU-blocks</b>	
DB	
• Number, max.	65 535; Limited only by RAM set for code
• Size, max.	64 kbyte

	6ES7671-1RC08-0YA0 SIMATIC WinAC RTX F 2010
<b>FB</b>	
• Number, max.	65 536; Limited only by RAM set for code
• Size, max.	64 kbyte
<b>FC</b>	
• Number, max.	65 536; Limited only by RAM set for code
• Size, max.	64 kbyte
<b>OB</b>	
• Size, max.	64 kbyte
• Number of free cycle OBs	1
• Number of time alarm OBs	1
• Number of delay alarm OBs	1
• Number of time interrupt OBs	9
• Number of process alarm OBs	1
• Number of ODK OBs	3; OB 52-54
• Number of DPV1 alarm OBs	3; OB 55-57
• Number isochronous mode OBs	2; OB 61-62
• Number of startup OBs	2
• Number of asynchronous error OBs	7
• Number of synchronous error OBs	2
<b>Nesting depth</b>	
• per priority class	24
• additional within an error OB	24

**Technical specifications (continued)**

	6ES7671-1RC08-0YA0 SIMATIC WinAC RTX F 2010	6ES7671-1RC08-0YA0 SIMATIC WinAC RTX F 2010	
<b>Counters, timers and their retentivity</b>		<b>Address area</b>	
S7 counter		I/O address area	
• Number	2 048	• Inputs	16 kbyte
• Retentivity		• Outputs	16 kbyte
- adjustable	Yes	• of which, distributed	
- lower limit	0	- DP interface, inputs	16 kbyte
- upper limit	2 047	- DP interface, outputs	16 kbyte
- preset	8	- PN interface, inputs	16 kbyte
• Counting range		- PN interface, outputs	16 kbyte
- adjustable	Yes		
- lower limit	0	Process image	
- upper limit	999	• Inputs, adjustable	8 kbyte
IEC counter		• Outputs, adjustable	8 kbyte
• present	Yes	• Inputs, default	512 byte
• Type	SFB	• Outputs, default	512 byte
• Number	Unlimited (limited only by RAM capacity)	Subprocess images	
S7 times		• Number of subprocess images, max.	15
• Number	2 048	Digital channels	
• Retentivity		• Inputs	128 000
- adjustable	Yes	• Outputs	128 000
- lower limit	0	Analog channels	
- upper limit	2 047	• Inputs	8 000
- preset	0	• Outputs	8 000
• Time range		<b>Hardware configuration</b>	
- lower limit	10 ms	Submodules	
- upper limit	9 990 s	• Number of submodules, max	4
IEC timer		• of which PROFIBUS, max.	4; Supported interfaces: see 1st and 2nd interface
• present	Yes	• of which Industrial Ethernet, max.	1; Supported interfaces: see 3rd and 4th interface
• Type	SFB	Number of operable FMs and CPs (recommended)	
• Number	Unlimited (limited only by RAM capacity)	• FM	4; FM distributed: FM 350-1, FM 350-2, FM 351, FM 352 / FM 352-5, FM 353, FM 354, FM 355, FM 355-2
<b>Data areas and their retentivity</b>		• CP, point-to-point	2; CP 340, CP 341 distributed
Retentivity without UPS and PS Extension Board	128 kbyte with SIMATIC IPC427C and HMI IPC477C; further SIMATIC PCs on request	• CP, LAN	Over PC CP
Retentivity with UPS	all data	<b>Time of day</b>	
Flag		Clock	
• Number, max.	16 kbyte	• Hardware clock (real-time clock)	Yes
• of which retentive	MB 0 to MB 16383	• battery-backed and synchronizable	Yes
• Retentivity preset	MB 0 to MB 15	Operating hours counter	
• Number of clock memories	8	• Number	8
Data blocks		Clock synchronization	
• Number, max.	Limited only by available retentive memory (NVRAM, or file storage)	• supported	Yes
• Size, max.	64 kbyte	• to PC-CP, slave	Yes
• Retentivity adjustable	Yes; via non-retain property on DB	• on Ethernet via NTP	Yes
• Retentivity preset	Yes		
Local data			
• adjustable, max.	64 kbyte		
• preset	32 kbyte		
• per priority class, max.	61 440 byte		

## PROFINET/Industrial Ethernet Controllers / PC-based controllers

### SIMATIC WinAC RTX F

#### Technical specifications (continued)

6ES7671-1RC08-0YA0 SIMATIC WinAC RTX F 2010	
<b>Interfaces</b>	
With optical interface	No
<b>1st interface</b>	
Interface type	CP 5611-A2, CP 5621, integrated PB interface of the SIMATIC PC
Max. no. of simultaneously operable CPs	1
Physics	RS 485 / PROFIBUS
Isolated	Yes
Power supply to interface (15 to 30 V DC), max.	does not exist
Number of connection resources	8
<b>Functionality</b>	
• MPI	No
• DP master	Yes
• DP slave	No
<b>DP master</b>	
• Number of connections, max.	8
• Transmission rate, max.	12 Mbit/s
• Number of DP slaves, max.	64
• Services	
- PG/OP communication	Yes
- Routing	Yes
- Global data communication	No
- S7 basic communication	No
- S7 communication	Yes
- S7 communication, as client	Yes
- S7 communication, as server	Yes
- Equidistance mode support	Yes; Only in conjunction with isochronous mode
- Isochronous mode	Yes
- SYNC/FREEZE	Yes
- Activation/deactivation of DP slaves	Yes
- Direct data exchange (slave-to-slave communication)	Yes
- DPV0	Yes
- DPV1	Yes
• Address area	
- Inputs, max.	16 kbyte
- Outputs, max.	16 kbyte
• User data per DP slave	
- Inputs, max.	244 byte
- Outputs, max.	244 byte

6ES7671-1RC08-0YA0 SIMATIC WinAC RTX F 2010	
<b>2nd interface</b>	
Interface type	CP 5613, CP 5613-A2, CP 5603, CP 5623
Max. no. of simultaneously operable CPs	4
Physics	RS 485 / PROFIBUS
Isolated	Yes
<b>Functionality</b>	
• MPI	No
• DP master	Yes
• DP slave	No
<b>DP master</b>	
• Number of connections, max.	50
• Transmission rate, max.	12 Mbit/s
• Number of DP slaves, max.	125
• Services	
- PG/OP communication	Yes
- Routing	Yes
- Global data communication	No
- S7 basic communication	No
- S7 communication	Yes
- S7 communication, as client	Yes
- S7 communication, as server	Yes
- Equidistance mode support	Yes; Only in conjunction with isochronous mode
- Isochronous mode	Yes
- SYNC/FREEZE	Yes
- Activation/deactivation of DP slaves	Yes
- Direct data exchange (slave-to-slave communication)	Yes
- DPV0	Yes
- DPV1	Yes
• Address area	
- Inputs, max.	16 kbyte
- Outputs, max.	16 kbyte
• User data per DP slave	
- Inputs, max.	244 byte
- Outputs, max.	244 byte
<b>3rd interface</b>	
Interface type	PROFINET
Max. no. of simultaneously operable CPs	1; Intel Pro/1000 (Intel 82571EB, 82573L, 82574L, 82541PI); non-shared IRQ required); integrated IE interface SIMATIC PC 4x7B, 6x7B, 8x7B, IPC4x7C, IPC6x7C, IPC8x7C
Physics	Ethernet
Isolated	Yes
Integrated switch	No
Number of ports	1
Automatic detection of transmission speed	Yes; 10/100 Mbit/s
Autonegotiation	Yes
Autocrossing	Yes
<b>Media redundancy</b>	
• supported	No

**Technical specifications (continued)**

6ES7671-1RC08-0YA0 SIMATIC WinAC RTX F 2010		6ES7671-1RC08-0YA0 SIMATIC WinAC RTX F 2010	
Functionality		<b>4th interface</b>	
• PROFINET IO Controller	Yes	Interface type	PROFINET
• PROFINET IO Device	No	Max. no. of simultaneously operable CPs	1
• PROFINET CBA	Yes	Physics	Ethernet
• Open IE communication	Yes	Isolated	Yes
PROFINET IO Controller		Integrated switch	Yes
• Transmission rate, min.	100 Mbit/s	Number of ports	3
• Transmission rate, max.	100 Mbit/s	Automatic detection of transmission speed	Yes; 10/100 Mbit/s
• Number of connectable IO devices, max.	128	Autonegotiation	Yes
• Max. number of connectable IO devices for RT	128	Autocrossing	Yes
- of which in line, max.	128	Change of IP address at runtime, supported	Yes
• IRT, supported	No	Number of connection resources	32
• Prioritized startup supported	Yes	Media redundancy	
- Number of IO Devices, max.	32	• supported	Yes
• Activation/deactivation of IO Devices	Yes	• Switchover time on line break, typically	200 ms
- Maximum number of IO devices that can be activated/deactivated at the same time.	8	• Number of stations in the ring, max.	50
• IO Devices changing during operation (partner ports), supported	Yes	Functionality	
• Device replacement without swap medium	Yes	• PROFINET IO Controller	Yes
• Send cycles	1 ms	• PROFINET IO Device	No
• Updating time	1 - 512 ms (minimum value depends on communication share set for PROFINET I/O, on the number of I/O devices, and on the volume of configured user data)	• PROFINET CBA	Yes
• Services		• Open IE communication	Yes
- PG/OP communication	Yes	• Web server	Yes
- Routing	Yes; S7 routing	PROFINET IO Controller	
- S7 communication	Yes	• Transmission rate, max.	100 Mbit/s
- Isochronous mode	No	• Max. number of connectable IO devices for RT	256
- Open IE communication	Yes	- of which in line, max.	256
• Address area		• Number of IO devices with IRT and the option "high flexibility"	64
- Inputs, max.	16 kbyte	- of which in line, max.	32
- Outputs, max.	16 kbyte	• Number of IO Devices with IRT and the option "high performance", max.	64
- User data per address area, max.	2 kbyte	- of which in line, max.	64
- User data consistency, max.	254 byte	• IRT, supported	Yes
PROFINET CBA		• Prioritized startup supported	Yes
• acyclic transmission	Yes	- Number of IO Devices, max.	32
• Cyclic transmission	Yes	• Activation/deactivation of IO Devices	Yes
SIMATIC communication		- Maximum number of IO devices that can be activated/deactivated at the same time.	8
• PG/OP communication	Yes	• IO Devices changing during operation (partner ports), supported	Yes
• S7 routing	Yes	• Device replacement without swap medium	Yes
• S7 communication	Yes	• Send cycles	250 µs, 500 µs, 1 ms
• Number of connections, max.	16	• Updating time	0.25...512 depending on the send cycle
Open IE communication		• Services	
• Open IE communication, supported	Yes	- PG/OP communication	Yes
• Number of connections, max.	32	- Routing	Yes; S7 routing
• Local port numbers used at the system end	0, 20, 21, 23, 25, 80, 102, 135, 161, 8080, 34962, 34963, 34964, 65532, 65533, 65534, 65535	- S7 communication	Yes
• Keep-alive function, supported	Yes	- Isochronous mode	Yes
		- Open IE communication	Yes

## PROFINET/Industrial Ethernet Controllers / PC-based controllers

### SIMATIC WinAC RTX F

#### Technical specifications (continued)

6ES7671-1RC08-0YAO SIMATIC WinAC RTX F 2010	
• Address area	
- Inputs, max.	16 kbyte
- Outputs, max.	16 kbyte
- User data per address area, max.	2 kbyte
- User data consistency, max.	254 byte
SIMATIC communication	
• PG/OP communication	Yes
• S7 routing	Yes
• S7 communication	Yes
• Number of connections, max.	32
Open IE communication	
• Open IE communication, supported	Yes
• Number of connections, max.	32
• Local port numbers used at the system end	0, 20, 21, 25, 80, 102, 135, 161, 34962, 34963, 34964, 65532, 65533, 65534, 65535
<b>Isochronous mode</b>	
Isochronous operation (application synchronized up to terminal)	Yes
Number of DP masters with isochronous mode	2
User data per isochronous slave, max.	128 byte
Equidistance	Yes
Shortest clock pulse	2.2 ms; 2.2 ms without partial process image; 2.2 ms with partial process image
<b>Communication functions</b>	
PG/OP communication	Yes
Data record routing	Yes; Only with CP 5611 or integrated PROFIBUS interface of the SIMATIC PC
Global data communication	
• supported	No
S7 basic communication	
• supported	No
S7 communication	
• supported	Yes
• as server	Yes
• As client	Yes
• User data per job, max.	64 kbyte; Depends on which block is used: BSEND/USEND or PUT/GET
Open IE communication	
• TCP/IP	Yes
- Number of connections, max.	32
- Data length for connection type 01H, max.	Not supported
- Data length for connection type 11H, max.	65 534 byte
- Data length, max.	65 534 byte
• ISO-on-TCP (RFC 1006)	Yes
- Number of connections, max.	32
- Data length, max.	65 534 byte
• UDP	Yes
- Number of connections, max.	32
- Data length, max.	1 472 byte
Web server	
• Supported	Yes
• Number of HTTP clients	2
• User-defined websites	No

6ES7671-1RC08-0YAO SIMATIC WinAC RTX F 2010	
PROFINET CBA (at set setpoint communication load)	
• Setpoint for the CPU communication load	20 %
• Number of remote interconnection partners	64
• Number of functions, master/slave	30
• Total of all Master/Slave connections	1 000
• Data length of all incoming connections master/slave, max.	6 800 byte
• Data length of all outgoing connections master/slave, max.	6 800 byte
• Number of device-internal and PROFIBUS interconnections	500
• Data length of device-internal and PROFIBUS interconnections, max.	4 000 byte
• Data length per connection, max.	1 400 byte
• Remote interconnections with acyclic transmission	
- Sampling frequency: Sampling time, min.	500 ms
- Number of incoming interconnections	100
- Number of outgoing interconnections	100
- Data length of all incoming interconnections, max.	2 000 byte
- Data length of all outgoing interconnections, max.	2 000 byte
- Data length per connection, max.	1 400 byte
• Remote interconnections with cyclic transmission	
- Transmission frequency: Transmission interval, min.	10 ms
- Number of incoming interconnections	200
- Number of outgoing interconnections	200
- Data length of all incoming interconnections, max.	4 800 byte
- Data length of all outgoing interconnections, max.	4 800 byte
- Data length per connection, max.	250 byte
• HMI variables via PROFINET (acyclic)	
- Number of stations that can log on for HMI variables (PN OPC/iMap)	3
- HMI variable updating	500 ms
- Number of HMI variables	200
- Data length of all HMI variables, max.	2 000 byte
• PROFIBUS proxy functionality	
- supported	Yes
- Number of linked PROFIBUS devices	16
- Data length per connection, max.	240 byte; Slave-dependent
Number of connections	
• overall	96
• usable for PG communication	
- reserved for PG communication	1
• usable for OP communication	
- reserved for OP communication	1

**Technical specifications (continued)**

6ES7671-1RC08-0YA0 SIMATIC WinAC RTX F 2010	
<b>S7 message functions</b>	
Number of login stations for message functions, max.	62
SCAN procedure	No
Process diagnostic messages	Yes; ALARM_S, ALARM_SQ, ALARM_D, ALARM_DQ
simultaneously active Alarm-S blocks, max.	20; of a total of 20 for all SFCs
Alarm 8-blocks	Yes
• Number of instances for alarm 8 and S7 communication blocks, max.	4 000
Process control messages	No
<b>Test commissioning functions</b>	
Status block	Yes
Single step	Yes
Number of breakpoints	20
Status/control	
• Status/control variable	Yes
Forcing	
• Forcing	No
Diagnostic buffer	
• present	Yes
• Number of entries, max.	
- adjustable	Yes
- preset	120
<b>Hardware requirements</b>	
Hardware required	PC with color monitor, keyboard, mouse or pointing device for Windows
Main memory, min.	1 Gbyte
Required memory on hard disk, min.	100 Mbyte
Processor	Intel Celeron M 900 MHz or compatible (older PC systems with Programmable Interrupt Controllers (PIC) are not suitable for WinAC RTX F 2010.)
• Multi-processor system	No
• Hyper-threading	Yes
<b>Operating systems</b>	
Windows NT 4.0	No
Windows 2000	No
Windows XP	Yes; Professional, SP2 and SP3
Windows XP embedded	Yes; With the delivery image of the SIMATIC PC
• Supported HAL types under Windows XP	ACPI uniprocessor PC, ACPI multiprocessor PC, MPS multiprocessor PC
Windows Vista	No
Windows 7	Yes; Professional, Enterprise, Ultimate (only 32 bits)
Windows embedded Standard 7	No

6ES7671-1RC08-0YA0 SIMATIC WinAC RTX F 2010	
<b>Configuration</b>	
Configuration software	
• STEP 7	Yes; As of V5.5 + HW update/S7 F Configuration Pack V5.5 + SP6 + HF1/option package S7 Distributed Safety V5.4 + SP5 or later
programming	
• Nesting levels	8
• Programming language	
- LAD	Yes
- FBD	Yes
- STL	Yes
- SCL	Yes
- CFC	Yes
- GRAPH	Yes
- HiGraph®	Yes
• Software libraries	
- Easy Motion Control	Yes
- Software redundancy	Yes; As of V1.2, only for operation of WinAC RTX (F) with WinAC RTX (F)
• Number of simultaneously active SFCs	
- DPSYC_FR	20; of a total of 20 for all SFCs
- D_ACT_DP	20; of a total of 20 for all SFCs
- RD_REC	20; of a total of 20 for all SFCs
- WR_REC	20; of a total of 20 for all SFCs
- WR_PARM	20; of a total of 20 for all SFCs
- PARM_MOD	20; of a total of 20 for all SFCs
- WR_DPARM	20; of a total of 20 for all SFCs
- DPNRM_DG	20; of a total of 20 for all SFCs
- RDSYSST	20; of a total of 20 for all SFCs
• Number of simultaneously active SFBs	
- RD_REC	20; of a total of 20 for all SFBs
- WR_REC	20; of a total of 20 for all SFBs
Know-how protection	
• User program protection/password protection	Yes
• Block encryption	No
Open Development interfaces	
• CCX (Custom Code Extension)	Yes; WinAC ODK V4.2 or higher
• CMI (Controller Management Interface)	Yes; WinAC ODK V4.2 or higher
• SMX (Shared Memory Extension)	Yes; WinAC ODK V4.2 or higher
- Inputs	4 kbyte
- Outputs	4 kbyte
<b>I/O/Options</b>	
I/O devices	none
• Printer	No
<b>Weights</b>	
Weight, approx.	100 g; Weight incl. packaging

## PROFINET/Industrial Ethernet Controllers / PC-based controllers

### SIMATIC WinAC RTX F

Ordering data	Article No.
<b>SIMATIC WinAC RTX F 2010</b>	<b>6ES7671-1RC08-0YA0</b>
<b>SIMATIC WinAC RTX F 2010 upgrade</b>	<b>6ES7671-1RC08-0YE0</b>
<b>CP 5612 communications processor</b>  PCI card (32 bit) for connection of a programming device or PC to PROFIBUS	<b>6GK1561-2AA00</b>
<b>CP 5621 communications processor</b>  PCI Express x1 card (32 bit) for connection of a programming device or PC to PROFIBUS	<b>6GK1562-2AA00</b>
<b>CP 5603 Microbox Package</b>  Comprising CP 5603 module and Microbox expansion rack	<b>6GK1560-3AU00</b>
<b>CP 5613 A2 communications processor</b>  PCI card (32 bit; 3.3 V/5 V) for connection to PROFIBUS incl. DP-Base software with NCM PC; DP-RAM interface for DP master, incl. PG and FDL protocol; single license for 1 installation, runtime software, software and electronic manual on CD-ROM, Class A, for 32 bit Windows 2000 Professional/Server, Windows XP Professional, German/English	<b>6GK1561-3AA01</b>
<b>CP 5623 communications processor</b>  PCI Express x1 card (32 bit) for connection to PROFIBUS incl. DP-Base software with NCM PC; DP-RAM interface for DP master or DP slave, incl. PG and FDL protocols; single license for 1 installation, runtime software, software and electronic manual on CD-ROM, Class A, for operating system support see SIMATIC NET software; German/English	<b>6GK1562-3AA00</b>
<b>CP 1616 communications processor</b>  PCI Card (32 bit; 3.3/5 V universal key) with ASIC ERTEC 400 for connecting PCs to PROFINET IO with 4-port real-time switch (RJ45); incl. IO-Base software for PROFINET IO controller (RT operation) and NCM PC; single license for one installation, runtime software, software and electronic manual on CD-ROM, Class A, for 32 bit Windows XP Professional; German/English	<b>6GK1161-6AA02</b>

### More information

#### Add-ons for SIMATIC WinAC

##### PC-based Competence Center Cologne

Our add-ons supplement the WinAC RTX soft PLC by useful functions which have arisen in the context of projects. In this way, you can fully utilize the advantages of PC based Automation.

The applications are available in the form of function blocks and are easy to use without special programming knowledge.

Detailed information and prices can be obtained from your Siemens contact or from:

Contact:

Siemens AG  
Competence Center Cologne  
E-mail: [CCCologne@siemens.com](mailto:CCCologne@siemens.com)

Application	Function
WinAC serial driver	Communication over serial interfaces
WinAC PC IO driver	Access to central I/O expansion PC IO including interrupt handling
WinAC SQL	Access to SQL databases
WinAC TCP/IP driver	Data exchange between WinAC and other communication partners over Windows interface using TCP/IP, UDP, or ISO-on-TCP
WinAC OPC Client	Access to various OPC servers
WinAC Shutdown	Controlled shutdown of WinAC and the PC system
WinAC File I/O	Reading and writing of DBs as a file on the PC system
WinAC Command	Calling batch commands from WinAC
WinAC Access DB	High-performance accesses to DBs, bit memories or I/O image
WinAC SMX Cover	Provides SMX functions, e.g. for Delphi or VB
WinAC CMI Wrapper	Easy program-controlled operation of WinAC

#### Brochures

Information material is available for downloading in the Internet at:

<http://www.siemens.com/simatic/printmaterial>



## Overview



- SIMATIC WinAC software PLCs support powerful interfaces which permit close meshing of the control task with PC-based applications.
- WinAC ODK allows the user to develop applications or to integrate already existing applications into the control task.

New with WinAC ODK V4.2:

- CCX interface:
  - New SFB 65003 for asynchronous execution of ODK applications
  - Expansion of data access functions
  - Creation of Windows DLL with C# and VB
- SMX interface:
  - Access to the Shared Memory interface under IntervalZero RTX
  - Expansion of data access functions
  - Creation of Windows applications with C# and VB
- Supports MS Visual Studio 2005 and 2008 (under Windows)

## Technical specifications

6ES7806-1CC03-0BA0 SIMATIC WinAC ODK V4.2 SP1	
<b>Hardware requirements</b>	
Hardware required	PC with color monitor, keyboard, mouse or pointing device for Windows
Main memory, min.	1 Gbyte
Required memory on hard disk, min.	30 Mbyte
Processor	Intel Pentium 800 MHz
<b>Software requirement</b>	
Software required	Microsoft Visual Developer Studio, for details see interfaces; CCX and SMX real-time applications in addition: IntervalZero SDK (SDK Version must match the WinAC RTX version used; see Technical Data for WinAC RTX)
<b>Operating systems</b>	
Windows XP	Yes; Professional, SP2 and SP3
Windows 7	Yes; Professional, Enterprise, Ultimate (only 32 bits)
<b>Configuration</b>	
Open Development interfaces	
• CCX (Custom Code Extension)	Yes; See product information: <a href="http://support.automation.siemens.com/WW/view/en/48207241">http://support.automation.siemens.com/WW/view/en/48207241</a>
• CMI (Controller Management Interface)	Yes; See product information: <a href="http://support.automation.siemens.com/WW/view/en/48207241">http://support.automation.siemens.com/WW/view/en/48207241</a>
• SMX (Shared Memory Extension)	Yes; See product information: <a href="http://support.automation.siemens.com/WW/view/en/48207241">http://support.automation.siemens.com/WW/view/en/48207241</a>
<b>Weights</b>	
Weight, approx.	200 g

## Ordering data

**SIMATIC WinAC ODK V4.2**  
for integration of C/C++ code in WinAC PLCs, executable under Windows XP SP2 or SP3; CD-ROM with electronic documentation  
Single license

## Article No.

**6ES7806-1CC03-0BA0**

## More information

### Brochures

Information material for downloading can be found in the Internet:

<http://www.siemens.com/simatic/printmaterial>

## PROFINET/Industrial Ethernet

### Controllers / SIMATIC S7-modular Embedded controllers

EC31

#### Overview



- Get off to a fast start in automation solutions with embedded PC platforms.
  - Ready-to-use SIMATIC WinAC RTX or WinAC RTX F preinstalled on EC31
  - Prepared for use in a SIMATIC environment with PROFINET and Industrial Ethernet
  - Commissioning by specialist automation personnel as with the S7-300
  - Configuring and programming with SIMATIC STEP 7 over Industrial Ethernet
  - Optional visualization
- Modular expansion capability:
  - Central expansion with
  - S7-300 I/O (SM modules of S7-300)
  - Expansion modules for additional PC interfaces, e.g. DVI-I, USB, Gigabit Ethernet networks and memory card slots, as well as PCI-104
- Rugged operation
  - Hard-disk-free operation based on flash disk and Windows Embedded Standard
  - Fan-free operation
- Flexibility of a PC-based automation environment
  - Free memory space on flash disk can be used for other PC applications
  - Use of WinAC ODK with SIMATIC WinAC RTX and WinAC RTX F (read-only in safety-related program part)
  - Connection option for USB devices
  - Memory capacity expandable using multimedia card
- Data retentivity for WinAC RTX and RTX F without uninterruptible power supply (UPS)

#### Function

- Control:
  - For the optimum control of processes with WinAC RTX, several processing levels are available:
    - Cyclic program processing
    - Interrupt processing
    - Time and date-controlled processing
- Functional safety with WinAC RTX F for EC31-RTX F:
  - The functional safety is implemented by means of targeted safety functions in the software. Safety functions are implemented with S7 Distributed Safety, to place the plant in a safe state or to hold it in a safe state. The safety functions are mainly included in the following components:
    - In the safety-related user program (safety program) in WinLC RTX F
    - In the fail-safe inputs and outputs (F I/O).
      - The F I/O ensures reliable processing of the field information (emergency stop pushbutton, light barriers, motor control). It features all the hardware and software components required for reliable processing, according to the required safety class. The user only programs the user safety functions. The safety functions for the process can be implemented with a user safety function or a system-internal fault reaction function. If the F system is unable to execute the actual user safety function, it will execute the fault response function: e.g. deactivation of the associated outputs and, if appropriate, F-CPU in STOP.
- Retentivity:
  - The controller can back up 512 KB of retentive data on an integrated, non-volatile memory, without the need for a UPS. Total retentivity of all process values of SIMATIC WinAC RTX can be achieved with a generally available UPS.
- Access to process values:
  - The SIMATIC NET OPC server supplied with EC31-RTX permits open access to all process values. Visualization systems or data processing systems can be linked to SIMATIC WinAC RTX via this interface.
- Communication:
  - The Windows Automation Center (WinAC) is programmed with SIMATIC STEP 7 via the integral Industrial Ethernet interface. The SIMATIC NET SOFTNET Lean communication package is pre-installed for this purpose.
- Use of other software:
  - The customer can install supporting software products. Windows Embedded Standard is designed so that typical add-on packages can be installed.

### Technical specifications

	6ES7677-1DD10-0BA0 SIMATIC S7-mEC, EC31	6ES7677-1DD10-0BB0 S7-mEC, EC31-RTX	6ES7677-1FD10-0FB0 S7-mEC, EC31-RTX F	6ES7677-1DD10-0BF0 S7-mEC, EC31-HM/RTX 128PT	6ES7677-1DD10-0BG0 S7-mEC, EC31-HM/RTX 512PT	6ES7677-1DD10-0BH0 S7-mEC, EC31-HM/RTX 2048PT
<b>General information</b>						
Hardware product version	01	01	01	01	01	01
Firmware version	V2.0	V2.0	V2.0	V2.0	V2.0	V2.0
<b>PC configuration</b>						
Computer platform	SIMATIC S7 modular embedded controller	SIMATIC S7 modular embedded controller	SIMATIC S7 modular embedded controller	SIMATIC S7 modular embedded controller	SIMATIC S7 modular embedded controller	SIMATIC S7 modular embedded controller
Processor selection	Intel Core Duo 1.2 GHz	Intel Core Duo 1.2 GHz	Intel Core Duo 1.2 GHz	Intel Core Duo 1.2 GHz	Intel Core Duo 1.2 GHz	Intel Core Duo 1.2 GHz
Main memory	1 GB RAM	1 GB RAM	1 GB RAM	1 GB RAM	1 GB RAM	1 GB RAM
Flash Disk	4 Gbyte	4 Gbyte	4 Gbyte	4 Gbyte	4 Gbyte	4 Gbyte
Operating systems	Windows Embedded Standard 2009	Windows Embedded Standard 2009	Windows Embedded Standard 2009	Windows Embedded Standard 2009	Windows Embedded Standard 2009	Windows Embedded Standard 2009
Installed software						
• Visualization				WinCC flexible RT 2008 SP2, incl. Sm@rtAccess, recipes, archives options	WinCC flexible RT 2008 SP2, incl. Sm@rtAccess, recipes, archives options	WinCC flexible RT 2008 SP2, incl. Sm@rtAccess, recipes, archives options
• Control		SIMATIC WinAC RTX 2010	SIMATIC WinAC RTX F 2010	SIMATIC WinAC RTX 2010	SIMATIC WinAC RTX 2010	SIMATIC WinAC RTX 2010
• Communication		Yes	Yes	Yes	Yes	Yes
<b>Supply voltage</b>						
Rated value, 24 V DC	Yes	Yes	Yes	Yes	Yes	Yes
Permissible range, lower limit (DC)	20.4 V	20.4 V	20.4 V	20.4 V	20.4 V	20.4 V
Permissible range, upper limit (DC)	28.8 V	28.8 V	28.8 V	28.8 V	28.8 V	28.8 V
Mains buffering						
• Mains/voltage failure stored energy time	5 ms	5 ms	5 ms	5 ms	5 ms	5 ms
<b>Input current</b>						
Rated value at 24 V DC	800 mA; without backplane bus and USB power supply	800 mA; without backplane bus and USB power supply	800 mA; without backplane bus and USB power supply	800 mA; without backplane bus and USB power supply	800 mA; without backplane bus and USB power supply	800 mA; without backplane bus and USB power supply
<b>Power losses</b>						
Power loss, typ.	34 W	34 W	34 W	34 W	34 W	34 W
<b>Memory</b>						
Type of memory	256 KB non-volatile memory for retentive data	512 KB non-volatile memory for retentive data	512 KB non-volatile memory for retentive data	512 KB non-volatile memory for retentive data	512 KB non-volatile memory for retentive data	512 KB non-volatile memory for retentive data
Work memory						
• integrated	1 Gbyte	1 Gbyte	1 Gbyte	1 Gbyte	1 Gbyte	1 Gbyte
<b>CPU processing times</b>						
for bit operations, typ.		0.004 µs	0.004 µs	0.004 µs	0.004 µs	0.004 µs
for fixed point arithmetic, typ.		0.003 µs	0.003 µs	0.003 µs	0.003 µs	0.003 µs
for floating point arithmetic, typ.		0.004 µs	0.004 µs	0.004 µs	0.004 µs	0.004 µs
<b>CPU-blocks</b>						
DB						
• Size, max.		64 kbyte	64 kbyte	64 kbyte	64 kbyte	64 kbyte
FB						
• Size, max.		64 kbyte	64 kbyte	64 kbyte	64 kbyte	64 kbyte
FC						
• Number, max.		Max. code size and max. data size: 4 MB each	Max. code size and max. data size: 4 MB each	Max. code size and max. data size: 4 MB each	Max. code size and max. data size: 4 MB each	Max. code size and max. data size: 4 MB each
• Size, max.		64 kbyte	64 kbyte	64 kbyte	64 kbyte	64 kbyte
OB						
• Size, max.		64 kbyte	64 kbyte	64 kbyte	64 kbyte	64 kbyte
• Number of free cycle OBs		1	1	1	1	1
• Number of time alarm OBs		1	1	1	1	1
• Number of delay alarm OBs		1	1	1	1	1
• Number of time interrupt OBs		9	9	9	9	9
• Number of process alarm OBs		1	1	1	1	1
• Number of startup OBs		2	2	2	2	2
• Number of asynchronous error OBs		7	7	7	7	7
• Number of synchronous error OBs		2	2	2	2	2
Nesting depth						
• per priority class		24	24	24	24	24
• additional within an error OB		24	24	24	24	24

## PROFINET/Industrial Ethernet

### Controllers / SIMATIC S7-modular Embedded controllers

#### EC31

#### Technical specifications (continued)

	6ES7677-1DD10-0BA0 SIMATIC S7-mEC, EC31	6ES7677-1DD10-0BB0 S7-mEC, EC31-RTX	6ES7677-1FD10-0FB0 S7-mEC, EC31-RTX F	6ES7677-1DD10-0BF0 S7-mEC, EC31-HMI/RTX 128PT	6ES7677-1DD10-0BG0 S7-mEC, EC31-HMI/RTX 512PT	6ES7677-1DD10-0BH0 S7-mEC, EC31-HMI/RTX 2048PT
<b>Counters, timers and their retentivity</b>						
S7 counter						
• Number		2 048	2 048	2 048	2 048	2 048
• Retentivity						
- adjustable		Yes	Yes	Yes	Yes	Yes
- lower limit		0	0	0	0	0
- upper limit		2 047	2 047	2 047	2 047	2 047
- preset		8	8	8	8	8
• Counting range						
- adjustable		Yes	Yes	Yes	Yes	Yes
- lower limit		0	0	0	0	0
- upper limit		999	999	999	999	999
IEC counter						
• present		Yes	Yes	Yes	Yes	Yes
• Type		SFB	SFB	SFB	SFB	SFB
S7 times						
• Number		2 048	2 048	2 048	2 048	2 048
• Retentivity						
- adjustable		Yes	Yes	Yes	Yes	Yes
- lower limit		0	0	0	0	0
- upper limit		2 047	2 047	2 047	2 047	2 047
• Time range						
- lower limit		10 ms	10 ms	10 ms	10 ms	10 ms
- upper limit		9 990 s	9 990 s	9 990 s	9 990 s	9 990 s
IEC timer						
• present		Yes	Yes	Yes	Yes	Yes
• Type		SFB	SFB	SFB	SFB	SFB
<b>Data areas and their retentivity</b>						
retentive data area, total		512 KB	512 KB	512 KB	512 KB	512 KB
Flag						
• Number, max.		16 kbyte	16 kbyte	16 kbyte	16 kbyte	16 kbyte
• of which retentive without battery		MB 0 to MB 16383	MB 0 to MB 16383	MB 0 to MB 16383	MB 0 to MB 16383	MB 0 to MB 16383
• Retentivity preset		MB 0 to MB 15	MB 0 to MB 15	MB 0 to MB 15	MB 0 to MB 15	MB 0 to MB 15
• Number of clock memories		8	8	8	8	8
Data blocks						
• Number, max.		Max. code size and max. data size: 4 MB each	Max. code size and max. data size: 4 MB each	Max. code size and max. data size: 4 MB each	Max. code size and max. data size: 4 MB each	Max. code size and max. data size: 4 MB each
• Size, max.		64 kbyte	64 kbyte	64 kbyte	64 kbyte	64 kbyte
<b>Address area</b>						
I/O address area						
• Inputs		16 kbyte	16 kbyte	16 kbyte	16 kbyte	16 kbyte
• Outputs		16 kbyte	16 kbyte	16 kbyte	16 kbyte	16 kbyte
• of which, distributed						
- Inputs		8 kbyte	8 kbyte	8 kbyte	8 kbyte	8 kbyte
- Outputs		8 kbyte	8 kbyte	8 kbyte	8 kbyte	8 kbyte
Process image						
• Inputs, adjustable		16 kbyte	16 kbyte	8 kbyte	8 kbyte	8 kbyte
• Outputs, adjustable		16 kbyte	16 kbyte	8 kbyte	8 kbyte	8 kbyte
• Inputs, default		512 byte	512 byte	512 byte	512 byte	512 byte
• Outputs, default		512 byte	512 byte	512 byte	512 byte	512 byte
Subprocess images						
• Number of subprocess images, max.		15	15	15	15	15
Digital channels						
• Inputs		128 000	128 000	128 000	128 000	128 000
• Outputs		128 000	128 000	128 000	128 000	128 000
Analog channels						
• Inputs		8 000	8 000	8 000	8 000	8 000
• Outputs		8 000	8 000	8 000	8 000	8 000
<b>Hardware configuration</b>						
Integrated power supply	Yes	Yes		Yes	Yes	Yes
<b>Time of day</b>						
Clock						
• Hardware clock (real-time clock)		Yes	Yes; Resolution: 1 s	Yes	Yes	Yes
Clock synchronization						
• supported		Yes	Yes	Yes	Yes	Yes
• to PC-CP, slave		Yes	Yes	Yes	Yes	Yes
• on Ethernet via NTP		Yes	Yes	Yes	Yes	Yes

# PROFINET/Industrial Ethernet

## Controllers / SIMATIC S7-modular Embedded controllers

EC31

### Technical specifications (continued)

	6ES7677-1DD10-0BA0 SIMATIC S7-mEC, EC31	6ES7677-1DD10-0BB0 S7-mEC, EC31-RTX	6ES7677-1FD10-0FB0 S7-mEC, EC31-RTX F	6ES7677-1DD10-0BF0 S7-mEC, EC31-HMI/RTX 128PT	6ES7677-1DD10-0BG0 S7-mEC, EC31-HMI/RTX 512PT	6ES7677-1DD10-0BH0 S7-mEC, EC31-HMI/RTX 2048PT
<b>Interfaces</b>						
Number of USB interfaces	2	2		2	2	2
Serial interface	0	0		0	0	0
Industrial Ethernet						
• Industrial Ethernet interface	X1: 2 ports 10/100 Mbit/s (ERTEC-based) X2: 1 port 10/100 Mbit/s	X1: 2 ports 10/100 Mbit/s (ERTEC-based) X2: 1 port 10/100 Mbit/s	X1: 2 ports 10/100 Mbit/s (ERTEC-based) X2: 1 port 10/100 Mbit/s	X1: 2 ports 10/100 Mbit/s (ERTEC-based) X2: 1 port 10/100 Mbit/s	X1: 2 ports 10/100 Mbit/s (ERTEC-based) X2: 1 port 10/100 Mbit/s	X1: 2 ports 10/100 Mbit/s (ERTEC-based) X2: 1 port 10/100 Mbit/s
<b>1st interface</b>						
Interface type		PROFINET	PROFINET	PROFINET	PROFINET	PROFINET
Physics		2x RJ45	2x RJ45	2x RJ45	2x RJ45	2x RJ45
Automatic detection of transmission speed		Yes	Yes	Yes	Yes	Yes
Autonegotiation		Yes	Yes	Yes	Yes	Yes
Autocrossing		Yes	Yes	Yes	Yes	Yes
Number of connection resources		32	32	32	32	32
Functionality						
• MPI			No			
• DP master			No			
• DP slave			No			
• PROFINET IO Device		No	No	No	No	No
• PROFINET IO Controller		Yes	Yes	Yes	Yes	Yes
• PROFINET CBA		Yes	Yes	Yes	Yes	Yes
• Open IE communication		Yes	Yes	Yes	Yes	Yes
• Point-to-point connection			No			
PROFINET IO Controller						
• Number of connectable IO devices, max.		256	256	256	256	256
• Max. number of connectable IO devices for RT		256	256	256	256	256
- of which in line, max.		256	256	256	256	256
• Number of IO devices with IRT and the option "high flexibility"		256	256	256	256	256
- of which in line, max.		61	61	61	61	61
• Number of IO Devices with IRT and the option "high performance", max.		256	256	256	256	256
- of which in line, max.		64	64	64	64	64
• IRT, supported		Yes	Yes	Yes	Yes	Yes
• Prioritized startup supported		Yes	Yes	Yes	Yes	Yes
- Number of IO Devices, max.		32	32	32	32	32
• Activation/deactivation of IO Devices		Yes	Yes	Yes	Yes	Yes
- Maximum number of IO devices that can be activated/deactivated at the same time.		8	8	8	8	8
• IO Devices changing during operation (partner ports), supported		Yes	Yes	Yes	Yes	Yes
- Max. number of IO devices per tool		8	8	8	8	8
• Device replacement without swap medium		Yes	Yes	Yes	Yes	Yes
• Send cycles		Adjustable: 250 µs, 500 µs and 1 ms	Adjustable: 250 µs, 500 µs and 1 ms	Adjustable: 250 µs, 500 µs and 1 ms	Adjustable: 250 µs, 500 µs and 1 ms	Adjustable: 250 µs, 500 µs and 1 ms
• Updating times		250 µs - 128 ms (with signal cycle 250 µs); 500 µs - 256 ms (with signal cycle 500 µs); 1 ms - 512 ms (with signal cycle 1 ms)	250 µs - 128 ms (with signal cycle 250 µs); 500 µs - 256 ms (with signal cycle 500 µs); 1 ms - 512 ms (with signal cycle 1 ms)	250 µs - 128 ms (with signal cycle 250 µs); 500 µs - 256 ms (with signal cycle 500 µs); 1 ms - 512 ms (with signal cycle 1 ms)	250 µs - 128 ms (with signal cycle 250 µs); 500 µs - 256 ms (with signal cycle 500 µs); 1 ms - 512 ms (with signal cycle 1 ms)	250 µs - 128 ms (with signal cycle 250 µs); 500 µs - 256 ms (with signal cycle 500 µs); 1 ms - 512 ms (with signal cycle 1 ms)
• Services						
- PG/OP communication		Yes	Yes	Yes	Yes	Yes
- S7 routing		Yes	Yes	Yes	Yes	Yes
- S7 communication		Yes	Yes	Yes	Yes	Yes
- Isochronous mode		Yes	Yes	Yes	Yes	Yes
• Address area						
- Inputs, max.		16 kbyte	16 kbyte	16 kbyte	16 kbyte	16 kbyte
- Outputs, max.		16 kbyte	16 kbyte	16 kbyte	16 kbyte	16 kbyte
- User data per address area, max.		2 kbyte	2 kbyte	2 kbyte	2 kbyte	2 kbyte
- User data consistency, max.		256 byte	256 byte	256 byte	256 byte	256 byte
PROFINET CBA						
• acyclic transmission		Yes	Yes	Yes	Yes	Yes
• Cyclic transmission		Yes	Yes	Yes	Yes	Yes

2

# PROFINET/Industrial Ethernet

## Controllers / SIMATIC S7-modular Embedded controllers

EC31

### Technical specifications (continued)

	6ES7677-1DD10-0BA0 SIMATIC S7-mEC, EC31	6ES7677-1DD10-0BB0 S7-mEC, EC31-RTX	6ES7677-1FD10-0FB0 S7-mEC, EC31-RTX F	6ES7677-1DD10-0BF0 S7-mEC, EC31-HMI/RTX 128PT	6ES7677-1DD10-0BG0 S7-mEC, EC31-HMI/RTX 512PT	6ES7677-1DD10-0BH0 S7-mEC, EC31-HMI/RTX 2048PT
Open IE communication						
<ul style="list-style-type: none"> <li>Open IE communication, supported</li> <li>Number of connections, max.</li> <li>Local port numbers used at the system end</li> </ul>	Yes 32	Yes 32	Yes 32	Yes 32	Yes 32	Yes 32
PROFINET functions						
<ul style="list-style-type: none"> <li>Detection of accessible nodes, supported</li> <li>Assignment of the IP address, supported</li> <li>Assignment of the device name, supported</li> <li>Topology recognition, supported</li> <li>Extended network diagnostics with Standard MIB II, supported</li> </ul>	Yes; DCP Yes; DCP Yes; DCP Yes; LLDP, LLDP MIB, SNMP Yes; Standard MIB II, SNMP	Yes; DCP Yes; DCP Yes; DCP Yes; LLDP, LLDP MIB, SNMP Yes; Standard MIB II, SNMP	Yes; DCP Yes; DCP Yes; DCP Yes; LLDP, LLDP MIB, SNMP Yes; Standard MIB II, SNMP	Yes; DCP Yes; DCP Yes; DCP Yes; LLDP, LLDP MIB, SNMP Yes; Standard MIB II, SNMP	Yes; DCP Yes; DCP Yes; DCP Yes; LLDP, LLDP MIB, SNMP Yes; Standard MIB II, SNMP	Yes; DCP Yes; DCP Yes; DCP Yes; LLDP, LLDP MIB, SNMP Yes; Standard MIB II, SNMP
<b>2nd interface</b>						
Interface type		Integrated Ethernet interface	Integrated Ethernet interface	Integrated Ethernet interface	Integrated Ethernet interface	Integrated Ethernet interface
Physics		Ethernet RJ45	Ethernet RJ45	Ethernet RJ45	Ethernet RJ45	Ethernet RJ45
Automatic detection of transmission speed		Yes	Yes	Yes	Yes	Yes
Autonegotiation		Yes	Yes	Yes	Yes	Yes
Autocrossing		No	No	No	No	No
Number of connection resources		32	32	32	32	32
Functionality						
<ul style="list-style-type: none"> <li>PROFINET IO Controller</li> <li>PROFINET IO Device</li> <li>PROFINET CBA</li> </ul>	No No No	No No No	No No No	No No No	No No No	No No No
PROFINET functions						
<ul style="list-style-type: none"> <li>Detection of accessible nodes, supported</li> <li>Assignment of the IP address, supported</li> <li>Assignment of the device name, supported</li> <li>Topology recognition, supported</li> <li>Extended network diagnostics with Standard MIB II, supported</li> </ul>	Yes; DCP Yes; DCP Yes; DCP Yes; LLDP, LLDP MIB, SNMP Yes; Standard MIB II, SNMP	Yes; DCP Yes; DCP Yes; DCP Yes; LLDP, LLDP MIB, SNMP Yes; Standard MIB II, SNMP	Yes; DCP Yes; DCP Yes; DCP Yes; LLDP, LLDP MIB, SNMP Yes; Standard MIB II, SNMP	Yes; DCP Yes; DCP Yes; DCP Yes; LLDP, LLDP MIB, SNMP Yes; Standard MIB II, SNMP	Yes; DCP Yes; DCP Yes; DCP Yes; LLDP, LLDP MIB, SNMP Yes; Standard MIB II, SNMP	Yes; DCP Yes; DCP Yes; DCP Yes; LLDP, LLDP MIB, SNMP Yes; Standard MIB II, SNMP
<b>Communication functions</b>						
PG/OP communication		Yes	Yes	Yes	Yes	Yes
Global data communication						
<ul style="list-style-type: none"> <li>supported</li> </ul>	No	No	No	No	No	No
S7 basic communication						
<ul style="list-style-type: none"> <li>supported</li> </ul>	No	No	No	No	No	No
S7 communication						
<ul style="list-style-type: none"> <li>supported</li> <li>as server</li> <li>As client</li> </ul>	Yes Yes Yes	Yes Yes Yes	Yes Yes Yes	Yes Yes Yes	Yes Yes Yes	Yes Yes Yes
Open IE communication						
<ul style="list-style-type: none"> <li>TCP/IP</li> <li>Number of connections, max.</li> <li>Data length, max.</li> <li>ISO-on-TCP (RFC1006)</li> <li>Number of connections, max.</li> <li>Data length, max.</li> <li>UDP</li> <li>Number of connections, max.</li> <li>Data length, max.</li> </ul>	Yes; Via integrated PROFINET interface (X1) and loadable FBs 32 32 kbyte Yes; Via integrated PROFINET interface (X1) and loadable FBs 32 32 kbyte Yes; Via integrated PROFINET interface (X1) and loadable FBs 32 32 kbyte	Yes; Via integrated PROFINET interface (X1) and loadable FBs 32 32 kbyte Yes; Via integrated PROFINET interface and loadable FBs 32 32 kbyte Yes; Via integrated PROFINET interface (X1) and loadable FBs 32 32 kbyte	Yes; Via integrated PROFINET interface (X1) and loadable FBs 32 32 kbyte Yes; Via integrated PROFINET interface and loadable FBs 32 32 kbyte Yes; Via integrated PROFINET interface (X1) and loadable FBs 32 32 kbyte	Yes; Via integrated PROFINET interface (X1) and loadable FBs 32 32 kbyte Yes; Via integrated PROFINET interface (X1) and loadable FBs 32 32 kbyte Yes; Via integrated PROFINET interface (X1) and loadable FBs 32 32 kbyte	Yes; Via integrated PROFINET interface (X1) and loadable FBs 32 32 kbyte Yes; Via integrated PROFINET interface (X1) and loadable FBs 32 32 kbyte Yes; Via integrated PROFINET interface (X1) and loadable FBs 32 32 kbyte	Yes; Via integrated PROFINET interface (X1) and loadable FBs 32 32 kbyte Yes; Via integrated PROFINET interface (X1) and loadable FBs 32 32 kbyte Yes; Via integrated PROFINET interface (X1) and loadable FBs 32 32 kbyte

### Technical specifications (continued)

	6ES7677-1DD10-0BA0 SIMATIC S7-mEC, EC31	6ES7677-1DD10-0BB0 S7-mEC, EC31-RTX	6ES7677-1FD10-0FB0 S7-mEC, EC31-RTX F	6ES7677-1DD10-0BF0 S7-mEC, EC31-HMI/RTX 128PT	6ES7677-1DD10-0BG0 S7-mEC, EC31-HMI/RTX 512PT	6ES7677-1DD10-0BH0 S7-mEC, EC31-HMI/RTX 2048PT
Number of connections		64	64	64	64	64
• overall						
• usable for PG communication						
- reserved for PG communication		1	1	1	1	1
• usable for OP communication						
- reserved for OP communication		1	1	1	1	1
<b>S7 message functions</b>						
Number of login stations for message functions, max.		62; The alarm functions cannot currently be used for central bus modules	62; The alarm functions cannot currently be used for central bus modules	62; The alarm functions cannot currently be used for central bus modules	62; The alarm functions cannot currently be used for central bus modules	62; The alarm functions cannot currently be used for central bus modules
Process diagnostic messages		Yes; Alarm_S	Yes; Alarm_S	Yes; Alarm_S	Yes; Alarm_S	Yes; Alarm_S
<b>Test commissioning functions</b>						
Status/control						
• Status/control variable		Yes	Yes	Yes	Yes	Yes
Forcing						
• Forcing		No	No	No	No	No
Diagnostic buffer						
• present		Yes	Yes	Yes	Yes	Yes
<b>EMC</b>						
Emission of radio interference acc. to EN 55 011						
• Limit class A, for use in industrial areas	Yes	Yes	Yes	Yes	Yes	Yes
<b>Degree and class of protection</b>						
IP20	Yes	Yes	Yes	Yes	Yes	Yes
<b>Standards, approvals, certificates</b>						
CE mark	Yes	Yes	Yes	Yes	Yes	Yes
CSA approval	Yes; Included in cULus	Yes; Included in cULus	Yes; Included in cULus	Yes; Included in cULus	Yes; Included in cULus	Yes; Included in cULus
cULus	Yes	Yes	Yes	Yes	Yes	Yes
RCM (former C-TICK)	Yes	Yes	Yes	Yes	Yes	Yes
FM approval	Yes	Yes	Yes	Yes	Yes	Yes
<b>Ambient conditions</b>						
Operating temperature						
• Min.	0 °C	0 °C	0 °C	0 °C	0 °C	0 °C
• Max.	50 °C	50 °C	50 °C	50 °C	50 °C	50 °C
Storage/transport temperature						
• Min.	-40 °C	-40 °C	-40 °C	-40 °C	-40 °C	-40 °C
• Max.	70 °C	70 °C	70 °C	70 °C	70 °C	70 °C
Vibrations						
• Operation, checked according to IEC 60068-2-6	Yes	Yes	Yes	Yes	Yes	Yes
• Transport tested checked to IEC 60068-2-6	Yes	Yes	Yes	Yes	Yes	Yes
Shock test						
• checked according to IEC 60068-2-27	Yes	Yes	Yes	Yes	Yes	Yes
• checked according to IEC 60068-2-29	Yes	Yes	Yes	Yes	Yes	Yes
Shock testing						
• checked according to IEC 60068-2-29	Yes	Yes	Yes	Yes	Yes	Yes
• Operation, checked according to IEC 60068-2-29	Operation, tested according to IEC 60068-2-27	Operation, tested according to IEC 60068-2-27	Operation, tested according to IEC 60068-2-27	Operation, tested according to IEC 60068-2-27	Operation, tested according to IEC 60068-2-27	Operation, tested according to IEC 60068-2-27
• Storage/transport, checked to IEC 60068-2-29	Yes	Yes	Yes	Yes	Yes	Yes

## PROFINET/Industrial Ethernet

### Controllers / SIMATIC S7-modular Embedded controllers

#### EC31

#### Technical specifications (continued)

	6ES7677-1DD10-0BA0 SIMATIC S7-mEC, EC31	6ES7677-1DD10-0BB0 S7-mEC, EC31-RTX	6ES7677-1FD10-0FB0 S7-mEC, EC31-RTX F	6ES7677-1DD10-0BF0 S7-mEC, EC31-HMI/RTX 128PT	6ES7677-1DD10-0BG0 S7-mEC, EC31-HMI/RTX 512PT	6ES7677-1DD10-0BH0 S7-mEC, EC31-HMI/RTX 2048PT
<b>Configuration</b>						
Configuration software • STEP 7		Yes	Yes; STEP7 V5.5 and higher / S7 Distributed Safety option package V5.4 + SP5 and higher	Yes	Yes	Yes
<b>programming</b>						
• Programming language						
- LAD		Yes	Yes	Yes	Yes	Yes
- FBD		Yes	Yes	Yes	Yes	Yes
- STL		Yes	Yes	Yes	Yes	Yes
- SCL		Yes	Yes	Yes	Yes	Yes
- CFC		Yes	Yes	Yes	Yes	Yes
- GRAPH		Yes	Yes	Yes	Yes	Yes
- HiGraph®		Yes	Yes	Yes	Yes	Yes
<b>Dimensions</b>						
Width	160 mm	160 mm	160 mm	160 mm	160 mm	160 mm
Height	125 mm	125 mm	125 mm	125 mm	125 mm	125 mm
Depth	115 mm	115 mm	115 mm	115 mm	115 mm	115 mm
<b>Weights</b>						
Weight, approx.	1.5 kg	1.5 kg	1.5 kg	1.5 kg	1.5 kg	1.5 kg

#### Ordering data

#### Article No.

#### Article No.

#### SIMATIC S7-modular Embedded Controller

##### EC31

Intel CoreDuo 1.2 GHz processor  
Memory configuration:  
1 GB RAM, 4 GB Flash Disk;  
interfaces:  
1 Industrial Ethernet port,  
2 PROFINET ports, 2 USB ports,  
1 slot for multimedia card;  
Software:  
Windows Embedded Standard  
preinstalled, Software Develop-  
ment Kit (SDK) for creating C/C++  
applications with accesses  
to central I/O modules

**6ES7677-1DD10-0BA0**

##### EC31-RTX

Intel CoreDuo 1.2 GHz processor  
Memory configuration:  
1 GB RAM, 4 GB Flash Disk;  
interfaces:  
1 Industrial Ethernet port,  
2 PROFINET ports, 2 USB ports,  
1 slot for multimedia card;  
Software:  
Windows Embedded Standard and  
WinAC RTX 2010 preinstalled

**6ES7677-1DD10-0BB0**

##### EC31-RTX F

Intel CoreDuo 1.2 GHz processor  
Memory configuration:  
1 GB RAM, 4 GB Flash Disk;  
interfaces:  
1 Industrial Ethernet port,  
2 PROFINET ports, 2 USB ports,  
1 slot for multimedia card;  
Software:  
Windows Embedded Standard and  
WinAC RTX F 2010 preinstalled

**6ES7677-1FD10-0FB0**

##### EC31-HMI/RTX

Intel CoreDuo 1.2 GHz processor  
Memory configuration:  
1 GB RAM, 4 GB Flash Disk;  
interfaces:  
1 Industrial Ethernet port,  
2 PROFINET ports, 2 USB ports,  
1 slot for multimedia card;  
Software:  
Windows Embedded Standard,  
WinAC RTX 2010,  
SIMATIC SOFTNET-S7/V7.0 Lean  
preinstalled  
• With WinCC flexible 2008 RT  
128 PT  
• With WinCC flexible 2008 RT  
512 PT  
• With WinCC flexible 2008 RT  
2048 PT

**6ES7677-1DD10-0BF0**

**6ES7677-1DD10-0BG0**

**6ES7677-1DD10-0BH0**

##### Accessories

##### EM PCI-104 expansion module

For fitting up to 3 additional  
PCI-104 cards

**6ES7677-1DD60-1AA0**

##### EM PC expansion module

Additional connection options:  
2 USB interfaces,  
1 Gigabit Ethernet interface,  
1 serial interface,  
1 slot for CF card,  
1 slot for SD card/Micro Memory  
Card

**6ES7677-1DD50-2AA0**



### Overview



- Expansion modules for SIMATIC S7-modular Embedded Controller EC31
  - EM PCI-104 for additionally accommodating up to 3 PCI-104 cards
  - EM PC with additional PC interfaces and slots for memory media

2

### Technical specifications

	6ES7677-1DD60-1AA0 EM PCI-104	6ES7677-1DD50-2AA0 EM PC
<b>General information</b>		
Hardware product version	01	01
<b>Input current</b>		
from expansion bus	100 mA	580 mA
<b>Power losses</b>		
Power loss, typ.	2.4 W; Without inserted PCI-104 cards	9 W
Power loss, max.		14 W
<b>Hardware configuration</b>		
Integrated power supply	Yes	No
<b>Interfaces</b>		
Number of USB interfaces	0	2
serial interface	0	1x V.24 (RS232)
Industrial Ethernet		
• Industrial Ethernet interface		Onboard, 10/100/1 000 Mbit/s, RJ45
<b>Ambient conditions</b>		
Operating temperature		
• Min.	0 °C	0 °C
• max.	50 °C	50 °C
<b>Dimensions</b>		
Width	120 mm; Without bus connector extension bus	80 mm; Without bus connector extension bus
Height	125 mm; Without external voltage connecting terminal	125 mm
Depth	115 mm	115 mm
<b>Weights</b>		
Weight, approx.	0.5 kg	0.4 kg

### Ordering data

#### Article No.

<b>EM PCI-104 expansion module</b>	<b>6ES7677-1DD60-1AA0</b>
For fitting up to 3 additional PCI-104 cards	
<b>EM PC expansion module</b>	<b>6ES7677-1DD50-2AA0</b>
Additional connection options: 1 DVI-I interface, 2 USB interfaces, 1 Gigabit Ethernet interface, 1 serial interface, 1 slot for CF card, 1 slot for SD card/Micro Memory Card	

## PROFINET/Industrial Ethernet Controllers / Embedded bundles

### SIMATIC IPC227D Bundles

#### Overview



- A quick start in automation solutions with embedded PC platforms
  - SIMATIC WinAC RTX or SIMATIC WinAC RTX F preinstalled on SIMATIC IPC227D and ready for use
  - PROFINET RT and Industrial Ethernet pre-configured for use in a SIMATIC environment
  - Optional WinCC RT Advanced for visualization tasks in parallel with SIMATIC WinAC RTX
  - Configuration and programming with SIMATIC STEP 7 via Industrial Ethernet or PROFINET
- Safety requirements up to SIL 3 in accordance with IEC 61508/62061 or EN ISO 13849-1 up to PL e can be implemented with WinAC RTX F.
- Rugged operation
  - Hard-disk-free operation with CompactFlash card (CF card) or solid-state drive and Windows Embedded Standard 2009 or Windows Embedded Standard 7, 32-bit
  - Fan-free operation
  - 128 KB of retentive data for WinAC RTX, also without uninterruptible power supply (UPS)
- Flexibility of a PC-based automation environment
  - Use of WinAC ODK with SIMATIC WinAC RTX or SIMATIC WinAC RTX F (read-only for fail-safe program section)
  - Connection option for USB devices, flat panel monitor or screen
  - PCIe cards can be plugged in

#### Technical specifications

See "PC-based Automation -> Industry PC -> Box PC -> SIMATIC IPC227D"

#### Ordering data

#### Article No.

SIMATIC IPC227D	6ES7647- 8 A	-	-	-	-	-	-
Atom E620 (600 MHz), 512 MB RAM, without drive, with CF slot, COM1: RS232, without operating system, device version: Base, DIN rail, 1 x DVI-D graphics interface 2 x 10/100/1 000 Mbps Ethernet RJ45 4 x USB V2.0 (high current) CompactFlash slot 24 V DC industrial power supply							
<u>Processors / memory configuration / NVRAM</u>							
• Atom E620 (600 MHz), 512 MB RAM							<b>A</b>
• Atom E620 (600 MHz), 512 MB RAM, NVRAM							<b>B</b>
• Atom E640 (1.0 GHz), 1 GB RAM							<b>E</b>
• Atom E640 (1.0 GHz), 1 GB RAM, NVRAM							<b>F</b>
• Atom E660 (1.3 GHz), 2 GB RAM							<b>G</b>
• Atom E660 (1.3 GHz), 2 GB RAM, NVRAM							<b>H</b>
<u>Drives</u>							
• Without drive, with CF slot							<b>0</b>
• 320 GB HDD SATA							<b>1</b>
• 160 GB Solid-State Drive SATA							<b>2</b>
• 80 GB Solid-State Drive SATA							<b>4</b>
• 2 GB SIMATIC IPC CompactFlash							<b>5</b>
• 4 GB SIMATIC IPC CompactFlash							<b>6</b>
• 8 GB SIMATIC IPC CompactFlash							<b>7</b>
• 16 GB SIMATIC IPC Compact- Flash							<b>8</b>
<u>COM interface</u>							
• COM1: RS232							<b>0</b>
• COM1: RS485							<b>1</b>
• COM1: CAN							<b>2</b>
<u>Operating system</u>							
• Without operating system							<b>0</b>
• Windows Embedded Standard 2009 preinstalled (CF from 2 GB/SSD/HD)							<b>1</b>
• XP Prof. MUI preinstalled on SSD/HD							<b>2</b>
• Windows Embedded Standard 7 (32-bit) preinstalled (CF from 4 GB/SSD/HD)							<b>3</b>
• Windows 7 (32-bit) MUI preinstalled on SSD/HD							<b>4</b>

#### More information

##### Delivery

Production and delivery of the devices will typically be completed within 15 business days after receipt of order. The hardware and mass memory with the complete, pre-installed, ready-to-use software are supplied fully assembled.

## Overview

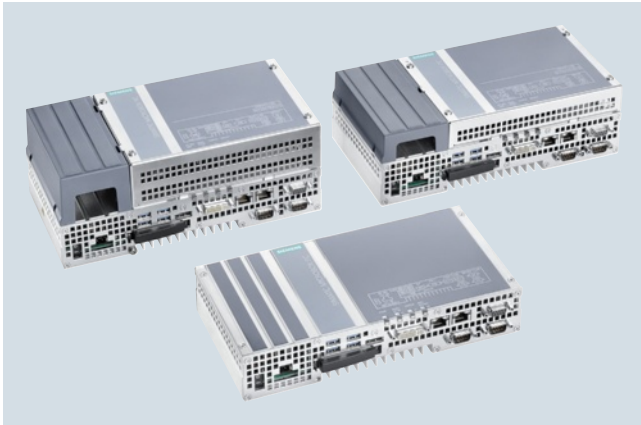

### **SIMATIC IPC427D (Microbox PC): The powerful embedded IPC – maintenance-free with versatile configuration**

Ready-to-run, complete solutions (software is already installed and preconfigured) for visualization and automation in connection with WinCC RT Advanced and/or WinAC RTX.

- Ultra-compact
- Maintenance-free
- Third generation Intel Core i technology
- Current product versions of the pre-installed software:
  - SIMATIC WinCC RT Advanced V13
  - SIMATIC WinAC RTX 2010
  - SIMATIC Net V12.1

## Benefits

### High data processing speed for high productivity

- Up to Core i 7, fan-free
- DDR3 memory technology up to 8 GB

### Maximum compactness and ruggedness for use directly on the machine

- Low mounting depth, ambient temperature up to 55 °C
- Upright mounting as second standard mounting position (ambient temperature 50 °C)
- Solid State Drive (SSD) (50 GB high endurance or 80 GB standard, optional), SATA hard disk, or up to two CFast cards with 16 GB

### High degree of industrial functionality and flexibility for implementing embedded solutions

- Flexible memory concepts (e.g. second mass storage unit possible)
- 2 x LAN 10/100/1000 Mbit/s connections; teaming capability
- Onboard PROFIBUS or PROFINET interface (optional)
- 4 x high-speed USB 3.0 ports; 2 serial interfaces (2nd interface is optional)
- Flexible installation with mounting options (rail, wall, front upright mounting)
- Simple expansion capability (up to 2 x PCIe slots)
- On-off switch

### High system availability in order to reduce the risk of potential failures and maintenance costs

- Maintenance-free since no rotating parts (fans, hard disks) and operation without battery possible
- 512 KB NVRAM can be written by WinAC RTX
- Front LED for efficient self-diagnostics; optimized for headless operation through special BIOS properties
- SIMATIC software system-tested

### High investment security in order to reduce engineering costs

- Long-term availability: Service and support period of 8 to 10 years after market launch
- Installation and interface compatibility with predecessor versions as of 2004

## Technical specifications

See "PC-based Automation -> Industry PC -> Box PC -> SIMATIC IPC427D"

## Ordering data

## Article No.

Ordering data	Article No.
<b>SIMATIC IPC427D (Box PC)</b>	<b>6AG4140-</b>
Processor and field bus	
Mounting accessories	
Main memory/NVRAM/ECC	
Expansions/interfaces	
Operating system	
Mass storage, externally accessible	
Internal mass storage	
SIMATIC Software preinstalled (bundles, only with Windows Embedded Standard 7)	
Power supply	

For detailed ordering data see ST 80 / ST PC "Industrie PC -> Box PC -> SIMATIC IPC427D" or on the internet under:

<http://www.automation.siemens.com/mcms/pc-based-automation/en/embedded-bundles>

## More information

### **Delivery**

Production and delivery of the devices will typically be completed within 15 business days after receipt of order. The hardware and mass memory with the complete, pre-installed, ready-to-use software are supplied fully assembled.

### **Commissioning**

Before the control or visualization application is complete, simply perform the following steps:

- Optional: Installation and setup of additional software on the device
- Optional: Installation and setup of other software on the device
- Transfer of the engineering projects from STEP 7 or WinCC Advanced
- Transfer of the supplied license keys for SIMATIC software
- Backup of the installed software and protection of the flash-based mass memory by switching on the Enhance Write filter

## PROFINET/Industrial Ethernet Controllers / Embedded bundles

### SIMATIC IPC277D bundles

#### Overview



SIMATIC IPC277D for implementing simple visualization and control tasks

- High degree of flexibility when selecting rugged widescreen fronts from 7" to 19" for more freely configurable display area
- High resolution, large viewing angle and up to 100% dimmable backlighting for brilliant display with optimized power consumption
- Absolutely maintenance-free due to the use of CompactFlash and SSD as mass storage and fanless operation up to 50 °C ambient temperature
- Maximum industrial functionality due to non-volatile retentive memory for battery-free operation
- Ready-to-run embedded bundles with visualization or/and control software

The following front installation versions are available:

- 7" Touch
- 9" Touch
- 12" Touch
- 15" Touch with front USB interface
- 19" Touch with front USB interface
- All fronts in widescreen design

#### Benefits

##### SIMATIC IPC277D

- Rugged, industry-standard widescreen displays (Touch) with 7" / 9" / 12" / 15" / 19"
  - High resolution, 16 million colors, large viewing angle, dimmable from 0 to 100% (this also optimizes the power consumption)
  - Integrated front concept (Panel PC, Comfort Panels)
  - Fanless up to 50°C ambient temperature

##### High-performance data processing at low power consumption

- Intel Atom technology of the Power-Optimized family E6xx
- Wake-on-LAN for remote-controlled switching between stand-by and active state
- Support of Sleep States/SpeedStep -> dynamic power adaptation depending on the required computing performance
- Intel VT-x technology for virtualization

##### High degree of industrial functionality and flexibility for implementing the embedded solution

- Flexible memory concepts: CompactFlash or Solid-State Drive
- 2 Gbit Ethernet (teaming-capable); PROFINET with RT functionality (via Standard Ethernet)
- 3 high-speed USB 2.0 ports
- 1 RS232
- Ready-to-run embedded bundles with WinAC RTX2010 and/or WinCC RT Advanced (optional)
- 512 KB retentive memory (MRAM), of which 128 KB can be written to within the buffer time (optional)
- Retentive message buffer for alarms (WinCC RT Advanced)

##### High system availability in order to reduce the risk of potential failures and maintenance costs

- Maintenance-free since there are no rotating parts (fans, HDD)
- Battery-free operation even if retentive memory option is selected (over the network with time-of-day synchronization)
- Comprehensive self-diagnostics by means of pre-installed local diagnostics software SIMATIC IPC DiagBase

##### High investment security in order to reduce engineering costs

- Long-term availability: Service and support period of 8 – 10 years after market launch

#### Technical specifications

See "PC-based Automation -> Industry PC -> Panel PC -> SIMATIC IPC277D"

#### Ordering data

#### Article No.

Ordering data	Article No.
<b>SIMATIC IPC277D Nanopanel PC</b>	<b>6AV7881- A 0 0 - 0</b>
Operating unit	
Processors / memory configuration / NVRAMC	
Drives	
Operating System	
Software bundles	

For detailed ordering data see ST 80 / ST PC "Industrie PC -> Box PC -> SIMATIC IPC427D" or on the internet under:

<http://www.automation.siemens.com/mcmsg/pc-based-automation/en/embedded-bundles>

#### More information

##### Delivery

Production and delivery of the devices will typically be completed within 15 working days after receipt of order. The hardware and mass memory with the complete, pre-installed, ready-to-use software are supplied fully assembled.

## Overview



### **SIMATIC IPC477D: The powerful embedded Panel PC – maintenance-free with versatile configuration**

Ready-to-run, complete solutions (software is already installed and preconfigured) for visualization and automation in connection with WinCC RT Advanced and/or WinAC RTX.

- Embedded PC platform with extremely high industrial compatibility for demanding tasks in the field of PC-based automation
- Maintenance-free (no rotating components such as fan and hard disk)
- Rugged construction: the PC is resistant to even the harshest mechanical stress and is extremely reliable in operation
- Compact design
- Battery-independent retentive memory onboard
- High investment protection
- Fast integration capability
- Safety requirements up to SIL 3 in accordance with IEC 61508/62061 or EN ISO 13849-1 up to PL e can be implemented with WinAC RTX F

The following front versions are available:

- Built-in versions
  - 12" TFT Touch
  - 15" TFT Touch
  - 19" TFT Touch
  - 22" TFT Touch
  - 15" TFT Touch/Key
- Current product versions of the pre-installed SIMATIC software:
  - SIMATIC WinCC RT Advanced V13
  - SIMATIC WinAC RTX 2010 or SIMATIC WinAC RTX F 2010
  - SIMATIC NET V12.1 (including SIMATIC SOFTNET S7 Basis license)
  - and the combinations of the software packages listed above

## Benefits

- Excellent industrial compatibility due to rugged construction, even when subjected to extreme vibration and shock
- High degree of investment protection thanks to assured availability of spare parts for a period of 5 years following the end of active marketing
- Excellent continuity of components for machine concepts with a long service life without any new engineering costs
- Cost and time savings due to service-friendly device design:
  - USB interfaces on the front and rear for quick and easy connection of additional hardware components
- High degree of industrial functionality thanks to integral PROFIBUS DP/MPI and PROFINET interfaces
- Maintenance-free due to lack of rotating components (fan and hard disk)
- High flexibility thanks to expansions (optional) such as PCIe, second RS232, DVD
- Minimization of downtimes thanks to high system availability
  - Efficient self-diagnostics (DiagBase and SIMATIC IPC DiagMonitor)
  - High reliability and security of an embedded platform
- An integral component of Totally Integrated Automation (TIA):
  - Enhanced productivity, minimization of engineering costs, reduction of lifecycle costs

## Technical specifications

See "PC-based Automation -> Industry PC -> Panel PC -> SIMATIC IPC477D"

### Ordering data

### Article No.

Ordering data	Article No.
<b>SIMATIC IPC477D</b>	<b>6AV7240-</b>
Processor and fieldbus	
Operator control unit	
Main memory/NVRAM	
Expansions/interface	
Operating system	
Mass storage, externally accessible (without operating system)	
Internal mass storage	
SIMATIC Software preinstalled (bundles)	
Power supply	

For detailed ordering data see ST 80 / ST PC "Industrie PC -> Box PC -> SIMATIC IPC427D" or on the internet under:

<http://www.automation.siemens.com/mcms/pc-based-automation/en/embedded-bundles>

# PROFINET/Industrial Ethernet

## System interfaces for SIMATIC S7

### Introduction

### Overview

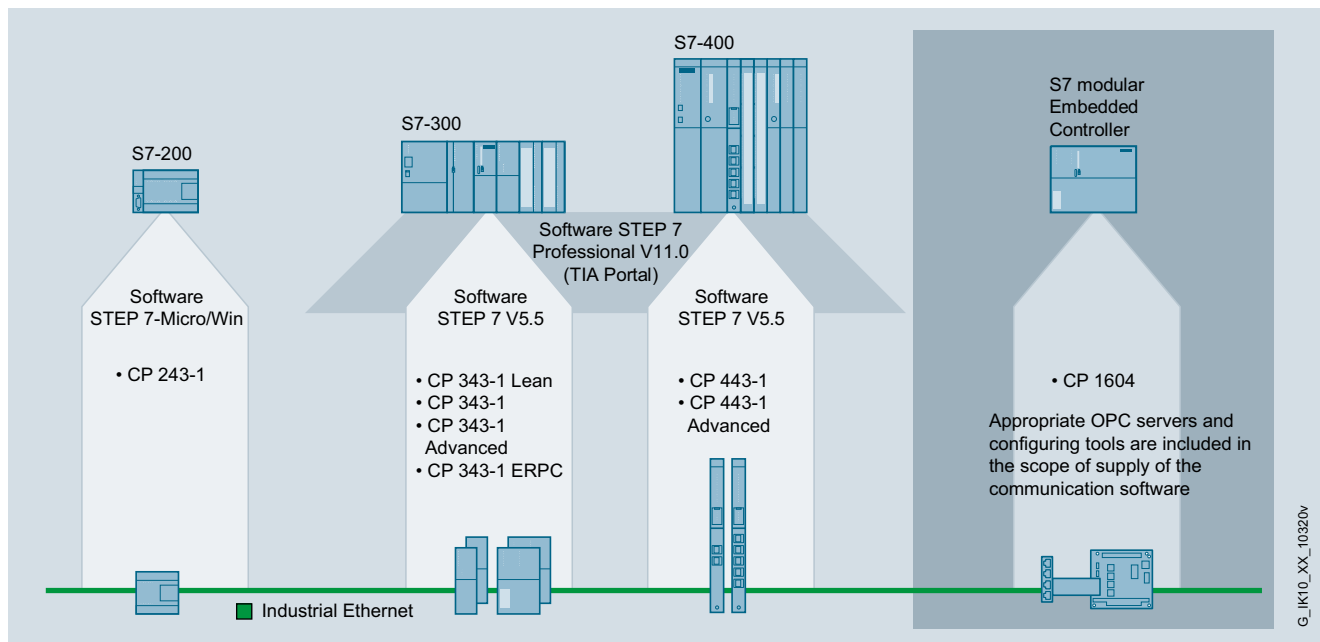

System connections for SIMATIC

Communication modules for SIMATIC allow further uses through additional functions using CPs such as security, integration in the customer's IT infrastructure, and network separation. In addition, they allow flexible expansion with additional communication interfaces for PROFIBUS or PROFINET depending on needs.

#### CPs with standard functions

- CP 243-1 for SIMATIC S7-200, CP 343-1 Lean and CP 343-1 for SIMATIC S7-300, CP 443-1 for SIMATIC S7-400, CM 1542-1 for SIMATIC S7-1500.
- Designed for use in harsh industrial environments
- Shipbuilding certification for use on ships and offshore units
- Additional integrated 2-port switch for CP 343-1 Lean, CP 343-1, CP 443-1 and CM 1542-1, e.g. for setting up Industrial Ethernet segments in linear and ring structures
- Increased availability through support for Media Redundancy Protocol (MRP)
- Can be used via RJ45 interface for the industrial-standard SIMATIC NET FastConnect cabling system
- High-speed data transfer even with large volumes of data (10/100 Mbit/s)

#### CPs with function expansions

- CP 343-1 Advanced for SIMATIC S7-300
  - With security functionality (firewall and VPN)
  - With IT functionality
  - Can be used as a PROFINET IO Controller and IO Device with real-time characteristics
  - PROFINET CBA
  - With Gigabit connection, incl. routing functionality (10/100/1 000 Mbit/s)
  - Network separation with IP-routing functionality
  - Additional integrated 2-port switch for setting up small local networks
  - Access protection via IP access list

- CP 343-1 ERPC optimized for linking to MES or ERP systems by means of additional partner software
- CP 443-1 Advanced for SIMATIC S7-400
  - With security functionality (firewall and VPN)
  - With IT functionality
  - Can be used as a PROFINET IO Controller with real-time characteristics
  - With Gigabit connection, incl. routing functionality (10/100/1000 Mbit/s)
  - Network separation with IP-routing functionality
  - Additional integrated 4-port switch for setting up small local networks
  - Access protection via IP access list
  - Operation in SIMATIC H system for redundant S7 communication
  - Operation in fail-safe applications (PROFIsafe) together with SIMATIC S7-400 CPU 416F
- The CP 443-1 RNA (Redundant Network Access <sup>1)</sup>) for interfacing to an S7-400 or S7-400H via the PRP redundancy protocol (Parallel Redundancy Protocol to IEC 62439-3) on parallel, separate networks, in which high reliability is required.
  - The CP supports:
    - PG/OP communication
    - S7 communication
    - Open communication (SEND/RECEIVE)
- CP 1243-1 for SIMATIC S7-1200
  - With security functionality (firewall and VPN)
  - With IT functionality
  - For remote diagnostics and remote maintenance
  - With TeleControl Basic functionality - rapid and flexible data communication via remote networks with caching of data values including automatic time stamping

<sup>1)</sup> At Siemens Industry, RNA stands for hardware and software for implementing redundancy solutions. RNA contains the PRP V1 protocol in accordance with the IEC 62439-3 standard (Parallel Redundancy Protocol) as well as the HSR protocol in accordance with IEC 62439-3 (High-availability Seamless Redundancy Protocol).

G\_IK10\_xx\_10320v

### Overview (continued)

- CP 1543-1 for SIMATIC S7-1500
  - With security functionality (firewall and VPN)
  - With IT functionality
  - For integrating the S7-1500 into IPv6 based networks.
- For the following communications services, an IP address according to IPv6 can be used:
  - FETCH/WRITE access (CP is server)
  - FTP server mode and FTP client mode with addressing via program block
  - E-mail transfer with addressing via program block

### Setup of Industrial Ethernet segments with SIMATIC modules with integrated switch

To set up Industrial Ethernet segments in a line or ring topology, all PROFINET communication modules offer integrated 100 Mbit/s switches with at least 2 RJ45 ports. The integration of the switch in the terminal devices allows the setup of very flexible networks and saves cabling costs.

2

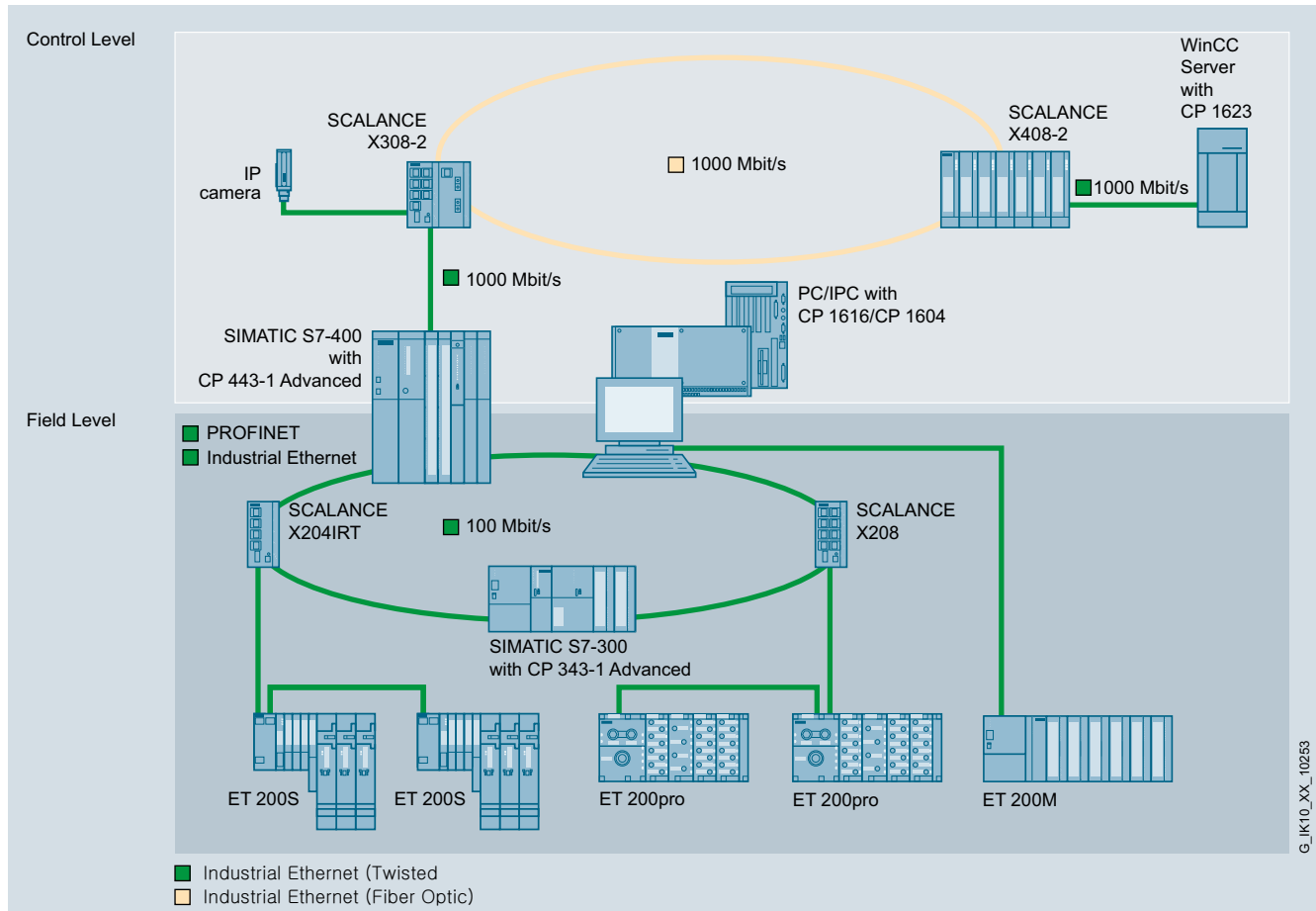

# PROFINET/Industrial Ethernet

## System interfaces for SIMATIC S7

### Introduction

### Overview (continued)

2

	Hardware	PROFINET						Ethernet communication					IT communication					Security			Transport protocol					Time			Other							
		IO Controller	IO Device	IRT real-time	CBA	MRP	MRPD	Send/Receive	Fetch/Write	TSend/TReceive	S7 communication	PG/OP communication	S7 routing	Web diagnosis	own web pages	send e-mail	receive e-mail	Filetransfer client	Filetransfer server	Access List ACL	SPI firewall	VPN (IP-Sec)	ISO	TCP	UDP	IPv4	IPv6	IP routing	Sender	Receiver	Transfer	PRP	ERP Connect	SNMP	NTP	
SIMATIC S7-200	CP 243-1									•	•		•	•	•		•	•							•										○	
SIMATIC S7-1200	S7-1200 CPUs	•							•	•	•	•	•	•									•	•	•				•					○	•	
	CP 1243-1								•	•	•	•	•	• <sup>2)</sup>					•	•	•		•	•	•	○			•					○	•	
SIMATIC S7-1500	CPU 1511-1 PN	•	•	•		•			•	•	•	•	•	•				•					•	•	•			•	•				○	•		
	CPU 1513-1 PN	•	•	•		•			•	•	•	•	•	•				•					•	•	•			•	•					○	•	
	CPU 1516-3 PN/DP	•	•	•		•			•	•	•	•	•	•				•					•	•	•			•	•					○	•	
	CP 1543-1						•	•	•	•	•	•	•	• <sup>2)</sup>		•		•	•	•	•	•	•	•	•	○			•	•				•	•	
	CM 1542-1	•	•			•				•	•	•	•	• <sup>2)</sup>		○ <sup>1)</sup>								•	•	•			•	•				•	•	
SIMATIC S7-300	S7-300 PN CPUs	•	•	•	•	•			•	○ <sup>3)</sup>	•	•	•	•										•	•	•			•	•					•	
	CP 343-1 Lean		•			•		•	•		•	•	•	•				•					•	•	•				•	•				•	•	
	CP 343-1	•	•			•		•	•		•	•	•	•				•				•	•	•				•	•					•	•	
	CP 343-1 Adv	•	•	•	•	•		•	•		•	•	•	•		•		•	•	•	•	•	•	•	•		•	•	•					•	•	
	CP 343-1 ERPC						•	•		•	•	•	•	•				•					•	•	•			•	•	•		•	○	•	•	
SIMATIC S7-400	S7-400 PN CPUs	•	•	•	•	•			•	•	•	•	•	•									•	•	•			•	•						•	
	CP 443-1	•		•		•		•	•	○ <sup>4)</sup>	•	•	•	•				•				•	•	•	•				•					•	•	
	CP 443-1 Adv	•		•	•	•		•	•	○ <sup>4)</sup>	•	•	•	•		•		•		•	•	•	•	•		•		•						•	•	
	CP 443-1 RNA						•	•	•	•	•	•	•	•				•				•	•	•	•				•	•				•	•	

1) SMTP pass-through only  
 2) via S7-1200/1500 CPU  
 3) Server (S) only  
 4) pass-through only

• applies  
 ○ with reservations

G\_IK10\_XX\_10369

Communications overview for SIMATIC



### Overview



The CP 1243-1 communications processor is used for connecting a SIMATIC S7-1200 to the TeleControl Server Basic control center software via Ethernet, and for safe communication via IP-based networks.

The CP has the following features:

- Ethernet-based connection to TeleControl Server basic, e.g. via Internet
- Data transfer of measured values, control variables, or alarms optimized for telecontrol systems
- Automatic sending of alert emails
- Data buffering of up to 64,000 values ensures a secure database even with temporary connection failures
- Secure communication via VPN connections based on IPSec
- Access protection by means of Stateful Inspection Firewall
- Clearly laid out LED signaling for fast and easy diagnostics
- Compact industrial enclosure in S7-1200 design for mounting on a standard mounting rail
- Fast commissioning thanks to easy configuration using STEP 7

### Benefits



- **Data security**  
The CP 1243-1 has a large buffer for several thousand data values. Downtimes in the transmission link can then be bridged.
- **Fully automatic time stamp**  
To enable subsequent and correct archiving of process data in the control system, all data frames are assigned with a time stamp at their place of origin.
- **Fast and flexible data communication**  
Operators are therefore quickly provided with alarms, statuses and values from the process, and they can influence process control by entering commands or setpoints at any time.
- **Simple and low-cost engineering**  
The cyclic or event-controller transfer of measurements, setpoints or alarms can be implemented in only a few operations and without programming effort.
- **Remote diagnostics**  
Saving of traveling and maintenance costs due to cost-effective remote programming, diagnostics, control and monitoring via the Internet
- **Industrial Security**  
Securing the system against unauthorized access by means of
  - Central access protection for any devices within an automation cell, e.g. by means of authentication of the network stations
  - Secure remote access via the Internet by means of data encryption (VPN) and data integrity checking

### Application

By using the CP 1243-1, the S7-1200 can be used as a remote terminal unit (substation) in telecontrol applications. Typical uses include the collection of measured values in geographically widely distributed outdoor areas (level measurement for water tanks) or centralized opening and closing of valves (oil/gas transport in pipelines).

- Plants in water, wastewater or environmental sectors:
  - Irrigation systems
  - Drinking water supply
- Monitoring of power networks for consumption metering and cost control
  - District heating networks
  - Wind farms
- Plants in the oil and gas sector
  - Oilfield water injection
  - Pipelines

Regardless of the telecontrol features of the CP, it can also be used for purely security applications if the automation system is to be connected securely to a higher-level IT network. This protects the SIMATIC S7-1200 against unauthorized access from an Ethernet network. The CP 1243-1 allows safe access via a LAN and allows data transfer between devices or network segments to be protected from data manipulation/espionage.

## PROFINET/Industrial Ethernet Communication for SIMATIC S7-1200

### CP 1243-1

#### Design (continued)

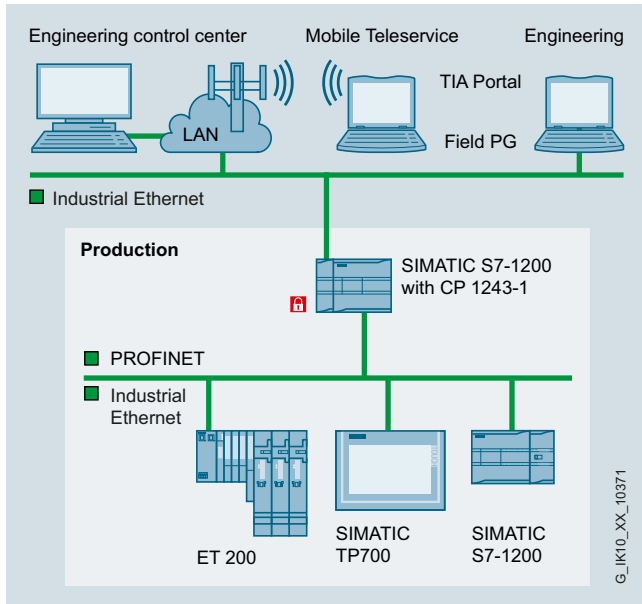

Cell protection for SIMATIC S7-1200 with CP 1243-1 (Security Integrated)

#### Design

The CP 1243-1 offers all the advantages of the S7-1200 design:

- Rugged, compact plastic enclosure
- Easily accessible connection and diagnostics elements, protected by front flaps
- Simple mounting on the mounting rail of the S7-1200

The CP 1243-1 DNP3 is plugged into the left-hand system bus interface of the S7-1200. Power is supplied directly via the S7-1200. No additional wiring is necessary. Any required modems or routers are connected via the Ethernet interface on the underside of the module.

#### Function

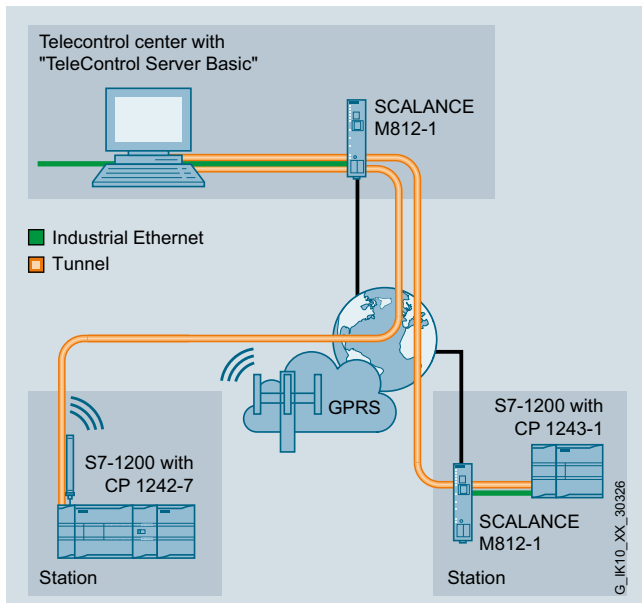

Connection of the S7-1200 to TeleControl Servers via mobile wireless and DSL Internet access

The CP 1243-1 is a communication module for the S7-1200. The module allows the S7-1200 to be connected as a remote station to TeleControl Server basic in just a few steps.

#### Completely configurable application through "data point configuration"

The introduction of the "data point configuration" in STEP 7 dispenses with all programming effort for transfer of data to the control center.

The data of the CPU relevant to the control center is selected via user-friendly "item browsing" in STEP 7. In a clearly-arranged menu, the data transfer parameters are then assigned to the data points selected in this way. The cyclic or event-controller transfer of measurements, setpoints or alarms can thus be implemented in only a few operations and without programming effort.

#### Data backup

Data losses are prevented by the data buffering mechanisms integrated in the product.

In the event of a connection failure, up to 64,000 time-stamped values are buffered. When the connection returns, the buffered values are automatically transferred to the control center in the right order.

#### E-mail alerting

Alert e-mails can be configured for timely provision of stations' states to service or maintenance personnel. If previously defined events (such as threshold violation) should occur, application-specific information is sent automatically by e-mail.

#### Diagnostics

The CP 1243-1 offers comprehensive diagnostic options for a quick and informative analysis of the station status. Elementary diagnostic information about the connection to the control center is signaled directly via LEDs at the CP.

Using STEP 7, comprehensive information can be retrieved, such as connection history, buffer status, and the transferred measured values.

#### Remote maintenance

For remote access from the control center to the substation, the CP provides a remote maintenance port in parallel with process operation. This ensures access for monitoring and program changes.

#### Interfaces

The CP 1243-1 has an Ethernet interface to connection to the control center. The S7-1200 can be connected via an existing network or via other media by using additional routers (e.g. SCALANCE M for Internet connection via DSL).

#### Power supply

Extra wiring for the CP power supply is not required. Power is supplied directly via the backplane bus of the S7-1200.

### Technical specifications

Article No.	6GK7243-1BX30-0XE0	Article No.	6GK7243-1BX30-0XE0
Product-type designation	CP 1243-1	Product-type designation	CP 1243-1
<b>Transmission rate</b>		<b>Performance data</b>	
Transfer rate		<u>Performance data</u> <u>open communication</u>	
• at the interface 1	10 ... 100 Mbit/s	• note	like CPU
<b>Interfaces</b>		<u>Performance data</u> <u>S7 communication</u>	
Number of electrical connections		Number of possible connections for S7 communication	
• at interface 1 in accordance with Industrial Ethernet	1	• note	like CPU
Design of electrical connection		<u>Performance data</u> <u>data telecontrol</u>	
• at interface 1 in accordance with Industrial Ethernet	RJ45 port	Suitability for use	
<b>Supply voltage, current consumption, power loss</b>		• node station	No
Type of supply voltage	DC	• substation	Yes
Supply voltage 1 from backplane bus	5 V	• control center	No
Resistive loss	1.25 W	Connection to the control center	STEP 7 Basic/Professional V13 (TIA Portal) or higher + HSP
<b>Permitted ambient conditions</b>		• note	Connection to SCADA Systems via TeleControl Server Basic supported
Ambient temperature		• by means of a permanent connection	
• for vertical installation during operating phase	-20 ... +60 °C	Protocol is supported	
• for horizontal installation during operating phase	-20 ... +70 °C	• DNP3	No
• during storage	-40 ... +70 °C	• IEC 60870-5	No
• during transport	-40 ... +70 °C	Product function data buffering if connection is aborted	Yes
Relative humidity at 25 °C without condensation during operating maximum	95 %	• note	64.000 values
Protection class IP	IP20	Number of data points per station maximum	200
<b>Design, dimensions and weight</b>		<u>Performance data</u> <u>Teleservice</u>	
Module format	Compact module S7-1200 single width	Diagnostic function online diagnostics with SIMATIC STEP 7	Yes
Width	30 mm	Product function	
Height	110 mm	• program download with SIMATIC STEP 7	Yes
Depth	75 mm	• remote firmware update	Yes
Net weight	0.122 kg	<b>Product functions management, configuration</b>	
<b>Product properties, functions, components general</b>		Configuration software required	STEP 7 Basic/Professional V13 (TIA Portal) or higher + HSP
Number of modules		<b>Product functions Security</b>	
• per CPU maximum	3	Design of the firewall	stateful inspection
		Product function with VPN connection	IPSec
		Type of authentication procedure with VPN connection	Preshared key (PSK), X.509v3 certificates
		Type of hashing algorithms with VPN connection	MD5, SHA-1
		Number of possible connections for VPN connection	8
		Product function	
		• password protection for Web applications	No
		• ACL - IP-based	No
		• ACL - IP-based for PLC/routing	No
		• switchoff of non-required services	Yes
		• blocking of communication via physical ports	No
		• log file for unauthorized access	No
		<b>Product functions Time</b>	
		Protocol is supported NTP	No

# PROFINET/Industrial Ethernet

## Communication for SIMATIC S7-1200

CP 1243-1

Ordering data	Article No.	Article No.
<b>Communications processor CP 1243-1</b> Communications processor for connection of SIMATIC S7-1200 to TeleControl Server Basic or for secure connection via IP-based networks	<b>6GK7243-1BX30-0XE0</b>	
<b>Accessories</b> <b>TeleControl Server Basic V3.0</b> Software for 8 to 5 000 stations; Single License for one installation; OPC (UA) server for GPRS and Ethernet/Internet communication with SIMATIC S7-1200 and SIMATIC S7-200 (GPRS only); connection management to remote stations; routing for connections between S7 stations; German and English operator interface; for Windows 7 Professional 32/64-bit + Service Pack 1 Windows 7 Enterprise 32/64-bit + Service Pack 1 Windows 7 Ultimate 32/64-bit + Service Pack 1 Windows Server 2008 32-bit + Service Pack 2 Windows Server 2008 R2 Standard 64-bit Service Pack 1 <ul style="list-style-type: none"> <li>• <b>TeleControl Server Basic 8 V3</b> Connection management for 8 SIMATIC S7-1200 or S7-200 stations</li> <li>• <b>TeleControl Server Basic 32 V3</b> Connection management for 32 SIMATIC S7-1200 or S7-200 stations</li> <li>• <b>TeleControl Server Basic 64 V3</b> Connection management for 64 SIMATIC S7-1200 or S7-200 stations</li> <li>• <b>TeleControl Server Basic 256 V3</b> Connection management for 256 SIMATIC S7-1200 or S7-200 stations</li> <li>• <b>TeleControl Server Basic 1000 V3</b> Connection management for 1 000 SIMATIC S7-1200 or S7-200 stations</li> <li>• <b>TeleControl Server Basic 5000 V3</b> Connection management for 5 000 SIMATIC S7-1200 or S7-200 stations</li> <li>• <b>TeleControl Server Basic UPGR V3</b> Upgrade package from Version V2.x to V3 for all license sizes</li> </ul>		
<b>CSM 1277 Compact Switch Module</b> Unmanaged switch for connecting a SIMATIC S7-1200 and up to three further nodes to Industrial Ethernet with 10/100 Mbit/s; 4 x RJ45 ports; external 24 V DC power supply, diagnostics on LEDs, S7-1200 module including electronic manual on CD-ROM	<b>6GK7277-1AA10-0AA0</b>	
		<b>Accessories (continued)</b> <b>IE FC RJ45 Plugs</b> RJ45 plug connector for Industrial Ethernet with a rugged metal housing and integrated insulation displacement contacts for connecting Industrial Ethernet FC installation cables; 180° cable outlet; for network components and CPs/CPU with Industrial Ethernet interface <ul style="list-style-type: none"> <li>• 1 pack = 1 unit</li> <li>• 1 pack = 10 units</li> <li>• 1 pack = 50 units</li> </ul>
		<b>IE FC TP Standard Cable GP 2 x 2 (Type A)</b> 4-core, shielded TP installation cable for connection to IE FC Outlet RJ45/ IE FC RJ45 Plug; PROFINET-compatible; with UL approval; Sold by the meter; max. length 1 000 m; minimum order 20 m
		<b>IE FC Stripping Tool</b> Preadjusted stripping tool for fast stripping of Industrial Ethernet FC cables
		<b>STEP 7 Basic Engineering Software V13 (TIA Portal)</b> <i>Target system:</i> SIMATIC S7-1200, S7-1500, S7-300, S7-400, WinAC <i>Requirement:</i> Windows 7 Professional (64 bit), Windows 7 Enterprise (64 bit), Windows 7 Ultimate SP1 (64 bit), Windows 8.1 (64 bit), Windows 8.1 Professional (64 bit), Windows 8.1 Enterprise (64 bit), Windows Server 2008 R2 StdE (full installation), Windows Server 2012 StdE (full installation) <i>Form of delivery:</i> German, English, Chinese, Italian, French, Spanish <ul style="list-style-type: none"> <li>• STEP 7 Basic V13, Floating License</li> <li>• STEP 7 Basic V13, Trial License</li> <li>• Upgrade STEP 7 Basic V12 to STEP 7 Professional Basic V13, Floating License</li> </ul>
		<b>Software Update Service</b> For a period of 12 months and for a fixed price, the customer is automatically provided with all upgrades and service packs for each installed software package. The contract is automatically extended by a further year unless canceled at least 12 weeks prior to expiration. Requires the current software version. <ul style="list-style-type: none"> <li>• STEP 7 Basic V1x, Software Update Service Standard, 1 year</li> <li>• STEP 7 Basic V1x, Software Update Service Compact, 1 year;</li> </ul>

### More information

#### Technical requirements/compatibility

A S7-1200 CPU with firmware version 3 is required to operate the CP 1243-1.

The CP 1243-1 can be configured with STEP 7 Basic/Professional V13 (TIA Portal) or higher.

The TeleControl Server Basic V3 software package is required to connect to the PCS 7/WinCC control center systems.

### Overview

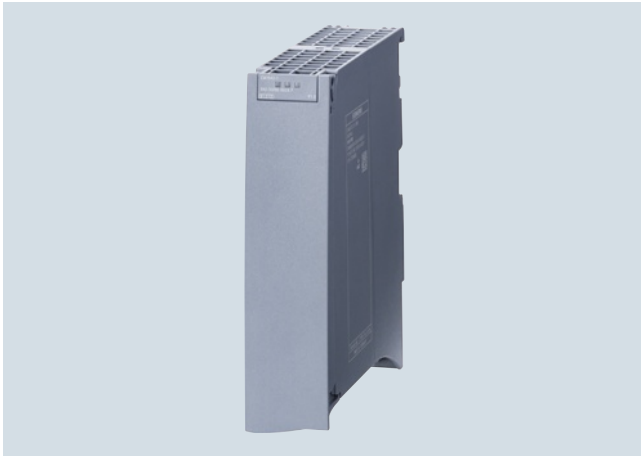

ISO	TCP/UDP	PN	MRP	IT	IP-R	PG/OP	S7/S5
	●	●	●	●		●	●

Communication module for connecting a SIMATIC S7-1500 to PROFINET networks as PROFINET IO controller.

The CM 1542-1 supports the following communication services:

- PG/OP communication
- S7 communication
- Open communication (SEND/RECEIVE)
- PROFINET communication
- IT communication;  
web diagnose by means of access to the Web server of the S7-1500 system

### Benefits



- High level of plant availability due to support of media redundancy (MRP)
- Optimum support of maintenance due to
  - Web-based diagnostics
  - Monitoring with IT network management tools (SNMP)
  - Module replacement without a PG

### Application

The CM 1542-1 is used to connect the SIMATIC S7-1500 to PROFINET networks. With its own processor, it relieves the CPU of communications tasks and facilitates additional connections.

The CM 1542-1 provides communication options with:

- PGs/PCs,
- master computers
- operator control and monitoring systems,
- SIMATIC S5/S7 systems
- PROFINET IO devices
- Remote programming via LAN

### Design

The CM 1542-1 features all the advantages of the SIMATIC S7-1500 design:

- Compact design:
  - Two RJ45 ports (integrated 2-port switch) for connecting to PROFINET with 10/100 Mbit/s full/half-duplex; automatic data rate detection through autonegotiation and autocrossing;
  - connection via an IE FC RJ45 Plug 180 with 180° cable outlet or via standard patch cable
  - The module is supplied with power via the integrated backplane bus
  - Three LEDs for displaying the operational and communications status of the module and two status LEDs (LINK/ACTIVITY) under the front cover for the PROFINET interface
- Simple installation:
  - The CM 1542-1 is mounted on the mounting rail of the S7-1500 and connected to the adjacent modules by means of the bus connectors.
- The CM 1542-1 can be operated without a fan; no backup battery is required.
- The module can be replaced without the need for a programming device.

## PROFINET/Industrial Ethernet

### Communication for SIMATIC S7-1500

CM 1542-1

#### Function

- PROFINET IO controller for the connection of up to 128 PN IO devices
- Communications services of the interface:
  - Open communication (TCP/IP, UDP): Multicast with UDP
  - PG/OP communication: inter-network with S7 routing
  - S7 communication (client, server)
  - IT communication (HTTP(S), e-mail)
  - Certified PROFINET IO controller with real-time properties (RT and IRT)
  - IP addressing via DCP
- Media redundancy (MRP);
  - Within an Ethernet network with a ring topology, the CM supports the MRP media redundancy protocol as an MRP manager and/or as an MRP client
- Diagnostics and network management:
  - Extensive diagnostics functions for all modules in the S7-1500 system
  - Integration in network management systems through the support of SNMP V1
- Time synchronization via NTP
- Security mechanisms:
  - Access to the Web server via HTTPS
  - Secure firmware update
- Configuration of all functions with STEP 7 Professional V13 (TIA Portal) or higher
- Module replacement without programming device: All information can be stored on the memory card of the CPU.

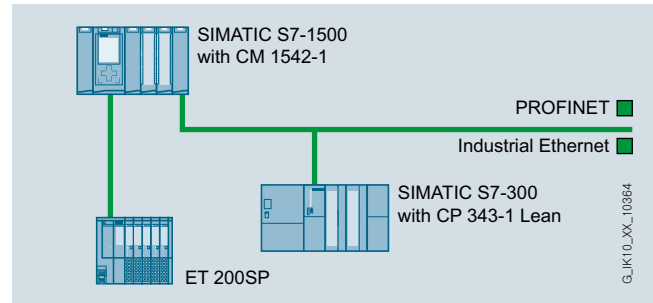

Use as PROFINET IO controller for operating distributed I/O on PROFINET

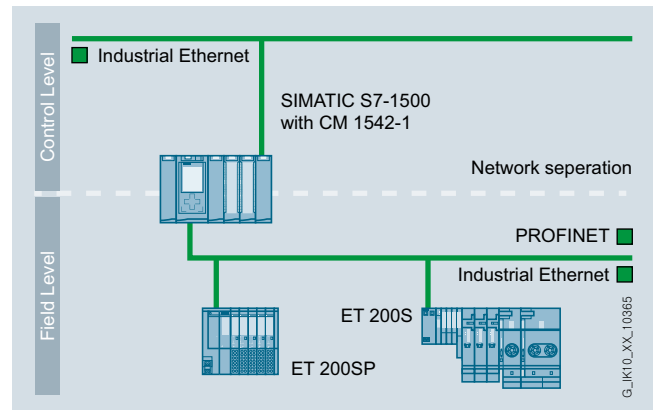

Connection to a higher-level network with CM 1542-1 for network separation of the field level and control level

**Technical specifications**

Article No.	6GK7542-1AX00-0XE0
Product-type designation	CM 1542-1
<b>Transmission rate</b>	
Transfer rate • at the interface 1	10 ... 100 Mbit/s
<b>Interfaces</b>	
Number of electrical connections • at interface 1 in accordance with Industrial Ethernet	2
Design of electrical connection • at interface 1 in accordance with Industrial Ethernet	RJ45 port
<b>Supply voltage, current consumption, power loss</b>	
Type of supply voltage	DC
Supply voltage 1 from backplane bus	15 V
Relative symmetrical tolerance at 15 V with DC	3 %
Current consumption from backplane bus at 15 V with DC typical	0.22 A
Resistive loss	3.3 W
<b>Permitted ambient conditions</b>	
Ambient temperature • for vertical installation during operating phase	0 ... 40 °C
• for horizontal installation during operating phase	0 ... 60 °C
• during storage	-40 ... +70 °C
• during transport	-40 ... +70 °C
• Comment	-
Relative humidity at 25 °C without condensation during operating maximum	95 %
Protection class IP	IP20
<b>Design, dimensions and weight</b>	
Module format	Compact module S7-1500 single width
Width	35 mm
Height	142 mm
Depth	129 mm
Net weight	0.4 kg
Mounting type S7-1500 rail mounting	Yes
<b>Product properties, functions, components general</b>	
Number of modules • per CPU maximum • note	8 depending on CPU type

Article No.	6GK7542-1AX00-0XE0
Product-type designation	CM 1542-1
<b>Performance data</b>	
<u>Performance data open communication</u>	
Number of possible connections for open communication via T-modules • maximum • comment	64 depending on the system upper limit
Data volume as user data per ISO on TCP connection for open communication by means of T blocks maximum	65 536 byte
Number of Multicast stations	16
<u>Performance data S7 communication</u>	
Number of possible connections for S7 communication • maximum • note	64 depending on the system upper limit
<u>Performance data multi-protocol mode</u>	
Number of active connections with multiprotocol mode	64
<u>Performance data PROFINET communication as PN IO-Controller</u>	
Product function PROFINET IO controller	Yes
Number of PN IO-Devices on PROFINET IO-Controller usable total	128
Number of PN IO IRT-Devices on PROFINET IO-Controller usable	64
Number of external PN IO lines with PROFINET per rack	10
Data volume	
• as useful data for input variables as PROFINET IO controller maximum	8 Kibyte
• as useful data for output variables with PROFINET IO controller maximum	8 Kibyte
• as useful data for input variables per PN IO device with PROFINET IO controller maximum	1 433 byte
• as useful data for output variables per PN IO device with PROFINET IO controller maximum	1 433 byte
• as user data for input variable per PN IO device per submodule as PROFINET IO controller maximum	256 byte
• as user data for output variables per PN IO device per submodule as PROFINET IO controller maximum	256 byte
<b>Product functions management, configuration</b>	
Product function MIB support	Yes
Protocol is supported • SNMP v1 • DCP • LLDP	Yes Yes Yes
Configuration software required	STEP 7 Professional V13 (TIA Portal) or higher
Identification & maintenance function	
• I&M0 - device-specific information	Yes
• I&M1 - higher level designation/location designation	Yes

## PROFINET/Industrial Ethernet

### Communication for SIMATIC S7-1500

#### CM 1542-1

#### Technical specifications (continued)

<b>Article No.</b>	<b>6GK7542-1AX00-0XE0</b>
<b>Product-type designation</b>	<b>CM 1542-1</b>
<b>Product functions Diagnosis</b>	
Product function Web-based diagnostics	Yes
<b>Product functions switch</b>	
Product feature switch	Yes
Product function	
• switch-managed	No
• for IRT PROFINET IO switch	Yes
• Configuration with STEP 7	Yes
<b>Product functions Redundancy</b>	
Product function	
• Ring redundancy	Yes
• Redundancy manager	Yes
• Media Redundancy Protocol (MRP)	Yes

<b>Article No.</b>	<b>6GK7542-1AX00-0XE0</b>
<b>Product-type designation</b>	<b>CM 1542-1</b>
<b>Product functions Security</b>	
Product function	
• switchoff of non-required services	Yes
• blocking of communication via physical ports	No
• log file for unauthorized access	No
<b>Product functions Time</b>	
Product function	
• SICLOCK support	Yes
• pass on time synchronization	Yes
Protocol is supported NTP	Yes

#### Ordering data

<b>Communication module</b> <b>CM 1542-1</b>	<b>Article No.</b> <b>6GK7542-1AX00-0XE0</b>
for connection of SIMATIC S7-1500 to PROFINET IO via TCP/IP, ISO-on-TCP, UDP S7 communication, IP broadcast/multicast, SNMPv1, time synchronization via NTP; 1 x RJ45 interface with 10/100 Mbit/s;	
<b>Accessories</b>	
<b>IE FC RJ45 Plug 4 x 2</b>	
RJ45 plug connector for Industrial Ethernet (10/100/1000 Mbit/s) with a sturdy metal enclosure and integrated insulation displacement contacts for connecting Industrial Ethernet FC installation cables; 180° cable outlet; for network components and CPUs/CPUUs with Industrial Ethernet interface	
• 1 pack = 1 unit	<b>6GK1901-1BB11-2AA0</b>
• 1 pack = 10 units	<b>6GK1901-1BB11-2AB0</b>
• 1 pack = 50 units	<b>6GK1901-1BB11-2AE0</b>
<b>IE FC TP Standard Cable GP 4 x 2</b>	
8-core, shielded TP installation cable for connection to IE FC RJ45 Modular Outlet for universal applications; with UL approval; sold by the meter; max. quantity 1 000 m, minimum order 20 m	
• AWG22, for connection to IE FC RJ45 Modular Outlet	<b>6XV1870-2E</b>
• AWG24, for connection to IE FC RJ45 Plug 4 x 2	<b>6XV1878-2A</b>

#### Article No.

#### Accessories (continued)

<b>SCALANCE X204-2 Industrial Ethernet Switch</b>	<b>Article No.</b> <b>6GK5204-2BB10-2AA3</b>
Industrial Ethernet Switches with integral SNMP access, Web diagnostics, copper cable diagnostics and PROFINET diagnostics for configuring line, star and ring topologies; four 10/100 Mbit/s RJ45 ports and two FO ports	
<b>Industrial Ethernet Switch SCALANCE X308-2</b>	<b>Article No.</b> <b>6GK5308-2FL00-2AA3</b>
2 x 1000 Mbit/s multimode fiber-optic cable ports (SC sockets), , , 1 x 10/100/1 000 Mbit/s RJ45 port, 7 x 10/100 Mbit/s RJ45 ports; for glass fiber-optic cable (multimode) up to max. 750 m	

#### More information

You will find more information on SIMATIC S7-1500 at <http://www.siemens.com/simatic-s7-1500>

The SIMATIC NET Selection Tool is available to assist in selecting the right Industrial Ethernet switches as well as the configuration of modular variants:

Online version:  
<http://www.siemens.com/snst>

Offline version:  
<http://www.siemens.com/snst-download>

You will find more information on the topic of Industrial Security on the Internet at:  
<http://www.siemens.com/industrialsecurity>



### Overview



ISO	TCP/UDP	PN	MRP	IT	IP-R	PG/OP	S7/S5
●	●			●		●	●

The SIMATIC CP 1543-1 communications processor securely connects the new SIMATIC S7-1500 controller to Industrial Ethernet networks. By combining a variety of security features such as an SPI (Stateful Packet Inspection) firewall, VPN and data encryption protocols such as FTPS and SNMPv3, the communications processor protects individual S7-1500 stations or even entire automation cells against unauthorized access.

The CP can also be used for linking the S7-1500 station into an IPv6-based network. All functions are configured by means of STEP 7 Professional V12 (TIA Portal) or higher.

The CP 1543-1 supports the following communications services:

- PG/OP communication
- S7 communication
- Open communication (SEND/RECEIVE, FETCH/WRITE)
- IT communication
  - FTP functions (File Transfer Protocol FTP/FTPS) for file management and access to data blocks in the CPU (client and server function)
  - Sending e-mails via SMTP or ESMTP with "SMTP-Auth" for authentication on an e-mail server (also with IPv6)
- Security functions
  - Stateful Packet Inspection (layers 3 and 4) firewall
  - Secure communication via VPN (IPsec)
  - Secure access to the Web server of the CPU via the HTTPS protocol
  - Secure file transfer using FTPS
  - Secure transfer of the time of day (NTP)
  - SNMPv3 for tap-proof transfer of network analysis information
- Integration of the S7-1500 into IPv6-based networks; An IPv6-compliant IP address can be used for the following communication services:
  - FETCH/WRITE access (CP as server)
  - FTP server mode
  - FTP client mode with addressing by program block
  - E-mail transfer with addressing by program block

### Benefits



- Reachability of the SIMATIC S7-1500 station from an IPv6-based infrastructure
- Optimum support of maintenance due to
  - Simple diagnostics via the central Web server
  - Remote programming via LAN
  - Monitoring with IT network management tools (SNMP)
  - Module replacement without a PG
- Securing the system against unauthorized access with
  - Central access protection for any S7 station
  - Secure access to the central Web server
- Network separation for setting up identical machines with the same IP address
- Simple alerting by e-mail and transfer of production data to master computer using FTP
- Protection of investment thanks to simple integration of the SIMATIC S7-1500 system in existing networks with SIMATIC S7-300 / S7-400 / S5 via Industrial Ethernet using the CP 1543-1

### Application

The CP 1543-1 is used to connect the SIMATIC S7-1500 to Industrial Ethernet networks. With its own processor, it relieves the CPU of communications tasks and facilitates additional connections.

The CP 1543-1 provides communication options with:

- PGs/PCs,
- master computers
- operator control and monitoring systems,
- other SIMATIC S5/S7 systems.

This can be used to protect the SIMATIC S7-1500 from unauthorized access from an Ethernet network. The CP 1543-1 allows safe remote access via a LAN and allows data transfer between devices or network segments to be protected from data manipulation/espionage.

# PROFINET/Industrial Ethernet

## Communication for SIMATIC S7-1500

CP 1543-1

### Application (continued)

2

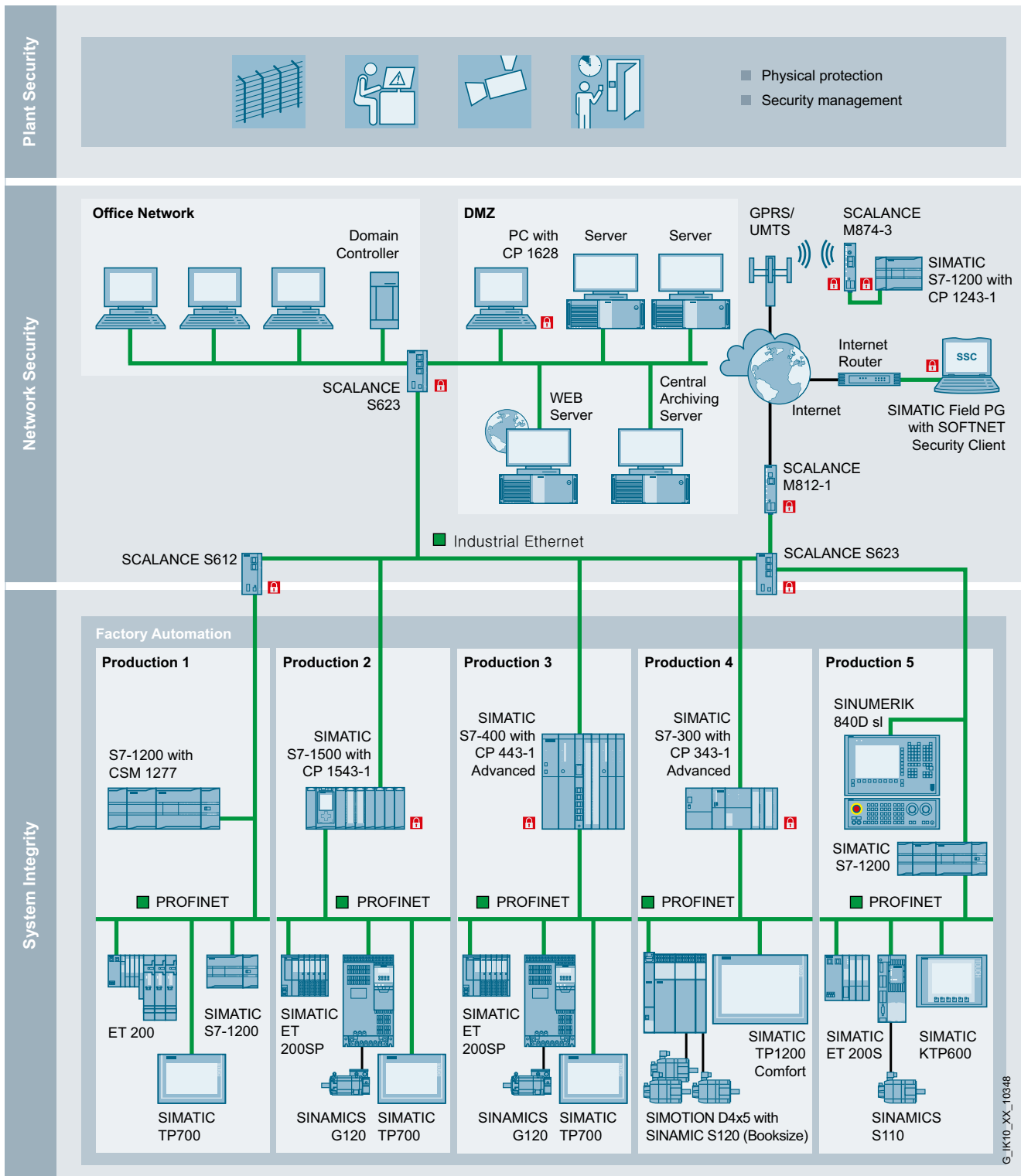

Protection of the SIMATIC S7-1500 system from unauthorized access from the Industrial Ethernet network

G\_IK10\_XX\_10348

### Design

The CP 1543-1 features all the advantages of the SIMATIC S7-1500 design:

- Compact design:
  - One RJ45 jack for connecting to Industrial Ethernet; automatic data rate detection using autosensing, autocrossing and autonegotiation; the connection is made via the IE FC RJ45 Plug 180 with 180° cable outlet or via a standard patch cable
  - The module is supplied with power via the integrated backplane bus
  - Three LEDs for displaying the operational and communications status of the module and one LED under the front cover for the Ethernet interface to display ACTIVITY and LINK.
- Simple installation:
 

The CP 1543-1 is mounted on the rail of the S7-1500 and connected to the adjacent modules by means of the bus connectors.
- The CP 1543-1 can be operated without a fan; no backup battery is required.
- The module can be replaced without the need for a programming device.

### Function

- Gigabit interface with an RJ45 connector with 10/100/1 000 Mbps full/half duplex with autosensing functionality
- Communication services:
  - Open communication (TCP/IP, UDP, ISO): Multicast with UDP
  - PG/OP communication: inter-network with S7 routing
  - S7 communication (client, server)
  - IT communication:
    - HTTP communication allows access to the Web server of the S7-1500 system. With the CP 1543-1, HTTPS communication is also possible.
    - The e-mail client function allows the sending of e-mails directly from the user program.
    - FTP communication allows program-controlled FTP client communication.
    - Access to data blocks in the CPU via FTP server.
  - IP address assignment using DHCP with IPv4 or by entering the address directly in the engineering software STEP 7 Professional V12 or higher (TIA Portal)
- Diagnostics and network management:
  - Extensive diagnostics functions for all modules in the S7-1500 system
  - Integration in network management systems due to support of SNMP V1/V3
- Security mechanisms:
  - Access protection with firewall for filtering connections on the basis of their IP and MAC addresses
  - Secure communication via VPN (IPsec)
  - Encrypted HTML pages using SSL (HTTPS)
  - Secure file transfer (FTPS)
  - Tap-proof transfer of network analysis information to the network management system (SNMPv3)
  - Secure transfer of the time of day (NTP)
- Configuration of all functions with STEP 7 Professional V13 (TIA Portal) or higher
- Module replacement without programming device:
 

All information can be stored on the memory card of the CPU.

# PROFINET/Industrial Ethernet

## Communication for SIMATIC S7-1500

CP 1543-1

### Integration

2

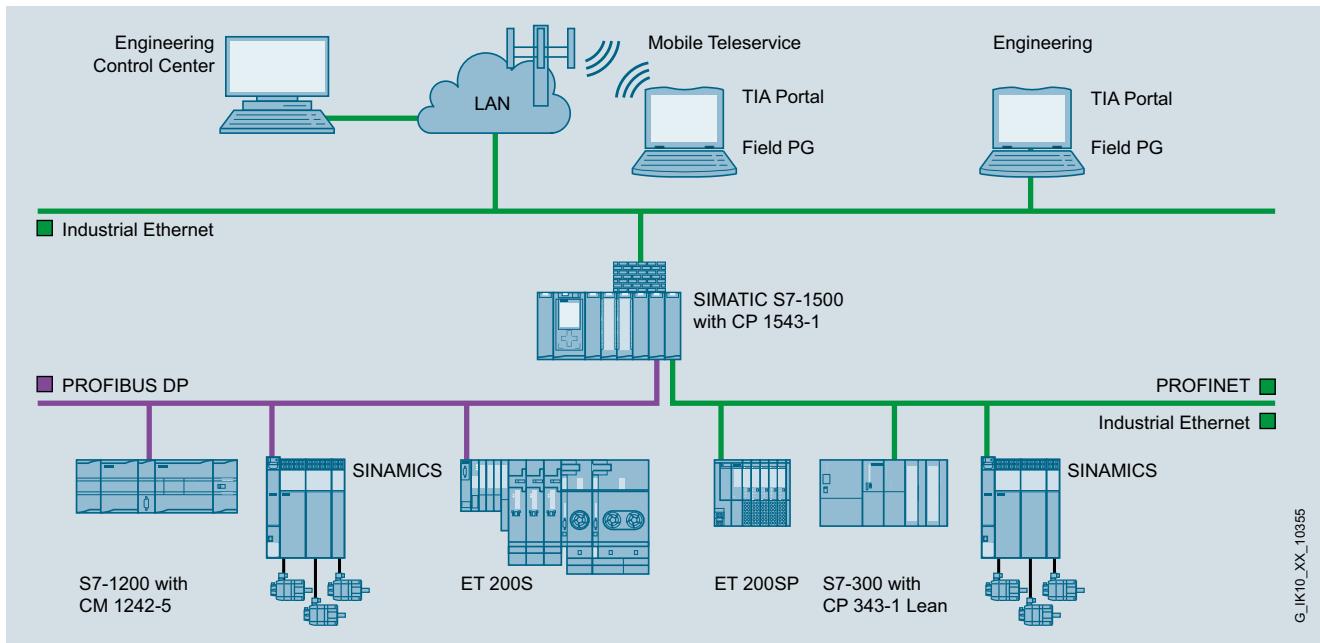

Connection to a higher-level network with network separation and access protection (firewall function)

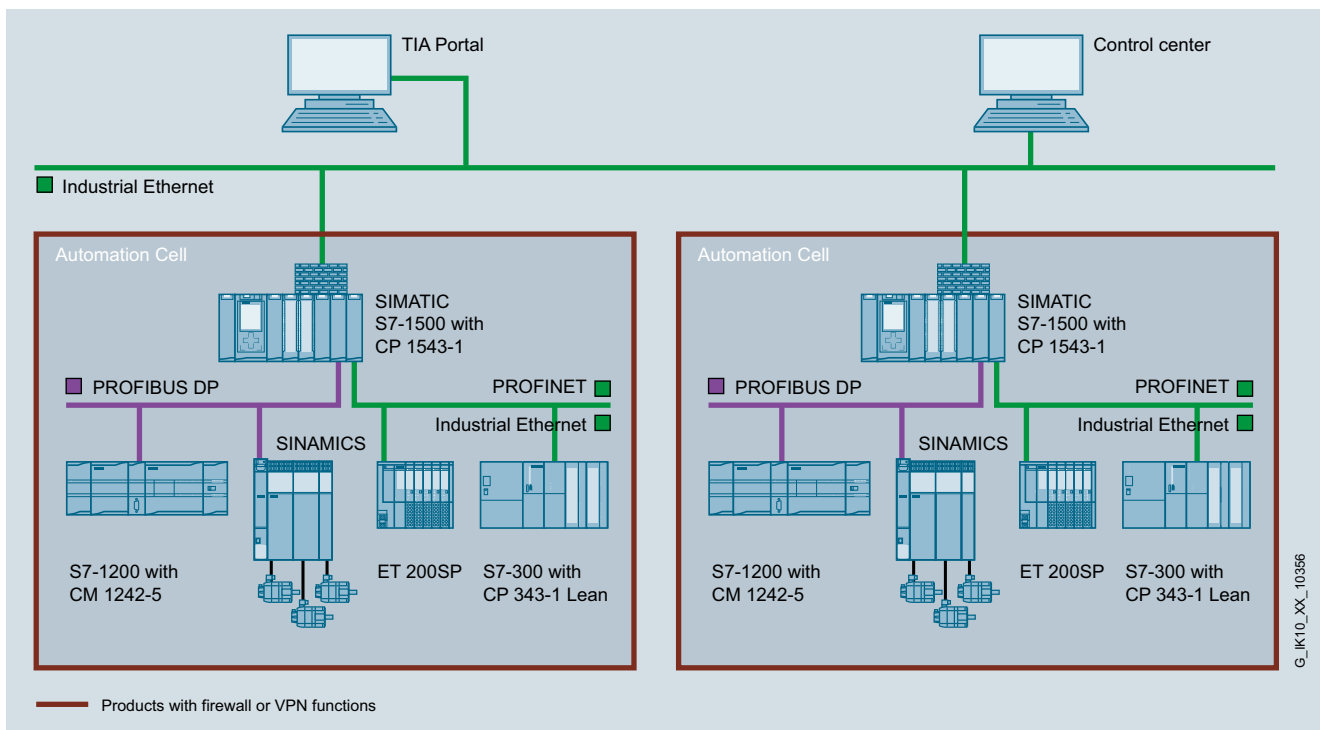

Connection to higher-level network and network separation of automation cells

**Technical specifications**

Article No.	6GK7543-1AX00-0XE0	Article No.	6GK7543-1AX00-0XE0
Product-type designation	CP 1543-1	Product-type designation	CP 1543-1
<b>Transmission rate</b>		<b>Performance data S7 communication</b>	
Transfer rate		Number of possible connections for S7 communication	
• at the interface 1	10 ... 1 000 Mbit/s	• maximum	118
<b>Interfaces</b>		• note	depending on the system upper limit
Number of electrical connections		<b>Performance data multi-protocol mode</b>	
• at interface 1 in accordance with Industrial Ethernet	1	Number of active connections with multiprotocol mode	118
Design of electrical connection		<b>Performance data IT functions</b>	
• at interface 1 in accordance with Industrial Ethernet	RJ45 port	Number of possible connections	
<b>Supply voltage, current consumption, power loss</b>		• as client by means of FTP maximum	32
Type of supply voltage	DC	• as server	
Supply voltage 1 from backplane bus	15 V	- by means of FTP maximum	16
Relative symmetrical tolerance at 15 V with DC	3 %	- by means of HTTP maximum	4
Current consumption from backplane bus at 15 V with DC typical	0.35 A	• as e-mail client maximum	1
Resistive loss	5.3 W	Amount of data as useful data for e-mail maximum	64 Kibyte
<b>Permitted ambient conditions</b>		<b>Product functions management, configuration</b>	
Ambient temperature		Product function MIB support	Yes
• for vertical installation during operating phase	0 ... 40 °C	Protocol is supported	
• for horizontal installation during operating phase	0 ... 60 °C	• SNMP v1	Yes
• during storage	-40 ... +70 °C	• DCP	Yes
• during transport	-40 ... +70 °C	• LLDP	No
Relative humidity at 25 °C without condensation during operating maximum	95 %	Configuration software required	STEP 7 Professional V12 (TIA Portal) or higher
Protection class IP	IP20	Identification & maintenance function	
<b>Design, dimensions and weight</b>		• I&M0 - device-specific information	Yes
Module format	Compact module S7-1500 single width	• I&M1 - higher level designation/ location designation	Yes
Width	35 mm	<b>Product functions Diagnosis</b>	
Height	142 mm	Product function Web-based diagnostics	Yes
Depth	129 mm	<b>Product functions Security</b>	
Net weight	0.35 kg	Design of the firewall	stateful inspection
Mounting type S7-1500 rail mounting	Yes	Product function with VPN connection	IPSec
<b>Product properties, functions, components general</b>		Type of encryption algorithms with VPN connection	AES-256, AES-192, AES-128, 3DES-168, DES-56
Number of modules		Type of authentication procedure with VPN connection	Preshared key (PSK), X.509v3 certificates
• per CPU maximum	8	Type of hashing algorithms with VPN connection	MD5, SHA-1
• note	depending on CPU type	Number of possible connections for VPN connection	16
<b>Performance data</b>		Product function	
<b>Performance data open communication</b>		• password protection for Web applications	No
Number of possible connections for open communication via T-modules		• ACL - IP-based	No
• maximum	118	• ACL - IP-based for PLC/routing	No
• comment	depending on the system upper limit	• switchoff of non-required services	Yes
Data volume as user data per ISO on TCP connection for open communication by means of T blocks maximum	65 536 byte	• blocking of communication via physical ports	No
Number of Multicast stations	118	• log file for unauthorized access	Yes
		<b>Product functions Time</b>	
		Product function	
		• SICLOCK support	Yes
		• pass on time synchronization	Yes
		Protocol is supported NTP	Yes

## PROFINET/Industrial Ethernet

### Communication for SIMATIC S7-1500

CP 1543-1

#### Ordering data

##### CP 1543-1

##### communications processor

for connection of SIMATIC S7-1500 to Industrial Ethernet via TCP/IP, ISO and UDP and Security functions;  
1 x RJ45 interface with 10/100/1 000 Mbit/s;  
electronic manual on DVD

##### Accessories

##### IE FC RJ45 Plug 180 2 x 2

RJ45 plug-in connector for Industrial Ethernet with a rugged metal enclosure and integrated insulation displacement contacts for connecting Industrial Ethernet FC installation cables; with 180° cable outlet; for network components and CPs/CPU with Industrial Ethernet interface

- 1 pack = 1 unit
- 1 pack = 10 units
- 1 pack = 50 units

##### IE FC RJ45 Plug 4 x 2

RJ45 plug connector for Industrial Ethernet (10/100/1 000 Mbit/s) with a sturdy metal enclosure and integrated insulation displacement contacts for connecting Industrial Ethernet FC installation cables; 180° cable outlet; for network components and CPs/CPU with Industrial Ethernet interface

- 1 pack = 1 unit
- 1 pack = 10 units
- 1 pack = 50 units

#### Article No.

6GK7543-1AX00-0XE0

6GK1901-1BB10-2AA0  
6GK1901-1BB10-2AB0  
6GK1901-1BB10-2AE0

6GK1901-1BB11-2AA0  
6GK1901-1BB11-2AB0  
6GK1901-1BB11-2AE0

#### Article No.

##### Accessories (continued)

##### IE FC TP Standard Cable GP 2 x 2 (Type A)

4-core, shielded TP installation cable for connection to IE FC Outlet RJ45/IE FC RJ45 Plug; PROFINET-compatible; with UL approval; sold by the meter; max. length 1 000 m, minimum order quantity 20 m

##### IE FC TP Standard Cable GP 4 x 2

8-core, shielded TP installation cable for connection to IE FC RJ45 Modular Outlet for universal applications; with UL approval; sold by the meter; max. quantity 1 000 m, minimum order 20 m

- AWG22, for connection to IE FC RJ45 Modular Outlet
- AWG24, for connection to IE FC RJ45 Plug 4 x 2

##### IE FC stripping tool

Preadjusted stripping tool for fast stripping of the Industrial Ethernet FC cables

##### SCALANCE X204-2 Industrial Ethernet Switch

Industrial Ethernet Switches with integral SNMP access, Web diagnostics, copper cable diagnostics and PROFINET diagnostics for configuring line, star and ring topologies; four 10/100 Mbit/s RJ45 ports and two FO ports

##### Industrial Ethernet Switch SCALANCE X308-2

2 x 1000 Mbit/s multimode fiber-optic cable ports (SC sockets), 1 x 10/100/1 000 Mbit/s RJ45 port, 7 x 10/100 Mbit/s RJ45 ports; for glass fiber-optic cable (multimode) up to max. 750 m

6XV1840-2AH10

6XV1870-2E

6XV1878-2A

6GK1901-1GA00

6GK5204-2BB10-2AA3

6GK5308-2FL00-2AA3

#### More information

You will find more information on SIMATIC S7-1500 at <http://www.siemens.com/simatic-s7-1500>

The SIMATIC NET Selection Tool is available to assist in selecting the right Industrial Ethernet switches as well as the configuration of modular variants:

Online version:

<http://www.siemens.com/snst>

Offline version:

<http://www.siemens.com/snst-download>

You will find more information on the topic of Industrial Security on the Internet at:

<http://www.siemens.com/industrialsecurity>

##### Note:

For software ordering data, see page 2/584

### Overview



ISO	TCP	PN	MRP	IT	IP-R	PG/OP	S7
	●			●		●	●

Communications processor for connecting a SIMATIC S7-200 to Industrial Ethernet networks

The CP supports:

- PG/OP communication
- S7 communication
- IT communication

In addition, the CP 243-1 offers e-mail functions and user-created web pages and thus optimally supports maintenance and quality assurance. The Internet functions such as FTP allow connection to the most diverse PC-based systems.

### Benefits

get **Designed for Industry**

- Process information can be accessed simultaneously (password protected) with standard Web browsers; software costs are reduced on the client side
- Low-cost bulk storage for data, statistics and HTML-based machine or plant documentation
- Simple universal linking of PLCs to different computers by means of FTP
- Local and worldwide transmission of event-driven messages by e-mail
- Time and cost savings due to fast and easy configuration, programming and monitoring from a central location via LAN
- Reduction of complexity and savings for networking all automation levels and devices since only Ethernet is required
- Simple startup and easy diagnostics options due to configuration support by STEP 7 Micro/WIN

### Application

- The CP 243-1 communications processor is used to connect S7-200 to Industrial Ethernet.
- Distributed plants can be reached over telephone lines or the Internet by using a router and simple diagnostics, signal or user functions can be performed with the help of a web browser. The CP 243-1 is especially suited for plant sections where using PCs for permanent monitoring functions would not be cost-effective.
- PC applications can access the data of an S7-200 via an S7 OPC server. In this way, process data can be easily archived or further processed.
- SIMATIC S7-300 and S7-400 programmable controllers can communicate with a SIMATIC S7-200 with CP 243-1 over Industrial Ethernet which means that the S7-200 can also be used for more complex applications.

### Design

The CP 243-1 offers all the advantages of the S7-200 design:

- Compact design in a rugged plastic enclosure
- Terminal strip for connecting the 24 V DC external supply voltage
- LED status display
- Optional DIN rail mounting or direct wall mounting
- RJ45 socket for connection to Industrial Ethernet with automatic data rate detection

## PROFINET/Industrial Ethernet

### Communication for SIMATIC S7-200

#### CP 243-1

#### Function

The CP 243-1 is connected to Industrial Ethernet via an RJ45 interface for 10/100 Mbit/s full/half duplex with autosensing/autonegotiation and autocrossover function.

The CP 243-1 enables communication between an S7-200 module and another S7-200 or S7-300/S7-400 controller via Industrial Ethernet, and access of the S7-200 programming software STEP 7-Micro/WIN to the S7-200 via Industrial Ethernet.

Integration into PC applications is possible by means of the S7-OPC server of the PC software.

#### IT functions

Simple visualization using Web technology, sending e-mails, and file processing (FTP).

The file system of the CP 243-1 can also be managed through the CPU. It is used as a bulk storage device, a cross-system computer link and a storage location for HTML pages and Java applets. The CP 243-1 has a large file system in which, apart from HTML pages, machine documentation or user guides can also be stored.

#### Web server;

HTML pages can be downloaded and viewed with standard browsers

#### Web pages

- For observation of the S7-200 controller: standard pages for system diagnostics and a simple variable editor are supplied.
- Other customer-specific pages can be generated with any HTML tools

#### E-mails;

sending of pre-defined e-mails directly from the user program Variables can be integrated into the text

#### FTP communication

The CPU can send data blocks as files to other computers or can read or delete the files of other computers (client function). Communication through FTP is possible with most operating systems

#### Configuration

- STEP 7 Micro/WIN V4.0 SP8 or higher is required for configuring the full functional scope of the CP 243-1.
- The CP 243-1 is supplied with a globally unique MAC address that cannot be changed.

#### Integration

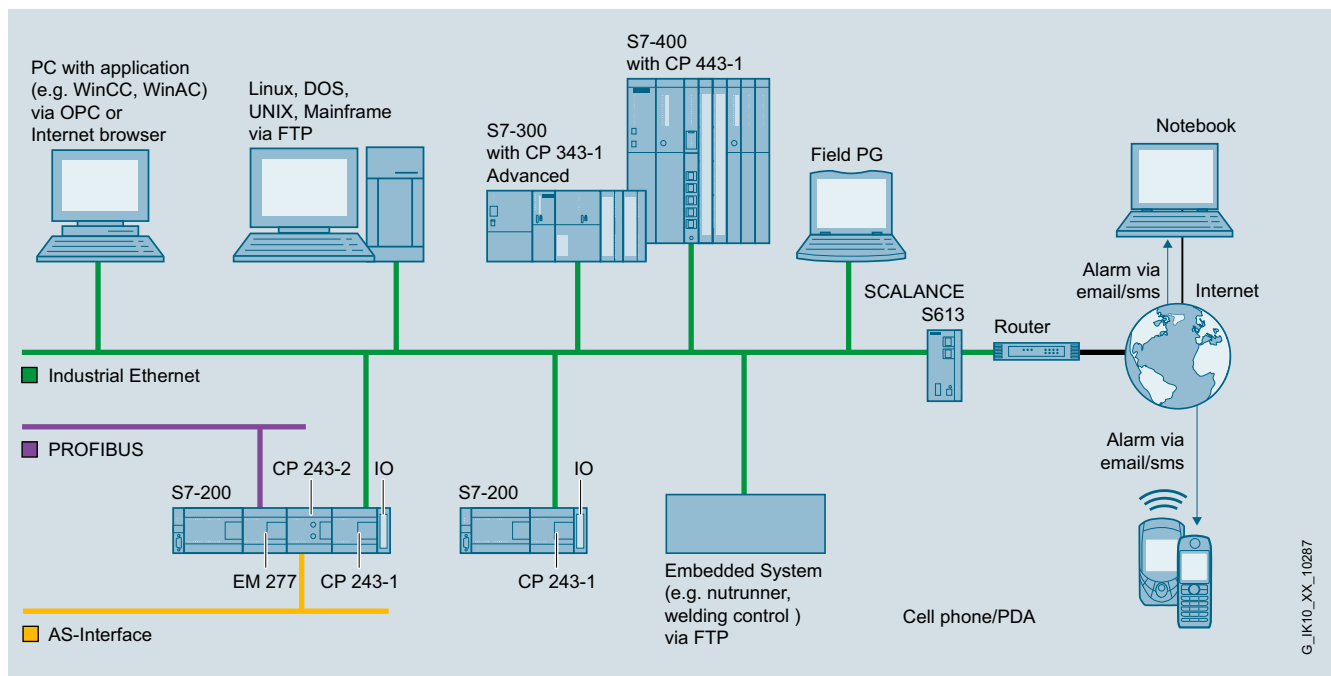

S7-200 communication options with CP 243-1

G\_IK10\_XX\_10287



**Technical specifications**

<b>Article No.</b>	<b>6GK7243-1EX01-0XE0</b>
<b>Product-type designation</b>	<b>CP 243-1</b>
<b>Transmission rate</b>	
Transfer rate at the interface 1	10 ... 100 Mbit/s
<b>Interfaces</b>	
Number of electrical connections	1
• at interface 1 in accordance with Industrial Ethernet	
• for power supply	1
Design of electrical connection	
• at interface 1 in accordance with Industrial Ethernet	RJ45 port
• for power supply	3-pin terminal strip
<b>Supply voltage, current consumption, power loss</b>	
Type of supply voltage	DC
Supply voltage	
• 1 from backplane bus	5 V
• external	24 V
Consumed current from external supply voltage at 24 V with DC	
• typical	0.053 A
• maximum	0.06 A
Resistive loss	1.5 W
<b>Permitted ambient conditions</b>	
Ambient temperature	
• for vertical installation during operating phase	0 ... 45 °C
• for horizontal installation during operating phase	0 ... 55 °C
• during storage	-40 ... +70 °C
• during transport	-40 ... +70 °C
Relative humidity at 25 °C without condensation during operating maximum	95 %
Protection class IP	IP20
<b>Design, dimensions and weight</b>	
Module format	Compact module S7-200 double width
Width	71.2 mm
Height	80 mm
Depth	62 mm
Net weight	0.15 kg

<b>Article No.</b>	<b>6GK7243-1EX01-0XE0</b>
<b>Product-type designation</b>	<b>CP 243-1</b>
<b>Product properties, functions, components general</b>	
Number of modules	
• per CPU maximum	1
<b>Performance data</b>	
<u>Performance data</u>	
<u>S7 communication</u>	
Number of possible connections for S7 communication	
• maximum	8
• with PG connections maximum	1
• with PG/OP connections maximum	8
<u>Performance data</u>	
<u>IT functions</u>	
Number of possible connections	
• as client by means of FTP maximum	1
• as server by means of HTTP maximum	4
• as e-mail client maximum	1
Number of e-mails with 1 024 characters of e-mail client maximum	32
Number of access rights access protections	8
Storage capacity of user memory as flash memory file system	8 Mibyte
Number of possible write cycles flash memory cells	100 000
<b>Product functions management, configuration</b>	
Product function MIB support	No
Protocol is supported SNMP v1	No
Configuration software required	STEP 7-Micro/WIN V4.0 SP8 or higher
<b>Product functions Diagnosis</b>	
Product function Web-based diagnostics	Yes

## PROFINET/Industrial Ethernet

### Communication for SIMATIC S7-200

CP 243-1

#### Ordering data

#### Article No.

##### CP 243-1 communications processor

for connection of SIMATIC S7-200 to Industrial Ethernet; for S7 communication, PG communication, e-mail and WWW server; with electronic manual on CD-ROM German, English, French, Italian, Spanish

6GK7243-1EX01-0XE0

#### Accessories

##### IE TP Cord RJ45/RJ45

TP cable 4 x 2 with 2 RJ45 connectors

- 0.5 m
- 1 m
- 2 m
- 6 m

6XV1870-3QE50  
6XV1870-3QH10  
6XV1870-3QH20  
6XV1870-3QH60

##### SCALANCE X005

Industrial Ethernet Switch for 10/100 Mbit/s; with five 10/100 Mbit/s RJ45 ports for configuring small star and line structures

6GK5005-0BA00-1AA3

#### More information

##### Selection tools:

To assist in selecting the right Industrial Ethernet switches as well as configuration of modular variants, the SIMATIC NET Selection Tool and the TIA Selection Tool are available at:

SIMATIC NET Selection Tool:

- Online version:  
<http://www.siemens.com/snst>
- Offline version:  
<http://www.siemens.com/snst-download>

You will find more information on the topic of Industrial Security on the Internet at:

<http://www.siemens.com/industrialsecurity>

##### Note:

For software ordering data, see page 2/584

### Overview



ISO	TCP/UDP	PN	MRP	IT	IP-R	PG/OP	S7/S5
	●	●	●			●	●

Communications processor for connecting a SIMATIC S7-300 to Industrial Ethernet networks, also as PROFINET IO Device.

The CP supports:

- PG/OP communication
- S7 communication
- Open communication (SEND/RECEIVE)
- PROFINET communication

### Benefits



- High level of plant availability due to support of media redundancy (MRP)
- Optimum support of maintenance through
  - Web-based diagnostics
  - Remote programming via WAN or a telephone network (ISDN)
  - Monitoring by means of IT network management tools (SNMP)
  - Module replacement without programming device thanks to saving of the configuration data on the CPU
- The capability of later connecting existing SIMATIC S7 systems to Industrial Ethernet using the CP 343-1 Lean ensures investment protection

### Application

The CP 343-1 Lean is used to connect the SIMATIC S7-300 to Industrial Ethernet networks. With its own processor, it relieves the CPU of communications tasks and facilitates additional connections.

The CP 343-1 Lean offers the communication options of the S7-300 with

- PGs/PCs
- Master computers
- HMI devices
- Other SIMATIC S5/S7 systems
- PROFINET I/O Controllers

### Design

The CP 343-1 Lean offers all the advantages of SIMATIC S7-300 system design:

- Compact design;
  - the rugged plastic casing features on the front:
    - Two RJ45 sockets for connecting to Industrial Ethernet with automatic detection of transmission rate by means of autosenesing; RJ45 sockets have an industry-compatible design with additional retaining collars for connection of IE FC RJ45 Plug 145/180
    - Diagnostic LEDs for each switch port
    - 2-pin plug-in terminal strip for connection of the 24 V DC external supply voltage
- Easy installation;
  - The CP 343-1 Lean is snap-mounted on the S7-300 DIN rail and connected to adjacent modules through the bus connectors. There are no slot rules.
- The CP 343-1 Lean can be operated without a fan. A standby battery is not required.
- In combination with IM 360/361, CP 343-1 Lean can also be used in an expansion rack (ER).

### Function

- PROFINET interface with two RJ45 ports, 10/100 Mbit/s full/half duplex with autosenesing and autocrossover functionality via 2-port switch
- Communication services via interface:
  - Open communication (TCP/IP, UDP): Multicast for UDP
  - PG/OP communication: inter-network with S7 routing
  - S7 communication (server only)
  - PROFINET IO device
- Media redundancy (MRP):
  - Within an Ethernet network with ring topology, the CP supports the media redundancy procedure MRP
- Diagnostics and network management:
  - Extensive diagnostic functions for all modules in the rack
  - Integration into network management systems through the support of SNMP V1
- Configuring of all functions with STEP 7, V5.4 or higher, or STEP 7 Professional V11 (TIA Portal) or higher
- Module replacement without programming device thanks to saving of the configuration data on the CPU

# PROFINET/Industrial Ethernet

## Communication for SIMATIC S7-300

### CP 343-1 Lean

#### Integration

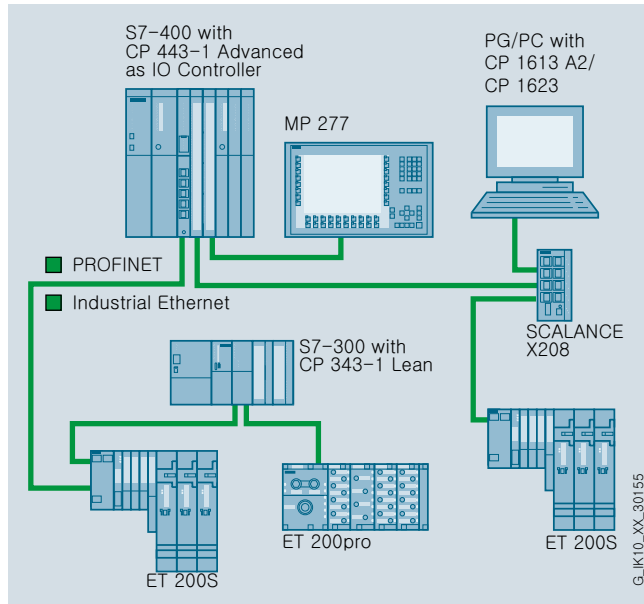

Line structure with CP 343-1 Lean with integrated real-time switch as a PROFINET IO device

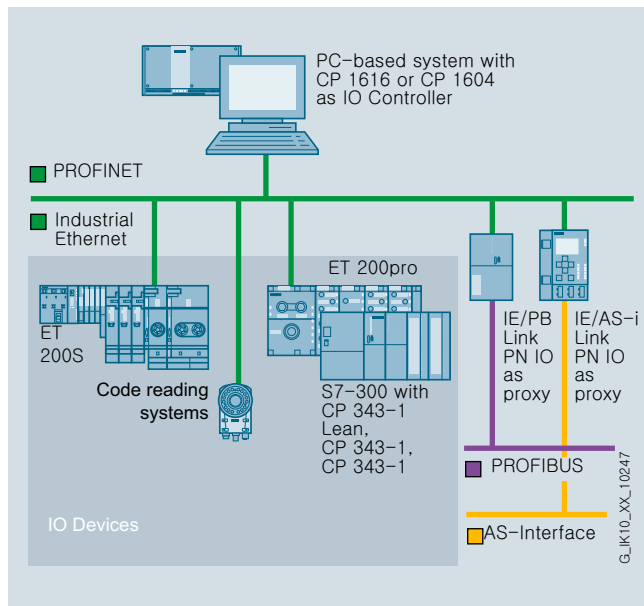

Connection to higher-level network and PC-based system

#### Technical specifications

<b>Article No.</b>	<b>6GK7343-1CX10-0XE0</b>
<b>Product-type designation</b>	<b>CP 343-1 Lean</b>
<b>Transmission rate</b>	
Transfer rate at the interface 1	10 ... 100 Mbit/s
<b>Interfaces</b>	
Number of electrical connections	2
• at interface 1 in accordance with Industrial Ethernet	1
• for power supply	
Design of electrical connection	
• at interface 1 in accordance with Industrial Ethernet	RJ45 port
• for power supply	2-pin plug-in terminal strip
<b>Supply voltage, current consumption, power loss</b>	
Type of supply voltage	DC
Supply voltage	
• 1 from backplane bus	5 V
• external	24 V
Relative positive tolerance at 24 V with DC	20 %
Relative negative tolerance at 24 V with DC	15 %
Consumed current	
• from backplane bus at 5 V for DC, typical	0.2 A
• from external supply voltage at 24 V with DC	-
- typical	0.16 A
- maximum	0.2 A
Resistive loss	5.8 W
<b>Permitted ambient conditions</b>	
Ambient temperature	
• for vertical installation during operating phase	0 ... 40 °C
• for horizontal installation during operating phase	0 ... 60 °C
• during storage	-40 ... +70 °C
• during transport	-40 ... +70 °C
• Comment	-
Relative humidity at 25 °C without condensation during operating maximum	95 %
Protection class IP	IP20
<b>Design, dimensions and weight</b>	
Module format	Compact module S7-300 single width
Width	40 mm
Height	125 mm
Depth	120 mm
Net weight	0,22 kg

**Technical specifications (continued)**

Article No.	6GK7343-1CX10-0XE0	Article No.	6GK7343-1CX10-0XE0
Product-type designation	CP 343-1 Lean	Product-type designation	CP 343-1 Lean
<b>Performance data</b>		<b>Product functions management, configuration</b>	
<u>Performance data open communication</u>		Product function MIB support	
Number of possible connections for open communication by means of SEND/RECEIVE blocks maximum	8	Protocol is supported	Yes
Data volume		• SNMP v1	Yes
• as user data per ISO on TCP connection for open communication by means of SEND/RECEIVE blocks maximum	8 Kibyte	• DCP	Yes
• as user data per TCP connection for open communication by means of SEND/RECEIVE blocks maximum	8 Kibyte	• LLDP	Yes
• as user data per UDP connection for open IE communication by means of SEND/RECEIVE blocks maximum	2 Kibyte	Configuration software required	STEP 7 V5.4 or higher / STEP 7 Professional V11 (TIA Portal) or higher
Number of Multicast stations	8	Identification & maintenance function	
<u>Performance data S7 communication</u>		• I&M0 - device-specific information	Yes
Number of possible connections for S7 communication		• I&M1 - higher level designation/location designation	Yes
• maximum	4	<b>Product functions Diagnosis</b>	
Service of SIMATIC communication as server	Yes	Product function Web-based diagnostics	Yes
<u>Performance data multi-protocol mode</u>		<b>Product functions switch</b>	
Number of active connections with multiprotocol mode	12	Product feature switch	Yes
<u>Performance data PROFINET communication as PN IO-Device</u>		Product function	
Product function PROFINET IO device	Yes	• switch-managed	No
Amount of data		• Configuration with STEP 7	Yes
• as useful data for input variables as PROFINET IO device maximum	512 byte	<b>Product functions Redundancy</b>	
• as useful data for input variables as PROFINET IO device maximum	512 byte	Product function	
• as useful data for input variables for each sub-module under PROFINET IO device	240 byte	• Ring redundancy	Yes
• as useful data for input variables for each sub-module under PROFINET IO device	240 byte	• Media Redundancy Protocol (MRP)	Yes
• as useful data for the consistency area for each sub-module	240 byte	<b>Product functions Security</b>	
Number of submodules per PROFINET IO-Device	32	Product function	
		• switchoff of non-required services	Yes
		• blocking of communication via physical ports	Yes
		<b>Product functions Time</b>	
		Product function	
		• SICLOCK support	Yes
		• pass on time synchronization	Yes
		Protocol is supported NTP	Yes

## PROFINET/Industrial Ethernet

### Communication for SIMATIC S7-300

#### CP 343-1 Lean

#### Ordering data

#### Article No.

##### CP 343-1 Lean communications processor

6GK7343-1CX10-0XE0

For connecting SIMATIC S7-300 to Industrial Ethernet through TCP/IP and UDP, Multicast, S7 communication, open communication (SEND/RECEIVE), FETCH/WRITE, PROFINET IO Device, MRP, integrated 2-port switch ERTEC, comprehensive diagnostics facilities, module replacement without PG, SNMP, initial commissioning over LAN; with electronic manual on CD-ROM

##### Accessories

##### IE FC RJ45 Plug 145

RJ45 plug connector 2 x 2 for Industrial Ethernet with a rugged metal enclosure and integrated insulation displacement contacts for connecting Industrial Ethernet FC installation cables; with 145° cable outlet

- 1 pack = 1 unit
- 1 pack = 10 units
- 1 pack = 50 units

6GK1901-1BB30-0AA0

6GK1901-1BB30-0AB0

6GK1901-1BB30-0AE0

##### IE FC TP Standard Cable GP 2 x 2 (Type A)

6XV1840-2AH10

4-core, shielded TP installation cable for connection to IE FC Outlet RJ45/IE FC RJ45 Plug; PROFINET-compatible; with UL approval; sold by the meter; max. length 1 000 m, minimum order quantity 20 m

##### IE FC stripping tool

6GK1901-1GA00

Preadjusted stripping tool for fast stripping of the Industrial Ethernet FC cables

##### CSM 377 Compact Switch Module

6GK7377-1AA00-0AA0

Unmanaged switch for connection of a SIMATIC S7-300 CPU, ET 200M, and up to three further nodes to Industrial Ethernet operating at 10/100 Mbit/s; 4 x RJ45 ports; external 24 V DC power supply, LED diagnostics, S7-300 module including electronic manual on CD-ROM

#### Note:

For software ordering data, see page 2/584

### Overview



ISO	TCP/UDP	PN	MRP	IT	IP-R	PG/OP	S7/S5
●	●	●	●			●	●

Communications processor for connecting a SIMATIC S7-300/SINUMERIK 840D powerline to Industrial Ethernet networks, also as PROFINET IO Controller or IO Device.

The CP supports:

- PG/OP communication
- S7 communication
- Open communication (SEND/RECEIVE)
- PROFINET communication

### Benefits



- High level of plant availability due to support of media redundancy (MRP)
- Optimum support of maintenance through
  - Web-based diagnostics
  - Remote programming via WAN or a telephone network (ISDN)
  - Monitoring by means of IT network management tools (SNMP)
  - Module replacement without programming device thanks to saving of the configuration data on the CPU
- Securing the system against unauthorized access by means of device-related IP address lists
- The capability of later connecting existing SIMATIC S7 systems to Industrial Ethernet using the CP 343-1 ensures investment protection

### Application

The CP 343-1 is used for connecting the SIMATIC S7-300/SINUMERIK 840D powerline to Industrial Ethernet networks. With its own processor, it relieves the CPU of communications tasks and facilitates additional connections.

The CP 343-1 permits communication of the S7-300 with:

- PGs/PCs
- Master computers
- HMI devices
- SIMATIC S7/C7 systems
- PROFINET IO devices

### Design

The CP 343-1 has all the advantages of the SIMATIC S7-300 design:

- Compact design; on the front, the rugged plastic housing features:
  - Two RJ45 sockets for connection to Industrial Ethernet with automatic sensing of the data transmission rate by means of Autosensing/Autonegotiation; the RJ45 sockets are industrially compatible and designed with additional holding collars for connecting to the IE FC RJ45 Plug 145/180
  - 2-pole plug-in terminal strip for connection of the 24 V DC external supply voltage
  - 8 LEDs for indication of the operating and communication status (diagnostics for each switch port)
- Easy installation; the CP 343-1 is mounted on the S7-300 rail and connected through the bus connector with the neighboring modules. No slot rules apply.
- Fan-free operation; A back-up battery is not required.
- Using the IM 360/361, the CP 343-1 can also be operated in the expansion rack (ER)
- Modules can be replaced without the need for a programming device

### Function

- PROFINET interface with two RJ45 connectors with 10/100 Mbit/s full/half duplex with autosensing and autocrossover functionality via integrated 2-port switch
- Communication services via interface:
  - Open communication (TCP/IP, UDP, ISO): Multicast for UDP
  - PG/OP communication: inter-network with S7 routing
  - S7 communication (client, server, multiplexing)
  - PROFINET IO Controller or IO Device
- Media redundancy (MRP):
  - Within an Ethernet network with ring topology, the CP supports the media redundancy procedure MRP
- Diagnostics and network management:
  - Extensive diagnostic functions for all modules in the rack
  - Integration into network management systems through the support of SNMP V1
- Security mechanisms:
  - Access protection by means of configurable IP access list
- Configuring of all functions with STEP 7, V5.4 or higher, or STEP 7 Professional V11 (TIA Portal) or higher
- Module replacement without programming device thanks to saving of the configuration data on the CPU

# PROFINET/Industrial Ethernet

## Communication for SIMATIC S7-300

### CP 343-1

#### Integration

2

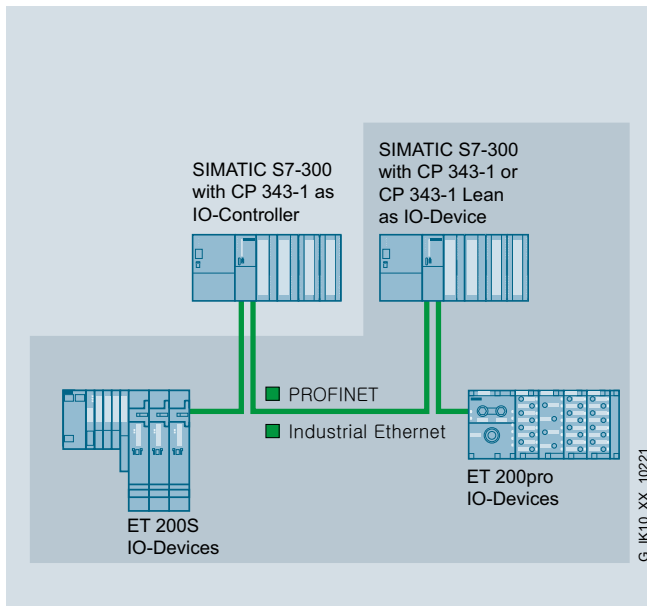

Line structure with CP 343-1 with integrated real-time switch as a PROFINET IO controller or IO device

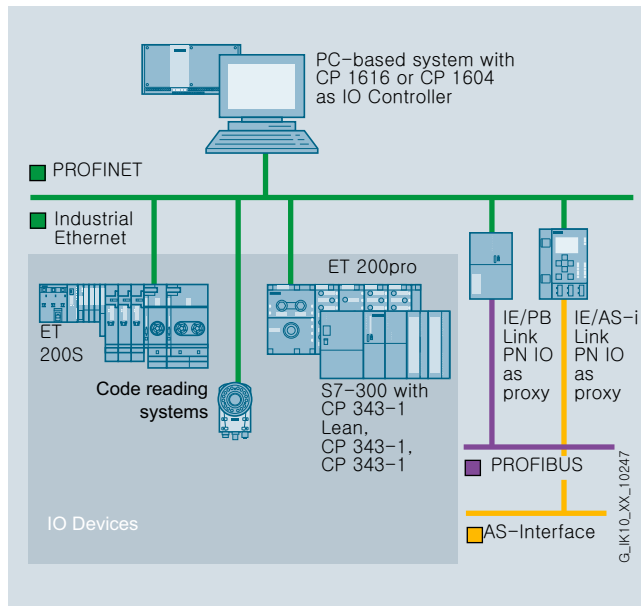

Connection to higher-level network and PC-based system

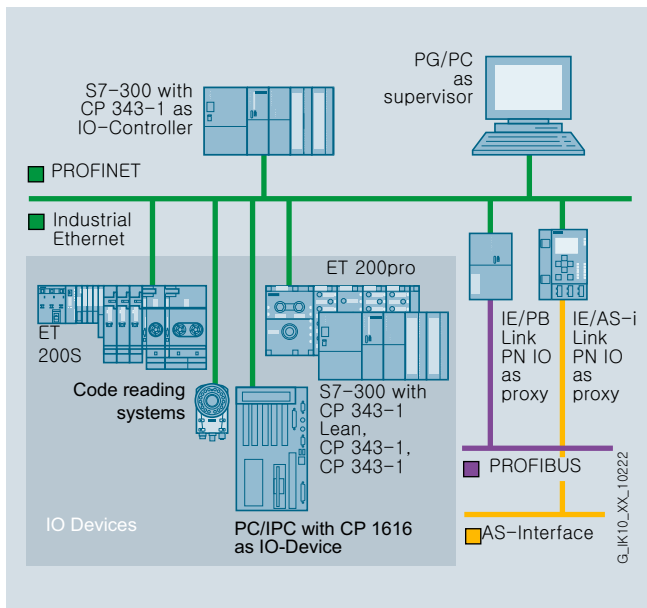

Interfacing to higher-level network with CP 343-1 as PROFINET IO controller



**Technical specifications**

Article No.	6GK7343-1EX30-0XE0
Product-type designation	CP 343-1
<b>Transmission rate</b>	
Transfer rate at the interface 1	10 ... 100 Mbit/s
<b>Interfaces</b>	
Number of electrical connections	
• at interface 1 in accordance with Industrial Ethernet	2
• for power supply	1
Design of electrical connection	
• at interface 1 in accordance with Industrial Ethernet	RJ45 port
• for power supply	2-pin plug-in terminal strip
<b>Supply voltage, current consumption, power loss</b>	
Type of supply voltage	DC
Supply voltage	
• 1 from backplane bus	5 V
• external	24 V
Relative positive tolerance at 24 V with DC	20 %
Relative negative tolerance at 24 V with DC	15 %
Consumed current	
• from backplane bus at 5 V for DC, typical	0,2 A
• from external supply voltage at 24 V with DC	
- typical	0.16 A
- maximum	0.2 A
Resistive loss	5.8 W
<b>Permitted ambient conditions</b>	
Ambient temperature	
• for vertical installation during operating phase	0 ... 40 °C
• for horizontal installation during operating phase	0 ... 60 °C
• during storage	-40 ... +70 °C
• during transport	-40 ... +70 °C
• Comment	-
Relative humidity at 25 °C without condensation during operating maximum	95 %
Protection class IP	IP20
<b>Design, dimensions and weight</b>	
Module format	Compact module S7-300 single width
Width	40 mm
Height	125 mm
Depth	120 mm
Net weight	0.22 kg

Article No.	6GK7343-1EX30-0XE0
Product-type designation	CP 343-1
<b>Performance data</b>	
<u>Performance data open communication</u>	
Number of possible connections for open communication by means of SEND/RECEIVE blocks maximum	16
Data volume	
• as user data per ISO connection for open communication by means of SEND/RECEIVE blocks maximum	8 Kibyte
• as user data per ISO on TCP connection for open communication by means of SEND/RECEIVE blocks maximum	8 Kibyte
• as user data per TCP connection for open communication by means of SEND/RECEIVE blocks maximum	8 Kibyte
• as user data per UDP connection for open IE communication by means of SEND/RECEIVE blocks maximum	2 Kibyte
Number of Multicast stations	16
<u>Performance data S7 communication</u>	
Number of possible connections for S7 communication	
• maximum	16
<u>Performance data multi-protocol mode</u>	
Number of active connections with multiprotocol mode	32
<u>Performance data PROFINET communication as PN IO-Controller</u>	
Number of PN IO-Devices on PROFINET IO-Controller usable total	32
Number of external PN IO lines with PROFINET per rack	1
Data volume	
• as useful data for input variables as PROFINET IO controller maximum	1 Kibyte
• as useful data for output variables with PROFINET IO controller maximum	1 Kibyte
• as useful data for input variables per PN IO device with PROFINET IO controller maximum	1 433 byte
• as useful data for output variables per PN IO device with PROFINET IO controller maximum	1 433 byte
• as user data for input variable per PN IO device per submodule as PROFINET IO controller maximum	240 byte
• as user data for output variables per PN IO device per submodule as PROFINET IO controller maximum	240 byte

## PROFINET/Industrial Ethernet

### Communication for SIMATIC S7-300

CP 343-1

#### Technical specifications (continued)

Article No.	6GK7343-1EX30-0XE0	Article No.	6GK7343-1EX30-0XE0
Product-type designation	CP 343-1	Product-type designation	CP 343-1
Performance data <u>PROFINET communication</u> as PN IO-Device		<b>Product functions Diagnosis</b>	
Product function PROFINET IO device	Yes	Product function Web-based diagnostics	Yes
Amount of data		<b>Product functions switch</b>	
• as useful data for input variables	512 byte	Product feature switch	Yes
• as PROFINET IO device maximum		Product function	
• as useful data for input variables as PROFINET IO device maximum	512 byte	• switch-managed	No
• as useful data for input variables for each sub-module under PROFINET IO device	240 byte	• Configuration with STEP 7	Yes
• as useful data for input variables for each sub-module under PROFINET IO device	240 byte	<b>Product functions Redundancy</b>	
• as useful data for the consistency area for each sub-module	240 byte	Product function	
Number of submodules per PROFINET IO-Device	32	• Ring redundancy	Yes
<b>Product functions management, configuration</b>		• Redundancy manager	No
Product function MIB support	Yes	• Media Redundancy Protocol (MRP)	Yes
Protocol is supported		<b>Product functions Security</b>	
• SNMP v1	Yes	Product function	
• DCP	Yes	• ACL - IP-based	Yes
• LLDP	Yes	• switchoff of non-required services	Yes
Configuration software required	STEP 7 V5.4 SP2 or higher / STEP 7 Professional V11 (TIA Portal) or higher	• blocking of communication via physical ports	Yes
Identification & maintenance function		• log file for unauthorized access	No
• I&M0 - device-specific information	Yes	<b>Product functions Time</b>	
• I&M1 - higher level designation/location designation	Yes	Product function	
		• SICLOCK support	Yes
		• pass on time synchronization	Yes
		Protocol is supported NTP	Yes

Ordering data	Article No.	Article No.
<p><b>CP 343-1 communications processor</b></p> <p>For connection of SIMATIC S7-300 to Industrial Ethernet over ISO and TCP/IP; PROFINET IO Controller or PROFINET IO Device, MRP, integrated 2-port switch ERTEC; S7 communication, open communication (SEND/RECEIVE), FETCH/WRITE, with and without RFC 1006, multicast, DHCP, CPU clock synchronization via SIMATIC procedure and NTP, diagnostics, SNMP, access protection through IP access list, initialization over LAN 10/100 Mbit/s; with electronic manual on DVD</p> <p><i>Accessories</i></p> <p><b>IE FC RJ45 Plug 180 2 x 2</b></p> <p>RJ45 plug connector for Industrial Ethernet with a rugged metal housing and integrated insulation displacement contacts for connecting Industrial Ethernet FC installation cables; 180° cable outlet; for network components and CPs/CPU with Industrial Ethernet interface</p> <ul style="list-style-type: none"> <li>• 1 pack = 1 unit</li> <li>• 1 pack = 10 units</li> <li>• 1 pack = 50 units</li> </ul> <p><b>IE FC RJ45 Plug 145</b></p> <p>RJ45 plug connector 2 x 2 for Industrial Ethernet with a rugged metal enclosure and integrated insulation displacement contacts for connecting Industrial Ethernet FC installation cables; with 145° cable outlet</p> <ul style="list-style-type: none"> <li>• 1 pack = 1 unit</li> <li>• 1 pack = 10 units</li> <li>• 1 pack = 50 units</li> </ul>	<p><b>6GK7343-1EX30-0XE0</b></p>	<p><i>Accessories</i> (continued)</p> <p><b>IE FC TP Standard Cable GP 2 x 2 (Type A)</b></p> <p>4-core, shielded TP installation cable for connection to IE FC Outlet RJ45/IE FC RJ45 Plug; PROFINET-compatible; with UL approval; sold by the meter; max. length 1 000 m, minimum order quantity 20 m</p> <p><b>IE FC stripping tool</b></p> <p>Preadjusted stripping tool for fast stripping of the Industrial Ethernet FC cables</p> <p><b>CSM 377 Compact Switch Module</b></p> <p>Unmanaged switch for connection of a SIMATIC S7-300 CPU, ET 200M, and up to three further nodes to Industrial Ethernet operating at 10/100 Mbit/s; 4 x RJ45 ports; external 24 V DC power supply, LED diagnostics, S7-300 module including electronic manual on CD-ROM</p> <p><b>SCALANCE X204-2 Industrial Ethernet Switch</b></p> <p>Industrial Ethernet Switches with integral SNMP access, Web diagnostics, copper cable diagnostics and PROFINET diagnostics for configuring line, star and ring topologies; four 10/100 Mbit/s RJ45 ports and two FO ports</p>
		<p><b>6XV1840-2AH10</b></p>
		<p><b>6GK1901-1GA00</b></p>
		<p><b>6GK7377-1AA00-0AA0</b></p>
		<p><b>6GK5204-2BB10-2AA3</b></p>

Note:

For software ordering data, see page 2/584

## PROFINET/Industrial Ethernet

### Communication for SIMATIC S7-300

#### CP 343-1 Advanced

#### Overview



ISO	TCP/UDP	PN	MRP	IT	IP-R	PG/OP	S7/S5
●	●	●	●	●	●	●	●

Communications processor for connecting the SIMATIC S7-300/SINUMERIK 840D powerline to Industrial Ethernet networks, also as PROFINET IO controller and IO device.

The CP supports:

- PG/OP communication
- S7 communication
- Open communication (SEND/RECEIVE)
- PROFINET communication
- IT communication
- Security functionality, firewall and VPN

In addition, the CP 343-1 Advanced provides e-mail functions and allows users to create their own Web pages - ideal support for maintenance and quality assurance. The Internet functions such as FTP even allow connection to the most diverse PC-based systems. This CP is therefore the bridge between the field level and the management level for the S7-300. The CP 343-1 Advanced connects seamlessly to the security structures of the office and IT world.

#### Benefits



- Cost advantage resulting from connection to two separate Ethernet segments with network separation
- High level of plant availability due to support of media redundancy (MRP)
- Optimum support of maintenance due to
  - Web-based diagnostics
  - Remote programming via WAN or telephone network
  - Monitoring with IT network management tools (SNMP)
  - Module replacement without programming device using the C-PLUG swap medium
- Securing the system<sup>1)</sup> against unauthorized access by means of
  - Central access protection for any devices within an automation cell, e.g. by reliable authentication of the network nodes
  - Secure remote access via the Internet by means of data encryption (VPN) and data integrity checking
  - Traceability by means of data logging on the basis of standard IT mechanisms (Syslog)
- The ability to connect existing SIMATIC S7 systems to Industrial Ethernet at a later point in time using the CP 343-1 Advanced ensures investment protection

<sup>1)</sup> Security functions, firewall and VPN only with -1GX31 variant

#### Application

The CP 343-1 Advanced is used to connect the SIMATIC S7-300 to Industrial Ethernet networks. With its own processor, it relieves the CPU of communications tasks and allows additional connections.

The CP 343-1 Advanced provides the following communications options:

- PGs/PCs
- Master computers
- Operator control and monitoring systems
- SIMATIC S5/S7/C7 systems
- PROFINET IO devices/IO controllers
- PROFINET CBA components

With this, all the devices of an Ethernet network can be protected from unauthorized access. The CP 343-1 Advanced allows secure remote access over the Internet and allows data transfer between devices or network segments to be protected from data manipulation/espionage.

PROFINET CBA components and security functionalities can only be used alternatively.

### Application (continued)

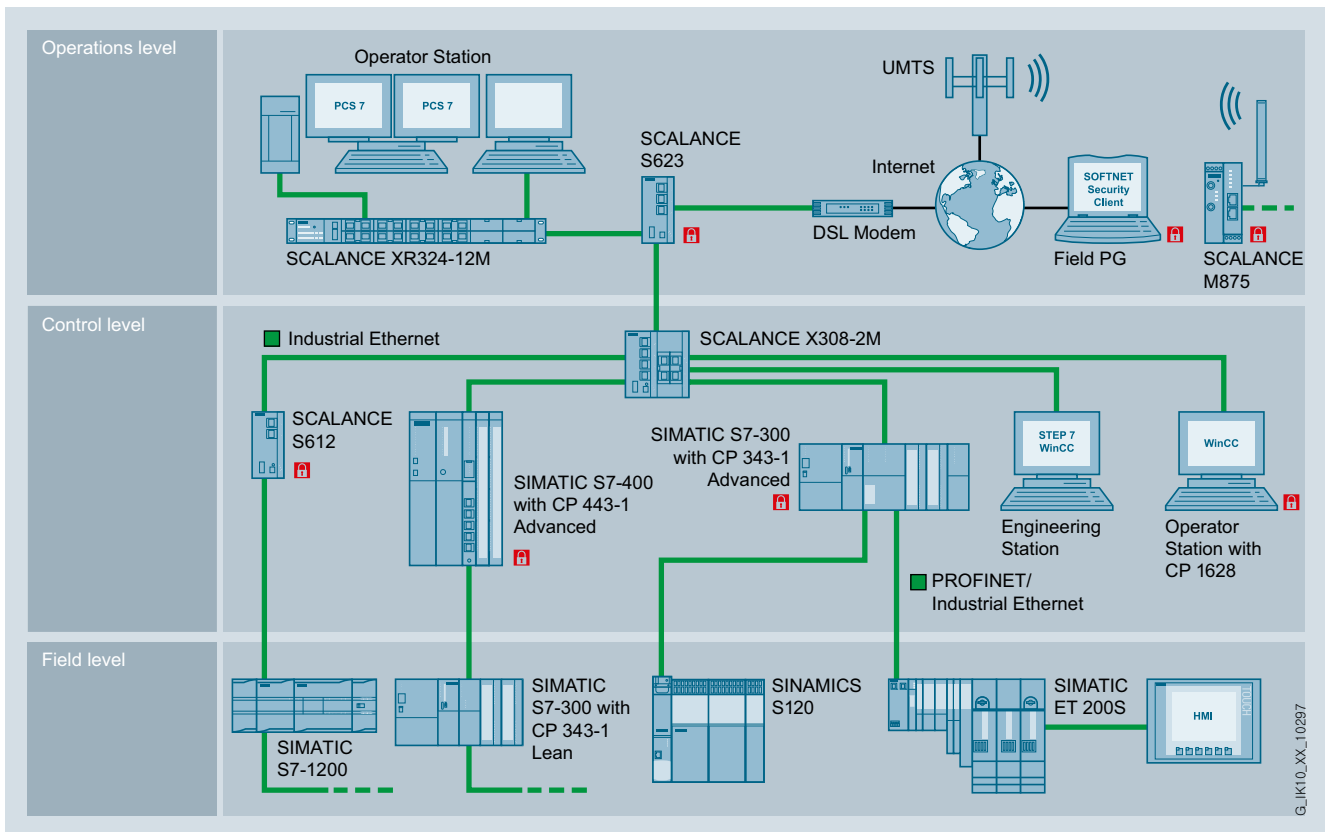

Secure VPN communication between SCALANCE S, SOFTNET Security Client and components with Security Integrated

### Design

The CP 343-1 Advanced offers all the advantages of SIMATIC S7-300 system design:

- Compact design:
  - Three RJ45 jacks for connecting to Industrial Ethernet via two independent interfaces; one of which is a security jack for externally safeguarding the network cell; automatic data rate detection by means of the autosensing, autonegotiation and autocross functions; the connection is made via the IE FC RJ45 Plug 180 with 180° cable outlet or via a standard patch cable
  - 2-pin plug-in terminal strip for connection of the 24 V DC external supply voltage
  - Diagnostics LEDs for indicating the operational and communication status
- Simple installation; the CP 343-1 Advanced is mounted on the S7-300 mounting rail and connected to adjacent modules by means of the bus connector. There are no slot rules.
- The CP 343-1 Advanced can be operated without a fan; no backup battery is required.
- In combination with IM 360/361, the CP 343-1 Advanced can also be used in an expansion rack (ER).
- The module can be replaced without the need for a programming device
- C-PLUG (configuration plug) is included in the scope of delivery as a removable storage medium (cannot be operated without C-PLUG)

## PROFINET/Industrial Ethernet

### Communication for SIMATIC S7-300

#### CP 343-1 Advanced

#### Function

- Two separate interfaces (integrated network separation):
  - Gigabit interface with an RJ45 connector with 10/100/1 000 Mbps full/half duplex with autosensing functionality
  - PROFINET interface with two RJ45 connectors with 10/100 Mbps full/half duplex with autosensing and autocrossover functionality via integrated 2-port switch
- Communications services via both interfaces:
  - Open communication (TCP/IP, UDP, ISO): Multicast with UDP, including routing between both interfaces
  - PG/OP communication: inter-network with S7 routing
  - S7 communication (client, server, multiplexing) including routing between both interfaces
  - IT communication:
    - HTTP communication permits access to process data via user's own Web pages. HTTPS communication is also possible with the CP 343-1 Advanced<sup>1)</sup>.
    - The e-mail client function allows e-mails to be sent directly from the user program.
    - FTP communication allows program-controlled FTP client communication.
    - Access to data blocks via FTP server.
- Communication services via PROFINET interfaces:
  - PROFINET IO controller and IO device with real-time properties (RT and IRT)
  - PROFINET CBA
  - IP address assignment via DHCP, simple PC tool or via user program
- Media redundancy (MRP):
  - Within an Ethernet network with a ring topology, the CP supports the MRP media redundancy protocol as an MRP manager and as an MRP client
- Diagnostics and network management:
  - Extensive diagnostics functions for all modules in the rack
  - Integration in network management systems due to support of SNMP V1/V3
- Security mechanisms:
  - Access protection by means of configurable IP access list
  - Firewall for filtering connections on the basis of their IP/port addresses
  - Bandwidth limitation to avoid communication overload
  - VPN server and VPN client for tap-proof access to controllers
  - Encrypted HTML pages using SSL (HTTPS)
  - Secure file transfer (FTPs)
  - Tap-proof transfer of network analysis information to the network management system (SNMP)
  - Translation of private and public IP addresses (NAT/NAPT)
  - Secure transfer of the time of day (NTP V3)
- Configuration of all functions using STEP 7; the security functions are configured using the Security Configuration Tool (SCT) which is included in the scope of supply of STEP 7 V5.5 SP3.
- Configuration with STEP 7 Professional V11; only possible with a limited range of functions of the predecessor CP 343-1 (6GK7 343-1GX30-0XE0), without security functions and CBA. Version with security functions<sup>1)</sup> for TIA Portal in planning.
- Module replacement without programming device: all information is stored on the C-PLUG (also file system for IT functions)

#### Integration

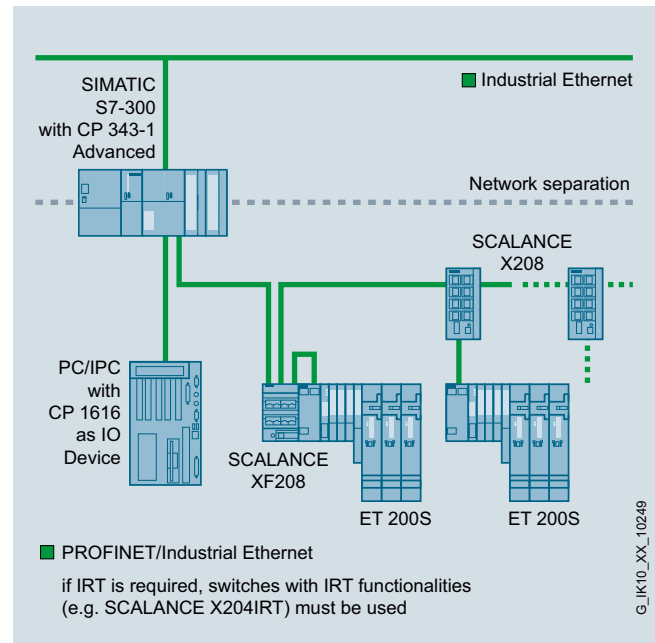

Connection to a higher-level network with network separation and access protection (security functions)

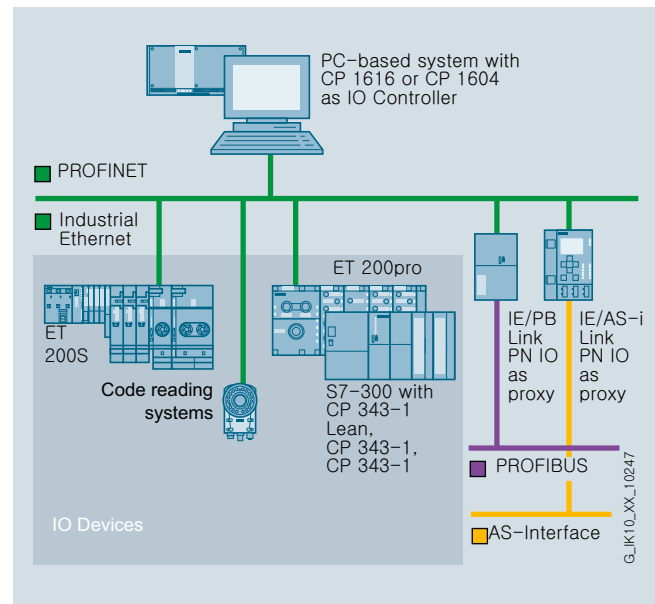

Connection to higher-level network and PC-based system

**Integration** (continued)

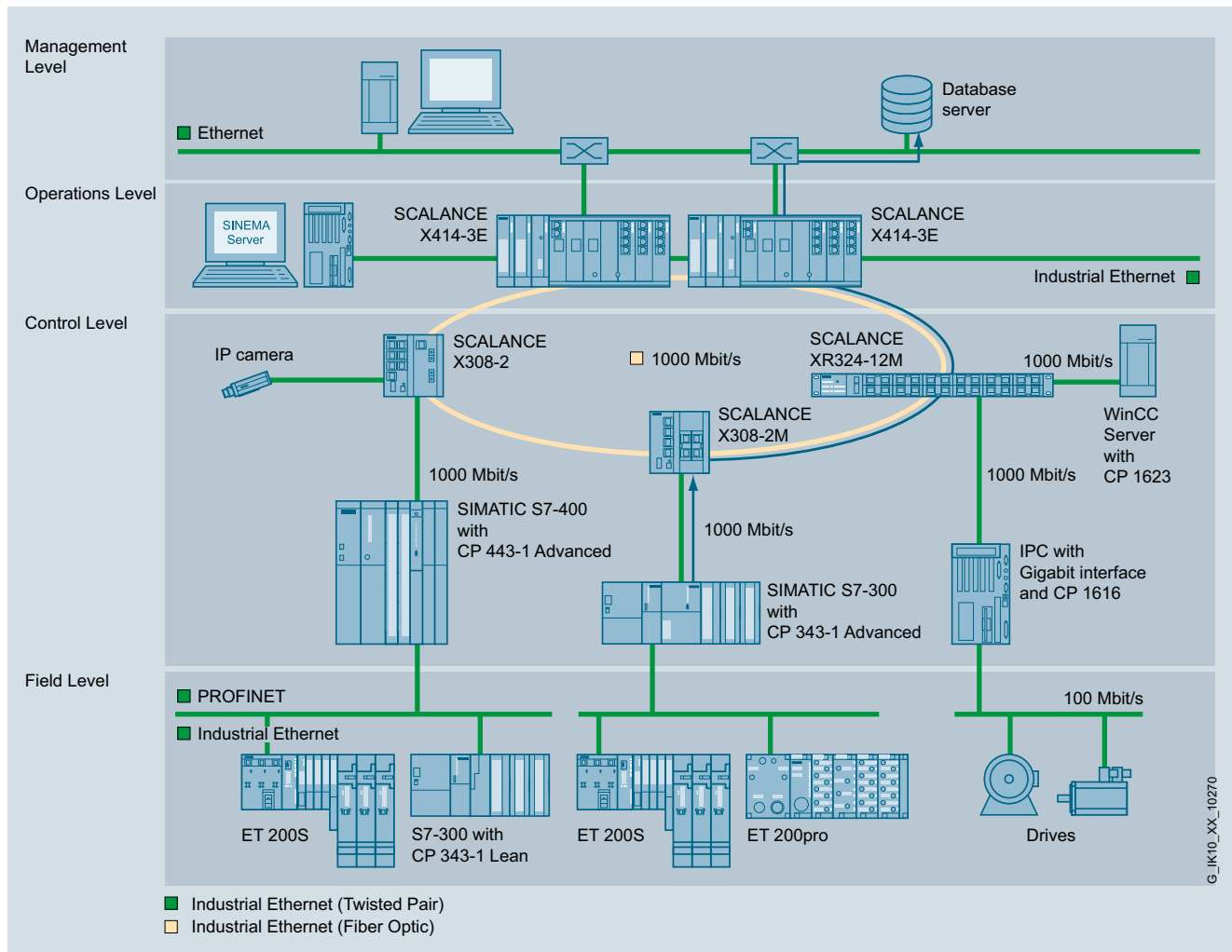

Gigabit communication at the control level

# PROFINET/Industrial Ethernet

## Communication for SIMATIC S7-300

### CP 343-1 Advanced

#### Technical specifications

Article No.	6GK7343-1GX31-0XE0	Article No.	6GK7343-1GX31-0XE0
Product-type designation	CP 343-1 Advanced	Product-type designation	CP 343-1 Advanced
<b>Transmission rate</b>		<b>Performance data</b>	
Transfer rate		<u>Performance data</u> <u>open communication</u>	
• at the interface 1	10 ... 1 000 Mbit/s	Number of possible connections for open communication by means of SEND/RECEIVE blocks maximum	16
• at the interface 2	10 ... 100 Mbit/s	Data volume	
<b>Interfaces</b>		• as user data per ISO connection for open communication by means of SEND/RECEIVE blocks maximum	8 Kibyte
Number of electrical connections		• as user data per ISO on TCP connection for open communication by means of SEND/RECEIVE blocks maximum	8 Kibyte
• at interface 1 in accordance with Industrial Ethernet	1	• as user data per TCP connection for open communication by means of SEND/RECEIVE blocks maximum	8 Kibyte
• at interface 2 in accordance with Industrial Ethernet	2	• as user data per UDP connection for open IE communication by means of SEND/RECEIVE blocks maximum	2 Kibyte
• for power supply	1	Number of Multicast stations	16
Design of electrical connection		<u>Performance data</u> <u>S7 communication</u>	
• at interface 1 in accordance with Industrial Ethernet	RJ45 port	Number of possible connections for S7 communication	
• at interface 2 in accordance with Industrial Ethernet	RJ45 port	• maximum	16
• for power supply	2-pin plug-in terminal strip	<u>Performance data</u> <u>multi-protocol mode</u>	
Design of the removable storage C-PLUG	Yes	Number of active connections with multiprotocol mode	48
<b>Supply voltage, current consumption, power loss</b>		<u>Performance data</u> <u>IT functions</u>	
Type of supply voltage	DC	Number of possible connections	
Supply voltage		• as client by means of FTP maximum	10
• 1 from backplane bus	5 V	• as server	
• external	24 V	- by means of FTP maximum	2
Relative positive tolerance at 24 V with DC	20 %	- by means of HTTP maximum	4
Relative negative tolerance at 24 V with DC	15 %	• as e-mail client maximum	1
Consumed current		Amount of data as useful data for e-mail maximum	8 Kibyte
• from backplane bus at 5 V for DC Typical	0.14 A	Storage capacity of user memory	
• from external supply voltage at 24 V with DC		• as flash memory file system	28 Mibyte
- typical	0.48 A	• as RAM	30 Mibyte
- maximum	0.62 A	Number of possible write cycles flash memory cells	100 000
Resistive loss	14.7 W	<u>Performance data</u> <u>PROFINET communication</u> <u>as PN IO-Controller</u>	
<b>Permitted ambient conditions</b>		Number of PN IO-Devices on PROFINET IO-Controller usable total	128
Ambient temperature		Number of PN IO IRT-Devices on PROFINET IO-Controller usable	128
• for vertical installation during operating phase	0 ... 40 °C	Number of external PN IO lines with PROFINET per rack	1
• for horizontal installation during operating phase	0 ... 60 °C		
• during storage	-40 ... +70 °C		
• during transport	-40 ... +70 °C		
Relative humidity at 25 °C without condensation during operating maximum	95 %		
Protection class IP	IP20		
<b>Design, dimensions and weight</b>			
Module format	Compact module		
Width	80 mm		
Height	125 mm		
Depth	120 mm		
Net weight	0.8 kg		



### Technical specifications (continued)

Article No.	6GK7343-1GX31-0XE0	Article No.	6GK7343-1GX31-0XE0
Product-type designation	CP 343-1 Advanced	Product-type designation	CP 343-1 Advanced
Data volume		Amount of data	
• as useful data for input variables as PROFINET IO controller maximum	4 Kibyte	• as useful data for remote interconnections with input variables in the case of acyclic transmission with PROFINET CBA	8 Kibyte
• as useful data for output variables with PROFINET IO controller maximum	4 Kibyte	• as useful data for remote interconnections with output variables in the case of acyclic transmission with PROFINET CBA	8 Kibyte
• as useful data for input variables per PN IO device with PROFINET IO controller maximum	1 433 byte	<u>Performance data</u> <u>PROFINET CBA remote connection with cyclic transmission</u>	
• as useful data for output variables per PN IO device with PROFINET IO controller maximum	1 433 byte	Update time of the remote interconnections with PROFINET CBA with cyclic transmission	8 ms
• as user data for input variable per PN IO device per submodule as PROFINET IO controller maximum	240 byte	Number of remote connections to input variables with PROFINET CBA with cyclic transmission maximum	200
• as user data for output variables per PN IO device per submodule as PROFINET IO controller maximum	240 byte	Number of remote connections to output variables with PROFINET CBA with cyclic transmission maximum	200
<u>Performance data</u> <u>PROFINET communication</u> <u>as PN IO-Device</u>		Amount of data	
Product function PROFINET IO device	Yes	• as useful data for remote interconnections with input variables with PROFINET CBA with cyclic transmission maximum	2 000 byte
Amount of data		• as useful data for remote interconnections with output variables with PROFINET CBA with cyclic transmission maximum	2 000 byte
• as useful data for input variables as PROFINET IO device maximum	1 024 byte	<u>Performance data</u> <u>PROFINET CBA</u> <u>HMI variables via PROFINET acyclic</u>	
• as useful data for input variables as PROFINET IO device maximum	1 024 byte	Number of connectable HMI stations for HMI variables with acyclic transmission with PROFINET CBA	3
• as useful data for input variables for each sub-module under PROFINET IO device	240 byte	Updating time of the HMI variables in the case of acyclic transmission with PROFINET CBA	500 ms
• as useful data for input variables for each sub-module under PROFINET IO device	240 byte	Number of HMI variables with acyclic transmission with PROFINET CBA maximum	200
• as useful data for the consistency area for each sub-module	240 byte	Amount of data as useful data for HMI variables in the case of acyclic transmission with PROFINET CBA maximum	8 Kibyte
Number of submodules per PROFINET IO-Device	32	<u>Performance data</u> <u>PROFINET CBA</u> <u>device-internal connections</u>	
<u>Performance data</u> <u>PROFINET CBA</u>		Number of internal connections with PROFINET CBA maximum	256
Number of remote connection partners with PROFINET CBA	64	Data volume of internal connections with PROFINET CBA maximum	2 400 byte
Number of connections with PROFINET CBA total	1 000	<b>Performance data PROFINET CBA connections to constants</b>	
Amount of data		Number of connections to constants with PROFINET CBA maximum	200
• as useful data for digital inputs with PROFINET CBA maximum	8 192 byte	Amount of data as useful data for interconnections with constants in the case of PROFINET CBA maximum	4 096 byte
• as useful data for digital outputs in the case of PROFINET CBA max.	8 192 byte	<u>Performance data</u> <u>PROFINET CBA</u> <u>PROFIBUS proxy functionality</u>	
• as useful data for arrays and data types		Product function with PROFINET CBA PROFIBUS proxy functionality	No
- in the case of acyclic transmission with PROFINET CBA maximum	8 192 byte		
- with PROFINET CBA with cyclic transmission maximum	250 byte		
- with PROFINET CBA in the case of local interconnection maximum	2 400 byte		
<u>Performance data</u> <u>PROFINET CBA remote connection with acyclic transmission</u>			
Updating time of the remote interconnections in the case of acyclic transmission with PROFINET CBA	0.1 s		
Number of remote connections to input variables with acyclic transmission with PROFINET CBA maximum	128		
Number of remote connections to output variables with acyclic transmission with PROFINET CBA maximum	128		

# PROFINET/Industrial Ethernet

## Communication for SIMATIC S7-300

### CP 343-1 Advanced

#### Technical specifications (continued)

Article No.	<b>6GK7343-1GX31-0XE0</b>
Product-type designation	<b>CP 343-1 Advanced</b>
<b>Product functions management, configuration</b>	
Product function MIB support	Yes
Protocol is supported	
• SNMP v1	Yes
• DCP	Yes
• LLDP	Yes
Configuration software	
• required	STEP 7 V5.5 SP2 HF1 or higher / STEP 7 Professional V12 (TIA Portal) or higher
• for PROFINET CBA required	SIMATIC iMap V3.0 SP4 and higher
Identification & maintenance function	
• I&M0 - device-specific information	Yes
• I&M1 - higher level designation/location designation	Yes
<b>Product functions Diagnosis</b>	
Product function Web-based diagnostics	Yes
<b>Product functions switch</b>	
Product feature switch	Yes
Product function	
• switch-managed	No
• for IRT PROFINET IO switch	Yes
• Configuration with STEP 7	Yes
<b>Product functions Redundancy</b>	
Product function	
• Ring redundancy	Yes
• Redundancy manager	Yes
• Media Redundancy Protocol (MRP)	Yes
<b>Product functions Security</b>	
Design of the firewall	stateful inspection
Product function with VPN connection	IPSec
Type of encryption algorithms with VPN connection	AES-256, AES-192, AES-128, 3DES-168, DES-56
Type of authentication procedure with VPN connection	Preshared key (PSK), X.509v3 certificates
Type of hashing algorithms with VPN connection	MD5, SHA-1
Number of possible connections for VPN connection	32
Product function	
• password protection for Web applications	Yes
• ACL - IP-based	Yes
• ACL - IP-based for PLC/routing	Yes
• switchoff of non-required services	Yes
• blocking of communication via physical ports	Yes
• log file for unauthorized access	No
<b>Product functions Time</b>	
Product function	
• SICLOCK support	Yes
• pass on time synchronization	Yes
Protocol is supported NTP	Yes

#### Ordering data

#### Article No.

##### CP 343-1 Advanced communications processor

For connecting the SIMATIC S7-300 CPU to Industrial Ethernet;  
 1 x 10/100/1 000 Mbit/s;  
 2 x 10/100 Mbit/s (IE switch);  
 RJ 45 ports; TCP; UDP; ISO;  
 PROFINET IO-Controller and Device, S7 communication (client + server);  
 open communication (SEND/RECEIVE); S7 routing;  
 IP configuration via DHCP/block;  
 extended web diagnostics;  
 time synchronization;  
 IP Access Control List; IP routing;  
 FTP; email; PROFINET CBA;  
 C-Plug

- With Security (Firewall + VPN) and PROFinergy (Controller + Device)

**6GK7343-1GX31-0XE0**

##### Accessories

##### IE FC RJ45 Plug 180 2 x 2

RJ45 plug-in connector for Industrial Ethernet with a rugged metal enclosure and integrated insulation displacement contacts for connecting Industrial Ethernet FC installation cables; with 180° cable outlet; for network components and CPs/CPU with Industrial Ethernet interface

- 1 pack = 1 unit
- 1 pack = 10 units
- 1 pack = 50 units

**6GK1901-1BB10-2AA0**  
**6GK1901-1BB10-2AB0**  
**6GK1901-1BB10-2AE0**

##### IE FC RJ45 Plug 145

RJ45 plug connector 2 x 2 for Industrial Ethernet with a rugged metal enclosure and integrated insulation displacement contacts for connecting Industrial Ethernet FC installation cables; with 145° cable outlet

- 1 pack = 1 unit
- 1 pack = 10 units
- 1 pack = 50 units

**6GK1901-1BB30-0AA0**  
**6GK1901-1BB30-0AB0**  
**6GK1901-1BB30-0AE0**

##### IE FC RJ45 Plug 4 x 2

RJ45 plug connector for Industrial Ethernet (10/100/1 000 Mbit/s) with a sturdy metal enclosure and integrated insulation displacement contacts for connecting Industrial Ethernet FC installation cables; 180° cable outlet; for network components and CPs/CPU with Industrial Ethernet interface

- 1 pack = 1 unit
- 1 pack = 10 units
- 1 pack = 50 units

**6GK1901-1BB11-2AA0**  
**6GK1901-1BB11-2AB0**  
**6GK1901-1BB11-2AE0**

##### IE FC TP Standard Cable GP 2 x 2 (Type A)

4-core, shielded TP installation cable for connection to IE FC Outlet RJ45/IE FC RJ45 Plug; PROFINET-compatible; with UL approval; sold by the meter; max. length 1 000 m, minimum order quantity 20 m

**6XV1840-2AH10**

**Ordering data**
**Article No.**
**Accessories**
**IE FC TP Standard Cable GP 4 x 2**

8-core, shielded TP installation cable for connection to IE FC RJ45 Modular Outlet for universal applications; with UL approval; sold by the meter; max. quantity 1 000 m, minimum order 20 m

- AWG22, for connection to IE FC RJ45 Modular Outlet
- AWG24, for connection to IE FC RJ45 Plug 4 x 2

**6XV1870-2E**
**6XV1878-2A**
**IE FC stripping tool**

Preadjusted stripping tool for fast stripping of the Industrial Ethernet FC cables

**6GK1901-1GA00**
**CSM 377 Compact Switch Module**

Unmanaged switch for connection of a SIMATIC S7-300 CPU, ET 200M, and up to three further nodes to Industrial Ethernet operating at 10/100 Mbit/s; 4 x RJ45 ports; external 24 V DC power supply, LED diagnostics, S7-300 module including electronic manual on CD-ROM

**6GK7377-1AA00-0AA0**
**SCALANCE X204-2 Industrial Ethernet Switch**

Industrial Ethernet Switches with integral SNMP access, Web diagnostics, copper cable diagnostics and PROFINET diagnostics for configuring line, star and ring topologies; four 10/100 Mbit/s RJ45 ports and two FO ports

**6GK5204-2BB10-2AA3**
**Industrial Ethernet Switch SCALANCE X308-2**

2 x 1000 Mbit/s multimode fiber-optic cable ports (SC sockets), 1 x 10/100/1 000 Mbit/s RJ45 port, 7 x 10/100 Mbit/s RJ45 ports; for glass fiber-optic cable (multimode) up to max. 750 m

**6GK5308-2FL00-2AA3**
**Note:**

For software ordering data, see page 2/584

**More information**

You will find more information on the topic of Industrial Security on the Internet at:

<http://www.siemens.com/industrialsecurity>

## PROFINET/Industrial Ethernet

### Communication for SIMATIC S7-300

#### CP 343-1 ERPC

#### Overview



ERPC	TCP/UDP	PN	MRP	IT	IP-R	PG/OP	S7/S5
●	●					●	●

The CP 343-1 ERPC (Enterprise Connect) communications processor for connecting a SIMATIC S7-300 to Industrial Ethernet networks.

The CP supports:

- PG/OP communication
- S7 communication
- Open communication (SEND/RECEIVE)
- ERPC communication

Connection of the SIMATIC S7-300 to various database systems for vertical integration is supported by means of a firmware expansion from ILS-Technology to be ordered separately.

#### Benefits



- Cost reductions through simply configured database connection by means of a firmware extension from the company ILS-Technology, to be ordered separately; no costly programming and no additional gateway PCs
- Optimum support of maintenance through
  - Web-based diagnostics
  - Remote programming via LAN/WAN (e.g. Internet)
  - Monitoring by network management tools (SNMP)
  - Module exchange without programming device using the C-PLUG swap medium
- Safeguarding of the system (security) against unauthorized access by means of device-related IP access list (IP-ACL); the capability of later connecting existing SIMATIC S7 systems to Industrial Ethernet using the CP 343-1 Advanced ensures investment protection
- The capability of later connecting existing SIMATIC S7 systems to Industrial Ethernet using the CP 343-1 ERPC ensures investment protection

#### Application

The CP 343-1 ERPC (Enterprise Connect) is used for connecting the SIMATIC S7-300 to Industrial Ethernet networks and to different ERP or MES systems for vertical integration by means of a firmware extension from the company ILS-Technology, to be ordered separately. With its own processor, the module relieves the CPU of communications tasks and facilitates additional connections.

The CP 343-1 ERPC permits communication of the S7-300 with:

- PGs/PCs
- Master computers
- HMI devices
- SIMATIC S5/S7/C7 systems
- ERP or MES systems by means of database interface, e.g. ORACLE, MySQL, MS-SQL, DB2, SAP by means of a firmware extension from the company ILS-Technology, to be ordered separately

#### Design

The CP 343-1 ERPC offers all the advantages of the SIMATIC S7-300 design:

- Compact design; the rugged plastic enclosure features the following on the front panel:
  - RJ45 socket for connection to Industrial Ethernet; Automatic detection of data transfer rate by means of autosensing function; The RJ45 socket is designed to be industry-compatible with an additional sleeve for connection of the IE FC RJ45 Plug 145/180; Integral autocrossover function permits use of uncrossed connecting cables
  - 2-pin plug-in terminal strip for connection of the 24 V DC external supply voltage
  - Diagnostics LEDs for indicating the operational and communication status
- Easy installation; the CP 343-1 ERPC is mounted on the rail of the S7-300 and connected to the adjacent modules by means of the bus connectors. No slot rules apply.
- Fanless operation; no backup battery required.
- The CP 343-1 ERPC can also be used in the expansion rack (ER) in conjunction with the IM 360/361
- The C-PLUG (configuration plug) is included in the scope of delivery as replacement medium (operation without C-PLUG is not possible)

### Function

- Gigabit interface with an RJ45 port with 10/100/1 000 Mbit/s full/half duplex with autosensing and autocrossover functionality
- Communication services:
  - Communication services: Open communication (TCP/IP, UDP)
  - PG/OP communication: across networks by means of S7 routing
  - S7 communication (client, server)
  - ERPC communication by means of a firmware expansion from the company ILS-Technology, to be ordered separately. Connection to databases such as ORACLE, MySQL, MS-SQL, DB2, SAP, and Message Queue systems. For further information on firmware expansion, refer to "deviceWISE Embedded Edition for SIMATIC S7".
- Diagnostics and network management:
  - Extensive diagnostic functions for all modules in the rack
  - Integration in network management systems through the support of SNMP V1
- Security mechanisms:
  - Access protection by means of configurable IP access list
- Configuration
  - For the configuration of the database connection, see "deviceWISE Embedded Edition for SIMATIC S7".
  - Configuration of the automation functionality with STEP 7 V5.5 or STEP 7 Professional V11
- Module replacement without programming device:
  - All information is stored on the C-PLUG

### Integration

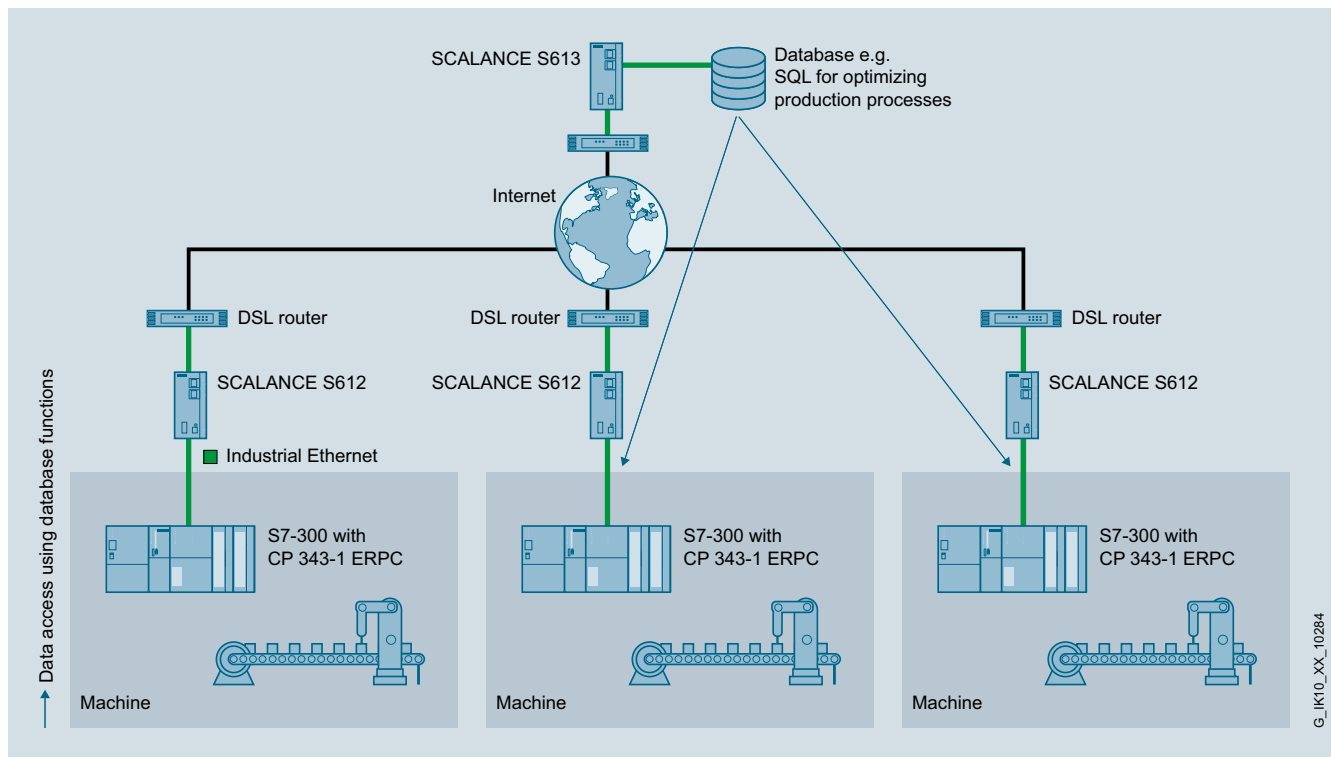

Example configuration of optimization of production process with CP 343-1 ERPC

## PROFINET/Industrial Ethernet

### Communication for SIMATIC S7-300

#### CP 343-1 ERPC

#### Integration (continued)

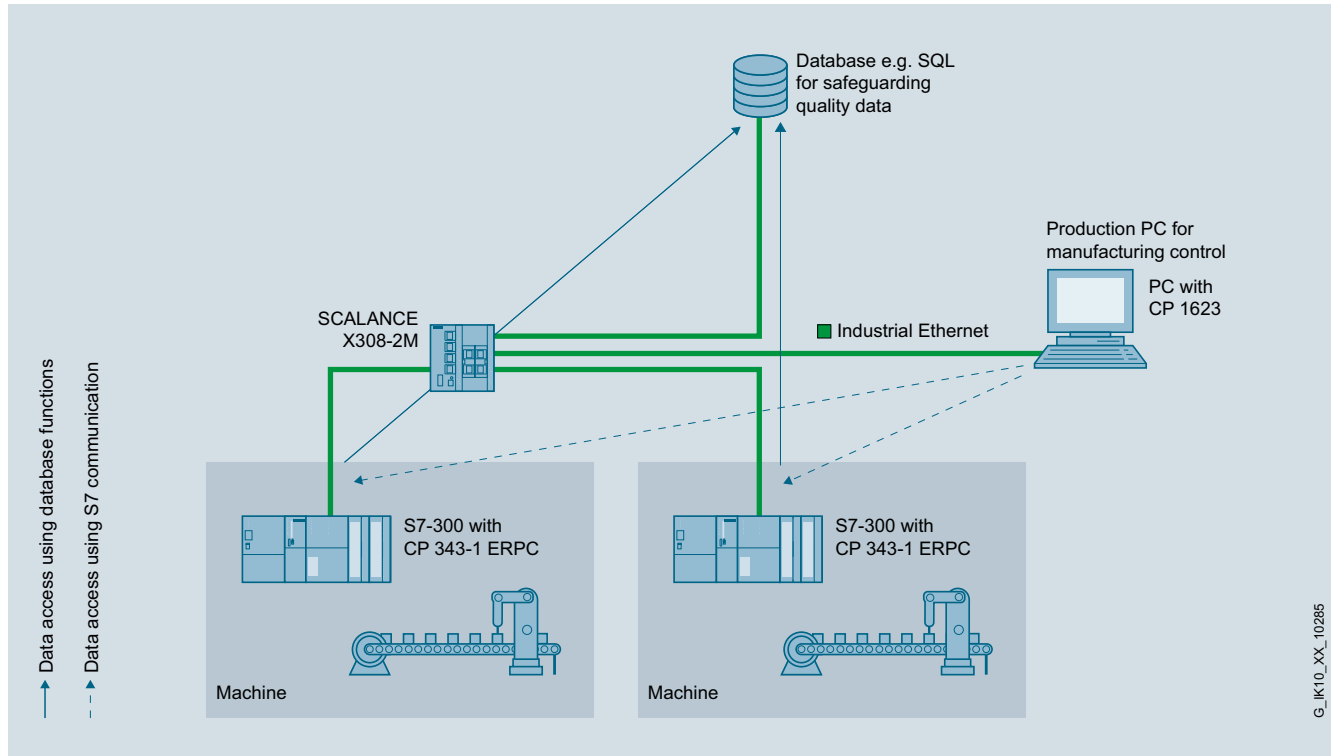

Example configuration of archiving of quality data with CP 343-1 ERPC

#### Technical specifications

Article No.	6GK7343-1FX00-0XE0
<b>Product-type designation</b>	<b>CP 343-1 ERPC</b>
<b>Transmission rate</b>	
Transfer rate at the interface 1	10 ... 1 000 Mbit/s
<b>Interfaces</b>	
Number of electrical connections	
• at interface 1 in accordance with Industrial Ethernet	1
• for power supply	1
Design of electrical connection	
• at interface 1 in accordance with Industrial Ethernet	RJ45 port
• for power supply	2-pin plug-in terminal strip
Design of the removable storage C-PLUG	Yes
<b>Supply voltage, current consumption, power loss</b>	
Type of supply voltage	DC
Supply voltage	
• 1 from backplane bus	5 V
• external	24 V
Relative positive tolerance at 24 V with DC	20 %
Relative negative tolerance at 24 V with DC	15 %

Article No.	6GK7343-1FX00-0XE0
<b>Product-type designation</b>	<b>CP 343-1 ERPC</b>
Consumed current	
• from backplane bus at 5 V for DC Typical	0.3 A
• from external supply voltage at 24 V with DC	
- typical	0.16 A
- maximum	0.6 A
Resistive loss	14.7 W
<b>Permitted ambient conditions</b>	
Ambient temperature	
• for vertical installation during operating phase	0 ... 40 °C
• for horizontal installation during operating phase	0 ... 60 °C
• during storage	-40 ... +70 °C
• during transport	-40 ... +70 °C
Relative humidity at 25 °C without condensation during operating maximum	95 %
Protection class IP	IP20

G\_IK10\_XX\_10285

**Technical specifications (continued)**

Article No.	6GK7343-1FX00-0XE0	Article No.	6GK7343-1FX00-0XE0
Product-type designation	CP 343-1 ERPC	Product-type designation	CP 343-1 ERPC
<b>Design, dimensions and weight</b>		<b>Product functions management, configuration</b>	
Module format	Compact module S7-300 double width	Product function MIB support	Yes
Width	80 mm	Protocol is supported	
Height	125 mm	• SNMP v1	Yes
Depth	120 mm	• DCP	Yes
Net weight	0.8 kg	• LLDP	Yes
<b>Performance data</b>		Configuration software required	STEP 7 V5.4 SP5 + HSP / STEP 7 Professional V11 (TIA Portal) or higher
<u>Performance data open communication</u>		Identification & maintenance function	
Number of possible connections for open communication by means of SEND/RECEIVE blocks maximum	8	• I&M0 - device-specific information	Yes
Data volume		• I&M1 - higher level designation/location designation	Yes
• as user data per ISO on TCP connection for open communication by means of SEND/RECEIVE blocks maximum	8 Kibyte	<b>Product functions Diagnosis</b>	
• as user data per TCP connection for open communication by means of SEND/RECEIVE blocks maximum	8 Kibyte	Product function Web-based diagnostics	Yes
• as user data per UDP connection for open IE communication by means of SEND/RECEIVE blocks maximum	2 Kibyte	<b>Product functions Redundancy</b>	
Number of Multicast stations	8	Product function	
<u>Performance data S7 communication</u>		• Ring redundancy	No
Number of possible connections for S7 communication		<b>Product functions Security</b>	
• maximum	8	Product function	
• note	also 2 PG/OP connections and 1 diagnostics connection	• ACL - IP-based	Yes
<u>Performance data multi-protocol mode</u>		• switchoff of non-required services	Yes
Number of active connections with multiprotocol mode	32	• blocking of communication via physical ports	Yes
<u>Performance data ERPC functions</u>		• log file for unauthorized access	No
Number of possible connections for communication with ERP or MES stations maximum	8	<b>Product functions Time</b>	
Number of possible logical triggers per CP maximum	8	Product function	
Number of configurable ERPC symbols for database access		• SICLOCK support	Yes
• per CPU maximum	2 000	• pass on time synchronization	Yes
• per logical trigger maximum	255	Protocol is supported NTP	Yes
Data volume as user data and header information per logical trigger	8 Kibyte		

## PROFINET/Industrial Ethernet

### Communication for SIMATIC S7-300

#### CP 343-1 ERPC

##### Ordering data

##### Article No.

##### Communications processor CP 343-1 ERPC (Enterprise Connect)

6GK7343-1FX00-0XE0

For the connection of SIMATIC S7-300 to Industrial Ethernet and for the support of the database connection of the SIMATIC S7-300 to various databases; TCP/UDP, S7 communication, open communication (SEND/RECEIVE), with and without RFC 1006, multicast, web server, setting of CPU's clock using SIMATIC procedures and NTP, access protection via IP access list, SNMP, DHCP, initialization over LAN 10/100/1 000 Mbit/s; with electronic manual on DVD, C-PLUG included in scope of delivery

##### deviceWISE Embedded Edition for SIMATIC S7

See Partner solutions/deviceWISE Embedded Edition for SIMATIC S7

Firmware expansion for database connection of the SIMATIC S7-300 complete with CP 343-1 ERPC to various ERP or MES systems

##### Accessories

##### IE FC RJ45 Plug 4 x 2

RJ45 plug connector for Industrial Ethernet (10/100/1 000 Mbit/s) with a sturdy metal enclosure and integrated insulation displacement contacts for connecting Industrial Ethernet FC installation cables; 180° cable outlet; for network components and CPs/CPU's with Industrial Ethernet interface

- 1 pack = 1 unit
- 1 pack = 10 units
- 1 pack = 50 units

6GK1901-1BB11-2AA0  
6GK1901-1BB11-2AB0  
6GK1901-1BB11-2AE0

##### IE FC TP Standard Cable GP 4 x 2

8-core, shielded TP installation cable for connection to IE FC RJ45 Modular Outlet for universal applications; with UL approval; sold by the meter; max. quantity 1 000 m, minimum order 20 m

- AWG22, for connection to IE FC RJ45 Modular Outlet
- AWG24, for connection to IE FC RJ45 Plug 4 x 2

6XV1870-2E  
6XV1878-2A

##### IE FC stripping tool

6GK1901-1GA00

Preadjusted stripping tool for fast stripping of the Industrial Ethernet FC cables

##### Industrial Ethernet Switch SCALANCE X308-2

6GK5308-2FL00-2AA3

2 x 1000 Mbit/s multimode fiber-optic cable ports (SC sockets), 1 x 10/100/1 000 Mbit/s RJ45 port, 7 x 10/100 Mbit/s RJ45 ports; for glass fiber-optic cable (multimode) up to max. 750 m

##### More information

You can obtain further information on the software "deviceWISE embedded Edition for SIMATIC S7" from

ILS Technology LLC;  
5300 Broken Sound Blvd.  
Suite 150  
Boca Raton, FL, USA, 33487

Phone: +1-561-982-9898 x124

Fax: +1-561-982-8638

E-mail: [devicewise@ilstechnology.com](mailto:devicewise@ilstechnology.com)

Internet: <http://www.ilstechnology.com/erpc>

##### Note:

For software ordering data, see page 2/584



### Overview



ISO	TCP/UDP	PN	MRP	IT	IP-R	PG/OP	S7/S5
●	●	●	●	●		●	●

Communications processor for connecting a SIMATIC S7-400 to Industrial Ethernet networks, also as PROFINET IO controller or in SIMATIC H systems.

The CP supports:

- PG/OP communication
- S7 communication
- Open communication (SEND/RECEIVE)
- PROFINET communication
- IT communication

The communications processor can also be used for redundant S7 communication in SIMATIC H systems and for fail-safe applications (PROFIsafe) in connection with an S7-400 F-CPU.

### Benefits



- High plant availability through the support of media redundancy (MRP) and use in the SIMATIC S7-400 H system
- Optimum support of maintenance through
  - Web-based diagnostics
  - Remote programming via WAN or a telephone network (ISDN)
  - Monitoring by means of IT network management tools (SNMP)
  - Module exchange without programming device using the C-PLUG swap medium
- Securing the system against unauthorized access by means of
  - Central access protection for any devices within an automation cell, e.g. by means of authentication of the network stations
- The capability of later connecting existing SIMATIC S7 systems to Industrial Ethernet using the CP 443-1 ensures investment protection

### Application

- The CP 443-1 is used to connect the SIMATIC S7-400 to Industrial Ethernet networks. With its own processor, it relieves the CPU of communications tasks and facilitates additional connections.

The CP 443-1 offers communication options with

- PGs/PCs
- Host computers
- HMI systems
- SIMATIC S5/S7/C7 systems
- PROFINET IO devices

### Design

The CP 443-1 features all the advantages of the SIMATIC S7-400 design:

- Compact design:
  - Two RJ45 sockets for connecting to Industrial Ethernet; automatic data rate detection by means of the autosensing/autocrossover function; the connection is made via the IE FC RJ45 Plug 180 with 180° cable outlet or via a standard patch cable
  - Diagnostics LEDs for indicating the operational and communication status
- Easy installation:
  - The CP 443-1 is mounted on the S7-400 rack and connected to the other modules via the backplane bus. No slot rules apply.
- The CP 443-1 can be operated without a fan
- The CP 443-1 can also be operated in the expansion rack (ER) in conjunction with the IM 460/461
- The module can be replaced without the need for a programming device

### Function

- Two RJ45 ports with 10/100 Mbit/s full/half duplex with autosensing and autocrossover functionality via integral 2-port switch
- Communications services of the interface:
  - Open communication (TCP/IP and UDP): Multicast with UDP, including routing between both interfaces
  - PG/OP communication: inter-network with S7 routing
  - S7 communication (client, server, multiplexing) including routing between both interfaces
  - S7-H-communication for S7-400-H-systems, now also across network boundaries (ISO-on-TCP)
  - Certified PROFINET IO controller with real-time properties (RT and IRT)
  - IP address assignment via DHCP, simple PC tool or via program block (e.g. for HMI)
- Media redundancy (MRP):
  - Within an Ethernet network with ring topology, the CP supports the media redundancy procedure MRPMRP as an MRP Manager and as an MRP Client
- Diagnostics and network management:
  - Comprehensive diagnostics functions for all modules in the rack (including graphical diagnostics, e.g. topology)
  - Integration in network management systems due to support of SNMP V1/V3

# PROFINET/Industrial Ethernet

## Communication for SIMATIC S7-400

### CP 443-1

#### Integration (continued)

- Security mechanisms:
  - Access protection by means of configurable IP access list
  - Secure firmware update
  - Plagiarism detection
  - Certification as per the Achilles Level II Standard  
[http://wurldtech.com/product\\_services/certify\\_educate/certified\\_products/](http://wurldtech.com/product_services/certify_educate/certified_products/)
- Configuration of all functions with STEP 7 V5.5 SP2; configuration with STEP 7 Professional V11 only with a limited range of functions of the predecessor CP 443-1 (6GK7 443-1EX20-0XE0) possible

#### Integration

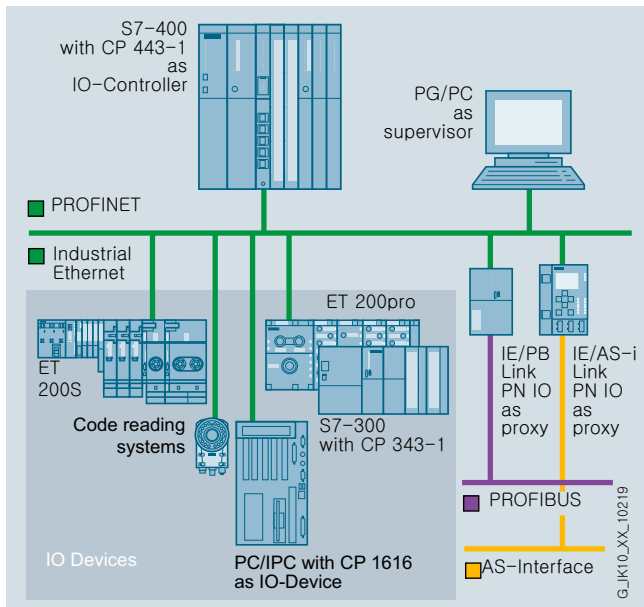

Interfacing to higher-level network with CP 443-1 as PROFINET IO controller

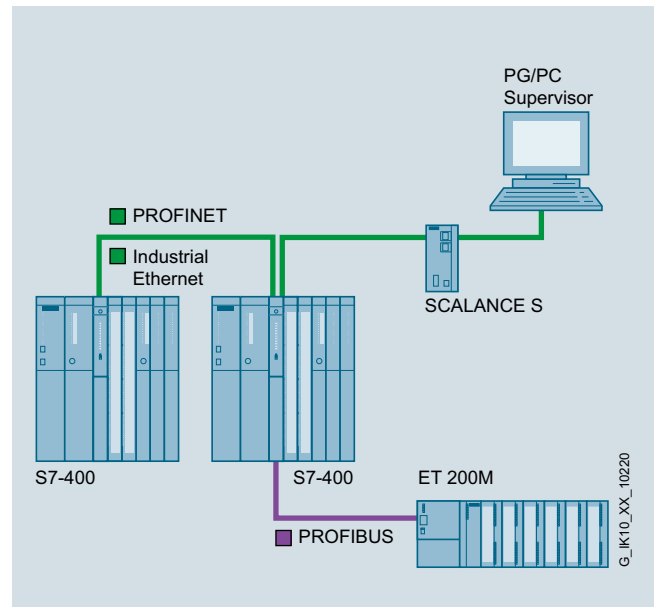

Line structure at the superordinated control level through integrated 2-port switch

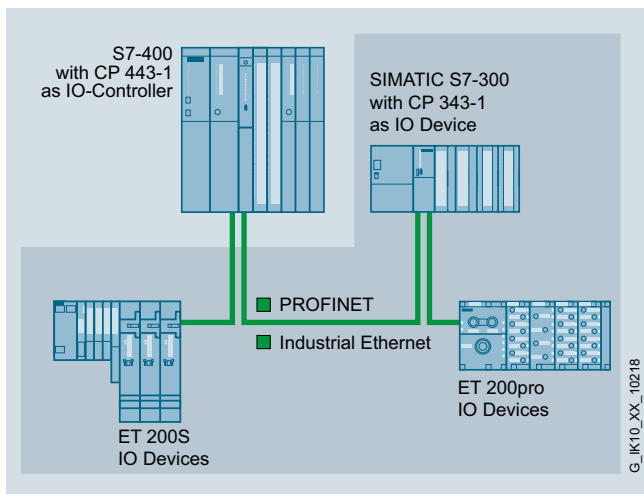

Line structure as PROFINET IO controller with integrated real-time switch

2

**Technical specifications**

Article No.	6GK7443-1EX30-0XE0	Article No.	6GK7443-1EX30-0XE0
Product-type designation	CP 443-1	Product-type designation	CP 443-1
<b>Transmission rate</b>		<b>Performance data</b>	
Transfer rate at the interface 1	10 ... 100 Mbit/s	<u>Performance data open communication</u>	
<b>Interfaces</b>		Number of possible connections for open communication by means of SEND/RECEIVE blocks maximum	64
Number of electrical connections at interface 1 in accordance with Industrial Ethernet	2	Data volume	
Design of electrical connection at interface 1 in accordance with Industrial Ethernet	RJ45 port	• as user data per ISO connection for open communication by means of SEND/RECEIVE blocks maximum	8 Kibyte
<b>Supply voltage, current consumption, power loss</b>		• as user data per ISO on TCP connection for open communication by means of SEND/RECEIVE blocks maximum	8 Kibyte
Type of supply voltage	DC	• as user data per TCP connection for open communication by means of SEND/RECEIVE blocks maximum	8 Kibyte
Supply voltage 1 from backplane bus	5 V	• as user data per UDP connection for open IE communication by means of SEND/RECEIVE blocks maximum	2 Kibyte
Relative symmetrical tolerance at 5 V with DC	5 %	Number of possible connections for open communication by means of T blocks maximum	64
Consumed current from backplane bus at 5 V for DC Typical	1.4 A	Data volume as user data per ISO on TCP connection for open communication by means of T blocks maximum	1 452 byte
Resistive loss	8.6 W	<u>Performance data S7 communication</u>	
<b>Permitted ambient conditions</b>		Number of possible connections for S7 communication	
Ambient temperature		• maximum	128
• during operating	0 ... 60 °C	• with PG connections maximum	2
• during storage	-40 ... +70 °C	• note	when using several CPUs
• during transport	-40 ... +70 °C	<u>Performance data multi-protocol mode</u>	
• Comment	-	Number of active connections with multiprotocol mode	128
Relative humidity at 25 °C without condensation during operating maximum	95 %	<u>Performance data PROFINET communication as PN IO-Controller</u>	
Protection class IP	IP20	Product function PROFINET IO controller	Yes
<b>Design, dimensions and weight</b>		Number of PN IO-Devices on PROFINET IO-Controller usable total	128
Module format	Compact module S7-400 single width	Number of PN IO IRT-Devices on PROFINET IO-Controller usable	64
Width	25 mm	Number of external PN IO lines with PROFINET per rack	4
Height	290 mm		
Depth	210 mm		
Net weight	0.7 kg		
<b>Product properties, functions, components general</b>			
Number of modules			
• per CPU maximum	14		
• note	max. 4 as PN IO ctrl.		

## PROFINET/Industrial Ethernet

### Communication for SIMATIC S7-400

CP 443-1

#### Technical specifications (continued)

Article No.	6GK7443-1EX30-0XE0
Product-type designation	CP 443-1
Data volume	
• as useful data for input variables as PROFINET IO controller maximum	4 Kibyte
• as useful data for output variables with PROFINET IO controller maximum	4 Kibyte
• as useful data for input variables per PN IO device with PROFINET IO controller maximum	1 433 byte
• as useful data for output variables per PN IO device with PROFINET IO controller maximum	1 433 byte
• as user data for input variable per PN IO device per submodule as PROFINET IO controller maximum	240 byte
• as user data for output variables per PN IO device per submodule as PROFINET IO controller maximum	240 byte
<b>Product functions management, configuration</b>	
Product function MIB support	Yes
Protocol is supported	
• SNMP v1	Yes
• DCP	Yes
• LLDP	Yes
Configuration software required	STEP 7 V5.5 SP3 or higher / STEP 7 Professional V12 (TIA Portal) or higher

Article No.	6GK7443-1EX30-0XE0
Product-type designation	CP 443-1
<b>Product functions Diagnosis</b>	
Product function Web-based diagnostics	Yes
<b>Product functions switch</b>	
Product feature switch	Yes
Product function	
• switch-managed	No
• for IRT PROFINET IO switch	Yes
• Configuration with STEP 7	Yes
<b>Product functions Redundancy</b>	
Product function	
• Ring redundancy	Yes
• Redundancy manager	Yes
• Media Redundancy Protocol (MRP)	Yes
<b>Product functions Security</b>	
Product function	
• ACL - IP-based	Yes
• switchoff of non-required services	Yes
• blocking of communication via physical ports	Yes
• log file for unauthorized access	No
<b>Product functions Time</b>	
Product function	
• SICLOCK support	Yes
• pass on time synchronization	Yes
Protocol is supported NTP	Yes

2

Ordering data	Article No.	Article No.
<b>CP 443-1 communications processor</b> For connecting SIMATIC S7-400 to Industrial Ethernet through TCP/IP, ISO and UDP; PROFINET IO Controller, MRP; integrated real-time switch ERTEC with two ports; 2 x RJ-45 interface; S7 communication, open communication (SEND/RECEIVE) with FETCH/WRITE, with and without RFC 1006, DHCP, SNMP V2, diagnostics, multicast, access protection over IP access list, initialization over LAN 10/100 Mbit/s with electronic manual on DVD	<b>6GK7443-1EX30-0XE0</b>	
<b>Accessories</b> <b>IE FC RJ45 Plug 180 2 x 2</b> RJ45 plug-in connector for Industrial Ethernet with a rugged metal enclosure and integrated insulation displacement contacts for connecting Industrial Ethernet FC installation cables; with 180° cable outlet; for network components and CPs/CPU with Industrial Ethernet interface <ul style="list-style-type: none"> <li>• 1 pack = 1 unit</li> <li>• 1 pack = 10 units</li> <li>• 1 pack = 50 units</li> </ul>		
<b>IE FC RJ45 Plug 4 x 2</b> RJ45 plug connector for Industrial Ethernet (10/100/1 000 Mbit/s) with a rugged metal housing and integrated insulation displacement contacts for connecting Industrial Ethernet FC installation cables; 180° cable outlet; for network components and CPs/CPU with Industrial Ethernet interface <ul style="list-style-type: none"> <li>• 1 pack = 1 unit</li> <li>• 1 pack = 10 units</li> <li>• 1 pack = 50 units</li> </ul>	<b>6GK1901-1BB10-2AA0</b> <b>6GK1901-1BB10-2AB0</b> <b>6GK1901-1BB10-2AE0</b>	
		<b>Accessories (continued)</b> <b>IE FC TP Standard Cable GP 2 x 2 (Type A)</b> 4-core, shielded TP installation cable for connection to IE FC Outlet RJ45/IE FC RJ45 Plug; PROFINET-compatible; with UL approval; sold by the meter; max. length 1 000 m, minimum order quantity 20 m <b>IE FC TP Standard Cable GP 4 x 2</b> 8-core, shielded TP installation cable for universal applications; with UL approval; sold by the meter; max. quantity 1 000 m, minimum order 20 m <ul style="list-style-type: none"> <li>• AWG22, for connection to IE FC RJ45 Modular Outlet</li> <li>• AWG24, for connection to IE FC RJ45 Plug 4 x 2</li> </ul>
		<b>6XV1840-2AH10</b>  <b>6XV1870-2E</b> <b>6XV1878-2A</b>
		<b>IE FC stripping tool</b> Preadjusted stripping tool for fast stripping of the Industrial Ethernet FC cables <b>6GK1901-1GA00</b>
		<b>SCALANCE X204-2 Industrial Ethernet Switch</b> Industrial Ethernet Switches with integral SNMP access, Web diagnostics, copper cable diagnostics and PROFINET diagnostics for configuring line, star and ring topologies; four 10/100 Mbit/s RJ45 ports and two FO ports <b>6GK5204-2BB10-2AA3</b>
		<b>SCALANCE X308-2 Industrial Ethernet Switch</b> 2 x 1 000 Mbit/s multimode fiber-optic cable ports (SC sockets), 1 x 10/100/1 000 Mbit/s RJ45 port, 7 x 10/100 Mbit/s RJ45 ports; for glass fiber-optic cable (multimode) up to max. 750 m <b>6GK5308-2FL00-2AA3</b>

Note:

For software ordering data, see page 2/584

## PROFINET/Industrial Ethernet

### Communication for SIMATIC S7-400

#### CP 443-1 Advanced

#### Overview



ISO	TCP/UDP	PN	MRP	IT	IP-R	PG/OP	S7/S5
●	●	●	●	●	●	●	●

Communications processor for connecting a SIMATIC S7-400 to Industrial Ethernet networks, also as PROFINET IO controller or in SIMATIC H systems.

The CP supports:

- PG/OP communication
- S7 communication
- Open communication (SEND/RECEIVE)
- PROFINET communication
- IT communication
- Security functionality, firewall and VPN

The communications processor can also be used for redundant S7 communication in SIMATIC H systems and for fail-safe applications (PROFIsafe) in connection with an S7-400 F-CPU. In addition, the CP 443-1 Advanced provides e-mail functions and user-created Web pages, offering ideal support for maintenance and quality assurance. The Internet functions such as FTP even allow connection to the most diverse PC-based systems. This CP is therefore the bridge between the field level and the management level for the S7-400. The CP 443-1 Advanced connects seamlessly to the security structures of the office and IT worlds.

#### Benefits



- Cost advantage due to connection to two separate Ethernet segments with integrated network separation
- High plant availability through the support of media redundancy (MRP) and use in the SIMATIC S7-400 H system
- Optimum support of maintenance through
  - Web-based diagnostics
  - Remote programming via WAN or telephone network (ISDN)
  - Monitoring with IT network management tools (SNMP)
  - Module replacement without programming device using the C-PLUG swap medium
- Securing the system against unauthorized access by means of
  - Central access protection for any devices within an automation cell, e.g. by means of authentication of the network stations
  - Secure remote access via the Internet by means of data encryption (VPN) and data integrity checking
  - Traceability by means of data logging on the basis of standard IT mechanisms (Syslog)
- Later connection of existing SIMATIC S7 systems to Industrial Ethernet using the CP 443-1 Advanced ensures investment protection

### Application

The CP 443-1 Advanced is used to connect the SIMATIC S7-400 to Industrial Ethernet networks. With its own processor, it relieves the CPU of communication tasks and facilitates additional connections.

The CP 443-1 Advanced provides the following communication options:

- PGs/PCs
- Master computers
- HMI systems
- SIMATIC S5/S7/C7 systems
- PROFINET I/O devices
- PROFINET CBA components

All the devices of an Ethernet network can be protected from unauthorized access. The CP 443-1 Advanced allows safe remote access over the Internet and allows data transfer between devices or network segments to be protected from data manipulation/espionage.

PROFINET CBA components and security functionalities can be used as an alternative.

2

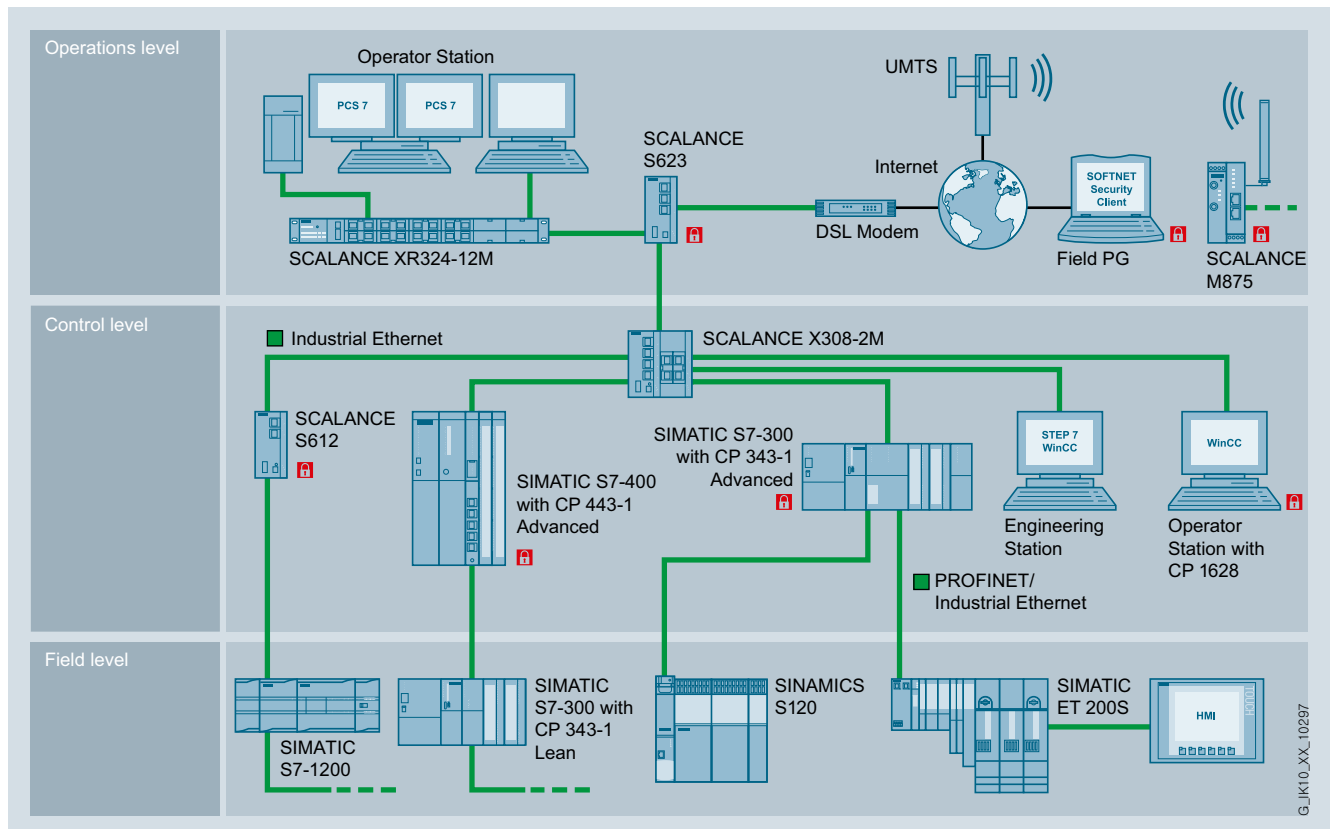

Secure VPN communication between SCALANCE S, SOFTNET Security Client and components with Security Integrated

## PROFINET/Industrial Ethernet

### Communication for SIMATIC S7-400

#### CP 443-1 Advanced

##### Design

The CP 443-1 Advanced offers all the advantages of SIMATIC S7-400 system design:

- Compact design:
  - Five RJ45 jacks for connecting to Industrial Ethernet via two independent interfaces; one of which is a security socket for externally safeguarding the network cell; automatic data rate detection by means of the autosensing and autocross function; the connection is made via the IE FC RJ45 Plug 180 with 180° cable outlet or via a standard patch cable
  - Diagnostics LEDs for indicating the operational and communication status
- Simple installation; the CP 443-1 Advanced is mounted on the S7-400 rack and connected to other modules by means of the backplane bus. There are no slot rules.
- The CP 443-1 Advanced can be operated without a fan.
- In combination with IM 460/461, the CP 443-1 Advanced can also be used in an expansion rack (ER).
- The module can be replaced without the need for a programming device
- C-PLUG (configuration plug) is included in scope of delivery as a swap medium (cannot be operated without C-PLUG).

##### Function

- Two separate interfaces (integrated network separation):
  - Gigabit interface with one RJ45 port with 10/100/1 000 Mbit/s, full/half-duplex with auto-sensing capability
  - PROFINET interface with four RJ45 ports with 10/100 Mbit/s full/half duplex with autosensing and autocrossover functionality via integrated 4-port switch
- Communications services via both interfaces:
  - Open communication (TCP/IP and UDP): Multicast with UDP, including routing between both interfaces
  - PG/OP communication: inter-network with S7 routing
  - S7 communication (client, server, multiplexing) including routing between both interfaces
  - S7-H-communication for S7-400-H-systems, now also across network boundaries (ISO-on-TCP)
  - IT communication:
    - HTTP communication permits access to process data via user's own Web pages. HTTPS communication is also possible with the CP 443-1 Advanced<sup>1)</sup>.
    - The e-mail client function allows e-mails to be sent directly from the user program.
    - FTP communication allows program-controlled FTP client communication.
    - Access to data blocks via FTP server.
- Communication services via PROFINET interfaces:
  - Certified PROFINET IO controller with real-time properties (RT and IRT)
  - PROFINET CBA
  - IP address assignment via DHCP, simple PC tool or via user program (e.g. for HMI)
- Media redundancy (MRP):
  - Within an Ethernet network with a ring topology, the CP supports the MRP media redundancy protocol as an MRP manager and as an MRP client
- Diagnostics and network management:
  - Comprehensive diagnostics functions for all modules in the rack (including graphical diagnostics, e.g. topology)
  - Integration in network management systems due to support of SNMP V1/V3
- Security mechanisms:

- Access protection by means of configurable IP access list
- Firewall for filtering connections on the basis of their IP/port addresses
- Bandwidth limitation to avoid communication overload
- VPN server and VPN client for tap-proof access to controllers
- Encrypted HTML pages using SSL (HTTPS)
- Secure file transfer (FTPs)
- Tap-proof transfer of network analysis information to the network management system (SNMP)
- Translation of private and public IP addresses (NAT/NAPT)
- Secure transfer of the time of day (NTP V3)
- Secure firmware update
- Plagiarism detection
- Certification as per the Achilles Level II Standard [http://wurldtech.com/product\\_services/certify\\_educate/certified\\_products/](http://wurldtech.com/product_services/certify_educate/certified_products/)
- Configuration of all functions with STEP 7; The security functions are configured using the Security Configuration Tool (SCT), which is included in the scope of delivery for STEP 7 V5.5 SP2 HF1.
- Configuration with STEP 7 Professional V11; only possible with a limited range of functions of the predecessor CP 443-1 (6GK7 443-1GX20-0XE0), without security functions and CBA. Version with security functions<sup>1)</sup> for TIA Portal in planning.
- When using the blocks AG\_SSEND (FC53), AG\_SRECV (FC63), TSEND (FB63), TRCV (FB64), TCON (FB65) and TDISCON (FB66), please note the following information: <http://support.automation.siemens.com/WW/view/en/60037071>
- Module replacement without programming device: all information is stored on the C-PLUG (also file system for IT functions)



### Integration

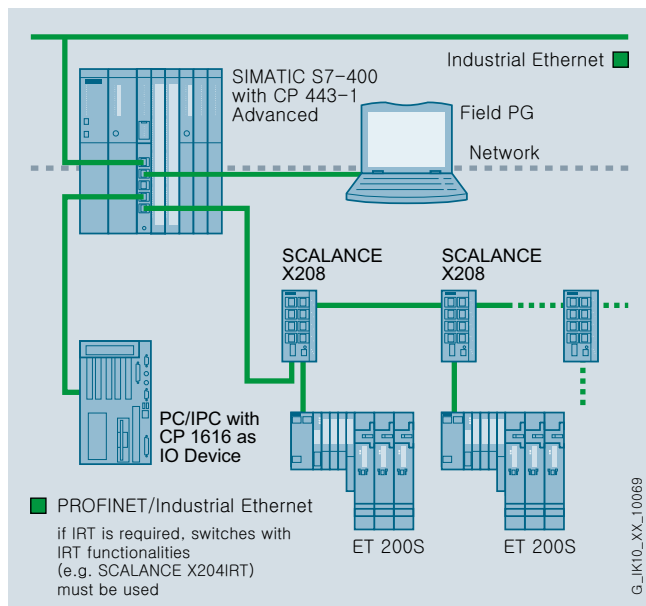

Connection to higher-level network

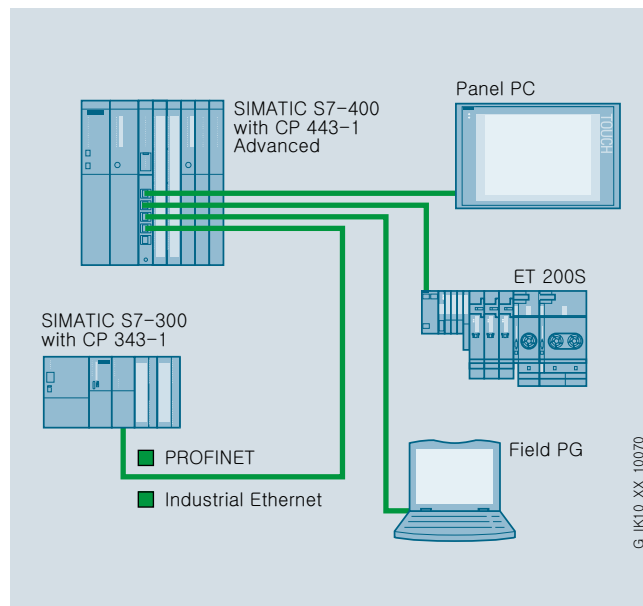

Small independent local networks (e.g. within a machine or cell)

### Technical specifications

Article No.	6GK7443-1GX30-0XE0
Product-type designation	CP 443-1 Advanced
<b>Transmission rate</b>	
Transfer rate	
• at the interface 1	10 ... 1 000 Mbit/s
• at the interface 2	10 ... 100 Mbit/s
<b>Interfaces</b>	
Number of electrical connections	
• at interface 1 in accordance with Industrial Ethernet	1
• at interface 2 in accordance with Industrial Ethernet	4
Design of electrical connection	
• at interface 1 in accordance with Industrial Ethernet	RJ45 port
• at interface 2 in accordance with Industrial Ethernet	RJ45 port
Design of the removable storage C-PLUG	Yes
<b>Supply voltage, current consumption, power loss</b>	
Type of supply voltage	DC
Supply voltage 1 from backplane bus	5 V
Relative symmetrical tolerance at 5 V with DC	5 %
Consumed current from backplane bus at 5 V for DC Typical	1.8 A
Resistive loss	7.25 W

Article No.	6GK7443-1GX30-0XE0
Product-type designation	CP 443-1 Advanced
<b>Permitted ambient conditions</b>	
Ambient temperature	
• during operating	0 ... 60 °C
• during storage	-40 ... +70 °C
• during transport	-40 ... +70 °C
Relative humidity at 25 °C without condensation during operating maximum	95 %
Protection class IP	IP20
<b>Design, dimensions and weight</b>	
Module format	Compact module S7-400 single width
Width	25 mm
Height	290 mm
Depth	210 mm
Net weight	0.7 kg
<b>Product properties, functions, components general</b>	
Number of modules	
• per CPU maximum	14
• note	max. 4 as PN IO ctrl.

# PROFINET/Industrial Ethernet

## Communication for SIMATIC S7-400

### CP 443-1 Advanced

#### Technical specifications (continued)

Article No.	6GK7443-1GX30-0XE0	Article No.	6GK7443-1GX30-0XE0
Product-type designation	CP 443-1 Advanced	Product-type designation	CP 443-1 Advanced
<b>Performance data</b>		<b>Performance data</b>	
<u>Performance data open communication</u>		<u>PROFINET communication as PN IO-Controller</u>	
Number of possible connections for open communication by means of SEND/RECEIVE blocks maximum	64	Product function PROFINET IO controller	Yes
Data volume		Number of PN IO-Devices on PROFINET IO-Controller usable total	128
• as user data per ISO connection for open communication by means of SEND/RECEIVE blocks maximum	8 Kibyte	Number of PN IO IRT-Devices on PROFINET IO-Controller usable	64
• as user data per ISO on TCP connection for open communication by means of SEND/RECEIVE blocks maximum	8 Kibyte	Number of external PN IO lines with PROFINET per rack	4
• as user data per TCP connection for open communication by means of SEND/RECEIVE blocks maximum	8 Kibyte	Data volume	
• as user data per UDP connection for open IE communication by means of SEND/RECEIVE blocks maximum	2 Kibyte	• as useful data for input variables as PROFINET IO controller maximum	8 Kibyte
Number of possible connections for open communication by means of T blocks maximum	64	• as useful data for output variables with PROFINET IO controller maximum	8 Kibyte
Data volume as user data per ISO on TCP connection for open communication by means of T blocks maximum	1 452 byte	• as useful data for input variables per PN IO device with PROFINET IO controller maximum	1 433 byte
<u>Performance data S7 communication</u>		• as useful data for output variables per PN IO device with PROFINET IO controller maximum	1 433 byte
Number of possible connections for S7 communication		• as user data for input variable per PN IO device per submodule as PROFINET IO controller maximum	240 byte
• maximum	128	• as user data for output variables per PN IO device per submodule as PROFINET IO controller maximum	240 byte
• with PG connections maximum	2		
• note	when using several CPUs	<u>Performance data PROFINET CBA</u>	
<u>Performance data multi-protocol mode</u>		Number of remote connection partners with PROFINET CBA	64
Number of active connections with multiprotocol mode	128	Number of connections with PROFINET CBA total	600
<u>Performance data IT functions</u>		Amount of data	
Number of possible connections		• as useful data for digital inputs with PROFINET CBA maximum	8 Kibyte
• as client by means of FTP maximum	20	• as useful data for digital outputs in the case of PROFINET CBA max.	8 Kibyte
• as server		• as useful data for arrays and data types	
- by means of FTP maximum	10	- in the case of acyclic transmission with PROFINET CBA maximum	8 Kibyte
- by means of HTTP maximum	4	- with PROFINET CBA with cyclic transmission maximum	250 byte
• as e-mail client maximum	1	- with PROFINET CBA in the case of local interconnection maximum	2 400 byte
Amount of data as useful data for e-mail maximum	8 Kibyte	<u>Performance data PROFINET CBA remote connection with acyclic transmission</u>	
Memory capacity of user memory		Updating time of the remote interconnections in the case of acyclic transmission with PROFINET CBA	0.1 s
• as flash memory file system	30 Mibyte	Number of remote connections to input variables with acyclic transmission with PROFINET CBA maximum	150
• as RAM	16 Mibyte	Number of remote connections to output variables with acyclic transmission with PROFINET CBA maximum	150
• additionally buffered as RAM via central backup battery	512 Kibyte		
Number of possible write cycles flash memory cells	100 000		

**Technical specifications (continued)**

Article No.	6GK7443-1GX30-0XE0	Article No.	6GK7443-1GX30-0XE0
Product-type designation	CP 443-1 Advanced	Product-type designation	CP 443-1 Advanced
Amount of data		<b>Product functions management, configuration</b>	
<ul style="list-style-type: none"> <li>as useful data for remote interconnections with input variables in the case of acyclic transmission with PROFINET CBA</li> </ul>	8 Kibyte	Product function MIB support	Yes
<ul style="list-style-type: none"> <li>as useful data for remote interconnections with output variables in the case of acyclic transmission with PROFINET CBA</li> </ul>	8 Kibyte	Protocol is supported	
		<ul style="list-style-type: none"> <li>SNMP v1</li> <li>DCP</li> <li>LLDP</li> </ul>	Yes Yes Yes
<u>Performance data</u> <u>PROFINET CBA</u> <u>remote connection</u> <u>with cyclic transmission</u>		Configuration software	
Update time of the remote interconnections with PROFINET CBA with cyclic transmission	10 ms	<ul style="list-style-type: none"> <li>required</li> </ul>	STEP 7 V5.5 SP3 or higher / STEP 7 Professional V12 (TIA Portal) or higher
Number of remote connections to input variables with PROFINET CBA with cyclic transmission maximum	250	<ul style="list-style-type: none"> <li>for PROFINET CBA required</li> </ul>	SIMATIC iMap V3.0 SP1 and higher
Number of remote connections to output variables with PROFINET CBA with cyclic transmission maximum	250	Identification & maintenance function	
Amount of data		<ul style="list-style-type: none"> <li>I&amp;M0 - device-specific information</li> <li>I&amp;M1 - higher level designation/location designation</li> </ul>	- -
<ul style="list-style-type: none"> <li>as useful data for remote interconnections with input variables with PROFINET CBA with cyclic transmission maximum</li> </ul>	2 000 byte	<b>Product functions Diagnosis</b>	
<ul style="list-style-type: none"> <li>as useful data for remote interconnections with output variables with PROFINET CBA with cyclic transmission maximum</li> </ul>	2 000 byte	Product function Web-based diagnostics	Yes
<u>Performance data</u> <u>PROFINET CBA</u> <u>HMI variables via PROFINET</u> <u>acyclic</u>		<b>Product functions switch</b>	
Number of connectable HMI stations for HMI variables with acyclic transmission with PROFINET CBA	3	Product feature switch	Yes
Updating time of the HMI variables in the case of acyclic transmission with PROFINET CBA	500 ms	Product function	
Number of HMI variables with acyclic transmission with PROFINET CBA maximum	200	<ul style="list-style-type: none"> <li>switch-managed</li> <li>for IRT PROFINET IO switch</li> <li>Configuration with STEP 7</li> </ul>	No Yes Yes
Amount of data as useful data for HMI variables in the case of acyclic transmission with PROFINET CBA maximum	8 Kibyte	<b>Product functions Redundancy</b>	
<u>Performance data</u> <u>PROFINET CBA</u> <u>device-internal connections</u>		Product function	
Number of internal connections with PROFINET CBA maximum	300	<ul style="list-style-type: none"> <li>Ring redundancy</li> <li>Redundancy manager</li> <li>Media Redundancy Protocol (MRP)</li> </ul>	Yes Yes Yes
Data volume of internal connections with PROFINET CBA maximum	2 400 byte	<b>Product functions Security</b>	
<u>Performance data</u> <u>PROFINET CBA</u> <u>connections to constants</u>		Design of the firewall	stateful inspection
Number of connections to constants with PROFINET CBA maximum	500	Product function with VPN connection	IPSec
Amount of data as useful data for interconnections with constants in the case of PROFINET CBA maximum	4 000 byte	Type of encryption algorithms with VPN connection	AES-256, AES-192, AES-128, 3DES-168, DES-56
<u>Performance data</u> <u>PROFINET CBA</u> <u>PROFIBUS proxy functionality</u>		Type of authentication procedure with VPN connection	Preshared key (PSK), X.509v3 certificates
Product function with PROFINET CBA PROFIBUS proxy functionality	No	Type of hashing algorithms with VPN connection	MD5, SHA-1
		Number of possible connections for VPN connection	32
		Product function	
		<ul style="list-style-type: none"> <li>password protection for Web applications</li> <li>ACL - IP-based</li> <li>ACL - IP-based for PLC/routing</li> <li>switchoff of non-required services</li> <li>blocking of communication via physical ports</li> <li>log file for unauthorized access</li> </ul>	Yes Yes Yes Yes Yes No
		<b>Product functions Time</b>	
		Product function	
		<ul style="list-style-type: none"> <li>SICLOCK support</li> <li>pass on time synchronization</li> </ul>	Yes Yes
		Protocol is supported NTP	Yes

# PROFINET/Industrial Ethernet

## Communication for SIMATIC S7-400

### CP 443-1 Advanced

#### Ordering data

#### Article No.

##### Communications processor CP 443-1 Advanced

for connecting the SIMATIC S7-400 CPU to Industrial Ethernet:  
1 x 10/100/1 000 Mbit/s;  
4 x 10/100 Mbit/s (IE SWITCH);  
RJ45 ports; ISO; TCP; UDP;  
PROFINET IO controller,  
S7 communication;  
open communication (SEND/  
RECEIVE); S7 routing;  
IP configuration via DHCP/block;  
IP Access Control List;  
time synchronization;  
expanded web diagnostics;  
Fast Startup; PROFInergy support;  
IP routing; FTP; web server; e-mail;  
PROFINET CBA

- With security functionality (firewall and VPN)

**6GK7443-1GX30-0XE0**

##### Accessories

##### IE FC RJ45 Plug 180 2 x 2

RJ45 plug-in connector for Industrial Ethernet with a rugged metal enclosure and integrated insulation displacement contacts for connecting Industrial Ethernet FC installation cables;  
with 180° cable outlet;  
for network components and CPs/CPUs with Industrial Ethernet interface

- 1 pack = 1 unit
- 1 pack = 10 units
- 1 pack = 50 units

**6GK1901-1BB10-2AA0**  
**6GK1901-1BB10-2AB0**  
**6GK1901-1BB10-2AE0**

##### IE FC RJ45 Plug 4 x 2

RJ45 plug connector for Industrial Ethernet (10/100/1 000 Mbit/s) with a rugged metal enclosure and integrated insulation displacement contacts for connecting Industrial Ethernet FC installation cables;  
180° cable outlet;  
for network components and CPs/CPUs with Industrial Ethernet interface

- 1 pack = 1 unit
- 1 pack = 10 units
- 1 pack = 50 units

**6GK1901-1BB11-2AA0**  
**6GK1901-1BB11-2AB0**  
**6GK1901-1BB11-2AE0**

#### Article No.

##### Accessories (continued)

##### IE FC TP Standard Cable GP 2 x 2 (Type A)

4-core, shielded TP installation cable for connection to IE FC Outlet RJ45/IE FC RJ45 Plug; PROFINET-compatible; with UL approval; sold by the meter; max. length 1 000 m, minimum order quantity 20 m

**6XV1840-2AH10**

##### IE FC TP Standard Cable GP 4 x 2

8-core, shielded TP installation cable for universal applications; with UL approval; sold by the meter; max. quantity 1 000 m, minimum order 20 m

**6XV1870-2E**

- AWG22, for connection to IE FC RJ45 Modular Outlet
- AWG24, for connection to IE FC RJ45 Plug 4 x 2

**6XV1878-2A**

##### IE FC stripping tool

Preadjusted stripping tool for fast stripping of the Industrial Ethernet FC cables

**6GK1901-1GA00**

##### SCALANCE X204-2 Industrial Ethernet Switch

Industrial Ethernet Switches with integral SNMP access, Web diagnostics, copper cable diagnostics and PROFINET diagnostics for configuring line, star and ring topologies;  
four 10/100 Mbit/s RJ45 ports and two FO ports

**6GK5204-2BB10-2AA3**

##### Industrial Ethernet Switch SCALANCE X308-2

2 x 1 000 Mbit/s multimode fiber-optic cable ports (SC sockets), 1 x 10/100/1000 Mbit/s RJ45 port, 7 x 10/100 Mbit/s RJ45 ports; for glass fiber-optic cable (multimode) up to max. 750 m

**6GK5308-2FL00-2AA3**

##### Note:

For software ordering data, see page 2/584

#### More information

You will find more information on the topic of Industrial Security on the Internet at:

<http://www.siemens.com/industrialsecurity>

### Overview



ISO	TCP/UDP	PN	PRP	IT	IP-R	PG/OP	S7/S5
●	●		●			●	●

Communication processor for connecting a SIMATIC S7-400/S7-400H to Industrial Ethernet networks.

The CP supports:

- PG/OP communication
- S7 communication
- Open communication (SEND/RECEIVE)

The communications processor can be used in SIMATIC H systems and for fail-safe applications (PROFIsafe) in connection with an S7-400 F-CPU. The CP 443-1 RNA (**R**edundant **N**etwork **A**ccess)<sup>1)</sup> offers the option of using the PRP procedure (**P**arallel **R**edundancy **P**rotocol in accordance with IEC 62439-3) to connect an S7-400 or S7-400H to parallel, separate networks where high availability is required.

The PRP functionality can be deactivated so that standard Industrial Ethernet communication is also possible with the CP.

The PRP redundancy procedure is based on double transmission of message frames over two separate networks (LAN A, LAN B). In the event of a fault in one of the two networks, transmission of the message frame from the second network is ensured without delay. A reconfiguration time (switchover of the communication paths) for the network, such as is required with other redundancy procedures, is thus not necessary.

<sup>1)</sup> At Siemens Industry, RNA stands for hardware and software to implement redundancy solutions. RNA contains the PRP V1 protocol in accordance with the IEC 62439-3 standard (Parallel Redundancy Protocol) as well as the HSR protocol in accordance with IEC 62439-3 (High-availability Seamless Redundancy Protocol).

### Benefits

get **Designed for Industry**

- Cost advantage due to connection to two separate Ethernet segments with integrated network separation
- High plant availability through the support of media redundancy (MRP) and use in the SIMATIC S7-400 H system
- Use in plants with high availability requirements
- Use in time-critical applications, since there is bumpless switchover in the event of a fault on the network
- Simple integration, since no additional programming overhead required for communication via PRP (transparent at application level)
- Optimum support of maintenance through
  - Web-based diagnostics
  - Remote programming via WAN or telephone network (ISDN)
  - Monitoring with IT network management tools (SNMP)
  - Module replacement without programming device using the C-PLUG swap medium
- Investment protection thanks to later connection of existing SIMATIC S7 systems to redundant, parallel networks using the CP 443-1 RNA
- The simple, single interfaces of the SEND/RECEIVE blocks enable straightforward parameterization and programming for customized communication requirements

## PROFINET/Industrial Ethernet

### Communication for SIMATIC S7-400

#### CP 443-1 RNA

##### Application

The CP 443-1 RNA enables communication in networks where extremely high plant availability is important.

It offers communication options with

- PGs/PCs
- Master computers
- SIMATIC S5/S7/C7 systems
- Third-party systems

With the CP 443-1 RNA, an S7-400 station can be connected to a high-availability PRP network.

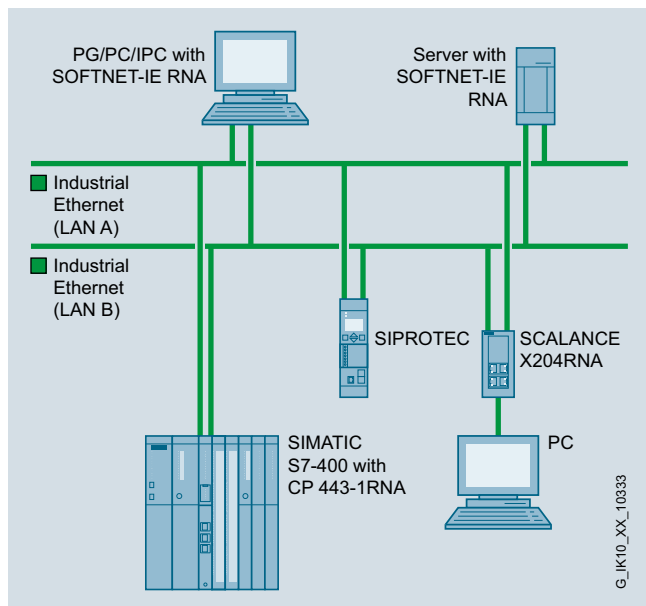

Connection of an S7-400 to a PRP network

##### Design

The CP 443-1 RNA offers all the advantages of the SIMATIC S7-400 system design:

- Compact design:
  - Three RJ45 jacks for connecting to Industrial Ethernet via two independent interfaces, of which only one can ever be active;
  - automatic data rate detection by means of the autonegotiation and autocross function;
  - the connection is made via the IE FC RJ45 Plug 180 with 180° cable outlet or via a standard patch cable.
  - Diagnostics LEDs for indicating the operational and communication status
- Simple installation; the CP 443-1 RNA is mounted on the S7-400 rack and connected to other modules by means of the backplane bus. There are no slot rules.
- The CP 443-1 RNA can be operated without a fan
- In combination with the IM 460/461, the CP 443-1 RNA can also be used in an expansion rack (ER)
- The module can be replaced without the need for a programming device

##### Function

A SIMATIC S7-400/S7-400H is connected to two parallel Industrial Ethernet networks via the two RJ45 connections of the CP 443-1 RNA. The CP uses the parallel redundancy protocol in accordance with the IEC 62439-3 standard. It doubles the message frame and feeds it into the two connected networks. The access point on the receiver side forwards the first arriving message frame to the addressee. The frame arriving later is discarded.

##### Two separate interfaces:

- RNA interface with two RJ45 ports with 100 Mbit/s full duplex with autonegotiation and autocrossover functionality (no switching functionality) for connection to a PRP network
- Ethernet interface with an RJ45 port with 10/100 Mbit/s full/half duplex with autonegotiation and autocrossover functionality

There is only ever one interface active, no IP routing between the interfaces; communication per interface only possible to the CPU in each case.

The PRP functionality can be deactivated, and the independent Ethernet interface can be activated as an alternative to the RNA interface. Standard Industrial Ethernet communication is thus also possible with the CP. Only the communication service is supported via the ISO transport protocol on the Ethernet interface, and all other services are deactivated. The CP is thus also suitable for applications that require qualification and can manage with the restricted functionality. The qualification costs can be reduced in this way.

##### Communication services

on the RNA interface (interface X2):

- Open communication (ISO, ISO on TCP, TCP/IP and UDP): Multicast with UDP
- PG/OP communication: across networks by means of S7 routing
- S7 communication (ISO, ISO on TCP, client, server)
- S7 H communication for S7-400 H systems beyond network boundaries (ISO-on-TCP, ISO)
- Time synchronization by means of the SIMATIC procedure and NTP
- IP address assignment via a simple PC tool
- Security mechanisms: Access protection by means of configurable IP access list

##### Communication services

on the Ethernet interface (interface X1):

- Open communication (ISO only)
- PG/OP communication: across networks by means of S7 routing (ISO)
- S7 communication (ISO client only, server)

##### Diagnostics and network management:

- Extensive diagnostics functions of all modules in the rack via Web diagnostics, integrated into STEP 7
- Integration into network management systems through the support of SNMP V1; the following MIBs are supported: MIBII, Automation MIB and PRP-MIB (IEC-62439-3)

##### Configuring

of all functions with STEP 7 from V5.5 SP2 plus HSP

Module replacement possible without PG.

**Integration**

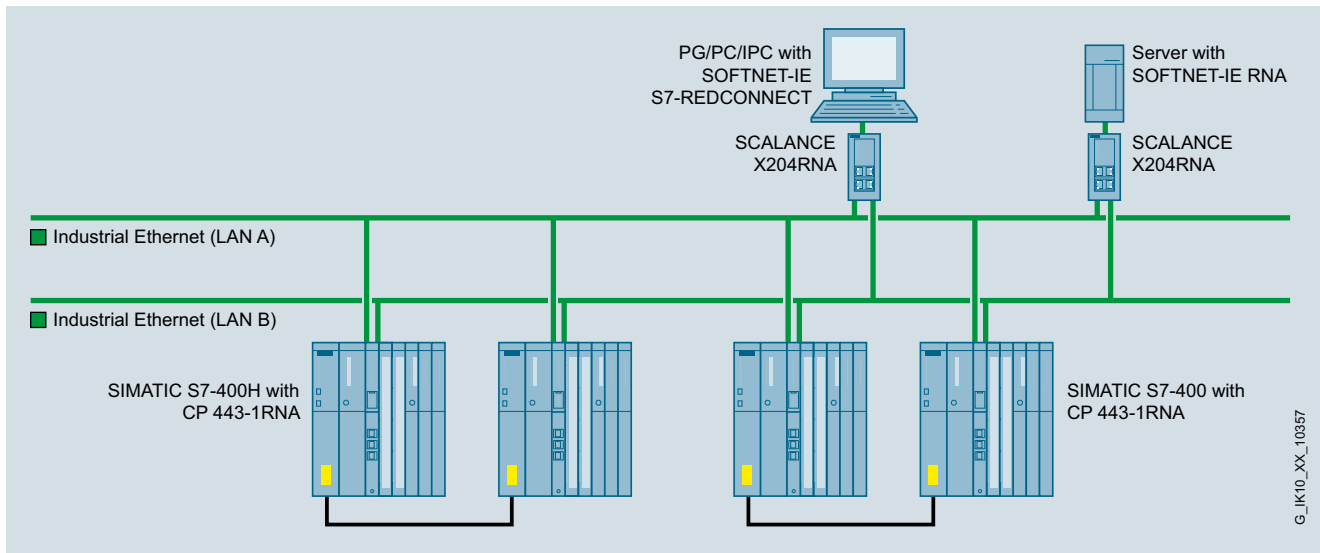

PRP communication with connected H systems to HMI station

Note:

With the SIMATIC NET DVD V12 it is possible to link SOFTNET REDCONNECT and SOFTNET RNA; in this case, the SCALANCE X switch can be omitted.

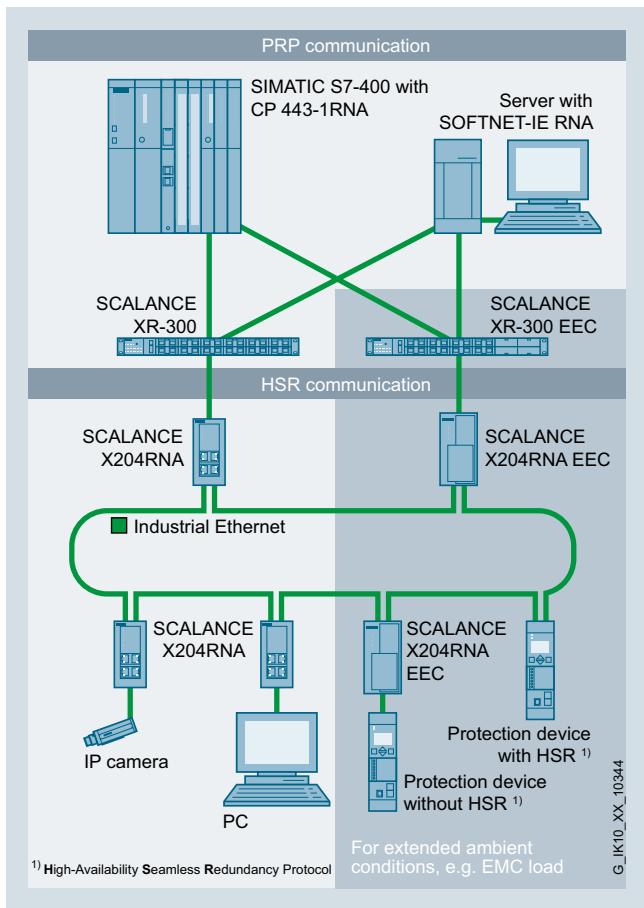

Example configuration: redundant network topology with PRP and HSR communication

# PROFINET/Industrial Ethernet

## Communication for SIMATIC S7-400

### CP 443-1 RNA

#### Technical specifications

Article No.	6GK7443-1RX00-0XE0	Article No.	6GK7443-1RX00-0XE0
Product-type designation	CP 443-1 RNA	Product-type designation	CP 443-1 RNA
<b>Transmission rate</b>		<b>Performance data</b>	
Transfer rate		<u>Performance data</u> <u>open communication</u>	
• at the interface 1	10 ... 100 Mbit/s	Number of possible connections for open communication by means of SEND/RECEIVE blocks maximum	64
• at the interface 2	100 Mbit/s	Data volume	
<b>Interfaces</b>		• as user data per ISO connection for open communication by means of SEND/RECEIVE blocks maximum	8 192 byte
Number of electrical connections		• as user data per ISO on TCP connection for open communication by means of SEND/RECEIVE blocks maximum	8 192 byte
• at interface 1 in accordance with Industrial Ethernet	1	• as user data per TCP connection for open communication by means of SEND/RECEIVE blocks maximum	8 192 byte
• at interface 2 in accordance with Industrial Ethernet	2	• as user data per UDP connection for open IE communication by means of SEND/RECEIVE blocks maximum	2 048 byte
Design of electrical connection		Number of possible connections for open communication by means of T blocks maximum	64
• at interface 1 in accordance with Industrial Ethernet	RJ45 port	Data volume as user data per ISO on TCP connection for open communication by means of T blocks maximum	1 452 byte
• at interface 2 in accordance with Industrial Ethernet	RJ45 port	<u>Performance data</u> <u>S7 communication</u>	
<b>Supply voltage, current consumption, power loss</b>		Number of possible connections for S7 communication	
Type of supply voltage	DC	• maximum	128
Supply voltage 1 from backplane bus	5 V	• with PG connections maximum	2
Relative symmetrical tolerance at 5 V with DC	5 %	• note	when using several CPUs
Consumed current from backplane bus at 5 V for DC typical	1.8 A	<u>Performance data</u> <u>multi-protocol mode</u>	
Resistive loss	7.25 W	Number of active connections with multiprotocol mode	128
<b>Permitted ambient conditions</b>			
Ambient temperature			
• during operating	0 ... 60 °C		
• during storage	-40 ... +70 °C		
• during transport	-40 ... +70 °C		
Relative humidity at 25 °C without condensation during operating maximum	95 %		
Protection class IP	IP20		
<b>Design, dimensions and weight</b>			
Module format	Compact module S7-400 single width		
Width	0.025 m		
Height	0.29 m		
Depth	0.21 m		
Net weight	0.7 kg		
<b>Product properties, functions, components general</b>			
Number of modules			
• per CPU maximum	14		
• note	-		



**Technical specifications** (continued)

<b>Article No.</b>	<b>6GK7443-1RX00-0XE0</b>
<b>Product-type designation</b>	<b>CP 443-1 RNA</b>
<b>Product functions management, configuration</b>	
Product function MIB support	Yes
Protocol is supported SNMP v1	Yes
Configuration software required	STEP 7 V5.5 SP2 + HSP or higher
<b>Product functions Diagnosis</b>	
Product function Web-based diagnostics	Yes
<b>Product functions Redundancy</b>	
Product function Parallel Redundancy Protocol (PRP)	Yes
<b>Product functions Security</b>	
Product function	
• ACL - IP-based	Yes
• ACL - IP-based for PLC/routing	Yes
• switchoff of non-required services	Yes
• blocking of communication via physical ports	Yes
<b>Product functions Time</b>	
Product function	
• SICLOCK support	Yes
• pass on time synchronization	Yes
Protocol is supported NTP	Yes

**Ordering data**

<b>CP 443-1 RNA communications processor</b>	<b>6GK7443-1RX00-0XE0</b>
for connecting the SIMATIC S7-400/S7-400H CPU to Industrial Ethernet	
<b>Accessories</b>	
<b>SCALANCE X-200RNA Industrial Ethernet network access points</b>	
Industrial Ethernet network access points with integrated SNMP access, web diagnostics and PROFINET diagnostics, for connecting non-PRP-enabled terminal equipment to PRP networks; incl. operating instructions, Industrial Ethernet network manual and configuration software on CD-ROM; with electrical and optical ports for glass multimode fiber optic cables up to 5 km	
• <b>SCALANCE X204RNA</b> with four 100 Mbit/s RJ45 ports	<b>6GK5204-0BA00-2KB2</b>
• <b>SCALANCE X204RNA EEC</b> with two 100 Mbit/s RJ45 ports and two RJ45/SFP combo ports	<b>6GK5204-0BS00-3LA3</b>
• <b>SCALANCE X204RNA EEC</b> with two 100 Mbit/s RJ45 ports and two RJ45/SFP combo ports with PRP or HSR support	<b>6GK5204-0BS00-3PA3</b>
<b>SOFTNET-IE RNA</b>	
Software for connecting PCs to PRP-enabled networks with integrated SNMP, runtime software, software and electronic manual on CD-ROM, license key on USB flash drive, Class A	
<b>SOFTNET-IE RNA V12</b>	
for 32/64-bit Windows 7 Professional/Ultimate; for Windows 2008 Server R2; for 32/64-bit Windows 8 Professional/Enterprise; for Windows Server 2012 German/English	
• Single license for one installation	<b>6GK1711-1EW12-0AA0</b>
<b>SOFTNET-IE RNA V8.1</b>	
for 32-bit Windows XP; German/English	
• Single license for one installation	<b>6GK1711-1EW08-1AA0</b>
<b>Software Update Service</b>	
for 1 year with automatic extension; requirement: Current software version	<b>6GK1711-1EW00-3AL0</b>

**Note:**

For software ordering data, see page 2/584

**More information**

You will find more information on the topic of Redundant Network Access on the Internet at:

<http://www.siemens.com/rna>

# PROFINET/Industrial Ethernet

## Communication for SIMATIC S7

### Software

#### Ordering data

#### Article No.

#### Article No.

##### Software

##### *SOFTNET S7 for Industrial Ethernet*

Software for S7 and open communication, including OPC server, PG/OP communication and NCM PC, runtime software, software and electronic manual on CD-ROM, license key on a USB stick, Class A

For CP 243-1, CP 1243-1, CP 1543-1, CM 1542-1, CP 343-1 Lean, CP 343-1, CP 343-1 Advanced, CP 343-1 ERPC, CP 443-1, CP 443-1 Advanced, CP 443-1 RNA

##### **SOFTNET-IE S7 V12**

For 32/64-bit Windows 7 Professional/Ultimate; for 64-bit: Windows 2008 Server R2 for 32/64-bit: Windows8 Pro for Windows Server 2012 German/English

up to 64 connections

- Single License for one installation

**6GK1704-1CW12-0AA0**

##### **SOFTNET-IE S7 Lean Edition V12**

Up to eight connections

- Single License for one installation

**6GK1704-1LW12-0AA0**

##### **STEP 7 Version 5.5**

##### *Target system:*

SIMATIC S7-300/-400, SIMATIC C7, SIMATIC WinAC

##### *Requirements:*

Windows XP Prof., Windows 7 Professional/Ultimate

##### *Type of delivery:*

German, English, French, Spanish, Italian; including license key on USB stick, with electronic documentation

For CP 343-1 Lean, CP 343-1, CP 343-1 Advanced, CP 343-1 ERPC, CP 443-1, CP 443-1 Advanced, CP 443-1 RNA

- Floating License on DVD
- Rental License for 50 hours
- Software Update Service on DVD (requires current software version)
- Upgrade Floating License 3.x/4.x/5.x to V5.5; on DVD
- Trial License STEP 7 V5.5; on DVD, 14 day trial

**6ES7810-4CC10-0YA5**

**6ES7810-4CC10-0YA6**

**6ES7810-4BC01-0YX2**

**6ES7810-4CC10-0YE5**

**6ES7810-4CC10-0YA7**

##### **STEP 7 Professional / Basic engineering software V13 (TIA Portal)**

##### *Target system:*

SIMATIC S7-1200, S7-1500, S7-300, S7-400, WinAC

##### *Requirement:*

Windows 7 Professional (64 bit), Windows 7 Enterprise (64 bit), Windows 7 Ultimate SP1 (64 bit), Windows 8.1 (64 bit), Windows 8.1 Professional (64 bit), Windows 8.1 Enterprise (64 bit), Windows Server 2008 R2 StdE (full installation), Windows Server 2012 StdE (full installation)

##### *Form of delivery:*

German, English, Chinese, Italian, French, Spanish

For CP 1243-1, CP 1543-1, CM 1542-1, CP 343-1 Lean, CP 343-1, CP 343-1 Advanced, CP 343-1 ERPC, CP 443-1, CP 443-1 Advanced

- STEP 7 Professional V13, Floating License
- STEP 7 Professional V13, Trial License
- Upgrade STEP 7 Professional V12 to STEP 7 Professional V13, Floating License
- Upgrade STEP 7 Professional 2006/2010 to STEP 7 Professional 2010/V13, Floating License
- PowerPack & Upgrade from STEP 7 V5.4/V5.5 to STEP 7 Professional 2010/V13, Floating License
- PowerPack STEP 7 Basic V13 to STEP 7 Professional V13, Floating License

**6ES7822-1AA03-0YA5**

**6ES7822-1AA03-0YA7**

**6ES7822-1AA03-0YE5**

**6ES7822-1AA03-0XE5**

**6ES7822-1AA03-0XC5**

**6ES7822-1AA03-0YC5**

2

Ordering data	Article No.	Article No.
<b>STEP 7 Professional engineering software V13; software download incl. license key <sup>1)</sup></b> E-mail address required for the delivery <ul style="list-style-type: none"> <li>STEP 7 Professional V13, Floating License</li> <li>Upgrade STEP 7 Professional V12 to STEP 7 Professional V13, Floating License</li> <li>Upgrade STEP 7 Professional 2006/2010 to STEP 7 Professional 2010/V13, Floating License</li> <li>PowerPack &amp; upgrade from STEP 7 V5.4/V5.5 to STEP 7 Professional 2010/V13, Floating License</li> <li>PowerPack STEP 7 Basic V13 to STEP 7 Professional V13, Floating License</li> </ul>	<b>6ES7822-1AE03-0YA5</b>  <b>6ES7822-1AE03-0YE5</b>  <b>6ES7822-1AE03-0XE5</b>  <b>6ES7822-1AE03-0XC5</b>  <b>6ES7822-1AA03-0YC5</b>	<b>SIMATIC iMap V3.0</b> <i>For CP 343-1 Advanced, CP 443-1 Advanced</i> for configuration of PROFINET CBA <i>Requirement:</i> Windows 2000 Prof. with Service Pack 4 or later or Windows XP Prof. with Service Pack 1 or later or Windows 2003 Server with Service Pack 1; on PG or PC with Pentium processor, min. 1 GHz; STEP 7 V5.3 Service Pack 3 or later, PN OPCServer V6.3 or later <i>Form of delivery:</i> German, English, with electronic documentation <ul style="list-style-type: none"> <li>Single License</li> <li>Software Update Service</li> <li>Upgrade to V3.0, Single license</li> </ul>
<b>STEP 7-Micro/WIN V4 programming software</b> <i>For CP 243-1</i> <i>Target system:</i> All CPUs of the SIMATIC S7-200 <i>Requirement:</i> Windows 2000/XP on PG or PC, <i>available in:</i> German, English, French, Spanish, Italian, Chinese; with online documentation <ul style="list-style-type: none"> <li>Single License</li> <li>Single license upgrade</li> </ul>	<b>6ES7810-2CC03-0YX0</b> <b>6ES7810-2CC03-0YX3</b>	<b>6ES7820-0CC04-0YA5</b> <b>6ES7820-0CC01-0YX2</b> <b>6ES7820-0CC04-0YE5</b>

<sup>1)</sup> For up-to-date information and download availability, see:  
<http://www.siemens.com/tia-online-software-delivery>

# PROFINET/Industrial Ethernet

## System interfaces for PG/PC/IPC

### Communication for PC-based systems

#### Introduction

#### Overview

2



#### Software



- ▶ You will find software products on the SIMATIC NET/Windows CD.
- ▶ Development Kits are available for use in various operating system environments (e.g. for CP 1616 or CP 1604).
- ▶ As a rule, the necessary configuration tools are included in the software packages.
- ▶ Manuals in PDF format and extensive supplementary information on SIMATIC NET products and communication can be found in the SIMATIC NET Manual Collection which is enclosed with the software products.

SIMATIC NET  
Manual Collection



#### Hardware

##### CPs with an internal microprocessor

CP 1613 A2 (PCI)



CP 1623/  
CP 1628 (PCIe)



CP 1616 (PCI)



CP 1604  
(PC/104-Plus)

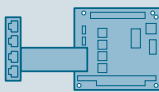

##### CP without an internal microprocessor

CP 1612 A2  
(PCI 32 Bit)



G\_IK10\_XX\_50183

#### CPs with an internal microprocessor

- Protocol software executes on the CP
- Free PC resources for applications
- Suitable for comprehensive applications
- Recommended for applications with HMI systems which have high performance requirements, e.g. WinCC
- Recommended for large systems (eight stations or more, e.g. SIMATIC)
- Constant communication throughput
- Can be used for redundant communication
- Use for PROFINET IO real-time applications (RT, IRT with CP 1616/CP 1604)
- Time synchronization

#### CPs without internal microprocessor

- Protocol software executes on the PG/PC
- PC resources are divided between communications and applications
- Suitable for less comprehensive applications
- Recommended for smaller applications (up to eight stations, e.g. SIMATIC)
- Communications performance depends on PC resources and PC loading

#### CPs with integral switch

- Connection of additional field devices to the Industrial Ethernet by means of additional switch ports
- Switch operation possible via external power supply even with PC turned off

#### Configuration for SIMATIC NET version V12 or higher

STEP 7 V12 or higher is used for PC configuration. The STEP 7 software is included in the scope of delivery of the SIMATIC NET products. A STEP 7 license is not required for PC configuration.

#### Configuration for SIMATIC NET versions up to V8.2:

The PC can be configured either in STEP 7 or in NCM PC Version V5.1+SP2 and higher. Both tools offer the same 'look & feel' and create the same database. This enables integrated configuration of the open communication and S7 communication functions. Data only has to be entered once and data consistency is assured.

- A configuration wizard integrated into NCM PC also supports user-driven configuration of the PC station.
- With NCM PC and STEP 7 from Version V5.1+SP2 upwards, a PC similar to a SIMATIC S7 station can be configured and loaded over a network. This applies both to the local station on which NCM PC or STEP 7 is installed and to the remote station that is addressed over the network.

#### Note:

NCM PC does not contain a conversion function for LDBs that were created using COML S7. Reconfiguration is necessary.

**Overview** (continued)

CPs for PG/PC/IPC		Hardware																										
		Type of device	Connection to S7 backplane bus	Format module S7	PC module	Flat type of construction	Box type of construction	19" type of construction	Rugged, compact housing	Modular design	10 Gigabit Ethernet	Gigabit Ethernet	PoE (Power over Ethernet)	LED diagnosis	SIMATIC environment	Redundant power supply (2 x 24 V DC)	External supply for integrated switch	Signal contact	Local display (SET pushbutton)	C-PLUG slot								
CP 1604				•									•	•		•												
CP 1616				•									•	•		•												
CP 1623				•								•	•	•		•												
CP 1628				•							•		•	•		•												
CPs for PG/PC/IPC		Software																										
		Security Integrated (Firewall/VPN)	PROFINET diagnosis	Topology support (LLDP)	Command Line Interface / Telnet	Web based Management	Configuration with STEP 7	SNMP	Ring redundancy incl. RM-functionality	Standby redundancy	IRT capability	VLAN (Virtual Local Area Network)	GVRP (Generic VLAN Registration Protocol)	STP/ RSTP (Spanning Tree Protocol/ Rapid Spanning Tree Protocol)	Passive Listening	IGMP Snooping/Querier (Internet Group Management Protocol)	GMRP (Generic Multicast Protocol)	Broadcast/ Multicast/ Unicast Limiter	Broadcast blocking	DHCP Option 82 (Dynamic Host Configuration Protocol)	IP Access List	Access Control List (MAC)	IEEE 802.1x (Radius)	Link Aggregation	Static Routing	RIPv2 (Dynamic Routing)	OSPFv2 (Dynamic Routing)	RRRP, Router Redundancy (Virtual Router Redundancy Protocol)
CP 1604		•	•		• <sup>1)</sup>	•	•	•		•																		
CP 1616			•	•		• <sup>1)</sup>	•	•		•																		
CP 1623						•	•																					
CP 1628		•				•	•																					

• applies

<sup>1)</sup> Port diagnosis possible by means of integrated web server

Function overview of the communication modules with integral switch for SIMATIC PG/PC/IPC

G\_JK10\_XX\_10319

## PROFINET/Industrial Ethernet

### System interfaces for PG/PC/IPC

### Communication for PC-based systems

#### Performance data

#### Overview

The following communications processors are available for connecting to the programming device or PC:

- CPs with an internal microprocessor:
  - CP 1616 (PCI)
  - CP 1604 (PCI-104)
  - CP 1613 A2 (PCI)
  - CP 1623 (PCIe)
  - CP 1628 (PCIe)

#### Data throughput of Industrial Ethernet

Comparisons between Layer-2 Ethernet cards and CP 1613 A2/CP 1623/CP 1628 show the respective communications throughput.

This throughput varies between 0 and the maximum throughput for Layer-2 Ethernet cards with the corresponding software packages.

When the CP 1613 A2/CP 1623/CP 1628 is used with software packages, the communications performance remains constantly at a high level and ensures fast response times without any variations.

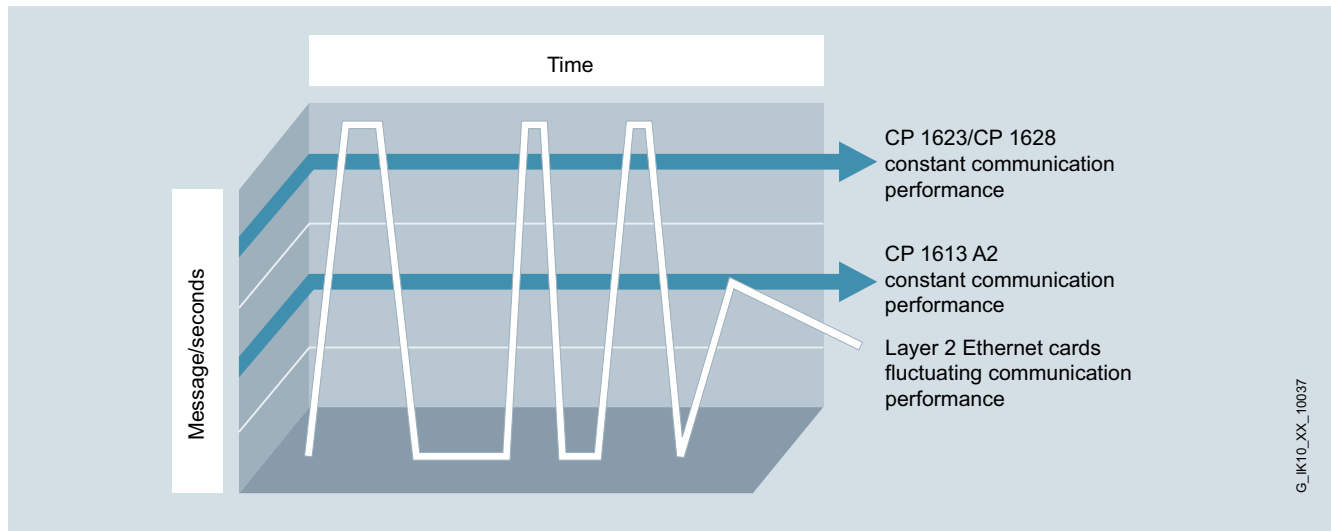

Communication performance comparisons

#### More information

You can find more information on the Internet at:

<http://www.siemens.com/simatic-net/ik-info>

**Overview**

The operating systems listed in the table refer exclusively to the communication products specified! Please refer to the descrip-

tion of the relevant IPC for the operating system that is available and has been released for that IPC.

Communication hardware	Communication software	Operating system environment of the communication software								SIMATIC Industrial PC/ Field PG								Embedded Systems			
		Windows 7 Professional / Ultimate SP1	Windows 8.1 Pro / Enterprise	Windows Server 2008 R2 SP1	Windows Server 2012 R2	Windows Server 2008 + SP1/2	Windows XP Pro + SP3	Windows Server 2003 R2 / SP2	other operating systems	Field PG M4	SIMATIC IPC227D + IPC 277D	SIMATIC IPC427D + IPC 477D	SIMATIC IPC547E	SIMATIC IPC627D	SIMATIC IPC647D	SIMATIC HMI IPC677D	SIMATIC IPC827D	SIMATIC IPC847D	Windows Embedded Standard 2009	Windows Embedded Standard 7 + SP1	SIMATIC IPC427D + 477D + IPC 227D/277D
<b>CPs and software for Industrial Ethernet</b>																					
CP 1613 A2 (PCI 32 Bit)	HARDNET-IE S7	●	●	●	●	●	●	●				●	●	●	●	●	●	●			
	HARDNET-IE S7 REDCONNECT 1)	●	●	●	●	●	●	●				●	4)5) ○	●	4)5) ○	●	●	●			
	S7 OPC Redundancy for Industrial Ethernet			●								●	●	●		●	●				
CP 1623 (PCIe x1)	HARDNET-IE S7	●	●	●	●	●	●	●			○ <sup>5)</sup>	●	○ <sup>5)</sup>	●	○ <sup>5)</sup>	●	●	●	●	●	
	HARDNET-IE S7 REDCONNECT 1)	●	●	●	●	●	●	●			4)5) ○	●	4)5) ○	●	4)5) ○	●	○ <sup>5)</sup>	●	●	4)5) ○	
	S7 OPC Redundancy for Industrial Ethernet			●								●		●		●					
CP 1628 (PCIe x1)	HARDNET-IE S7	●	●	●	●						○ <sup>5)</sup>	●	○ <sup>5)</sup>	●	○ <sup>5)</sup>	●	●	●	●	●	
	HARDNET-IE S7 REDCONNECT 1)	●	●	●	●						4)5) ○	●	4)5) ○	●	4)5) ○	●	○ <sup>5)</sup>	●	●	4)5) ○	
	S7 OPC Redundancy for Industrial Ethernet			●								●		●		●					
CP 1612 A2 (PCI 32 Bit)	SOFTNET-IE S7	●		●		●	●	●				●	●	●	●	●	●	●	●	●	
	SOFTNET-IE S7 Lean	●		●		●	●	●				●	●	●	●	●	●	●	●	●	
	SOFTNET-IE PG	●		●		●	●	●				●	●	●	●	●	●	●	●	●	
	S7 OPC Redundancy for Industrial Ethernet			●								●		●		●					
SIMATIC PG/PC with integral Ethernet interface	SOFTNET-IE S7	●	●	●	●	●	●	●		●	●	●	●	●	●	●	●	●	●	●	●
	SOFTNET-IE S7 Lean	●	●	●	●	●	●	●		●	●	●	●	●	●	●	●	●	●	●	●
	SOFTNET-IE PG	●	●	●	●	●	●	●		●	●	●	●	●	●	●	●	●	●	●	●
	S7 OPC Redundancy for Industrial Ethernet			●								●		●		●					
<b>CPs and software for PROFINET</b>																					
CP 1616 <sup>1)</sup> (PCI 32 Bit)	DK-16xx PNIO	●	●				●		○ <sup>8)</sup>			6)7) ○	○	○ <sup>6)</sup>	○ <sup>6)</sup>	○	○ <sup>6)</sup>	○ <sup>6)</sup>	○		
CP 1604 <sup>1)</sup> (PCI-104)	DK-16xx PNIO	●	●				●		○ <sup>8)</sup>										○		
SIMATIC PG/PC with integral Ethernet interface	SOFTNET PN IO	●	●	●	●	●	●	●		●	●	●	●	●	●	●	●	●	●	●	●
	Support package SIMATIC IPC for VxWorks								●			●		●	●		●				
1) and integrated CP1616-compatible onboard 3-port PROFINET interface																					
2) possible with restrictions, if necessary, depending on memory expansion and processor capacity																					
3) requires at least 2 PCI or 2 PCIe slots for redundant connection (4-way redundancy requires 4 free PCI or 4 PCIe slots); hybrid configurations with CP 1613 A2 (PCI) and CP 1623 (PCIe) are possible, depending on PC expansion																					
4) without 4-way redundancy as there are only 2 slots																					
5) Observe restrictions for some PC versions: Number of slots and tolerable maximum heat loss/power consumption per slot and in total																					
6) integrated CP1616-compatible onboard 3-port PROFINET interface is optional																					
7) only with integrated interface																					
8) Portioning DL-16xx PNIO																					
Notes		<ul style="list-style-type: none"> <li>- Please always note the supplementary conditions for the specified SIMATIC NET products that you can view on the Internet pages shown below.</li> <li>- for further details on XP embedded, see <a href="http://support.automation.siemens.com/WW/view/en/21661049">http://support.automation.siemens.com/WW/view/en/21661049</a></li> <li>- further details on system requirements and operating environments can be found in the Readme file of the communication products on the SIMATIC NET PC Software DVD</li> <li>- Updates and supplements to the catalog entries, as well as the above tables can be viewed at <a href="http://www.siemens.com/simatic-net/ik-info">http://www.siemens.com/simatic-net/ik-info</a></li> </ul>																			
● suitable																					
○ suitable under certain conditions																					
not suitable																					

Connection options of Industrial Ethernet CPs to PG/PC/IPC



## PROFINET/Industrial Ethernet

### Communication for PC-based systems

CP 1604

#### Overview

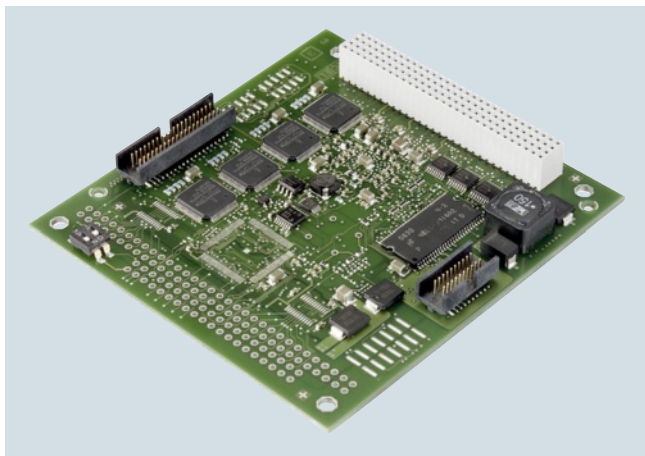

ISO	TCP/UDP	PN	MRP	OPC	PG/OP	S7/S5	IT
	●	●	●				

- PCI-104 module for connecting PCI-104 systems to PROFINET IO
- Full/half duplex with autonegotiation
- With Ethernet real-time ASIC ERTEC 400
- Integral 4-port real-time switch
- Communication services:
  - PROFINET IO controller and/or PROFINET IO device
  - Support of IRT in motion control applications
  - Support of PROFlenergy functionality
- High performance through direct memory access
- Integration in network management systems through the support of SNMP
- Comprehensive diagnostics possibilities for installation, start-up and operation of the module
- Powerful configuration tools are included in delivery of module

#### Benefits

get **Designed for Industry**

- Connection of field devices to Industrial Ethernet with PROFINET
- Ideally suited for design of small local networks through integral 4-port real-time switch
- Direct memory access to process data by linking as PROFINET IO-Controller via IO-Base interface
- High computing power is available in the PC by taking the load off the host CPU by means of a real-time ASIC ERTEC 400 with support of the PROFINET real-time features RT and IRT
- Implementation in Motion Control applications thanks to support of IRT
- Energy savings thanks to support of PROFlenergy
- Simple transfer to various operating system environments using HARDNET-PN IO Development Kit
- Switch mode also with the PC switched off, via optional external power supply (in RT mode only)
- Uncrossed connecting cables can be used due to the integrated Autocrossover function

#### Application

The CP 1604 is used to connect PCI-104 systems to PROFINET IO.

The CP 1604 provides high-performance support for control tasks on the PC (PC based Control, Numeric Control, Robot Control).

With IRT (Isochronous Real-Time), the CP is ideally suited to time-critical applications that are in the range of strictly isochronous closed-loop control in the motion control sector.

The integrated 4-port switch supports low-cost system solutions and the configuration of different topologies.

The CP 1604 offers PCI-104 systems communications facilities with:

- PROFINET IO controller and/or PROFINET IO device

The DK-16xx PN IO development kit enables integration of the module into any operating systems.

2



### Design

- Industrial Ethernet (via "Connection Board for CP 1604")
  - Ethernet real-time ASIC ERTEC 400
  - 4 x RJ45 connection
  - Integral 4-port real-time switch for 10/100 Mbit/s Ethernet
  - Half/full duplex
  - Autosensing/Autocrossover/Autonegotiation
- PCI-104-Plus interface:
  - PCI 2.2
  - 32 bits
  - 33 MHz or 66 MHz
  - Installation through PCI standard mechanisms (Plug & Play)
- Host interface/processor:
  - Dual-port RAM onboard
  - Flash for program memory onboard
  - ARM 946 RISK processor (32-bit) onboard for preprocessing
- Interface for PROFIenergy:
  - Connection option for user-specific interface for switching back on PC
- Power supply:
  - Operating voltage: 5 V through PCI-104
  - Optional external 24 V DC supply for switch operation when PC is switched off (through "Power Supply for CP 1604")
- Size:
  - PCI-104 format

### Function

The CP 1604 can be operated as a PROFINET IO controller and/or PROFINET IO device that stores the process image (input and output data) in the memory area on the CP. With simultaneous controller and device mode, only the controller or the device can be operated in IRT mode. High-performance data transfer to and from the IO devices is performed autonomously by the CP 1604.

#### Real-time

Support of real-time properties of PROFINET for RT and IRT. The real-time properties of the CP 1604 ensure extremely short cycle times with highly accurate clock-pulse rates.

#### Switching

According to the industry requirements, the 4-port real-time switch additionally permits the configuration of line topologies with spur lines and makes external switch components unnecessary.

The switch function in RT mode is also available when the PC is turned off thanks to the possibility of independently supplying an external voltage (via "Power Supply for CP 1604").

#### Energy savings

Thanks to its support of PROFIenergy, CP 1604 allows for the implementation of various energy-saving states during idle times. By connecting an external power supply, the CP 1604 can continue to communicate with the controller as a PROFIenergy device, even while the PC is switched off. By connecting an external hardware circuit, it is then possible to use this to reactivate the PC via PROFIenergy mechanisms.

#### Software packages

##### DK-16xx PN IO development kit;

driver and IO-Base software for CP 1604 as PROFINET IO-Controller and IO-Device under Linux in source code for transfer to any PC-based operating systems with IO-Base interface for:

- PROFINET communication:
  - PROFINET IO controller: Connection of field devices to Industrial Ethernet with PROFINET
  - PROFINET IO device: Link-up with a PROFINET IO controller through real-time communication according to the PROFINET standard
- Access in isochronous mode to real-time data for PROFINET over IRT; extremely short cycle times with highly accurate clock-pulse rates; jitter accuracy, isochronous mode, and cycle time enable high-performance motion control applications.
- Direct memory access to the process data; the process data of the IO-Devices are always consistent. The IO programming interface provides the PC programmer with function calls for data transfer.
- The design of the interface not only permits fast access as a PROFINET IO controller, but also easy transfer to other operating system environments (e.g. VXWorks, QNX, RMOS, RTX).
- The IO-Base interface for the PROFINET IO controller of the CP 1604 is compatible with the interface for SOFTNET PN IO
- The CP 1604 is functionally compatible to the CP 1616

Using the Development Kit DK-16xx PN IO, the CP 1604 communications processor can be integrated into any PC-based operating system environment. The Development Kit contains the driver and IO-Base source code required for this including the transfer instructions and also the example code which executes with SUSE Linux.

## PROFINET/Industrial Ethernet

### Communication for PC-based systems

#### CP 1604

##### User interfaces

##### Programming interface through C library

- For applications that want to use the PROFINET IO-Controller or IO-Device functionality directly over C/C++, the IO-Base interface can be used. This interface is of a similar design to the DP Base interface of PROFIBUS modules CP 5613 and CP 5614. It is therefore possible to port existing PROFIBUS DP master applications to PROFINET IO-Controller applications.

##### Diagnostics data

Extensive diagnostic options are available via STEP 7 or SNMP, including:

- General diagnostics functions
- Connection diagnostics
- Diagnostics of the assigned PROFINET field devices
- Integration in network management systems through the support of SNMP

##### Configuration

Configuration of the CP 1604 is performed with STEP 7/NCM PC, V5.3 SP2 and higher. NCM PC is included with the module.

##### Integration

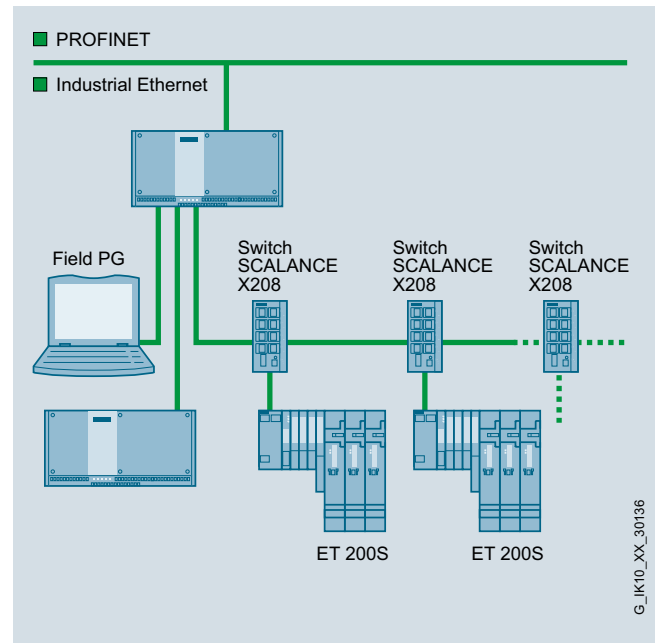

CP 1604 as PROFINET IO-Controller and PROFINET IO-Device

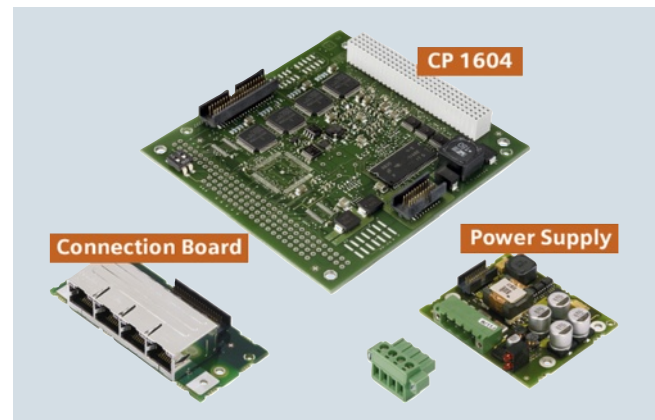

CP 1604 with accessories



CP 1604 Microbox Package

### Technical specifications

Article No.	6GK1160-4AA01
Product-type designation	CP 1604
<b>Transmission rate</b>	
Transfer rate at the interface 1	10 ... 100 Mbit/s
<b>Interfaces</b>	
Number of electrical connections	4
• at interface 1 in accordance with Industrial Ethernet	
• for power supply	1
Design of electrical connection	RJ45 port via connection board
• at interface 1 in accordance with Industrial Ethernet	
• of the backplane bus	PCI-104 (32Bit)
• for power supply	4-pin terminal block via power supply board
<b>Supply voltage, current consumption, power loss</b>	
Type of supply voltage	DC
Type of power supply optional external supply	Yes
Supply voltage	5 V
• 1 from backplane bus	24 V
• external	optional external power supply and external supply voltage alternatively via power supply board (optional accessory)
• note	
Relative symmetrical tolerance	5 %
• at 5 V with DC	20 %
• at 24 V with DC	
Consumed current	0.8 A
• 1 from backplane bus with DC maximum	
• from external supply voltage at 24 V with DC maximum	0.3 A
Resistive loss	4 W
• in switch mode maximum	4.1 W
<b>Permitted ambient conditions</b>	
Ambient temperature	5 ... 60 °C
• during operating	
• during storage	-20 ... +60 °C
• during transport	-20 ... +60 °C
Relative humidity at 25 °C without condensation during operating maximum	95 %
Protection class IP	IP00
<b>Design, dimensions and weight</b>	
Module format	PC/104-Plus
Width	90 mm
Height	24 mm
Depth	95 mm
Net weight	110 g
<b>Product properties, functions, components general</b>	
Number of plug-in cards in the same design can be plugged in per PC station	1

Article No.	6GK1160-4AA01
Product-type designation	CP 1604
<b>Performance data</b>	
<u>Performance data PROFINET communication as PN IO-Controller</u>	
Software for PROFINET IO communication required	No
Number of PN IO-Devices on PROFINET IO-Controller usable total	128
Number of PN IO IRT-Devices on PROFINET IO-Controller usable	64
Data volume	
• as useful data for input variables as PROFINET IO controller maximum	8 192 byte
• as useful data for output variables with PROFINET IO controller maximum	8 192 byte
• as useful data for input variables per PN IO device with PROFINET IO controller maximum	1 433 byte
• as useful data for output variables per PN IO device with PROFINET IO controller maximum	1 433 byte
<u>Performance data PROFINET communication as PN IO-Device</u>	
Amount of data	
• as useful data for input variables as PROFINET IO device maximum	1 433 byte
• as useful data for input variables as PROFINET IO device maximum	1 433 byte
• as useful data for input variables for each sub-module under PROFINET IO device	254 byte
• as useful data for input variables for each sub-module under PROFINET IO device	254 byte
• as useful data for the consistency area for each sub-module	254 byte
Number of submodules per PROFINET IO-Device	64
<b>Product functions management, configuration</b>	
Product function MIB support	Yes
Protocol is supported	
• SNMP v1	Yes
• DCP	Yes
• LLDP	Yes
Configuration software required	included in scope of delivery
Identification & maintenance function	
• I&M0 - device-specific information	Yes
• I&M1 - higher level designation/location designation	Yes
• I&M2 - installation date	Yes
• I&M3 - comment	Yes
• I&M4 - signature	Yes

## PROFINET/Industrial Ethernet

### Communication for PC-based systems

#### CP 1604

#### Technical specifications (continued)

<b>Article No.</b>	<b>6GK1160-4AA01</b>
<b>Product-type designation</b>	<b>CP 1604</b>
<b>Product functions Diagnosis</b>	
Product function	
• Web-based diagnostics	Yes
• Port diagnostics	Yes
<b>Product functions switch</b>	
Product feature switch	Yes
Product function	
• switch-managed	No
• for IRT PROFINET IO switch	Yes
<b>Product functions Redundancy</b>	
Product function	
• Ring redundancy	Yes
• Redundancy manager	Yes
• Media Redundancy Protocol (MRP)	Yes

<b>Article No.</b>	<b>6GK1160-4AA01</b>
<b>Product-type designation</b>	<b>CP 1604</b>
<b>Standards, specifications, approvals</b>	
Standard	
• for EMC	2004/108/EC
• for safety of CSA and UL	CAN/CSA C22.2 & UL 60950-1
• for emitted interference	EN 61000-6-3, EN 61000-6-4
• for interference immunity	EN 61000-6-1, EN 61000-6-2
Verification of suitability	
• CE mark	Yes
• C-Tick	Yes
<b>Accessories</b>	
Accessories	optional: Connection board for CP 1604, power supply board for CP 1604, HARDNET-IE DK (development kit)

#### Ordering data

Article No.	Article No.
<b>CP 1604 communications processor</b>	<b>6GK1160-4AA01</b>
PCI-104 card (32-bit) with ASIC ERTEC 400 for connecting PCI-104 systems to PROFINET IO with 4-port real-time switch (RJ45); incl. IO-Base software for PROFINET IO-Controller and NCM PC; single license for one installation, runtime software, software and electronic manual on CD-ROM, Class A, for 32-bit Windows XP Professional and Windows 7; other operating systems using DK-16xx PN IO Development Kit German/English	
<b>CP 1604 Microbox Package</b>	<b>6GK1160-4AU01</b>
Package for implementing the CP 1604 in the SIMATIC Microbox PC; comprising the CP 1604, connection board, power supply and expansion racks for Microbox PC; for use with Development Kit DK-16xx PN IO; NCM PC	
<b>Accessories</b>	
<b>Connection board for CP 1604</b>	<b>6GK1160-4AC00</b>
Connection board for CP 1604 with four RJ45 sockets incl. connecting cable	
<b>Power supply for CP 1604</b>	<b>6GK1160-4AP00</b>
Redundant power supply for CP 1604 for operating the integral 4-port switch of the CP 1604 with the PC-104 system switched off; includes connecting cable	

#### Article No.

#### Accessories (continued)

<b>Development Kit DK-16xx PN IO</b>	see <a href="http://www.siemens.com/simatic-net/dk16xx">http://www.siemens.com/simatic-net/dk16xx</a>
Software Development Kit for CP 1616/CP 1604; driver and IO-Base software for CP 1616/CP 1604 as PN IO controller and PN IO device in source code for transfer to other PC-based operating systems; incl. executable sample code for SUSE Linux 10, Windows XP Professional and Windows 7	
<b>IE TP Cord RJ45/RJ45</b>	
TP cable 4 x 2 with 2 RJ45 connectors	
• 0.5 m	<b>6XV1870-3QE50</b>
• 1 m	<b>6XV1870-3QH10</b>
• 2 m	<b>6XV1870-3QH20</b>
• 6 m	<b>6XV1870-3QH60</b>
• 10 m	<b>6XV1870-3QN10</b>
<b>SCALANCE X204IRT</b>	<b>6GK5204-0BA00-2BA3</b>
Managed Industrial Ethernet switches; isochronous real time, LED diagnostics, error signaling contact with SET button, redundant power supply; 4 x 10/100 Mbit/s RJ45 ports	

#### Note:

For software ordering data, see page 2/636

#### More information

The DK-16xx PN IO development kit can be found on the Internet at:  
<http://www.siemens.com/simatic-net/dk16xx>

### Overview

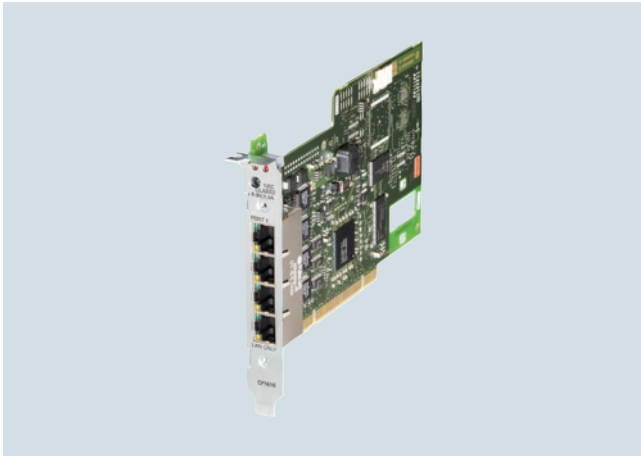

ISO	TCP/UDP	PN	MRP	OPC	PG/OP	S7/S5	IT
	●	●	●				

- PCI module for connecting PCs and SIMATIC PGs/PCs to PROFINET IO (Universal Keyed 3.3 V and 5 V; 33 MHz/66 MHz; 32-bit, runs in 64-bit PCI-X systems)
- Full/half duplex with autonegotiation
- With Ethernet real-time ASIC ERTEC 400
- Integral 4-port real-time switch
- Communication services:
  - PROFINET IO controller and/or PROFINET IO device
  - Support of IRT in motion control applications
- High performance through direct memory access
- Integration in network management systems through the support of SNMP
- Comprehensive diagnostics possibilities for installation, start-up and operation of the module
- Powerful configuration tools are part of the scope of delivery of the module

### Benefits



- Connection of field devices to Industrial Ethernet with PROFINET
- Ideally suited for design of small local networks through integral 4-port real-time switch
- Direct memory access to process data by linking as PROFINET IO-Controller via IO-Base interface
- High computing power is available in the PC by taking the load off the host CPU by means of a real-time ASIC ERTEC 400 with support of the PROFINET real-time features RT and IRT
- Implementation in Motion Control applications thanks to support of IRT
- Energy savings thanks to support of PROFlenergy
- Simple transfer to various operating system environments using Development Kit DK-16xx PN IO
- Switch mode also with the PC switched off, via optional external power supply (in RT mode only)
- Uncrossed connecting cables can be used due to the integrated autocrossover function

### Application

The CP 1616 enables SIMATIC PGs/PCs and PCs equipped with a PCI slot to be connected to PROFINET IO.

The CP 1616 provides high-performance support for control tasks on the PC (PC-based control, numeric control, robot control).

With IRT (isochronous real-time), the CP is ideally suited to time-critical applications that are in the range of isochronous closed-loop control in the motion control sector.

The integrated 4-port switch supports low-cost system solutions and the configuration of different topologies.

The CP 1616 provides SIMATIC programming devices/PCs and industrial PCs with communication functions as:

- PROFINET IO controller and/or PROFINET IO device

The HARDNET-PN IO Development Kit enables integration of the module into any operating systems.

### Design

- Industrial Ethernet
  - Ethernet real-time ASIC ERTEC 400
  - 4 x RJ45 connection
  - Integral 4-port real-time switch for 10/100 Mbit/s Ethernet
  - Half/full duplex
  - Autosensing/Autonegotiation/Autonegotiation
- PCI interface:
  - PCI 2.2
  - 32-bit, for execution in 64-bit PCI X systems
  - 33 MHz or 66 MHz
  - Universal Keyed 3.3 V and 5 V
  - Installation through PCI standard mechanisms (Plug & Play)
- Host interface/processor:
  - Dual-port RAM on board
  - Flash for program memory onboard
  - ARM 946 RISK processor (32-bit) onboard for preprocessing
- Power supply:
  - Operating voltage: 5 V through PCI
  - Optional external 6 to 9 V DC supply for switch operation with PC switched off
- Size:
  - Short PCI format

## PROFINET/Industrial Ethernet

### Communication for PC-based systems

#### CP 1616

#### Function

The CP 1616 can be operated as a PROFINET IO controller and/or PROFINET IO device that stores the process image (input and output data) in the memory area on the CP. With simultaneous controller and device mode, only the controller or the device can be operated in IRT mode. High-performance data transfer to and from the IO devices is performed autonomously by the CP 1616.

#### Real-time

Support of real-time properties of PROFINET for RT and IRT. The real-time properties of the CP 1616 ensure extremely short cycle times with highly accurate clock-pulse rates.

#### Switching

According to the industry requirements, the 4-port real-time switch additionally permits the configuration of line topologies with spur lines and makes external switch components unnecessary.

The switch function is also available in RT mode when the PC is turned off thanks to the possibility of independently supplying an external voltage.

#### Energy savings

Thanks to support from PROFenergy, it is possible to implement various energy-saving states during idle times on the CP 1616.

#### Software packages

##### DK-16xx PN IO development kit;

driver and IO-Base software for CP 1616 as PROFINET IO-Controller and IO-Device under Linux in source code for transfer to any PC-based operating systems with IO-Base interface for:

- PROFINET communication:
  - PROFINET IO controller: Connection of field devices to Industrial Ethernet with PROFINET
  - PROFINET IO device: Link-up with a PROFINET IO controller through real-time communication according to the PROFINET standard
- Access in isochronous mode to real-time data for PROFINET over IRT; extremely short cycle times with highly accurate clock-pulse rates; jitter accuracy, isochronous mode, and cycle time enable high-performance motion control applications.
- Direct memory access to the process data; the process data of the IO-Devices are always consistent. The IO programming interface provides the PC programmer with function calls for data transfer.
- The design of the interface not only permits fast access as a PROFINET IO controller, but also easy transfer to other operating system environments (e.g. VXWorks, QNX, RMOs, RTX).
- The IO-Base interface for the PROFINET IO controller of the CP 1616 is compatible with the interface for SOFTNET PN IO
- The CP 1616 is functionally compatible with the CP 1604

Using the Development Kit DK-16xx PN IO, the CP 1616 communications processor can be integrated into any PC-based operating system environment. The Development Kit contains the driver and IO-Base source code required for this including the transfer instructions and also the example code which executes with SUSE Linux.

#### User interfaces

##### Programming interface through C library

For applications that want to use the PROFINET IO-Controller or IO-Device functionality directly over C/C++, the IO-Base interface can be used. This interface is of a similar design to the DP Base interface of PROFIBUS modules CP 5613 and CP 5614. It is therefore possible to port existing PROFIBUS DP master applications to PROFINET IO-Controller applications.

##### Diagnostics

Extensive diagnostic options are available via STEP 7 or SNMP, including:

- General diagnostics functions
- Connection diagnostics
- Diagnostics of the assigned PROFINET field devices
- Integration in network management systems through the support of SNMP

##### Configuration

Configuration of the CP 1616 is performed with STEP 7/NCM PC, V5.3 SP2 and higher. NCM PC is included with the module.

#### Integration

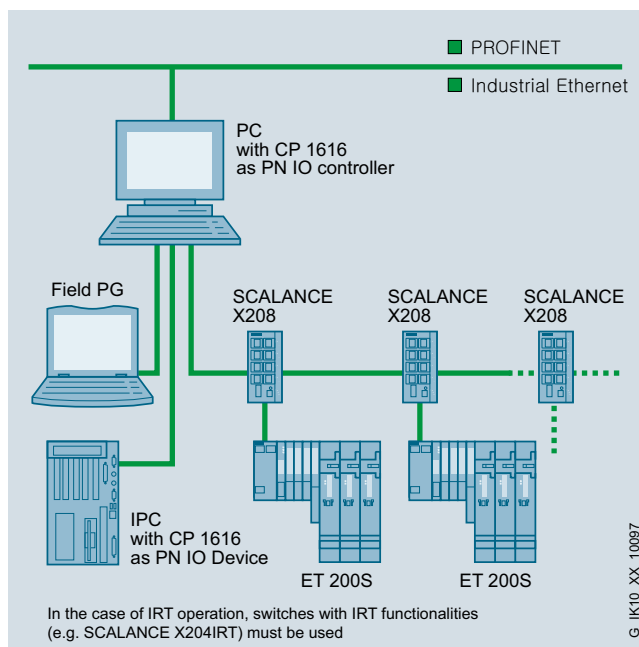

CP 1616 as PROFINET IO-Controller and PROFINET IO-Device

### Technical specifications

Article No.	6GK1161-6AA02
Product-type designation	CP 1616
<b>Transmission rate</b>	
Transfer rate at the interface 1	10 ... 100 Mbit/s
<b>Interfaces</b>	
Number of electrical connections	4
• at interface 1 in accordance with Industrial Ethernet	
• for power supply	1
Design of electrical connection	
• at interface 1 in accordance with Industrial Ethernet	RJ45 port
• of the backplane bus	PCI (32 Bit 3,3 V/5 V UniversalKey 33/66 MHz)
• for power supply	Low-voltage socket for hollow plug 3.5 mm (-) / 1.3 mm (+)
<b>Supply voltage, current consumption, power loss</b>	
Type of supply voltage	DC
Type of power supply optional external supply	Yes
Supply voltage	
• 1 from backplane bus	5 V
• external	6 ... 9 V
Relative symmetrical tolerance at 5 V with DC	5 %
Consumed current	
• 1 from backplane bus with DC maximum	0.8 A
• from external supply voltage	
- at 9 V with DC max.	0.65 A
- at 9 V with DC max.	0.45 A
Resistive loss	4 W
• in switch mode maximum	4.1 W
<b>Permitted ambient conditions</b>	
Ambient temperature	
• during operating	5 ... 70 °C
• during storage	-40 ... +70 °C
• during transport	-20 ... +60 °C
Relative humidity at 25 °C without condensation during operating maximum	95 %
Protection class IP	IP00
<b>Design, dimensions and weight</b>	
Module format	PCI
Width	18 mm
Height	107 mm
Depth	167 mm
Net weight	110 g
<b>Product properties, functions, components general</b>	
Number of plug-in cards in the same design can be plugged in per PC station	1

Article No.	6GK1161-6AA02
Product-type designation	CP 1616
<b>Performance data</b>	
<u>Performance data PROFINET communication as PN IO-Controller</u>	
Software for PROFINET IO communication required	No
Number of PN IO-Devices on PROFINET IO-Controller usable total	128
Number of PN IO IRT-Devices on PROFINET IO-Controller usable	64
Data volume	
• as useful data for input variables as PROFINET IO controller maximum	8 192 byte
• as useful data for output variables with PROFINET IO controller maximum	8 192 byte
• as useful data for input variables per PN IO device with PROFINET IO controller maximum	1 433 byte
• as useful data for output variables per PN IO device with PROFINET IO controller maximum	1 433 byte
<u>Performance data PROFINET communication as PN IO-Device</u>	
Amount of data	
• as useful data for input variables as PROFINET IO device maximum	1 433 byte
• as useful data for input variables as PROFINET IO device maximum	1 433 byte
• as useful data for input variables for each sub-module under PROFINET IO device	254 byte
• as useful data for input variables for each sub-module under PROFINET IO device	254 byte
• as useful data for the consistency area for each sub-module	254 byte
Number of submodules per PROFINET IO-Device	64
<b>Product functions management, configuration</b>	
Product function MIB support	Yes
Protocol is supported	
• SNMP v1	Yes
• DCP	Yes
• LLDP	Yes
Configuration software required	included in scope of delivery
Identification & maintenance function	
• I&M0 - device-specific information	Yes
• I&M1 - higher level designation/location designation	Yes
• I&M2 - installation date	Yes
• I&M3 - comment	Yes
• I&M4 - signature	Yes

# PROFINET/Industrial Ethernet

## Communication for PC-based systems

### CP 1616

#### Technical specifications (continued)

Article No.	6GK1161-6AA02	Article No.	6GK1161-6AA02
<b>Product-type designation</b>	<b>CP 1616</b>	<b>Product-type designation</b>	<b>CP 1616</b>
<b>Product functions Diagnosis</b>		<b>Standards, specifications, approvals</b>	
Product function		Standard	
• Web-based diagnostics	Yes	• for EMC	89/336/EEC
• Port diagnostics	Yes	• for safety of CSA and UL	CAN/CSA C22.2 & UL 60950-1
<b>Product functions switch</b>		• for emitted interference	EN 61000-6-3, EN 61000-6-4
Product feature switch	Yes	• for interference immunity	EN 61000-6-1, EN 61000-6-2
Product function switch-managed	No	Verification of suitability	
Product function for IRT PROFINET IO switch	Yes	• CE mark	Yes
<b>Product functions Redundancy</b>		• C-Tick	Yes
Product function			
• Ring redundancy	Yes		
• Redundancy manager	Yes		
• Media Redundancy Protocol (MRP)	Yes		

#### Ordering data

Article No.	Article No.	Article No.
<b>CP 1616 communications processor</b>	<b>6GK1161-6AA02</b>	<b>Accessories</b>
PCI Card (32 bit; 3,3/5 V universal keyed) with ASIC ERTEC 400 for connecting PCs to PROFINET IO with 4-port real-time switch (RJ45); incl. IO Base software for PROFINET IO Controller and NCM PC; single license for one installation, runtime software, software and electronic manual on CD-ROM, Class A, for 32-bit Windows XP Professional and Windows 7; other operating systems via Development Kit DK-16xx PN IO; German/English		<b>Development Kit DK-16xx PN IO</b>
		see <a href="http://www.siemens.com/simatic-net/dk16xx">http://www.siemens.com/simatic-net/dk16xx</a>
		Software development kit for CP 1616/CP 1604; driver and IO-Base software for CP 1616/CP 1604 as PN IO controller and IO device in source code for transfer to other PC-based operating systems; including executable example code for SUSE Linux 10, Windows XP Professional and Windows 7
		<b>IE TP Cord RJ45/RJ45</b>
		TP cable 4 x 2 with 2 RJ45 connectors
		• 0.5 m
		• 1 m
		• 2 m
		• 6 m
		• 10 m
		<b>6XV1870-3QE50</b>
		<b>6XV1870-3QH10</b>
		<b>6XV1870-3QH20</b>
		<b>6XV1870-3QH60</b>
		<b>6XV1870-3QN10</b>
		<b>SCALANCE X204IRT</b>
		<b>6GK5204-0BA00-2BA3</b>
		Managed Industrial Ethernet switches; isochronous real time, LED diagnostics, error signaling contact with SET button, redundant power supply; 4 x 10/100 Mbit/s RJ45 ports

#### Note:

For software ordering data, see page 2/636

#### More information

The DK-16xx PN IO development kit can be found on the Internet at:  
<http://www.siemens.com/simatic-net/dk16xx>



### Overview

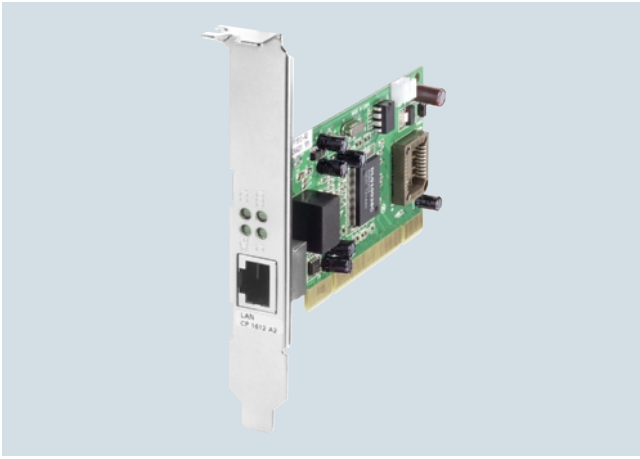

ISO	TCP/UDP	PN	MRP	OPC	PG/OP	S7/S5	IT
●	●	●		●	●	●	●

- PCI card (32 bit; 33 MHz/66 MHz; 3.3 V/5 V Universal Key) for the connection of PG/PC to Industrial Ethernet
- 1 x 10/100/1 000 Mbit/s RJ45 port, electrical
- Automatic data transmission rate detection (10/100/1 000 Mbit/s), with autosensing and autocrossover function
- Communication services via
  - PROFINET
  - ISO or TCP/IP transport protocol
  - PG/OP communication
  - S7 communication
  - Open communication (SEND/RECEIVE)
- Designed for use in industrial environments
- The appropriate OPC servers and configuration tools are included in the scope of supply of the respective communication software.

### Benefits

**get** Designed for Industry

- Low commissioning overhead due to plug & play and autosensing/autocrossover/autonegotiation (10/100/1 000 Mbit/s)
- Particularly suitable for industrial use in PCs that require a smaller quantity structure and no integrated switching functionality
- Ideally suited to SOFTNET for Industrial Ethernet and SOFTNET PN IO
- Simple access to automation data via OPC as standard interface
- Uniform procedure and configuration functionality with NCM PC and STEP 7

### Application

The CP 1612 A2 supports the connection to Industrial Ethernet (10/100/1 000 Mbit/s) for SIMATIC PG/PC and PCs with a PCI slot. It is designed for use in an industrial environment and can be operated with all SOFTNET for Industrial Ethernet and SOFTNET PN IO packages.

### Design

The CP 1612 A2 module (PCI card 32-bit; 33 MHz/66 MHz; 3.3 V/5 V Universal Key) is inserted directly into a SIMATIC PG/PC or in a PC and requires a PCI slot.

- 1 x RJ45 connection with 10/100/1 000 Mbit/s (half/full duplex)
- Installation through PCI standard mechanisms (Plug & Play)

### Function

The CP 1612 A2 offers the following accesses:

- Level 2: interface for PC networks in the industrial environment
- Level 4 and Level 7: economical access to Industrial Ethernet, e.g. to SIMATIC S5/S7 in connection with SOFTNET packages for Industrial Ethernet.

In addition, the protocols for Industrial Ethernet provided by the operating system are supported.

The IT functionality is provided in combination with the Windows software of the PC.

### User interfaces

#### OPC interface

The OPC server included in the respective software package can be used as the standard programming interface for the protocols S7 communication and open communication, in order to connect automation technology applications to OPC-compatible Windows applications (Office, HMI systems, etc.)

#### Diagnostics

- Integration into network management systems through the support of SNMP

#### Configuration

- The S7 communication and open communication protocols are configured in STEP 7 V5.1 SP3 or higher or NCM PC V5.1 SP2 or higher.
- A configuration tool is included in the scope of delivery of the CP 1612 A2 software packages.

# PROFINET/Industrial Ethernet

## Communication for PC-based systems

### CP 1612 A2

#### Technical specifications

Article No.	6GK1161-2AA01
Product-type designation	CP 1612 A2
<b>Transmission rate</b>	
Transfer rate at the interface 1	10 ... 1 000 Mbit/s
<b>Interfaces</b>	
Number of electrical connections at interface 1 in accordance with Industrial Ethernet	1
Design of electrical connection	
• at interface 1 in accordance with Industrial Ethernet	RJ45 port
• of the backplane bus	PCI (32 Bit 3.3 V/5 V UniversalKey 33/66 MHz)
<b>Supply voltage, current consumption, power loss</b>	
Type of supply voltage	DC
Supply voltage	
• 1 from backplane bus	5 V
• 2 from the backplane bus	12 V
Relative symmetrical tolerance	
• at 5 V with DC	5 %
• at 12 V with DC	5 %
Consumed current	
• 1 from backplane bus with DC maximum	0.45 A
• 2 from backplane bus with DC maximum	0.5 A
Resistive loss	3.65 W
<b>Permitted ambient conditions</b>	
Ambient temperature	
• during operating	0 ... 55 °C
• during storage	-10 ... +70 °C
• during transport	-10 ... +70 °C
Relative humidity at 25 °C without condensation during operating maximum	95 %
Protection class IP	IP00
<b>Design, dimensions and weight</b>	
Module format	PCI
Width	18 mm
Height	59 mm
Depth	140 mm
Net weight	60 g
<b>Product properties, functions, components general</b>	
Number of plug-in cards in the same design can be plugged in per PC station	2

Article No.	6GK1161-2AA01
Product-type designation	CP 1612 A2
<b>Performance data</b>	
<u>Performance data open communication</u>	
Software for open communication by means of SEND/RECEIVE required	Yes, SOFTNET-IE S7 (64 conn.) / SOFTNET-IE S7 Lean (8 conn.)
Number of possible connections for open communication by means of SEND/RECEIVE maximum	64
<u>Performance data S7 communication</u>	
Software for S7 communication required	Yes, SOFTNET-IE S7 (64 conn.) / SOFTNET-IE S7 Lean (8 conn.)
Number of possible connections for S7/PG communication maximum	64
<u>Performance data multi-protocol mode</u>	
Number of active connections with multiprotocol mode	64
Number of configurable connections per PC station	207
<u>Performance data PROFINET communication as PN IO-Controller</u>	
Software for PROFINET IO communication required	Yes, SOFTNET-IE PN IO
Number of PN IO-Devices on PROFINET IO-Controller usable total	64
Number of PN IO IRT-Devices on PROFINET IO-Controller usable	0
Data volume	
• as useful data for input variables as PROFINET IO controller maximum	4 096 byte
• as useful data for output variables with PROFINET IO controller maximum	4 096 byte
• as useful data for input variables per PN IO device with PROFINET IO controller maximum	1 472 byte
• as useful data for output variables per PN IO device with PROFINET IO controller maximum	1 472 byte
<u>Performance data PROFINET CBA</u>	
Software for PROFINET CBA communication required	Yes, PN CBA OPC server
Number of remote connection partners with PROFINET CBA	228
Number of connections with PROFINET CBA total	10 000

### Technical specifications (continued)

<b>Article No.</b>	<b>6GK1161-2AA01</b>
<b>Product-type designation</b>	<b>CP 1612 A2</b>
<b>Product functions management, configuration</b>	
Product function MIB support	No
Protocol is supported	
• SNMP v1	Yes
• SNMP v3	No
• DCP	Yes
Configuration software	
• required	
• for PROFINET CBA required	Yes, SIMATIC iMAP
<b>Standards, specifications, approvals</b>	
Standard	
• for EMC	2004/108/EC
• for safety of CSA and UL	CAN/CSA C22.2 & UL 60950-1, UL 1950
• for emitted interference	EN 61000-6-3, EN 61000-6-4
• for interference immunity	EN 61000-6-1, EN 61000-6-2
Verification of suitability	
• CE mark	Yes
• C-Tick	Yes

### Ordering data

**CP 1612 A2 communications processor**

PCI card (32 bit, 33 MHz/66 MHz; 3.3 V/5 V universal keyed) for connection to Industrial Ethernet (10/100/1 000 Mbit/s) with RJ45 interface, incl. driver for 32-bit Windows XP Professional SP2/3, 32/64-bit Windows 7, 2003 R2 Server SP2, Vista Business/Ultimate SP1, Windows 2008 Server; German/English

#### Accessories

#### IE TP Cord RJ45/RJ45

TP cable 4 x 2 with 2 RJ45 connectors

- 0.5 m
- 1 m
- 2 m
- 6 m
- 10 m

### Article No.

**6GK1161-2AA01**

**6XV1870-3QE50**  
**6XV1870-3QH10**  
**6XV1870-3QH20**  
**6XV1870-3QH60**  
**6XV1870-3QN10**

#### Note:

For software ordering data, see page 2/636

## PROFINET/Industrial Ethernet

### Communication for PC-based systems

#### CP 1613 A2

#### Overview



ISO	TCP/UDP	PN	MRP	OPC	PG/OP	S7/S5	IT
●	●			●	●	●	●

- PCI card (32 bit; 33 MHz/66 MHz; 3.3 V/5 V universal key) with microprocessor for connection of PG/PC to Industrial Ethernet with 10/100 Mbit/s Autosensing/Autonegotiation
- Communication services using
  - Open IE communication via TCP/IP and UDP
  - ISO transport protocol
  - PG/OP communication
  - S7 communication
  - Open communication (SEND/RECEIVE)
- 15-pole ITP connection
- RJ45 connection
- Time synchronization
- ISO and TCP/IP transport protocol onboard
- SNMP-supported diagnostics
- The appropriate OPC server and configuration tools are included in the respective scope of supply of the communication software

#### Benefits



- Constant data throughput through protocol processing on the CP
- Can be connected to many devices through ITP or RJ45 connections on the module
- Free computing capacity for other applications on the PC e.g. HMI (ISO and TCP/IP transport onboard)
- Simple handling through Plug&Play and Autosensing (10/100 Mbit/s)
- Operation of large network configurations with a single card through high number of connections
- Can be used for redundant communication
- OPC as standard interface

#### Application

The CP 1613 A2 is used to connect SIMATIC PGs/PCs and PCs with a PCI slot to Industrial Ethernet (10/100 Mbit/s).

#### Design

The module CP 1613 A2 (PCI card with 32-bit microprocessor; 33 MHz/66 MHz; 3.3 V/5 V Universal Key) is inserted directly into a SIMATIC PG/PC or into a PC and requires a short PCI slot. It is capable of running in 64-bit PCI-X slots (PCI 2.2 and PCI-X-compatible).

Ports:

- 15-pin Sub-D socket for ITP
- RJ45 jack for twisted pair
- Automatic recognition and selection of the interface during booting (ITP or RJ45)

The module is connected, for example,

- in the case of ITP via the ITP standard cable 9/15 to OSM/ESM
- in the case of TP via TP cord up to 10 m or via FastConnect system up to 100 m (IE FC RJ45 Plug and FC cables) to SCALANCE X or SCALANCE S

## Function

### User interfaces

#### OPC interface

The OPC server included in the respective software package can be used as the standard programming interface for the protocols S7 communication and open communication, in order to connect automation technology applications to OPC-compatible Windows applications (Office, HMI systems, etc.)

#### Programming interface through C library

The programming interfaces for the S7 communication, PG/OP communication, and open communication protocols for existing applications are implemented as Dynamic Link Library (DLL) interfaces.

You can find the released compilers in the Readme file of the SIMATIC NET CD products at <http://www.siemens.com/automation/csi/net>.

#### Software for PG/OP communication

This software makes it possible to program the S7 controllers via Industrial Ethernet in conjunction with the STEP 7 engineering software.

It is included in all CP 1613 A2 software packages.

#### Software for S7 communication (HARDNET-IE S7 or S7-REDCONNECT)

The S7 interface allows PG/PC applications (e.g. WinCC) and user programs to access the SIMATIC S7 system components. This provides easy, flexible access to the data of the SIMATIC S7 controller.

S7 communication offers:

#### Administrative services

- Connection management
- Mini database
- Trace

#### Data transfer services

- Read/write variables
- BSEND/BRECEIVE

#### H-communication

For redundant S7 communication with a high availability S7-400H system, the CP 1613/CP 1623/CP 1628 can be used in connection with the S7-REDCONNECT software.

#### Software for open communication (SEND/RECEIVE)

This interface is used for communication between

- PG/PC and SIMATIC S5
- PG/PC and SIMATIC S7
- PG/PC and PG/PC

Open communication (SEND/RECEIVE) offers the following services:

- Management services
- Connection establishment services
- Data transfer services

These functionalities are a component part of the HARDNET-IE S7 software product.

#### Mode of operation

Protocols up to Level 4 (Transport) are processed autonomously on the module.

16 MB of memory is available for this to support a large quantitative framework and reliable communication.

Data is exchanged between the module and the host in master mode. This means that the CP 1613 A2 accesses the physical RAM of the host.

A Windows driver is responsible for transferring data between the host system and the CP 1613 A2. The transmission rate to Industrial Ethernet is detected and automatically switched over (autosensing).

The IT functionality is provided in combination with the Windows software of the PC.

#### Diagnostics

Via SNMP all MIB-2 objects can be read out. This enables the current status of the Ethernet interfaces to be retrieved.

#### Configuration

- The S7 communication and open communication protocols are configured in STEP 7 or NCM PC.
- A configuration tool is included in the scope of delivery of the CP 1613 A2 software packages.

# PROFINET/Industrial Ethernet

## Communication for PC-based systems

### CP 1613 A2

#### Integration

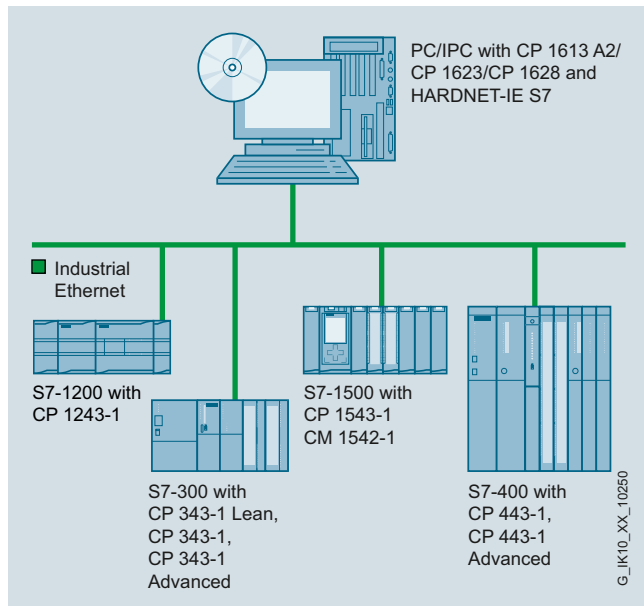

System configuration with CP 1613 A2/CP 1623/CP 1628 and HARDNET-IE S7

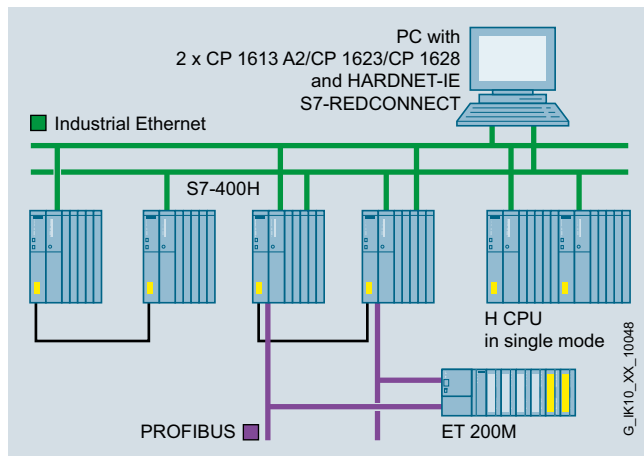

Example of redundant network structure with CP 1613 A2/CP 1623/CP 1628 and HARDNET-IE S7-REDCONNECT

#### Technical specifications

<b>Article No.</b>	<b>6GK1161-3AA01</b>
<b>Product-type designation</b>	<b>CP 1613 A2</b>
<b>Transmission rate</b>	
Transfer rate at the interface 1	10 ... 100 Mbit/s
<b>Interfaces</b>	
Number of electrical connections at interface 1 in accordance with Industrial Ethernet	2
Design of electrical connection	
• at interface 1 in accordance with Industrial Ethernet	RJ45 port / 15-pin ITP connection
• of the backplane bus	PCI (32 Bit 3.3 V/5 V UniversalKey 33/66 MHz)
<b>Supply voltage, current consumption, power loss</b>	
Type of supply voltage	DC
Supply voltage	
• 1 from backplane bus	5 V
• 2 from the backplane bus	12 V
Relative symmetrical tolerance	
• at 5 V with DC	5 %
• at 12 V with DC	5 %
Consumed current	
• 1 from backplane bus with DC maximum	0.45 A
• 2 from backplane bus with DC maximum	0.5 A
Resistive loss	4 W
<b>Permitted ambient conditions</b>	
Ambient temperature	
• during operating	5 ... 55 °C
• during storage	-20 ... +60 °C
• during transport	-20 ... +60 °C
Relative humidity at 25 °C without condensation during operating maximum	95 %
Protection class IP	IP00
<b>Design, dimensions and weight</b>	
Module format	PCI
Width	21.6 mm
Height	107 mm
Depth	167 mm
Net weight	140 g
<b>Product properties, functions, components general</b>	
Number of plug-in cards in the same design can be plugged in per PC station	4

### Technical specifications (continued)

Article No.	6GK1161-3AA01
Product-type designation	CP 1613 A2
<b>Performance data</b>	
<u>Performance data open communication</u>	
Software for open communication by means of SEND/RECEIVE required	Yes, HARDNET-IE S7 (S7-1613)
Number of possible connections for open communication by means of SEND/RECEIVE maximum	120
<u>Performance data S7 communication</u>	
Software for S7 communication required	Yes, HARDNET-IE S7 (S7-1613)
Number of possible connections	120
• for S7/PG communication maximum	
• for optimized S7 communication maximum	40
<u>Performance data multi-protocol mode</u>	
Number of active connections with multiprotocol mode	120
Number of configurable connections per PC station	207
<u>Performance data PROFINET CBA</u>	
Software for PROFINET CBA communication required	Yes, PN CBA OPC server
Number of remote connection partners with PROFINET CBA	228
Number of connections with PROFINET CBA total	10 000
<b>Product functions management, configuration</b>	
Product function MIB support	Yes
Protocol is supported	
• SNMP v1	Yes
• SNMP v3	No
• DCP	Yes
Configuration software	
• required	included in scope of delivery of the required software
• for PROFINET CBA required	Yes, SIMATIC iMAP
Identification & maintenance function	
• I&M0 - device-specific information	Yes
• I&M1 - higher level designation/location designation	Yes
<b>Product functions Redundancy</b>	
Software for redundancy function required	Yes, HARDNET-IE S7-REDCONNECT for communication with SIMATIC S7 H systems
<b>Product functions Time</b>	
Product function SICLOCK support	Yes
Protocol is supported NTP	No
<b>Standards, specifications, approvals</b>	
Standard	
• for EMC	2004/108/EC
• for safety of CSA and UL	CAN/CSA C22.2 & UL 60950-1, UL 1950
• for emitted interference	EN 61000-6-3, EN 61000-6-4
• for interference immunity	EN 61000-6-1, EN 61000-6-2
Verification of suitability	
• CE mark	Yes
• C-Tick	Yes

### Ordering data

### Article No.

#### CP 1613 A2 communications processor

PCI card (32-bit, 33 MHz/66 MHz; 3.3 V/5 V universal keyed) for connection to Industrial Ethernet (10/100 Mbit/s) with ITP and RJ45 connection over HARDNET-IE S7/S7-1613 and S7-REDCONNECT, for operating system support see SIMATIC NET Software

6GK1161-3AA01

#### Accessories

#### IE TP Cord RJ45/RJ45

TP cable 4 x 2 with 2 RJ45 connectors

- 0.5 m
- 1 m
- 2 m
- 6 m
- 10 m

6XV1870-3QE50  
6XV1870-3QH10  
6XV1870-3QH20  
6XV1870-3QH60  
6XV1870-3QN10

<sup>1)</sup> also S5-compatible communication

#### Note:

For software ordering data, see page 2/636

## PROFINET/Industrial Ethernet

### Communication for PC-based systems

CP 1623

#### Overview



ISO	TCP/UDP	PN	MRP	OPC	PG/OP	S7/S5	IT
●	●			●	●	●	●

- PCI Express Card (PCIe x1) with an internal microprocessor for connection of PG/PC to Industrial Ethernet
- 10/100/1 000 Mbit/s (Autosensing/Autocrossover/Autonegotiation)
- Integrated 2-port switch (2 x RJ45 connection)
- Communications services via
  - Open IE communication (TCP/IP and UDP)
  - ISO transport protocol
  - PG/OP communication
  - S7 communication
  - Open communication (SEND/RECEIVE)
- Time synchronization
- ISO and TCP/IP transport protocol on board
- Integration into network management systems through the support of SNMP (V1)
- The appropriate OPC server and configuration tools are included in the scope of supply of the respective communication software.

#### Benefits

g e t **get** Designed for Industry

- High plant availability thanks to
  - stable and constant data communication by means of protocol processing on the CP
  - Optional: redundant communication via intelligent CPs combined with high-availability software package (S7-REDCONNECT)
- IT cost savings (e.g. no additional computer) and use of free computer capacity for further applications since the intelligent CPs facilitate large quantity structures and enable the workload of the host CPU to be reduced
- Simple access to automation/diagnostic data via SNMP and OPC as standard interface
- Easy and cost-efficient commissioning due to plug & play technology
- Connection of additional field devices to the Industrial Ethernet by means of an additional switch port
- Switch operation possible via external power supply even with PC turned off



### Application

The CP 1623 makes it possible to connect to the Industrial Ethernet (10/100/1 000 Mbit/s) for SIMATIC PG/PC and PCs with PCI Express slot. Additional field devices can be flexibly connected to the Industrial Ethernet via the integrated switch.

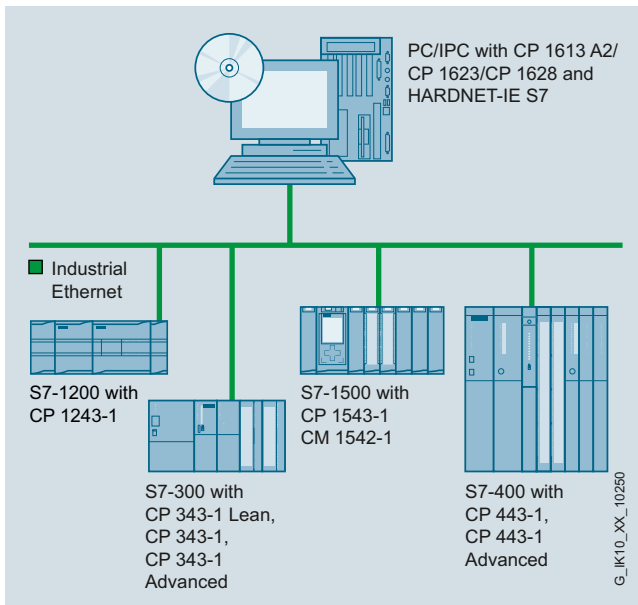

System configuration with CP 1613 A2/CP 1623/CP 1628 and HARDNET-IE S7

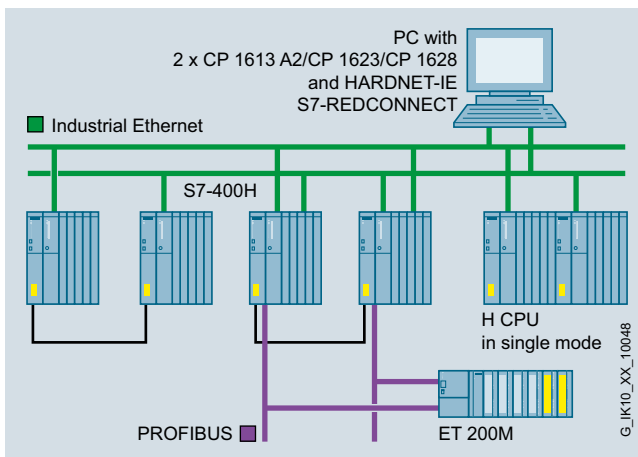

Example of redundant network structure with CP 1613 A2/CP 1623/CP 1628 and HARDNET-IE S7-REDCONNECT

### Design

Industrial Ethernet:

- 2 x RJ45 connection
- Integrated 2-port switch for 10/100/1 000 Mbit/s (half/full/duplex)
- Autosensing/Autocrossover/Autonegotiation

PG/PC slot:

- PCI Express x1 card
- Can also be operated in PCIe x4-, x8- or x16 slots
- Installation via PCIe standard mechanisms (Plug & Play)

Power supply:

- Operating voltage 3.3 V/12 V via PCIe interface
- Optional external 12 - 24 V DC power supply for switch operation with PG/PC turned off

Size:

- Short PCIe format

## PROFINET/Industrial Ethernet

### Communication for PC-based systems

CP 1623

#### Function

##### User interfaces

###### OPC interface

The OPC server included in the respective software package can be used as the standard programming interface for the protocols S7 communication and open communication, in order to connect automation technology applications to OPC-compatible Windows applications (Office, HMI systems, etc.)

###### Programming interface through C library

The programming interfaces for the S7 communication, PG/OP communication, and open communication protocols for existing applications are implemented as Dynamic Link Library (DLL) interfaces.

The released compilers can be found in the readme file of the SIMATIC NET CD products at <http://www.siemens.com/automation/csi/net>

###### Software for PG/OP communication

This software makes it possible to program the S7 controllers via Industrial Ethernet in conjunction with the STEP 7 engineering software.

It is contained in all CP 1623 software packages.

###### Software for S7 communication (HARDNET-IE S7 or S7-REDCONNECT)

The S7 interface allows PG/PC applications (e.g. WinCC) and user programs to access the SIMATIC S7 system components. This provides easy, flexible access to the data of the SIMATIC S7 controller.

S7 communication offers:

###### Administrative services

- Connection management
- Mini database
- Trace

###### Data transfer services

- Read/write variables
- BSEND/BRECEIVE

###### H-communication

For redundant S7 communication with a high availability S7-400H system, the CP 1613/CP 1623/CP 1628 can be used in connection with the S7-REDCONNECT software.

##### Software for open communication (SEND/RECEIVE)

This interface is used for communication between

- PG/PC and SIMATIC S5
- PG/PC and SIMATIC S7
- PG/PC and PG/PC

Open communication (SEND/RECEIVE) offers the following services:

- Management services
- Connection establishment services
- Data transfer services

These functionalities are a component part of the HARDNET-IE S7 software product.

##### Mode of operation

Protocols up to Level 4 (Transport) are processed autonomously on the module.

The internal memory is available for this purpose and it also provides for a large quantity structure and high communication reliability.

Data is exchanged between the module and the host in master mode. This means that the CP 1623 accesses the physical RAM of the host.

A Windows driver transfers the data between the host system and the CP 1623. The transmission rate to Industrial Ethernet is detected and automatically switched over (autosensing).

The IT functionality is provided in combination with the Windows software of the PC.

##### Diagnostics

All MIB-2 objects, for example, can be read out via SNMP. This enables the current status of the Ethernet interfaces to be retrieved.

##### Configuration

- The S7 communication and open communication protocols are configured in STEP 7 or NCM PC.
- A configuration tool is included in the scope of delivery of the CP 1623 software packages.

2

### Technical specifications

Article No.	6GK1162-3AA00	Article No.	6GK1162-3AA00
Product-type designation	CP 1623	Product-type designation	CP 1623
<b>Transmission rate</b>		<b>Product properties, functions, components general</b>	
Transfer rate at the interface 1	10 ... 1 000 Mbit/s	Number of plug-in cards in the same design can be plugged in per PC station	4
<b>Interfaces</b>		Number of modules note	-
Number of electrical connections		<b>Performance data</b>	
• at interface 1 in accordance with Industrial Ethernet	2	<u>Performance data open communication</u>	
• for power supply	1	Software for open communication by means of SEND/RECEIVE required	Yes, HARDNET-IE S7 (S7-1613)
Design of electrical connection		Number of possible connections for open communication by means of SEND/RECEIVE maximum	120
• at interface 1 in accordance with Industrial Ethernet	RJ45 port	<u>Performance data S7 communication</u>	
• of the backplane bus	PCI Express x1	Software for S7 communication required	Yes, HARDNET-IE S7 (S7-1613)
• for power supply	2-pin terminal block	Number of possible connections	
<b>Supply voltage, current consumption, power loss</b>		• for S7/PG communication maximum	120
Type of supply voltage	DC	• for optimized S7 communication maximum	40
Type of power supply optional external supply	Yes	<u>Performance data multi-protocol mode</u>	
Supply voltage		Number of active connections with multiprotocol mode	120
• 1 from backplane bus	3.3 V	Number of configurable connections per PC station	207
• 2 from the backplane bus	12 V	<u>Performance data PROFINET CBA</u>	
• external	24 V	Software for PROFINET CBA communication required	Yes, PN CBA OPC server
- minimum	10.5 V	Number of remote connection partners with PROFINET CBA	228
- maximum	32 V	Number of connections with PROFINET CBA total	10 000
• note	-	<b>Product functions management, configuration</b>	
Relative symmetrical tolerance		Product function MIB support	Yes
• at 3.3 V with DC	9 %	Protocol is supported	
• at 12 V with DC	8 %	• SNMP v1	Yes
• at 24 V with DC	33 %	• SNMP v3	No
Consumed current		• DCP	Yes
• 1 from backplane bus with DC maximum	0.85 A	Configuration software	
• 2 from backplane bus with DC maximum	0.4 A	• required	included in scope of delivery of the required software
• from external supply voltage		• for PROFINET CBA required	Yes, SIMATIC iMAP
- at 12 V with DC max.	0.55 A	Identification & maintenance function	
- at 24 V with DC maximum	0.3 A	• I&M0 - device-specific information	Yes
Resistive loss	7.6 W	• I&M1 - higher level designation/location designation	Yes
• in switch mode maximum	7.2 W		
<b>Permitted ambient conditions</b>			
Ambient temperature			
• during operating	5 ... 55 °C		
• during storage	-20 ... +60 °C		
• during transport	-20 ... +60 °C		
Relative humidity at 25 °C without condensation during operating maximum	95 %		
Protection class IP	IP00		
<b>Design, dimensions and weight</b>			
Module format	PCI Express x1 (half length)		
Width	18 mm		
Height	111 mm		
Depth	167 mm		
Net weight	124 g		

## PROFINET/Industrial Ethernet

### Communication for PC-based systems

CP 1623

#### Technical specifications (continued)

<b>Article No.</b>	<b>6GK1162-3AA00</b>
<b>Product-type designation</b>	<b>CP 1623</b>
<b>Product functions switch</b>	
Product feature switch	Yes
Product function switch-managed	No
Product function for IRT PROFINET IO switch	No
<b>Product functions Redundancy</b>	
Software for redundancy function required	Yes, HARDNET-IE S7-REDCONNECT for communication with SIMATIC S7 H systems
<b>Product functions Time</b>	
Product function SICLOCK support	Yes
Protocol is supported NTP	No
<b>Standards, specifications, approvals</b>	
Standard	
• for EMC	2004/108/EC
• for safety of CSA and UL	CAN/CSA C22.2 & UL 60950-1, UL 1950
• for emitted interference	EN 61000-6-3, EN 61000-6-4
• for interference immunity	EN 61000-6-1, EN 61000-6-2
Verification of suitability	
• CE mark	Yes
• C-Tick	Yes

#### Ordering data

#### Article No.

##### CP 1623 communications processor

PCI Express x1 card for connection to Industrial Ethernet (10/100/1 000 Mbit/s), with 2-port switch (RJ45) via HARDNET-IE S7/S7-1613 and S7-REDCONNECT. For operating system support, see SIMATIC NET Software

**6GK1162-3AA00**

##### Accessories

##### IE TP Cord RJ45/RJ45

TP cable 4 x 2 with 2 RJ45 connectors

- 0.5 m
- 1 m
- 2 m
- 6 m
- 10 m

**6XV1870-3QE50**  
**6XV1870-3QH10**  
**6XV1870-3QH20**  
**6XV1870-3QH60**  
**6XV1870-3QN10**

#### Note:

For software ordering data, see page 2/636

2

### Overview



ISO	TCP/UDP	PN	MRP	OPC	PG/OP	S7/S5	IT
●	●			●	●	●	●

- PCI Express card (PCIe x1) with its own microprocessor and integrated 2-port switch (2 x RJ45 connection, 10/100/1000 Mbit/s) for the connection of a PG/PC to Industrial Ethernet
- Integrated security mechanisms (e.g. Firewall, VPN)
- ISO and TCP/IP transport protocol on board
- Communications services via
  - Open IE communication (TCP/IP and UDP)
  - ISO transport protocol
  - PG/OP communication
  - S7 communication
  - Open communication (SEND/RECEIVE)
- Integration into network management systems through the support of SNMP (V1/V3)

### Benefits

get **Designed for Industry**

- High plant availability thanks to
  - stable and constant data communication by means of protocol processing on the CP
  - Optional: redundant communication via intelligent CPs combined with high-availability software package (HARDNET-IE S7-REDCONNECT)
- Safeguarding of important computer systems and their associated data communication by means of integrated security mechanisms on the CP, such as firewall and VPN
- IT cost savings (e.g. no additional computer) and use of free computer capacity for further applications since intelligent CPs facilitate large quantity structures and enable the workload of the host CPU to be reduced
- Simple access to automation/diagnostic data via SNMP and OPC as standard interface e

# PROFINET/Industrial Ethernet

## Communication for PC-based systems

### CP 1628

#### Application

The CP 1628 makes it possible to connect SIMATIC PG/PC and PCs with PCI Express slot to the Industrial Ethernet (10/100/1000 Mbps). Additional field devices can be flexibly connected to the Industrial Ethernet via the integrated switch.

2

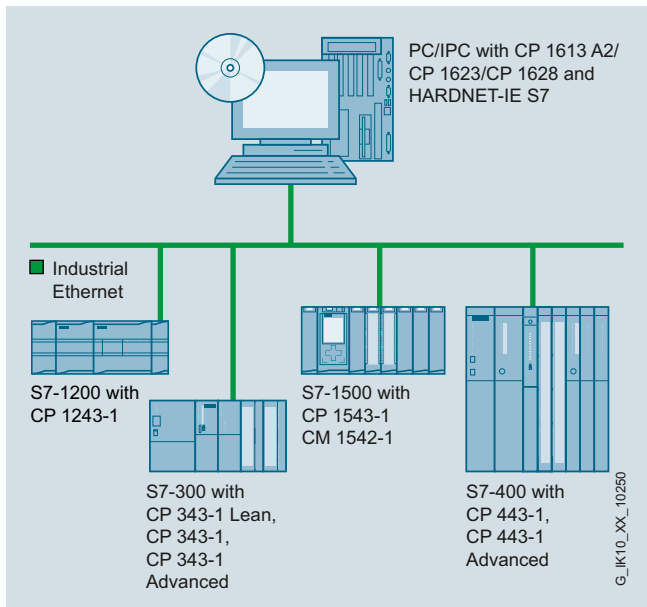

System configuration with CP 1613 A2/CP 1623/CP 1628 and HARDNET-IE S7

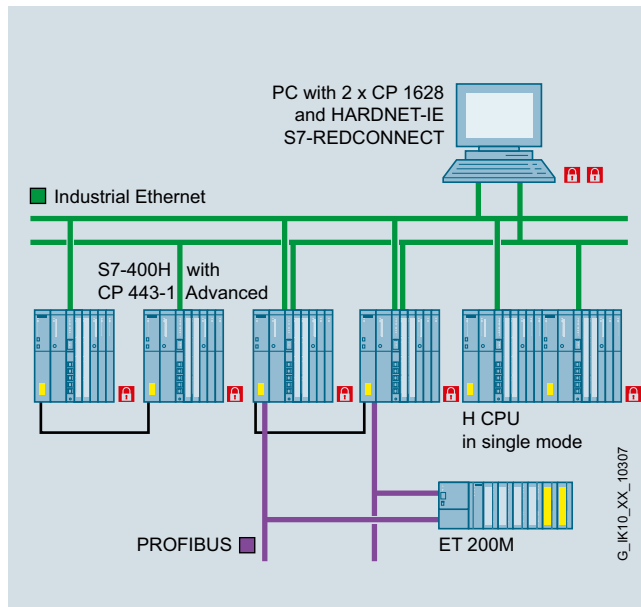

Example of redundant and secure network structure with CP 1628 and HARDNET-IE S7-REDCONNECT

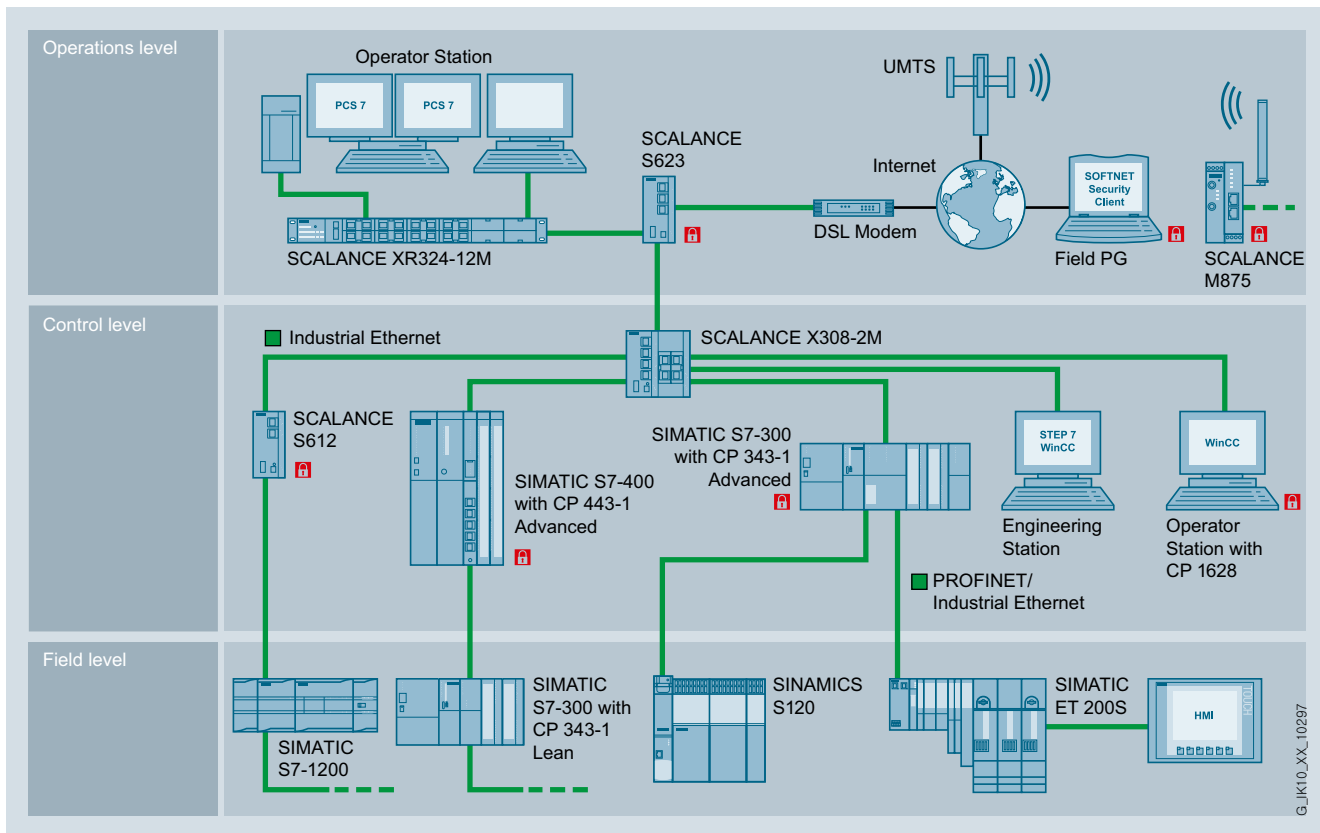

Secure VPN communication between SCALANCE S, SOFTNET Security Client and components with Security Integrated

### Design

Industrial Ethernet:

- 2 x RJ45 connection
- Integrated 2-port switch for 10/100/1 000 Mbps (half/full duplex)
- Autosensing/Autocrossover/Autonegotiation

PG/PC slot:

- PCI Express x1 card
- Can also be operated in PCIe x4, x8 or x16 slots
- Installation via PCIe standard mechanisms (Plug & Play)

Power supply:

- Operating voltage 3.3 V/12 V via PCIe interface
- Optional external 12 - 24 V DC power supply for switch operation with PG/PC turned off

Size:

- Short PCIe format

### Function

#### User interfaces

##### OPC interface

The OPC server included in the respective software package can be used as the standard programming interface for the protocols S7 communication and open communication, in order to connect automation technology applications to OPC-compatible Windows applications (Office, HMI systems, etc.)

##### Programming interface through C library

The programming interfaces for the S7 communication, PG/OP communication, and open communication protocols for existing applications are implemented as Dynamic Link Library (DLL) interfaces.

The released compilers can be found in the readme file of the SIMATIC NET CD products at <http://www.siemens.com/automation/csi/net>

#### Software for PG/OP communication

This software makes it possible to program the S7 controllers via Industrial Ethernet in conjunction with the STEP 7 engineering software.

It is contained in all CP 1628 software packages.

#### Software for S7 communication (HARDNET-IE S7 or HARDNET-IE S7-REDCONNECT)

The S7 interface allows PG/PC applications (e.g. WinCC) and user programs to access the SIMATIC S7 system components. This provides easy, flexible access to the data of the SIMATIC S7 controller.

S7 communication offers:

##### Administrative services

- Connection management
- Mini database
- Trace

##### Data transfer services

- Read/write variables
- BSEND/BRECEIVE

##### H-communication

For redundant S7 communication with a fault-tolerant S7-400H system, the CP 1613/CP1623/CP 1628 can be used in connection with the HARDNET-IE S7-REDCONNECT software.

#### Software for open communication (SEND/RECEIVE)

This interface is used for communication between

- PG/PC and SIMATIC S5
- PG/PC and SIMATIC S7
- PG/PC and PG/PC

Open communication (SEND/RECEIVE) offers the following services:

- Management services
- Connection establishment services
- Data transfer services

These functionalities are a component part of the HARDNET-IE S7 software product.

#### Security mechanisms:

Integrated security mechanisms enable safeguarding of important computer systems, including their associated data communication systems:

- Stateful Inspection Firewall for filtering connections on the basis of their IP/port addresses
- Bandwidth limitation to avoid communication overload
- Secure and encrypted access to controllers or remote access over the Internet by means of VPN Server and VPN Client and checking of data integrity
- Tap-proof transmission of network analysis information to the network management system (SNMP V3)
- Secure transfer of the time of day (NTP V3)
- Traceability by means of data logging on the basis of standard IT mechanisms (Syslog)

#### Mode of operation

Protocols up to Level 4 (Transport) are processed autonomously on the module.

The internal memory is available for this purpose and it also provides for a large quantity structure and high communication reliability.

Data is exchanged between the module and the host in master mode. This means that the CP 1628 accesses the physical RAM of the host.

A Windows driver transfers the data between the host system and the CP 1628. The transmission rate to Industrial Ethernet is detected and automatically switched over (autosensing).

The IT functionality is provided in combination with the Windows software of the PC.

#### Diagnostics

All MIB-2 objects, for example, can be read out via SNMP. This enables the current status of the Ethernet interfaces to be retrieved.

#### Configuration

- The S7 communication and open communication protocols are configured in STEP 7 or NCM PC.
- A configuration tool is included in the scope of delivery of the CP 1628 software packages.

# PROFINET/Industrial Ethernet

## Communication for PC-based systems

CP 1628

### Technical specifications

Article No.	6GK1162-8AA00	Article No.	6GK1162-8AA00
Product-type designation	CP 1628	Product-type designation	CP 1628
<b>Transmission rate</b>		<b>Design, dimensions and weight</b>	
Transfer rate at the interface 1	10 ... 1 000 Mbit/s	Module format	PCI Express x1 (half length)
<b>Interfaces</b>		Width	18 mm
Number of electrical connections		Height	111 mm
• at interface 1 in accordance with Industrial Ethernet	2	Depth	167 mm
• for power supply	1	Net weight	0.124 kg
Design of electrical connection		<b>Product properties, functions, components general</b>	
• at interface 1 in accordance with Industrial Ethernet	RJ45 port	Number of plug-in cards in the same design can be plugged in per PC station	4
• of the backplane bus	PCI Express x1	<b>Performance data</b>	
• for power supply	2-pin terminal block	<u>Performance data open communication</u>	
<b>Supply voltage, current consumption, power loss</b>		Software for open communication by means of SEND/RECEIVE required	Yes, HARDNET-IE S7 (S7-1613)
Type of supply voltage	DC	Number of possible connections for open communication by means of SEND/RECEIVE maximum	120
Type of power supply optional external supply	Yes	<u>Performance data S7 communication</u>	
Supply voltage		Software for S7 communication required	Yes, HARDNET-IE S7 (S7-1613)
• 1 from backplane bus	3.3 V	Number of possible connections	
• 2 from the backplane bus	12 V	• for S7/PG communication maximum	120
• external	24 V	• for optimized S7 communication maximum	64
- minimum	10.5 V	<u>Performance data multi-protocol mode</u>	
- maximum	32 V	Number of active connections with multiprotocol mode	120
Supply voltage note	-	Number of configurable connections per PC station	207
Relative symmetrical tolerance		<u>Performance data PROFINET CBA</u>	
• at 3.3 V with DC	9 %	Software for PROFINET CBA communication required	Yes, PN CBA OPC server
• at 12 V with DC	8 %	Number of remote connection partners with PROFINET CBA	228
• at 24 V with DC	33 %	Number of connections with PROFINET CBA total	10 000
Consumed current		<b>Product functions management, configuration</b>	
• 1 from backplane bus with DC maximum	0.85 A	Product function MIB support	Yes
• 2 from backplane bus with DC maximum	0.4 A	Protocol is supported	
• from external supply voltage		• SNMP v1	Yes
- at 12 V with DC max.	0.55 A	• SNMP v3	Yes
- at 24 V with DC maximum	0.3 A	• DCP	Yes
Resistive loss	7.6 W	Configuration software	
Resistive loss in switch mode maximum	7.2 W	• required	included in scope of delivery of required software
<b>Permitted ambient conditions</b>		• for PROFINET CBA required	Yes, SIMATIC IMAP
Ambient temperature		Identification & maintenance function	
• during operating	5 ... 55 °C	• I&M0 - device-specific information	Yes
• during storage	-20 ... +60 °C	• I&M1 - higher level designation/location designation	Yes
• during transport	-20 ... +60 °C		
Relative humidity at 25 °C without condensation during operating maximum	95 %		
Protection class IP	IP00		



### Technical specifications (continued)

<b>Article No.</b>	<b>6GK1162-8AA00</b>
<b>Product-type designation</b>	<b>CP 1628</b>
<b>Product functions switch</b>	
Product feature switch	Yes
Product function	
• switch-managed	No
• for IRT PROFINET IO switch	No
<b>Product functions Redundancy</b>	
Software for redundancy function required	Yes, HARDNET-IE S7-REDCONNECT for communication with SIMATIC S7 H systems
<b>Product functions Security</b>	
Design of the firewall	stateful inspection
Product function with VPN connection	IPSec
Type of encryption algorithms with VPN connection	AES-256, AES-192, AES-128, 3DES-168, DES-56
Type of authentication procedure with VPN connection	Preshared key (PSK), X.509v3 certificates
Type of hashing algorithms with VPN connection	MD5, SHA-1
Number of possible VPN tunnels	64
Number of possible connections for S7 communication	
• via ISO and VPN with S7-REDCONNECT maximum	64
• via TCP and VPN with S7-REDCONNECT maximum	120
Number of available IP addresses with VPN connection maximum	16
<b>Product functions Time</b>	
Product function SICLOCK support	Yes
Protocol is supported NTP	Yes
<b>Standards, specifications, approvals</b>	
Standard	
• for EMC	2004/108/EC
• for safety of CSA and UL	CAN/CSA C22.2 & UL 60950-1, UL 1950
• for emitted interference	EN 61000-6-3, EN 61000-6-4
• for interference immunity	EN 61000-6-1, EN 61000-6-2
Verification of suitability	
• CE mark	Yes
• C-Tick	Yes

### Ordering data

### Article No.

#### CP 1628 communications processor

PCI Express x1 card for connection to Industrial Ethernet (10/100/1 000 Mbit/s), with 2-port switch (RJ45) and integrated security (firewall, VPN) via HARDNET-IE S7 and S7-REDCONNECT. For operating system support, see SIMATIC NET Software

**6GK1162-8AA00**

#### Accessories

#### IE TP Cord RJ45/RJ45

TP cable 4 x 2 with 2 RJ45 connectors

- 0.5 m
- 1 m
- 2 m
- 6 m
- 10 m

**6XV1870-3QE50**  
**6XV1870-3QH10**  
**6XV1870-3QH20**  
**6XV1870-3QH60**  
**6XV1870-3QN10**

#### Note:

For software ordering data, see page 2/636

### More information

You will find more information on the topic of Industrial Security on the Internet at:

<http://www.siemens.com/industrialsecurity>

## PROFINET/Industrial Ethernet

### Communication for PC-based systems

#### HARDNET-IE S7-REDCONNECT

##### Overview

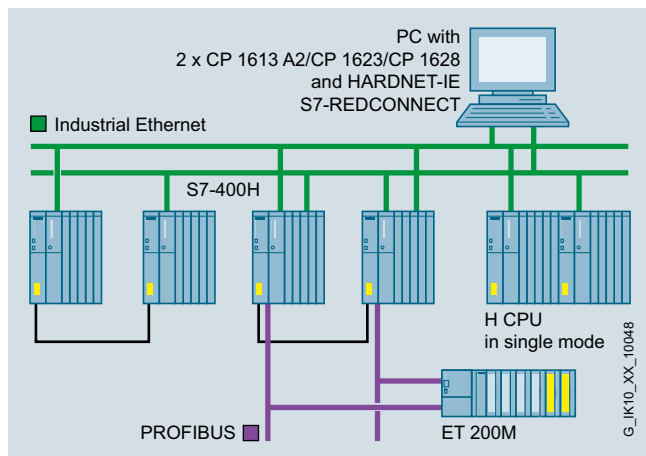

System configuration for S7-REDCONNECT

ISO	TCP/UDP	PN	MRP	OPC	PG/OP	S7/S5	IT
●				●	●	●	

- For connecting PCs over redundant Industrial Ethernet to the SIMATIC S7-400H
- Protected from communication failures arising from a fault in the double bus or in redundant rings
- For redundant Layer 2 or Layer 3 Industrial Ethernet
- Can also be implemented in non-redundant networks
- No additional programming overhead for the PC and in H systems
- The appropriate OPC server and configuration tools are included in the scope of supply of the respective communication software
- Enhanced redundancy over 4-way communication (STEP 7 V5.1 + SP4 and higher)

##### Benefits

get **Designed for Industry**

- Protects against communication failures arising from a fault in the double bus or in redundant rings
- Simplifies communication between a PC application and the SIMATIC S7-400H system
- Secures the investment thanks to the use of existing applications and flexible application options
- No additional programming overhead for the PC and in H systems
- Increases the availability of the PC application (e.g. PCS 7) thanks to redundant Layer 2 or Layer 3 communication

##### Application

The HARDNET-IE S7-REDCONNECT software package connects the SIMATIC S7-400H with applications on the PC such as WinCC.

A redundant Industrial Ethernet is typically used. The software package can also be used if SIMATIC H systems are operated on non-redundant networks.

Combined operation of redundant and single systems is also possible.

##### Design

The following components are required to design a SIMATIC H system with PC connection

PC with:

- up to four CP 1613 A2/CP 1623/CP 1628 and HARDNET-IE S7-REDCONNECT to connect the PC to Industrial Ethernet with ISO or ISO-on-TCP protocol

S7-400H with:

- CP 443-1 to connect the S7-400H to Industrial Ethernet with ISO or ISO-on-TCP protocol
- STEP 7 V5.0 to V5.5 for configuring

### Function

- HARDNET-IE S7-REDCONNECT contains the functional scope of the HARDNET-IE S7 software package (S7-communication, open communication and PG/OP communication) as well as additional redundant communication over S7 connections. No additional license is required for HARDNET-IE S7.
- Open communication
- Time synchronization
- Existing Windows applications can be used
- Services for monitoring the redundant communication
- Diagnostic tool for visualizing the communication status
- Simple redundancy over 2-way communication (STEP 7 V5.0 SP2 and higher)
- Enhanced redundancy over 4-way communication (STEP 7 V5.1 + SP4 and higher)

Fault-tolerant S7 communication is carried out via a standard connection and a standby connection. These are monitored during operation and switched in the event of a fault. With HARDNET-IE S7-REDCONNECT, these remain hidden from the PC application.

Fault detection, changeover (if required), communication monitoring, and synchronization are all invisible to the application.

The application, e.g. WinCC, communicates with both subunits of the S7-400H as with an S7-CPU.

### User interfaces

#### OPC interface

The OPC server included in the respective software package can be used as the standard programming interface for the S7 communication and open communication protocols in order to connect automation technology applications to OPC-compatible Windows applications such as Office, HMI systems, etc.

#### Configuration

- H-connections are configured and engineered using STEP 7 (V5.0 to V5.5)

### Integration

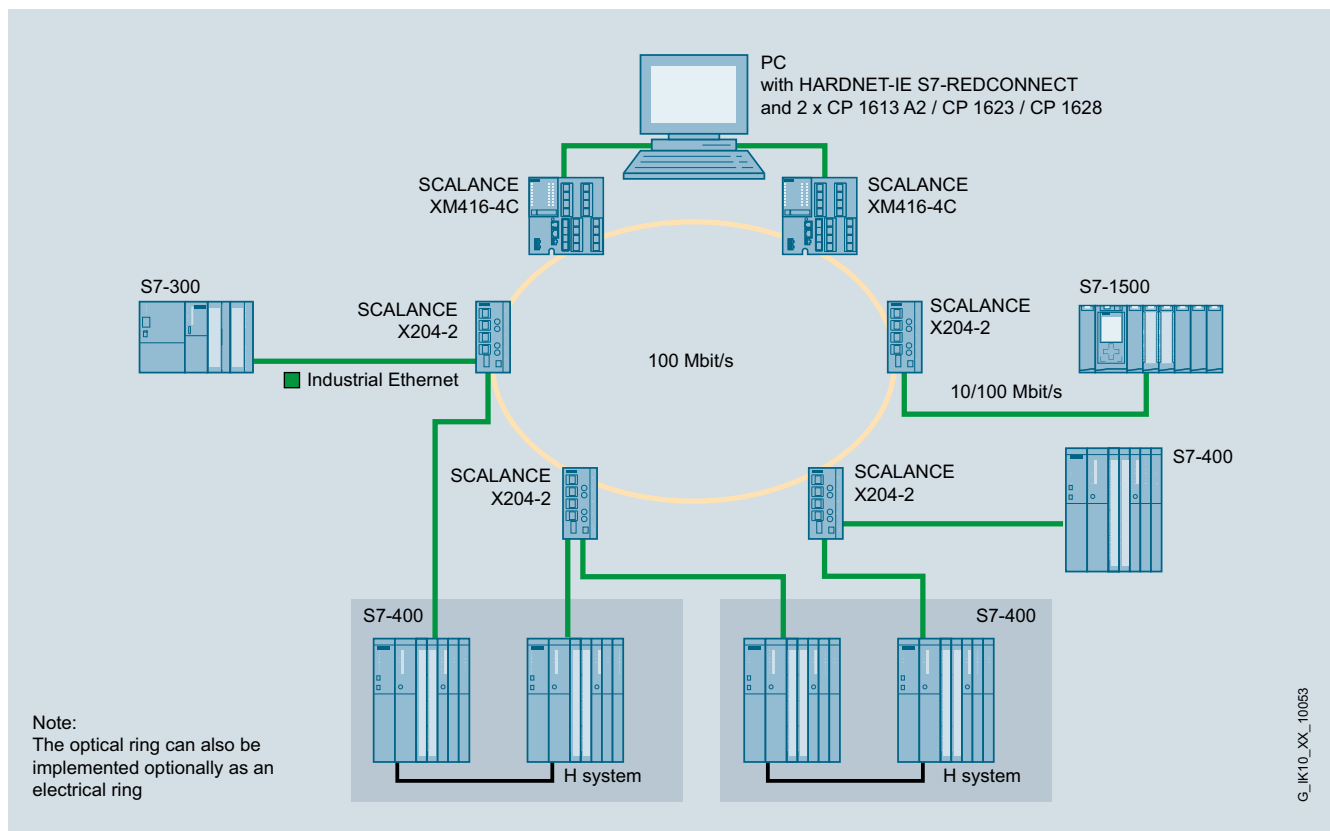

Redundant optical ring for connection of high-availability systems

# PROFINET/Industrial Ethernet

## Communication for PC-based systems

### HARDNET-IE S7-REDCONNECT

#### Ordering data

#### Article No.

#### Article No.

##### *HARDNET-IE S7-REDCONNECT*

Software for fail-safe S7 communication via redundant networks, incl. S7 OPC server, HARDNET-IE S7, runtime software, software and electronic manual on CD-ROM, license key on USB stick, Class A;

For CP 1613 A2,  
CP 1623, CP 1628

##### **HARDNET-IE S7-REDCONNECT V12**

for 32/64-bit:  
Windows 7 Professional/Ultimate;  
for 64-bit:  
Windows 2008 Server R2  
for 32/64 Bit Windows 8 Pro;  
for Windows Server 2012  
German/English

- Single License for one installation

##### **Software Update Service**

For one year  
with automatic extension;  
requirement:  
current software version

##### **Upgrade**

- As of Edition 2006 to S7-REDCONNECT Edition 2008 or HARDNET-IE S7-REDCONNECT V12
- From V6.0, V6.1, V6.2 or V6.3 to S7-REDCONNECT Edition 2008 or HARDNET-IE S7-REDCONNECT V12

**6GK1716-0HB12-0AA0**

**6GK1716-0HB00-3AL0**

**6GK1716-0HB00-3AE0**

**6GK1716-0HB00-3AE1**

##### *HARDNET-IE S7-REDCONNECT PowerPack*

For expansion from HARDNET-IE S7 to HARDNET-IE S7-REDCONNECT / from S7-1613 to S7 REDCONNECT, Single License for one installation, runtime software, software and electronic manual on CD-ROM, license key on USB stick, Class A;

##### **HARDNET-IE S7-REDCONNECT PowerPack V12**

for 32/64-bit:  
Windows 7 Professional/Ultimate;  
for 64-bit:  
Windows 2008 Server R2;  
for 32/64-bit Windows 8 Pro;  
for Windows Server 2012  
German/English;

##### **CP 1613 A2 communications processor**

PCI card (32-bit, 33 MHz/66 MHz; 3.3 V/5 V universal keyed) for connection to Industrial Ethernet (10/100 Mbit/s) with ITP and RJ45 connection over HARDNET-IE S7 and S7-REDCONNECT, for operating system support see SIMATIC NET Software

##### **CP 1623 communications processor**

PCI Express x1 card for connection to Industrial Ethernet (10/100/1 000 Mbit/s), with 2-port switch (RJ45) via HARDNET-IE S7 and S7-REDCONNECT. For operating system support, see SIMATIC NET Software

##### **CP 1628 communications processor**

PCI Express x1 card for connection to Industrial Ethernet (10/100/1 000 Mbit/s), with 2-port switch (RJ45) and integrated security (firewall, VPN) via HARDNET-IE S7 and S7-REDCONNECT. For operating system support, see SIMATIC NET Software

**6GK1716-0HB12-0AC0**

**6GK1161-3AA01**

**6GK1162-3AA00**

**6GK1162-8AA00**

### Overview

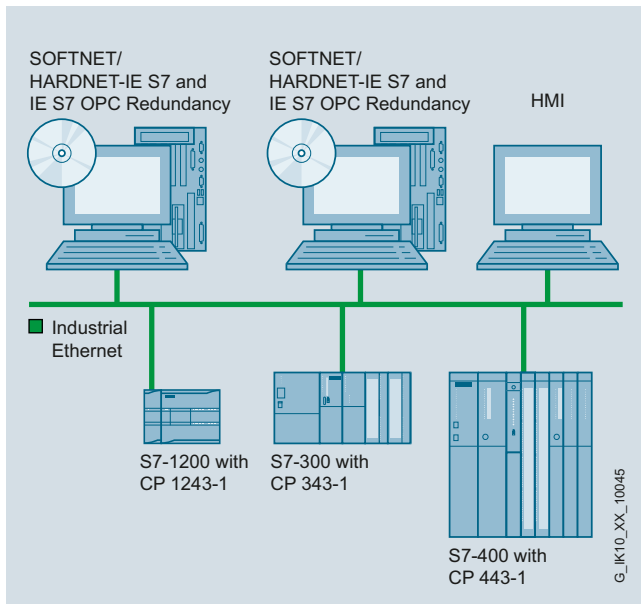

System configuration SOFTNET for Industrial Ethernet

ISO	TCP/UDP	PN	MRP	OPC	PG/OP	S7/S5	IT
●	●			●	●	●	

- Software for coupling programming devices/workstations to automation systems
- Communication services:
  - PG/OP communication
  - S7 communication
  - Open communication (SEND/RECEIVE)
- Can be used with
  - Layer 2 Ethernet card (PCI/PCle), e.g. CP 1612 A2
  - Integrated Industrial Ethernet interface
  - Modem/ISDN (Remote Access Service RAS)
- Complete protocol stack as a software package
- Increased availability thanks to additional option packages such as OPC Server Redundancy

### Benefits



- Maximum transparency due to integrated communication with SIMATIC via Industrial Ethernet and OPC as the standard interface
- Low-cost solution for industrial use in PCs that require smaller quantity structures
- Simple and low-cost commissioning thanks to uniform procedure and configuration functionality with NCM PC and STEP 7
- Increased availability of the plant information by means of redundant SIMATIC NET OPC server

### Application

With SOFTNET for Industrial Ethernet, PC/PG and workstations can be connected to programmable controllers, such as SIMATIC S7, over Industrial Ethernet.

The following user interfaces are available:

- PG/OP communication for SIMATIC S7
- Open communication (SEND/RECEIVE) for communication with SIMATIC S5 and S7
- S7 communication

SOFTNET is available for the following interfaces:

- Layer 2 Ethernet card (PCI/PCle), e.g. CP 1612 A2
- integrated Industrial Ethernet interface
- Modem/ISDN (Remote Access Service RAS)

### Function

With SOFTNET, the complete protocol stack is processed in the PC.

This architecture means that in contrast to the CP 1613 A2/CP 1623/CP 1628 communications processors, the performance of the SOFTNET packages is dependent on the configuration or capacity utilization of the PC used.

The IT functionality is established in connection with the interfaces and the PC's Windows software.

### User interfaces

#### OPC interface

The OPC server included in the respective software package can be used as the standard programming interface for the S7 communication and open communication protocols in order to connect automation technology applications to OPC-compatible Windows applications such as Office, HMI systems, etc.

#### Software for PG/OP communication

This software makes it possible to program the S7 controllers via Industrial Ethernet in conjunction with the STEP 7 engineering software.

#### Software for S7 communication

SIMATIC S7 system components communicate with each other using S7 communication functions.

The S7 communication can be based optionally on the ISO protocol or the TCP/IP protocol.

S7 communication offers the following services:

- Administrative services
- S7 connection management services
- Variable services
- VFD (Virtual Field Device) services
- Trace and mini database

## PROFINET/Industrial Ethernet

### Communication for PC-based systems

#### SOFTNET for Industrial Ethernet

##### Function (continued)

##### Open communication (SEND/RECEIVE)

This interface based on Layer 4 (ISO Transport or TCP/IP with RFC 1006) is used for communication between

- PG/PC and SIMATIC S5
- PG/PC and SIMATIC S7
- PG/PC and PG/PC

Open communication (SEND/RECEIVE) offers the following services:

- Management services
- Dial-up services
- Data transfer services

##### Configuration

- The complete configuration of the S7 communication and open communication protocols takes place in STEP 7 or NCM PC V5.1 SP2 or higher
- A configuration tool is included in the scope of delivery of the corresponding packages
- H-connections are configured using STEP 7 (V5.0 to V5.5)

##### Technical specifications

Product-type designation	SOFTNET für Industrial Ethernet
<i>Performance data</i>	
<b>S7 and PG/OP communication</b> (number of operable connections)	
• SOFTNET-IE S7	max. 64
• SOFTNET-IE S7 Lean	max. 8

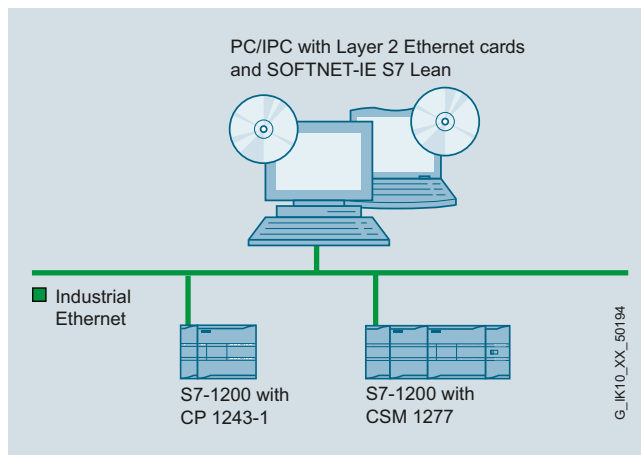

System configuration with SOFTNET-S7 Lean for Industrial Ethernet and SIMATIC S7-1200

Ordering data	Article No.	Article No.	
<b>SOFTNET S7 for Industrial Ethernet</b>		<b>SOFTNET-PG for Industrial Ethernet</b>	
Software for S7 and open communication, incl. OPC server, PG/OP communication, and NCM PC / STEP 7 Professional V12, runtime software, software and electronic manual on CD-ROM, license key on a USB stick, Class A		Software for PG/OP communication, runtime software, software and electronic manual on CD-ROM, license key on USB flash drive, Class A	
<b>SOFTNET-IE S7 V12</b>		<b>SOFTNET-IE PG V12</b>	
For 32/64-bit Windows 7 Professional/Ultimate; for 64-bit: Windows 2008 Server R2; for 32/64-bit Windows 8 Pro; for Windows Server 2012 German/English		For 32/64-bit: Windows 7 Professional/Ultimate; for 64-bit: Windows 2008 Server R2; for 32/64-bit Windows 8 Pro; for Windows Server 2012: German/English	
Up to 64 connections • Single License for one installation	<b>6GK1704-1CW12-0AA0</b>	• Single License for one installation	<b>6GK1704-1PW12-0AA0</b>
<b>Software Update Service</b>	<b>6GK1704-1CW00-3AL0</b>	<b>Software update</b>	<b>6GK1704-1PW00-3AL0</b>
For 1 year with automatic extension; requirement: current software version		For 1 year with automatic extension; requirement: Current software version	
<b>Upgrade</b>		<b>Upgrade</b>	
• From Edition 2006 to Edition 2008 or V12	<b>6GK1704-1CW00-3AE0</b>	• From Edition 2006 to Edition 2008 or V12	<b>6GK1704-1PW00-3AE0</b>
• From V6.0, V6.1, V6.2 or V6.3 to Edition 2008 or V12	<b>6GK1704-1CW00-3AE1</b>	• From V6.0, V6.1, V6.2 or V6.3 to Edition 2008 or V12	<b>6GK1704-1PW00-3AE1</b>
<b>SOFTNET-IE S7 REDCONNECT VM V12</b>		<b>IE S7 OPC Redundancy</b>	
Software for fail-safe S7 communication via redundant networks, incl. S7 OPC server, runtime software, software and electronic manual on CD-ROM, license key on USB stick, Class A for 32/64-bit: Windows 7 Professional/Ultimate; for 64-bit: Windows 2008 Server R2; for 32/64-bit Windows 8 Pro; for Windows Server 2012 German/English;		Software for redundant OPC servers in the environment of Industrial Ethernet software, S7 products, runtime software, software and electronic manual on CD-ROM, license key on USB flash drive, Class A	
• Single License for one installation	<b>6GK1704-0HB12-0AA0</b>	<b>IE S7 OPC Redundancy V12</b>	
<b>SOFTNET-IE S7 Lean Edition V12</b>		For 64-bit: Windows 2008 Server R2; German/English	
For 32/64-bit Windows 7 Professional/Ultimate; for 64-bit: Windows 2008 Server R2; for 32/64-bit Windows 8 Pro; for Windows Server 2012 German/English		• Single License for one installation	<b>6GK1706-1CW12-0AA0</b>
Up to eight connections • Single License for one installation	<b>6GK1704-1LW12-0AA0</b>		
<b>Software Update Service</b>	<b>6GK1704-1LW00-3AL0</b>		
For 1 year with automatic extension; requirement: Current software version			
<b>Upgrade</b>			
• From Edition 2006 to Edition 2008 or V12	<b>6GK1704-1LW00-3AE0</b>		
• From V6.0, V6.1, V6.2 or V6.3 to Edition 2008 or V12	<b>6GK1704-1LW00-3AE1</b>		

## PROFINET/Industrial Ethernet

### Communication for PC-based systems

#### SOFTNET-IE RNA

##### Overview



- SOFTNET-IE RNA (Redundant Network Access) is the software for connecting a PC to networks with PRP (**P**arallel **R**edundancy **P**rotocol in accordance with IEC62439-3) capability
- High level of plant availability thanks to duplicate transmission of frames in two parallel, separate networks
- Reconfiguration times in a subnetwork do not affect the propagation time because the frames are transmitted via two separate networks (bumpless redundancy)
- Integration in network management systems through support for SNMP
- Configuring tools are included in the scope of delivery of the communication software in each case

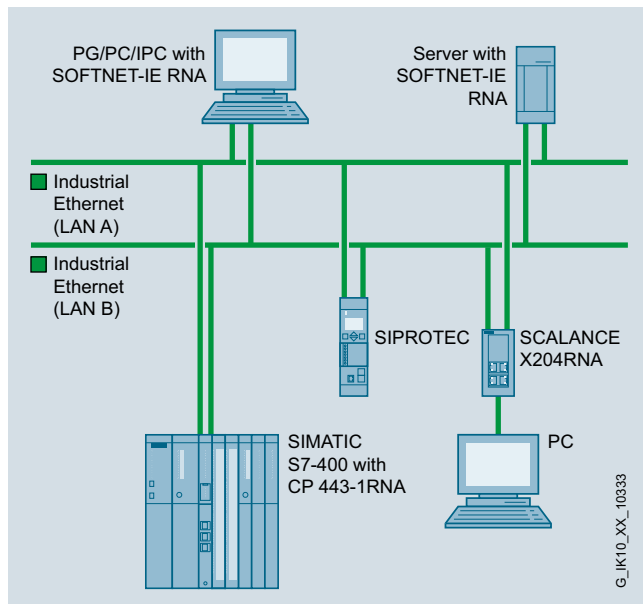

##### Benefits

get **Designed for Industry**

- Increases the availability of the PC application by establishing Industrial Ethernet networks with high network availability (bumpless media redundancy through parallel data transfer in parallel networks)
- High availability of the overall plant
- No additional programming overhead required in the PC
- Secures the investment thanks to the use of existing applications and flexible application options
- Simple integration into existing network management systems thanks to access to diagnostic data via SNMP as the standard interface

##### Application

The SOFTNET-IE RNA software package enables low-cost connection of non-PRP-enabled terminal equipment to parallel, separate networks in which high availability is demanded.

##### Function

- Connection of PCs to parallel, separate networks (PRP)
- Parallel data transfer over two parallel, separate networks
- Simple diagnostics via SNMP

##### Configuration

A configuration tool is included in the scope of delivery of the software package.



Ordering data	Article No.	Article No.
<p><b>SOFTNET-IE RNA</b></p> <p>Software for connecting PCs to PRP-enabled networks with integrated SNMP, runtime software, software and electronic manual on CD-ROM, license key on USB flash drive, Class A</p> <p><i>For CP1612 A2</i></p> <p><b>SOFTNET-IE RNA V12</b></p> <p>For 32/64-bit Windows 7 Professional/Ultimate; for 64-bit Windows 2008 Server R2; for 32/64-bit Windows 8 Pro; for Windows Server 2012 German/English</p> <ul style="list-style-type: none"> <li>• Single License for one installation</li> </ul> <p><b>Software Update Service</b></p> <p>For 1 year with automatic extension; requirement: current software version</p> <p>Upgrade</p> <ul style="list-style-type: none"> <li>• From V8.1 to V12</li> </ul>	<p><b>6GK1711-1EW12-0AA0</b></p> <hr/> <p><b>6GK1711-1EW00-3AL0</b></p> <hr/> <p><b>6GK1711-1EW00-3AE0</b></p>	<p><b>SCALANCE X-200RNA Industrial Ethernet network access points</b></p> <p>Industrial Ethernet network access points with integrated SNMP access, web diagnostics and PROFINET diagnostics, for connecting non-PRP-enabled terminal equipment to PRP networks; incl. operating instructions, Industrial Ethernet network manual and configuration software on CD-ROM; with electrical and optical ports for glass multimode fiber-optic cable up to 5 km</p> <ul style="list-style-type: none"> <li>• <b>SCALANCE X204RNA</b> with four 100 Mbit/s RJ45 ports</li> <li>• <b>SCALANCE X204RNA EEC</b> with two 100 Mbit/s RJ45 ports and two RJ45/SFP combo ports</li> </ul> <p><b>CP 443-1 RNA communications processor</b></p> <p>for connecting the SIMATIC S7-400/S7-400H CPU to Industrial Ethernet</p>
		<p><b>6GK5204-0BA00-2KB2</b></p> <p><b>6GK5204-0BS00-3LA3</b></p> <hr/> <p><b>67443-1RX00-0XE0</b></p>

# PROFINET/Industrial Ethernet

## Communication for PC-based systems

### SOFTNET PN IO

#### Overview

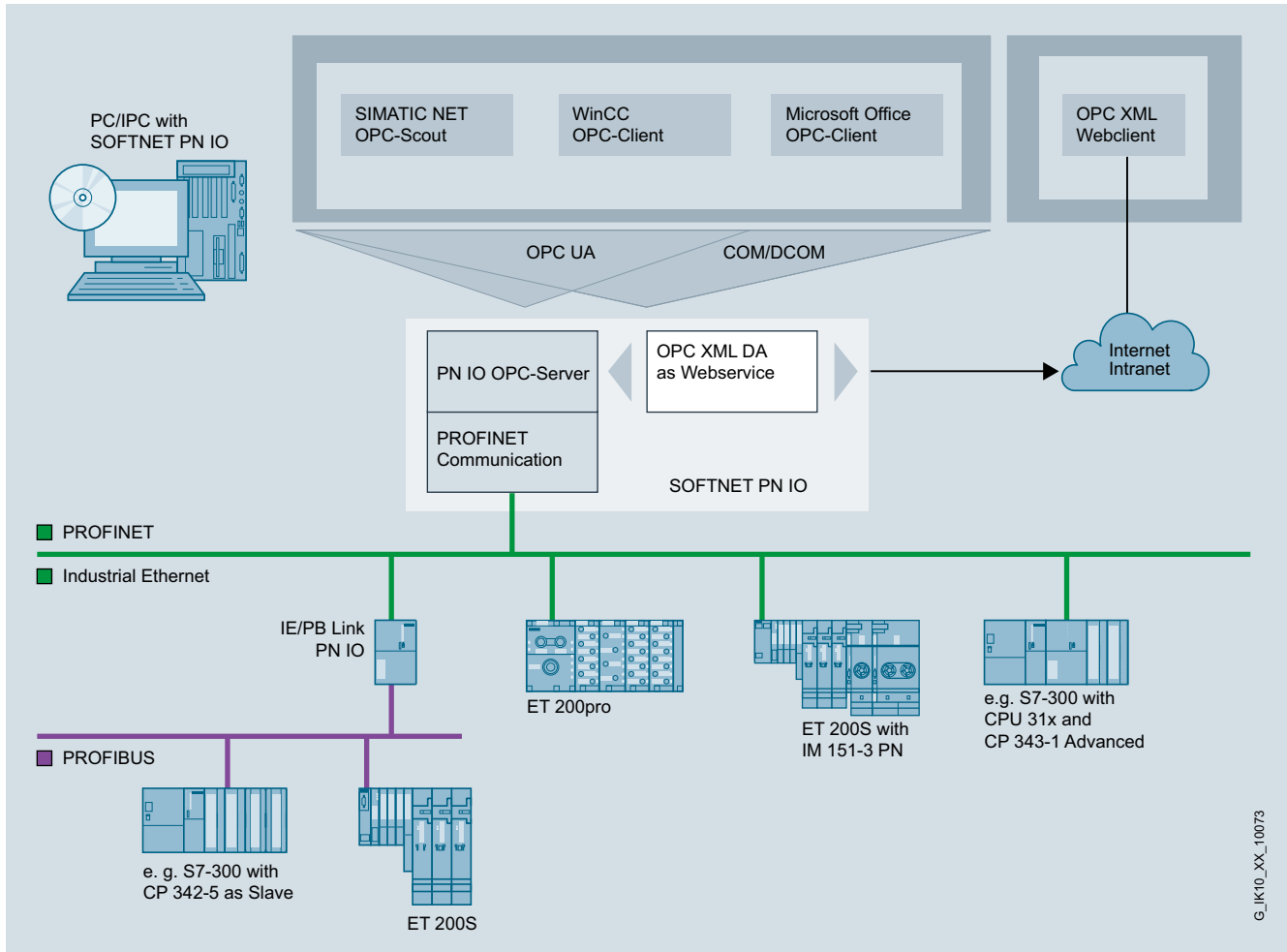

PC with SOFTNET PN IO as PROFINET IO Controller

ISO	TCP/UDP	PN	MRP	OPC	PG/OP	S7/S5	IT
	●	●		●			

#### Benefits



- Software with PROFINET IO Controller function for coupling PG/PC and IPC with PROFINET IO Devices
- Possible applications:
  - PC-based control systems
  - HMI systems
  - Test applications
- Communication services:
  - PROFINET IO controller
- Can be used with
  - Layer 2 Ethernet card (PCI/PCIe), e.g. CP 1612 A2
  - Integral Industrial Ethernet interfaces of SIMATIC programming devices/PCs
- Cost-effective solution for the low-end performance range
- OPC server for I/O connection over PROFINET included in scope of delivery

- Cost-effective interfacing of field devices to Industrial Ethernet with PROFINET
- Simple porting of the application with OPC as a standard interface
- High-performance IO data access through RT Base interface for linking into C/C++ applications
- Simple changeover from PROFIBUS modules CP 5613 A2/CP 5614 A2 with DP-Base interface to PROFINET through IO-Base interface
- Uniform procedure and configuration functions for NCM PC and STEP 7

G\_IK10\_XX\_10073

### Application



Using SOFTNET PN IO, PCs can be linked with PROFINET field devices including PC-based PN IO devices (e.g. with CP 1616 or CP 1604) via Industrial Ethernet.

SOFTNET PN IO is available for the following interfaces:

- CP 1612 A2
- Integral Industrial Ethernet interfaces of SIMATIC programming devices/PCs

### Function

#### **PROFINET communication**

##### *PROFINET IO controller*

Connection of field devices to Industrial Ethernet with PROFINET

#### **User interfaces**

##### *OPC interface*

The supplied OPC server can be used as a standard programming interface for PROFINET IO controller to link automation applications to OPC-capable Windows applications (Office, HMI systems, etc.).

##### *Programming interface via C Library;*

For applications that want to use the PROFINET IO controller functionality directly over C/C++, the IO-Base interface can be used. This interface is of a similar design to the DP Base interface of PROFIBUS modules CP 5613 A2 and CP 5614 A2. It is therefore possible to port existing PROFIBUS DP master applications to PN IO-Controller applications.

The released compilers can be found in the readme file of the SIMATIC NET CD products at <http://www.siemens.com/automation/csi/net>.

SOFTNET PN IO and CP 1616 use compatible functions of the IO-Base interface.

#### **Mode of operation**

With SOFTNET, the complete protocol stack is processed in the PC. This architecture means that the performance depends on the configuration of the PC used or the loading on the PC.

#### **Configuration**

Configuration is performed with STEP 7/NCM PC

### Technical specifications

Product-type designation	SOFTNET PN IO
<b>Performance data</b>	
• Number of operable IO devices	Max. 64
• Number of external IO-lines in one central rack	Max. 1
• Size of IO data areas overall	
- I/O input area	Max. 2 KB
- I/O output area	Max. 2 KB
• Size of I/O data area per connected I/O device	
- I/O input range	Max. 1 433 byte
- I/O output range	Max. 1 433 byte

### Ordering data

#### Article No.

<b>SOFTNET PN IO</b> Software for PROFINET IO Controller with OPC server and NCM PC / STEP7 Professional V12, runtime software, software and electronic manual on CD-ROM, license key on USB flash drive, Class A	
<b>SOFTNET-IE PN IO V12</b> for 32/64-bit Windows 7 Professional/Ultimate for Windows 2008 Server R2 for 32/64 Bit Windows 8 Pro for Windows Server 2012 German/English • Single License for one installation	<b>6GK1704-1HW12-0AA0</b>
<b>Software Update Service</b> for 1 year with automatic extension Requirement: current software version	<b>6GK1704-1HW00-3AL0</b>
<b>Upgrade</b> • from Edition 2006 to SOFTNET PN IO Edition 2008 or V12 • from V6.0, V6.1, V6.2 or V6.3 to SOFTNET PN IO Edition 2008 or V12	<b>6GK1704-1HW00-3AE0</b>  <b>6GK1704-1HW00-3AE1</b>

## PROFINET/Industrial Ethernet

### Communication for PC-based systems

#### OPC server for Industrial Ethernet

#### Overview

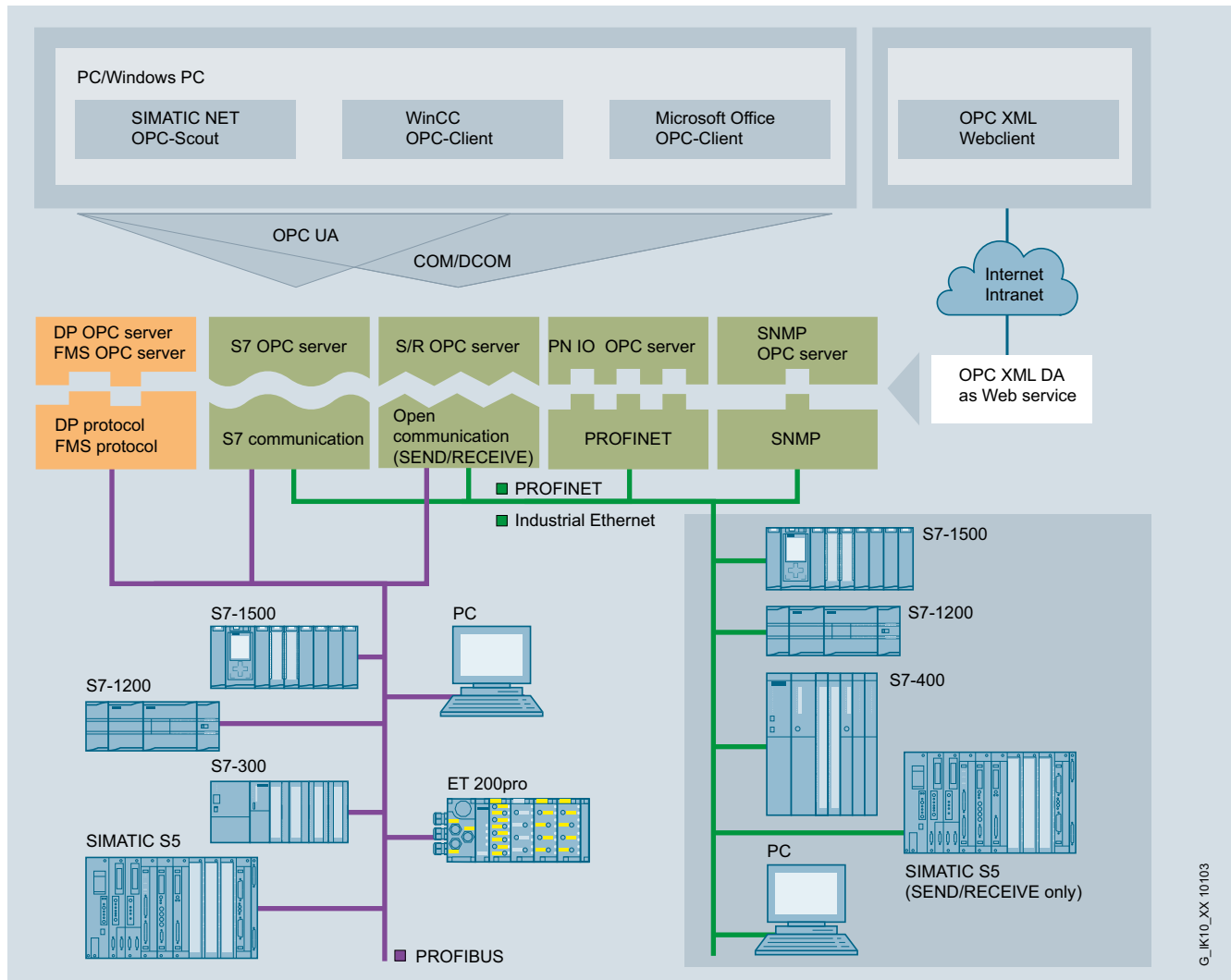

System integration with OPC server

OPC (**O**penness, **P**roductivity & **C**ollaboration) is a standardized, open, and vendor-independent interface that is widely used in automation.

A fundamental distinction is made between the classic OPC and its consistent further development OPC UA (**U**nified **A**rchitecture). Smooth migration to the new OPC UA standard is easily possible; this offers further value added, such as security. The SIMATIC NET OPC servers offer the two interfaces OPC UA and classic OPC for SIMATIC S7 and PROFINET.

- The corresponding OPC servers are included in the scope of supply of the respective communication software
- Standardized, open, multi-vendor interface
- It permits interfacing of OPC-capable Windows applications to S7 communication, open communication (SEND/RECEIVE), PROFINET, and SNMP
- Increased availability thanks to additional option packages such as OPC server redundancy
- OPC Scout with browser functionality as an OPC client and OCX Data Control/.NET Data Control for simple OPC client creation

#### Benefits

get **Designed for Industry**

- Simple use of different networks and protocols through uniform interface
- Reduced training and familiarization overhead
- Increased availability of the plant information by means of redundant SIMATIC NET OPC server
- Simple integration into the system environment and office applications via C++, Visual Basic- and .NET interfaces
- Short setup times for applications
- Simple handling and cost effective since the appropriate OPC servers are included in the scope of supply of the respective communication software

G\_IK10\_XX 10103

#### Application

The basic principle of OPC is that OPC client applications communicate with the OPC server over a standardized, open and manufacturer-independent interface.

It is also possible to connect to OPC-capable Windows applications (Microsoft Office or HMI systems) that are already available on the market.

The following communication possibilities are available for Industrial Ethernet with OPC server:

- S7 communication
- Open communication (SEND/RECEIVE)
- PROFINET
- SNMP (Simple Network Management Protocol)

The OPC server offers, for example:

- Data Access interfaces 2.0, 2.05a and 3.0
- Alarm and event interface 1.1
- OPC XML DA interface 1.0
- Integration of automation products of different manufacturers
- Uniform, easy user interface for different components
- Can be accessed from every computer in the LAN
- High-performance data access over the Custom Interface (C++, NET)
- Easy to use with the "Automation Interface" (VB, NET) or the supplied OCX Data Control or .NET Data Control
- Grouping of variables (Items); which allows a large quantity of data to be pre-processed in a short time.
- Optional redundancy expansion for S7 communication

#### Function

- Optimized data block access to S7-1500
- Open standardization of the addressing using logical names for objects from an automation component or an automation system
- Supports STEP 7 symbols
- Efficient data transfer from a process component to an application for further processing
- One client application can use several servers simultaneously
- Simultaneous execution of more than one client is possible on one OPC server
- Communication protocols can be used in parallel by means of the multiplexer function

- Interfaces
  - "Custom Interface" for high-performance C++/NET applications
  - "Automation Interface" for easily created Visual Basic applications (or similar)
  - XML DA interface; Data access to S7 CPUs is therefore possible over the Internet.
  - OCX Data Control or .NET Data Control for direct integration in Windows applications that support COM/DCOM

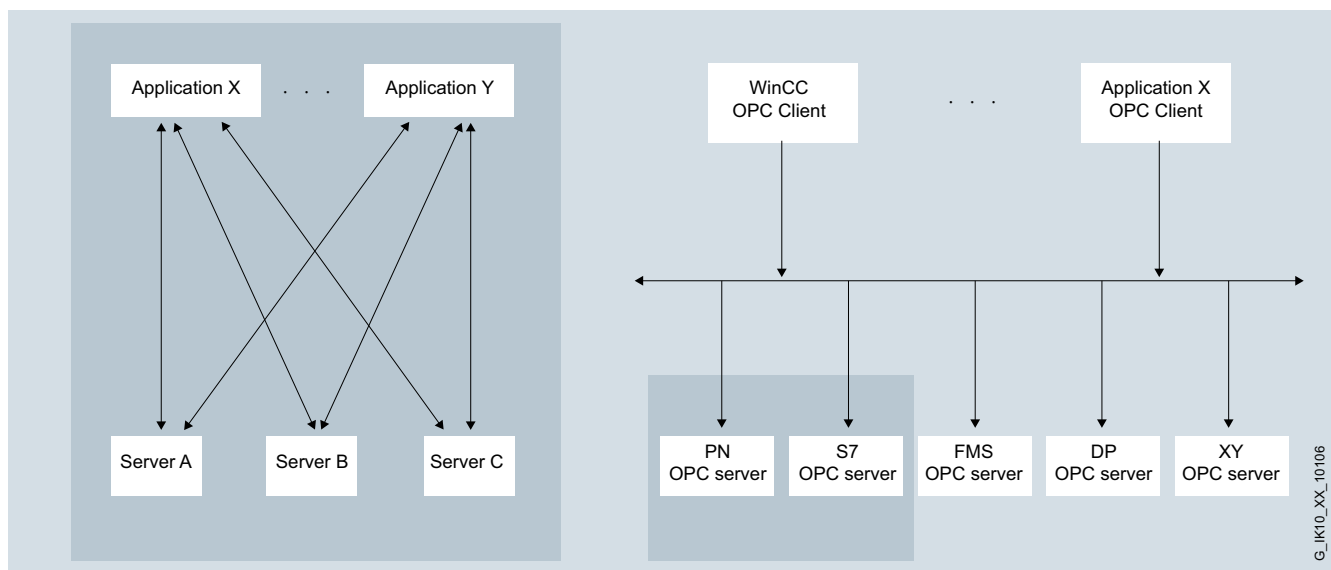

Comparison of conventional client/server architecture with an OPC architecture

#### Configuration

The communication parameters are configured entirely using the tools of the installed SIMATIC NET software

# PROFINET/Industrial Ethernet

## Communication for PC-based systems

### OPC server for Industrial Ethernet

#### Technical specifications

Product-type designation	OPC-Server für Industrial Ethernet
Programming	<ul style="list-style-type: none"> <li>• Synchronous and asynchronous reading and writing of variables</li> <li>• Monitoring of variables using the OPC server with a signal to the client when a change occurs</li> <li>• Use of quantity operations; so a large amount of data can be processed in a short time.</li> </ul>
Interfaces	<ul style="list-style-type: none"> <li>• Custom Interface (C++, NET) for high OPC performance</li> <li>• Automation Interface (VB, Excel, Access, Delphi, ...) for ease-of-use</li> <li>• Graphics with OCX or .NET Data Control; for configuring instead of programming</li> <li>• OPC XML-Interface for Data Access</li> </ul>
<b>Products</b>	
Industrial Ethernet	<b>include OPC servers for:</b>
<ul style="list-style-type: none"> <li>• HARDNET-IE S7, SOFTNET-IE S7, SOFTNET-IE S7 Lean</li> </ul>	S7 OPC server for S7 communication, XML-DA S5 OPC server for open communication <sup>1)</sup> communication, XML-DA
<ul style="list-style-type: none"> <li>• SNMP OPC server</li> </ul>	SNMP OPC server for SNMP protocol access; XML-DA
<ul style="list-style-type: none"> <li>• S7 OPC Redundancy</li> </ul>	Redundant S7-OPC server for S7 communication
PROFINET	
<ul style="list-style-type: none"> <li>• SOFTNET-IE PN IO</li> </ul>	PN IO OPC server for PROFINET IO communication; XML-DA
PROFIBUS	
<ul style="list-style-type: none"> <li>• HARDNET-PB DP, SOFTNET-PB DP, SOFTNET-PB DP slave</li> </ul>	DP-OPC server for PROFIBUS DP communication; XML-DA
<ul style="list-style-type: none"> <li>• FMS-5613</li> </ul>	FMS-OPC server for PROFIBUS FMS communication; XML-DA
<ul style="list-style-type: none"> <li>• HARDNET-PB S7, SOFTNET-PB S7</li> </ul>	S7-OPC server for S7 communication, XML-DA
<ul style="list-style-type: none"> <li>• S7 OPC Redundancy</li> </ul>	Redundant S7-OPC server for S7 communication

<sup>1)</sup> also S5-compatible communication

#### Ordering data

#### Article No.

##### SNMP OPC server

Status monitoring of SNMP-capable devices in any OPC client systems; e.g. SIMATIC WinCC/PCS 7

See SNMP OPC server

##### S7 OPC Redundancy

Software for redundant OPC servers in the environment of Industrial Ethernet software, S7 products, runtime software, software and electronic manual on CD-ROM, license key on USB flash drive, Class A

##### S7 OPC Redundancy V12

for 64-bit: Windows 2008 Server R2; German/English

- Single License for one installation

**6GK1706-1CW12-0AA0**

##### Software Update Service

For 1 year with automatic extension; requirement: current software version

**6GK1706-1CW00-3AL0**

#### Overview

OPC (**O**penness, **P**roductivity & **C**ollaboration) is a standardized, open, and vendor-independent interface that is widely used in automation. OPC UA (**U**nified **A**rchitecture) is the result of consistent further development of this standard, offering additional functions such as security or redundancy.

S7 OPC Redundancy is a software product compliant with the OPC UA standard that enables the redundant configuration of OPC UA servers to SIMATIC S7. The availability of automation data to operator control and monitoring systems is guaranteed thanks to the redundant use of OPC UA servers. This requires neither additional cabling for synchronizing the redundant OPC UA servers, nor additional programming overhead in the PC. The OPC UA servers are synchronized via high-performance Industrial Ethernet network access points at 10/100 and 1 000 Mbps. S7 OPC Redundancy represents an integrated customer solution for all SIMATIC NET S7 SOFTNET and HARDNET software products in the automation world.

#### Benefits

- Enhanced plant availability thanks to redundant OPC UA servers that ensure plant access for operator control and monitoring systems
- Secures investments thanks to the use of existing applications (OPC clients) and flexible application options, regardless of the SIMATIC S7 controller used
- Improved utilization of IT resources thanks to even distribution of the OPC clients among the redundant OPC servers

#### Application

The redundant OPC UA server software enables redundant configuration of SIMATIC NET OPC UA servers. Failure of one OPC UA server, as a result of power outage or system failure, for example, results in immediate use of the other OPC UA server, and continuation of the existing OPC UA client connection. This ensures increased availability of automation data to operator control and monitoring systems.

#### Design

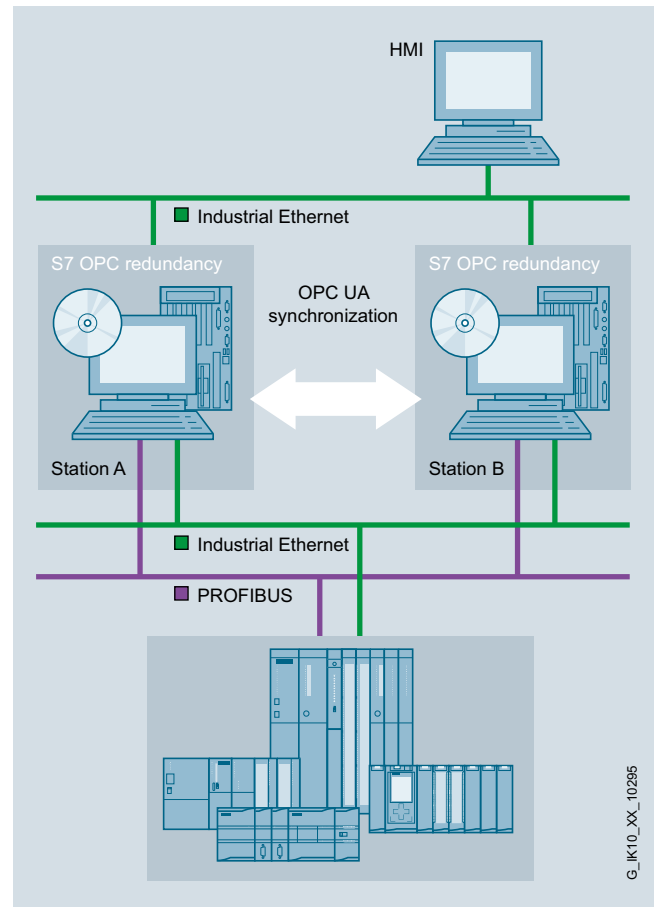

Redundant use of OPC servers

A redundant OPC UA server system comprises the following:

#### Server PC with

- Operating system for Windows server
- SOFTNET-IE S7 or HARDNET-IE S7 software based on OPC UA server
- S7 OPC Redundancy software

The redundant operation of up to two OPC UA servers is possible.

#### Client PC (HMI)

- Software for OPC clients that supports OPC UA (incl. reconnect functionalities in accordance with OPC UA specification)

The communication parameters are configured using STEP 7 or SIMATIC NET NCM PC. A configuration tool is included in the scope of delivery of the corresponding packages.

## PROFINET/Industrial Ethernet

### Communication for PC-based systems

#### S7 OPC Redundancy for Industrial Ethernet

##### Function

S7 OPC Redundancy enables the setup of redundant OPC UA servers, thus ensuring plant access for the operator control and monitoring systems.

This means, for example, that the information synchronization between two SIMATIC NET S7 OPC servers via the S7 OPC Redundancy software package is guaranteed. This is handled transparently for the OPC Client application so that in the event of a fault, the redundant OPC server takes over the tasks from the failed OPC server system.

Data exchange between the OPC clients and the OPC servers takes place via the standardized OPC UA communication. Communication with the SIMATIC S7 controller takes place using the S7 protocol. This is ensured by the software products SIMATIC NET SOFTNET or HARDNET-S7 for Industrial Ethernet that are necessary as the basis for SIMATIC NET IE S7 OPC Redundancy.

The S7 OPC Redundancy software package supports:

- High availability;  
Failure of one OPC UA server results in immediate use of the other OPC UA server, and continuation of the existing OPC UA client connection. The basis for this is the OPC UA synchronization that ensures synchronization of the necessary client information.
- Load compensation;  
Even distribution of OPC clients among the available OPC servers

##### Configuration

A configuration tool is included in the scope of delivery of the software package.

##### Ordering data

###### *S7 OPC Redundancy*

Software for redundant OPC servers in the environment of Industrial Ethernet software, S7 products, runtime software, software and electronic manual on CD-ROM, license key on USB flash drive, Class A

###### **S7 OPC Redundancy V12 for Industrial Ethernet**

for 64-bit: Windows 2008 Server R2;  
German/English

- Single License for one installation

##### Article No.

**6GK1706-1CW12-0AA0**



### Overview

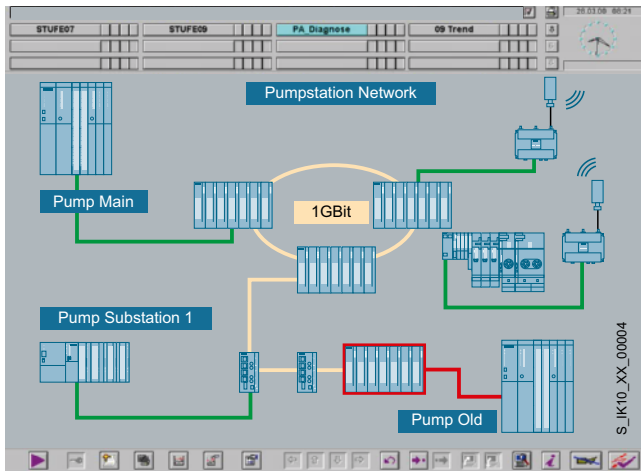

- Status monitoring of SNMP-capable devices in any OPC client systems; e.g. SIMATIC WinCC/PCS 7
- Easy access to SNMP-capable devices over the OPC interface
- Devices without SNMP agents can be monitored using the ping mechanism
- Configuration with STEP 7 (up to STEP 7 V5.5) or NCM PC
- Ready-to-use SNMP diagnostics profiles for Siemens devices, e.g. SCALANCE X/W
- Generation of any SNMP diagnostics profiles by means of the integral MIB compiler
- Easy setup of the monitored devices with the help of an Autodiscovery function

### Benefits



- Network view and process view in a single system
- Easy network diagnostics in SIMATIC HMI/SCADA systems and office applications
- Easy configuration and engineering without the need for detailed knowledge of SNMP: embedded in the SIMATIC tool landscape
- It can operate in parallel with other communication protocols

### Application

The SNMP OPC server makes data available for the administration of TCP/IP networks for any OPC client systems.

SNMP (Simple Network Management Protocol) is a protocol that has been specifically designed for administration of TCP/IP networks. The individual nodes in the network (network components or data terminals) are equipped with a so-called SNMP agent that provides information in structured form.

OPC (Openness, Productivity & Collaboration) provides a standardized, open, multi-vendor interface for automation engineering.

The SNMP OPC server supports access to device information over the OPC interface. This means that network visualization, system diagnostics and plant status monitoring can be implemented in any OPC client systems (with OPC clients such as WinCC, WinCC flexible, PCS 7). In addition to simple device diagnostics, detailed information such as redundant network structures or network load distribution can be displayed. This increases the operational safety and improves the availability of the plant.

The device information can be visualized according to individual requirements and can be adapted to the special requirements of the respective customer installation. The information that is made available can also be integrated into the signaling system and alarm log of an HMI/SCADA system for example.

Using the SNMP information, it is possible to expand an existing HMI/SCADA system as far as a customer-specific network management station.

The SNMP OPC server can be operated over the following interfaces:

- CP 1613 A2 (PCI)
- CP 1623 (PCIe)
- CP 1628 (PCIe)
- Integrated Industrial Ethernet interface or CP 1612 A2

## PROFINET/Industrial Ethernet

### Communication for PC-based systems

#### SNMP OPC server

##### Function

The SNMP OPC server supports access to SNMP-capable devices in the OPC client systems. For all configured TCP/IP devices that are not SNMP-capable, one OPC variable for sign-of-life monitoring (ICMP-PING) is offered.

Read access and in part write access to the respective device information is possible. Thus the diagnosis of individual devices is possible as well as diagnosis of the complete plant and device characteristics can be actively controlled.

STEP 7/NCM PC contains an MIB compiler (Management Information Base) for integrating SNMP-enabled devices. This allows device profiles to be created on the basis of an MIB file

##### Devices with SNMP agents:

SIMATIC NET devices that feature special SNMP agents such as switches, WLAN Access Points and Industrial Ethernet PC and S7 communication processors are already included complete with their device profiles.

Thanks to MIB compilers (Management Information Base), other SNMP-enabled devices can be integrated into the OPC configuration through loading of MIBs in accordance with the SMI V1 and SMI V2 standard from STEP 7 V5.4.

##### Devices with IP addresses without SNMP agents:

Devices without SNMP agents can be monitored using the ping mechanism. The user can edit and save device-specific information such as the contact person, site and device description for this purpose.

- Any SNMP-capable devices such as printers or PCs can be depicted using a predefined library.
- The devices are integrated into the desktop of a client application using preconfigured ActiveX Controls.

The predefined device profiles and the associated ActiveX controls allow easy administration of the devices in OPC client applications. Individual expansions can also be implemented.

The SNMP OPC server is integrated in the SIMATIC NET OPC server. The OPC Scout is also included in the functional scope for browsing the displayed SNMP information. The SNMP OPC server can use, for example, PROFINET or S7 communication at the same time as PROFIBUS and Industrial Ethernet communication. This means that existing installations can also be expanded with SNMP functionality. The SNMP OPC server also enables several clients to execute simultaneously on one server.

##### User interfaces

- "Custom Interface" for high-performance C++ applications
- "Automation Interface" for easily created Visual Basic applications (or similar).
- OPC Data Control for easy creation of client applications by configuring ActiveX controls
- OPC Alarms & Events (Subset)
- Preconfigured ActiveX controls for the device profile used

##### Configuration

Configuration and engineering with STEP 7 (up to STEP 7 V5.5) or NCM PC (e.g. component SIMATIC NET DVD V8.2; Order No.: 6GK1700-0AA12-3AA0)

##### Ordering data

##### Article No.

###### SNMP OPC server

Including MIB compiler; single license for one installation of runtime software; software and electronic manual on CD-ROM; license key on USB stick, Class A

###### SNMP OPC Server Basic

Administration of up to 20 IP addresses

- **Basic V12** for 32/64-bit: Windows 7 Professional/Ultimate for 64-bit:
- Windows 2008 Server R2 for 32/64-bit: Windows 8 Pro for Windows Server 2012 Single License for one installation

6GK1706-1NW12-0AA0

###### Software Update Service SNMP OPC Server Basic

for 1 year with automatic extension  
Requirement: current software version

6GK1706-1NW00-3AL0

###### Upgrade SNMP OPC Server Basic

- from Edition 2006 to Edition 2008 or V12
- from V6.0, V6.1, V6.2 or V6.3 to Edition 2008 or V12

6GK1706-1NW00-3AE0

6GK1706-1NW00-3AE1

###### SNMP OPC Server Extended

Administration of up to 200 IP addresses

- **Extended V12** for 32/64-bit: Windows 7 Professional/Ultimate for 64-bit: Windows 2008 Server R2 for 32/64-bit Windows Pro for Windows Server 2012 Single License for one installation

6GK1706-1NX12-0AA0

###### Software Update Service SNMP OPC Server Extended

for 1 year with automatic extension  
Requirement: Current software version

6GK1706-1NX00-3AL0

###### Upgrade SNMP OPC Server Extended

- from Edition 2006 to Edition 2008 or V12
- from V6.0, V6.1, V6.2 or V6.3 to Edition 2008 or V12

6GK1706-1NX00-3AE0

6GK1706-1NX00-3AE1

###### SNMP OPC Server Power Pack

for upgrade from SNM OPC Server Basic to SNM OPC Server Extended

###### PowerPack V12

6GK1706-1NW12-0AC0

### Overview

- Software for connecting SIMATIC S7
- Provision of S7 communication via SAPI-S7 interface
- Support of ISO and TCP/IP (RFC 1006) protocol
- Available on Linux operating systems
- Simultaneous operation of several cards

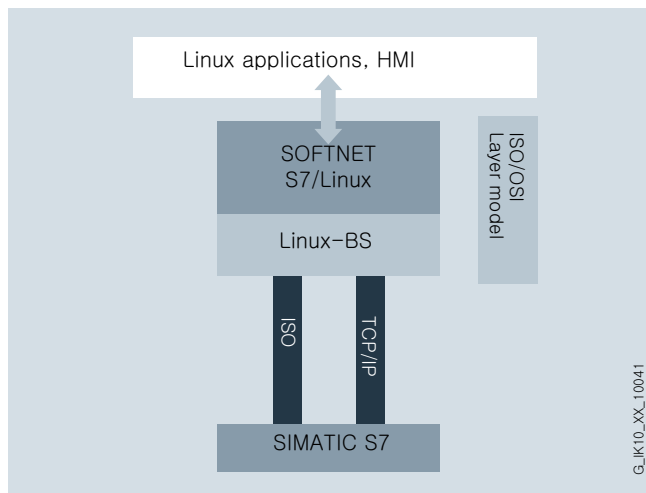

SOFTNET-S7/Linux system configuration

### Benefits

**get** Designed for Industry

- High-speed communication with the S7 based on the S7 protocol
- Cost-saving programming thanks to user-friendly and simple interface
- Flexible in use thanks to hardware-independent software

### Application

For Linux systems, Siemens offers high-speed communication with the SIMATIC S7 for Industrial Ethernet based on the S7 protocol.

SAPI-S7 (Simple Application Programmer Interface) provides you with a user-friendly call interface for communication between HMI systems or other Linux applications and the SIMATIC S7.

### Function

SOFTNET uses internal standard interfaces of the operating system for accessing the Ethernet connections. This supports the interface cards enabled by the operating system. Simultaneous operation of several cards is possible.

During communication, you can choose between the protocols ISO and TCP/IP with RFC1006 for each connection.

The SOFTNET products offer the user diagnostics and trace functions.

### SOFTNET-S7/Linux functions

SIMATIC S7 system components communicate with each other using S7 communication functions. The programming interface SAPI-S7 (Simple Application Programmer Interface) is available for Linux operating systems as well as for the Windows operating systems.

S7 communication offers the following services:

- Administrative services
- Variable services
- BSEND/BRECV

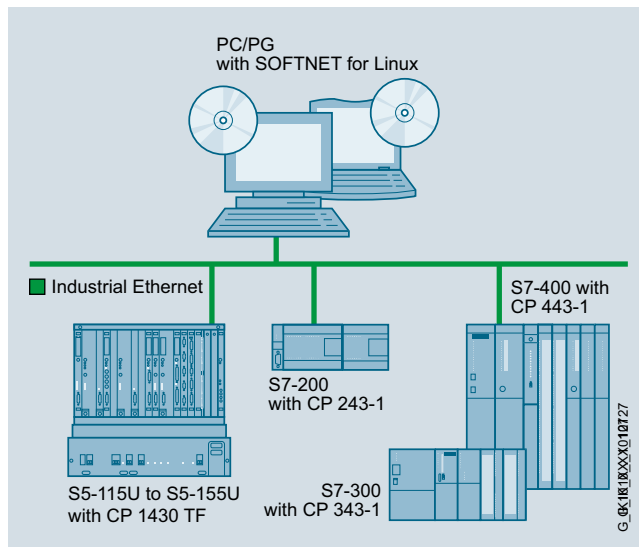

SOFTNET-S7/Linux system configuration

### Ordering data

### Article No.

#### SOFTNET-S7/Linux for Industrial Ethernet

Software for S7 communication for SIMATIC S7 including Level 4 interface over ISO or TCP/IP, single license for 1 installation, runtime software, software and electronic manual on CD-ROM, license key by fax, Class A, German/English  
Version 4.x

**2XV9450-1CG00**

#### SOFTNET-S7/Linux Lean

max. 8 connections

The original distributions of SUSE and RedHat Linux are supported. Please contact your Siemens contacts for information about the latest versions and their variants (32-bit and 64-bit).

**2XV9450-2CG00**

### More information

Support for Linux distributors:  
Contact for sales, service and training can be found at:  
[www.siemens.com/simatic-net/ik-info](http://www.siemens.com/simatic-net/ik-info)

## PROFINET/Industrial Ethernet

### Communication for PC-based systems

#### SOFTBUS for Linux

##### Overview

- Integrated communication
- Cross-computer communication
- Uniform interface
  - Link to ERP and DB systems
  - To SIMATIC S7

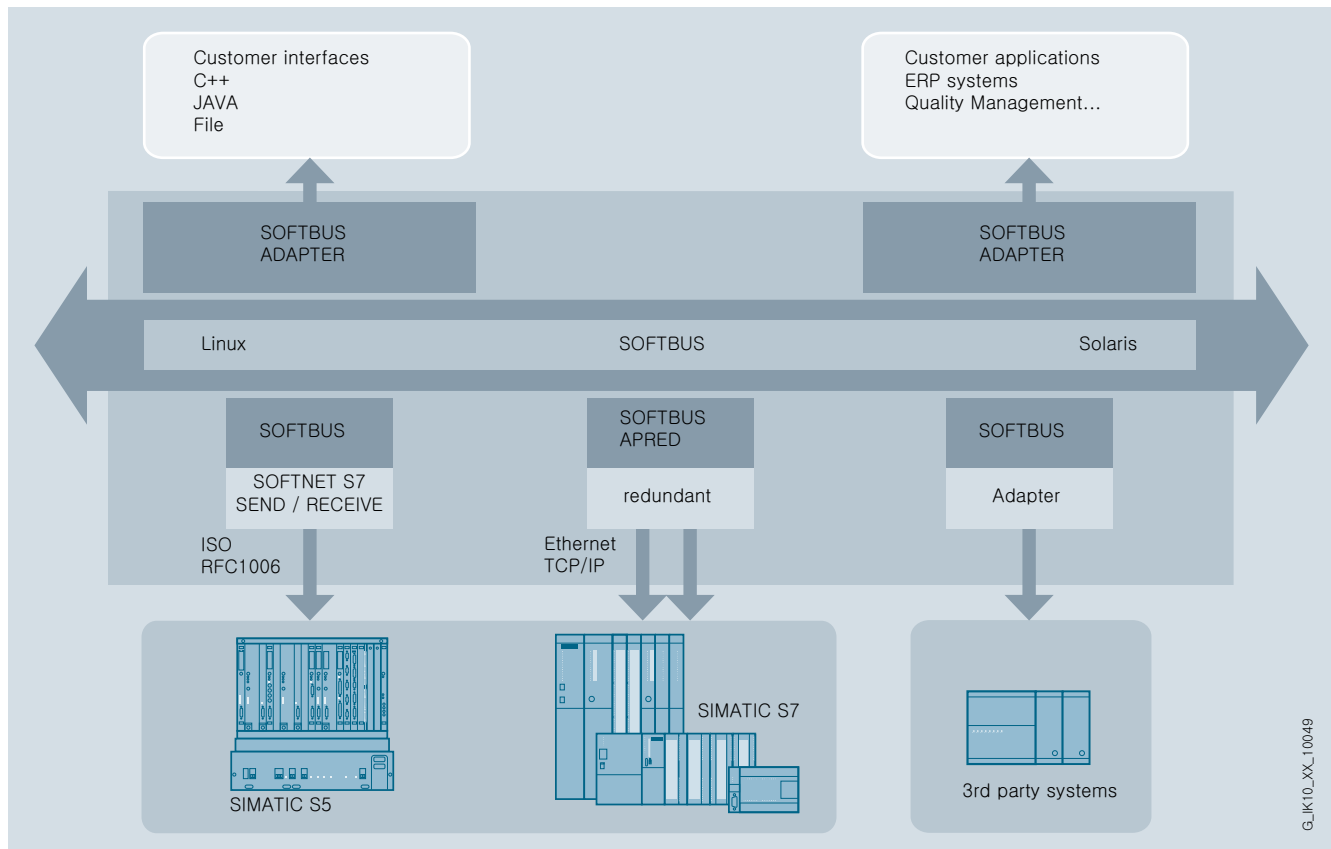

System configuration for SOFTBUS-SOFTNET

##### Benefits



- Communication across the system with standardized interface.
- Incorporation of ERP and DB systems.
- Interfacing of SIMATIC control systems
- Fast and automatic data flow

##### Application

The process landscape in industrial companies is frequently a product of historical developments. Thus there are many isolated solutions that function optimally within their own terms of reference but operate in a vacuum.

Integrating these requires a smooth, loss-free and integrated communication system. Only this guarantees that the right information arrives at the right place and at the right time.

SOFTBUS together with SOFTNET-S7 consists of matched modules that are available on the commonly used system platforms and thus ensure smooth communication between the system platforms.

G\_LK10\_XX\_10049

### Function

#### **SOFTBUS functions**

SOFTBUS comprises software modules that can be used on all commonly available computer systems (Windows, Linux).

The modules are compatible and have been adapted to standards such as SIMATIC NET and thus secure vertical integration with short start-up times.

#### **Interfaces**

Thanks to the combination of different modules, all commonly used platforms can be supported and linked together heterogeneously or homogeneously.

The programming interface of SOFTBUS is identical to the WVS-KOM interface of the SIPAX package.

This means that SIPAX applications can migrate to SOFTBUS without any problems.

### Ordering data

### Article No.

#### **SOFTBUS**

Version 2.3

#### **SOFTBUS Linux**

- SOFTBUS/Linux redundant (TCP) (32 bit)
- SOFTBUS/Linux redundant (ISO) (32 bit)
- SOFTBUS/Linux (TCP) (32 bit)
- SOFTBUS/Linux (ISO) (32 bit)

Please contact your Siemens contacts for information about the latest versions and their variants (32-bit and 64-bit).

**2XV9450-1CG02**

**2XV9450-1CG04**

**2XV9450-1CG08**

**2XV9450-1CG10**

### More information

Support for Linux distributors can be found at:  
[www.siemens.com/simatic-net/ik-info](http://www.siemens.com/simatic-net/ik-info)

# PROFINET/Industrial Ethernet

## Communication for PC-based systems

### Software

#### Ordering data

#### Article No.

#### Article No.

##### Software

#### SOFTNET Security Client V4

6GK1704-1VW04-0AA0

Software for designing secure IP-based VPN connections from a programming device/PC to network segments which are secured by SCALANCE S in bridge mode; Single license for 1 installation, runtime software (German/English), configuring tool (German/English) and electronic manual on CD-ROM (German/English/French/Italian/Spanish) for 32-bit Windows, XP Professional + SP1, SP2, SP3; for 32/64-bit Windows 7 Ultimate/Business

For CP 1612 A2

#### Upgrade

- From V3.0 to SOFTNET Security Client V4
- From Edition 2008+HF1 to SOFTNET Security Client V4

6GK1704-1VW00-0AE0

6GK1704-1VW00-0AE1

##### SOFTNET PN IO

Software for PROFINET IO Controller with OPC server and NCM PC, runtime software, software and electronic manual on CD-ROM, license key on USB stick, Class A,

For CP 1612 A2

#### SOFTNET-IE PN IO V12

for 32/64-bit: Windows Server 2012, Windows 8 Pro, Windows 7 Professional/Ultimate;  
for 64-bit: Windows 2008 Server R2 German/English

- Single License for one installation

6GK1704-1HW12-0AA0

#### Software Update Service

6GK1704-1HW00-3AL0

For 1 year with automatic extension; requirement: current software version

#### Upgrade

- From Edition 2006 to SOFTNET PN IO Edition 2008 or V12
- From V6.0, V6.1, V6.2 or V6.3 to SOFTNET PN IO Edition 2008 or V12

6GK1704-1HW00-3AE0

6GK1704-1HW00-3AE1

##### SOFTNET S7 for Industrial Ethernet

Software for S7 and open communication, including OPC server, PG/OP communication and NCM PC, runtime software, software and electronic manual on CD-ROM, license key on a USB stick, Class A

For CP 1612 A2

#### SOFTNET-IE S7 V12

for 32/64-bit:  
Windows Server 2012, Windows 8 Pro, Windows 7 Professional/Ultimate;  
for 64-bit:  
Windows 2008 Server R2;  
German/English

up to 64 connections

- Single License for one installation

6GK1704-1CW12-0AA0

#### Software Update Service

6GK1704-1CW00-3AL0

For 1 year with automatic extension; requirement: current software version

#### Upgrade

- From Edition 2006 to Edition 2008 or V12
- From V6.0, V6.1, V6.2 or V6.3 to Edition 2008 or V12

6GK1704-1CW00-3AE0

6GK1704-1CW00-3AE1

#### SOFTNET-IE S7 Lean Edition V12

Up to eight connections

- Single License for one installation

6GK1704-1LW12-0AA0

#### Software Update Service

6GK1704-1LW00-3AL0

For 1 year with automatic extension; requirement: current software version

#### Upgrade

- From Edition 2006 to Edition 2008 or V12
- From V6.0, V6.1, V6.2 or V6.3 to Edition 2008 or V12

6GK1704-1LW00-3AE0

6GK1704-1LW00-3AE1

#### Note:

The Windows XP software version is still available for older CPs; see the Industry Mall: [www.siemens.com/industrymall](http://www.siemens.com/industrymall)

Ordering data	Article No.	Ordering data	Article No.
<b>SOFTNET-IE PG for Industrial Ethernet</b> Software for PG/OP communication, runtime software, software and electronic manual on CD-ROM, license key on USB stick, Class A <i>For CP 1612 A2</i> <b>SOFTNET-IE PG V12</b> for 32/64-bit: Windows Server 2012, Windows 8 Pro, Windows 7 Professional/Ultimate; for 64-bit: Windows 2008 Server R2; German/English <ul style="list-style-type: none"> <li>• Single License for one installation</li> <li>• Single License for one installation</li> </ul>		<b>HARDNET-IE S7 for Industrial Ethernet</b> Software for S7 and open communication, incl. PG/OP communication, OPC server and NCM PC; up to 120 connections, runtime software, software and electronic manual on CD-ROM, license key on USB stick, Class A; for CP 1613/CP 1613 A2/CP 1623/CP 1628 <i>For CP 1613 A2, CP 1623, CP 1628</i> <b>HARDNET-IE S7 V8.2</b> for 32/64-bit: Windows Server 2012, Windows 8 Pro, Windows 7 Professional/Ultimate; for 64-bit: Windows 2008 Server R2 German/English <ul style="list-style-type: none"> <li>• Single License for one installation</li> </ul>	
<b>Software update</b> For 1 year with automatic extension; requirement: current software version	<b>6GK1704-1PW12-0AA0</b> <b>6GK1704-1PW71-3AA0</b> <b>6GK1704-1PW00-3AL0</b>	<b>Software Update Service</b> For 1 year with automatic extension; requirement: current software version	<b>6GK1716-1CB12-0AA0</b> <b>6GK1716-1CB00-3AL0</b>
<b>Upgrade</b> <ul style="list-style-type: none"> <li>• From Edition 2006 to Edition 2008 or V12</li> <li>• From V6.0, V6.1, V6.2 or V6.3 to Edition 2008 or V12</li> </ul>	<b>6GK1704-1PW00-3AE0</b> <b>6GK1704-1PW00-3AE1</b>	<b>Upgrade</b> <ul style="list-style-type: none"> <li>• S7-1613, Edition 2006 or higher, to S7-1613 Edition 2008 or HARDNET-IE S7 V12</li> <li>• from S7-1613 V6.0, V6.1, V6.2 or V6.3 to S7-1613 Edition 2008 or HARDNET-IE S7 V12</li> </ul>	<b>6GK1716-1CB00-3AE0</b> <b>6GK1716-1CB00-3AE1</b>

## PROFINET/Industrial Ethernet

### System interfaces for SIMATIC HMI

#### System interfaces with WinCC (TIA Portal)

##### Overview

The SIMATIC Basic Panel, Comfort Panel and Mobile Panel offer HMI functionality for the control systems:

- SIMATIC S7
- Non-Siemens controllers:
  - Allen Bradley
  - Mitsubishi
  - Modicon
  - Omron

For more detailed information, refer to the WinCC (TIA Portal) user manual, the "Windows-based systems communication" manual, or the WinCC (TIA Portal) online help.

OPC communication and HTTP communication are offered for all Panels with an integrated Ethernet interface. Both OPC and HTTP communication can be used in parallel with the process links to SIMATIC S7 or non-Siemens PLCs.

1) For the sake of simplicity, SIMATIC Panel is always used in the text below. This is not restrictive, as the information is valid for all systems referred to above. If there are constraints, direct reference is made to them in the text.

##### Note:

Interface options for HMI devices: See the individual device descriptions.

##### OPC communication

OPC Data Access is an open standard for exchanging both local and remote variables between various applications via Industrial Ethernet.

##### HTTP communication for variable exchange between SIMATIC HMI systems

Communication based on HTTP message frames enables variables to be exchanged between SIMATIC HMI systems.

Communication standard	SIMATIC HMI			
	Version	Comfort Panel	Mobile Panel 177 PN	Mobile Panel 277
<i>OPC Data Access V2.05a + OPC UA Data Access V1.01 + OPC Data Access XML V1.00</i>				
OPC DA client (COM/DCOM)	–	–	–	•
OPC DA server (COM/DCOM)	–	–	–	•
OPC UA DA client	•	–	–	•
OPC UA DA server (SOAP/XML)	•	–	–	•
<i>HTTP communication for variable exchange between SIMATIC HMI systems</i>				
HTTP client	•	•	•	•
HTTP server	•	•	•	•

- System interface possible
- System interface not possible



## Overview

The following types of interface are differentiated in respect of the link between the SIMATIC Panels and SIMATIC S7 controllers:

- **PROFINET interface:**  
Coupling of SIMATIC Panel to SIMATIC S7 controllers via Industrial Ethernet TCP/IP using the integrated PROFINET interface of the CPU or, alternatively, a PROFINET interface module.
- **MPI/PROFIBUS interface:**  
Coupling of SIMATIC Panel to SIMATIC S7 controllers via MPI/PROFIBUS using the integrated MPI/PROFIBUS interface of the CPU or the integrated PPI interface of the CPU in the case of S7-200 or, alternatively, a PROFIBUS interface module in the case of S7-1200, S7-1500, S7-300 and S7-400.
- **PPI interface:**  
Coupling of SIMATIC Panel to SIMATIC S7-200 via PPI network using the integrated PPI interface of the CPU

The maximum possible number of S7 connections of one CPU is determined by its performance capacity (see Catalog ST 70); from the point of view of SIMATIC Panel, the following restrictions apply:

- Basic Panel, Comfort Panel 4",  
Mobile Panel 177: max. 4 connections
- Comfort Panel 7" - 22": max. 8 connections
- Mobile Panel 277: max. 6 connections
- PC with WinCC Runtime Advanced: max. 8 connections

### **PPI interface**

The PPI interface is a point-to-point connection between a SIMATIC Panel (PPI master) or alternatively a PG (PPI master) and an S7-200 (PPI slave).

### **MPI/PROFIBUS interface or PROFINET interface**

The corresponding multipoint-enabled communication interfaces of SIMATIC Panels and SIMATIC S7 are used. The following are possible:

- Interface between one or more SIMATIC Panels (MPI master) and one or more S7-1200/S7-1500/S7-300/S7-400s or WinAC (MPI master) (possible network topology: MPI/PROFIBUS or Industrial Ethernet, TCP/IP)
- Interface between one or a number of SIMATIC Panels (MPI master) and one or a number of S7-200s (MPI slave)<sup>1)</sup> (possible network topology: PPI, MPI/PROFIBUS)

Unlike PPI connections, MPI connections are static connections that are set up during booting and then monitored.

The original format of a master/master link has been joined by a master/slave link, which has enabled integration of the S7-200 (except CPU 212).<sup>1)</sup>

In principle this type of information exchange between SIMATIC Panels and SIMATIC S7 is independent of the network used, PPI, MPI/PROFIBUS or Industrial Ethernet: SIMATIC Panels are S7 clients and SIMATIC S7 CPUs are S7 servers.

<sup>1)</sup> With regard to restricted baud transmission rates for S7-200, see Catalog ST 70.

# PROFINET/Industrial Ethernet

## System interfaces for SIMATIC HMI

### System interfaces with WinCC (TIA Portal)

#### SIMATIC S7

#### Overview (continued)

Controller	SIMATIC HMI				
	Basic Panel	Comfort Panel	Mobile Panel 177 DP <sup>1)</sup> Mobile Panel 177 PN <sup>1)</sup>	Mobile Panel 277 <sup>1)</sup> MP 177 MP 277 MP 377	WinCC Runtime Advanced
<b>Target hardware (PROTOCOL)</b> (physics)					
<i>SIMATIC S7-1200</i> <sup>2)</sup>					
over Ethernet (TCP/IP) to max. 4 x S7-1200	• <sup>3)</sup>	•	• <sup>3)</sup>	•	•
over MPI or PROFIBUS network to max. 4 x S7-1200 with PROFIBUS modul (DP-Master) CM 1243-5	• <sup>4)</sup>	•	• <sup>3)</sup>	•	• <sup>5)</sup>
<i>SIMATIC S7-300, -400, Win AC</i> <sup>2)</sup>					
over Ethernet (TCP/IP) to max. 4 x S7-300, -400, WinAC	• <sup>3)</sup>	•	• <sup>3)</sup>	•	•
over MPI or PROFIBUS network to max. 4 x S7-300, -400, WinAC	• <sup>4)</sup>	•	• <sup>4)</sup>	•	• <sup>5)</sup>

- System interface possible
- System interface not possible

<sup>1)</sup> Mobile Panel connection via special connecting cable and junction box (see Mobile Panel), see Manual for cable layout

<sup>2)</sup> Controllers can be combined as desired

<sup>3)</sup> Basic Panel PN and Mobile Panel 177 PN only

<sup>4)</sup> Basic Panel PN DP only or Mobile Panel 177 PN DP only

<sup>5)</sup> Connection via integrated MPI/PROFIBUS interface; in the case of a standard PC, a communications processor (CP) is to be used (e.g. CP 5611 A2)

#### Note:

Detailed information regarding cable layout can be found in the online help for WinCC.

## Overview

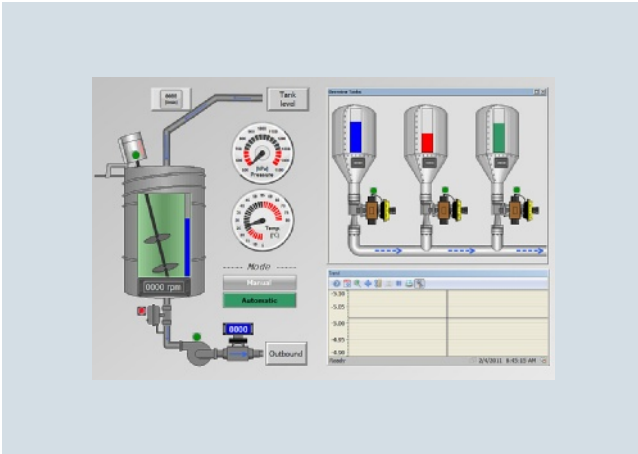

### ***SIMATIC WinCC Runtime Advanced visualization software***

- PC-based HMI solution for single-user systems directly at the machine
- Basic package for visualization, reporting and logging, user administration, can be expanded flexibly with VB scripts
- Basic package expandable by means of option packages
- Can be integrated into automation solutions based on TCP/IP networks
- Expanded service concepts with remote operation, diagnostics and administration over the intranet and Internet in combination with email communication

### ***SIMATIC WinCC Runtime Professional visualization software***

- PC-based operator control and monitoring system for visualization and operator control of processes, production flows, machines and plants in all sectors – from the simple single-user station through to distributed multi-user systems and cross-location solutions with web clients. WinCC Runtime Professional is the information hub for corporation-wide vertical integration.
- Industry-standard functions for signaling and acknowledging events, archiving of messages and measured values, logging of all process and configuration data, user administration, can be expanded flexibly with VB and C scripts
- Basic package expandable by means of option packages
- Also included are APIs for the Runtime to utilize the open programming interfaces

# PROFINET/Industrial Ethernet

## System interfaces for SIMATIC HMI

### System interfaces with WinCC (TIA Portal)

#### WinCC Runtime Communication

#### Overview

##### **Communication – SIMATIC WinCC Runtime Advanced**

WinCC Advanced is an open visualization system and offers the option of connecting the most diverse control systems.

##### Number of connectable controllers

WinCC Advanced permits the parallel coupling of up to 8 controllers.

Connection to third-party controllers

The following "Coupling overview" table lists third-party protocols and controllers which are directly supported by WinCC Advanced. Generally it is also possible to connect third-party controllers via OPC (OLE for Process Control).

Current notes and information about OPC servers from many different suppliers can be found at:

<http://www.opcfoundation.org/>

WinCC Advanced supports the standards:

- OPC Data Access 2.05a
- OPC UA Data Access 1.01
- OPC XML Data Access 1.00 (client via DCOM/XML gateway)

**Overview** (continued)**Coupling overview for WinCC Runtime Advanced**

Protocol	Description	PC interface
<i>SIMATIC HMI</i>		
<b>Ethernet TCP/IP (HTTP communication)</b>	HTTP communication for data exchange between SIMATIC HMI (client + server) <sup>1)</sup>	CP 1612 A2
<i>SIMATIC S7</i>		
<b>Ethernet TCP/IP (S7 communication)</b>	Channel for communication via Ethernet TCP/IP with max. 8 x SIMATIC S7 controllers S7-1200, S7-1500 S7-300, S7-400, S7-200 with CP 243-1	CP 1612 A2 CP 1613 A2 CP 1623
<i>SINUMERIK <sup>2)</sup></i>		
<b>Ethernet TCP/IP (S7 communication)</b>	Channel for communication via Ethernet TCP/IP with SINUMERIK 840D sl	CP 1612 A2 CP 1613 A2 CP 1623
<i>Third-party controllers (from WinCC V11.0) <sup>3)</sup></i>		
<b>Allen Bradley Ethernet IP</b>	Channel for communication with max. 4 x Allen Bradley controllers via Ethernet TCP/IP with Allen Bradley Ethernet IP protocol The controllers ControlLogix / CompactLogix, SLC500 / MicroLogix and PLC5 are supported	CP 1612 A2
<b>Allen Bradley DF1</b>	Channel for communication with Allen Bradley controllers via DF1 protocol The controllers SLC500 / MicroLogix and PLC5 are supported <sup>3)</sup>	COM1/COM2
<b>Mitsubishi MC TCP/IP</b>	Channel for communication with max. 4 x Mitsubishi controllers via Ethernet TCP/IP with Mitsubishi MC TCP/IP protocol The FX3, Q, and iQ/QnUD controller series are supported	CP 1612 A2
<b>Mitsubishi FX</b>	Channel for communication with Mitsubishi controllers via FX protocol The FX1N, FX2N controllers are supported	COM1/COM2
<b>Modbus TCP/IP</b>	Channel for communication with max. 4 x Modicon controllers via Ethernet TCP/IP using the Modbus TCP/IP protocol The Quantum, Momentum, Premium, TSX Micro, Compact and M340 controllers are supported	CP 1612 A2
<b>Modbus RTU</b>	Channel for communication with Modicon controllers via the Modbus RTU protocol The Quantum, Momentum, and Compact controllers are supported	COM1/COM2
<b>Omron Link / Multi Link</b>	Channel for communication with Omron controllers via the Link/Multi protocol The CP1x, CJ1x, CJ2H, CS1x, and CP2MC controllers are supported	COM1/COM2
<i>Cross-manufacturer</i>		
<b>OPC client <sup>1) 4)</sup> for OPC DA, OPC UA DA, XML DA</b>	Channel for OPC communication, WinCC can acquire data from OPC server applications	CP 1612 A2
<b>OPC server for OPC DA</b>	Server applications for OPC communication; WinCC provides process data to PC clients	CP 1612 A2

<sup>1)</sup> HTTP and OPC communication can be used in combination with the other couplings; regarding SIMATIC Panels that support HTTP or OPC communication, see the overview under "System interfaces (WinCC V11)".

<sup>2)</sup> "SINUMERIK Operate WinCC RT Advanced" license required; for further information, see NC 60 Catalog.

<sup>3)</sup> For detailed information regarding supported controllers, see "System interfaces (WinCC V11)"

<sup>4)</sup> Application note:

Parallel use of the OPC client channel allows, for example, connection to an SNMP OPC Server for visualization of the data present there. The SNMP OPC Server enables monitoring of any network components (e.g. switches) that support the SNMP protocol. Further information can be found under SIMATIC NET communications systems/SNMP OPC Server.

# PROFINET/Industrial Ethernet

## System interfaces for SIMATIC HMI

### System interfaces with WinCC (TIA Portal)

#### WinCC Runtime Communication

#### Overview (continued)

##### Communication – SIMATIC WinCC Runtime Professional

WinCC Professional is an open process visualization system and offers the option of connecting the most diverse control systems.

##### Released communication software

Only communication software with the listed (or higher) product versions should be used. Corresponding SIMATIC NET upgrades are available for the upgrading of older versions.

##### Number of connectable controllers

With CP 1613/CP 1623, a maximum of 64 S7 controllers can be connected via Industrial Ethernet; with CP 5612/CP 5622 a maximum of 8, and with CP 5613 A3 a maximum of 44 S7 controllers can be connected via PROFIBUS. With approx. 10 or more controllers, the use of Industrial Ethernet is recommended.

##### Client-server communication

Communication between the clients and the server is implemented using the TCP/IP protocol. The construction of a separate PC-LAN is recommended. For small projects with correspondingly small message frame advent, a SIMATIC NET Industrial Ethernet can be used for both process communication (WinCC/server ↔ PLC) and for PC-PC communication (WinCC/client ↔ WinCC/server)

##### Connection to third-party controllers

The following "Coupling overview" table lists third-party protocols and controllers which are directly supported by WinCC Professional. Generally it is also possible to connect third-party controllers via OPC (OLE for Process Control).

Current notes and information about OPC servers from many different suppliers can be found at:

<http://www.opcfoundation.org/>

WinCC Professional supports the standards:

- OPC Data Access 2.05a
- OPC Data Access 3.00
- OPC UA Data Access 1.01
- OPC XML Data Access 1.00
- OPC HDA 1.20
- OPC A&E 1.10

#### Coupling overview for WinCC Runtime Professional

Protocol	Description	PC interface
<i>SIMATIC S7</i>		
<b>SIMATIC S7</b>	Protocol Suite with channel units for communication with SIMATIC S7 via <ul style="list-style-type: none"> <li>• Ethernet TCP/IP (S7 communication) to S7-1200, S7-1500, S7-300, S7-400</li> </ul>	CP 1612 A2 CP 1613 A2 CP 5611 A2 CP 5621 CP 5512 CP 5711 CP 5613 A2 CP 5623
<i>Third-party controllers (from WinCC V11.0)</i>		
<b>Allen Bradley Ethernet IP</b>	Channel for communication with Allen Bradley controllers via Ethernet TCP/IP with Ethernet IP protocol The controllers ControlLogix / CompactLogix, SLC500 / MicroLogix, and PLC5 are supported	CP 1612 A2
<b>Mitsubishi MC TCP/IP</b>	Channel for communication with Mitsubishi controllers via Ethernet TCP/IP with Mitsubishi MC TCP/IP protocol The FX3, Q, and iQ/QnUD controller series are supported	CP 1612 A2
<b>Modbus TCP/IP</b>	Channel for communication with Modicon controllers via Ethernet TCP/IP using the Modbus TCP/IP protocol The Quantum, Momentum, Premium, TSX Micro, Compact and M340 controllers are supported	CP 1612 A2
<i>Cross-manufacturer</i>		
<b>OPC client <sup>1)</sup> for OPC DA, OPC XML DA</b>	Channel for OPC communication, WinCC can acquire data from OPC server applications	CP 1612 A2
<b>OPC server for OPC DA, OPC UA DA, OPC XML DA, OPC A&amp;E, OPC HDA</b>	Server applications for OPC communication; WinCC provides process data to OPC Clients	CP 1612 A2

<sup>1)</sup> Application note:

Parallel use of the OPC client channel allows, for example, connection to an SNMP OPC Server for visualization of the data present there. The SNMP OPC Server enables monitoring of any network components (e.g. switches) that support the SNMP protocol. Further information can be found under SIMATIC NET communications systems/SNMP OPC Server.

#### Overview (continued)

#### Communications examples

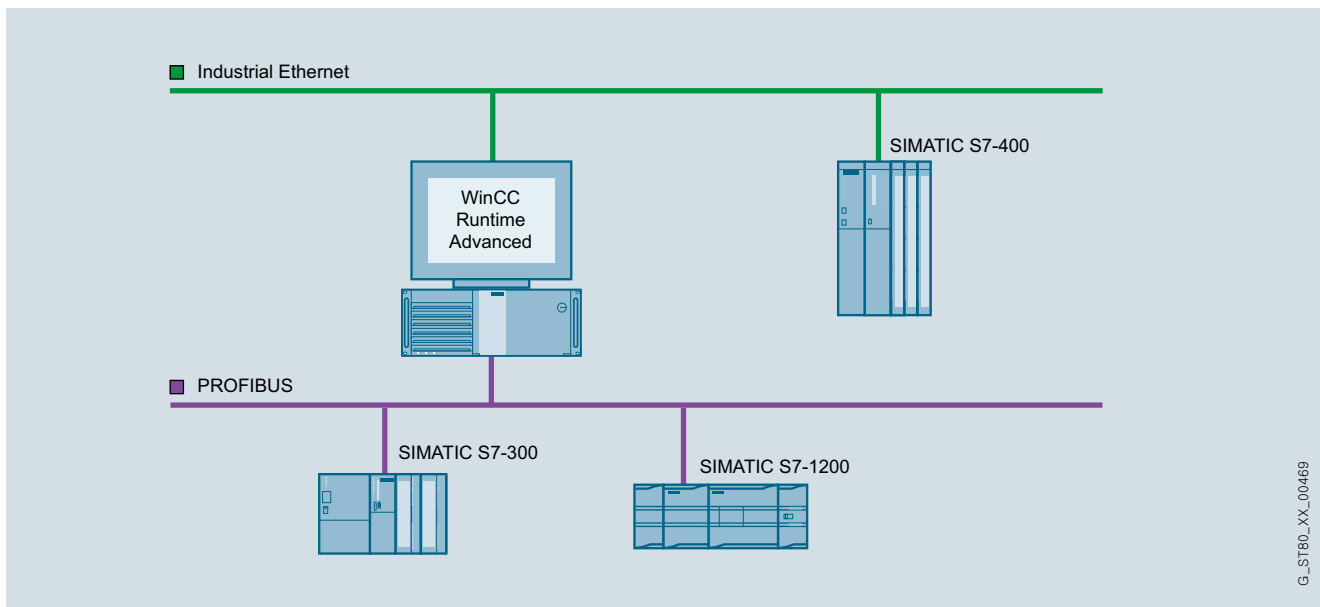

WinCC Runtime Advanced single-user system

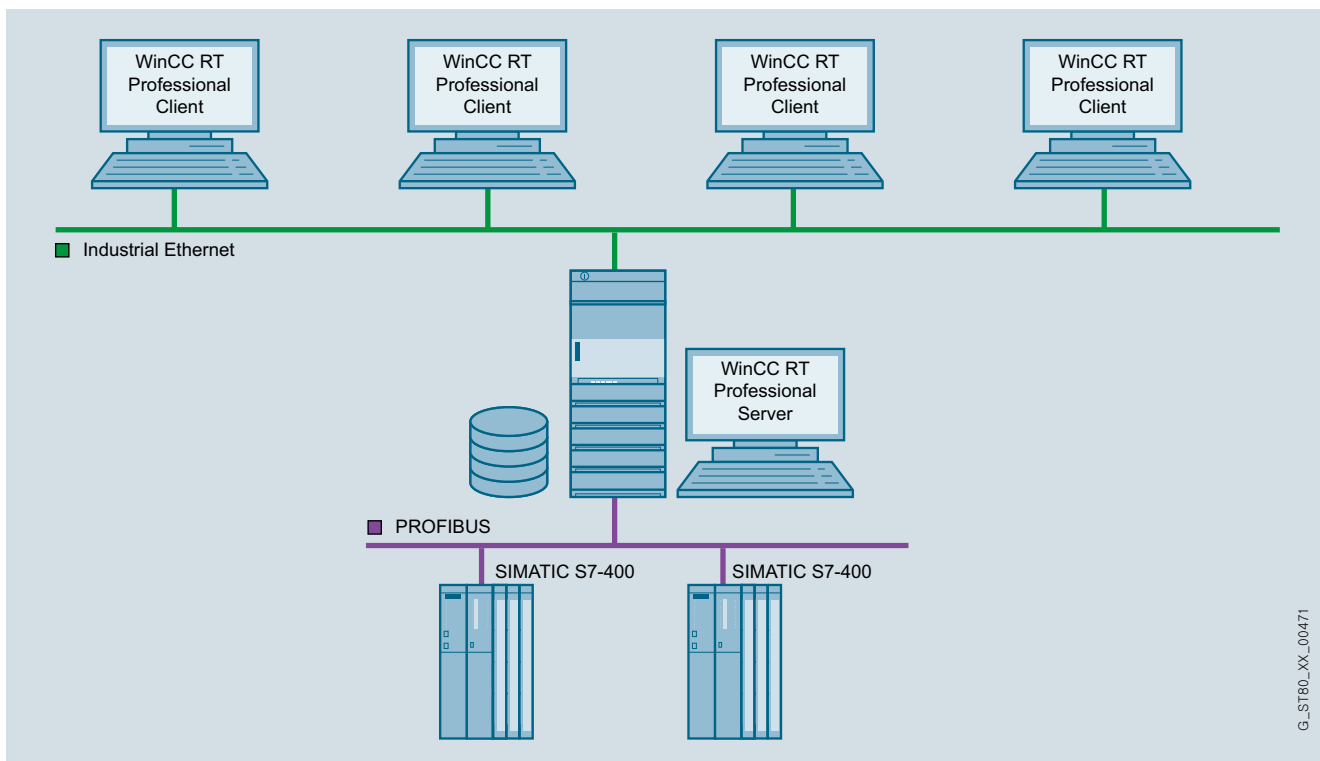

WinCC Runtime Professional multi-user system with operable server

# PROFINET/Industrial Ethernet

## System interfaces for SIMATIC HMI

### System interfaces with WinCC (TIA Portal)

#### WinCC Runtime Communication

#### Overview (continued)

2

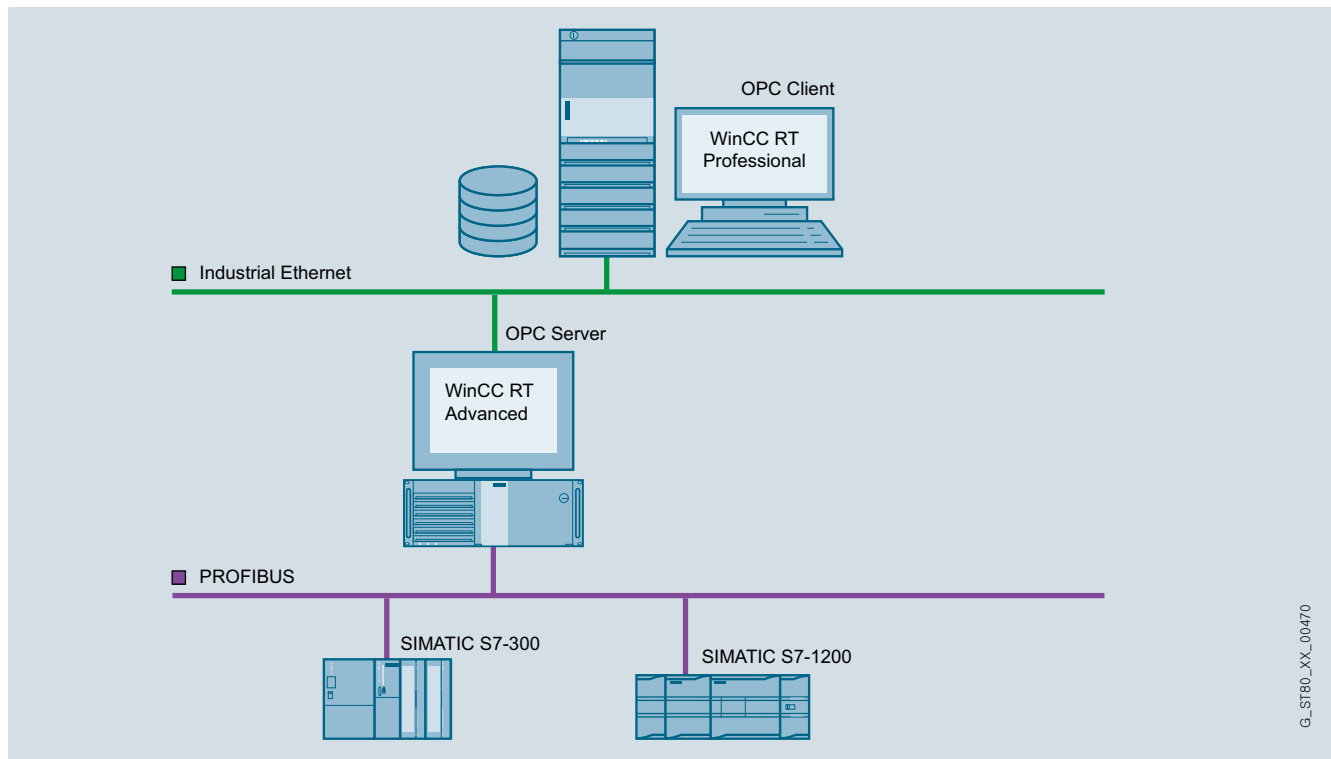

OPC coupling



## Overview

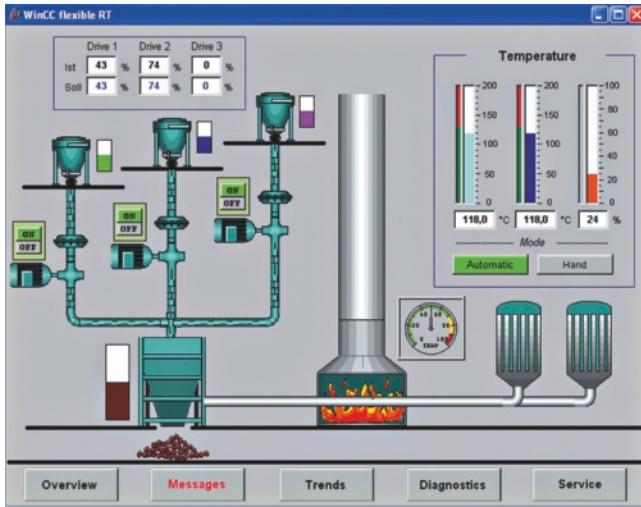

PC-based visualization software for single-user systems directly at the machine.

- Runs under Windows XP Professional and Windows 7 Professional, Ultimate, Enterprise
- Current version: SIMATIC WinCC flexible 2008 SP3 Runtime

SIMATIC WinCC flexible Runtime is configured with the SIMATIC WinCC flexible Advanced configuration software.

## Benefits

- Optimum price/performance ratio thanks to individually scalable system functionality
- Functions for all visualization tasks: Operator functions, graphical and trend displays, signaling system, log system, archiving (option), recipe management (option), Audit Trail (option), process fault diagnostics (option)
- Flexible runtime functionality thanks to Visual Basic scripts
- Innovative service concepts with remote operation, diagnostics and administration via intranet and Internet as well as e-mail communication to increase availability (option)
- Support for simple distributed automation solutions based on TCP/IP networks at the machine level (option)

## Application

SIMATIC WinCC flexible Runtime is the high-performance visualization software for simple visualization tasks at machine level. It can be used as a single-user solution for all automation applications in factory automation, process automation and building services automation.

SIMATIC WinCC flexible Runtime can be used in combination with the following operator panels:

- SIMATIC Panel PCs
  - PC IL 70/77
  - Microbox 420
  - Panel PC 477
  - Panel PC 577
  - Panel PC 670/677
  - Panel PC 870/877
- SIMOTION Panel PCs
  - P012, P015
  - PCR, PCR-Touch
- SINUMERIK Panel PCs
  - HT8; OP08T
  - OP010, OP012, OP015
  - TP012, TP015, OP015A
- Standard PCs with resolutions (W x H in pixels) of:
  - 4:3 format: 640 x 480, 800 x 600, 1024 x 768, 1280 x 1024, 1600 x 1200
  - Widescreen format: 800 x 480, 1280 x 800, 1366 x 768, 1440 x 900, 1680 x 1050, 1920 x 1080, 1920 x 1200, 1980 x 1080

## Design

SIMATIC WinCC flexible Runtime is available as a software package with 128, 512, 2048 or 4096 PowerTags. The term PowerTags is used exclusively to identify process variables and range pointers that have a process link to the controller. Variables without process link, constant limit values of variables, and messages (up to 4000 bit-triggered messages) are also available for additional system performance.

The range of functions of WinCC flexible Runtime includes the centralized HMI components for visualizing and reporting, and it can be expanded to suit requirements and costs by using optional packages.

SIMATIC WinCC flexible Runtime is configured with the SIMATIC WinCC flexible Advanced configuration software.

# PROFINET/Industrial Ethernet

## System interfaces for SIMATIC HMI

### System interfaces with WinCC flexible

#### SIMATIC WinCC flexible RT

#### Function

##### Visualization via Windows-compliant operator interface

made up of parameterizable screen objects and image blocks created on a project-specific basis:

- Numeric and alphanumeric input/output fields
- Static text and graphic display plus vector graphics
- Dynamizable graphics from HMI symbol library
- Bar graph, trend curve graph with scroll and zoom function as well as read line
- Signal-specific text and graphic lists
- Buttons and switches for operator-process communication
- Editing fields for process values (signals)
- Analog display, slider as example for further screen objects
- Project-specific image blocks created from system basic objects
- Graphic displays for various standard graphic formats, e.g., bitmaps, .jpg, .wmf

##### Alarms and messages

- Discrete alarms and analog alarms as well as event-driven Alarm-S/Alarm-D message procedure with SIMATIC S7 and SIMOTION
- Freely-definable message classes for definition of acknowledgment response and display of message events

##### Logging of alarms and process values <sup>1)</sup>

- Archiving in files (e.g. CSV or TXT file) and Microsoft SQL databases
- Online evaluation of process value archives and alarm logs
- Evaluation of process value archives and alarm logs using standard Microsoft tools such as Excel

##### Recipes <sup>1)</sup>

- Generation of data records for machine or production data
- Display or entry of data records via a configurable screen object or via process images when distributed within the project
- Transmission of data records from or to the PLC
- Import/export for data records from/to CSV files

##### Documentation of process data, alarm events and recipes

- Time- or event-driven report output
- User-definable layout

##### Flexible expansion of system function

- thanks to Visual Basic Script

##### Language support for multilingual projects

- Up to 16 online languages (incl. Asian and Cyrillic)
- Language-dependent texts and graphics
- Language selection during runtime

##### User-oriented access protection according to requirements of regulated sectors

- Authentication with user ID and password
- User-group-specific rights
- Central system-wide user administration based on SIMATIC Logon <sup>1)</sup>
- Monitoring of changes by operators in runtime operation <sup>1)</sup>
- Recording of operator actions in an Audit Trail <sup>1)</sup>

##### PLC link for a wide variety of PLCs on-board

- Simultaneous connection using several protocols: OPC Client or SIMATIC HMI HTTP protocol are additive, i.e. can be used in conjunction with other PLC links
- Communication via native drivers and standard OPC channel

##### Open communication between HMI systems and with higher-level systems <sup>1)</sup>

- OPC server
- Sm@rtAccess for communication between HMI systems based on Ethernet networks, or via the intranet/Internet:
- Read and write access to variables; WinCC flexible Runtime or SIMATIC Panels make data (variables) available to other SIMATIC HMI systems or Office applications.
- A SIMATIC HMI system can be used to control or monitor another system remotely; entry level for client/server configurations for distributed operator stations or for solutions with headend or control room.

##### Sm@rtService for remote control, diagnostics and administration via intranet and Internet <sup>1)</sup>

- Display and control of process images on remote PC or Panel
- Sending of e-mails on demand or event-driven
- System diagnostics visualized via device-specific HTML pages

<sup>1)</sup> Option for SIMATIC WinCC flexible Runtime; runtime licenses must be purchased separately. For further information, refer to "WinCC flexible options".

System requirements	WinCC flexible Runtime
<b>Operating system</b>	Windows XP Professional SP3 (32 bit) Windows XP Embedded <sup>1)</sup> Windows 7 Professional / Ultimate / Enterprise (32 bit and 64 bit)
<b>Processor</b> <sup>4)</sup>	
• Minimum	Windows XP: 300 MHz Windows 7: 1 GHz
• Recommended	Windows XP: ≥ Pentium III, 500 MHz Windows 7: ≥ 1 GHz
<b>Graphics</b>	
• Minimum	SVGA
• Resolution	640 x 480 to 1600 x 1200 or 800 x 480 to 1980 x 1080
<b>RAM</b> <sup>2)</sup>	
• Minimum	Windows XP: 128 MB Windows 7: 1 GB
• Recommended	Windows XP: ≥ 512 MB Windows 7: ≥ 1 GB
<b>Hard disk (free memory space)</b> <sup>3)</sup>	≥ 250 MB

<sup>1)</sup> Only for enabled platforms (e.g. Panel PC 477). You can get information from your Siemens contact.

<sup>2)</sup> RAM requirements are determined primarily by the size of the graphics used.

<sup>3)</sup> Without taking archives into account. In addition to the space needed by WinCC flexible, Windows also requires space on the hard disk; e.g., for the swap file. The following formula has proven itself in the past: The size of the swap file = 3 x the size of the RAM. For further information, refer to your Windows documentation

<sup>4)</sup> More powerful systems (Pentium 4 and higher) may be required in order to use options

## Integration

SIMATIC WinCC flexible Runtime supports linking to:

Protocol	PC interfaces
<b>SIMATIC S7 via Ethernet (TCP/IP)</b>	
S7-200 with CP 243-1	CP 1612 <sup>1)</sup> CP 1613 A2
S7-300 CPUs with integral Ethernet interface	
S7-300 with CP 343-1	
S7-400 CPUs with integral Ethernet interface	
S7-400 with CP 443-1	
WinAC Basis (V3.0 and higher)	
WinAC RTX	
<b>SIMATIC S7 via integrated interface</b>	
WinAC Basis (V2.0 and higher)	Internal system interface
WinAC RTX	
<b>SIMOTION <sup>2)</sup></b>	
<b>SINUMERIK <sup>3)</sup></b>	
<b>Third-party controllers</b>	
Allen Bradley (DF1/DH485)	COM1/COM2
Allen Bradley (Ethernet)	CP 1612 <sup>1)</sup>
GE Fanuc (SNP/SNPX)	COM1/COM2
LG GLOFA GM	COM1/COM2
Mitsubishi (FX/MP4)	COM1/COM2
Modicon (Modbus)	COM1/COM2
Modicon (Modbus TCP/IP)	CP 1612 <sup>1)</sup>
OMRON (Link/Multilink)	COM1/COM2
<b>OPC <sup>4) 6)</sup></b>	
Data Access V2.05a (client + server)	CP 1612 <sup>1)</sup>
Data Access XML V1.00 (client)	
<b>HTTP communication for data exchange between SIMATIC HMI (client + server) <sup>5) 6)</sup></b>	CP 1612 <sup>1)</sup>

<sup>1)</sup> For Microbox 427 and Panel PC 477/577/677/877 via internal Ethernet interface

<sup>2)</sup> For further information, see Catalog PM 10

<sup>3)</sup> "SINUMERIK HMI copy license OA" option required; for further information, see Catalog NC 60

<sup>4)</sup> OPC Client is included in scope of delivery, the "WinCC flexible/OPC Server for WinCC flexible Runtime" license is required for the OPC Server option

<sup>5)</sup> "WinCC flexible/Sm@rtAccess for WinCC flexible Runtime" license required

<sup>6)</sup> OPC and HTTP communication are additive, i.e. can be used in conjunction with the PLC links listed above

<sup>7)</sup> Via PC cable with integrated level converter RS 232/TTY; Article number: 6ES5734-1BD20

<sup>8)</sup> For information about SIMATIC Panels that support OPC/http communication, see the overview under "System interfaces".

## Application note

In parallel with each and every PLC link, WinCC flexible Runtime supports the use of the OPC Client channel; this enables, for example, connection to an SNMP OPC Server for the purpose of visualizing the data stored there. The SNMP OPC Server provides a means of monitoring network components of any type (e.g. switches) which support the SNMP protocol. For further information, see Catalog IK PI.

### Note:

For further information, see "HMI devices/System interfaces"

# PROFINET/Industrial Ethernet

## System interfaces for SIMATIC HMI

### System interfaces with WinCC flexible

#### SIMATIC WinCC flexible RT

#### Integration (continued)

2

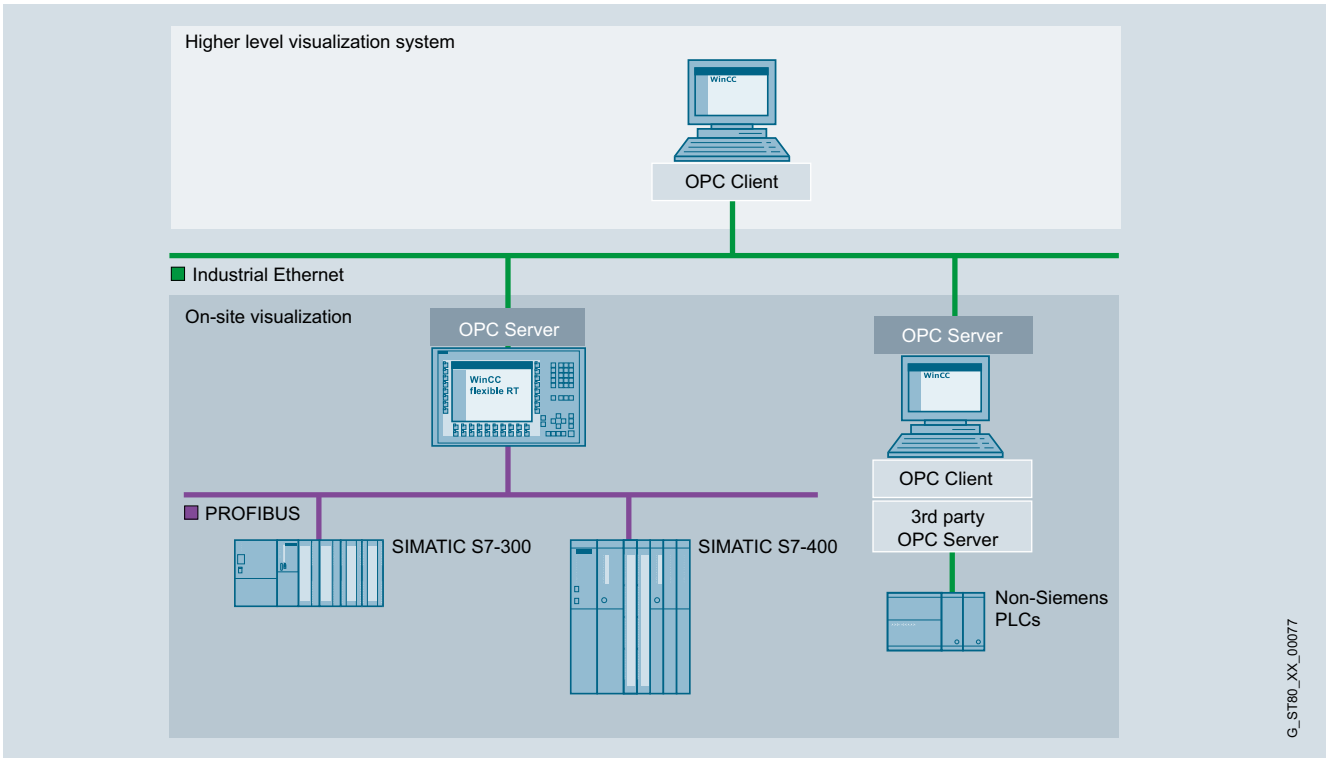

SIMATIC WinCC flexible Runtime application example

#### Technical specifications

Type	SIMATIC WinCC flexible Runtime
	The specifications are maximum values
<b>Displays</b>	500
• Fields per screen	400
• Variables per screen	400
• Static text	30 000
• Graphics objects	2 000
• Complex objects per display (e.g. bars)	40
• Trends	800
• Graphics lists <sup>1)</sup>	500
• Text lists <sup>1)</sup>	500
• Number of entries in symbol tables	3 500
<b>Variables</b>	4 096 <sup>3)</sup>
<b>Messages bit-triggered / analog</b>	4 000 / 500
• Message text (number of characters)	80
• Number of process values per message	8
• Size of message buffer	1 024
• Pending message events	500
<b>Archives <sup>4)</sup></b>	100
• Archivable data	Process data, messages
• Max. number of entries per archive (incl. all archive segments)	500,000
• Archive types	Short-term archive, sequence archive (max. 400 per archive)
• Data storage format	CSV (Comma Separated Variable), RDB (Runtime Data Base), interface to MS SQL database
<b>Recipes<sup>4)</sup></b>	1 000
• Elements per recipe	2 000 <sup>3)</sup>
• Data records per recipe	5 000 <sup>2)</sup>

Type	SIMATIC WinCC flexible Runtime
	The specifications are maximum values
<b>Password protection</b>	
• User rights	32
• Number of user groups	50
<b>Visual Basic scripts</b>	200
<b>Online languages, max.</b>	16
<b>Communication</b>	
SIMATIC S7 MPI interface/ PROFIBUS DP interface	Depending on the scope of the configuration (communication) from the point of view of WinCC flexible Runtime, as many as 8 connections are possible
• Number of connectable stations, max.	
SIMATIC S7 PPI interface	
• Number of connectable stations, max.	1 from viewpoint of WinCC flexible Runtime
SIMATIC S5 PROFIBUS DP interface	
• Number of connectable stations, max.	1 from viewpoint of WinCC flexible Runtime
Multi-protocol operation	Yes, OPC Client or SIMATIC HMI HTTP protocol are additive, i.e. can be used in conjunction with other PLC links

<sup>1)</sup> Together only 500 text and graphics lists

<sup>2)</sup> Dependent on memory medium used

<sup>3)</sup> Dependent on number of licensed PowerTags

<sup>4)</sup> Option for SIMATIC WinCC flexible Runtime. For further information, refer to "WinCC flexible options".

# PROFINET/Industrial Ethernet

## System interfaces for SIMATIC HMI

### System interfaces with WinCC flexible

#### SIMATIC WinCC flexible RT

#### Ordering data

#### Article No.

#### Article No.

#### SIMATIC WinCC flexible 2008 Runtime

for PC systems;  
incl. SW for PC systems options <sup>1)</sup>  
Single license,  
on CD-ROM incl. licensing, for:

- 128 PowerTags (RT 128)
- 512 PowerTags (RT 512)
- 2 048 PowerTags (RT 2048)
- 4 096 PowerTags (RT 4096)

**6AV6613-1BA51-3CA0**  
**6AV6613-1DA51-3CA0**  
**6AV6613-1FA51-3CA0**  
**6AV6613-1GA51-3CA0**

#### Power Packs

#### SIMATIC WinCC flexible 2008 Runtime

Single license,  
only license key for PowerTags,  
from

- 128 to 512 PowerTags
- 128 to 2 048 PowerTags
- 512 to 2 048 PowerTags
- 128 to 4 096 PowerTags
- 512 to 4 096 PowerTags
- 2 048 to 4 096 PowerTags

**6AV6613-4BD01-3AD0**  
**6AV6613-4BF01-3AD0**  
**6AV6613-4DF01-3AD0**  
**6AV6613-4BG01-3AD0**  
**6AV6613-4DG01-3AD0**  
**6AV6613-4FG01-3AD0**

#### Updates

#### SIMATIC WinCC flexible 2008 Runtime Update 2008, 2008 SP1, 2008 SP2 -> 2008 SP3

**6AV6613-1XA51-3CU8**

#### Upgrades

#### SIMATIC WinCC flexible 2004/2005/2007 Runtime to SIMATIC WinCC flexible 2008 Runtime

Upgrade to SIMATIC WinCC flexible Runtime 2008 PowerTags incl. Runtime Options for:

- WinCC flexible /Archives
- WinCC flexible /Recipes
- WinCC flexible /Audit
- WinCC flexible /Sm@rtAccess
- WinCC flexible /Sm@rtService
- WinCC flexible /OPC server
- WinCC flexible /ProAgent

**6AV6613-1XA51-3CE0**

Upgrade of the SIMATIC WinCC flexible Panel options:

- WinCC flexible /Audit for SIMATIC Panel
- WinCC flexible /Sm@rtAccess for SIMATIC Panel
- WinCC flexible /Sm@rtService for SIMATIC Panel
- WinCC flexible /OPC server for SIMATIC Multi Panel
- WinCC flexible /ProAgent for SIMATIC Multi Panel

**6AV6618-7XX01-3AF0**

#### Documentation (must be ordered separately)

#### User Manual WinCC flexible Runtime

- German
- English
- French
- Italian
- Spanish

**6AV6691-1BA01-3AA0**  
**6AV6691-1BA01-3AB0**  
**6AV6691-1BA01-3AC0**  
**6AV6691-1BA01-3AD0**  
**6AV6691-1BA01-3AE0**

#### User Manual WinCC flexible Communication

- German
- English
- French
- Italian
- Spanish

**6AV6691-1CA01-3AA0**  
**6AV6691-1CA01-3AB0**  
**6AV6691-1CA01-3AC0**  
**6AV6691-1CA01-3AD0**  
**6AV6691-1CA01-3AE0**

#### SIMATIC HMI Manual Collection

Electronic documentation,  
on DVD

5 languages (English, French, German, Italian and Spanish);  
contains: all currently available user manuals, device manuals and communication manuals for SIMATIC HMI

**6AV6691-1SA01-0AX0**

<sup>1)</sup> Runtime licenses for WinCC flexible Runtime options must be purchased separately for each target system.

#### More information

Additional information is available in the Internet under:

<http://www.siemens.com/wincc-flexible>

#### Note:

Do you need a specific modification or option for the products described here? You will find information about the Open Platform Program for the creation of user-specific functions and controls for WinCC flexible under "Customized Products".

## Overview

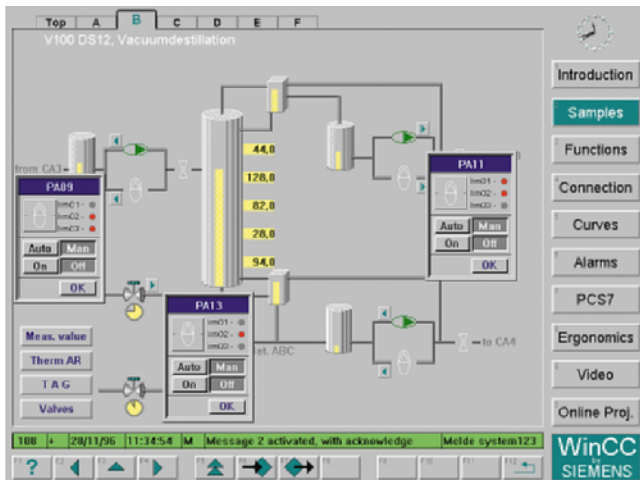

- PC-based operator control and monitoring system for visualizing and operating processes, production flows, machines and plants in all sectors – from the simple single-user station through to distributed multi-user systems with redundant servers and cross-location solutions with Web clients. WinCC is the information hub for corporation-wide vertical integration.
- The basic system configuration (WinCC basic software) includes industry-standard functions for signaling and acknowledging events, archiving of messages and measured values, logging of all process and configuration data, user administration and visualization.
- The WinCC basic software forms the core of a wide range of different applications. Based on the open programming interfaces, a wide range of WinCC options (from Siemens Industry Automation) and WinCC add-ons have been developed (by Siemens-internal and external partners).
- WinCC can be operated with every PC that meets the given HW requirements. The SIMATIC IPC product range is available in particular for the industrial use of WinCC systems. SIMATIC IPCs impress with their powerful PC technology, are designed for round-the-clock operation, and can be operated in both office areas and harsh industrial environments.

Current versions:

### **SIMATIC WinCC V7.3**

Executable with

- Windows 7 SP1 (32 / 64 bit) Professional, Enterprise, Ultimate
- Windows 8.1 (32 / 64 bit) Professional, Enterprise
- Windows 2008 Server SP2 (32 bit) Standard
- Windows 2008 Server R2 SP1 (64 bit) Standard
- Windows Server 2012 R2 (64 bit) Standard includes the Microsoft SQL Server 2008 R2 SP2 (32 bit)

### **SIMATIC WinCC V7.2**

Executable with:

- Windows 7 SP1 (32 / 64 bit) Professional, Enterprise, Ultimate
- Windows XP Professional SP3
- Windows Server 2003 SP2, Standard
- Windows Server 2008 SP2 (32 bit) Standard
- Windows Server 2008 R2 SP1 (64 bit) Standard contains the Microsoft SQL Server 2008 R2 SP1 (32 bit)

### **SIMATIC WinCC V7.0 SP3**

Executable with:

- Windows 7 SP1 (32 / 64 bit) Professional, Enterprise, Ultimate
- Windows XP Professional SP3
- Windows Server 2003 SP2 and Windows Server 2003 R2 SP2 Standard
- Windows Server 2008 SP2 (32 bit) Standard
- Windows Server 2008 R2 SP1 (64 bit) Standard includes the Microsoft SQL Server 2005 SP4
- Use in virtual environments – for additional information, see <http://support.automation.siemens.com/WWW/view/en/49370459>

## PROFINET/Industrial Ethernet

### System interfaces for SIMATIC HMI

### System interfaces with WinCC

#### SIMATIC WinCC

##### Benefits

- All-purpose
  - Solutions for all sectors
  - Multilingual for worldwide usage
  - Can be integrated into all automation solutions
- All HMI functions on board
  - User administration
  - Operator control and monitoring
  - Reporting, acknowledging, and archiving of events
  - Acquisition, compression and archiving of measured values (incl. long-term backup)
  - Logging and documenting of process and configuration data
- Can be configured simply and efficiently
  - Configuration wizards let the user focus on the essentials
  - In the picture by means of cross-reference lists and screen property displays
  - Configuration of multilingual applications
  - Configuring tool for configuring bulk data
- Universally scalable
  - Expandable from single station to client-server configurations
  - Increased availability by means of redundant servers
  - Process visualization via the web with the WinCC WebNavigator
- Open standards for simple integration
  - Powerful real-time database Microsoft SQL Server 2008 R2 SP1 (32 bit)
  - Open for application modules with ActiveX controls
  - Visual Basic for Applications for individual expansions
  - OPC for cross-vendor communication
- Process visualization with Plant Intelligence
  - Integrated high-performance Historian on the basis of the Microsoft SQL Server 2008 R2 SP1 (32 bit)
  - Integrated evaluation functions for the online analysis (statistical process control)
  - Production optimization with the help of diverse options
- Expandable using options and add-ons
  - Options for scalable configurations
  - Options for increasing the availability
  - Options for IT & business integration
  - Options for SCADA expansions
  - Options for validation in accordance with FDA 21 CFR Part 11
  - Options for the use of telecontrol protocols
- Part of Totally Integrated Automation
  - Direct access to the tag and message configuration of the SIMATIC control system
  - Integrated diagnostic functions for increasing productivity
  - Options for the use of telecontrol protocols

##### New in V7.2

- Expansion into Graphic Designer
  - Know-how protection by means of password protection for PDL images and image blocks
- Unicode support
  - WinCC SETUP in 5 languages / up to 9 installed languages
  - Individual language selection for engineering and runtime, regardless of the language settings in the operating system
- Simplified configuration of the Tag Management by means of the innovative WinCC Configuration Studio
  - Configuration options similar to those in Excel
  - Simplified tags / structure tag management
- New communication channels
  - Communication channel to new CPU (S7-1200 / S7-1500) (absolute address only, no CPU alarming support)
  - Introduction of the OPC UA server (DA, HDA)
- Expansion into archive system
  - New archive recording (day, week, year)
  - New archiving methods (difference)

and more ...

##### Application

SIMATIC WinCC is designed for visualization and operation of processes, manufacturing cycles, machines and plants. With its powerful process interface, especially to the SIMATIC family, and the secure data archiving, WinCC enables highly available solutions for the process control.

The sector-neutral basic system enables universal usage in all automation applications. Sector-specific solutions can, for example, be implemented using WinCC options (e.g. FDA options for the pharmaceutical industry) and sector-specific add-ons (e.g. for the water industry).

##### Design

SIMATIC WinCC is available as a complete package and as a runtime package with 128, 512, 2048, 8192, 65536, 102400, 153600, 262144 PowerTags<sup>1)</sup>. PowerTags are data points that are connected to controllers or other data sources over a WinCC channel. Up to 32 alarms can be obtained from one data point. Moreover, internal tags without coupling are available for additional system performance. In addition WinCC also contains 512 archive tags. Individual archive licenses can be obtained for greater quantity structures.

##### Licenses for a multi-user configuration

The system software with the required number of PowerTags and additionally the option WinCC/Server must be installed on the WinCC server. In the basic configuration, an RT128 or RT client license is sufficient for the WinCC clients. In order to perform configuration on clients, an RC128 license is required. Remote configuration is possible if WinCC clients without their own project (UniClient) on the server project are configured.

<sup>1)</sup> V6: 128, 256, 1024, 8192, 65536 PowerTags



## Function

The powerful configuration functions of SIMATIC WinCC contribute to a reduced engineering and training overhead and lead to a more flexible use of personnel and greater operational reliability. Whoever is familiar with Microsoft Windows can also operate the WinCC Explorer, the central switching point of WinCC.

In combination with other SIMATIC components, the system is also equipped with auxiliary functions such as process diagnostics and maintenance. All SIMATIC engineering tools work together in the configuration of the functions.

SIMATIC WinCC offers a complete basic functionality for process visualization and operation. To this end WinCC has a number of editors and interfaces that can be used to individually configure this functionality according to the respective application. Expansions of a WinCC station for control tasks are also possible with minimal engineering effort.

WinCC editors	Task or configurable runtime functionality
WinCC Explorer	Central project management for the quick access to all project data and central settings
WinCC Graphics Designer	Graphics system for user-defined visualization and operation via pixel-graphic objects
WinCC Alarm Logging	Signaling system for detecting and archiving events with display and control options according to DIN 19235; freely selectable message classes, message display and logging
WinCC Tag Logging	Process archiving for the acquisition, compression and storage of measured values, e.g., presentation in trend and table format as well as further processing
WinCC Report Designer	Reporting and logging system for time and event-controlled documentation of messages, operator inputs and current process data in the form of user reports or project documentation in an arbitrary layout
WinCC User Administrator	Tool for user-friendly administration of users and authorizations
WinCC Global Script	Processing functions with limitless functionality by means of the use of VBScript and ANSI-C

## Interfaces

	Task or configurable runtime functionality
Communication channels	For communication with subordinate controls (SIMATIC protocols, PROFIBUS DP, PROFIBUS FMS, DDE and OPC server included in the scope of delivery)
Standard interfaces	For the open integration of other Windows applications via WinCC, WinCC-OLE-DB, ActiveX, OLE, DDE, OPC, etc.)
Programming ports	For the individual access to data and functions of WinCC and for the integration in user programs with VBA, VB Script, C-API (ODK), C-Script (ANSI-C)

## Integration

### Integration in company-wide solutions (IT and business integration)

WinCC is strictly based on Microsoft technology, which provides the greatest possible compatibility and integration ability. ActiveX and .net <sup>1)</sup> controls support technology-specific and industry-specific expansions. Cross-manufacturer communication is also a simple exercise. The reason: WinCC can be used as an OPC client and server, and in addition to access to current process values, it also supports standards such as OPC HDA (Historical Data Access), OPC Alarm & Events, and OPC XML Data Access.

Just as important: Visual Basic for Applications (VBA) for user-specific expansions of the WinCC Graphics Designer and Visual Basic Scripting (VBS) as an easy-to-learn, open runtime language. If desired, professional application developers can also use ANSI-C. And access to the API programming interfaces is really simple with the Open Development Kit ODK.

WinCC integrates a powerful and scalable historian function based on Microsoft SQL Server 2005 into the basic system. As a result, users have every possibility: from high-performance archiving of current process data, to long-term archiving with high data compression, through to a central information hub in the form of a company-wide process historian. With the help of the Central Archive Server option, this can be set up within the framework of a WinCC solution. Versatile clients and tools for evaluation, the open interfaces, and special options (Connectivity Pack, Connectivity Station, IndustrialDataBridge) provide the basis for effective IT and business integration.

If external networks are accessed, suitable protective measures (incl. IT security measures, such as network segmentation) should be taken in order to ensure safe operation of the system.

You can find more information on the topic of Industrial Security on the Internet at:

<http://www.siemens.com/industrialsecurity>

<sup>1)</sup> Only supported in WinCC V7.0 or higher

### Integration in automation solutions

WinCC is an open process visualization system and provides the option to connect the most diverse control systems.

#### Approved communication software

Only communication software with the listed product versions (or higher) should be used. Corresponding SIMATIC NET upgrades are available for upgrading older versions.

#### Number of connectable controls

For the number of controls connectable via Industrial Ethernet CP 1613, the following applies to a message frame length of 512 bytes:

Type of connection	Number of nodes
SIMATIC S5 Ethernet Layer 4 + TCP/IP	Up to 60
SIMATIC S7 Protocol Suite	Up to 64
SIMATIC 505 Ethernet Layer 4 + TCP/IP	up to 60

Via PROFIBUS, a maximum of 8 controls can be connected with CP 5611, and a maximum of 44 controls with CP 5613. With approx. 10 or more controls, the usage of Industrial Ethernet is recommended.

# PROFINET/Industrial Ethernet

## System interfaces for SIMATIC HMI

### System interfaces with WinCC

#### SIMATIC WinCC

#### Integration (continued)

##### Mixed operation with different controls

With their multi-protocol stack, the CP 1613 and CP 5613 communication processors allow parallel operation of two protocols, such as for the mixed operation of different controls, via a bus cable. WinCC supports the operation of two similar interface boards only in connection with the channels SIMATIC S5 Ethernet Layer 4 (2 x CP 1613), SIMATIC S7 Protocol Suite (2 x CP 1613, 2 x CP 5613) as well as PROFIBUS DP (4 x CP 5613; each CP 5613 max. 122 slaves). In addition to communication over industrial Ethernet CP 1613 or PROFIBUS CP 5613, one CP 5611 can be used in each case for communication with SIMATIC S7 via MPI.

##### Client-server communication

Communication between the clients and the server is via TCP/IP protocol. Setting up a separate PC LAN is recommended. For small projects with a correspondingly low incidence of message frames, SIMATIC NET Industrial Ethernet communication can be used for both process communication (WinCC/Server ↔ PLC) and PC-PC communication (WinCC/client ↔ WinCC/server).

##### Channel DLL PROFIBUS DP

In accordance with the PROFIBUS standard, DP/slaves are always permanently assigned to a DP master; i.e. a second WinCC station (DP/master) cannot access the same controls (DP/slave). This means that redundant operation of two WinCC stations is not possible using the PROFIBUS DP connection.

##### Connection to controls from other manufacturers:

OPC (OLE for Process Control) is recommended for the connection of controls from other manufacturers.

Current notes and information about OPC servers from various suppliers can be found at:

<http://www.opcfoundation.org>

WinCC supports the standards:

- OPC Data Access 2.05a
- OPC Data Access 3.00
- OPC XML Data Access 1.00 (Connectivity Pack/Connectivity Station)
- OPC HDA 1.20 (Connectivity Pack/Connectivity Station)
- OPC A&E 1.10 (Connectivity Pack/Connectivity Station)
- OPC UA Client Data Access
- OPC UA Server Data Access, HDA (Connectivity Pack / Connectivity Station)

#### Connection overview

Protocol	Description
<b>SIMATIC S7</b>	
SIMATIC S7 Protocol Suite	Channel DLL for S7 functions via MPI, PROFIBUS or Ethernet Layer 4 + TCP/IP
<b>SIMATIC S5</b>	
SIMATIC S5 Ethernet Layer 4	Channel DLL for S5 Layer 4 communication + TCP/IP
SIMATIC S5 Programmer Port AS511	Channel DLL and driver for serial communication with S5 using AS511 protocol to programmers port
SIMATIC S5 Serial 3964R	Channel DLL and driver for serial communication with S5 using RK512 protocol
SIMATIC S5 PROFIBUS-FDL	Channel DLL for S5-FDL
<b>SIMATIC 505</b>	
SIMATIC 505 Serial	Channel DLL and driver for serial communication with 505 using NITP/TBP protocol to SIMATIC 535/545/555/565/575
SIMATIC 505 Ethernet Layer 4	Channel DLL for 505 Layer 4 communication
SIMATIC 505 TCP/IP	Channel DLL for 505 TCP/IP communication
<b>SIMATIC S7-1200, S7-1500 (WinCC 7.2 or higher)</b>	
SIMATIC S7-1200, S7-1500 Channel <sup>1)</sup>	Channel DLL for S7-1200 and S7-1500 communication
<b>Controllers from other manufacturers (from WinCC V7.0 SP3)</b>	
Allen Bradley Ethernet IP	Channel DLL and drivers for communication with Allen Bradley controllers via Ethernet TCP/IP using Ethernet IP protocol
Modbus TCP/IP	Channel DLL and drivers for communication with Modicon controllers via Ethernet TCP/IP using Modbus TCP/IP protocol
Mitsubishi MC TCP/IP	Channel DLL and drivers for communication with Mitsubishi controllers via Ethernet TCP/IP using Mitsubishi MC TCP/IP protocol
<b>Cross-manufacturer</b>	
OPC Client <sup>2) 3)</sup> for DA, XML DA	Channel DLL for OPC communication, WinCC can acquire data from OPC server applications.
OPC Server for DA, XML DA, A&E, HDA	Server applications for OPC communication; WinCC provides process data to OPC clients
OPC UA server for DA, HDA	Server applications for OPC UA communication
PROFIBUS FMS	Channel DLL for PROFIBUS FMS
PROFIBUS DP	Channel DLL for PROFIBUS DP
SIMOTION	Channel DLL for SIMOTION

<sup>1)</sup> WinCC version V7.2 or higher supports communication with S7-1200 / S7-1500 CPU.  
Restrictions:  
No symbolic address, type safe structure support (absolute address only)  
No CPU alarming support

<sup>2)</sup> Application note:  
Parallel usage of the OPC client channel allows, for example, connection to an SNMP-OPC server for visualization of the data contained there. The SNMP OPC server enables monitoring of any network components (such as switches) that support the SNMP protocol. You can find more information under SIMATIC NET Communications Systems/SNMP OPC Server.

<sup>3)</sup> WinCC V7.0 SP3 and later supports OPC UA (United Architecture) Client for DA.

**Integration** (continued)

**Communications components for PG/PC for SIMATIC (for WinCC V7.2)**

Industrial Ethernet	SIMATIC S5 Ethernet Layer 4	SIMATIC S5 TCP/IP	SIMATIC S7 Protocol Suite	SIMATIC 505 Ethernet Layer 4	SIMATIC 505 TCP/IP <sup>1)</sup>	Article No.
<i>WinCC – channel DLL</i>						
<b>SIMATIC S5 Ethernet Layer 4</b> Channel DLL for S5 Layer 4 communication + TCP/IP	•	•				Included in the basic package
<b>SIMATIC S7 Protocol Suite</b> Channel DLL for S7 functions			•			Included in the basic package
<b>SIMATIC 505 Ethernet Layer 4</b> Channel DLL for 505 Layer 4 communication				•		Included in the basic package
<b>SIMATIC 505 TCP/IP<sup>1)</sup></b> Channel DLL for 505 TCP/IP communication					•	Included in the basic package
<i>Communication components for extension of the OS/OP</i>						
<b>CP 1612 A2</b> PCI card for connecting a PG/PC to Industrial Ethernet (SOFTNET-S7 or SOFTNET-S7 Lean communication software must be ordered separately)		•	•		•	<b>6GK1161-2AA01</b>
<b>SOFTNET-IE S7</b> communication software for S7 functions (max. 64 connections) • Version 12 <sup>2)</sup> for 32/64-bit Windows 7 Professional/Ultimate; for 64-bit: Windows 2008 Server R2; for 32/64-bit Windows 8 Pro; for Windows Server 2012 German/English • Edition 2008 SP2 (V7.1) <sup>2)</sup> for Windows XP/2003 Server/(32-bit) 2008 Server		•	•			<b>6GK1704-1CW12-0AA0</b>
						<b>6GK1704-1CW71-3AA0</b>
<b>SOFTNET-IE S7 Lean</b> communication software for S7 functions (max. 8 connections) • Version 12 <sup>2)</sup> for 32/64-bit Windows 7 Professional/Ultimate; for 64-bit: Windows 2008 Server R2; for 32/64-bit Windows 8 Pro; German/English • Edition 2008 SP2 (V7.1) <sup>2)3)</sup> for Windows XP/2003 Server / (32-bit) 2008 Server		•	•			<b>6GK1704-1LW12-0AA0</b>
						<b>6GK1704-1LW71-3AA0</b>
<b>CP 1613 A2</b> PCI card (32-bit) for connecting a PG/PC to Industrial Ethernet (S7-1613 communication software required)	•	•	•	•	•	<b>6GK1161-3AA01</b>
<b>CP 1623</b> PCI Express X1 card (32-bit) for connecting a PG/PC to Industrial Ethernet (S7-1613 communication software required)	•	•	•	•	•	<b>6GK1162-3AA00</b>
<b>HARDNET-IE S7</b> communication software for S7 functions and S5/505 Layer 4 communication with TCP/IP • Version 12 <sup>2)</sup> for 32/64-bit Windows Server 2012, Windows 8 Pro, Windows 7 Professional / Ultimate; for 64-bit: Windows 2008 Server R2; German/English • Edition 2008 SP2 (V7.1) <sup>2)</sup> for Windows XP/2003 Server / (32-bit) 2008 Server	•	•	•	•		<b>6GK1716-1CB08-2AA0</b>
						<b>6GK1716-1CB71-3AA0</b>

• System interface possible

<sup>1)</sup> Via any interface board with NDIS 3.0 interface; no separate communication software required

<sup>2)</sup> See ordering data for SIMATIC NET upgrade packages

<sup>3)</sup> SOFTNET-S7 Lean included in scope of supply of WinCC V7.2

# PROFINET/Industrial Ethernet

## System interfaces for SIMATIC HMI

### System interfaces with WinCC

#### SIMATIC WinCC

#### Integration (continued)

#### Communication examples

2

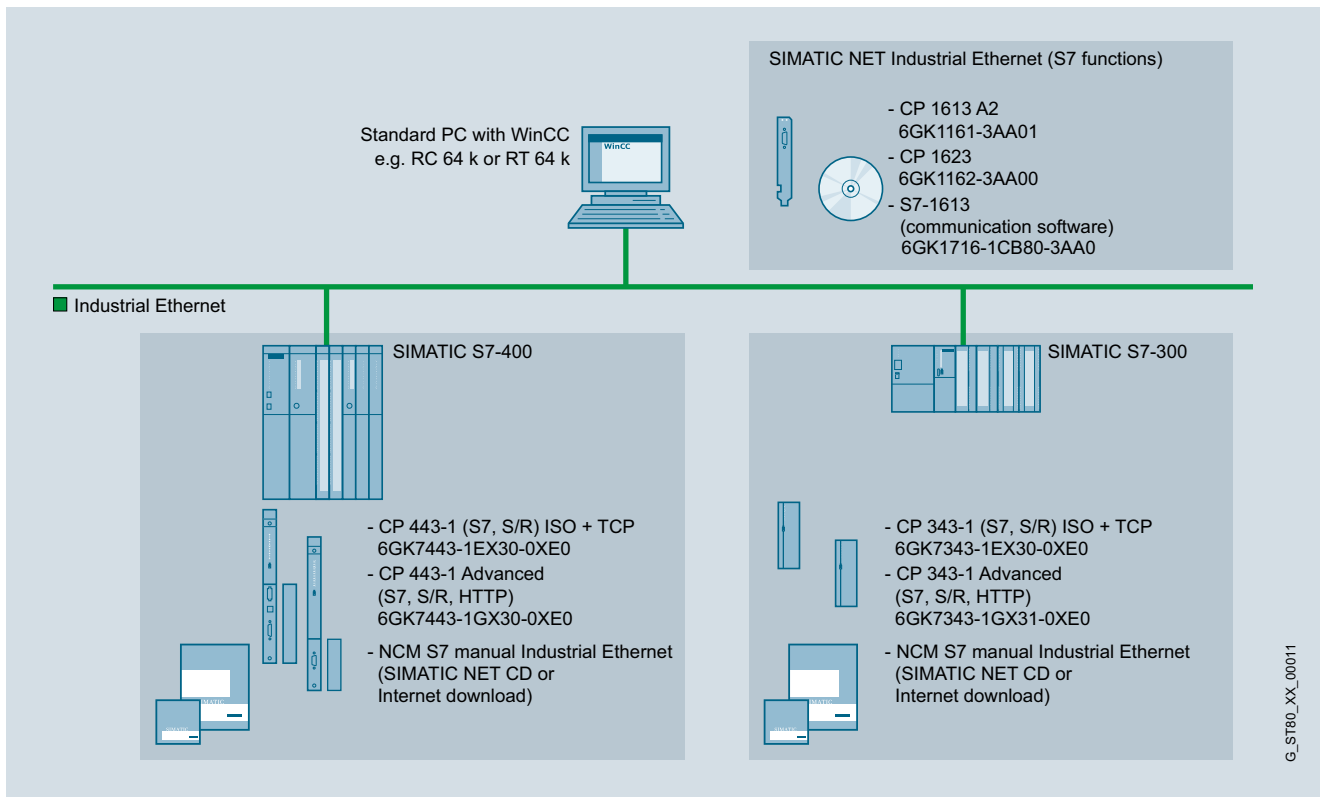

WinCC single-user system: Industrial Ethernet with S7 communication

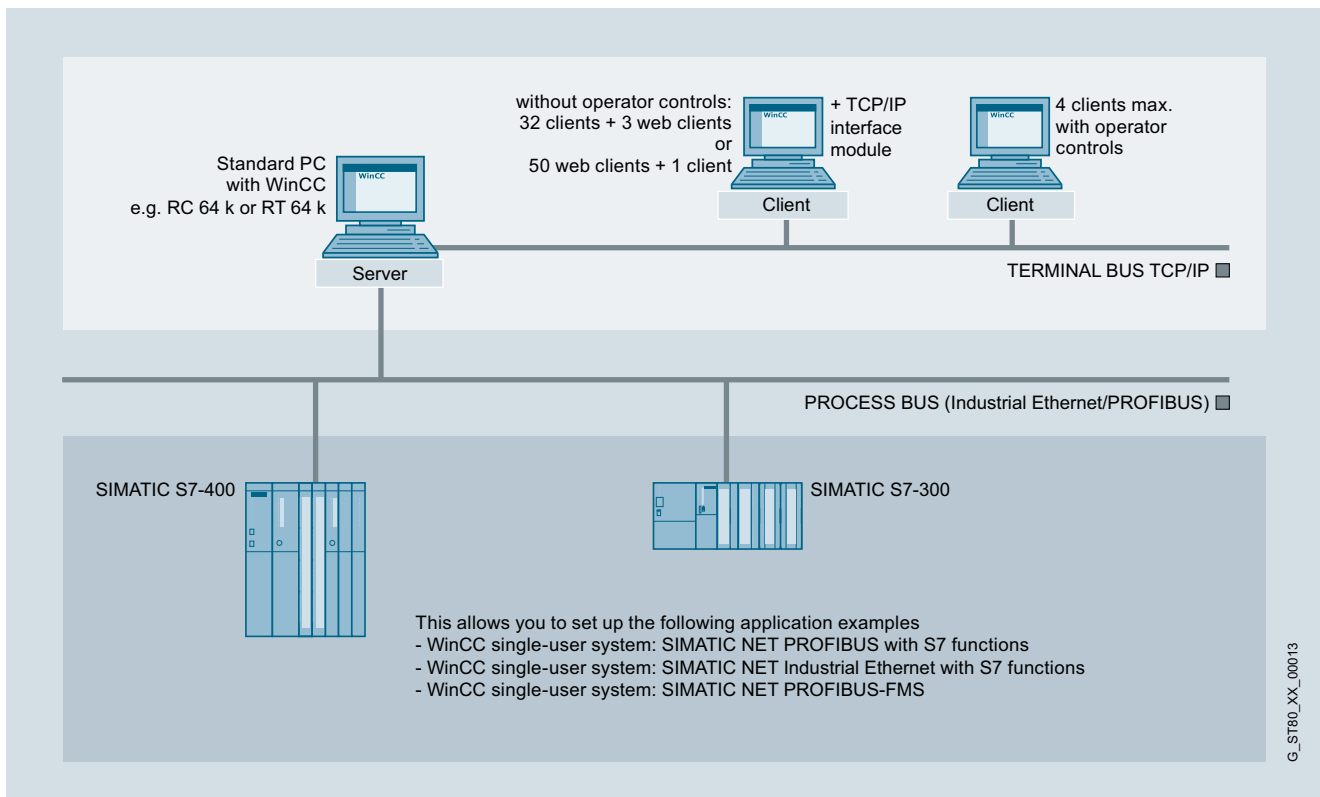

WinCC multi-user system with operable server

#### Integration (continued)

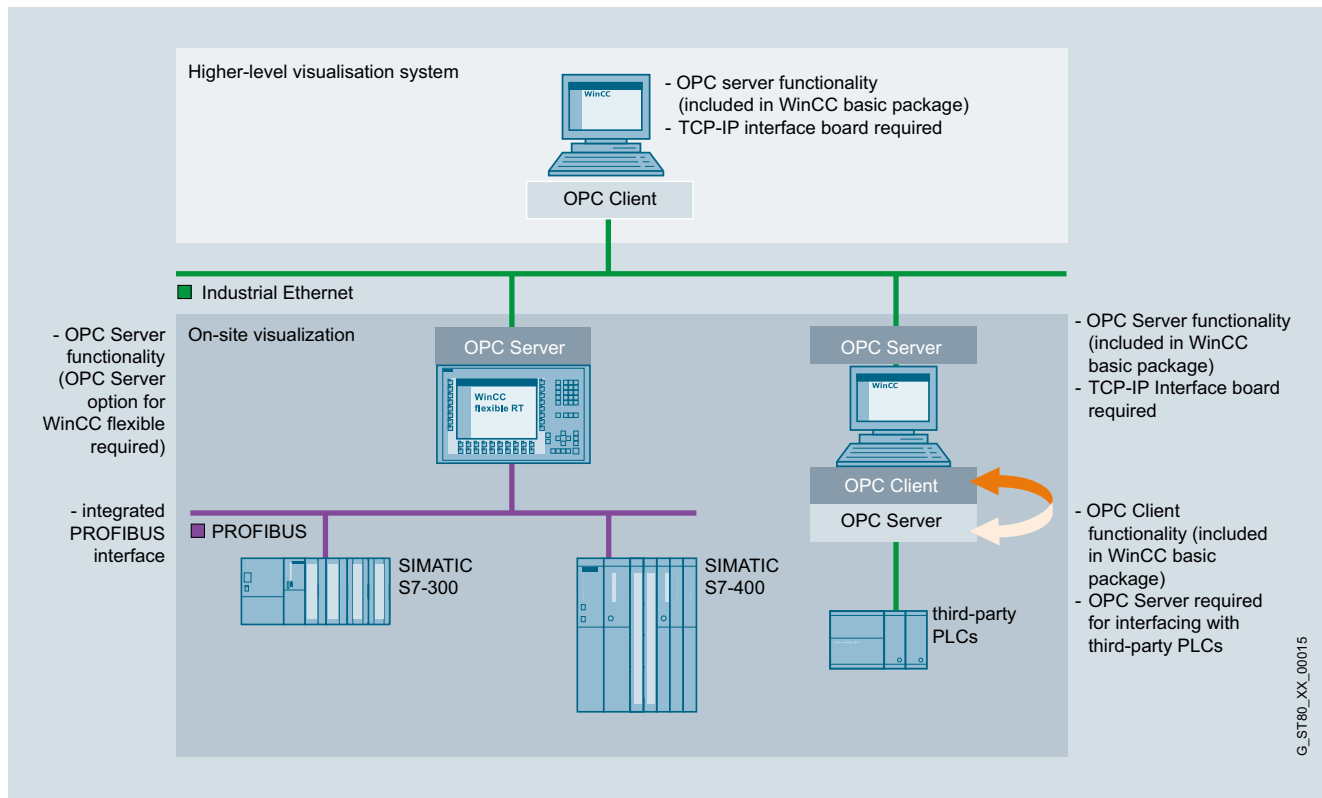

G\_ST80\_XX\_00015

OPC link

# PROFINET/Industrial Ethernet

## System interfaces for SIMATIC HMI

### System interfaces with WinCC

#### SIMATIC WinCC

#### Technical specifications

Type	SIMATIC WinCC V7.2 and V7.0 SP3	SIMATIC WinCC V6.2 SP3
<b>Operating system</b>	<ul style="list-style-type: none"> <li>Windows 7 (32 bit / 64 bit) Ultimate, Professional and Enterprise</li> <li>Windows XP Professional SP3</li> <li>Windows 2003 Server SP2 and Windows 2003 Server R2 SP2</li> <li>Windows Server 2008 SP2 (32 bit) Standard</li> <li>Windows Server 2008 R2 SP1 (64 bit) Standard</li> </ul>	<ul style="list-style-type: none"> <li>Windows XP Professional SP3,</li> <li>Windows 2000 Professional SP4,</li> <li>Windows Server 2003 SP2,</li> <li>Windows Server 2003 R2 SP2</li> </ul>
<b>PC hardware requirements</b>		
<b>Processor type</b> <sup>1)</sup>		
• Minimum	Single-user station/server: Pentium 4, 2.5 GHz <sup>2)</sup> Central Archive Server (V7.0 SP3): Pentium 4, 2.5 GHz Client: Pentium 3, 1 GHz <sup>2)</sup> WebClient/DataMonitor Client: Pentium III, 600 MHz <sup>2)</sup>	Single-user station/server: Pentium III, 1 GHz Central Archive Server: Pentium 4, 2 GHz Client: Pentium III, 600 MHz
• Recommended	Single-user station/server: Pentium 4 or Dual Core, 3 GHz <sup>2)</sup> Central Archive Server (V7.0 SP3): Pentium 4 or Dual Core, 3 GHz Client: Pentium 4, 2 GHz <sup>2)</sup> WebClient/DataMonitor Client: Pentium III, 1 GHz	Single-user station/server: Pentium 4, 2 GHz Central Archive Server: Pentium 4, 2.5 GHz Client: Pentium III, 1 GHz WebClient/DataMonitor Client: Pentium III, 1 GHz
<b>RAM</b>		
• Minimum	Single-user station/server: 4 GB <sup>2)</sup> Central Archive Server: 4 GB Client: 1 GB <sup>2)</sup> WebClient/DataMonitor Client: 512 MB <sup>2)</sup>	Single-user station: 512 MB, server: 1 GB Central Archive Server: 1 GB Client: 512 MB WebClient/DataMonitor Client: 256 MB
• Recommended	Single-user station/server: 8 GB <sup>2)</sup> Central Archive Server: ≥ 4 GB Client: 2 GB <sup>2)</sup> WebClient/DataMonitor Client: 1 GB <sup>2)</sup>	Single-user station: ≥ 1 GB, server: >1 GB Central Archive Server: ≥ 2 GB Client: 512 MB WebClient/DataMonitor Client: 512 MB
<b>Graphics card</b>		
• Minimum	16 MB, 800 x 600 <sup>2)</sup>	16 MB, 800 x 600
• Recommended	32 MB, 1 280 x 1 024 <sup>2)</sup>	32 MB, 1 280 x 1 024
<b>Hard disk</b>		
• Minimum	Single-user station/server: 80 GB Client: 20 GB Central Archive Server: 40 GB WebClient/DataMonitor Client: 5 GB	Single-user station/server: 20 GB Client: 5 GB Central Archive Server: 40 GB WebClient/DataMonitor Client: 5 GB
• Recommended	Single-user station/server: 160 GB Client: 40 GB Central Archive Server: 2 x 80 GB WebClient/DataMonitor Client: 10 GB	Single-user station/server: 80 GB Client: 20 GB Central Archive Server: 2 x 80 GB WebClient/DataMonitor Client: 10 GB
• Hard disk (available memory for installation)		
- Minimum	Server: >1.5 GB Client: 1.5 GB	Server: 1.5 GB Client: 1 GB
- Recommended	Server: >10 GB Client: >1.5 GB	Server: >10 GB Client: >1.5 GB
<b>CD-ROM/DVD-ROM/disk drive/USB port</b>	for software installation	for software installation

<sup>1)</sup> An AMD system with comparable performance can also be used

<sup>2)</sup> Hardware requirements when using Microsoft XP Professional

#### Technical specifications (continued)

Type	SIMATIC WinCC
<b>Functionality/quantity structure</b>	
Number of messages	150 000
• Message text (number of characters)	10 x 256
• Message archive	> 500 000 messages <sup>1)</sup>
• Process values per message	10
• Constant load of messages, max.	Central Archive Server: 100/sec Server/single-user station: 10/s
• Message burst, max.	Server/single-user station: 2 000/10 s every 5 min
<b>Archives</b>	
• Archive data points	Max. 120 000 per server <sup>2)</sup>
• Archive types	Short-term archive with and without long-term archiving
• Data storage format	Microsoft SQL Server 2005
• Measured values per second, max.	Server/single-user station: 5 000/s
<b>User archive</b>	
• Archives and views	500 each
• Product consisting of data record and column per user archive	320 000
• Fields per user archive	500
<b>Graphics system</b>	
• Number of screens	System-limited <sup>1)</sup>
• Number of objects per screen	System-limited <sup>1)</sup>
• Number of controllable fields per screen	System-limited <sup>1)</sup>
PowerTags	256 K <sup>3)</sup>
<b>Trends</b>	
• Trend views per image	25
• Trends per trend view	80
<b>User administration</b>	
• User groups	128
• Number of users	128
• Authorization groups	999
Configuration languages	5 European (Eng., Fr., Ger., It., Sp.), 4 Asian (simpl.+trad. Chi/Kor/Jpn) <sup>4)</sup>
<b>Protocols</b>	
• Message sequence reports (simultaneously)	1 per server/single-user station
• Message archive reports (simultaneously)	3
• User reports	System-limited <sup>1)</sup>
• Report lines per group	66
• Variables per report	300 <sup>5)</sup>
<b>Multi-user system</b>	
• Server	18
• Clients for server with operator sta- tion	4
• Clients for server without operator station	32 clients + 3 WebClients or 50 WebClients + 1 client

<sup>1)</sup> Dependent on the available storage space

<sup>2)</sup> Dependent on the number of licensed archive variables

<sup>3)</sup> Dependent on number of licensed PowerTags

<sup>4)</sup> Asian versions for Version 7 SP1 or higher

<sup>5)</sup> The number of variables per report is dependent on process communication performance

#### Ordering data

#### Article No.

##### SIMATIC WinCC system software V7.2

#### Runtime packages on DVD

Language/script versions:  
DE/EN/FR/IT/ES;  
with license for

- WinCC RT Client
  - 128 PowerTags (RT 128)
  - 512 PowerTags (RT 512)
  - 2 048 PowerTags (RT 2048)
  - 8 192 PowerTags (RT 8192)
  - 65 536 PowerTags (RT 65536)
  - 102 400 PowerTags (RT 102400)
  - 153 600 PowerTags (RT 153600)
  - 262 144 PowerTags (RT 262144)
- Including 512 archive tags each

6AV6381-2CA07-2AX0  
6AV6381-2BC07-2AX0  
6AV6381-2BD07-2AX0  
6AV6381-2BE07-2AX0  
6AV6381-2BH07-2AX0  
6AV6381-2BF07-2AX0  
6AV6381-2BJ07-2AX0  
6AV6381-2BK07-2AX0  
6AV6381-2BL07-2AX0

#### Complete packages on DVD

Language versions:  
DE/EN/FR/IT/ES;  
with license for

- WinCC RC Client
- 128 PowerTags (RC 128)
- 512 PowerTags (RC 512)
- 2 048 PowerTags (RC 2048)
- 8 192 PowerTags (RC 8192)
- 65 536 PowerTags (RC 65536)
- 102 400 PowerTags (RC 102400)
- 153 600 PowerTags (RC 153600)
- 262 144 PowerTags (RC 262144)

6AV6381-2CB07-2AX0  
6AV6381-2BM07-2AX0  
6AV6381-2BN07-2AX0  
6AV6381-2BP07-2AX0  
6AV6381-2BS07-2AX0  
6AV6381-2BQ07-2AX0  
6AV6381-2BT07-2AX0  
6AV6381-2BU07-2AX0  
6AV6381-2BV07-2AX0

##### SIMATIC WinCC system software V7.2 ASIA

#### Runtime packages on DVD

Language/script versions:  
EN, CHS, CHT, KOR, JPN;  
with license for

- WinCC RT Client
- 128 PowerTags (RT 128)
- 512 PowerTags (RT 512)
- 2 048 PowerTags (RT 2048)
- 8 192 PowerTags (RT 8192)
- 65 536 PowerTags (RT 65536)
- 102 400 PowerTags (RT 102400)
- 153 600 PowerTags (RT 153600)
- 262 144 PowerTags (RT 262144)

6AV6381-2CA07-2AV0  
6AV6381-2BC07-2AV0  
6AV6381-2BD07-2AV0  
6AV6381-2BE07-2AV0  
6AV6381-2BH07-2AV0  
6AV6381-2BF07-2AV0  
6AV6381-2BJ07-2AV0  
6AV6381-2BK07-2AV0  
6AV6381-2BL07-2AV0

Including 512 archive tags each

#### Complete packages on DVD

Language versions:  
EN, CHS, CHT, KOR, JPN;  
with license for

- WinCC RC Client
- 128 PowerTags (RC 128)
- 512 PowerTags (RC 512)
- 2 048 PowerTags (RC 2048)
- 8 192 PowerTags (RC 8192)
- 65 536 PowerTags (RC 65536)
- 102 400 PowerTags (RC 102400)
- 153 600 PowerTags (RC 153600)
- 262 144 PowerTags (RC 262144)

6AV6381-2CB07-2AV0  
6AV6381-2BM07-2AV0  
6AV6381-2BN07-2AV0  
6AV6381-2BP07-2AV0  
6AV6381-2BS07-2AV0  
6AV6381-2BQ07-2AV0  
6AV6381-2BT07-2AV0  
6AV6381-2BU07-2AV0  
6AV6381-2BV07-2AV0

# PROFINET/Industrial Ethernet

## System interfaces for SIMATIC HMI

## System interfaces with WinCC

### SIMATIC WinCC

#### Ordering data

#### Article No.

##### *SIMATIC WinCC V7.2 Powerpacks*

For upgrading from:

##### Runtime packages

- 128 to 512 PowerTags
- 512 to 2 048 PowerTags
- 2 048 to 8 192 PowerTags
- 8 192 to 65 536 PowerTags
- 65 536 to 102 400 PowerTags
- 102 400 to 153 600 PowerTags
- 153 600 to 262 144 PowerTags

**6AV6371-2BD07-2AX0**  
**6AV6371-2BG07-2AX0**  
**6AV6371-2BM07-2AX0**  
**6AV6371-2BN07-2AX0**  
**6AV6371-2BP07-2AX0**  
**6AV6371-2BQ07-2AX0**  
**6AV6371-2BR07-2AX0**

##### Complete packages

- 128 to 512 PowerTags
- 512 to 2 048 PowerTags
- 2 048 to 8 192 PowerTags
- 8 192 to 65 536 PowerTags
- 65 536 to 102 400 PowerTags
- 102 400 to 153 600 PowerTags
- 153 600 to 262 144 PowerTags

**6AV6371-2BD17-2AX0**  
**6AV6371-2BG17-2AX0**  
**6AV6371-2BM17-2AX0**  
**6AV6371-2BN17-2AX0**  
**6AV6371-2BP17-2AX0**  
**6AV6371-2BQ17-2AX0**  
**6AV6371-2BR17-2AX0**

##### *SIMATIC WinCC V7.2 archives*

- 1 500 archives
- 5 000 archives
- 10 000 archives
- archives
- 80 000 archives

**6AV6371-1DQ17-2AX0**  
**6AV6371-1DQ17-2BX0**  
**6AV6371-1DQ17-2CX0**  
**6AV6371-1DQ17-2EX0**  
**6AV6371-1DQ17-2GX0**

##### *SIMATIC WinCC V7.2 Archive Powerpacks*

For upgrading archiving from

- 1 500 to 5 000 archive tags
- 5 000 to 10 000 archive tags
- 10 000 to 30 000 archive tags
- 30 000 to 80 000 archive tags

**6AV6371-1DQ17-2AB0**  
**6AV6371-1DQ17-2BC0**  
**6AV6371-1DQ17-2CE0**  
**6AV6371-1DQ17-2EG0**

##### *SIMATIC WinCC Upgrade/Software Update Service*

##### **SIMATIC WinCC V7.2 upgrade <sup>1)</sup>**

For upgrading the RT version

- from V6.2 to V7.2
- from V7.0 to V7.2
- from V6.2 ASIA to V7.2 ASIA
- from V7.0 ASIA to V7.2 ASIA

**6AV6381-2AA07-2AX4**  
**6AV6381-2AA07-2AX3**  
**6AV6381-2AA07-2AV4**  
**6AV6381-2AA07-2AV3**

For upgrading the Client RT version

- from V6.2 to V7.2
- from V7.0 to V7.2
- from V6.2 ASIA to V7.2 ASIA
- from V7.0 ASIA to V7.2 ASIA

**6AV6381-2BC07-2AX4**  
**6AV6381-2BC07-2AX3**  
**6AV6381-2BC07-2AV4**  
**6AV6381-2BC07-2AV3**

For upgrading the RC version

- from V6.2 to V7.2
- from V7.0 to V7.2
- from V6.2 ASIA to V7.2 ASIA
- from V7.0 ASIA to V7.2 ASIA

**6AV6381-2AB07-2AX4**  
**6AV6381-2AB07-2AX3**  
**6AV6381-2AB07-2AV4**  
**6AV6381-2AB07-2AV3**

##### *SIMATIC WinCC Software Update Service (SUS) <sup>2) 3)</sup>*

##### **SIMATIC WinCC V7 Update**

Software Update Service for WinCC basic software and options:

- 1 license
- 3 licenses
- 10 licenses

**6AV6381-1AA00-0AX5**  
**6AV6381-1AA00-0BX5**  
**6AV6381-1AA00-0CX5**

<sup>1)</sup> According to licensing provisions, 1 upgrade package must be ordered for each WinCC station

<sup>2)</sup> The Software Update Service is valid for 1 year. The contract is automatically extended by 1 more year unless canceled 3 months prior to expiration. According to licensing provisions, 1 Software Update Service must be ordered for each WinCC station.

<sup>3)</sup> Requires the current software version

#### Article No.

##### *SIMATIC WinCC system software V6.2 SP3*

##### Runtime packages on CD-ROM

Language/script versions: DE/EN/FR/IT/ES; with license for

- 128 PowerTags (RT 128)
- 256 PowerTags (RT 256)
- 1 024 PowerTags (RT 1024)
- 8 192 PowerTags (RT 8192)
- 65 536 PowerTags (RT 65536)
- 102 400 PowerTags (RT 102400)
- 153 600 PowerTags (RT 153600)
- 262 144 PowerTags (RT 262144)

**6AV6381-1BC06-2AX0**  
**6AV6381-1BD06-2AX0**  
**6AV6381-1BE06-2AX0**  
**6AV6381-1BH06-2AX0**  
**6AV6381-1BF06-2AX0**  
**6AV6381-1BJ06-2AX0**  
**6AV6381-1BK06-2AX0**  
**6AV6381-1BL06-2AX0**

Including 512 archive tags each

##### Complete packages on CD-ROM

Language versions: DE/EN/FR/IT/ES; with license for

- 128 PowerTags (RC 128)
- 256 PowerTags (RC 256)
- 1 024 PowerTags (RC 1024)
- 8 192 PowerTags (RC 8192)
- 65 536 PowerTags (RC 65536)
- 102 400 PowerTags (RC 102400)
- 153 600 PowerTags (RC 153600)
- 262 144 PowerTags (RC 262144)
- Including 512 archive tags each

**6AV6381-1BM06-2AX0**  
**6AV6381-1BN06-2AX0**  
**6AV6381-1BP06-2AX0**  
**6AV6381-1BS06-2AX0**  
**6AV6381-1BQ06-2AX0**  
**6AV6381-1BT06-2AX0**  
**6AV6381-1BU06-2AX0**  
**6AV6381-1BV06-2AX0**

##### *SIMATIC WinCC system software V6.2 SP3 ASIA*

##### Runtime packages on CD-ROM

Language versions: English/simplified and traditional Chinese/Korean/Taiwanese/Japanese; with license for

- 128 PowerTags (RT 128)
- 256 PowerTags (RT 256)
- 1 024 PowerTags (RT 1024)
- 8 192 PowerTags (RT 8192)
- 65 536 PowerTags (RT 65536)

**6AV6381-1BC06-2AV0**  
**6AV6381-1BD06-2AV0**  
**6AV6381-1BE06-2AV0**  
**6AV6381-1BH06-2AV0**  
**6AV6381-1BF06-2AV0**

Including 512 archive tags each

##### Complete packages on CD-ROM

Language versions: English/simplified and traditional Chinese/Korean/Taiwanese, Japanese; with license for

- 128 PowerTags (RC 128)
- 256 PowerTags (RC 256)
- 1 024 PowerTags (RC 1024)
- 8 192 PowerTags (RC 8192)
- 65 536 PowerTags (RC 65536)

**6AV6381-1BM06-2AV0**  
**6AV6381-1BN06-2AV0**  
**6AV6381-1BP06-2AV0**  
**6AV6381-1BS06-2AV0**  
**6AV6381-1BQ06-2AV0**

Including 512 archive tags each



Ordering data	Article No.	Article No.
<b>SIMATIC WinCC V6.2 PowerPacks</b>		
For upgrading from:		
<b>Runtime packages</b>		
• 128 to 256 PowerTags	<b>6AV6371-1BD06-2AX0</b>	<b>6AV6371-1DQ16-2AX0</b>
• 128 to 1 024 PowerTags	<b>6AV6371-1BE06-2AX0</b>	<b>6AV6371-1DQ16-2BX0</b>
• 128 to 8 192 PowerTags	<b>6AV6371-1BK06-2AX0</b>	<b>6AV6371-1DQ16-2CX0</b>
• 128 to 65 536 PowerTags	<b>6AV6371-1BF06-2AX0</b>	<b>6AV6371-1DQ16-2EX0</b>
• 256 to 1 024 PowerTags	<b>6AV6371-1BG06-2AX0</b>	<b>6AV6371-1DQ16-2GX0</b>
• 256 to 8 192 PowerTags	<b>6AV6371-1BL06-2AX0</b>	<b>6AV6371-1DQ16-2JX0</b>
• 256 to 65 536 PowerTags	<b>6AV6371-1BH06-2AX0</b>	
• 1 024 to 8 192 PowerTags	<b>6AV6371-1BM06-2AX0</b>	
• 1 024 to 65 536 PowerTags	<b>6AV6371-1BJ06-2AX0</b>	
• 8 192 to 65 536 PowerTags	<b>6AV6371-1BN06-2AX0</b>	
<b>Complete packages</b>		
• 128 to 256 PowerTags	<b>6AV6371-1BD16-2AX0</b>	
• 128 to 1 024 PowerTags	<b>6AV6371-1BE16-2AX0</b>	
• 128 to 8 192 PowerTags	<b>6AV6371-1BK16-2AX0</b>	
• 128 to 65 536 PowerTags	<b>6AV6371-1BF16-2AX0</b>	
• 256 to 1 024 PowerTags	<b>6AV6371-1BG16-2AX0</b>	
• 256 to 8 192 PowerTags	<b>6AV6371-1BL16-2AX0</b>	
• 256 to 65 536 PowerTags	<b>6AV6371-1BH16-2AX0</b>	
• 1 024 to 8 192 PowerTags	<b>6AV6371-1BM16-2AX0</b>	
• 1 024 to 65 536 PowerTags	<b>6AV6371-1BJ16-2AX0</b>	
• 8 192 to 65 536 PowerTags	<b>6AV6371-1BN16-2AX0</b>	
<b>SIMATIC WinCC V6.2 Archive</b>		
• 1 500 archives		
• 5 000 archives		
• 10 000 archives		
• 30 000 archives		
• 80 000 archives		
• 120 000 archives		
<b>SIMATIC WinCC V6.2 Archive Powerpacks</b>		
For upgrading archiving from		
• 1 500 to 5 000 archive tags	<b>6AV6371-1DQ16-2AB0</b>	
• 5 000 to 10 000 archive tags	<b>6AV6371-1DQ16-2BC0</b>	
• 10 000 to 30 000 archive tags	<b>6AV6371-1DQ16-2CE0</b>	
• 30 000 to 80 000 archive tags	<b>6AV6371-1DQ16-2EG0</b>	
• 80 000 to 120 000 archive tags	<b>6AV6371-1DQ16-2GJ0</b>	
<b>SIMATIC WinCC V6.2 upgrade <sup>1)</sup></b>		
For upgrading the RT version		
• from V5.x to V6.2 SP3	<b>6AV6381-1AA06-2AX4</b>	
• from V6.x to V6.2 SP3	<b>6AV6381-1AA06-2AX3</b>	
• from V5.x ASIA to V6.2 SP3 ASIA	<b>6AV6381-1AA06-2AV4</b>	
• from V6.x ASIA to V6.2 SP3 ASIA	<b>6AV6381-1AA06-2AV3</b>	
For upgrading the RC version		
• from V5.x to V6.2 SP3	<b>6AV6381-1AB06-2AX4</b>	
• from V6.x to V6.2 SP3	<b>6AV6381-1AB06-2AX3</b>	
• from V5.x ASIA to V6.2 SP3 ASIA	<b>6AV6381-1AB06-2AV4</b>	
• from V6.x ASIA to V6.2 SP3 ASIA	<b>6AV6381-1AB06-2AV3</b>	

<sup>1)</sup> According to licensing provisions,  
1 upgrade package must be ordered for each WinCC station.

## More information

### WinCC language versions

SIMATIC WinCC is also offered in simplified Chinese, traditional Chinese, Korean and Japanese especially for Asian markets. These WinCC versions are intended for machine manufacturers, plant constructors and exporters who supply the regions of China, Taiwan, Korea and Japan.

WinCC ASIA includes all familiar WinCC functions and offers in addition the configuration user interface in the respective national language and English. The online help is available in simplified Chinese, traditional Chinese, Korean, Japanese and English. A Chinese, Korean, Japanese or multilingual Windows operating system is required for operation.

WinCC ASIA is delivered on a separate DVD which contains all of the above mentioned language versions. The corresponding documentation can be obtained from the national subsidiaries in China, Korea, Taiwan and Japan.

The runtime licenses are language-neutral. The English handling program (Automation License Manager – ALM) is executable under the Chinese, Korean and Japanese Windows versions.

In order to use the Asian languages in WinCC, an Asia hardware dongle is required.

Additional information is available on the Internet at:

<http://www.siemens.com/wincc>

Separate configurators are available for PC hardware:

- SIMATIC IPC547C
- SIMATIC IPC647C
- SIMATIC IPC847C
- SIMATIC IPC427C, SIMATIC IPC427D
- SIMATIC IPC627C
- SIMATIC Box PC 827C
- SIMATIC IPC477C, SIMATIC IPC477D
- SIMATIC HMI IPC577C
- SIMATIC HMI IPC677C

## PROFINET/Industrial Ethernet Accessories

### C-PLUG

#### Overview



- Swap media that supports the fast and easy replacement of SIMATIC NET components without a programming device in the event of a fault
- For implementation in all SIMATIC NET products with C-PLUG slot
- For automatic backing up of configuration or engineering data from the SIMATIC NET components
- The C-PLUG can also be used to store application data such as documents or Web pages
- In some SIMATIC S7 CP modules, such as the CP 443-1 Advanced, the C-PLUG is a standard component of the scope of supply and is required to guarantee the complete functional scope of the respective component.

#### Benefits

get **Designed for Industry**

- Quick and easy replacement of SIMATIC NET components without the need to reconfigure the replacement part
- The device can be replaced without the need for specially trained personnel or a programming device or PC
- The downtime of network segments and connected Industrial Ethernet stations in the event of a fault is minimized.

#### Application

The C-PLUG is used when it is necessary for network components or communication modules to be replaced quickly and easily in the event of a fault without the need for reconfiguring the replacement part and without the need for special training.

#### Design

The C-PLUG has degree of protection IP20. The degree of protection of IP65 components is ensured by the design of the target device. The power supply is also provided by the end device.

The C-PLUG is inserted in the associated slot of the SIMATIC NET component. The configuration data are automatically saved to the C-PLUG during device start-up and reconfiguring.

If a device needs to be replaced, the C-PLUG is simply removed from the failed component and plugged into the replacement device. The replacement device installed in the network or automation system now starts up automatically with the same device configuration as the failed device.

To prevent unintentional removal or falling out, the C-PLUG slot is usually located on the rear of the terminal devices.



Plugging the C-PLUG into the rear of the CP 443-1 Advanced



Plugging the C-PLUG into the SCALANCE XM408-8C switch

**Function**

During start-up, the device automatically backs up the configuration data on an unwritten C-PLUG (delivery condition) that has been plugged into a SIMATIC NET component. Changes to the configuration during normal operation are also backed up on the C-PLUG without any additional operator intervention.

During start-up an unconfigured device automatically loads the configuration data from an inserted, written C-PLUG provided the data were written by a compatible device type.

**Diagnostics**

Incorrect C-PLUG handling, such as inserting a C-PLUG that contains the configuration of another device group or general malfunctions of the C-PLUG are signaled over the diagnostic mechanisms for the respective data terminal (LEDs, PROFINET, SNMP, Web-based Management, etc.).

**Integration****Supported products****SCALANCE X Industrial Ethernet switches**

- SCALANCE X-200
- SCALANCE X-300 (included in scope of supply)
- SCALANCE X-400 (included in scope of supply)
- SCALANCE X-500 (included in scope of supply)

**SCALANCE S security modules**

- SCALANCE S -600

**Industrial Wireless LAN SCALANCE W**

- W78x, W77x IWLAN Access Points
- W74x, W76x IWLAN Client Modules

**SCALANCE M industrial modems and routers**

- SCALANCE M81x
- SCALANCE M826
- SCALANCE M874

**System connections for SIMATIC S7**

- CP 443-1 Advanced (included in delivery)
- CP 343-1 Advanced (included in delivery)
- CP 343-1 ERPC (included in delivery)

**Network transitions**

- IE/PB Link PN IO
- IE/AS-i LINK PN IO
- DP/AS-i LINK Advanced

**Technical specifications**

Product-type designation	C-PLUG
Supply voltage	Via terminal device
Power loss	0.015 mW
Installation	Can be plugged into C-PLUG slot
Constructional design	
• Dimensions (W x H x D) in mm	24.3 x 17 x 8.1
• Weight	Approx. 5 g
Memory capacity	32 MB
Degree of protection	IP20

**Ordering data****Article No.****C-PLUG**

Swap medium for simple replacement of devices in the event of a fault; for storing configuration or engineering and application data; can be used for SIMATIC NET products with PLUG slot

**6GK1900-0AB00**

## PROFINET/Industrial Ethernet Accessories

### Time synchronization

#### Overview

##### Introduction



In many applications it is becoming increasingly important to synchronize the time in plants and systems. Only if all network stations are supplied cyclically with a reliable time frame from a central location can optimum process operation be ensured. This results in benefits for the plant operator such as increased operational reliability, the possibility of tracing system faults in a targeted manner, increased economic efficiency due to fewer production outages, and increased productivity in manufacture.

For this purpose, the SICLOCK product family offers a comprehensive range of optimally matched components for setting up highly reliable time synchronization systems.

Typical industries and fields of application for time synchronization systems are:

- Factory/process automation
- Power supply
- Building automation
- Transportation systems
- Safety engineering
- IT systems

The SICLOCK product range comprises the following product groups:

- Wireless receivers
- Central plant clocks
- Pulse converters
- Accessories

##### System description

Satellites or long-wave transmitters are used as primary time sources. The SICLOCK wireless receivers (e.g. SICLOCK GPS1000) receive these high-frequency signals and transmit the demodulated time signal to the central plant clock via a robust and interference-proof 2-wire connection.

The central plant clock converts the time signal into an Ethernet-based network frame (e.g. NTP, SIMATIC procedure) and thus provides all connected network stations with precise and uniform time information.

Furthermore, in the event of failure or loss of reception from the primary time source, the central plant clock ensures stable continuation of the clock time and tracking of the system time without time jumps as soon as reception is restored.

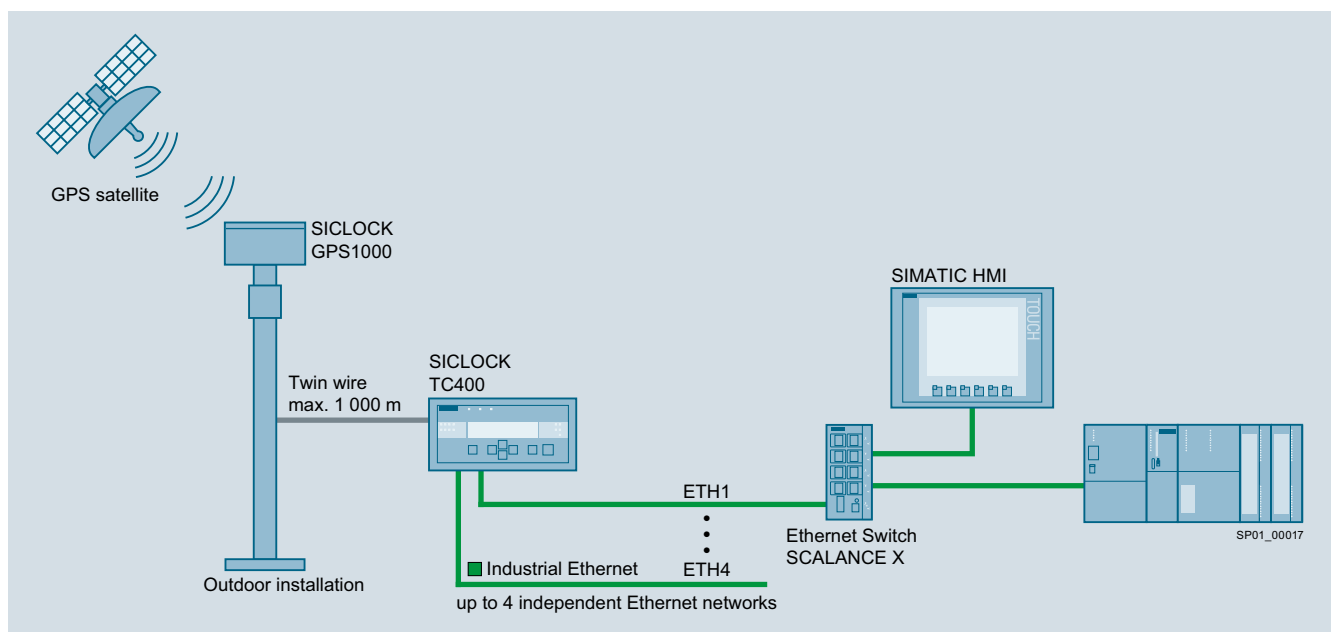

SICLOCK TC400 central plant clock with SICLOCK GPS1000 wireless receiver

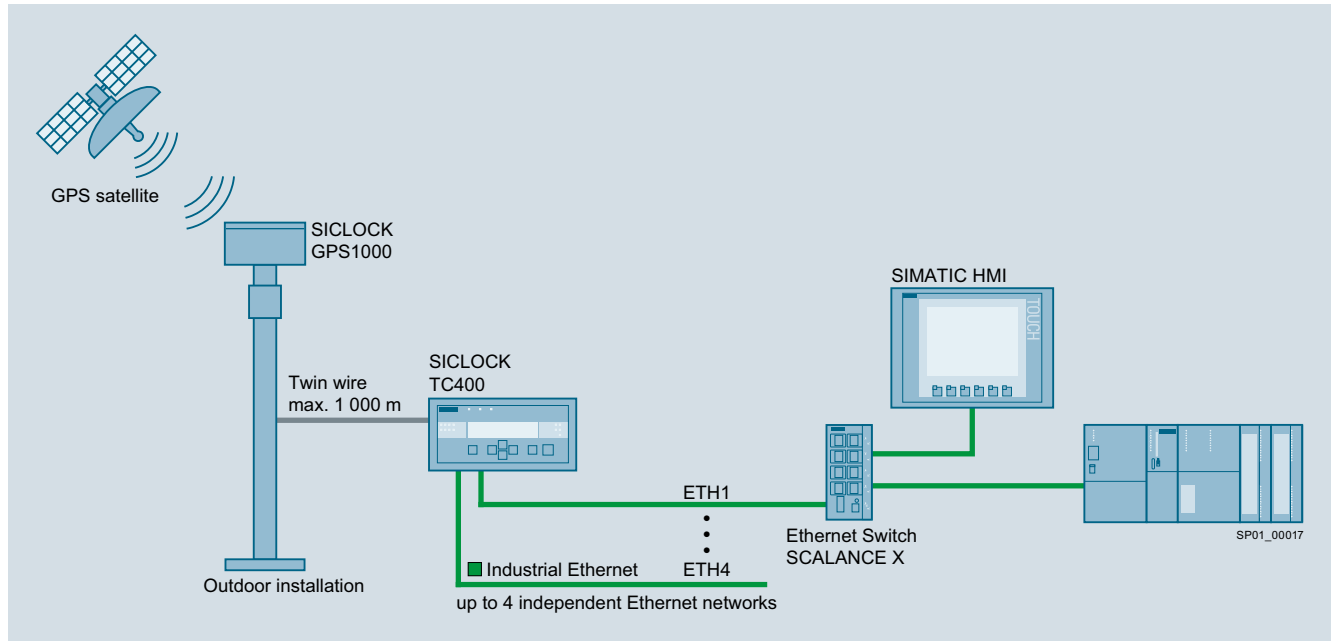
**Application****Application examples**System with GPS reception

SICLOCK TC400 central plant clock with SICLOCK GPS1000 wireless receiver

The SICLOCK GPS1000 wireless receiver (Article No. 2XV9450-1AR84) is used in this example. The wireless receiver is mounted outdoors with "visual contact" to the navigation satellites for optimum reception quality.

The line current method (TTY - 20 mA) used in the SICLOCK system permits distances of up to one kilometer between the wireless receiver and the central plant clock and also supplies the receiver with power, which eliminates the need for any additional power supply components. This makes it possible to install the central plant clock at a central location, even in plants spread over a very large area.

The SICLOCK TC400 central plant clock shown in the example features four 10/100 Mbit Ethernet interfaces for supplying up to four independent IP networks. The SICLOCK TC100 central plant clock with one Ethernet interface has been designed for smaller, cost-sensitive plants.

The central plant clocks do not have Ethernet switching functionality for safety reasons. SIMATIC NET SCALANCE X switches are recommended for this purpose, see <http://support.automation.siemens.com/WWW/view/en/18689247/133200>.

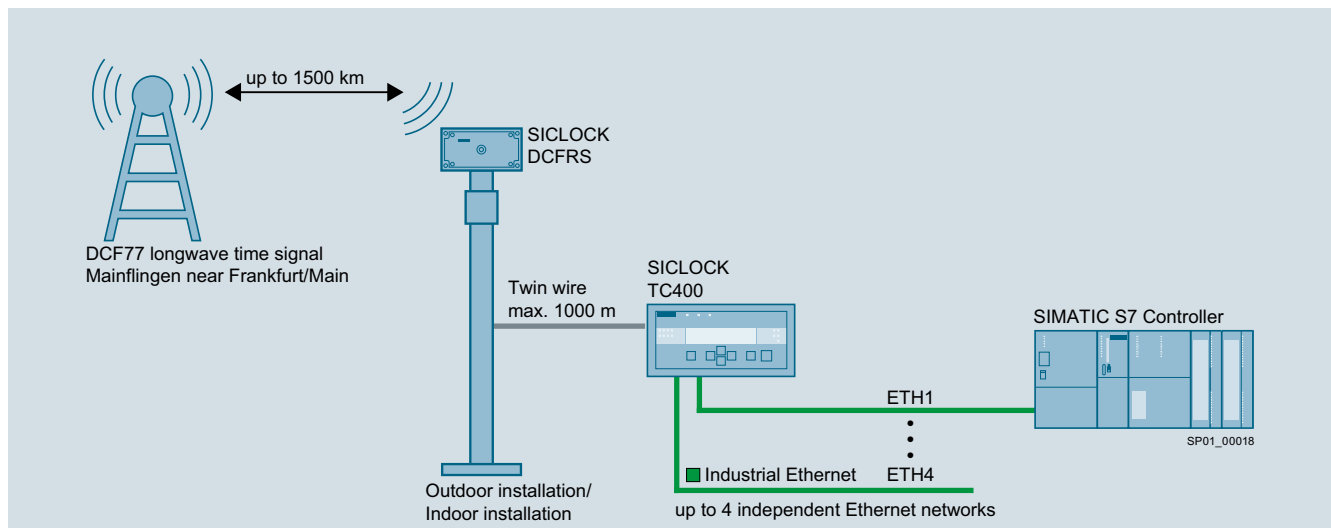
System with DCF77 reception

SICLOCK TC400 central plant clock with SICLOCK DCFRS wireless receiver

## PROFINET/Industrial Ethernet Accessories

### Time synchronization

#### Application (continued)

As an alternative to receiving satellite signals, the DCF77 time signal transmitter can be used as primary time source. The transmitter is located near Frankfurt am Main and transmits long-wave signals at a frequency of 77.5 kHz. Under normal conditions, reception is possible up to a distance of about 1 500 km from the transmitter.

The SICLOCK DCFRS wireless receiver with TTY output (Article No. 2XV9450-1AR16) is used in this application. Here too, a separate power supply is not required if a SICLOCK TC100 or SICLOCK TC400 central plant clock is used.

#### Reception-side redundancy

The advantages over satellite reception are lower costs and the option of mounting the receiver inside a building. The last advantage is especially useful if outdoor installation is not advisable, e.g. due to vandalism.

#### Redundant modes

Due to the importance of having a reliable time supply in many demanding applications, the SICLOCK system offers optional redundant modes to further increase plant reliability. The redundancy can be on the reception side, the network side, or even be combined with a redundant central plant clock for highly sensitive applications.

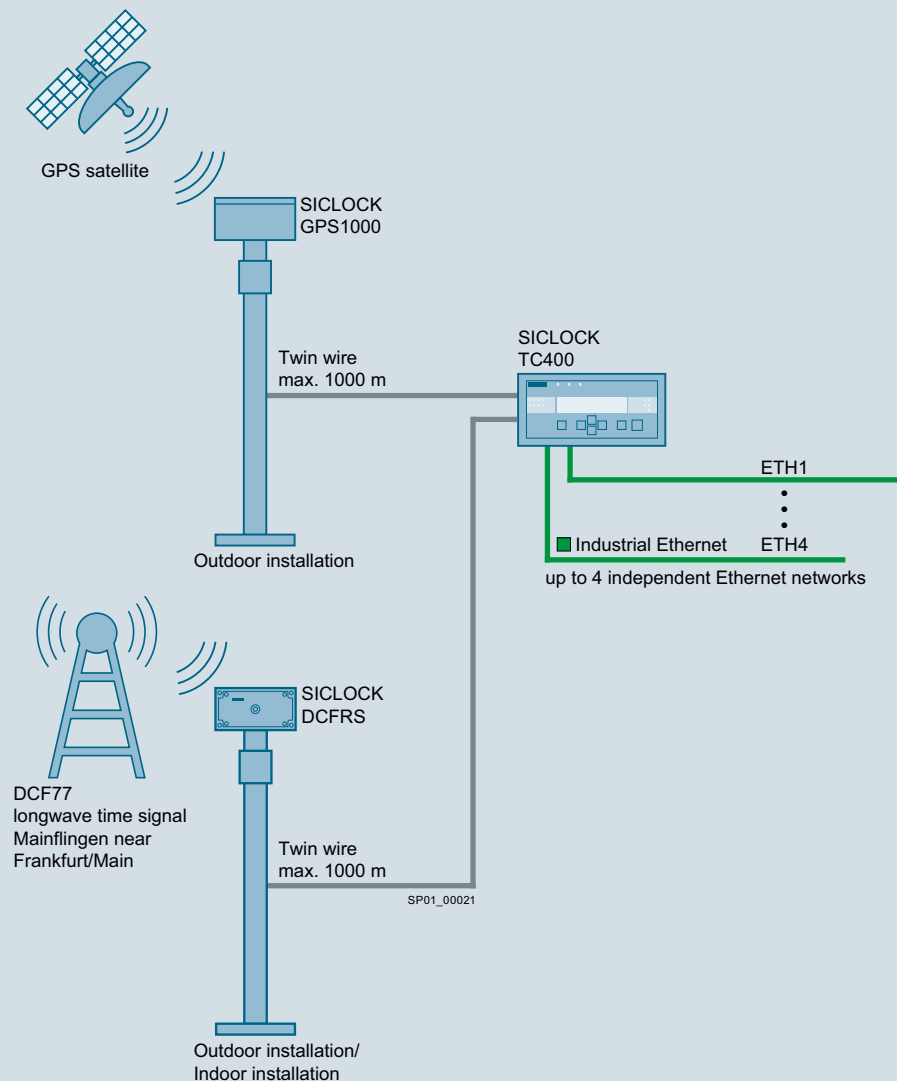

SICLOCK TC400 central plant clock with SICLOCK GPS1000 and SICLOCK DCFRS wireless receivers

In this application, SICLOCK GPS1000 and SICLOCK DCFRS wireless receivers are used in parallel. External time information can continue to be received even if one of the two primary time sources fails. The SICLOCK TC100 and SICLOCK TC400 central plant clocks each have two inputs for the wireless receivers.

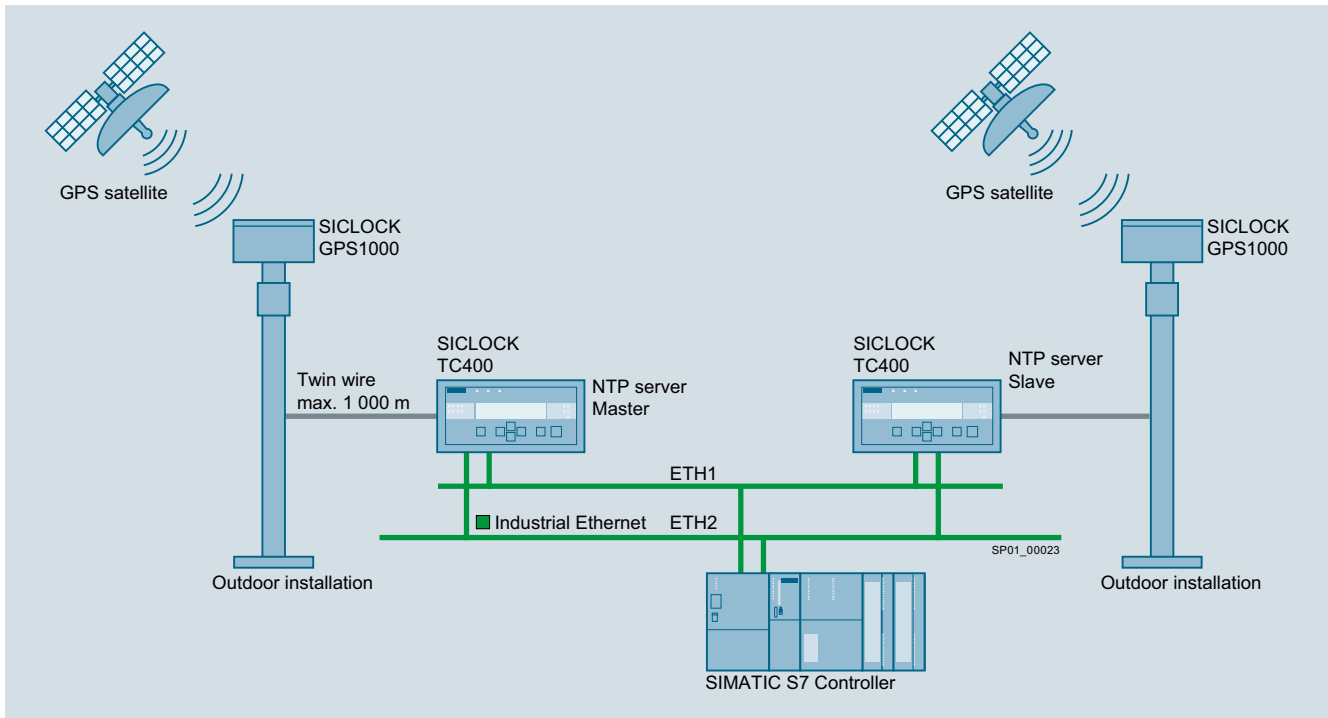
**Application** (continued)  
Highly redundant system

SICLOCK TC400 central plant clocks with SICLOCK GPS1000 wireless receiver

This application can satisfy the highest redundancy requirements. The system uses two SICLOCK TC400 central plant clocks, each with separate SICLOCK GPS1000 wireless receivers

One central plant clock is parameterized as the NTP server master, the other as the NTP server slave. The NTP server slave takes over if the NTP master or the connected wireless receiver fails.

If SICLOCK GPS1000 wireless receivers are used, they should be mounted as far away from each other as possible so that the receiver with the better reception conditions can be used and, for example, to avoid damage to both receivers in the event of a lightning strike. Instead of using two GPS wireless receivers, one SICLOCK DCFRS wireless receiver can of course be used.

## PROFINET/Industrial Ethernet Accessories

### Time synchronization

#### Application (continued)

#### Synchronization of IT networks

IT network with a central plant clock

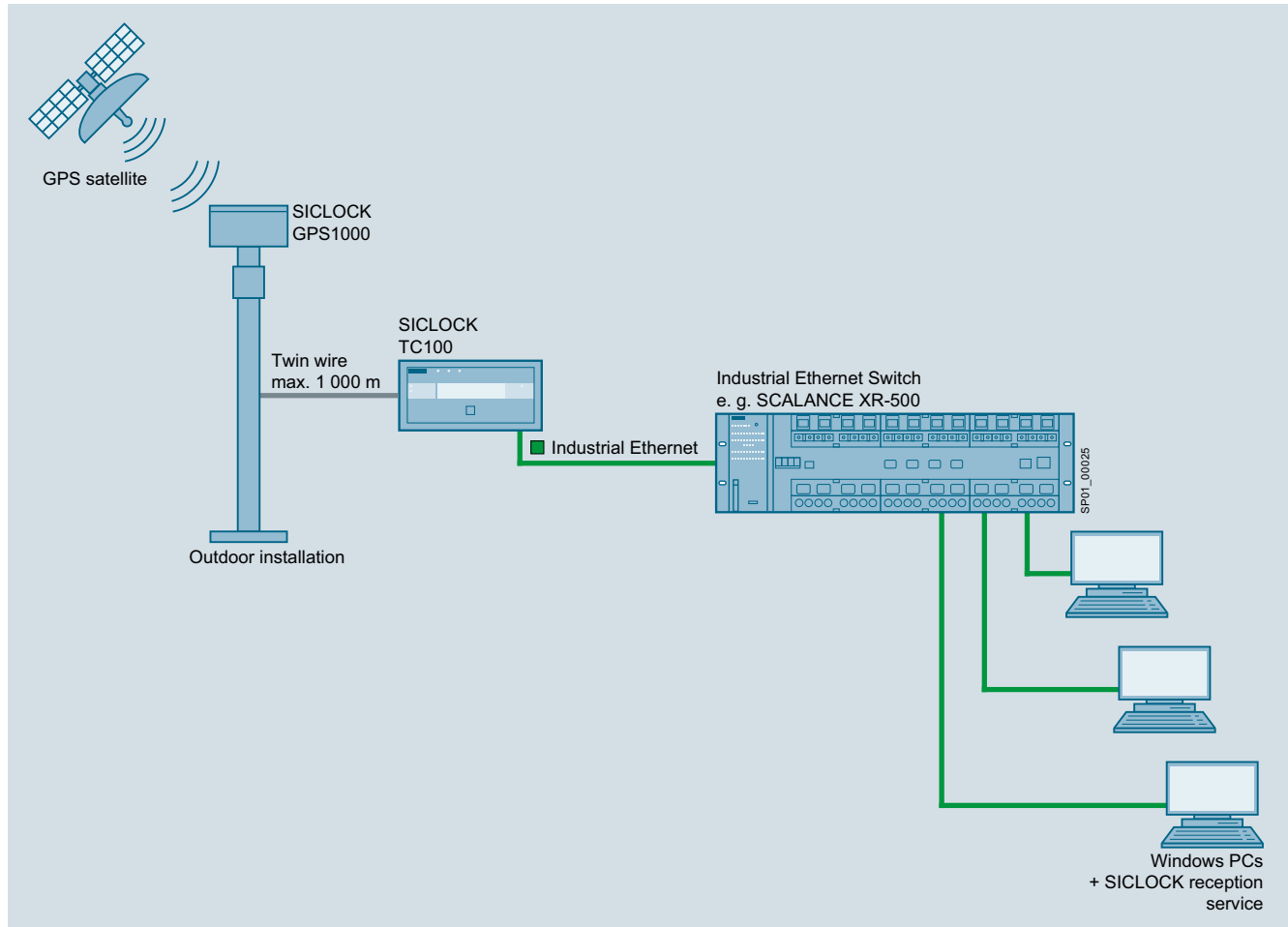

SICLOCK TC-100 central plant clock with SICLOCK GPS1000 wireless receiver: Synchronization of IT systems (with failure protection)

This application can be used for the synchronization of a large number of IT devices. The cost-optimized SICLOCK TC100 central plant clock can be used if all the stations that have to be synchronized belong to the same IP subnet. A wide range of SCALANCE X Ethernet switches is available for selection according to the number of terminal devices to be synchronized; see <http://support.automation.siemens.com/WW/view/en/18689247/133200>.



**Application** (continued)

Simple solution without failure protection for the direct supply of clock time to IT systems

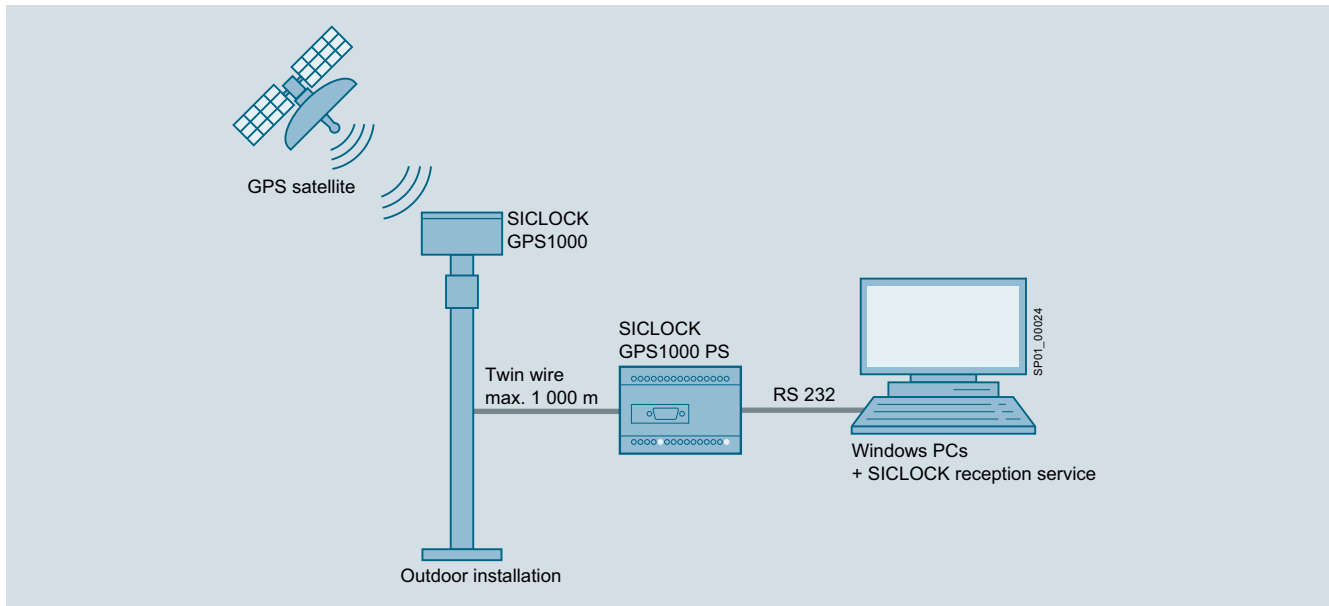

SICLOCK GPS1000 PS pulse converter with SICLOCK GPS1000 wireless receiver, synchronization of IT systems (without failure protection)

Direct connection to an IT system can be considered in applications with low failure protection requirements.

All of the required components are included in the SICLOCK GPS1000 package (Article No. 2XV9450-1AR82). The scope of delivery includes the SICLOCK GPS1000 wireless receiver with antenna base, the SICLOCK GPS1000 PS pulse converter, and a receiving software that runs on Windows systems.

**More information**

For more information, go to

- [www.siemens.com/siclock](http://www.siemens.com/siclock)
- E-mail: [siclock@siemens.com](mailto:siclock@siemens.com)

## PROFINET/Industrial Ethernet Accessories

### SICLOCK Time synchronization > Central plant clocks

#### Overview



SICLOCK TC100 and SICLOCK TC400 central plant clocks

The central plant clocks evaluate the clock time data that was transmitted from the wireless receiver and generate diverse output signals in order to synchronize the connected I/O devices.

If the wireless receiver fails or signal transmission is interrupted, the central plant clocks switch over to their internal high-precision quartz system and thus ensure reliable tracking of the clock time. When the input signal is available again, the central plant clock adjusts any time differences that may have occurred without time jumps by means of "microsteps".

#### Inputs and outputs

The high-precision SICLOCK TC100 and SICLOCK TC400 central plant clocks have one (SICLOCK TC100) or two (SICLOCK TC400) inputs for connection to wireless receivers.

The central plant clocks have one (SICLOCK TC100) or four (SICLOCK TC400) independent 10/100 Mbit Ethernet interfaces.

The network stations are synchronized using the proven SNTP standard and by means of the SIMATIC procedure.

The SICLOCK central plant clocks have two relay outputs for signaling alarms or warnings.

Alternatively and/or in addition, two point-to-point connections TTY (20 mA current interface) or one RS 422 (5 V level) connection can be set up for the SICLOCK TC400 central plant clock.

#### Operation

Parameterization of the interfaces, setting of the signal types, redundancy modes, and read-out of the status messages stored in the device are conveniently implemented via the integrated web interface.

LEDs and a display indicate operating states and show any error messages, which can also be read out via the web interface.

#### Ordering data

##### Central plant clock

A wireless receiver supplies the central plant clocks with time data; these then generate signals which are used to synchronize the connected I/O devices.

- SICLOCK TC400 central plant clock, single device
- SICLOCK TC100 central plant clock, single device

#### Article No.

**2XV9450-2AR01**

**2XV9450-2AR22**

**Overview**

SICLOCK GPS1000 wireless receiver

The SICLOCK GPS1000 wireless receiver is designed to receive signals on the 1.575 GHz frequency from the GPS satellite system. The wireless receiver generates the time information (UTC – coordinated universal time) from this high frequency signal and converts it on the output side into the DCF77 time signal. The wireless receiver can be used all over the world.

The SICLOCK GPS1000 wireless receiver is designed for direct connection to SICLOCK TC100 and SICLOCK TC400 central plant clocks. The line current method used permits a distance of up to one kilometer between the wireless receiver and the central plant clock.

The antenna has to be installed outdoors for optimum reception of the satellite signals. The wireless receiver needs no parameter assignment or maintenance and, when used with SICLOCK TC100 or SICLOCK TC400 central plant clocks, is supplied by them with its operational energy.

The 2XV9450-1AR82 package is available for the direct synchronization of PCs. This package also includes the SICLOCK GPS1000 PS pulse converter for level conversion and the receiving software, which runs on PCs.

**Ordering data**
**Article No.**
*Wireless receivers*
**SICLOCK GPS1000 package**

GPS radio clock for the time synchronization of PCs as well as programmable controllers via RS 232 interface;  
 in industrial environments with high levels of interference;  
 with distances up to 1000 m between the antenna and the device,  
 package comprises

- GPS1000 antenna head with antenna frame
- GPS1000 power supply
- Distribution socket
- 5 m RS232 connecting cable
- DCF77 receiving service for Windows

**2XV9450-1AR82**
**SICLOCK GPS1000**

GPS radio clock for the time synchronization of PCs, programmable controllers, as well as the SICLOCK TC100 and SICLOCK TC400 central plant clocks;  
 Single device incl. installation material

**2XV9450-1AR84**

## PROFINET/Industrial Ethernet

### Accessories

#### SICLOCK Time synchronization > DCF77 receivers

##### Overview



SICLOCK DCFRS wireless receiver (without antenna base)

SICLOCK DCFRS wireless receivers receive signals from the DCF77 time signal transmitter. The DCF77 transmitter is located in Mainflingen near Frankfurt am Main and transmits long-wave signals at a frequency of 77.5 kHz. Under good reception conditions, signals can be received within a radius of up to 1 500 km of the transmitter location.

Unlike devices that receive signals from satellites, the SICLOCK DCFRS can also be used inside buildings. SICLOCK DCF77 wireless receivers output the demodulated DCF77 time signal.

SICLOCK DCF77 wireless receivers are available in two versions:

- SICLOCK DCFRS with TTY interface (20 mA current interface) for direct connection to central plant clocks
- SICLOCK DCFRS with RS 232 signal level for connection to PCs

##### Note:

We recommend the software DCF77 receiving service (Article No. 2XV9450-1AR28) if the RS 232 version is used, see "Accessories". Parameter assignment is not necessary for both receiver versions.

##### Ordering data

##### Article No.

###### *Wireless receivers*

###### **SICLOCK DCFRS**

DCF radio clock for the time synchronization of PCs and programmable controllers

- Active DCF77 antenna with TTY output (20 mA line current) spare part

**2XV9450-1AR16**

###### **SICLOCK DCFRS**

DCF radio clock for the time synchronization of individual PCs over short distances, package comprises

- Active DCF77 antenna with RS 232 interface and mounting bracket
- 20 m connecting cable, mounted

**2XV9450-1AR06**

###### **SICLOCK DCFRS**

DCF radio clock for the time synchronization of individual PCs over short distances, package comprises

- Active DCF77 antenna with RS 232 interface and mounting bracket
- 20 m connecting cable, mounted
- DCF77 receiving service for Windows

**2XV9450-1AR14**

###### **SICLOCK DCFRS**

DCF radio clock for the time synchronization of PCs and programmable controllers package comprises

- Active DCF77 antenna with TTY output (20 mA line current) and antenna frame
- TTY/RS 232 converter
- Plug-in power supply
- Two distribution sockets
- 1 m connecting cable mounted, extendable to 1000 m
- DCF77 receiving service for Windows

**2XV9450-1AR21**

## Overview

The pulse converter is available in three versions:

- SICLOCK PCON
- SICLOCK EOPC
- SICLOCK GPS1000 PS



SICLOCK GPS1000 PS, SICLOCK PCON and SICLOCK EOPC pulse converters

### SICLOCK PCON pulse converter

The SICLOCK PCON is a single-channel, electrical-optical pulse converter. It enables electrical and optical time frames and pulses to be distributed.

The device has three inputs for electrical signals (RS 422, RS 232, etc.), one optical input, as well as five electrical outputs and one optical output. By using fiber-optic cables, longer distances can be bridged with very high interference immunity.

The SICLOCK PCON pulse converter can be operated in two modes:

- In transparent mode, the input signal is output at all outputs without any change.
- In pulse mode, an edge change at the input triggers a pulse with parameterizable length at all outputs.

The device is easily parameterized by means of DIP switches located directly on the device.

Inputs X1	Outputs X2
RS 422 (non-isolated)	RS 422 (non-isolated)
RS 232 (non-isolated)	RS 232 (non-isolated)
Pulse input 5 ... 35 V or 5 ... 70 V	Pulse output 24 V (non-isolated) Pulse output 24 ... 220 V (isolated)
FOC	FOC
BFOC connection system	BFOC connection system TTY 20 mA current interface

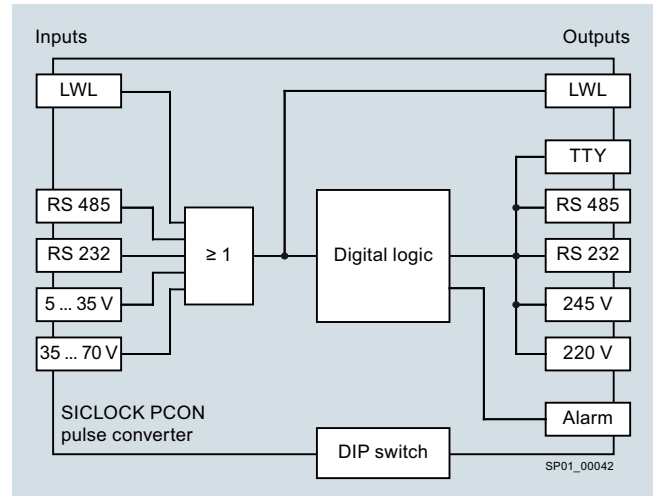

SICLOCK PCON pulse converter (functional diagram)

### SICLOCK EOPC pulse converter

The SICLOCK EOPC is an electrical-optical converter and hub. It features two electrical inputs, which can be alternatively used, and transfers these signals at its 32 fiber-optic outputs. This pulse converter is therefore the ideal choice for applications with numerous nodes with optical pulse interface which have to be synchronized.

Inputs X1	Outputs
TTY 20 mA current interface	32 x BFOC 62.5/125 μm
Pulse input 10 ... 65 V	

### SICLOCK GPS1000 PS pulse converter

The SICLOCK GPS1000 PS pulse converter is always used when a SICLOCK wireless receiver is used as stand-alone unit, i.e. without a central plant clock. It fulfills two main functions:

- On the one hand, the pulse converter is used as an energy source for SICLOCK wireless receivers.
- On the other hand, the device is used as a level converter.

The time signal received at input 11/12 is output as RS 232 level at the Sub-D interface X3.

Inputs	Outputs
TTY 20 mA current interface to the wireless receiver	9-pole Sub-D RS 232 level TTY 20 mA current interface TTY-inverted 20 mA current interface

## PROFINET/Industrial Ethernet Accessories

### SICLOCK Time synchronization > Pulse converters

#### Ordering data

#### Article No.

##### *Pulse converters*

#### **SICLOCK PCON**

Single-channel, electrical-optical pulse converter for industrial applications, 820 nm, 24 ... 230 V AC/DC, with multimode fiber optic connection

**2XV9450-1AR63-1SA3**

#### **SICLOCK EOPC**

Electrical-optical pulse converter for industrial applications with 32 fiber-optic cable outlets for transparent operation and pulse mode, 24 ... 110 V DC

**2XV9450-1AR72**

#### **SICLOCK GPS1000 power supply 230 V**

**2XV9450-1AR85-0AA2**

2

**Overview**
**Software**

For less complex applications, the wireless receivers can even be operated without central plant clocks.

Two software packages are available for such applications to process the time information on Windows computers or in a SIMATIC PLC.

- 2XV9450-1AR28: SICLOCK DCF77 receiving service software for Windows XP, Windows Vista, Windows 7, Windows Server 2003/2008/2008 R2
- 2XV9450-1AR32: SICLOCK DCF77 receiving service software for SIMATIC S7-300 and S7-400

**Lightning protection**

The 2XV9450-1AR83 lightning protection element is integrated by default into the connecting cable downstream of the wireless receiver and protects the components connected to it against overvoltage caused by lightning strikes.

**Mounting hardware**

For easy installation in 19" rack units, a 2XV9450-2AR81 mounting frame for two SICLOCK TC100 and/or SICLOCK TC400 central plant clocks each is available.

**Ordering data**
**Article No.**
*Accessories*
**Software**

- Receiving service software for Windows
- Receiving service software for SIMATIC

**2XV9450-1AR28**
**2XV9450-1AR32**
**Lightning protection for antenna cable**

Lightning protection for TTY connection cable for SICLOCK GPS1000 or SICLOCK DCFRS wireless receivers

**2XV9450-1AR83**
**Mounting frame for SICLOCK TC100 and SICLOCK TC400 central plant clocks**
**2XV9450-2AR81**

## PROFINET/Industrial Ethernet SIMATIC PCS 7 process control systems

### Automation systems

#### Overview



SIMATIC PCS 7 automation systems in various designs:  
Modular S7-400 systems as well as embedded systems (mEC and Microbox system)

Automation systems are available in three different designs for the SIMATIC PCS 7 process control system. The automation performance can therefore be finely scaled within wide limits.

The automation systems offered can be classified as follows:

- Modular systems of the S7-400 series with hardware controller in the versions "Standard", "High availability" and "Safety-related"
  - AS 410 automation systems
  - Complementary S7-400 systems
- Embedded systems with software controller
  - mEC automation system
  - Microbox automation system

#### Application

Automation system with APL	AS 412H	AS 414-3	AS 414-3IE	AS 414H	AS 416-2	AS 416-3	AS 416-3IE	AS 416H	AS 417-4	AS 417H	AS RTX	AS mEC
	AS 410											
Analog value measurements	10	50	100	100	200	400	400	400	500	600	300	300
Digital value measurements	20	160	250	250	450	800	800	800	1 000	1 000	600	600
PID controls	5	35	50	50	75	150	150	150	180	200	200	200
Motors	7	40	75	75	100	200	200	200	350	400	150	150
Valves	7	40	75	75	100	200	200	200	350	400	250	250
SFC	0	15	15	15	40	100	100	100	200	200	100	100
Steps	0	150	150	150	400	1 000	1 000	1 000	2 000	2 000	800	800
Dosing	0	3	3	3	15	25	25	25	50	50	50	50
Digital inputs DI	30	200	350	300	600	1 200	1 200	1 200	1 700	1 800	1 200	1 200
Digital outputs DO	10	60	100	110	200	400	400	400	550	650	400	400
Analog inputs AI	15	100	175	150	300	600	600	600	800	900	600	600
Analog outputs AO	5	30	75	50	100	200	200	200	250	350	200	200
Process objects (PO)	30	200	350	350	600	1 200	1 200	1 200	1 800	2 000	1 200	1 200

Typical mixed configuration limits for SIMATIC PCS 7 automation systems, based on the SIMATIC PCS 7 Advanced Process Library (APL)

#### Note:

The values quoted here are not AS-specific maximum values for the particular item. Instead, they represent a typical distribution of the available total capacity of the AS during mixed operation of all the items of a contiguous block.

The number of process objects is not an absolute value, but depends on the library used as well as on the number and type of blocks used in the application.



**Application** (continued)**Modular automation systems of the S7-400 range**

The rugged automation systems of the S7-400 series are suitable for universal use. They are characterized by high processing and communication performance. The product range offered differs with regard to the area of application as follows:

- **AS 410 automation systems**
  - Preferred systems for new plants with SIMATIC PCS 7 V8.0
  - Suitable for SIMATIC PCS 7 as of V8.0+SP1, including hardware upgrade package (HUP CPU 410-5H)
  - Performance of the general purpose CPU scalable based on the number of process objects

AS type	Features
<b>Standard systems, high availability and safety-related systems</b>	
AS 410S/H/F/FH	CPU 410-5H Process Automation (1 x or 2 x) Interfaces: 1 x PN/IE (2 ports), 1 x DP

- **Complementary S7-400 systems**
  - Can be used in plants with SIMATIC PCS 7 V8.0, V7.1, or V7.0
  - As an alternative to AS 410, primarily in systems with SIMATIC PCS 7 V7.0/V7.1
  - Scalable based on types of CPU differing in performance

AS type	Features
<b>Standard systems</b>	
AS 414-3	Standard CPU, interfaces: 1 x MPI/DP, 1 x DP, 1 x DP module can be optionally inserted
AS 414-3IE	Standard CPU, interfaces: 1 x PN/IE (2 ports), 1 x MPI/DP, 1 x DP module can be optionally inserted
AS 416-2	Standard CPU, interfaces: 1 x MPI/DP, 1 x DP
AS 416-3	Standard CPU, interfaces: 1 x MPI/DP, 1 x DP, 1 x DP module can be optionally inserted
AS 416-3IE	Standard CPU, interfaces: 1 x PN/IE (2 ports), 1 x MPI/DP, 1 x DP module can be optionally inserted
AS 417-4	Standard CPU, interfaces: 1 x MPI/DP, 1 x DP, 2 x DP module can be optionally inserted

**High availability and safety-related systems**

AS 412H/F/FH	H-CPU (1 x or 2 x), interfaces: 1 x PN/IE (2 ports), 1 x MPI/DP, 1 x DP
AS 414H/F/FH	H-CPU (1 x or 2 x), interfaces: 1 x PN/IE (2 ports), 1 x MPI/DP, 1 x DP
AS 416H/F/FH	H-CPU (1 x or 2 x), interfaces: 1 x PN/IE (2 ports), 1 x MPI/DP, 1 x DP
AS 417H/F/FH	H-CPU (1 x or 2 x), interfaces: 1 x PN/IE (2 ports), 1 x MPI/DP, 1 x DP

**Embedded automation systems**

The SIMATIC PCS 7 AS mEC RTX and SIMATIC PCS 7 AS RTX embedded automation systems are low-price, compact systems for the lower and medium performance ranges. They are particularly suitable for small applications, especially at plant level and as OEM products, e.g. in package units.

Both systems have exceptional physical properties, but differ with regard to design and expandability.

- SIMATIC PCS 7 AS mEC RTX
  - S7-300 design
  - Centrally expandable with up to 8 S7-300 I/O modules
  - PROFINET IO interface for connection to ET 200M distributed remote I/O stations
- SIMATIC PCS 7 AS RTX
  - Microbox design
  - Routing-capable PROFIBUS DP interface for connecting ET 200M, ET 200iSP, ET 200S and ET 200pro distributed remote I/O stations and intelligent field and process devices to PROFIBUS DP/PA

**More information****Catalog information**

- For detailed information and ordering data for AS 410 automation systems, refer to the following catalog section "Modular AS 410 systems".
- For information and ordering data for AS 412 to AS 417 automation systems (standard systems, high availability and safety-related systems), see "Complementary S7-400 systems" in the following.
- For detailed information and ordering data for the SIMATIC PCS 7 AS mEC RTX automation system, see the section "Embedded systems", "mEC automation system" below.
- For detailed information and ordering data for the SIMATIC PCS 7 AS RTX automation system, see the section "Embedded systems", "Microbox automation system" below.

**Online configurators**

Selected SIMATIC S7-400 components are combined as "AS bundles" according to the task involved for the modular SIMATIC PCS 7 automation systems. Configurators in the Industry Mall ([www.siemens.com/industrymall](http://www.siemens.com/industrymall)) help you to assemble the AS bundles:

- Online configurators for AS 410 automation systems
  - SIMATIC PCS 7 AS 410 Single Station configurator
  - SIMATIC PCS 7 AS 410 Redundancy Station configurator
- Online configurators for complementary S7-400 systems
  - SIMATIC PCS 7 AS Single Station configurator
  - SIMATIC PCS 7 AS Redundancy Station configurator

## PROFINET/Industrial Ethernet SIMATIC PCS 7 process control systems

### AS 410 modular systems

#### Overview

With the rugged all-round system AS 410, the SIMATIC PCS 7 process control system for the first time offers an exclusive automation system from the SIMATIC S7-400 series, which can be used in all domains due to its versatility. For specific requirements, you can configure it as a:

- Standard AS 410S automation system
- Fault-tolerant AS 410H automation system
- Safety-related AS 410F/FH automation system

With its high-performance hardware and optimized V8.0 firmware, the innovative CPU 410-5H Process Automation of the AS 410 covers the entire spectrum of conventional AS 412 to AS 417 automation systems. Its automation performance can be flexibly scaled based on the number of SIMATIC PCS 7 process objects (PO).

System expansion cards are available for

- 100 PO
- 500 PO
- 1 000 PO
- 1 600 PO
- $\geq 2\ 000$  PO (PO 2k+)

The type reduction to a single CPU offers numerous advantages. It significantly simplifies selection and configuration of the automation system as well as spare part inventory and plant expansion.

#### Note:

The configuration of the CPU 410-5H Process Automation of the AS 410 and the loading of the user blocks is only possible with SIMATIC PCS 7 engineering software as of V8.0+SP1 (including hardware upgrade package HUP CPU 410-5H).

#### Design

Similar to all SIMATIC PCS 7 automation systems of the S7-400 series, AS 410 automation systems are available as "AS bundles" as follows:

- Individual components bundled per system in one delivery
- Pre-assembled and tested complete systems (no extra charge compared to delivery of individual components)

With a SIMATIC PCS 7 Industry Library Runtime license and a SIMATIC PCS 7 AS Runtime license, the AS bundles are equipped for 100 process objects (PO). Building on this, the number of process objects can be increased with cumulative AS Runtime licenses for 100, 1 000 or 10 000 POs.

The configuration of the AS bundles and their article numbers can be defined by selecting pre-configured ordering units. System-specific ordering configurations are available in tabular form for this purpose in the sections "Standard automation systems", "Fault-tolerant automation systems" and "Safety-related automation systems".

For interactive configuration of AS bundles, two online configurators are also available in the Industry Mall ([www.siemens.com/industrymall](http://www.siemens.com/industrymall)):

- SIMATIC PCS 7 AS 410 Single Station configurator
- SIMATIC PCS 7 AS 410 Redundancy Station configurator

#### Flexible and scalable availability

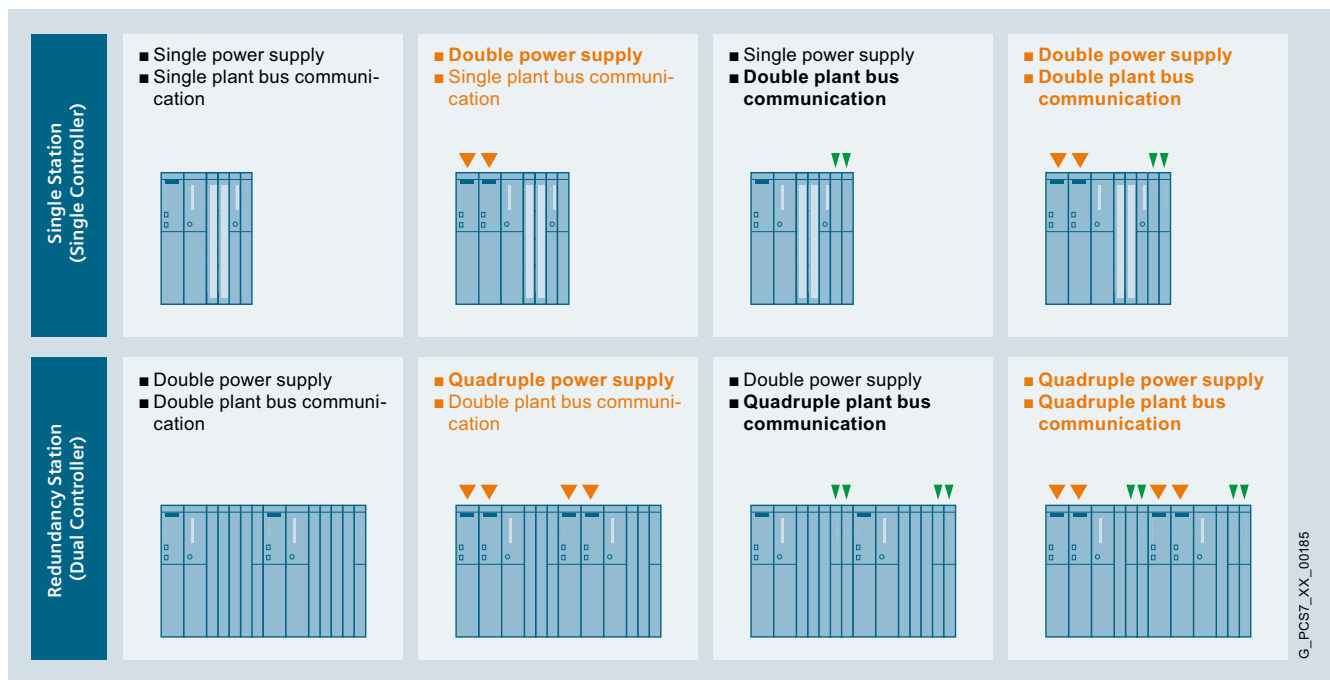

### Design (continued)

A particular characteristic of the modular S7-400 systems is the flexible and scalable availability of various components.

For a SIMATIC PCS 7 AS Single Station of the AS 410 type, you have the option of specifically increasing the availability by implementing a redundant configuration of the power supply or the Industrial Ethernet communications module, and combining these measures.

Even the AS Redundancy Station of the AS 410 type with its redundant CPUs offers significantly higher availability. It operates according to the 1oo2 principle, in which a switch is made from the active subsystem to the standby system in the event of a fault. Starting from here, you can double the power supply or the Industrial Ethernet communications module for each subsystem, and combine these measures.

### CPU 410-5H Process Automation

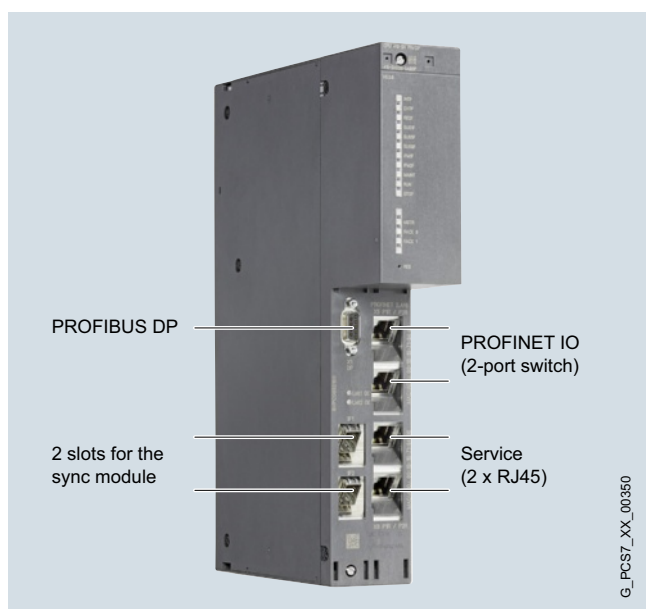

CPU 410-5H Process Automation

The CPU 410-5H Process Automation is the heart of standard automation systems, as well as the fault-tolerant and safety-related AS 410 automation systems. Expansion cards for 100 PO, 500 PO, 1 000 PO, 1 600 PO and  $\geq 2\ 000$  PO (PO 2k+) can be used to increase their performance in a user-defined manner to up to approximately 2 600 PO.

As shown in the figure, CPU 410-5H Process Automation is equipped with a PROFINET IO interface (2-port switch) for up to 250 I/O devices and a PROFIBUS DP interface for up to 96 PROFIBUS DP slaves. Two integrated slots allow the synchronization of two redundant subsystems via sync modules and sync cables (FOC).

CPU 410-5H Process Automation supports NTP as well as S7 time synchronization.

Other features include:

- Integrated 48 MB load memory and 16 MB RAM each for program and data
- Cycle time up to 10 ms/9 process tasks
- Total number of I/Os (on PROFIBUS DP and PROFINET IO) approx. 7 500 (16 KB each for inputs and outputs)
- Additional protection of the circuit board with coating (conformal coating)
- High-precision time stamping
- Recessed RESET button
- Preset hardware parameters (PCS 7 skinning)

For detailed information about CPU 410-5H Process Automation, see "Technical specifications".

### I/O connection via PROFIBUS DP

The distributed process I/O can be integrated into a PROFIBUS DP segment either directly or via a lower-level fieldbus (PROFIBUS PA or FOUNDATION Fieldbus H1). For details on this, see sections "PROFIBUS DP", "PROFIBUS PA" and "FOUNDATION Fieldbus H1" in the "Communication" chapter.

PROFIBUS DP segments with distributed process I/O can be operated on a PROFIBUS DP interface in the CPU and on additive CP 443-5 Extended (conformal coating) PROFIBUS DP interfaces. You can configure up to 4 individual or redundant CP 443-5 Extended PROFIBUS DP interfaces (conformal coating) for an automation system using the configurators for SIMATIC PCS 7 automation systems in the Industry Mall as well as in the catalog sections "Standard automation systems", "Fault-tolerant automation systems" and "Safety-related automation systems".

You can additionally implement further PROFIBUS interfaces using separately ordered CP 443-5 Extended PROFIBUS DP interfaces (conformal coating). According to the manual, up to 10 CP 443-5 Extended interfaces (conformal coating) can be operated in one automation system.

### I/O connection via PROFINET IO

You can easily and efficiently connect AS 410 automation systems to remote I/O stations via the PROFINET IO interface integrated in the CPU 410-5H Process Automation, for example, to remote ET 200M I/O stations (see also the "PROFINET" section in the "Communication" chapter). PROFINET IO interfaces made available by additive communication modules of the CP 443-1 type (conformal coating) cannot be used.

# PROFINET/Industrial Ethernet

## SIMATIC PCS 7 process control systems

### AS 410 modular systems

#### Technical specifications

CPU 410-5H Process Automation	
<b>General information</b>	
Firmware version	V8.0
Engineering with	SIMATIC PCS 7 V8.0+SP1 + HUP CPU 410-5H
Degree of protection	IP20
Version	Conformal coating
<b>Power supply</b>	
Supply voltage	5 V DC from SV system
Input current	
• From backplane bus, 5 V DC max.	1.7 A
• From interface 5 V DC, max.	90 mA
Power loss, typical	7.5 W
<b>Memory</b>	
RAM	
• For program	16 MB
• For data	16 MB
Load memory, integrated	48 MB
Buffering with battery	Yes, all data
<b>CPU performance</b>	
Clock	450 MHz (multiprocessor system)
Average processing time of APL typicals	Approx. 110 µs
PCS 7 process objects, can be set with system expansion card	Up to approx. 2 600
<b>Process tasks</b>	
Cyclic interrupts (can be set from 10 ms to 5 s)	9
<b>I/O</b>	
Total number of I/Os	Approx. 7 500 (16 KB inputs/outputs)
Number of I/Os per DP interface	Approx. 3 800 (8 KB inputs/outputs)
Number of I/Os per PN interface	Approx. 3 800 (8 KB inputs/outputs)

CPU 410-5H Process Automation	
<b>Communication</b>	
Number of S7 connections	120
Alarm_8P	10 000 (max. 80 000 messages)
<b>Interfaces</b>	
• X1: PROFIBUS DP	1 x up to 12 Mbps, 9-pin Sub-D socket
• X5: PROFINET IO with 2 ports	2 x 10/100 Mbps, RJ45
• X8: Service	2 x RJ45
• IF1: Sync module slot (redundant systems)	Sync module 1
• IF2: Sync module slot (redundant systems)	Sync module 2
<b>Electromagnetic compatibility (EMC)</b>	
Emission of radio interference acc. to EN 55011	Limit class A, for use in industrial areas
<b>Climatic conditions</b>	
Temperature	
• Operation	0 ... 60 °C
Relative humidity	
• Operation	0 to 95%, without condensation
<b>Standards, specifications, approvals</b>	
CE mark	Yes
cULus	Yes
CSA approval	Yes
FM approval	Yes
ATEX approval	Yes
<b>Dimensions and weights</b>	
Dimensions (W x H x D in mm)	50 x 290 x 219
Weight	approx. 1.1 kg

#### Accessories

##### Backup batteries

Lithium backup batteries of type AA with 2.3 Ah are used in the power supply modules of all SIMATIC PCS 7 automation systems of the S7-400 range (AS bundles). Since lithium batteries are easily inflammable, more rigorous transport and storage regulations apply to them.

To avoid subjecting the AS bundles to these more rigorous transport and storage regulations, the backup batteries must be ordered and delivered separately (order no. 6ES7971-0BA00).

The following backup batteries are required depending on the configuration of the AS bundles:

- SIMATIC PCS 7 AS Single Station with
  - 1 power supply module: 2 units
  - 2 redundant power supply modules: 4 units
- SIMATIC PCS 7 AS Redundancy Station with
  - 2 power supply modules: 4 units
  - 2 x 2 redundant power supply modules: 8 units

### Overview



Standard AS 410S automation system

The AS 410S modular standard automation systems are suitable for general use. These are always your first choice if high availability through redundancy and safety-related functions are not relevant for the application.

In the range from 100 to approx. 2 600 PO, their performance can be customized to meet the task at hand using expansion cards (for more information, see the previous section of the catalog "Modular S7-400 systems").

An AS 410S is also the base system for a fault-tolerant (AS 410H) or a safety-related automation system (AS 410F, AS 410FH). Your decision for the AS 410S is therefore not final, you can remain flexible. If the task changes, the automation system can be used differently at any time and the target system can be expanded accordingly.

### Design

#### Individual configuration of AS bundles

The equipment of the standard automation systems as well as their article numbers can be individually compiled by selecting pre-configured ordering units.

Typical combinations can be selected from tables in the section "Ordering data". The complete range is available to you via the SIMATIC PCS 7 AS 410 Single Station online configurator in the Industry Mall ([www.siemens.com/industrymall](http://www.siemens.com/industrymall)).

#### I/O connection via PROFIBUS DP

Several PROFIBUS DP segments with distributed process I/Os can be operated on one standard automation system. A PROFIBUS DP interface is already integrated in the CPU 410-5H Process Automation. Using the configurator in the Industry Mall or in the selection and ordering data, up to four more PROFIBUS DP interfaces can be configured via additional CP 443-5 PROFIBUS DP interfaces (conformal coating).

#### I/O connection via PROFINET IO

Standard automation systems AS 410S can only be connected to remote I/O stations, for example, ET 200M remote I/O stations via the PROFINET interface (2-port switch) integrated in CPU 410-5H Process Automation (see also chapter "Communications", section "PROFINET").

The availability of the I/O devices can be increased by a ring topology with media redundancy (MRP). If the transmission link in the ring is interrupted at a given location, for example, due to a break in the ring cable or the failure of a station, the redundancy manager, e.g. the CPU, immediately activates the alternative communication path.

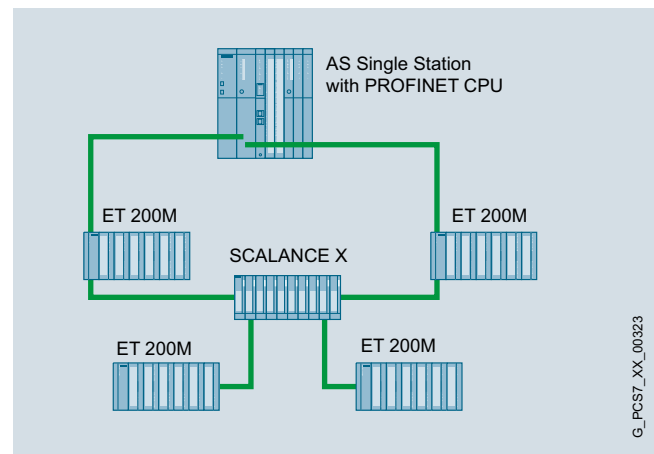

Example for PROFINET IO communication with media redundancy

#### Industrial Ethernet (IE) plant bus communication

If the PROFINET interface integrated in the CPU is not used for PROFINET IO, it can also be used for the connection to the Industrial Ethernet plant bus. Otherwise, the AS 410S standard automation system can be connected to the Industrial Ethernet plant bus via a CP 443-1 (conformal coating) communication module. The availability of the plant bus communication can be increased with a second communication module.

#### Redundant power supply

If you have two separate power supply networks for your plant, you can increase the availability of the AS 410S standard automation systems by using two redundant power supplies.

#### Runtime licenses

With a SIMATIC PCS 7 Industry Library Runtime license and a SIMATIC PCS 7 AS Runtime license, the AS bundle is equipped for 100 process objects (PO). The number of process objects can be extended by additional Runtime licenses for 100, 1 000 or 10 000 POs. The process objects of additional Runtime licenses can be added to process objects which already exist. The number and type (e.g. 100 or 1 000) of additional Runtime licenses are irrelevant with regard to the implementable quantity framework.

# PROFINET/Industrial Ethernet

## SIMATIC PCS 7 process control systems

### Standard automation systems

#### Ordering data

#### Article No.

<b>AS 410S</b> CPU 410-5H with PROFIBUS DP and PROFINET IO interface 32 MB RAM (16 MB each for program and data) with SIMATIC PCS 7 AS Runtime license for 100 PO and SIMATIC PCS 7 Industry Library Runtime license	<b>6ES7654-</b>	<b>C</b>	<b>0</b>	<b>-</b>	<b>F</b>
<b>Type of delivery</b>					
• Individual components, not pre-assembled					<b>5</b>
• Pre-assembled and tested					<b>6</b>
<b>System expansion card</b>					
• System expansion card 100 PO				<b>J</b>	
• System expansion card 500 PO				<b>L</b>	
• System expansion card 1 000 PO				<b>N</b>	
• System expansion card 1 600 PO				<b>P</b>	
• System expansion card PO 2k+ (≥ 2 000)				<b>Q</b>	
<b>Additive Industrial Ethernet interfaces<sup>1)</sup></b>					
• Without CP 443-1					<b>0</b>
• 1 x CP 443-1 (conformal coating)					<b>3</b>
• 2 x CP 443-1 (conformal coating)					<b>4</b>
<b>Racks</b>					
• UR2 (9 slots), aluminum <sup>1)</sup>					<b>3</b>
• UR2 (9 slots), steel <sup>1)</sup>					<b>4</b>
• UR1 (18 slots), aluminum					<b>5</b>
• UR1 (18 slots), steel					<b>6</b>
<b>Power supply (without backup batteries)</b>					
• 1 x PS 407, 10 A for 120/230 V AC/DC					<b>B</b>
• 1 x PS 407, 10 A for 120/230 V AC/DC, optional redundancy					<b>C</b>
• 1 x PS 407, 20 A for 120/230 V AC/DC					<b>D</b>
• 2 x PS 407, 10 A for 120/230 V AC/DC, redundant					<b>E</b>
• 1 x PS 405, 10 A for 24 V DC					<b>G</b>
• 1 x PS 405, 10 A for 24 V DC, optional redundancy					<b>H</b>
• 1 x PS 405, 20 A for 24 V DC					<b>J</b>
• 2 x PS 405, 10 A for 24 V DC, redundant					<b>K</b>
<b>Additive PROFIBUS DP interfaces<sup>1)</sup></b>					
• Without CP 443-5 Extended					<b>0</b>
• 1 x CP 443-5 Extended (conformal coating)					<b>1</b>
• 2 x CP 443-5 Extended (conformal coating)					<b>2</b>
• 3 x CP 443-5 Extended (conformal coating)					<b>3</b>
• 4 x CP 443-5 Extended (conformal coating)					<b>4</b>

<sup>1)</sup> Up to 5 CPs (Industrial Ethernet/PROFIBUS) can be plugged into the UR2 rack with a single power supply, or up to 3 with a redundant power supply.

#### Article No.

#### Individual components

##### Individual components for AS 410S standard automation systems

<b>CPU 410-5H Process Automation (conformal coating)</b> 32 MB RAM integrated (16 MB each for program and data); module occupies 2 slots	<b>6ES7410-5HX08-0AB0</b>
<b>CPU 410-5H Process Automation 100 PO Bundle</b> CPU bundle, consisting of CPU 410-5H Process Automation and system expansion card for 100 PO	<b>6ES7654-5CJ00-0XF0</b>
<b>CPU 410-5H Process Automation 500 PO Bundle</b> CPU bundle, consisting of CPU 410-5H Process Automation and system expansion card for 500 PO	<b>6ES7654-5CL00-0XF0</b>
<b>CPU 410-5H Process Automation 1 000 PO Bundle</b> CPU bundle, consisting of CPU 410-5H Process Automation and system expansion card for 1 000 PO	<b>6ES7654-5CN00-0XF0</b>
<b>CPU 410-5H Process Automation 1 600 PO Bundle</b> CPU bundle, consisting of CPU 410-5H Process Automation and system expansion card for 1 600 PO	<b>6ES7654-5CP00-0XF0</b>
<b>CPU 410-5H Process Automation PO 2k+ Bundle</b> CPU bundle, consisting of CPU 410-5H Process Automation and system expansion card for PO 2k+ (≥ 2 000)	<b>6ES7654-5CQ00-0XF0</b>
<b>SIMATIC NET CP 443-1 (conformal coating)</b> Communication module for connecting SIMATIC S7-400 to Industrial Ethernet through TCP/IP, ISO, and UDP; PROFINET IO controller, MRP; integrated real-time switch ERTEC with two ports; 2 x RJ45 interface; S7 communication, open communication (SEND/RECEIVE) with FETCH/WRITE, with or without RFC 1006, DHCP, SNMP V2, diagnostics, multicast, access protection over IP access list, initialization over LAN 10/100 Mbit/s; with electronic manual on DVD	<b>6GK7443-1EX30-0XE1</b>
<b>SIMATIC NET CP 443-5 Extended (conformal coating)</b> Communications processor for connection of SIMATIC S7-400 to PROFIBUS as DP master or for S7 communication, for increasing the number of DP lines, for data set routing with SIMATIC PDM and for 10-ms time stamping, electronic manual on CD; module occupies 1 slot	<b>6GK7443-5DX05-0XE1</b>

### Ordering data

### Article No.

#### Individual components for AS 410S standard automation systems

#### PS 407 power supply module

with battery compartment for 2 backup batteries, module occupies 2 slots

- **10 A**  
120/230 V AC/DC; 5 V DC/10 A, 24 V DC/1 A
- **10 A, redundant**  
120/230 V AC/DC; 5 V DC/10 A, 24 V DC/1 A
- **20 A**  
120/230 V AC/DC; 5 V DC/20 A, 24 V DC/1 A

6ES7407-0KA02-0AA0

6ES7407-0KR02-0AA0

6ES7407-0RA02-0AA0

#### PS 405 power supply module

with battery compartment for 2 backup batteries, module occupies 2 slots

- **10 A**  
24 V DC; 5 V DC/10 A, 24 V DC/1 A
- **10 A, redundant**  
24 V DC; 5 V DC/10 A, 24 V DC/1 A
- **20 A**  
24 V DC; 5 V DC/20 A, 24 V DC/1 A;  
with battery compartment for 2 backup batteries,  
• module occupies 2 slots

6ES7405-0KA02-0AA0

6ES7405-0KR02-0AA0

6ES7405-0RA02-0AA0

#### Backup battery

Type AA, 2.3 Ah

6ES7971-0BA00

#### Aluminum rack

- UR1, 18 slots
- UR2, 9 slots

6ES7400-1TA11-0AA0

6ES7400-1JA11-0AA0

#### Steel rack

- UR1, 18 slots
- UR2, 9 slots

6ES7400-1TA01-0AA0

6ES7400-1JA01-0AA0

### Article No.

#### Runtime licenses for SIMATIC PCS 7 automation systems

(can be added to existing licenses)

#### SIMATIC PCS 7 AS Runtime license

Independent of language, floating license for 1 user

- Delivery form package (without SIMATIC PCS 7 Software Media Package)  
License key USB stick, certificate of license
  - 100 PO
  - 1 000 PO
  - 10 000 PO
- Delivery form online (without SIMATIC PCS 7 Software Media Package)  
License key download, online certificate of license  
Note:  
E-mail address required!
  - 100 PO
  - 1 000 PO
  - 10 000 PO

6ES7653-2BA00-0XB5

6ES7653-2BB00-0XB5

6ES7653-2BC00-0XB5

6ES7653-2BA00-0XH5

6ES7653-2BB00-0XH5

6ES7653-2BC00-0XH5

## PROFINET/Industrial Ethernet SIMATIC PCS 7 process control systems

### Fault-tolerant automation systems

#### Overview



Redundancy Station AS 410H

Fault-tolerant automation systems are used to reduce the risk of production failures. The higher investment costs for fault-tolerant automation systems are frequently negligible compared to the costs resulting from production failures. The higher the costs of a production failure, the more worthwhile it is to use a fault-tolerant system.

The SIMATIC PCS 7 fault-tolerant automation systems can be used on their own in a plant configuration, or together with standard and safety-related automation systems.

#### Design

The AS 410H, which consists of two redundant, galvanically isolated subsystems, can be mounted on a UR2-H compact rack with a split backplane bus or on two separate racks (UR1 or UR2). The configuration in two racks has the advantage that the redundant subsystems are spatially separated (for example, by a fire-proof wall) and can be located far apart from each other. Depending on the sync modules used, distances from 10 m to 10 km are possible between the two subsystems. As a result of the electrical isolation, the system is also resistant to EMC interference.

#### Individual configuration of AS bundles

The equipment of the high availability automation systems as well as their article numbers can be individually defined by selecting pre-configured ordering units.

Typical combinations can be selected from tables in the section "Ordering data". The complete range for selection is available via the SIMATIC PCS 7 AS 410 Redundancy Station online configurator in the Industry Mall ([www.siemens.com/industrymall](http://www.siemens.com/industrymall)).

#### Ordering information:

- For an AS 410H redundant configuration based on two AS Single Stations (AS 410S), you additionally require 4 sync modules (up to 10 m or up to 10 km) and 2 fiber-optic sync cables. The selection depends on the distance between the two AS Single Stations.
- FO sync cables longer than 1 m must always be ordered separately (2 cables required in each case).

#### I/O connection via PROFIBUS DP

The distributed process I/O can be integrated into a PROFIBUS DP segment either directly or via a lower-level field-bus (PROFIBUS PA or FOUNDATION Fieldbus H1).

Several PROFIBUS DP segments with distributed process I/Os can be operated on an AS 410H high availability automation system. A PROFIBUS DP interface is integrated in each of the two CPUs 410-5H Process Automation. Using the online configurator in the Industry Mall or in the selection and ordering data, up to four more PROFIBUS DP interfaces can be configured for each redundant subsystem with add-on CP 443-5 PROFIBUS DP interfaces (conformal coating).

With redundant PROFIBUS DP lines, the process I/Os can be connected to an AS 410H as follows:

- ET 200M remote I/Os stations with two IM 153-2 High Feature interface modules on a special bus module
- ET 200iSP remote I/Os stations with two IM 152-1 on a special terminal module
- Field devices on the PROFIBUS PA over a PA link to two redundant IM 153-2 High Feature interface modules
- Field devices on the FOUNDATION Fieldbus H1 via an FF link with two redundant IM 153-2 FF interface modules
- Non-redundant PROFIBUS DP devices, e.g. ET 200S or ET 200pro remote I/O stations per Y-Link

#### I/O connection via PROFINET IO

High availability AS 410H automation systems can be connected via PROFINET IO with remote I/O stations, for example, ET 200M remote I/O stations. Only the PROFINET interfaces integrated in the CPUs can be used for this on the automation system.

The maximum availability with minimum error reaction times is achieved by the AS 410H when used in conjunction with system redundancy of the I/O devices. System redundancy refers to a type of PROFINET IO communication in which each I/O device establishes a communication link to each of the two CPUs of an AS 410H over the topological network. Then, the failure of a CPU does not automatically lead to failure of the connected I/O devices.

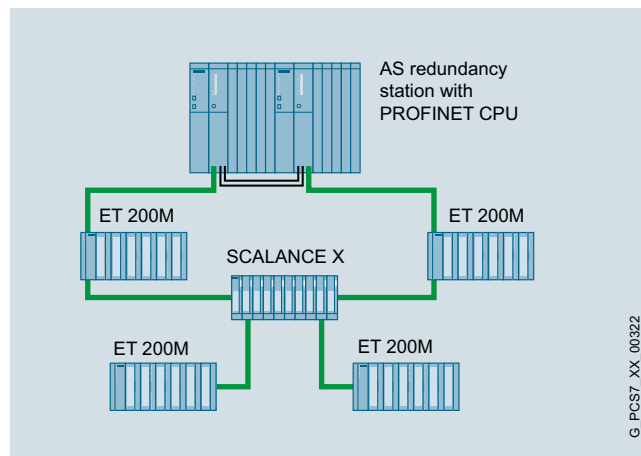

PROFINET IO communication with system redundancy

G\_PCS7\_XX\_00322



**Design** (continued)**Communication via the Industrial Ethernet (IE) plant bus**

If the PROFINET interface integrated in the CPUs of the AS 410H is not used for PROFINET IO, it can also be used for the connection to the Industrial Ethernet plant bus. Otherwise, the two subsystems of the AS 410H can be connected to the plant bus using one CP 443-1 communication module (conformal coating) each.

The plant bus can be implemented in the form of a ring structure, which can also be configured with redundant architecture if the availability requirements are high. When there are two redundant rings it makes sense to use two communications processors in each case and to distribute their connections between the two rings (4-way connection). Double faults such as failure of the switch on ring 1 with simultaneous interruption of the bus cable on ring 2 can thus be tolerated.

**Runtime licenses**

With SIMATIC PCS 7 Industry Library Runtime and the SIMATIC PCS 7 AS Runtime license, the automation systems are equipped with 100 process objects (PO) on delivery. The number of process objects can be extended by additional Runtime licenses for 100, 1 000 or 10 000 POs. The process objects of additional Runtime licenses can be added to process objects which already exist. The number and type (e.g. 100 or 1 000) of additional Runtime licenses are irrelevant.

**Ordering data****Article No.**

Ordering data	Article No.
<b>AS 410H (Redundancy Station)</b> 2 x CPU 410-5H with PROFIBUS DP and PROFIBET IO interface 32 MB RAM (16 MB each for program and data) with SIMATIC PCS 7 AS Runtime license for 100 PO and SIMATIC PCS 7 Industry Library Runtime license	6ES7656- C - - - - F
<b>Type of delivery</b>	
• Individual components, not pre-assembled	5
• Pre-assembled and tested	6
<b>System expansion card</b>	
• 2 x System expansion card 100 POs	J
• 2 x System expansion card 500 POs	L
• 2 x System expansion card 1 000 POs	N
• 2 x System expansion card 1 600 POs	P
• 2 x System expansion card PO 2k+ (≥ 2 000)	Q
<b>Sync modules and cables</b>	
• 2 x 2 sync modules for distances up to 10 m and 2 x FO sync cable, 1 m	3
• 2 x 2 sync modules for up to 10 km and 2 x FO sync cable, 1 m, for testing	4
<b>Additive Industrial Ethernet interfaces<sup>1)</sup></b>	
• Without CP 443-1	0
• 2 x 1 CP 443-1 (conformal coating)	3
• 2 x 2 CP 443-1 (conformal coating)	4
<b>Racks</b>	
• 1 x UR2-H (2 x 9 slots), aluminum <sup>1)</sup>	1
• 1 x UR2-H (2 x 9 slots), steel <sup>1)</sup>	2
• 2 x UR2 (9 slots), aluminum <sup>1)</sup>	3
• 2 x UR2 (9 slots), steel <sup>1)</sup>	4
<b>Power supply (without backup batteries)</b>	
• 2 x PS 407, 10 A for 120/230 V AC/DC	B
• 2 x PS 407, 10 A for 120/230 V AC/DC, optional redundancy	C
• 2 x PS 407, 20 A for 120/230 V AC/DC	D
• 2 x 2 PS 407, 10 A for 120/230 V AC/DC, redundant	E
• 2 x PS 405, 10 A for 24 V DC	G
• 2 x PS 405, 10 A for 24 V DC, optional redundancy	H
• 2 x PS 405, 20 A for 24 V DC	J
• 2 x 2 PS 405, 10 A for 24 V DC, redundant	K
<b>Additive PROFIBUS DP interfaces<sup>1)</sup></b>	
• Without CP 443-5 Extended	0
• 2 x 1 CP 443-5 Extended (conformal coating)	1
• 2 x 2 CP 443-5 Extended (conformal coating)	2
• 2 x 3 CP 443-5 Extended (conformal coating)	3
• 2 x 4 CP 443-5 Extended (conformal coating)	4

<sup>1)</sup> In configurations with UR2/UR2-H racks, up to 5 CPs (Industrial Ethernet/PROFIBUS) can be configured with a single power supply, or up to 3 CPs for each subsystem with a redundant power supply.

# PROFINET/Industrial Ethernet

## SIMATIC PCS 7 process control systems

### Fault-tolerant automation systems

#### Ordering data

Article No.

Article No.

#### Individual components

##### Individual components of the fault-tolerant SIMATIC PCS 7 AS 410H automation systems

Ordering data	Article No.	Article No.
<b>CPU 410-5H Process Automation (conformal coating)</b> 32 MB RAM integrated (16 MB each for program and data); module occupies 2 slots	6ES7410-5HX08-0AB0	<b>SIMATIC NET CP 443-1 (conformal coating)</b> Communication module for connecting SIMATIC S7-400 to Industrial Ethernet through TCP/IP, ISO and UDP; PROFINET IO controller, MRP; integrated real-time switch ERTEC with 2 ports; 2 x RJ45 interface; S7 communication, open communication (SEND/RECEIVE) with FETCH/WRITE, with or without RFC 1006, DHCP, SNMP V2, diagnostics, multicast, access protection over IP access list, initialization over LAN 10/100 Mbit/s; with electronic manual on DVD
<b>CPU 410-5H Process Automation 100 PO Bundle</b> CPU bundle, consisting of CPU 410-5H Process Automation and system expansion card for 100 PO	6ES7654-5CJ00-0XF0	<b>SIMATIC NET CP 443-5 Extended (conformal coating)</b> Communication module for connection of SIMATIC S7-400 to PROFIBUS as DP master or for S7 communication, for increasing the number of DP lines, for data set routing with SIMATIC PDM and for 10-ms time stamp, electronic manual on CD; module occupies 1 slot
<b>CPU 410-5H Process Automation 500 PO Bundle</b> CPU bundle, consisting of CPU 410-5H Process Automation and system expansion card for 500 PO	6ES7654-5CL00-0XF0	<b>PS 407 power supply module</b> with battery compartment for 2 backup batteries, module occupies 2 slots
<b>CPU 410-5H Process Automation 1 000 PO Bundle</b> CPU bundle, consisting of CPU 410-5H Process Automation and system expansion card for 1 000 PO	6ES7654-5CN00-0XF0	<ul style="list-style-type: none"> <li>• <b>10 A</b> 120/230 V AC/DC; 5 V DC/10 A, 24 V DC/1 A</li> <li>• <b>10 A, redundant</b> 120/230 V AC/DC; 5 V DC/10 A, 24 V DC/1 A</li> <li>• <b>20 A</b> 120/230 V AC/DC; 5 V DC/20 A, 24 V DC/1 A</li> </ul>
<b>CPU 410-5H Process Automation 1 600 PO Bundle</b> CPU bundle, consisting of CPU 410-5H Process Automation and system expansion card for 1 600 PO	6ES7654-5CP00-0XF0	<b>PS 405 power supply module</b> with battery compartment for 2 backup batteries, module occupies 2 slots
<b>CPU 410-5H Process Automation PO 2k+ Bundle</b> CPU bundle, consisting of CPU 410-5H Process Automation and system expansion card for PO 2k+ (≥ 2 000)	6ES7654-5CQ00-0XF0	<ul style="list-style-type: none"> <li>• <b>10 A</b> 24 V DC; 5 V DC/10 A, 24 V DC/1 A</li> <li>• <b>10 A, redundant</b> 24 V DC; 5 V DC/10 A, 24 V DC/1 A</li> <li>• <b>20 A</b> 24 V DC; 5 V DC/20 A, 24 V DC/1 A; with battery compartment for 2 backup batteries, module occupies 2 slots</li> </ul>
<b>Sync set</b> For coupling two redundant CPUs; for distances up to <ul style="list-style-type: none"> <li>• 10 m, consisting of 4 sync modules for up to 10 m and 2 fiber-optic sync cables, 1 m each</li> <li>• 10 km, consisting of 4 sync modules for up to 10 km</li> </ul> Note: please order fiber-optic sync cables (2 units) in the required length separately.	6ES7656-7XX30-0XE0	<b>Backup battery</b> Type AA, 2.3 Ah
	6ES7656-7XX40-0XE0	<b>Aluminum rack</b>
<b>Sync module</b> For coupling two redundant CPUs; 2 modules required for each CPU; for distances up to <ul style="list-style-type: none"> <li>• 10 m</li> <li>• 10 km</li> </ul>	6ES7960-1AA06-0XA0 6ES7960-1AB06-0XA0	<ul style="list-style-type: none"> <li>• UR1, 18 slots</li> <li>• UR2, 9 slots</li> <li>• UR2-H, for divided central controllers; 2 x 9 slots</li> </ul>
<b>Sync cable (fiber-optic cable)</b> For connecting two redundant CPUs, 2 cables required for each redundant automation system <ul style="list-style-type: none"> <li>• 1 m</li> <li>• 2 m</li> <li>• 10 m</li> </ul> Other lengths	6ES7960-1AA04-5AA0 6ES7960-1AA04-5BA0 6ES7960-1AA04-5KA0	<ul style="list-style-type: none"> <li>• UR1, 18 slots</li> <li>• UR2, 9 slots</li> <li>• UR2-H, for divided central controllers; 2 x 9 slots</li> </ul>
	On request	

### Ordering data

### Article No.

*Runtime licenses for SIMATIC PCS 7 automation systems*  
(can be added to existing licenses)

#### **SIMATIC PCS 7 AS Runtime license**

Independent of language,  
floating license for 1 user

- Delivery form package  
(without SIMATIC PCS 7 Software  
Media Package)

License key USB stick,  
certificate of license

- 100 PO
- 1 000 PO
- 10 000 PO

- Delivery form online  
(without SIMATIC PCS 7 Software  
Media Package)

License key download,  
online certificate of license

Note:

E-mail address required!

- 100 PO
- 1 000 PO
- 10 000 PO

**6ES7653-2BA00-0XB5**  
**6ES7653-2BB00-0XB5**  
**6ES7653-2BC00-0XB5**

**6ES7653-2BA00-0XH5**  
**6ES7653-2BB00-0XH5**  
**6ES7653-2BC00-0XH5**

#### *Y-Link*

#### **Y-Link**

For connection of devices with only  
1 PROFIBUS DP interface to a  
redundant automation system

**6ES7197-1LA11-0XA0**

### Options

#### **Y-Link**

- Bus coupler for transition from a redundant PROFIBUS DP master system to a single-channel PROFIBUS DP master system
- For connection of devices with only one PROFIBUS DP interface to the redundant PROFIBUS DP master system

The Y-link comprises:

- Two IM 153-2 High Feature interface modules for extended temperature range
- One Y coupler including RS 485 repeater
- One BM IM157 (IM/IM) bus module for two IM 153-2 High Feature modules, for extended temperature range
- One BM Y coupler bus module

Evaluation of the Y-Link diagnostics (and hence indirectly of the connected DP standard slaves) is supported by driver blocks.

## PROFINET/Industrial Ethernet

### SIMATIC PCS 7 process control systems

#### Safety-related automation systems

#### Overview



AS Single Station AS 410F

Safety-related automation systems are used for critical applications where a fault could endanger life or result in damage to the plant or the environment. These F/FH systems also referred to as "fail-safe automation systems" detect both faults in the process and their own internal faults in association with the safety-related F modules of the ET 200 distributed I/O systems or fail-safe transmitters connected directly via the fieldbus. They automatically transfer the plant to a safe state in the event of a fault.

#### Design

The PROFIsafe profile allows safety-related communication between the automation system (controller) and the process I/O via both PROFIBUS and PROFINET. The decision for choosing either PROFINET IO or the PROFIBUS DP/PA fieldbuses has a significant influence on the architecture of the safety-related system.

For information on the safety-related design versions with PROFIBUS DP/PA and PROFINET IO, refer to the section "Introduction" in the "Safety Integrated for Process Automation" chapter.

The safety-related SIMATIC PCS 7 automation systems are based either on the hardware of the AS 410S standard automation system (F systems) or the hardware of the AS 410H high availability automation system (FH systems), which have been supplemented with safety functions using S7 F systems.

In accordance with the design variant, they are categorized as:

- **AS Single Station AS 410F**  
with only one CPU (safety-related)
- **AS Redundancy Station AS 410FH**  
with two redundant CPUs (safety-related and high availability)

The availability can be flexibly increased with a redundant design for the power supply or the Industrial Ethernet communications module (for details, see the section "Modular S7-400 systems" under "Flexible and scalable availability").

All AS 410F/FH systems are TÜV-certified and comply with the safety requirements up to SIL 3 according to IEC 61508.

In these systems with multitasking capability, several programs can be executed simultaneously in one CPU – basic process control (BPCS) applications or also safety-related applications. The programs are reaction-free, i.e. faults in BPCS applications have no effect on safety-related applications, and vice versa. Special tasks with very short response times can also be implemented.

The redundant FH systems operating according to the 1-out-of-2 principle consist of two subsystems of identical design. These are electrically isolated from each other to achieve optimum EMC, and are synchronized with each other via fiber-optic cables. A bumpless switchover is made from the active subsystem to the standby subsystem in the event of a fault. The two subsystems can be present in the same rack or separated by up to 10 km. The spatial separation provides additional security in the case of extreme influences in the environment of the active subsystem, e.g. resulting from a fire.

The redundancy of the FH systems is only used to increase the availability. It is not relevant to processing of the safety functions and the associated fault detection.

### Design (continued)

#### Individual configuration of AS bundles

The configuration of the safety-related automation systems and their article numbers can be defined by selecting pre-configured ordering units.

Typical combinations for the respective system can be selected using tables in the section "Ordering data". These are divided into:

- AS Single Station AS 410F with one CPU
- AS Redundancy Station AS 410FH with two redundant CPUs, mounted on one common rack (UR2-H) or two separate racks (UR2)

The complete range for selection is available using two correspondingly structured online configurators in the Industry Mall ([www.siemens.com/industrymall](http://www.siemens.com/industrymall)):

- SIMATIC PCS 7 AS 410 Single Station configurator
- SIMATIC PCS 7 AS 410 Redundancy Station configurator

System expansion cards including an S7 F systems Runtime license should be selected here for safety-related AS 410 F/FH automation systems.

FO sync cables longer than 1 m must always be ordered separately (2 cables required in each case).

The components suitable for engineering the safety-related applications can be ordered in the section "Safety Integrated for Process Automation":

- S7 F Systems  
F programming tool with F block library for programming safety-related user programs on the engineering system
- SIMATIC Safety Matrix  
Convenient safety lifecycle tool for configuration, operation and servicing

#### I/O connection via PROFIBUS DP

The distributed process I/O can be integrated into a PROFIBUS DP segment either directly or via a lower-level PROFIBUS PA fieldbus. Several PROFIBUS DP segments with distributed process I/Os can be operated on an AS 410F/FH automation system.

A PROFIBUS DP interface is already integrated in each CPU 410-5H Process Automation. Using the online configurator in the Industry Mall or in the selection and ordering data, up to four additional PROFIBUS DP interfaces can be configured with additive CP 443-5 PROFIBUS DP interfaces (conformal coating) for each AS 410F as well as for each subsystem of the AS 410FH.

Connection of the process I/Os to two redundant PROFIBUS DP lines of an FH system (AS Redundancy Station) is carried out as described in the section "High availability automation systems".

The FOUNDATION Fieldbus (FF) H1 and the FF devices are not supported by Safety Integrated for Process Automation.

#### I/O connection via PROFINET IO

Safety-related AS 410F/FH automation systems can be connected via PROFINET IO with remote I/O stations, for example, ET 200M remote I/O stations. Only the PROFINET interface (2-port switch) integrated in the CPU can be used for this on the automation system. For additional information, refer to section "Introduction" in the "Safety Integrated for Process Automation" chapter.

#### Communication over the plant bus

If the PROFINET interface integrated in the CPU of the safety-related automation systems is not used for PROFINET IO, it is available for connection to the Industrial Ethernet plant bus. Otherwise, the AS 410F and the two subsystems of the AS 410FH can be connected to the plant bus via one CP 443-1 (conformal coating) communication module each.

The plant bus can be implemented in the form of a ring structure, which can also be configured with redundant architecture if the availability requirements are high. When there are two redundant rings, it makes sense to use two communication modules per AS (AS 410F) or AS subsystem (AS 410FH) and to distribute their connections over the two rings (4-way connection). Double faults such as failure of the switch on ring 1 with simultaneous interruption of the bus cable on ring 2 can thus be tolerated.

#### Runtime licenses

In the factory state, safety-related automation systems come with a SIMATIC PCS 7 AS Runtime license for 100 process objects (PO), SIMATIC PCS 7 Industry Library Runtime and the S7 F systems RT license. The 100 POs of the SIMATIC PCS 7 AS Runtime license can be expanded by additional Runtime licenses for 100, 1 000 or 10 000 POs. The process objects of additional Runtime licenses can be added to process objects which already exist. The number and type (e.g. 100 or 1 000) of additional Runtime licenses are irrelevant.

# PROFINET/Industrial Ethernet

## SIMATIC PCS 7 process control systems

### Safety-related automation systems

Ordering data	Article No.	Article No.	
<b>AS 410F (Single Station)</b> CPU 410-5H with PROFIBUS DP and PROFINET IO interface 32 MB RAM (16 MB each for program and data) with SIMATIC PCS 7 AS Runtime license for 100 PO and SIMATIC PCS 7 Industry Library Runtime license <b>Type of delivery</b> • Individual components, not pre-assembled • Pre-assembled and tested <b>System expansion card</b> • System expansion card 100 PO including S7 F systems Runtime license • System expansion card 500 PO including S7 F systems Runtime license • System expansion card 1 000 PO including S7 F systems Runtime license • System expansion card 1 600 PO including S7 F systems Runtime license • System expansion card PO 2k+ (≥ 2 000) including S7 F systems Runtime license <b>Additive Industrial Ethernet interfaces<sup>1)</sup></b> • Without CP 443-1 • 1 x CP 443-1 (conformal coating) • 2 x CP 443-1 (conformal coating) <b>Racks</b> • UR2 (9 slots), aluminum <sup>1)</sup> • UR2 (9 slots), steel <sup>1)</sup> • UR1 (18 slots), aluminum • UR1 (18 slots), steel <b>Power supply (without backup batteries)</b> • 1 x PS 407, 10 A for 120/230 V AC/DC • 1 x PS 407, 10 A for 120/230 V AC/DC, optional redundancy • 1 x PS 407, 20 A for 120/230 V AC/DC • 2 x PS 407, 10 A for 120/230 V AC/DC, redundant • 1 x PS 405, 10 A for 24 V DC • 1 x PS 405, 10 A for 24 V DC, optional redundancy • 1 x PS 405, 20 A for 24 V DC • 2 x PS 405, 10 A for 24 V DC, redundant <b>Additive PROFIBUS DP interfaces<sup>1)</sup></b> • Without CP 443-5 Extended • 1 x CP 443-5 Extended (conformal coating) • 2 x CP 443-5 Extended (conformal coating) • 3 x CP 443-5 Extended (conformal coating) • 4 x CP 443-5 Extended (conformal coating)	6ES7654- C 0 - F 5 6 A C E F G 0 3 4 3 4 5 6 B C D E G H J K 0 1 2 3 4	<b>AS 410FH (Redundancy Station)</b> 2 x CPU 410-5H with PROFIBUS DP and PROFINET IO interface 32 MB RAM (16 MB each for program and data) with SIMATIC PCS 7 AS Runtime license for 100 PO and SIMATIC PCS 7 Industry Library Runtime license <b>Type of delivery</b> • Individual components, not pre-assembled • Pre-assembled and tested <b>System expansion card</b> • 2 x system expansion card 100 PO including S7 F systems Runtime license • 2 x system expansion card 500 PO including S7 F systems Runtime license • 2 x system expansion card 1 000 PO including S7 F systems Runtime license • 2 x system expansion card 1 600 PO including S7 F systems Runtime license • 2 x system expansion card PO 2k+ (≥ 2 000) including S7 F systems Runtime license <b>Sync modules and cables</b> • 2 x 2 sync modules for distances up to 10 m and 2 x FO sync cable, 1 m • 2 x 2 sync modules for up to 10 km and 2 x FO sync cable, 1 m, for testing <b>Additive Industrial Ethernet interfaces<sup>1)</sup></b> • Without CP 443-1 • 2 x 1 CP 443-1 (conformal coating) • 2 x 2 CP 443-1 (conformal coating) <b>Racks</b> • 1 x UR2-H (2 x 9 slots), aluminum <sup>1)</sup> • 1 x UR2-H (2 x 9 slots), steel <sup>1)</sup> • 2 x UR2 (9 slots), aluminum <sup>1)</sup> • 2 x UR2 (9 slots), steel <sup>1)</sup> <b>Power supply (without backup batteries)</b> • 2 x PS 407, 10 A for 120/230 V AC/DC • 2 x PS 407, 10 A for 120/230 V AC/DC, optional redundancy • 2 x PS 407, 20 A for 120/230 V AC/DC • 2 x 2 PS 407, 10 A for 120/230 V AC/DC, redundant • 2 x PS 405, 10 A for 24 V DC • 2 x PS 405, 10 A for 24 V DC, optional redundancy • 2 x PS 405, 20 A for 24 V DC • 2 x 2 PS 405, 10 A for 24 V DC, redundant <b>Additive PROFIBUS DP interfaces<sup>1)</sup></b> • Without CP 443-5 Extended • 2 x 1 CP 443-5 Extended (conformal coating) • 2 x 2 CP 443-5 Extended (conformal coating) • 2 x 3 CP 443-5 Extended (conformal coating) • 2 x 4 CP 443-5 Extended (conformal coating)	6ES7656- C - F 5 6 A C E F G 3 4 0 3 4 1 2 3 4 B C D E G H J K 0 1 2 3 4

<sup>1)</sup> Up to 5 CPs (Industrial Ethernet/PROFIBUS) can be plugged into the UR2 rack with a single power supply, or up to 3 with a redundant power supply.

<sup>1)</sup> In configurations with UR2/UR2-H racks, up to 5 CPs (Industrial Ethernet/PROFIBUS) can be configured with a single power supply, or up to 3 CPs for each subsystem with a redundant power supply.

Ordering data	Article No.	Article No.
<b>Individual components</b>		
<i>Individual components of the safety-related SIMATIC PCS 7 automation systems AS 410F and AS 410FH</i>		
<b>S7 F Systems RT License</b> For processing safety-related application programs, for one AS 410F/FH system each	6ES7833-1CC00-6YX0	
<b>CPU 410-5H Process Automation (conformal coating)</b> 32 MB RAM integrated (16 MB each for program and data); module occupies 2 slots	6ES7410-5HX08-0AB0	
<b>CPU 410-5H Process Automation 100 PO Bundle</b> CPU bundle, consisting of CPU 410-5H Process Automation and system expansion card for 100 PO	6ES7654-5CJ00-0XF0	
<b>CPU 410-5H Process Automation 500 PO Bundle</b> CPU bundle, consisting of CPU 410-5H Process Automation and system expansion card for 500 PO	6ES7654-5CL00-0XF0	
<b>CPU 410-5H Process Automation 1 000 PO Bundle</b> CPU bundle, consisting of CPU 410-5H Process Automation and system expansion card for 1 000 PO	6ES7654-5CN00-0XF0	
<b>CPU 410-5H Process Automation 1 600 PO Bundle</b> CPU bundle, consisting of CPU 410-5H Process Automation and system expansion card for 1 600 PO	6ES7654-5CP00-0XF0	
<b>CPU 410-5H Process Automation PO 2k+ Bundle</b> CPU bundle, consisting of CPU 410-5H Process Automation and system expansion card for PO 2k+ (≥ 2 000)	6ES7654-5CQ00-0XF0	
<b>Sync set</b> For coupling two redundant CPUs; for distances up to <ul style="list-style-type: none"> <li>• 10 m, consisting of 4 sync modules for up to 10 m and 2 fiber-optic sync cables, 1 m each</li> <li>• 10 km, consisting of 4 sync modules for up to 10 km</li> </ul> Note: please order fiber-optic sync cables (2 units) in the required length separately.	6ES7656-7XX30-0XE0  6ES7656-7XX40-0XE0	
<b>Sync module</b> For coupling two redundant CPU; 2 modules required for each CPU, for distances up to <ul style="list-style-type: none"> <li>• 10 m</li> <li>• 10 km</li> </ul>	6ES7960-1AA06-0XA0 6ES7960-1AB06-0XA0	
<b>Sync cable (fiber-optic cable)</b> For connecting two redundant CPUs, 2 cables required for each redundant automation system <ul style="list-style-type: none"> <li>• 1 m</li> <li>• 2 m</li> <li>• 10 m</li> </ul> Other lengths	6ES7960-1AA04-5AA0 6ES7960-1AA04-5BA0 6ES7960-1AA04-5KA0  On request	
<b>SIMATIC NET CP 443-1 (conformal coating)</b> Communication module for connecting SIMATIC S7-400 to Industrial Ethernet through TCP/IP, ISO and UDP; PROFINET IO controller, MRP; integrated real-time switch ERTEC with 2 ports; 2 x RJ45 interface; S7 communication, open communication (SEND/RECEIVE) with FETCH/WRITE, with or without RFC 1006, DHCP, SNMP V2, diagnostics, multicast, access protection over IP access list, initialization over LAN 10/100 Mbit/s; with electronic manual on DVD		6GK7443-1EX30-0XE1
<b>SIMATIC NET CP 443-5 Extended (conformal coating)</b> Communication module for connection of SIMATIC S7-400 to PROFIBUS as DP master or for S7 communication, for increasing the number of DP lines, for data set routing with SIMATIC PDM and for 10-ms time stamp, electronic manual on CD; module occupies 1 slot		6GK7443-5DX05-0XE1
<b>PS 407 power supply module</b> with battery compartment for 2 backup batteries, module occupies 2 slots <ul style="list-style-type: none"> <li>• <b>10 A</b> 120/230 V AC/DC; 5 V DC/10 A, 24 V DC/1 A</li> <li>• <b>10 A, redundant</b> 120/230 V AC/DC; 5 V DC/10 A, 24 V DC/1 A</li> <li>• <b>20 A</b> 120/230 V AC/DC; 5 V DC/20 A, 24 V DC/1 A</li> </ul>		6ES7407-0KA02-0AA0  6ES7407-0KR02-0AA0  6ES7407-0RA02-0AA0
<b>PS 405 power supply module</b> with battery compartment for 2 backup batteries, module occupies 2 slots <ul style="list-style-type: none"> <li>• <b>10 A</b> 24 V DC; 5 V DC/10 A, 24 V DC/1 A</li> <li>• <b>10 A, redundant</b> 24 V DC; 5 V DC/10 A, 24 V DC/1 A</li> <li>• <b>20 A</b> 24 V DC; 5 V DC/20 A, 24 V DC/1 A; with battery compartment for 2 backup batteries, module occupies 2 slots</li> </ul>		6ES7405-0KA02-0AA0  6ES7405-0KR02-0AA0  6ES7405-0RA02-0AA0
<b>Backup battery</b> Type AA, 2.3 Ah		6ES7971-0BA00
<b>Aluminum rack</b> <ul style="list-style-type: none"> <li>• UR1, 18 slots</li> <li>• UR2, 9 slots</li> <li>• UR2-H, for divided central controllers; 2 x 9 slots</li> </ul>		6ES7400-1TA11-0AA0 6ES7400-1JA11-0AA0 6ES7400-2JA10-0AA0
<b>Steel rack</b> <ul style="list-style-type: none"> <li>• UR1, 18 slots</li> <li>• UR2, 9 slots</li> <li>• UR2-H, for divided central controllers; 2 x 9 slots</li> </ul>		6ES7400-1TA01-0AA0 6ES7400-1JA01-0AA0 6ES7400-2JA00-0AA0

## PROFINET/Industrial Ethernet

### SIMATIC PCS 7 process control systems

#### Safety-related automation systems

#### Ordering data

#### Article No.

#### Article No.

*Runtime licenses for SIMATIC PCS 7 automation systems*  
(can be added to existing licenses)

#### **SIMATIC PCS 7 AS Runtime license**

Independent of language,  
floating license for 1 user

- Delivery form package  
(without SIMATIC PCS 7 Software  
Media Package)

License key USB stick,  
certificate of license

- 100 PO
- 1 000 PO
- 10 000 PO

- Delivery form online  
(without SIMATIC PCS 7 Software  
Media Package)

License key download,  
online certificate of license

Note:

E-mail address required!

- 100 PO
- 1 000 PO
- 10 000 PO

**6ES7653-2BA00-0XB5**  
**6ES7653-2BB00-0XB5**  
**6ES7653-2BC00-0XB5**

**6ES7653-2BA00-0XH5**  
**6ES7653-2BB00-0XH5**  
**6ES7653-2BC00-0XH5**

#### *AS 410F/FH Engineering*

See section "Safety Integrated for Process Automation", S7 F Systems

#### *Y-Link*

#### **Y-Link**

For connection of devices with only  
one PROFIBUS DP interface to a  
redundant automation system

**6ES7197-1LA11-0XA0**



### Overview

With the S7-400 automation systems, which are scalable via different types of CPU, you have an alternative to AS 410 automation systems. The systems that can be used in plants with SIMATIC PCS 7 V8.0, V7.1 or V7.0 can be classified as follows:

- Standard automation systems
- High availability automation systems
- Safety-related automation systems

#### Standard automation systems

The AS 414-3, AS 414-3IE, AS 416-2, AS 416-3, AS 416-3IE and AS 417-4 standard automation systems are extremely robust and feature high processing and communication performance.

The AS 414-3 and AS 414-3IE are tailored for smaller-scale applications with smaller quantity structures, which allows for a low-cost starter solution with a modular and scalable system based on the S7-400 controller range. Larger quantity structures can be implemented using the AS 416-2, AS 416-3/416-3IE and AS 417-4 automation systems. These systems are preferred for medium and large-sized plants.

#### High availability automation systems

The aim in using high availability automation systems is to minimize the risk of a production outage. In accordance with their basic design, these systems are categorized as:

- AS Single Stations: AS 412-5-1H, AS 414-5-1H, AS 416-5-1H, and AS 417-5-1H with only one CPU, e.g. for the following applications:
  - Subsequent expansion to a redundant system
  - Redundant configuration on UR1 racks, comprising 2 Single Stations, 4 sync modules, and 2 sync fiber-optic cables
- AS Redundancy Stations: AS 412-5-2H, AS 414-5-2H, AS 416-5-2H and AS 417-5-2H with two redundant CPUs, mounted on one common rack (UR2-H) or two separate racks (UR2)

#### Safety-related automation systems

Safety-related automation systems (F/FH systems) are available for safety-relevant applications in which an incident can result in danger to persons, plant damage or environmental pollution. These are based on the hardware of the high availability automation systems, which is expanded by safety functions with S7 F systems.

In accordance with the design variant, they are categorized as:

- **AS Single Stations**  
AS 412F, AS 414F, AS 416F, and AS 417F with only one CPU (safety-related)
- **AS Redundancy Stations**  
AS 412FH, AS 414FH, AS 416FH, and AS 417FH with two redundant CPUs (safety-related and high availability)

The safety-related F/FH systems collaborate with safety-related F modules of the ET 200 distributed I/O systems or fail-safe transmitters connected directly via the fieldbus to detect not only faults in the process, but also their own, internal faults. They automatically transfer the plant to a safe state in the event of a fault. The redundancy of the FH systems is only used to increase the availability. It is not relevant to processing of the safety functions and the associated fault detection.

All F/FH systems are TÜV-certified and comply with the safety requirements up to SIL 3 according to IEC 61508.

### Design

#### Racks

Automation systems based on only one CPU (AS Single Station) can be mounted on a UR1 rack (18 slots) or UR2 rack (9 slots).

The automation systems (AS Redundancy Station) consisting of two electrically isolated redundant subsystems can be mounted on a UR2-H compact rack with divided backplane bus or on two separate racks (UR1 or UR2). The design with two racks allows physical separation of the redundant subsystems, e.g. by a fireproof partition and over a distance of up to 10 km. As a result of the galvanic isolation, the system is insensitive to electromagnetic interferences.

#### Redundant power supply

If you have two separate power supplies for supplying your system, you can increase the availability of the automation systems with redundant power supplies (2 power supplies for one AS Single Station or 1 or 2 power supplies for each subsystem of an AS Redundancy Station).

#### Communication via the Industrial Ethernet (IE) plant bus

Each standard automation system is connected to the Industrial Ethernet plant bus by means of a CP 443-1 communication module.

If the PN/IE interface integrated in the CPUs of the high availability and safety-related automation systems is not used for PROFINET IO, it is available for the connection to the Industrial Ethernet plant bus. Otherwise, the 1H/F systems (AS Single Station) and the two subsystems of the 2H/FH systems (AS Redundancy Station) can be connected to the plant bus via one CP 443-1 communication module each.

#### I/O connection via PROFIBUS DP

The distributed process I/O can be integrated into a PROFIBUS DP segment either directly or via a lower-level fieldbus (PROFIBUS PA or FOUNDATION Fieldbus H1).

Several PROFIBUS DP segments with distributed process I/Os can be operated on a standard automation system, an 1H/F system (AS Single Station), or a 2H/FH system (AS Redundancy Station). The following table provides an overview of the number and type of configurable PROFIBUS DP interfaces.

#### I/O connection via PROFINET (PN)

Standard automation systems, high availability and safety-oriented automation systems (AS Single Stations and AS Redundancy Stations) can be networked simply and effectively with ET 200M remote I/O stations over PROFINET IO. If a PN/IE interface is integrated in the CPU of the automation system (AS 414-3IE, AS 416-3IE, and all H/F/FH systems), then it is to be used for connecting ET 200M remote I/O stations via PROFINET IO. In standard automation systems, the PN/IE interfaces of type CP 443-1 communication modules can also be used for PROFINET IO.

The maximum availability with minimum error handling times is achieved by the AS Redundancy Station (2 H/FH systems) in conjunction with the system redundancy of the I/O devices. System redundancy refers to a type of PROFINET IO communication where each I/O device establishes a communication connection to each of the two CPUs of an AS Redundancy Station over the topological network.













# PROFINET/Industrial Ethernet SIMATIC PCS 7 process control systems

## Complementary S7-400 systems

2

**Ordering data**

**Article No.**

**Article No.**

**Configuration tables  
for safety-related automation systems**

<p><b>AS 414F (Single Station)</b> with SIMATIC PCS 7 AS Runtime license for 100 POs</p> <p>CPU with 2 PROFIBUS interfaces (MPI/DP master and DP master) and 1 PN/IE interface (2 port switch)</p> <p>4 MB RAM (2 MB each for program and data)</p>	<p><b>6ES7654-</b> </p>
<p><b>Type of delivery</b></p> <ul style="list-style-type: none"> <li>• Individual components, not pre-assembled <b>7</b></li> <li>• Pre-assembled and tested <b>8</b></li> </ul>	
<p><b>Memory card</b></p> <ul style="list-style-type: none"> <li>• Memory card 2 MB RAM (up to approx. 100 POs) <b>B</b></li> <li>• Memory card 4 MB RAM (up to approx. 210 POs) <b>C</b></li> </ul>	
<p><b>CPU type</b></p> <ul style="list-style-type: none"> <li>• CPU 414-5H with S7 F Systems RT license (up to approx. 350 POs) <b>F</b></li> </ul>	
<p><b>Additive interface modules</b></p> <ul style="list-style-type: none"> <li>• Without additive interface module <b>0</b></li> </ul>	
<p><b>Interface to Industrial Ethernet plant bus</b></p> <ul style="list-style-type: none"> <li>• Without interface module <b>0</b></li> <li>• 1 x CP 443-1EX30<sup>1)</sup> <b>3</b></li> <li>• 2 x CP 443-1EX30 for redundant connection<sup>1)</sup> <b>4</b></li> </ul>	
<p><b>Racks</b></p> <ul style="list-style-type: none"> <li>• UR2 (9 slots), aluminum <b>3</b></li> <li>• UR2 (9 slots), steel <b>4</b></li> <li>• UR1 (18 slots), aluminum <b>5</b></li> <li>• UR1 (18 slots), steel <b>6</b></li> </ul>	
<p><b>Power supply (without backup batteries)</b></p> <ul style="list-style-type: none"> <li>• 1 x PS 407, 10 A for 120/230 V AC/DC <b>B</b></li> <li>• 1 x PS 407, 10 A for 120/230 V AC/DC, optional redundancy <b>C</b></li> <li>• 1 x PS 407, 20 A for 120/230 V AC/DC <b>D</b></li> <li>• 2 x PS 407, 10 A for 120/230 V AC/DC (redundant) <b>E</b></li> <li>• 1 x PS 405, 10 A for 24 V DC <b>G</b></li> <li>• 1 x PS 405, 10 A for 24 V DC, optional redundancy <b>H</b></li> <li>• 1 x PS 405, 20 A for 24 V DC <b>J</b></li> <li>• 2 x PS 405, 10 A for 24 V DC (redundant) <b>K</b></li> </ul>	
<p><b>Additive PROFIBUS DP interfaces</b></p> <ul style="list-style-type: none"> <li>• Without CP 443-5 Extended <b>0</b></li> <li>• 1 x CP 443-5 Extended <b>1</b></li> <li>• 2 x CP 443-5 Extended<sup>1)</sup> <b>2</b></li> <li>• 3 x CP 443-5 Extended<sup>1)</sup> <b>3</b></li> <li>• 4 x CP 443-5 Extended<sup>1)</sup> <b>4</b></li> </ul>	

<p><b>AS 416F (Single Station)</b> with SIMATIC PCS 7 AS Runtime license for 100 POs</p> <p>CPU with 2 PROFIBUS interfaces (MPI/DP master and DP master) and 1 PN/IE interface (2 port switch)</p> <p>16 MB RAM (6 MB for program and 10 MB for data)</p>	<p><b>6ES7654-</b> </p>
<p><b>Type of delivery</b></p> <ul style="list-style-type: none"> <li>• Individual components, not pre-assembled <b>7</b></li> <li>• Pre-assembled and tested <b>8</b></li> </ul>	
<p><b>Memory card</b></p> <ul style="list-style-type: none"> <li>• Memory card 4 MB RAM (up to approx. 210 POs) <b>C</b></li> <li>• Memory card 8 MB RAM (up to approx. 800 POs) <b>D</b></li> <li>• Memory card 16 MB RAM (up to approx. 2 100 POs) <b>E</b></li> </ul>	
<p><b>CPU type</b></p> <ul style="list-style-type: none"> <li>• CPU 416-5H with S7 F Systems RT license (up to approx. 1 200 POs) <b>Q</b></li> </ul>	
<p><b>Additive IF 964-DP interface module</b></p> <ul style="list-style-type: none"> <li>• Without additive IF 964-DP <b>0</b></li> </ul>	
<p><b>Interface to Industrial Ethernet plant bus</b></p> <ul style="list-style-type: none"> <li>• Without interface module <b>0</b></li> <li>• 1 x CP 443-1EX30<sup>1)</sup> <b>3</b></li> <li>• 2 x CP 443-1EX30 for redundant connection<sup>1)</sup> <b>4</b></li> </ul>	
<p><b>Racks</b></p> <ul style="list-style-type: none"> <li>• UR2 (9 slots), aluminum <b>3</b></li> <li>• UR2 (9 slots), steel <b>4</b></li> <li>• UR1 (18 slots), aluminum <b>5</b></li> <li>• UR1 (18 slots), steel <b>6</b></li> </ul>	
<p><b>Power supply (without backup batteries)</b></p> <ul style="list-style-type: none"> <li>• 1 x PS 407, 10 A for 120/230 V AC/DC <b>B</b></li> <li>• 1 x PS 407, 10 A for 120/230 V AC/DC, optional redundancy <b>C</b></li> <li>• 1 x PS 407, 20 A for 120/230 V AC/DC <b>D</b></li> <li>• 2 x PS 407, 10 A for 120/230 V AC/DC (redundant) <b>E</b></li> <li>• 1 x PS 405, 10 A for 24 V DC <b>G</b></li> <li>• 1 x PS 405, 10 A for 24 V DC, optional redundancy <b>H</b></li> <li>• 1 x PS 405, 20 A for 24 V DC <b>J</b></li> <li>• 2 x PS 405, 10 A for 24 V DC (redundant) <b>K</b></li> </ul>	
<p><b>Additive PROFIBUS DP interfaces</b></p> <ul style="list-style-type: none"> <li>• Without CP 443-5 Extended <b>0</b></li> <li>• 1 x CP 443-5 Extended <b>1</b></li> <li>• 2 x CP 443-5 Extended<sup>1)</sup> <b>2</b></li> <li>• 3 x CP 443-5 Extended<sup>1)</sup> <b>3</b></li> <li>• 4 x CP 443-5 Extended<sup>1)</sup> <b>4</b></li> </ul>	

<sup>1)</sup> Up to 5 CPs can be plugged into the UR2 rack with a single power supply or up to 3 with a redundant power supply.

<sup>1)</sup> Up to 5 CPs can be plugged into the UR2 rack with a single power supply or up to 3 with a redundant power supply.



**Ordering data**

Article No.

Article No.

**Configuration tables**  
**for safety-related automation systems**

**AS 417F (Single Station)**  
 mit SIMATIC PCS 7 AS  
 Runtime License für 100 PO  
 CPU with 2 PROFIBUS interfaces  
 (MPI/DP master and DP master) and  
 1 PN/IE interface (2 port switch)  
 32 MB RAM  
 (16 MB each for program and data)

**Type of delivery**

- Individual components,  
not pre-assembled 7
- Pre-assembled and tested 8

**Memory card**

- Memory card 4 MB RAM  
(up to approx. 210 POs) C
- Memory card 8 MB RAM  
(up to approx. 800 POs) D
- Memory card 16 MB RAM  
(up to approx. 2 100 POs) E

**CPU type**

- CPU 417-5H with S7 F Systems  
RT license (up to approx. 2 000 POs) N

**Additive interface modules**

- Without additive interface module 0

**Interface to Industrial Ethernet plant bus**

- Without interface module 0
- 1 x CP 443-1EX30<sup>1)</sup> 3
- 2 x CP 443-1EX30  
for redundant connection<sup>1)</sup> 4

**Racks**

- UR2 (9 slots), aluminum 3
- UR2 (9 slots), steel 4
- UR1 (18 slots), aluminum 5
- UR1 (18 slots), steel 6

**Power supply (without backup batteries)**

- 1 x PS 407,  
10 A for 120/230 V AC/DC B
- 1 x PS 407,  
10 A for 120/230 V AC/DC,  
optional redundancy C
- 1 x PS 407,  
20 A for 120/230 V AC/DC D
- 2 x PS 407,  
10 A for 120/230 V AC/DC  
(redundant) E
- 1 x PS 405, 10 A for 24 V DC G
- 1 x PS 405, 10 A for 24 V DC,  
optional redundancy H
- 1 x PS 405, 20 A for 24 V DC J
- 2 x PS 405, 10 A for 24 V DC  
(redundant) K

**Additive PROFIBUS DP interfaces**

- Without CP 443-5 Extended 0
- 1 x CP 443-5 Extended 1
- 2 x CP 443-5 Extended<sup>1)</sup> 2
- 3 x CP 443-5 Extended<sup>1)</sup> 3
- 4 x CP 443-5 Extended<sup>1)</sup> 4

<sup>1)</sup> Up to 5 CPs can be plugged into the UR2 rack with a single power supply or up to 3 with a redundant power supply 3.

**AS 412FH (Redundancy Station)**  
 with SIMATIC PCS 7 AS  
 Runtime license for 100 POs  
 2 x CPU with 2 PROFIBUS interfaces  
 each (MPI/DP master and DP master)  
 and 1 PN/IE interface each  
 (2 port switch)  
 2 x 1 MB RAM  
 (512 KB each for program and data)

**Type of delivery**

- Individual components,  
not pre-assembled 7
- Pre-assembled and tested 8

**Memory card**

- 2 x memory card 1 MB RAM  
(up to approx. 30 POs) A
- 2 x memory card 2 MB RAM  
(up to approx. 100 POs) B

**CPU type**

- 2 x CPU 412-5H with S7 F Systems  
RT license (up to approx. 30 POs) B

**Sync modules and cables**

- 2 x 2 sync modules for distances  
up to 10 m and 2 x FO sync cable,  
1 m 3

**Interface to Industrial Ethernet plant bus**

- Without interface module 0
- 2 x CP 443-1EX30  
for redundant connection<sup>1)</sup> 3
- 2 x 2 CP 443-1EX30  
for 4-way connection<sup>1)</sup> 4

**Racks**

- 1 x UR2-H (2 x 9 slots), aluminum 1
- 1 x UR2-H (2 x 9 slots), steel 2
- 2 x UR2 (9 slots), aluminum 3
- 2 x UR2 (9 slots), steel 4

**Power supply (without backup batteries)**

- 2 x PS 407,  
10 A for 120/230 V AC/DC B
- 2 x PS 407,  
10 A for 120/230 V AC/DC,  
optional redundancy C
- 2 x PS 407,  
20 A for 120/230 V AC/DC D
- 2 x 2 PS 407,  
10 A for 120/230 V AC/DC (re-  
dundant) E
- 2 x PS 405, 10 A for 24 V DC G
- 2 x PS 405, 10 A for 24 V DC,  
optional redundancy H
- 2 x PS 405, 20 A for 24 V DC J
- 2 x 2 PS 405, 10 A for 24 V DC  
(redundant) K

**Additive PROFIBUS DP interfaces**

- Without CP 443-5 Extended 0
- 2 x CP 443-5 Extended 1
- 2 x 2 CP 443-5 Extended<sup>1)</sup> 2
- 2 x 3 CP 443-5 Extended<sup>1)</sup> 3
- 2 x 4 CP 443-5 Extended<sup>1)</sup> 4

<sup>1)</sup> Up to 5 CPs can be plugged in per subsystem with a single power supply or up to 3 with a redundant power supply.



**Ordering data****Article No.**
**Configuration tables**  
**for safety-related automation systems**

Ordering data	Article No.									
<b>AS 417FH (Redundancy Station)</b> with SIMATIC PCS 7 AS Runtime license for 100 POs  2 x CPU with 2 PROFIBUS interfaces each (MPI/DP master and DP master) and 1 PN/IE interface each (2 port switch) 2 x 32 MB RAM (16 MB each for program and data)	<b>6ES7656-</b>									<b>F</b>
<b>Type of delivery</b>										
• Individual components, not pre-assembled										<b>7</b>
• Pre-assembled and tested										<b>8</b>
<b>Memory card</b>										
• 2 x memory card 4 MB RAM (up to approx. 210 POs)										<b>C</b>
• 2 x memory card 8 MB RAM (up to approx. 800 POs)										<b>D</b>
• 2 x memory card 16 MB RAM (up to approx. 2 100 POs)										<b>E</b>
<b>CPU type</b>										
• 2 x CPU 417-5H with S7 F Systems RT license (up to approx. 2 000 POs)										<b>N</b>
<b>Sync modules and cables</b>										
• 2 x 2 sync modules for distances up to 10 m and 2 x FO sync cable, 1 m										<b>3</b>
• 2 x 2 sync modules for up to 10 km and 2 x FO sync cable, 1 m, for testing										<b>4</b>
<b>Interface to Industrial Ethernet plant bus</b>										
• Without interface module										<b>0</b>
• 2 x CP 443-1EX30 for redundant connection <sup>1)</sup>										<b>3</b>
• 2 x 2 CP 443-1EX30 for 4-way connection <sup>1)</sup>										<b>4</b>
<b>Racks</b>										
• 1 x UR2-H (2 x 9 slots), aluminum										<b>1</b>
• 1 x UR2-H (2 x 9 slots), steel										<b>2</b>
• 2 x UR2 (9 slots), aluminum										<b>3</b>
• 2 x UR2 (9 slots), steel										<b>4</b>
<b>Power supply (without backup batteries)</b>										
• 2 x PS 407, 10 A for 120/230 V AC/DC										<b>B</b>
• 2 x PS 407, 10 A for 120/230 V AC/DC, optional redundancy										<b>C</b>
• 2 x PS 407, 20 A for 120/230 V AC/DC										<b>D</b>
• 2 x 2 PS 407, 10 A for 120/230 V AC/DC (redundant)										<b>E</b>
• 2 x PS 405, 10 A for 24 V DC										<b>G</b>
• 2 x PS 405, 10 A for 24 V DC, optional redundancy										<b>H</b>
• 2 x PS 405, 20 A for 24 V DC										<b>J</b>
• 2 x 2 PS 405, 10 A for 24 V DC (redundant)										<b>K</b>
<b>Additive PROFIBUS DP interfaces<sup>1)</sup></b>										
• Without CP 443-5 Extended										<b>0</b>
• 2 x CP 443-5 Extended										<b>1</b>
• 2 x 2 CP 443-5 Extended <sup>1)</sup>										<b>2</b>
• 2 x 3 CP 443-5 Extended <sup>1)</sup>										<b>3</b>
• 2 x 4 CP 443-5 Extended <sup>1)</sup>										<b>4</b>

<sup>1)</sup> Up to 5 CPs can be plugged into the UR2 rack with a single power supply or up to 3 with a redundant power supply..

**Accessories****Backup batteries**

Lithium backup batteries of type AA with 2.3 Ah are used in the power supply modules of all SIMATIC PCS 7 automation systems AS 412 to AS 417. Since lithium batteries are easily inflammable, more rigorous transport and storage regulations apply to them.

To avoid subjecting the AS bundles to these more rigorous transport and storage regulations, the backup batteries must be ordered and delivered separately (order no. 6ES7971-0BA00).

The following backup batteries are required depending on the configuration of the AS bundles:

- SIMATIC PCS 7 AS Single Station:
  - With 1 power supply module: 2 units
  - With 2 redundant power supply modules: 4 units
- SIMATIC PCS 7 AS Redundancy Station:
  - With 2 power supply modules: 4 units
  - With 2 x 2 redundant power supply modules: 8 units

## PROFINET/Industrial Ethernet

### SIMATIC PCS 7 process control systems

#### Process I/O

#### SIMATIC ET 200M for SIMATIC PCS 7

#### Overview



Within the SIMATIC ET 200 range, ET 200M represents the main series of distributed I/O systems for process control applications with SIMATIC PCS 7.

The ET 200M I/O system offers a comprehensive range of I/O modules of S7-300 design, including ones with special I&C functions:

- Standard analog and digital modules
- Redundant I/O modules
- I/O modules with enhanced diagnostics capability
- Ex I/O modules
- Controller and counter modules
- HART modules
- F-modules for safety-related applications

When using active bus modules, faulty I/O modules can be replaced while the plant is in operation (RUN) without influencing adjacent modules (hot swapping function).

The following actions are possible with the automation system in RUN:

- Adding new modules to the station
- Re-configuration of modules
- Addition of ET 200M stations
- Configuration of connected HART field devices with SIMATIC PDM

#### Note:

Apart from these selected modules, it is also possible to use – with limitations in functions - all other I/O modules from the current range of S7-300 signal modules.

#### Design

An ET 200M remote I/O station comprises:

- 1 or 2 (redundant) power supply modules (can be omitted in the case of a central 24 V DC supply for the plant)
- Up to 2 interface modules:
  - 1 or 2 (redundant) IM 153-2 High Feature for PROFIBUS DP connection or
  - 1 IM 153-4 PN High Feature for PROFINET connection
- Up to 12 I/O modules for connection of sensors/actuators

All I/O modules have optical electrical isolation from the backplane bus. Up to 12 I/O modules can be connected to an IM 153-2 High Feature or IM 153-4 PN High Feature interface module. The IM 153-2 High Feature interface modules can also be configured redundantly.

In addition to the standard SIMATIC S7 I/O modules, special I/O modules with diagnostics capability offer the following functions, among others:

- Channel-based diagnostics, e.g. open-circuit, short-circuit, limit violations
- Internal module monitoring, e.g. configuration error, RAM error, tripped fuse
- Flatter monitoring for sensors
- Pulse stretching
- Output of a selectable substitute value on failure of the central processing unit

In the event of a fault, the modules with diagnostics capability automatically pass on the corresponding message to the operator station, permitting fast and simple troubleshooting.

The ET 200M stations can be used in standard environments and also in Ex zone 2/22. The actuators/sensors can be positioned in Ex zone 1/21 when suitable Ex input/output modules are used. Hot swapping of I/O modules within Ex zone 2 is allowed with the right permit (e.g. fire certificate).

#### Technical specifications

You can find detailed technical data on the ET 200M and S7-300 I/O modules in the following places:

- Catalog ST 70 or
- Industry Mall/CA 01 under "Automation engineering – Automation systems – SIMATIC industrial automation systems – SIMATIC ET 200 distributed I/O"

#### Options

##### **SIPLUS extreme range for extended temperature ranges and corrosive environments**

The "standard" properties of an individual device or system are often insufficient for harsh environmental conditions, applications in corrosive environments or extreme temperature ranges. Depending on the location of use, the result could be limitations in functionality or operational safety or even total failure of the plant.

The SIPLUS extreme range offers individually adapted standard products which permit retention of the functionality of your plant or process even under extreme conditions of use. These include:

- Ambient temperature range from -25 to +60/+70 °C
- Condensation, high humidity
- Increased mechanical stress
- Extreme loading by media, e.g. toxic atmospheres
- Voltage ranges deviating from the standard
- Increased degree of protection (dust, water)

You can find a summary of the available range of products classified according to their special properties on the Internet. The corresponding SIPLUS product is assigned there to the standard product:

<http://www.siemens.com/siplus>

#### Note:

SIPLUS products are also included in the ST 70 Catalog.

## Overview



IM 153-2 High Feature interface module for PROFIBUS connection

### Interface module for the PROFIBUS connection

The IM 153-2 High Feature interface module (electrical PROFIBUS DP transmission mode) is available for connecting the ET 200M remote I/O station to the PROFIBUS DP fieldbus. Depending on the fieldbus configuration (single/redundant), the ET 200M remote I/O station can be connected via one single or two redundant interface modules.



IM 153-4 High Feature interface module for PROFINET connection

### Interface module for PROFINET connection

The IM 153-4 PN High Feature interface module is used to connect the ET 200M remote I/O station to PROFINET via copper cables (RJ45). It autonomously handles communication between the I/O modules and the higher-level PROFINET I/O controller.

## Function

### IM 153-2 High Feature

The IM 153-2 High Feature supports the following functions:

- HART configuring of intelligent field devices
- Configuration of ET 200M I/Os in RUN mode of the automation system
- Connection to redundant automation systems
- Use of ET 200M function modules (controller and counter modules)
- Operation of up to 12 I/O modules per remote I/O station
- Time stamping (SOE) with the safety-related SM 326F digital input module (F-DI24)
- Transmission of additional values with HART secondary variables of the HART SM 331 and SM 332 analog modules (up to 4 per channel or up to 8 per module)

### IM 153-4 PN High Feature

- Integrated 2-port switch
- Baud rate 10 Mbps / 100 Mbps (Autonegotiation/Full Duplex)
- Operation of up to 12 I/O modules per remote I/O station
- I&M functions in accordance with PROFIBUS International Guidelines, order no. 3.502, version V1.1

#### Note:

In order to be able to use the hot swapping function, use of the active bus module and the mounting rail for hot swapping is necessary (see under the following section "Accessories").

## Ordering data

## Article No.

### Interface module for the PROFIBUS connection

#### IM 153-2 High Feature

Slave interface module for connection of an ET 200M station to PROFIBUS DP, with time stamp (accuracy 1 ms), support of HART functionality, F modules, FM modules, "Configuration in RUN" function; also for use in redundant systems

**6ES7153-2BA02-0XB0**

### Interface module for PROFINET connection

#### IM 153-4 PN High Feature

Interface for connecting an ET 200M station to PROFINET

**6ES7153-4BA00-0XB0**

# PROFINET/Industrial Ethernet

## SIMATIC ET 200SP

### Interface modules without CPU

IM 155-6

#### Overview



- Interface module for linking the ET 200SP to PROFINET or PROFIBUS
- Handles all data exchange with the controller
- BusAdapter (BA) for individual PROFINET connection
- Integrated 2-port switch for line configuration
- Depending on the selected interface module
  - up to max. 64 I/O modules per station; all I/O modules, including fail-safe modules, can be used.
  - Replacement of I/O modules during operation
- Operation with gaps (non-equipped BaseUnits) possible
- Replacement of an I/O module possible during operation (hot swapping)
- Load group formation without power module

#### Technical specifications

	6ES7155-6AA00-0BN0 IM 155-6 PN ST with BA 2xRJ45 and server module	6ES7155-6AU00-0BN0 IM 155-6 PN ST with server module	6ES7155-6AU00-0CN0 IM 155-6 PN HF with server module
<b>General information</b>			
Firmware version			V2.2.0
Vendor identification (VendorID)		002AH	
Device identifier (DeviceID)		0313H	
Product function			
• I&M data	Yes	Yes	Yes; I&M0 to I&M4
Engineering with			
• STEP 7 TIA Portal can be configured/integrated as of version	V11 SP2 with HSP0024 / -	V12 / V12	V12 SP1 / V13
• STEP 7 can be configured/integrated as of version	V5.5 SP3 / -	V5.5 SP3 / -	V5.5 SP3 / -
• PROFIBUS as of GSD version/ GSD revision			
• PROFINET as of GSD version/ GSD revision	V2.3 / -	V1.0 / V2.23	V2.3 / -
<b>Supply voltage</b>			
Type of supply voltage		24 V DC	DC
Rated value (DC)	24 V	24 V	24 V
permissible range, lower limit (DC)	19.2 V	19.2 V	19.2 V
permissible range, upper limit (DC)	28.8 V	28.8 V	28.8 V
Reverse polarity protection	Yes	Yes	Yes
Mains buffering			
• Mains/voltage failure stored energy time	5 ms	5 ms	5 ms
<b>Input current</b>			
Current consumption, max.	450 mA	450 mA	
Inrush current, max.			4.5 A
$I^2t$			0.09 A <sup>2</sup> -s
<b>Power losses</b>			
Power loss, typ.	1.9 W	1.9 W	2.4 W
<b>Address area</b>			
Address space per module			
• Address space per module, max.			32 byte
Address space per station			
• Address space per station, max.	256 byte	256 byte	1 440 byte
<b>Hardware configuration</b>			
Rack			
• Modules per rack, max.	32	32	64

**Technical specifications (continued)**

	<b>6ES7155-6AA00-0BNO</b> <b>IM 155-6 PN ST with BA 2xRJ45 and server module</b>	<b>6ES7155-6AU00-0BNO</b> <b>IM 155-6 PN ST with server module</b>	<b>6ES7155-6AU00-0CNO</b> <b>IM 155-6 PN HF with server module</b>
<b>Interfaces</b>			
Number of PROFINET interfaces	1	1	1
Number of PROFIBUS interfaces			
1st interface			
• Interface types			
- Number of ports	2	2	2
- Integrated switch	Yes	Yes	Yes
- RJ 45 (Ethernet)	Yes; Pre-assembled bus adapter BA 2x RJ45		
- RS 485			
- Bus adapter (PROFINET)	Yes; Applicable bus adapters: BA 2x RJ45, BA 2x FC	Yes; applicable bus adapters: BA 2x RJ45, BA 2x FC	Yes; Applicable bus adapters: BA 2xRJ45, BA 2xFC, BA 2xSCRJ (as from FS03)
• Protocols			
- PROFINET IO Device	Yes	Yes	Yes
- Open IE communication	Yes	Yes	Yes
- Media redundancy	Yes	Yes	Yes; As MRP or MRPD client; max. 50 or 30 devices in the ring
<b>Interface types</b>			
RJ 45 (Ethernet)			
• 10 Mbps	Yes; for Ethernet services	Yes; for Ethernet services	Yes; for Ethernet services
• 100 Mbps	Yes; PROFINET with 100 Mbit/s full duplex (100BASE-TX)	Yes; PROFINET with 100 Mbit/s full duplex (100BASE-TX)	Yes; PROFINET with 100 Mbit/s full duplex (100BASE-TX)
• Transmission procedure	PROFINET with 100 Mbit/s full duplex (100BASE-TX)	PROFINET with 100 Mbit/s full duplex (100BASE-TX)	PROFINET with 100 Mbit/s full duplex (100BASE-TX)
• Autonegotiation	Yes	Yes	Yes
• Autocrossing	Yes	Yes	Yes
<b>Protocols</b>			
PROFINET IO			
• Supports protocol for PROFINET IO	Yes	Yes	Yes
PROFINET IO Device			
• Services			
- Isochronous mode			Yes; Bus cycle time: min. 250 µs
- Open IE communication	Yes	Yes	Yes
- IRT, supported	Yes; with send cycles of between 250 µs and 4 ms in increments of 125 µs	Yes; with send cycles of between 250 µs and 4 ms in increments of 125 µs	Yes; 250 µs, 500 µs, 1 ms, 2 ms, 4 ms additionally with IRT with high performance: 250 µs to 4 ms in 125 µs frame
- MRP, supported			Yes
- MRPD, supported			Yes
- PROFIenergy		Yes	Yes
- Prioritized startup	Yes	Yes	Yes
- Shared device	Yes	Yes	Yes
- Number of IO controllers with shared device, max.		2	4
Open IE communication			
• TCP/IP	Yes	Yes	Yes
• SNMP	Yes	Yes	Yes
• LLDP	Yes	Yes	Yes
<b>Isochronous mode</b>			
Isochronous operation (application synchronized up to terminal)			Yes
equidistance			Yes
shortest clock pulse			250 µs
max. cycle			4 ms
Jitter, max.			1 µs
<b>Interrupts/diagnostics/ status information</b>			
Status indicator	Yes	Yes	Yes
Alarms			
• Alarms	Yes	Yes	Yes

# PROFINET/Industrial Ethernet

## SIMATIC ET 200SP

### Interface modules without CPU

#### IM 155-6

#### Technical specifications (continued)

	<b>6ES7155-6AA00-0BNO</b> <b>IM 155-6 PN ST with BA 2xRJ45 and server module</b>	<b>6ES7155-6AU00-0BNO</b> <b>IM 155-6 PN ST with server module</b>	<b>6ES7155-6AU00-0CN0</b> <b>IM 155-6 PN HF with server module</b>
Diagnostic messages • Diagnostic functions	Yes	Yes	Yes
Diagnostics indication LED • RUN LED • ERROR LED • MAINT LED • Monitoring the supply voltage (PWR-LED) • Connection display LINK TX/RX • Connection display DP	Yes; Green LED Yes; Red LED Yes; yellow LED Yes; Green LED Yes	Yes; Green LED Yes; Red LED Yes; yellow LED Yes; Green LED Yes; 2x green LED	Yes; Green LED Yes; Red LED Yes; yellow LED Yes; Green LED Yes; 2x green LED
<b>Galvanic isolation</b> between backplane bus and electronics	No		
between PROFINET and all other circuits	Yes	Yes	Yes
between supply and all other circuits	Yes	Yes	Yes
<b>Permissible potential difference</b> between different circuits	75 V DC / 60 V AC	75 V DC/60 V AC (base isolation)	75 V DC/60 V AC (base isolation)
<b>Isolation</b> Isolation checked with	707 V DC between supply voltage and electronics; 1 500 V AC between Ethernet and electronics	707 V DC between supply voltage and electronics (type test); 1 500 V AC between Ethernet and electronics (type test)	707 V DC between supply voltage and electronics (type test); 1 500 V AC between Ethernet and electronics (type test)
<b>Standards, approvals, certificates</b> Network loading class	3	3	3
Security level	According to Security Level 1 Test Cases V1.1.1	According to Security Level 1 Test Cases V1.1.1	According to Security Level 1 Test Cases V1.1.1
<b>Dimensions</b> Width	50 mm	50 mm	50 mm
Height	117 mm	117 mm	117 mm
Depth	74 mm	74 mm	74 mm
<b>Weights</b> Weight, approx.	191 g; IM155PN ST with BA 2x RJ45 (mounted)	147 g; without bus adapter	147 g; without bus adapter

#### Ordering data

	<b>Article No.</b>
<b>Interface module Standard</b> • IM 155-6PN ST, with server module and installed BusAdapter BA 2xRJ45 • IM 155-6PN ST, with server module, without BusAdapter	<b>6ES7155-6AA00-0BNO</b>  <b>6ES7155-6AU00-0BNO</b>
<b>Interface module High Feature</b> • IM 155-6PN HF, incl. server module, without BusAdapter	<b>6ES7155-6AU00-0CN0</b>

#### Accessories

##### Digital input modules

Digital input module DI 8x24 V DC Standard, BU type A0, color code CC01

Digital input module DI 16x24 V DC Standard, BU type A0, color code CC00

Digital input module DI 8x24 V DC High Feature, BU type A0, color code CC01, channel-specific diagnostics, isochronous mode, shared input (MSI)

Digital input module DI 8x24 V DC Source Input, Basic, BU type A0, color code CC02

Digital input module DI 8xNAMUR High Feature, BU type A0, color code CC01

Digital input module DI 4x120 V AC-230 V AC Standard, BU type B1, color code CC41

Fail-safe digital input module F-DI 8x24 V DC High Feature, BU type A0, color code CC01, SIL3/Cat.4/PLe

#### Article No.

**6ES7131-6BF00-0BA0**

**6ES7131-6BH00-0BA0**

**6ES7131-6BF00-0CA0**

**6ES7131-6BF60-0AA0**

**6ES7131-6TF00-0CA0**

**6ES7131-6FD00-0BB1**

**6ES7136-6BA00-0CA0**



Ordering data	Article No.	Article No.	
<i>Accessories (continued)</i>		<i>Accessories (continued)</i>	
<b>Digital output modules</b>		<b>Analog output modules</b>	
Digital output module DQ 4x24 V DC/ 2 A Standard, BU type A0, color code CC02	<b>6ES7132-6BD20-0BA0</b>	Analog output module AQ 4xU/I Standard, BU type A0 or A1, color code CC00, 16 bit, ± 0.3%	<b>6ES7135-6HD00-0BA1</b>
Digital output module DQ 4x24 V DC/ 2 A High Feature, BU type A0, color code CC02, channel-precise diagnostics, isochronous mode, shared output (MSO)	<b>6ES7132-6BD20-0CA0</b>	Analog output module AQ 2xU/I High Speed, BU type A0 or A1, color code CC00, 16 bit, ± 0.3%	<b>6ES7135-6HB00-0DA1</b>
Digital output module DQ 4x24 V AC-230 V AC/2 A Standard for BU type B1, color code CC41	<b>6ES7132-6FD00-0BB1</b>	Analog output module AQ 2xU/I High Feature, BU type A0 or A1, color code CC00, 16 bit, ± 0.1%	<b>6ES7135-6HB00-0CA1</b>
Digital output module DQ 8x24 V DC/ 0.5 A Standard, BU type A0, color code CC02	<b>6ES7132-6BF00-0BA0</b>	<b>Communication modules</b>	
Digital output module DQ 8x24 V DC/ 0.5 A High Feature, BU type A0, color code CC02	<b>6ES7132-6BF00-0CA0</b>	Communication module CM 1xPtP Standard, for serial communication connections with RS232 and RS422 interfaces. RS485, BU type A0, color code CC00	<b>6ES7137-6AA00-0BA0</b>
Digital output module DQ 8x24 V DC/ 0.5 A Sink output, Basic, BU type A0, color code CC01	<b>6ES7132-6BF60-0AA0</b>	CM 4xIO-Link Master V1.1 Standard communication module, for connecting up to 4 IO-Link devices, time-based IO, BU type A0, color code CC04	<b>6ES7137-6BD00-0BA0</b>
Digital output module DQ 16x24 V DC/ 0.5 A Standard, BU type A0, color code CC00	<b>6ES7132-6BH00-0BA0</b>	CM AS-i Master ST communication module, BU type C0 or C1, color code CC00	<b>3RK7137-6SA00-0BC1</b>
Relay module RQ NO 4x120 V DC - 230 V AC/5 A Standard, normally-open, BU type B0, color code CC00	<b>6ES7132-6HD00-0BB0</b>	<b>Special modules</b>	
Signal relay module RQ CO 4x24 V UC/2 A Standard, changeover contact, BU type A0, color code CC00	<b>6ES7132-6GD50-0BA0</b>	Fail-safe power module F-PM-E 24 V DC/8 A PPM Standard, BU type C0, color code CC52. 2 inputs, 1 output, SIL3/Cat.4/PLe	<b>6ES7136-6PA00-0BC0</b>
Fail-safe digital output module F-DQ 4x24 V DC High Feature, BU type A0, color code CC01, SIL3/Cat.4/PLe	<b>6ES7136-6DB00-0CA0</b>	<b>BusAdapter BA 2xRJ45</b>	<b>6ES7193-6AR00-0AA0</b>
Fail-safe digital F output module relay 1 F-RQ, BU type F0, relay output (2 NO contacts), total output current 5 A, load voltages 24 V DC and 24...230 V AC; can be used up to SIL3 / Category 4/PLe if controlled via F-DQ	<b>6ES7136-6RA00-0BF0</b>	<b>BusAdapter BA 2xFC for increased vibration and EMC loads</b>	<b>6ES7193-6AF00-0AA0</b>
<b>Analog input modules</b>		<b>BusAdapter BA 2xSCRJ, fiber-optic connection for POF or PCF cables up to 250 m, with monitoring of damping</b>	<b>6ES7193-6AP00-0AA0</b>
Analog input module AI 4xU/I 2-wire Standard, BU type A0 or A1, color code CC03, 16 bit, ± 0.3%	<b>6ES7134-6HD00-0BA1</b>	Can only be used with High Feature interface modules	
Analog input module AI 4xI 2-/4-wire Standard, BU type A0 or A1, color code CC03, 16 bit, ± 0.3%	<b>6ES7134-6GD00-0BA1</b>	<b>Reference identification label</b>	<b>6ES7193-6LF30-0AW0</b>
Analog input module AI 4xRTD/TC 2-, 3-, 4-wire High Feature, BU type A0 or A1, color code CC00, 16 bit, ± 0.1%, scalable measuring range	<b>6ES7134-6JD00-0CA1</b>	10 sheets of 16 labels	
Analog input module AI 2xU/I 2-/4-wire High Speed, BU type A0 or A1, color code CC00, 16 bit, ± 0.3%, isochronous mode above 250 µs, oversampling above 50 µs	<b>6ES7134-6HB00-0DA1</b>	<b>Shield connection</b>	<b>6ES7193-6SC00-1AM0</b>
Analog input module AI 8xRTD/TC 2-wire High Feature, BU type A0 or A1, color code CC00, 16 bit, ± 0.1%, scalable measuring range	<b>6ES7134-6JF00-0CA1</b>	5 shield connections and 5 shield terminals each for plugging onto BaseUnits with automatic low-impedance connection to functional ground	
Analog input module AI 2xU/I 2-/4-wire High Feature, BU type A0 or A1, color code CC05, 16 bit, ± 0.1%, independent channel isolation, isochronous mode above 1 ms	<b>6ES7134-6HB00-0CA1</b>	<b>Labeling strips</b>	
Analog input module AI Energy Meter Standard, BU type D0, color code CC00	<b>6ES7134-6PA00-0BD0</b>	500 labeling strips on roll, light gray, for inscription with thermal transfer roll printer	<b>6ES7193-6LR10-0AA0</b>
		500 labeling strips on roll, yellow, for inscription with thermal transfer roll printer	<b>6ES7193-6LR10-0AG0</b>
		1000 labeling strips DIN A4, light gray, card, for inscription with laser printer	<b>6ES7193-6LA10-0AA0</b>
		1000 labeling strips DIN A4, yellow, card, for inscription with laser printer	<b>6ES7193-6LA10-0AG0</b>

# PROFINET/Industrial Ethernet

## SIMATIC ET 200SP

### Interface modules without CPU

IM 155-6

#### Ordering data

#### Article No.

##### Accessories (continued)

##### IE FC RJ45 plugs

RJ45 plug connector for Industrial Ethernet with a rugged metal enclosure and integrated insulation displacement contacts for connecting Industrial Ethernet FC installation cables

##### IE FC RJ45 Plug 180

180° cable outlet

1 unit

**6GK1901-1BB10-2AA0**

10 units

**6GK1901-1BB10-2AB0**

50 units

**6GK1901-1BB10-2AE0**

##### DIN rail 35 mm

Length: 483 mm  
for 19" cabinets

**6ES5710-8MA11**

Length: 530 mm  
for 600 mm cabinets

**6ES5710-8MA21**

Length: 830 mm  
for 900 mm cabinets

**6ES5710-8MA31**

Length: 2 m

**6ES5710-8MA41**

##### Manuals for ET 200SP distributed I/O system

ET 200SP library:  
ET 200SP Manual Collection, comprising system manual, product information, and device manuals

Manuals can be downloaded from the Internet as PDF files:

<http://www.siemens.com/simatic-doku>

##### SIMATIC Manual Collection

**6ES7998-8XC01-8YE0**

Electronic manuals on DVD, multi-language: LOGO!, SIMADYN, SIMATIC bus components, SIMATIC C7, SIMATIC distributed I/O, SIMATIC HMI, SIMATIC Sensors, SIMATIC NET, SIMATIC PC Based Automation, SIMATIC PCS 7, SIMATIC PG/PC, SIMATIC S7, SIMATIC Software, SIMATIC TDC

##### SIMATIC Manual Collection update service for 1 year

**6ES7998-8XC01-8YE2**

Current "Manual Collection" DVD and the three subsequent updates

##### Spare parts

##### Server module

**6ES7193-6PA00-0AA0**

##### Power supply connector for interface module

for connecting the 24 V DC supply voltage

with push-in terminals (10 units)

**6ES7193-4JB00-0AA0**

with screw-type terminals (10 units)

**6ES7193-4JB50-0AA0**

#### More information

##### Brochures

Information material for downloading can be found on the Internet:

<http://www.siemens.com/simatic/printmaterial>

2

## Overview



- Interface module for SIMATIC ET 200S with integrated CPU S7-314
- For high-performance control solutions in ET 200S
- Increase of the availability of systems and machines
- PROFINET IO Controller for up to 128 IO Devices
- PROFINET I-Device for connecting the CPU as an intelligent PROFINET device under a SIMATIC or non-Siemens PROFINET IO controller
- PROFINET interface with integrated 3-port switch
- Isochronous mode on PROFINET
- With many communication options: PG/OP communication, PROFINET IO, PROFINET CBA, open IE communication (TCP, ISO-on-TCP and UDP), web server and S7-communication (with loadable FBs)
- Fast, simple and end-to-end programming of a system with modular programs via STEP 7
- Compact SIMATIC Micro Memory Card (MMC)
- Optional PROFIBUS master for 32 PROFIBUS DP slaves (with master interface 6ES7138-4HA00-0AB0)
- Fail-safe IM 151-8F PN/DP CPU PROFIsafe available

### Note:

SIMATIC Micro Memory Card required for operation of CPU.

## Technical specifications

6ES7151-8AB01-0AB0 IM 151-8 PN/DP CPU	
<b>General information</b>	
Engineering with	
• Programming package	STEP7 V 5.5 or higher
<b>Supply voltage</b>	
24 V DC	Yes
<b>Power losses</b>	
Power loss, typ.	5.5 W
<b>Memory</b>	
Work memory	
• integrated	192 kbyte
• Size of retentive memory for retentive data blocks	64 kbyte
Load memory	
• pluggable (MMC), max.	8 Mbyte
<b>CPU processing times</b>	
for bit operations, typ.	0.06 µs
for word operations, typ.	0.12 µs
for fixed point arithmetic, typ.	0.16 µs
for floating point arithmetic, typ.	0.59 µs
<b>Counters, timers and their retentivity</b>	
S7 counter	
• Number	256
IEC counter	
• present	Yes
S7 times	
• Number	256
IEC timer	
• present	Yes
<b>Data areas and their retentivity</b>	
Flag	
• Number, max.	256 byte

6ES7151-8AB01-0AB0 IM 151-8 PN/DP CPU	
<b>Address area</b>	
I/O address area	
• Inputs	2 048 byte
• Outputs	2 048 byte
Process image	
• Inputs, adjustable	2 048 byte
• Outputs, adjustable	2 048 byte
<b>Time of day</b>	
Clock	
• Hardware clock (real-time clock)	Yes
Operating hours counter	
• Number	1
<b>1st interface</b>	
Interface type	
	PROFINET
Physics	
	Ethernet
Number of ports	
	3; RJ45
Functionality	
• MPI	No
• DP master	No
• DP slave	No
• PROFINET IO Device	Yes; Also simultaneously with IO Controller functionality
• PROFINET IO Controller	Yes; Also simultaneously with IO-Device functionality
• PROFINET CBA	Yes
• Point-to-point connection	No
PROFINET IO Controller	
• Max. number of connectable IO devices for RT	128
• Number of IO devices with IRT and the option "high flexibility"	128
• Number of IO Devices with IRT and the option "high performance", max.	64

# PROFINET/Industrial Ethernet

## SIMATIC ET 200S

### Interface modules with CPU

#### IM 151-8 PN/DP CPU

#### Technical specifications (continued)

6ES7151-8AB01-0AB0 IM 151-8 PN/DP CPU	
<b>2nd interface</b>	
Interface type	External interface via master module 6ES7138-4HA00-0AB0
Physics	RS 485
Functionality	
• MPI	No
• DP master	Yes
• DP slave	No
• PROFINET IO Controller	No
• PROFINET IO Device	No
• PROFINET CBA	No
DP master	
• Number of DP slaves, max.	32; Per station
<b>Isochronous mode</b>	
Isochronous operation (application synchronized up to terminal)	No
<b>Communication functions</b>	
PG/OP communication	Yes
Data record routing	Yes; With DP master module
Global data communication	
• supported	No
S7 basic communication	
• supported	Yes; I blocks
S7 communication	
• supported	Yes
Open IE communication	
• TCP/IP	Yes; via integrated PROFINET interface and loadable FBs 8
- Number of connections, max.	8
• ISO-on-TCP (RFC1006)	Yes; via integrated PROFINET interface and loadable FBs 8
- Number of connections, max.	8
• UDP	Yes; via integrated PROFINET interface and loadable FBs 8
- Number of connections, max.	8
Web server	
• supported	Yes
Number of connections	
• overall	12
<b>Configuration</b>	
programming	
• Programming language	
- LAD	Yes
- FBD	Yes
- STL	Yes
- SCL	Yes; Optional
- CFC	Yes; Optional
- GRAPH	Yes; Optional
- HiGraph®	Yes; Optional
Know-how protection	
• User program protection/ password protection	Yes
• Block encryption	Yes; With S7 block Privacy
<b>Dimensions</b>	
Width	120 mm; DP master module: 35 mm
Height	119.5 mm
Depth	75 mm
<b>Weights</b>	
Weight, approx.	320 g; DP master module: Approx. 100 g

#### Ordering data

#### Article No.

<b>IM 151-8 PN/DP CPU interface module (192 K)</b> Including termination module	<b>6ES7151-8AB01-0AB0</b>
<b>Accessories</b>	
<b>MMC 64 kByte</b> <sup>1)</sup> for program backup	<b>6ES7953-8LF30-0AA0</b>
<b>MMC 128 kByte</b> <sup>1)</sup> for program backup	<b>6ES7953-8LG30-0AA0</b>
<b>MMC 512 kByte</b> <sup>1)</sup> for program backup	<b>6ES7953-8LJ30-0AA0</b>
<b>MMC 2 MByte</b> <sup>1)</sup> for program backup and/or firmware update	<b>6ES7953-8LL31-0AA0</b>
<b>MMC 4 MByte</b> <sup>1)</sup> for program backup	<b>6ES7953-8LM31-0AA0</b>
<b>MMC 8 MByte</b> <sup>1)</sup> for program backup	<b>6ES7953-8LP31-0AA0</b>
<b>External prommer</b> for MMC, among others, with USB interface	<b>6ES7792-0AA00-0XA0</b>
<b>PG</b> with integrated MMC interface	On request
<b>Label sheets DIN A4 (10 units)</b> Each sheet contains 60 label strips for peripheral modules and 20 label strips for interface modules	
• petrol	<b>6ES7193-4BH00-0AA0</b>
• red	<b>6ES7193-4BD00-0AA0</b>
• yellow	<b>6ES7193-4BB00-0AA0</b>
• light beige	<b>6ES7193-4BA00-0AA0</b>
<b>ET 200S distributed I/O system manuals</b> are available on the Internet as PDF files:	<a href="http://www.siemens.com/simatic-docu">http://www.siemens.com/simatic-docu</a>
<b>Terminating module</b> as spare part for ET 200S	<b>6ES7193-4JA00-0AA0</b>
<b>Power supply connector</b> Spare part for connecting the 24 V DC supply voltage	
• with push-in terminals	<b>6ES7193-4JB00-0AA0</b>
• with screw terminals, 2-pin	<b>6ES7193-4JB50-0AA0</b>
<b>SIMATIC S5, 35 mm DIN rail</b>	
• Length: 483 mm for 19" cabinets	<b>6ES5710-8MA11</b>
• Length: 530 mm for 600 mm cabinets	<b>6ES5710-8MA21</b>
• Length: 830 mm for 900 mm cabinets	<b>6ES5710-8MA31</b>
• 2 m long	<b>6ES5710-8MA41</b>
<b>Industrial Ethernet FC RJ45 Plug 90</b> RJ45 plug connector for Industrial Ethernet with a rugged metal enclosure and integrated insulation displacement contacts for connecting Industrial Ethernet FC installation cables: with 90° cable outlet	
• 1 unit	<b>6GK1901-1BB20-2AA0</b>
• 10 units	<b>6GK1901-1BB20-2AB0</b>
• 50 units	<b>6GK1901-1BB20-2AE0</b>
<b>Industrial Ethernet FastConnect installation cables</b>	
• FastConnect Standard Cable	<b>6XV1840-2AH10</b>
• FastConnect Trailing Cable	<b>6XV1840-3AH10</b>
• FastConnect Marine Cable	<b>6XV1840-4AH10</b>
<b>Industrial Ethernet FastConnect stripping tool</b>	<b>6GK1901-1GA00</b>

<sup>1)</sup> An MMC is essential to operate the CPU

## Overview



PROFIBUS DP master interface module for IM 151-7(F) CPU / IM 151-8(F) PN/DP CPU interface modules

- Integrated 12 Mbit/s PROFIBUS DP master interface in copper design
- Facilitates parallel operation of two PROFIBUS DP interfaces on one IM 151-7 (F-)CPU
- Enables operation of a PROFIBUS DP interface on an IM 151-8(F) PN/DP CPU
- Increases the availability of plants and machinery
- Functionality corresponds to the interface of an S7-300 CPU 314-2 DP configured as DP master

Programming is with STEP 7 from Version V5.2 with Service Pack 1.

## Technical specifications

6ES7138-4HA00-0AB0	
<b>Hardware configuration</b>	
Number of modules per CPU	1
<b>Dimensions</b>	
Width	35 mm
Height	119.5 mm
Depth	75 mm
<b>Weights</b>	
Weight, approx.	100 g

## Ordering data

**Master interface module for IM 151-7 CPU / IM 151-7 F-CPU / IM 151-8 PN/DP CPU / IM 151-8F PN/DP CPU interface modules**

## Article No.

6ES7138-4HA00-0AB0

### Accessories

#### PROFIBUS DP bus connector RS 485

with 90° cable outlet, max. transfer rate 12 Mbit/s

- Without PG interface
- with PG interface

6ES7972-0BA12-0XA0  
6ES7972-0BB12-0XA0

with 90° cable outlet for FastConnect connection system, max. transfer rate 12 Mbit/s

- without PG interface, 1 unit
- without PG interface, 100 units
- with PG interface, 1 unit
- with PG interface, 100 units

6ES7972-0BA52-0XA0  
6ES7972-0BA52-0XB0  
6ES7972-0BB52-0XA0  
6ES7972-0BB52-0XB0

#### PROFIBUS Fast Connect bus cable

Standard type with special design for quick mounting, 2-core, shielded, sold by the meter, max. delivery unit 1000 m, minimum ordering quantity 20 m

6XV1830-0EH10

#### PROFIBUS bus components

For establishing MPI/PROFIBUS communication

See CA 01 catalog

#### Label sheets DIN A4 (10 pieces)

Each sheet contains 60 labeling strips for peripheral modules and 20 labeling strips for interface modules

- petrol
- red
- yellow
- light beige

6ES7193-4BH00-0AA0  
6ES7193-4BD00-0AA0  
6ES7193-4BB00-0AA0  
6ES7193-4BA00-0AA0

#### ET 200S distributed I/O system manuals

are available on the Internet as PDF files:

<http://www.siemens.com/simatic-doku>

## More information

### Brochures

Information material for downloading can be found in the Internet:

<http://www.siemens.com/simatic/printmaterial>

# PROFINET/Industrial Ethernet

## SIMATIC ET 200S

### Interface modules with fail-safe CPU

#### IM 151-8 F PN/DP CPU

#### Overview



- Interface module with integrated fail-safe CPU for SIMATIC ET 200S
- For constructing a fail-safe automation system for plants with increased safety requirements
- Complies with safety requirements up to SIL 3 according to IEC 61508, IEC 62061, up to PLe according to ISO 13849-1:2006 and PL e according to ISO 13849.1
- For high-performance control solutions in ET 200S
- Increase of the availability of systems and machines
- PROFINET IO Controller for up to 128 IO Devices
- PROFINET interface with integrated 3-port switch
- With many communication options: PG/OP communication, PROFINET IO, PROFINET CBA, open IE communication (TCP, ISO-on-TCP and UDP), web server and S7-communication (with loadable FBs)
- Fast, simple and end-to-end programming of a system with modular programs via STEP 7
- Compact SIMATIC Micro Memory Card (MMC)
- Optional PROFIBUS master for 32 PROFIBUS DP slaves (with master interface 6ES7138-4HA00-0AB0)

#### Note:

SIMATIC Micro Memory Card required for operation of CPU.

#### Technical specifications

6ES7151-8FB01-0AB0 IM 151-8 F PN/DP CPU	
<b>General information</b>	
Hardware product version	01
Firmware version	V3.2
Engineering with	
• Programming package	STEP 7 V 5.5 or higher, Distributed Safety V 5.4 SP4
<b>Supply voltage</b>	
24 V DC	Yes
<b>Power losses</b>	
Power loss, typ.	5.5 W
<b>Memory</b>	
Work memory	
• integrated	256 kbyte; F or program and data
• Size of retentive memory for retentive data blocks	64 kbyte
Load memory	
• pluggable (MMC), max.	8 Mbyte
<b>CPU processing times</b>	
for bit operations, typ.	0.06 µs
for word operations, typ.	0.12 µs
for fixed point arithmetic, typ.	0.16 µs
for floating point arithmetic, typ.	0.59 µs
<b>Counters, timers and their retentivity</b>	
S7 counter	
• Number	256
IEC counter	
• present	Yes
S7 times	
• Number	256
IEC timer	
• present	Yes
<b>Data areas and their retentivity</b>	
Flag	
• Number, max.	256 byte
<b>Address area</b>	
I/O address area	
• Inputs	2 048 byte
• Outputs	2 048 byte
Process image	
• Inputs, adjustable	2 048 byte
• Outputs, adjustable	2 048 byte
<b>Time of day</b>	
Clock	
• Hardware clock (real-time clock)	Yes
Operating hours counter	
• Number	1

**Technical specifications** (continued)

<b>6ES7151-8FB01-0AB0</b> <b>IM 151-8 F PN/DP CPU</b>	
<b>1st interface</b>	
Interface type	PROFINET
Physics	Ethernet
Number of ports	3; RJ45
Functionality	
• MPI	No
• DP master	No
• DP slave	No
• PROFINET IO Device	Yes; Also simultaneously with IO Controller functionality
• PROFINET IO Controller	Yes; Also simultaneously with IO-Device functionality
• PROFINET CBA	Yes
• Open IE communication	Yes
• Web server	Yes
- Number of HTTP clients	5
• Point-to-point connection	No
PROFINET IO Controller	
• Number of connectable IO devices, max.	128
• Number of IO devices with IRT and the option "high flexibility"	128
• Number of IO Devices with IRT and the option "high performance", max.	64
<b>2nd interface</b>	
Interface type	External interface via master module 6ES7138-4HA00-0AB0
Physics	RS 485
Functionality	
• MPI	No
• DP master	Yes
• DP slave	No
• PROFINET IO Controller	No
• PROFINET IO Device	No
• PROFINET CBA	No
DP master	
• Number of DP slaves, max.	32; Per station
<b>Isochronous mode</b>	
Isochronous operation (application synchronized up to terminal)	No

<b>6ES7151-8FB01-0AB0</b> <b>IM 151-8 F PN/DP CPU</b>	
<b>Communication functions</b>	
PG/OP communication	Yes
Data record routing	Yes; With DP master module
Global data communication	
• supported	No
S7 basic communication	
• supported	Yes; I blocks
S7 communication	
• supported	Yes
Open IE communication	
• TCP/IP	Yes; via integrated PROFINET interface and loadable FBs
- Number of connections, max.	8
• ISO-on-TCP (RFC1006)	Yes; via integrated PROFINET interface and loadable FBs
• UDP	Yes; via integrated PROFINET interface and loadable FBs
- Number of connections, max.	8
Web server	
• supported	Yes
Number of connections	
• overall	12
<b>Configuration</b>	
Configuration software	
• STEP 7	Yes; V5.5 or higher
programming	
• Programming language	
- LAD	Yes
- FBD	Yes
- STL	Yes
- SCL	Yes; Optional
- CFC	Yes; Optional
- GRAPH	Yes; Optional
- HiGraph®	Yes; Optional
Know-how protection	
• User program protection/password protection	Yes
• Block encryption	Yes; With S7 block Privacy
<b>Dimensions</b>	
Width	120 mm; DP master module: 35 mm
Height	119.5 mm
Depth	75 mm
<b>Weights</b>	
Weight, approx.	320 g; DP master module: Approx. 100 g

# PROFINET/Industrial Ethernet

## SIMATIC ET 200S

### Interface modules with fail-safe CPU

#### IM 151-8 F PN/DP CPU

Ordering data	Article No.	Article No.
<b>IM 151-8F PN/DP CPU interface module (256 K)</b> Including termination module	<b>6ES7151-8FB01-0AB0</b>	
<b>Distributed Safety V5.4 programming tool</b> <i>Task:</i> Engineering tool for configuring fail-safe user programs for SIMATIC S7-300F, S7-400F, WinAC RTX F, ET 200S, ET 200M, ET 200iSP, ET 200pro, ET 200eco <i>Requirement:</i> STEP 7 V5.3 SP3 and higher Floating license	<b>6ES7833-1FC02-0YA5</b> <b>6ES7833-1FC02-0YH5</b>	<b>6ES7193-4BH00-0AA0</b> <b>6ES7193-4BD00-0AA0</b> <b>6ES7193-4BB00-0AA0</b> <b>6ES7193-4BA00-0AA0</b>
Floating license for 1 user, license key download without software and documentation <sup>1)</sup> ; email address required for delivery.		
<b>Distributed Safety Upgrade</b> from V5.x to V5.4; Floating license for 1 user	<b>6ES7833-1FC02-0YE5</b>	
<b>STEP 7 Safety Advanced V13</b> <i>Task:</i> Engineering tool for configuring fail-safe user programs for SIMATIC S7-1500F, S7-300F, S7-400F, WinAC RTX F, ET200SP, ET 200S, ET 200M, ET 200iSP, ET 200pro, ET 200eco <i>Requirement:</i> STEP 7 Professional V13 Floating license for 1 user	<b>6ES7833-1FA13-0YA5</b> <b>6ES7833-1FA13-0YH5</b>	
Floating license for 1 user, license key download without software or documentation <sup>1)</sup> ; email address required for delivery		
<b>Accessories</b>		
<b>SIMATIC Micro Memory Cards</b>		
<b>MMC 64 KB <sup>2)</sup></b> for program backup	<b>6ES7953-8LF30-0AA0</b>	
<b>MMC 128 KB <sup>2)</sup></b> for program backup	<b>6ES7953-8LG30-0AA0</b>	
<b>MMC 512 KB <sup>2)</sup></b> for program backup	<b>6ES7953-8LJ30-0AA0</b>	
<b>MMC 2 MB <sup>2)</sup></b> for program backup and/or firmware update	<b>6ES7953-8LL31-0AA0</b>	
<b>MMC 4 MB <sup>2)</sup></b> for program backup	<b>6ES7953-8LM31-0AA0</b>	
<b>MMC 8 MB <sup>2)</sup></b> for program backup	<b>6ES7953-8LP31-0AA0</b>	
<b>External prommer</b> for MMC with USB interface	<b>6ES7792-0AA00-0XA0</b>	
<b>PG</b> with integrated MMC interface	On request	
<b>Accessories (continued)</b>		
<b>Label sheets DIN A4 (10 pieces)</b> Each sheet contains 60 labeling strips for peripheral modules and 20 labeling strips for interface modules • Petrol • Red • Yellow • Light beige		
<b>ET 200S distributed I/O system manuals</b> are available on the Internet as PDF files:		<a href="http://www.siemens.com/simatic-docu">http://www.siemens.com/simatic-docu</a>
<b>Termination module</b> as spare part for ET 200S		<b>6ES7193-4JA00-0AA0</b>
<b>Power supply connector</b> Spare part for connecting the 24 V DC supply voltage • with push-in terminals • with screw terminals, 2-pin		<b>6ES7193-4JB00-0AA0</b> <b>6ES7193-4JB50-0AA0</b>
<b>SIMATIC S5, 35 mm DIN rail</b> • Length: 483 mm for 19" cabinets • Length: 530 mm for 600 mm cabinets • Length: 830 mm for 900 mm cabinets • Length: 2 m		<b>6ES5710-8MA11</b> <b>6ES5710-8MA21</b> <b>6ES5710-8MA31</b> <b>6ES5710-8MA41</b>
<b>Industrial Ethernet FC RJ45 Plug 90</b> RJ45 plug connector for Industrial Ethernet with a rugged metal enclosure and integrated insulation displacement contacts for connecting Industrial Ethernet FC installation cables; with 90° cable outlet • 1 unit • 10 units • 50 units		<b>6GK1901-1BB20-2AA0</b> <b>6GK1901-1BB20-2AB0</b> <b>6GK1901-1BB20-2AE0</b>
<b>Industrial Ethernet FastConnect installation cables</b> • FastConnect Standard Cable • FastConnect Trailing Cable • FastConnect Marine Cable		<b>6XV1840-2AH10</b> <b>6XV1840-3AH10</b> <b>6XV1840-4AH10</b>
<b>Industrial Ethernet FastConnect stripping tool</b>		<b>6GK1901-1GA00</b>

<sup>1)</sup> For up-to-date information and download availability, see: <http://www.siemens.com/tia-online-software-delivery>

<sup>2)</sup> An MMC is essential for operating the CPU



## Overview



- Interface module for linking the ET 200S to PROFINET
- Handles all data exchange with the PROFINET I/O Controller
- 3 versions:
  - IM151-3 PN STANDARD
  - IM151-3 PN HIGH FEATURE and IM 151-3 PN FO: supports, in contrast to the STANDARD version, the operation of PROFIsafe F modules
- with integrated 2-port switch for line topology
- Delivery including connecting module

### Note:

Micro Memory Card required for operation depending on the configuration.

## Technical specifications

	6ES7151-3AA23-0AB0 IM 151-3 PN	6ES7151-3BA23-0AB0 IM 151-3 PN PROFINET High Feature
<b>General information</b>		
Vendor identification (VendorID)	002AH	002AH
Device identifier (DeviceID)	0301H	0301H
<b>Supply voltage</b>		
Mains buffering		
• Mains buffering, min.	20 ms	20 ms
<b>Address area</b>		
Addressing volume		
• Inputs	256 byte	256 byte
• Outputs	256 byte	256 byte
<b>Interfaces</b>		
Supports protocol for PROFINET IO		
• RJ45	Yes	Yes
<b>Protocols</b>		
Supports protocol for PROFINET IO	Yes	Yes
<b>Isochronous mode</b>		
Isochronous operation (application synchronized up to terminal)	No	No
<b>Interrupts/diagnostics/status information</b>		
Alarms		
• Alarms	Yes	Yes
Diagnostic messages		
• Diagnostic functions	Yes	Yes
Diagnostics indication LED		
• Bus fault BF (red)	Yes	Yes
• Group error SF (red)	Yes	Yes
• Monitoring 24 V voltage supply ON (green)	Yes	Yes
• Connection to network LINK (green)	Yes	Yes
• Transmit/receive RX/TX (yellow)	Yes	Yes
<b>Galvanic isolation</b>		
between backplane bus and electronics	No	No
between supply voltage and electronics	No	No
between Ethernet and electronics	Yes	Yes
<b>Dimensions</b>		
Width	60 mm	60 mm
Height	119.5 mm	119.5 mm
Depth	75 mm	75 mm
<b>Weights</b>		
Weight, approx.	120 g	135 g

# PROFINET/Industrial Ethernet

## SIMATIC ET 200S

### Interface modules without CPU

#### IM 151-3 PN

#### Ordering data

#### Article No.

#### Article No.

#### IM 151-3 PN interface module

6ES7151-3AA23-0AB0

For ET 200S;  
transfer rates up to 100 Mbit/s;  
data volume depends on the  
number of modules inserted,  
up to 63 modules can be connected,  
bus connection through RJ45

#### IM 151-3 PN PROFINET High Feature interface module

6ES7151-3BA23-0AB0

for ET 200S;  
transfer rate up to 100 Mbit/s;  
max. 63 modules up to 2 m wide  
can be connected; bus connection  
via RJ45, incl. termination module

#### IM 151-3 FO interface module

6ES7151-3BB23-0AB0

for ET 200S;  
with 2 PROFINET FO-interfaces and  
integrated 2-port switch,  
max. 63 modules up to 2 m wide  
can be connected,  
incl. termination module

#### Accessories

#### Industrial Ethernet FC RJ45 Plug 90

RJ45 plug connector  
for Industrial Ethernet with a rugged  
metal enclosure and integrated  
insulation displacement contacts  
for connecting Industrial Ethernet  
FC installation cables;  
with 90° cable outlet

1 unit

6GK1901-1BB20-2AA0

10 units

6GK1901-1BB20-2AB0

50 units

6GK1901-1BB20-2AE0

#### Industrial Ethernet FastConnect installation cables

Fast Connect standard cable

6XV1840-2AH10

Fast Connect trailing cable

6XV1840-3AH10

Fast Connect marine cable

6XV1840-4AH10

#### Termination Kits

SC RJ POF Plug  
Assembly case for on-site assembly  
of SC RJ plugs consisting of strip-  
ping tool, kevlar cutter, microscope,  
abrasive paper, grinding support

6GK1900-0ML00-0AA0

IE SC RJ POF Plug  
Screw-in plug for on-site assembly  
to POF fiber optic cable  
(1 pack = 20 units)

6GK1900-0MB00-0AC0

IE SC RJ Refill Set POF  
Refill set for Termination Kit SC RJ  
POF Plug, consisting of abrasive  
paper and grinding plate (set of 5)

6GK1900-0MN00-0AA0

SC RJ POF Plug  
Assembly case for on-site assembly  
of SC RJ plugs consisting of strip-  
ping tool, buffer stripping tool, kev-  
lar cutter, fiber breaking tool,  
microscope

6GK1900-0NL00-0AA0

Industrial Ethernet SC RJ PCF Plug  
Screw-in plug for on-site assembly  
to PCF fiber optic cable  
(1 pack = 10 units)

6GK1900-0NB00-0AC0

#### Industrial Ethernet Fast Connect stripping tool

6GK1901-1GA00

#### MMCs for storing the device name

MMC 64 kByte <sup>1)</sup>

6ES7953-8LF30-0AA0

MMC 128 kByte <sup>1)</sup>

6ES7953-8LG30-0AA0

MMC 512 kByte <sup>1)</sup>

6ES7953-8LJ30-0AA0

#### MMCs for storing the device name and/or firmware update

MMC 2 MByte <sup>1)</sup>

6ES7953-8LL31-0AA0

MMC 4 MByte <sup>1)</sup>

6ES7953-8LM31-0AA0

MMC 8 MByte <sup>1)</sup>

6ES7953-8LP31-0AA0

#### ET 200S distributed I/O system manuals

are available on the Internet  
as PDF files:

<http://www.siemens.com/simatic-doku>

#### SIMATIC Manual Collection

Electronic manuals on DVD,  
multi-language:  
S7-200, TD 200, S7-300, M7-300,  
C7, S7-400, M7-400, STEP 7, Engi-  
neering Tools, Runtime Software,  
SIMATIC DP (Distributed I/O),  
SIMATIC HMI (Human Machine  
Interface), SIMATIC NET (Industrial  
Communication)

6ES7998-8XC01-8YE0

#### SIMATIC Manual Collection – Update service for 1 year

Scope of delivery: Current DVD  
"S7 Manual Collection" and the  
three subsequent updates

6ES7998-8XC01-8YE2

#### Label sheets DIN A4 (10 pieces)

Each sheet contains 60 labeling strips  
for peripheral modules and 20 label-  
ing strips for interface modules

- petrol
- red
- yellow
- light beige

6ES7193-4BH00-0AA0

6ES7193-4BD00-0AA0

6ES7193-4BB00-0AA0

6ES7193-4BA00-0AA0

#### Termination module

as spare part for ET 200S

6ES7193-4JA00-0AA0

#### Power supply connector

Spare part; for connecting the  
24 V DC supply voltage

- with push-in terminals
- with screw-type terminals

6ES7193-4JB00-0AA0

6ES7193-4JB50-0AA0

#### DIN rail 35 mm

- Length: 483 mm for 19" cabinets
- Length: 530 mm  
for 600 mm cabinets
- Length: 830 mm  
for 900 mm cabinets
- Length: 2 m

6ES5710-8MA11

6ES5710-8MA21

6ES5710-8MA31

6ES5710-8MA41

#### Industrial Ethernet Switches

Managed Industrial Ethernet  
Switches; Isochronous real time,  
LED diagnostics, fault signaling  
contact with SET button,  
redundant power supply

- SCALANCE X202-2P IRT;  
2 x 10/100 Mbit/s RJ45 ports,  
2 x 100 Mbit/s POF/PCF SC RJ
- SCALANCE X201-3P IRT;  
1 x 10/100 Mbit/s RJ45 ports,  
3 x 100 Mbit/s POF/PCF SC RJ
- SCALANCE X200-4P IRT;  
4 x 100 Mbit/s POF/PCF SC RJ

6GK5202-2BH00-2BA3

6GK5201-3BH00-2BA3

6GK5200-4AH00-2BA3

<sup>1)</sup> For operating the IM 151-3, an MMC is essential

#### More information

##### Brochures

Information material for downloading can be found  
in the Internet:

<http://www.siemens.com/simatic/printmateria>

## Overview



- Interface modules for linking the ET 200MP to PROFINET
- These handle data exchange with the PROFINET I/O controller in the PLC
- Integrated 2-port switch for line topology
- Max. 30 I/O modules
- Shortest bus cycle 250 µs
- Linking to the isochronous task of the CPU

- Prioritized fast startup (FSU) with 500 ms (max. 12 I/O modules)
- Media Redundancy Protocol (MRP)
- Shared device on up to two I/O controllers (when configuring using GSD file; depends on the respective configuration tool)
- Omission of SIMATIC memory card (SMC); IM replacement without PG using LLDP

Starting from FW version V2.0.0, the IM155-5 PN ST interface module supports the following new functions:

- Submodule-granular shared device with up to two I/O controllers
- Configuration control (option handling)
- Module-internal shared input and output (MSI/MSO), i.e. the inputs or outputs of a module can be made available simultaneously to up to two I/O controllers

The IM155-5 PN HF interface module has the following additional functions:

- Shared device on up to 4 IO controllers
- Module-internal shared input and output (MSI/MSO) on up to four IO controllers
- Operation on a highly available SIMATIC S7-400H
- Support for the MRPD function (media redundancy with planned duplication)

## Technical specifications

	6ES7155-5AA00-0AB0 IM 155-5 PN ST	6ES7155-5AA00-0AC0 IM 155-5 PN HF
<b>General information</b>		
Product function		
• I&M data	Yes; I&M0 to I&M3	Yes; I&M0 to I&M3
Engineering with		
• STEP 7 TIA Portal can be configured/integrated as of version	V13 / V13	V13 / V13
• STEP 7 can be configured/integrated as of version	V5.5 SP3 / -	V5.5 SP3 / -
• PROFINET as of GSD version/GSD revision	V2.3 / -	V2.3 / -
<b>Supply voltage</b>		
Type of supply voltage	DC	DC
Rated value (DC)	24 V	24 V
Reverse polarity protection	Yes	Yes
Short-circuit protection	Yes	Yes
Mains buffering		
• Mains/voltage failure stored energy time	5 ms	5 ms
<b>Hardware configuration</b>		
Integrated power supply		Yes
Rack		
• Modules per rack, max.	30; I/O modules	30; I/O modules
<b>Interfaces</b>		
Number of PROFINET interfaces	1	1
1st interface		
• Interface types		
- Number of ports	2	2
- Integrated switch	Yes	Yes
- RJ 45 (Ethernet)	Yes	Yes
• Protocols		
- PROFINET IO Device	Yes	Yes
- Media redundancy	Yes	Yes

# PROFINET/Industrial Ethernet

## SIMATIC ET 200MP

### Interface modules

#### IM 155-5 PN

#### Technical specifications (continued)

	6ES7155-5AA00-0AB0 IM 155-5 PN ST	6ES7155-5AA00-0AC0 IM 155-5 PN HF
<b>Interface types</b>		
RJ 45 (Ethernet)		
• 10 Mbps		No
• 100 Mbps	Yes	Yes
• Transmission procedure	PROFINET with 100 Mbit/s full duplex (100BASE-TX)	PROFINET with 100 Mbit/s full duplex (100BASE-TX)
• Autonegotiation	Yes	Yes
• Autocrossing	Yes	Yes
<b>Protocols</b>		
PROFINET IO	Yes	Yes
PROFINET IO Device		
• Services		
- Isochronous mode	Yes	Yes
- IRT, supported	Yes	Yes
- MRP, supported	Yes	Yes
- MRPD, supported		Yes
- PROFINET system redundancy		Yes
- Prioritized startup	Yes	Yes
- Shared device	Yes	Yes
- Number of IO controllers with shared device, max.	2	4
Open IE communication		
• TCP/IP	Yes	Yes
• SNMP	Yes	Yes
• LLDP	Yes	Yes
<b>Isochronous mode</b>		
Isochronous operation (application synchronized up to terminal)	Yes	Yes
equidistance	Yes	Yes
shortest clock pulse	250 µs	250 µs
max. cycle	4 ms	4 ms
<b>Interrupts/diagnostics/ status information</b>		
Status indicator	Yes	Yes
Alarms		
• Alarms	Yes	Yes
Diagnostic messages		
• Diagnostic functions	Yes	Yes
Diagnostics indication LED		
• RUN LED	Yes; Green LED	Yes; Green LED
• ERROR LED	Yes; Red LED	Yes; Red LED
• MAINT LED	Yes; yellow LED	Yes; yellow LED
• Connection display LINK TX/RX	Yes; yellow LED	Yes; yellow LED
<b>Isolation</b>		
Isolation checked with	707 V DC (type test)	707 V DC (type test)
<b>Dimensions</b>		
Width	35 mm	35 mm
Height	147 mm	155 mm
Depth	129 mm	120 mm
<b>Weights</b>		
Weight, approx.	310 g	350 g

Ordering data	Article No.	Article No.
<b>IM 155-5 PN interface module</b> IP 20 degree of protection, module width 35 mm, installation on S7-1500 mounting rail IM 155-5 PN ST, standard version IM 155-5 PN HF, High Feature version with additional functions	<b>6ES7155-5AA00-0AB0</b> <b>6ES7155-5AA00-0AC0</b>	<b>IE FC TP Standard Cable GP 2x2</b> 4-core, shielded TP installation cable for connection to IE FC Outlet RJ45/IE FC RJ45 Plug; PROFINET-compatible; with UL approval; Sold by the meter, max. length 1000 m; minimum order 20 m
<b>Accessories</b> <b>Front flap for IM 155-5 PN (spare part), 5 units</b> <b>SIMATIC S7-1500 mounting rail</b> Fixed lengths, with grounding elements <ul style="list-style-type: none"> <li>• 160 mm</li> <li>• 482 mm</li> <li>• 530 mm</li> <li>• 830 mm</li> </ul> For cutting to length by customer, without drill holes; grounding elements must be ordered separately <ul style="list-style-type: none"> <li>• 2000 mm</li> </ul>	<b>6ES7528-0AA70-7AA0</b> <b>6ES7590-1AB60-0AA0</b> <b>6ES7590-1AE80-0AA0</b> <b>6ES7590-1AF30-0AA0</b> <b>6ES7590-1AJ30-0AA0</b> <b>6ES7590-1BC00-0AA0</b>	<b>IE FC TP Trailing Cable 2 x 2 (Type C)</b> 4-core, shielded TP installation cable for connection to IE FC Outlet RJ45/IE FC RJ45 Plug 180/90 for trailing cable use; PROFINET-compatible; with UL approval; Sold by the meter, max. length 1000 m; minimum order 20 m
<b>PE connection element for mounting rail 2000 mm</b> 20 units	<b>6ES7590-5AA00-0AA0</b>	<b>IE FC TP Marine Cable 2 x 2 (Type B)</b> 4-core, shielded TP installation cable for connection to IE FC Outlet RJ45/IE FC RJ45 Plug 180/90 marine certified, Sold by the meter, max. length 1000 m; minimum order 20 m
<b>Power supply</b> For supplying the backplane bus of the S7-1500 24 V DC input voltage, power 25 W 24/48/60 V DC input voltage, power 60 W 120/230 V AC input voltage, power 60 W	<b>6ES7505-0KA00-0AB0</b> <b>6ES7505-0RA00-0AB0</b> <b>6ES7507-0RA00-0AB0</b>	<b>IE FC Stripping Tool</b> Preadjusted stripping tool for fast stripping of Industrial Ethernet FC cables
<b>Power connector</b> With coding element for power supply module; spare part, 10 units	<b>6ES7590-8AA00-0AA0</b>	<b>Client Modules SCALANCE W734</b> WLAN Ethernet client modules with built-in wireless interface; wireless networks IEEE 802.11a/b/g/h/n at 2.4/5 GHz up to 300 Mbit/s; WPA2/AES; integrated 2-port switch; Power over Ethernet (PoE), IP30 degree of protection (-20 °C to +60 °C); scope of delivery: Mounting hardware, 4-pin screw terminal for 24V DC; manual on CD-ROM; German/English
<b>Load power supply</b> 24 V DC/3 A 24 V DC/8 A	<b>6EP1332-4BA00</b> <b>6EP1333-4BA00</b>	<b>SCALANCE W734-1 RJ45</b> for managing the wireless connection of up to eight linked devices with Industrial Ethernet connection <ul style="list-style-type: none"> <li>• National approvals for operation outside the USA</li> <li>• National approvals for operation within the USA<sup>1)</sup></li> </ul>
<b>Power supply connector</b> Spare part; for connecting the 24 V DC supply voltage <ul style="list-style-type: none"> <li>• with push-in terminals</li> </ul>	<b>6ES7193-4JB00-0AA0</b>	<b>KEY-PLUG W740 iFeatures</b> Swap medium for enabling additional iFeatures, for simple device replacement if a fault occurs and for storage of configuration data; can be used in SCALANCE W client modules with PLUG compartment
<b>IE FC RJ45 Plugs</b> RJ45 plug connector for Industrial Ethernet with a rugged metal enclosure and integrated insulation displacement contacts for connecting Industrial Ethernet FC installation cables <b>IE FC RJ45 plug 180</b> 180° cable outlet 1 unit 10 units 50 units	<b>6GK1901-1BB10-2AA0</b> <b>6GK1901-1BB10-2AB0</b> <b>6GK1901-1BB10-2AE0</b>	<b>6XV1840-2AH10</b> <b>6XV1840-3AH10</b> <b>6XV1840-4AH10</b> <b>6GK1901-1GA00</b> <b>6GK5734-1FX00-0AA0</b> <b>6GK5734-1FX00-0AB0</b> <b>6GK5907-4PA00</b>

<sup>1)</sup> Please note national approvals under [http://www.siemens.com/wireless\\_approvals](http://www.siemens.com/wireless_approvals)

# PROFINET/Industrial Ethernet

## SIMATIC ET 200M

### Interface modules

#### IM 153-4 PN

#### Overview



- To connect ET 200M to PROFINET IO (via copper line, RJ45) as an IO device
- 2 versions:
  - IM 153-4 PN STANDARD
  - IM 153-4 PN HIGH FEATURE: supports, in contrast to the STANDARD version, the operation of PROFI-safe F and HART modules. The operation of an S7-400H (system redundancy) is likewise possible.
- Integrated 2-port switch
- 12 modules per station
- Usable I/O capacity: 192 bytes each
- Active bus backplane to hot-swap modules available as an option
- Baud rate 10 Mbit/s / 100 Mbit/s (autonegotiation / full duplex)
- I&M functions according to PNO-Guideline Order-No. 3.502, Version V1.1

#### Note:

Micro Memory Card with at least 64 KB required if not all the stations in the network support LLDP (Link Layer Discovery Protocol; proximity detection).

#### Technical specifications

	6ES7153-4AA01-0XB0 IM 153-4 PN STANDARD	6ES7153-4BA00-0XB0 IM 153-4 PN HIGH FEATURE
<b>General information</b>		
Vendor identification (VendorID)	002AH	002AH
Device identifier (DeviceID)	0302H	0302H
<b>Supply voltage</b>		
24 V DC	Yes	Yes
permissible range, lower limit (DC)	20.4 V	20.4 V
permissible range, upper limit (DC)	28.8 V	28.8 V
permissible range (ripple included), lower limit (DC)	20.4 V	18.5 V
permissible range (ripple included), upper limit (DC)	28.8 V	30.2 V
External protection for supply cables (recommendation)	In a construction with grounded reference potential, a fuse is necessary for redundant interface modules (Recommendation: 2.5 A)	In a construction with grounded reference potential, a fuse is necessary for redundant interface modules (Recommendation: 2.5 A)
<b>Mains buffering</b>		
• Mains/voltage failure stored energy time	5 ms	5 ms
<b>Input current</b>		
Current consumption, max.	600 mA	600 mA
Inrush current, typ.	4 A	4 A
I <sup>2</sup> t	0.09 A <sup>2</sup> ·s	0.09 A <sup>2</sup> ·s

**Technical specifications (continued)**

	<b>6ES7153-4AA01-0XB0</b> <b>IM 153-4 PN STANDARD</b>	<b>6ES7153-4BA00-0XB0</b> <b>IM 153-4 PN HIGH FEATURE</b>
<b>Output voltage</b>		
Rated value (DC)	5 V	5 V
Rated value, 5 V DC	Yes	Yes
<b>Output current</b> for backplane bus (5 V DC), max.	1.5 A	1.5 A
<b>Power losses</b>		
Power loss, typ.	6 W	6 W
<b>Address area</b>		
Addressing volume		
• Inputs	192 byte	672 byte; Extended HART user data
• Outputs	192 byte	192 byte
<b>Hardware configuration</b>		
Number of modules per DP slave interface, max.	12	12
<b>1st interface</b>		
PROFINET IO Controller		
• Services		
- PROFINET system redundancy		Yes
<b>Communication functions</b>		
Bus protocol/transmission protocol	PN IO	PN IO
<b>Interrupts/diagnostics/status information</b>		
Diagnostics indication LED		
• Connection to network LINK (green)	Yes	Yes
• Transmit/receive RX/TX (yellow)	Yes	Yes
<b>Isolation</b>		
Isolation checked with	500 V DC	Between PROFINET and 24 V supply: 1 500 V AC, between functional grounding and 24 V supply: 500 V DC
<b>Degree and class of protection</b>		
IP20	Yes	Yes
<b>Ambient conditions</b>		
Operating temperature		
• Min.	0 °C	0 °C
• max.	60 °C	60 °C
Air pressure		
• Operating altitude above sea level, max.	2 000 m	2 000 m
<b>Dimensions</b>		
Width	40 mm	40 mm
Height	125 mm	125 mm
Depth	118 mm	118 mm
<b>Weights</b>		
Weight, approx.	215 g	215 g

# PROFINET/Industrial Ethernet

## SIMATIC ET 200M

### Interface modules

#### IM 153-4 PN

Ordering data	Article No.	Article No.
<b>IM 153-4 PN interface module</b> I/O device to connect an ET 200M to PROFINET Standard High Feature	 <b>6ES7153-4AA01-0XB0</b> <b>6ES7153-4BA00-0XB0</b>	
<b>Accessories</b> <b>Bus modules for ET 200M</b> <ul style="list-style-type: none"> <li>To accommodate a power supply and an IM 153 module for the hot-swapping function during RUN, incl. bus module cover</li> <li>To accommodate two 40-mm wide I/O modules for the hot-swapping function</li> <li>To accommodate one 80-mm wide I/O module for the hot-swapping function</li> </ul>	<b>6ES7195-7HA00-0XA0</b> <b>6ES7195-7HB00-0XA0</b> <b>6ES7195-7HC00-0XA0</b>	
<b>SIMATIC Micro Memory Card</b> 64 KB <sup>1)</sup>	<b>6ES7953-8LF30-0AA0</b>	
<b>SIMATIC DP DIN rail for ET 200M</b> Accommodates up to 5 bus modules; for hot-swapping function <ul style="list-style-type: none"> <li>Length: 483 mm (19")</li> <li>Length: 530 mm</li> <li>Length: 620 mm</li> <li>Length: 2 000 mm</li> </ul>	<b>6ES7195-1GA00-0XA0</b> <b>6ES7195-1GF30-0XA0</b> <b>6ES7195-1GG30-0XA0</b> <b>6ES7195-1GC00-0XA0</b>	
<b>SIMATIC S7-300 mounting rail</b> Length: 160 mm Length: 480 mm (19") Length: 530 mm Length: 830 mm Length: 2000 mm	<b>6ES7390-1AB60-0AA0</b> <b>6ES7390-1AE80-0AA0</b> <b>6ES7390-1AF30-0AA0</b> <b>6ES7390-1AJ30-0AA0</b> <b>6ES7390-1BC00-0AA0</b>	
<b>Power supply connector</b> For connection of the 24 V DC power supply; spare part, 1 pack containing 10 units Spring-loaded connection Screw terminal connections	<b>6ES7193-4JB00-0AA0</b> <b>6ES7193-4JB50-0AA0</b>	
		<b>S7 Manual Collection</b> Electronic manuals on DVD, multi-language: S7-200, TD 200, S7-300, M7-300, C7, S7-400, M7-400, STEP 7, Engineering Tools, Runtime Software, SIMATIC DP (Distributed I/O), SIMATIC HMI (Human Machine Interface), SIMATIC NET (Industrial Communication)
		<b>6ES7998-8XC01-8YE0</b>
		<b>S7 Manual Collection update service for 1 year</b> Scope of delivery: Current DVD "S7 Manual Collection" and the three subsequent updates
		<b>6ES7998-8XC01-8YE2</b>
		<b>Industrial Ethernet FC RJ45 Plug 180</b> RJ45 plug connector for Industrial Ethernet with a rugged metal housing and integrated insulation displacement contacts for connecting Industrial Ethernet FC installation cables; with 180° cable outlet 1 unit 10 units 50 units
		<b>6GK1901-1BB10-2AA0</b> <b>6GK1901-1BB10-2AB0</b> <b>6GK1901-1BB10-2AE0</b>
		<b>Industrial Ethernet FastConnect installation cables</b> <ul style="list-style-type: none"> <li>Fast Connect standard cable</li> <li>Fast Connect trailing cable</li> <li>Fast Connect marine cable</li> </ul>
		<b>6XV1840-2AH10</b> <b>6XV1840-3AH10</b> <b>6XV1840-4AH10</b>
		<b>Industrial Ethernet FastConnect Stripping Tool</b>
		<b>6GK1901-1GA00</b>

<sup>1)</sup> To operate the IM153-4, an MMC is required with at least 64 KB memory. Cards with higher memory capacity may also be used.



## Overview



Interface module for processing the communication between ET 200pro and a higher-level controller over PROFINET IO.

2

## Technical specifications

	<b>6ES7154-4AB10-0AB0</b> <b>IM 154-4 PN High Feature</b>
<b>General information</b>	
Vendor identification (VendorID)	0x002A
Device identifier (DeviceID)	0x0305
<b>Supply voltage</b>	
24 V DC	Yes
permissible range, lower limit (DC)	20.4 V
permissible range, upper limit (DC)	28.8 V
Load voltage 1L+	
• Rated value (DC)	24 V
• Short-circuit protection	Yes; Fuse in lower part is exchangeable, the fuse on the IM-LP is not
• Reverse polarity protection	Yes; against destruction
<b>Input current</b>	
from supply voltage 1L+, max.	400 mA; Dependent on terminal module, typ. maximum value for FO connection method, full load on RWB and 20.4 V input voltage
<b>Power losses</b>	
Power loss, typ.	6 W; Dependent on terminal module, typ. maximum value for CU connection method, full load on RWB, for FO the value is approx. 0.7 W higher
<b>Memory</b>	
Micro Memory Card	No; Internal memory medium
<b>Address area</b>	
Addressing volume	
• Inputs	256 byte
• Outputs	256 byte
<b>Interfaces</b>	
Supports protocol for PROFINET IO	
• Automatic detection of transmission speed	Yes
• Transmission rate, max.	100 Mbit/s
• Services	ARP, PING, SNMP
<b>Protocols</b>	
Supports protocol for PROFINET IO	Yes

	<b>6ES7154-4AB10-0AB0</b> <b>IM 154-4 PN High Feature</b>
<b>Interrupts/diagnostics/status information</b>	
Diagnostics indication LED	
• Bus fault BF (red)	Yes; Additional LEDs (MAINT, P1/2 LINK, P1/2 RX/TX) available
• Group error SF (red)	Yes
• Monitoring 24 V voltage supply ON (green)	Yes
• Load voltage monitoring DC 24 V (green)	Yes
<b>Parameter</b>	
Diagnostic alarm	1
Hardware interrupt	1
Swapping interrupt	1
identifier-related diagnostic data	1
Module status	1
Channel-related diagnostics	1
Startup if setpoint not equal to actual configuration	1
Hot swapping of modules	1
<b>Galvanic isolation</b>	
between backplane bus and electronics	No
<b>Isolation</b>	
Isolation checked with	500 V DC
<b>Degree and class of protection</b>	
IP65	Yes
IP66	Yes
IP67	Yes
<b>Ambient conditions</b>	
Operating temperature	
• Min.	-25 °C
• max.	55 °C
Storage/transport temperature	
• Min.	-40 °C
• max.	70 °C
<b>Dimensions</b>	
Width	135 mm
Height	130 mm
Depth	59.3 mm
<b>Weights</b>	
Weight, approx.	490 g

# PROFINET/Industrial Ethernet

## SIMATIC ET 200pro

### Interface modules

#### IM 154-4 PN

#### Ordering data

##### IM 154-4 PN High Feature interface module

For communication between ET 200pro and higher-level controllers over PROFINET IO; support of PROFIsafe.

#### Accessories

##### CM IM PN connection module M12, 7/8"

For connecting PROFINET PN and 24 V power supply to PROFINET interface modules, 2 x M12 and 2 x 7/8".

##### CM IM PN connection module 2xRJ45

For connecting PROFINET PN and 24 V power supply to PROFINET interface modules, 2 x RJ45 and 2 x push-pull power connector.

##### CM IM PN 2xSCRJ FO connection module

For connecting PROFINET PN and 24 V power supply to PROFINET interface modules, 2 x SCRJ FO and 2 x push-pull power connector.

##### M12 sealing cap

For protection of unused M12 connections with ET 200pro.

##### IE M12 connecting cables

Preassembled with two M12 connectors, up to 85 m, in various lengths:

0.3 m

0.5 m

1.0 m

1.5 m

2.0 m

3.0 m

5.0 m

10 m

15 m

Other special lengths with 90° or 180° cable outlet.

##### 7/8" sealing caps

1 pack = 10 units

##### 7/8" connecting cable to power supply

5-core, 5 x 1.5 mm<sup>2</sup>, trailing type, preassembled with two 7/8" connectors, 5-pin, up to 50 m, in various lengths:

1.5 m

2.0 m

3.0 m

5.0 m

10 m

15 m

Other special lengths with 90° or 180° cable outlet.

#### Article No.

6ES7154-4AB10-0AB0

6ES7194-4AJ00-0AA0

6ES7194-4AF00-0AA0

6ES7194-4AG00-0AA0

3RX9802-0AA00

6XV1870-8AE30

6XV1870-8AE50

6XV1870-8AH10

6XV1870-8AH15

6XV1870-8AH20

6XV1870-8AH30

6XV1870-8AH50

6XV1870-8AN10

6XV1870-8AN15

See <http://support.automation.siemens.com/WW/view/en/26999294>

6ES7194-3JA00-0AA0

6XV1822-5BH15

6XV1822-5BH20

6XV1822-5BH30

6XV1822-5BH50

6XV1822-5BN10

6XV1822-5BN15

See <http://support.automation.siemens.com/WW/view/en/26999294>

#### Article No.

#### Accessories (continued)

##### Power cable

5-core, 5 x 1.5 mm<sup>2</sup>, trailing type, sold by the meter, minimum order quantity 20 m, maximum order quantity 1 000 m.

##### 7/8" cable connector

For ET 200eco, with axial cable outlet.

- With male insert, 5-pack
- With female insert, 5-pack

##### Industrial Ethernet FastConnect installation cables

- **IE FC TP Standard Cable GP 2 x 2;**

Sold by the meter, max. delivery unit 1 000 m; Minimum order quantity 20 m.

- **IE FC TP Trailing Cable 2 x 2;**

Sold by the meter, max. order quantity 1000 m; Minimum order quantity 20 m.

- **IE FC TP Trailing Cable GP 2 x 2;**

sold by the meter, max. delivery unit 1000 m; minimum order quantity 20 m.

- **IE TP Torsion Cable GP 2 x 2;**

sold by the meter, max. delivery unit 1000 m; minimum order quantity 20 m.

- **IE FC TP Marine Cable 2 x 2;**

Sold by the meter, max. order quantity 1000 m; Minimum order quantity 20 m.

##### IE RJ45 Plug PRO

RJ45 plug in IP65/67-rated design for on-site assembly, plastic housing, insulation/displacement connection system, for SCALANCE X-200IRT PRO and ET200pro: 1 pack = 1 unit.

##### IE SC RJ POF Plug PRO

SC RJ plug for POF fibers in IP65/67-rated design for on-site assembly, plastic housing, for SCALANCE X-200IRT PRO and ET 200pro 1 pack = 1 unit

##### IE SC RJ PCF Plug PRO

SC RJ plug connector for PCF fibers in IP65/67-rated design for on-site assembly, plastic housing, for SCALANCE X-200IRT PRO 1 pack = 1 unit.

##### Power Plug PRO

5-pole power plug for 2 x 24 V power supply in IP65/67-rated design, for on-site assembly, plastic housing, for SCALANCE X-200IRT and ET200 pro 1 pack = 1 unit.

##### IE panel feedthrough

Control cabinet feedthrough for converting M12 D-coded connection system (IP65) to RJ45 connection system (IP20).

- 1 pack = 5 units

##### Push-Pull cable connector

For 1L+/ 2L+, unassembled

##### Cover caps for Push-Pull RJ45 female connectors

5 items per pack

6XV1830-8AH10

6GK1905-0FA00

6GK1905-0FB00

6XV1840-2AH10

6XV1840-3AH10

6XV1870-2D

6XV1870-2F

6XV1840-4AH10

6GK1901-1BB10-6AA0

6GK1900-0MB00-6AA0

6GK1900-0NB00-6AA0

6GK1907-0AB10-6AA0

6GK1901-0DM20-2AA5

6GK1907-0AB10-6AA0

6ES7194-4JD50-0AA0

**Ordering data**
**Article No.**
**Article No.**
*General accessories*
**ET 200pro rack**

- Narrow, for interface, electronics and power modules
  - 500 mm
  - 1000 mm
  - 2000 mm, can be cut to length
- Compact, for interface, electronics and power modules
  - 500 mm
  - 1000 mm
  - 2000 mm, can be cut to length
- Wide, for interface, electronics, power modules and motor starters
  - 500 mm
  - 1000 mm
  - 2000 mm, can be cut to length
- Wide, for I/O modules and motor starters
  - 500 mm
  - 1000 mm
  - 2000 mm

**6ES7194-4GA00-0AA0**  
**6ES7194-4GA60-0AA0**  
**6ES7194-4GA20-0AA0**

**6ES7194-4GC70-0AA0**  
**6ES7194-4GC60-0AA0**  
**6ES7194-4GC20-0AA0**

**6ES7194-4GB00-0AA0**  
**6ES7194-4GB60-0AA0**  
**6ES7194-4GB20-0AA0**

**6ES7194-4GD00-0AA0**  
**6ES7194-4GD10-0AA0**  
**6ES7194-4GD20-0AA0**

*General accessories (continued)*
**Spare fuse**

12.5 A fast-blow, for interface and power modules, 10 units per pack.

**SIMATIC Manual Collection**

Electronic manuals on DVD, multi-language: S7-200, TD 200, S7-300, M7-300, C7, S7-400, M7-400, STEP 7, Engineering Tools, Runtime Software, SIMATIC DP (Distributed I/O), SIMATIC HMI (Human Machine Interface), SIMATIC NET (Industrial Communication).

**SIMATIC Manual Collection – Update service for 1 year**

Scope of delivery: Current DVD "S7 Manual Collection" and the three subsequent updates.

**6ES7194-4HB00-0AA0**

**6ES7998-8XC01-8YE0**

**6ES7998-8XC01-8YE2**

# PROFINET/Industrial Ethernet

## SIMATIC ET 200pro

### Interface modules

#### IM 154-8 PN/DP CPU

#### Overview



- CPU with PLC functionality equivalent to S7-315-2 PN/DP provides distributed intelligence for preprocessing
- Interface module for exchanging pre-processed I/O data between the ET 200pro and a higher-level master/IO Controller via PROFIBUS DP/PROFINET IO
- PROFINET IO Controller to operate distributed I/Os on PROFINET
- Component based Automation (CBA) on PROFINET
- PROFINET proxy for intelligent devices on PROFIBUS DP in Component Based Automation (CBA)
- PROFINET interface with 3-port switch
- Isochronous mode on PROFIBUS or PROFINET
- Integrated web server with the option of creating user-defined web pages
- CPU with PLC functionality equivalent to S7-315-2 PN/DP provides distributed intelligence for preprocessing
- Interface module to exchange preprocessed I/O data from ET 200pro with a higher-level master through PROFIBUS DP
- Fast, simple and end-to-end programming of a system with modular programs via STEP 7
- Fail-safe IM 154-8F PN/DP CPU PROFIsafe available

#### Note:

Micro Memory Card required for operation of CPU.

#### Technical specifications

6ES7154-8AB01-0AB0 IM 154-8 PN/DP CPU	
<b>General information</b>	
Engineering with	STEP7 V 5.5 or higher
• Programming package	
<b>Supply voltage</b>	
24 V DC	Yes
<b>Power losses</b>	
Power loss, typ.	8.5 W
<b>Memory</b>	
Work memory	
• integrated	384 kbyte
Load memory	
• pluggable (MMC), max.	8 Mbyte
<b>CPU processing times</b>	
for bit operations, typ.	0.05 μs
for word operations, typ.	0.09 μs
for fixed point arithmetic, typ.	0.12 μs
for floating point arithmetic, typ.	0.45 μs
<b>Counters, timers and their retentivity</b>	
S7 counter	
• Number	256
IEC counter	
• present	Yes
S7 times	
• Number	256
IEC timer	
• present	Yes
<b>Data areas and their retentivity</b>	
Flag	
• Number, max.	2 048 byte
<b>Address area</b>	
I/O address area	
• Inputs	2 048 byte
• Outputs	2 048 byte
Process image	
• Inputs, adjustable	2 048 byte
• Outputs, adjustable	2 048 byte
<b>Time of day</b>	
Clock	
• Hardware clock (real-time clock)	Yes
Operating hours counter	
• Number	1

**Technical specifications (continued)**

6ES7154-8AB01-0AB0 IM 154-8 PN/DP CPU		6ES7154-8AB01-0AB0 IM 154-8 PN/DP CPU	
<b>1st interface</b>		<b>Communication functions</b>	
Interface type	Integrated RS 485 interface	PG/OP communication	Yes
Physics	RS 485/connection: 2 x M12 b-coded	Global data communication • supported	Yes
Functionality		S7 basic communication • supported	Yes
• MPI	Yes	S7 communication • supported	Yes
• DP master	Yes	Open IE communication • TCP/IP	Yes; via integrated PROFINET interface and loadable FBs
• DP slave	Yes	- Number of connections, max.	8
• Point-to-point connection	No	• ISO-on-TCP (RFC1006) - Number of connections, max.	8
DP master		• UDP - Number of connections, max.	Yes 8
• Number of DP slaves, max.	124	Web server • supported	Yes
<b>2nd interface</b>		<b>Configuration</b>	
Interface type	PROFINET	programming	
Physics	Ethernet (2 x M12 d-coded; 1 x RJ45)	• Programming language	
Number of ports	3	- LAD	Yes
Functionality		- FBD	Yes
• MPI	No	- STL	Yes
• DP master	No	- SCL	Yes
• DP slave	No	- CFC	Yes
• PROFINET IO Controller	Yes; Also simultaneously with IO-Device functionality	- GRAPH	Yes
• PROFINET IO Device	Yes; Also simultaneously with IO Controller functionality	- HiGraph®	Yes
• PROFINET CBA	Yes	Know-how protection	
PROFINET IO Controller		• User program protection/password protection	Yes
• Max. number of connectable IO devices for RT	128	• Block encryption	Yes; With S7 block Privacy
• Number of IO devices with IRT and the option "high flexibility"	128	<b>Dimensions</b>	
• Number of IO Devices with IRT and the option "high performance", max.	64	Width	135 mm
<b>Isochronous mode</b>		Height	130 mm
Isochronous operation (application synchronized up to terminal)	Yes; Via PROFIBUS DP or PROFINET interface	Depth	65 mm; 60 mm without cover for RJ45 socket; 65 mm with cover for RJ45 socket
		<b>Weights</b>	
		Weight, approx.	720 g

# PROFINET/Industrial Ethernet

## SIMATIC ET 200pro

### Interface modules

#### IM 154-8 PN/DP CPU

#### Ordering data

#### Article No.

**IM 154-8 PN/DP CPU interface module, V3.2**

**6ES7154-8AB01-0AB0**

PROFINET IO Controller for operating distributed I/Os on PROFINET, with integrated PLC functionality.

#### Accessories

#### MMC for program backup

<b>MMC 64 Kbyte</b> <sup>1)</sup>	<b>6ES7953-8LF30-0AA0</b>
<b>MMC 128 Kbyte</b> <sup>1)</sup>	<b>6ES7953-8LG30-0AA0</b>
<b>MMC 512 Kbyte</b> <sup>1)</sup>	<b>6ES7953-8LJ30-0AA0</b>
<b>MMC 4 Mbyte</b> <sup>1)</sup>	<b>6ES7953-8LM31-0AA0</b>
<b>MMC 8 Mbyte</b> <sup>1)</sup>	<b>6ES7953-8LP31-0AA0</b>

#### MMC for program backup and/or firmware updates

<b>MMC 2 Mbyte</b> <sup>1)</sup>	<b>6ES7953-8LL31-0AA0</b>
----------------------------------	---------------------------

**Connection module** **6ES7194-4AN00-0AA0**

For CPU IM154-8 PN/DP, with 4 x M12 and 2 x 7/8", for connecting PROFINET and PROFIBUS DP.

#### SCALANCE X-200 Industrial Ethernet Switches

With integral SNMP access, Web diagnostics, copper cable diagnostics and PROFINET diagnostics, for setting up linear, star and ring structures SCALANCE X208PRO, in degree of protection IP65, with eight 10/100 Mbit/s M12 ports, incl. eleven M12 dust caps.

**6GK5208-0HA00-2AA6**

#### Industrial Ethernet FC RJ45 Plug 180

RJ45 plug connector for Industrial Ethernet with a rugged metal enclosure and integrated insulation displacement contacts for connecting Industrial Ethernet FC installation cables; with 180° cable outlet

- 1 unit
- 10 units
- 50 units

**6GK1901-1BB10-2AA0**  
**6GK1901-1BB10-2AB0**  
**6GK1901-1BB10-2AE0**

#### Industrial Ethernet Fast Connect installation cables

- FastConnect Standard Cable
- FastConnect Trailing Cable
- FastConnect Marine Cable

**6XV1840-2AH10**  
**6XV1840-3AH10**  
**6XV1840-4AH10**

#### Industrial Ethernet FastConnect installation cables

- **IE FC TP Trailing Cable GP 2 x 2;** sold by the meter, max. delivery unit 1 000 m; minimum order quantity 20 m.
- **IE TP Torsion Cable GP 2 x 2;** sold by the meter, max. delivery unit 1 000 m; minimum order quantity 20 m.

**6XV1870-2D**  
  
**6XV1870-2F**

#### Industrial Ethernet Fast Connect

Stripping Tool

**6GK1901-1GA00**

#### Article No.

#### Accessories (continued)

#### IE Connecting Cable M12-180/M12-180

- Preassembled IE FC TP Trailing Cable GP 2 x 2 (PROFINET Type C) with two 4-pin M12 plugs (4-pin, D-coded), degree of protection IP65/IP67, in various lengths:

- 0.3 m
- 0.5 m
- 1.0 m
- 1.5 m
- 2.0 m
- 3.0 m
- 5.0 m
- 10 m
- 15 m

**6XV1870-8AE30**  
**6XV1870-8AE50**  
**6XV1870-8AH10**  
**6XV1870-8AH15**  
**6XV1870-8AH20**  
**6XV1870-8AH30**  
**6XV1870-8AH50**  
**6XV1870-8AN10**  
**6XV1870-8AN15**

- PROFINET M12 connecting cable, trailing cable preassembled at both ends with angled M12 connectors (male insert), in various lengths:

- 3.0 m
- 5.0 m
- 10 m

**3RK1902-2NB30**  
**3RK1902-2NB50**  
**3RK1902-2NC10**

- PROFINET M12 connecting cable, trailing cable preassembled at one end with angled M12 connector (male insert at one end, other end open), in various lengths:

- 3.0 m
- 5.0 m
- 10 m

**3RK1902-2HB30**  
**3RK1902-2HB50**  
**3RK1902-2HC10**

#### IE FC M12 Plug PRO

PROFINET M12 plug connector, D-coded with fast connection system, axial cable outlet.

- 1 unit
- 8 units
- PROFINET M12 plug connector, D-coded, angled.

**6GK1901-0DB20-6AA0**  
**6GK1901-0DB20-6AA8**  
**3RK1902-2DA00**

#### IE panel feedthrough

Cabinet feedthrough for converting from the M12 connection system (D-coded, IP65/IP67) to the RJ45 connection system (IP20), 1 pack = 5 units.

**6GK1901-0DM20-2AA5**

<sup>1)</sup> An MMC is essential for operating the CPU

**Ordering data****Article No.****Article No.***Accessories (continued)***7/8" connecting cable to power supply**

5-core, 5 x 1.5 mm<sup>2</sup>, trailing type, preassembled with two 7/8" connectors (axial cable outlet), 5-pin, up to 50 m, in various lengths:

- 1.5 m
- 2.0 m
- 3.0 m
- 5.0 m
- 10 m
- 15 m
- Other special lengths with 90° or 180° cable outlet.

**6XV1822-5BH15**  
**6XV1822-5BH20**  
**6XV1822-5BH30**  
**6XV1822-5BH50**  
**6XV1822-5BN10**  
**6XV1822-5BN15**  
 See  
<http://support.automation.siemens.com/WW/view/en/26999294>

- Power cable, can be trailed, 5 x 1.5 mm<sup>2</sup>, preassembled at both ends with 7/8" angled connectors (female insert at one end, male insert at the other end), in various lengths:

- 3.0 m
- 5.0 m
- 10 m

**3RK1902-3NB30**  
**3RK1902-3NB50**  
**3RK1902-3NC10**

- Power cable, can be trailed, 5 x 1.5 mm<sup>2</sup>, preassembled at one end with 7/8" angled connector with female insert (female insert at one end, other end open), in various lengths:

- 3.0 m
- 5.0 m
- 10 m

**3RK1902-3GB30**  
**3RK1902-3GB50**  
**3RK1902-3GC10**

**Power line****6XV1830-8AH10**

5-core, 5 x 1.5 mm<sup>2</sup>, trailing type, sold by the meter, minimum order quantity 20 m, maximum order quantity 1 000 m.

**7/8" cable connector**

For ET 200eco, with axial cable outlet.

- with male insert, 5-pack
- with female insert, 5-pack
- angled, with female insert, 1 unit
- angled, with male insert, 1 unit

7/8" cover cap, 10 per pack

**6GK1905-0FA00**  
**6GK1905-0FB00**  
**3RK1902-3DA00**  
**3RK1902-3BA00**  
**6ES7194-3JA00-0AA0**

**Twisted Pair cables 4x2 with RJ45 connectors**

0.5 m  
 1 m  
 2 m  
 6 m  
 10 m

**6XV1870-3QE50**  
**6XV1870-3QH10**  
**6XV1870-3QH20**  
**6XV1870-3QH60**  
**6XV1870-3QN10**

**Crossed Twisted Pair cables 4x2 with RJ45 connectors**

0.5 m  
 1 m  
 2 m  
 6 m  
 10 m

**6XV1870-3RE50**  
**6XV1870-3RH10**  
**6XV1870-3RH20**  
**6XV1870-3RH60**  
**6XV1870-3RN10**

*Accessories (continued)***M12 sealing cap****3RX9802-0AA00**

For protection of unused M12 connections with ET 200pro

**M12 sealing caps with female thread****6ES7194-4JD60-0AA0**

5 units

**PROFIBUS M12 connecting cable**

Preassembled, with two 5-pole M12 connectors/sockets, up to 100 m, in various lengths:

1.5 m  
 2.0 m  
 3.0 m  
 5.0 m  
 10 m  
 15 m

**6XV1830-3DH15**  
**6XV1830-3DH20**  
**6XV1830-3DH30**  
**6XV1830-3DH50**  
**6XV1830-3DN10**  
**6XV1830-3DN15**

Other special lengths with 90° or 180° cable outlet

See  
<http://support.automation.siemens.com/WW/view/en/26999294>

**M12 bus termination connector for PROFIBUS, female insert****6GK1905-0ED00****M12 bus termination connector for PROFIBUS, male insert****6GK1905-0EC00****M12 plug connector, axial outlet, with male insert****6GK1905-0EA00****PROFIBUS FC Standard Cable GP****6XV1830-0EH10**

Standard type with special design for fast mounting, 2-core, shielded.

Sold by the meter;  
 max. delivery unit 1 000 m,  
 minimum order quantity 20 m.

**PROFIBUS FC Trailing Cable****6XV1830-3EH10**

2-wire, shielded.

**PROFIBUS FC Food Cable****6XV1830-0GH10**

2-wire, shielded.

Sold by the meter;  
 max. delivery unit 1 000 m,  
 minimum order quantity 20 m.

**PROFIBUS FC Robust Cable****6XV1830-0JH10**

2-core, shielded

Sold by the meter;  
 max. delivery unit 1 000 m,  
 minimum order quantity 20 m.

**PROFIBUS M12 cable connector**

5-pole, B-coded, metal casing, 1 pack = 5 units.

- Female insert

**6GK1905-0EB00**

<sup>1)</sup> An MMC is essential for operating the CPU

# PROFINET/Industrial Ethernet

## SIMATIC ET 200pro

### Interface modules

#### IM 154-8 F PN/DP CPU

#### Overview



- Interface module for SIMATIC ET 200pro with integrated fail-safe CPU
- CPU with PLC functionality equivalent to CPU S7-315F PN/DP; with distributed intelligence for preprocessing
- For constructing a fail-safe automation system for plants with increased safety requirements
- Complies with safety requirements up to SIL 3 according to IEC 61508, IEC 62061 and PLe according to ISO 13849.1:2006
- For high-performance control solutions in ET 200pro
- Increase of the availability of systems and machines
- Integral Web server with the option of creating user-defined Web sites
- Isochronous mode on PROFIBUS or PROFINET
- PROFINET IO Controller for up to 128 IO Devices
- PROFINET interface with integrated 3-port switch
- With many communication options:  
PG/OP communication, PROFINET IO, PROFINET CBA, open IE communication (TCP, ISO-on-TCP and UDP), web server and S7-communication (with loadable FBs)
- Fast, simple and end-to-end programming of a system with modular programs via STEP 7
- Compact SIMATIC Micro Memory Card (MMC)

#### Note:

SIMATIC Micro Memory Card required for operation of CPU.

#### Technical specifications

	<b>6ES7154-8FB01-0AB0</b> <b>IM 154-8 F PN/DP CPU</b> <b>Work memory 512 Kbyte</b>	<b>6ES7154-8FX00-0AB0</b> <b>IM 154-8 F PN/DP CPU</b> <b>Work memory 1.5 MByte</b>
<b>General information</b>		
Engineering with • Programming package	STEP 7 V 5.5 or higher, Distributed Safety V 5.4 SP4	As of STEP7 V5.5 with HSP 222 + Distributed Safety V5.4 SP4
<b>Supply voltage</b> 24 V DC	Yes	Yes
<b>Power losses</b> Power loss, typ.	8.5 W	8.5 W
<b>Memory</b>		
Work memory • integrated	512 kbyte	1 536 kbyte
Load memory • pluggable (MMC), max.	8 Mbyte	8 Mbyte
<b>CPU processing times</b>		
for bit operations, typ.	0.05 µs	0.025 µs
for word operations, typ.	0.09 µs	0.03 µs
for fixed point arithmetic, typ.	0.12 µs	0.04 µs
for floating point arithmetic, typ.	0.45 µs	0.16 µs
<b>Counters, timers and their retentivity</b>		
S7 counter • Number	256	256
IEC counter • present	Yes	Yes
S7 times • Number	256	256
IEC timer • present	Yes	Yes
<b>Data areas and their retentivity</b>		
Flag • Number, max.	2 048 byte	2 048 byte



**Technical specifications** (continued)

	<b>6ES7154-8FB01-0AB0</b> <b>IM 154-8 F PN/DP CPU</b> <b>Work memory 512 KByte</b>	<b>6ES7154-8FX00-0AB0</b> <b>IM 154-8 F PN/DP CPU</b> <b>Work memory 1.5 MByte</b>
<b>Address area</b>		
I/O address area		
• Inputs	2 048 byte	2 048 byte
• Outputs	2 048 byte	2 048 byte
<b>Process image</b>		
• Inputs, adjustable	2 048 byte	2 048 byte
• Outputs, adjustable	2 048 byte	2 048 byte
<b>Time of day</b>		
Clock		
• Hardware clock (real-time clock)	Yes	Yes
Operating hours counter		
• Number	1	1
<b>1st interface</b>		
Interface type	Integrated RS 485 interface	Integrated RS 485 interface
Physics	RS 485/connection: 2 x M12 b-coded	RS 485/connection: 2 x M12 b-coded
Functionality		
• MPI	Yes	Yes
• DP master	Yes	Yes
• DP slave	Yes	Yes
• Point-to-point connection	No	No
DP master		
• Number of DP slaves, max.	124	124
<b>2nd interface</b>		
Interface type	PROFINET	PROFINET
Physics	Ethernet (2 x M12 d-coded; 1 x RJ45)	Ethernet (2 x M12 d-coded; 1 x RJ45)
Number of ports	3	3
Functionality		
• MPI	No	No
• DP master	No	No
• DP slave	No	No
• PROFINET IO Controller	Yes; Also simultaneously with IO-Device functionality	Yes; Also simultaneously with IO-Device functionality
• PROFINET IO Device	Yes; Also simultaneously with IO Controller functionality	Yes; Also simultaneously with IO Controller functionality
• PROFINET CBA	Yes	Yes
PROFINET IO Controller		
• Max. number of connectable IO devices for RT	128	128
• Number of IO devices with IRT and the option "high flexibility"	128	128
• Number of IO Devices with IRT and the option "high performance", max.	64	64
<b>Isochronous mode</b>		
Isochronous operation (application synchronized up to terminal)	Yes; Via PROFIBUS DP or PROFINET interface	Yes; Via PROFIBUS DP or PROFINET interface
<b>Communication functions</b>		
PG/OP communication	Yes	Yes
Global data communication		
• supported	Yes	Yes
S7 basic communication		
• supported	Yes	Yes
S7 communication		
• supported	Yes	Yes
Open IE communication		
• TCP/IP	Yes; via integrated PROFINET interface and loadable FBs	Yes; via integrated PROFINET interface and loadable FBs
- Number of connections, max.	8	8
• ISO-on-TCP (RFC1006)	Yes	Yes
- Number of connections, max.	8	8
• UDP	Yes	Yes
- Number of connections, max.	8	8
Web server		
• supported	Yes	Yes

# PROFINET/Industrial Ethernet

## SIMATIC ET 200pro

### Interface modules

#### IM 154-8 F PN/DP CPU

#### Technical specifications (continued)

	<b>6ES7154-8FB01-0AB0</b> <b>IM 154-8 F PN/DP CPU</b> <b>Work memory 512 Kbyte</b>	<b>6ES7154-8FX00-0AB0</b> <b>IM 154-8 F PN/DP CPU</b> <b>Work memory 1.5 MByte</b>
<b>Configuration</b>		
programming		
• Programming language		
- LAD	Yes	Yes
- FBD	Yes	Yes
- STL	Yes	Yes
- SCL	Yes	Yes
- CFC	Yes	Yes
- GRAPH	Yes	Yes
- HiGraph®	Yes	Yes
Know-how protection		
• User program protection/password protection	Yes	Yes
• Block encryption	Yes; With S7 block Privacy	Yes; With S7 block Privacy
<b>Dimensions</b>		
Width	135 mm	135 mm
Height	130 mm	130 mm
Depth	65 mm; 60 mm without cover for RJ45 socket; 65 mm with cover for RJ45 socket	65 mm; 60 mm without cover for RJ45 socket; 65 mm with cover for RJ45 socket
<b>Weights</b>		
Weight, approx.	720 g	720 g

#### Ordering data

#### Article No.

#### Article No.

##### IM 154-8 F PN/DP CPU interface module, V3.2

Fail-safe PROFINET IO Controller for operating distributed I/Os on PROFINET, with integrated PLC functionality.

- 512 KB RAM
- 1.5 MB RAM

**6ES7154-8FB01-0AB0**  
**6ES7154-8FX00-0AB0**

##### Distributed Safety V5.4 programming tool

###### Task:

Engineering tool for configuring fail-safe user programs for SIMATIC S7-300F, S7-400F, WinAC RTX F, ET 200S, ET 200M, ET 200iSP, ET 200pro, ET 200eco

###### Requirement:

STEP 7 V5.3 SP3 and higher

Floating license

**6ES7833-1FC02-0YA5**

Floating license for 1 user, license key download without software and documentation<sup>2)</sup>, email address required for delivery.

**6ES7833-1FC02-0YH5**

##### Distributed Safety Upgrade

from V5.x to V5.4;

Floating license for 1 user

**6ES7833-1FC02-0YE5**

##### STEP 7 Safety Advanced V13

###### Task:

Engineering tool for configuring fail-safe user programs for SIMATIC S7-1500F, S7-300F, S7-400F, WinAC RTX F, ET 200SP, ET 200S, ET 200M, ET 200iSP, ET 200pro, ET 200eco

###### Requirement:

STEP 7 Professional V13

Floating license for 1 user

**6ES7833-1FA13-0YA5**

Floating license for 1 user, license key download without software or documentation<sup>1)</sup>, email address required for delivery

**6ES7833-1FA13-0YH5**

Ordering data	Article No.	Article No.
<i>Accessories</i>		
<i>MMC for program backup</i>		
<b>MMC 64 Kbyte</b> <sup>1)</sup>	6ES7953-8LF30-0AA0	
<b>MMC 128 Kbyte</b> <sup>1)</sup>	6ES7953-8LG30-0AA0	
<b>MMC 512 Kbyte</b> <sup>1)</sup>	6ES7953-8LJ30-0AA0	
<b>MMC 4 Mbyte</b> <sup>1)</sup>	6ES7953-8LM31-0AA0	
<b>MMC 8 Mbyte</b> <sup>1)</sup>	6ES7953-8LP31-0AA0	
<i>MMC for program backup and/or firmware updates</i>		
<b>MMC 2 Mbyte</b> <sup>1)</sup>	6ES7953-8LL31-0AA0	
<b>Connection module</b>	6ES7194-4AN00-0AA0	
for CPU IM154-8 PN/DP, with 4 x M12 and 2 x 7/8", for connecting PROFINET and PROFIBUS DP.		
<b>SCALANCE X-200 Industrial Ethernet Switches</b>	6GK5208-0HA00-2AA6	
with integral SNMP access, Web diagnostics, copper cable diagnostics and PROFINET diagnostics, for setting up linear, star and ring structures SCALANCE X208PRO, in degree of protection IP65, with eight 10/100 Mbit/s M12 ports, incl. eleven M12 dust caps.		
<b>Industrial Ethernet FC RJ45 Plug 90</b>		
RJ45 plug-in connector for Industrial Ethernet with a rugged metal housing and integrated insulation displacement contacts for connecting Industrial Ethernet FC installation cables; with 90° cable outlet.		
<ul style="list-style-type: none"> <li>• 1 unit</li> <li>• 10 units</li> </ul>	6GK1901-1BB20-2AA0 6GK1901-1BB20-2AB0	
<b>Industrial Ethernet FC RJ45 Plug 180</b>		
RJ45 plug connector for Industrial Ethernet with a rugged metal enclosure and integrated insulation displacement contacts for connecting Industrial Ethernet FC installation cables; with 180° cable outlet		
<ul style="list-style-type: none"> <li>• 1 unit</li> <li>• 10 units</li> <li>• 50 units</li> </ul>	6GK1901-1BB10-2AA0 6GK1901-1BB10-2AB0 6GK1901-1BB10-2AE0	
<b>Industrial Ethernet FastConnect installation cables</b>		
<ul style="list-style-type: none"> <li>• FastConnect Standard Cable</li> <li>• FastConnect Trailing Cable</li> <li>• FastConnect Marine Cable</li> </ul>	6XV1840-2AH10 6XV1840-3AH10 6XV1840-4AH10	
<b>Industrial Ethernet FastConnect installation cables</b>		
<ul style="list-style-type: none"> <li>• <b>IE FC TP Trailing Cable GP 2 x 2</b> Sold by the meter, max. delivery unit 1 000 m Minimum order quantity 20 m.</li> <li>• <b>IE TP Torsion Cable GP 2 x 2</b> Sold by the meter, max. delivery unit 1 000 m Minimum order quantity 20 m.</li> </ul>	6XV1870-2D  6XV1870-2F	
<b>Industrial Ethernet FastConnect</b>		
Stripping Tool	6GK1901-1GA00	
<i>Accessories (continued)</i>		
<b>IE Connecting Cable M12-180/ M12-180</b>		
<ul style="list-style-type: none"> <li>• Preassembled IE FC TP Trailing Cable GP 2 x 2 (PROFINET Type C) with two 4-pin M12 plugs (4-pin, D-coded), degree of protection IP65/IP67, in various lengths:</li> <li>• 0.3 m</li> <li>• 0.5 m</li> <li>• 1.0 m</li> <li>• 1.5 m</li> <li>• 2.0 m</li> <li>• 3.0 m</li> <li>• 5.0 m</li> <li>• 10 m</li> <li>• 15 m</li> <li>• PROFINET M12 connecting cable, trailing cable preassembled at both ends with angled M12 con- nectors (male contact insert), in various lengths:</li> <li>• 3.0 m</li> <li>• 5.0 m</li> <li>• 10 m</li> <li>• PROFINET M12 connecting cable, trailing cable preassembled at one end with angled M12 connec- tor (male contact insert at one end, other end open), in various lengths:</li> <li>• 3.0 m</li> <li>• 5.0 m</li> <li>• 10 m</li> </ul>		6XV1870-8AE30 6XV1870-8AE50 6XV1870-8AH10 6XV1870-8AH15 6XV1870-8AH20 6XV1870-8AH30 6XV1870-8AH50 6XV1870-8AN10 6XV1870-8AN15
		3RK1902-2NB30 3RK1902-2NB50 3RK1902-2NC10
		3RK1902-2HB30 3RK1902-2HB50 3RK1902-2HC10
<b>IE FC M12 Plug PRO</b>		
PROFINET M12 plug connector, D-coded with fast connection system, axial cable outlet		
<ul style="list-style-type: none"> <li>• 1 unit</li> <li>• 8 units</li> <li>• PROFINET M12 plug connector, D-coded, angled</li> </ul>		6GK1901-0DB20-6AA0 6GK1901-0DB20-6AA8 3RK1902-2DA00
<b>IE panel feedthrough</b>		
Cabinet feedthrough for converting from the M12 connection system (D-coded, IP65/IP67) to the RJ45 connection system (IP20), 1 pack = 5 units		
		6GK1901-0DM20-2AA5

# PROFINET/Industrial Ethernet

## SIMATIC ET 200pro

### Interface modules

#### IM 154-8 F PN/DP CPU

#### Ordering data

#### Article No.

#### Article No.

##### Accessories (continued)

##### 7/8" connecting cable to power supply

- 5-core, 5 x 1.5 mm<sup>2</sup>, trailing type, preassembled with two 7/8" connectors (axial cable outlet), 5-pin, up to 50 m, in various lengths:
  - 1.5 m
  - 2.0 m
  - 3.0 m
  - 5.0 m
  - 10 m
  - 15 m
- Other special lengths with 90° or 180° cable outlet
- Power cable, can be trailed, 5 x 1.5 mm<sup>2</sup>, preassembled at both ends with 7/8" angled connectors (female contact insert at one end, male contact insert at the other end), in various lengths:
  - 3.0 m
  - 5.0 m
  - 10 m
- Power cable, can be trailed, 5 x 1.5 mm<sup>2</sup>, preassembled at one end with 7/8" angled connector with female contact insert (female contact insert at one end, other end open), in various lengths:
  - 3.0 m
  - 5.0 m
  - 10 m

6XV1822-5BH15  
6XV1822-5BH20  
6XV1822-5BH30  
6XV1822-5BH50  
6XV1822-5BN10  
6XV1822-5BN15  
See  
<http://support.automation.siemens.com/WWW/view/en/26999294>

3RK1902-3NB30  
3RK1902-3NB50  
3RK1902-3NC10

3RK1902-3GB30  
3RK1902-3GB50  
3RK1902-3GC10

##### Power line

5-core, 5 x 1.5 mm<sup>2</sup>, trailing type, sold by the meter, minimum order quantity 20 m, maximum order quantity 1 000 m

6XV1830-8AH10

##### 7/8" cable connector

- For ET 200eco, with axial cable outlet
- with male contact insert, 5-pack
  - with female contact insert, 5-pack
  - Angled, with female contact insert, 1 unit
  - Angled, with male contact insert, 1 unit

6GK1905-0FA00  
6GK1905-0FB00  
3RK1902-3DA00

3RK1902-3BA00

7/8" cover cap, 10 per pack

6ES7194-3JA00-0AA0

##### Twisted Pair cables 4x2 with RJ45 connectors

- 0.5 m
- 1 m
- 2 m
- 6 m
- 10 m

6XV1870-3QE50  
6XV1870-3QH10  
6XV1870-3QH20  
6XV1870-3QH60  
6XV1870-3QN10

##### Crossed Twisted Pair cables 4x2 with RJ45 connectors

- 0.5 m
- 1 m
- 2 m
- 6 m
- 10 m

6XV1870-3RE50  
6XV1870-3RH10  
6XV1870-3RH20  
6XV1870-3RH60  
6XV1870-3RN10

##### Accessories (continued)

##### M12 sealing cap

for protection of unused M12 connections with ET 200pro

3RX9802-0AA00

##### M12 sealing caps with female thread

5 units

6ES7194-4JD60-0AA0

##### PROFIBUS M12 connecting cable

Preassembled, with two 5-pole M12 connectors/sockets, up to 100 m, in various lengths:

- 1.5 m
- 2.0 m
- 3.0 m
- 5.0 m
- 10 m
- 15 m

6XV1830-3DH15  
6XV1830-3DH20  
6XV1830-3DH30  
6XV1830-3DH50  
6XV1830-3DN10  
6XV1830-3DN15

Additional special lengths with 90° or 180° cable outlet

See  
<http://support.automation.siemens.com/WWW/view/en/26999294>

##### M12 bus termination connector for PROFIBUS, female contact insert

6GK1905-0ED00

##### M12 bus termination connector for PROFIBUS, male contact insert

6GK1905-0EC00

##### M12 plug connector, axial outlet, with male contact insert

6GK1905-0EA00

##### PROFIBUS FC Standard Cable GP

Standard type with special design for fast mounting, 2-core, shielded

Sold by the meter  
Max. delivery unit 1 000 m  
Minimum order quantity 20 m

6XV1830-0EH10

##### PROFIBUS FC Trailing Cable

2-wire, shielded

6XV1830-3EH10

##### PROFIBUS FC Food Cable

2-wire, shielded  
Sold by the meter  
Max. delivery unit 1 000 m  
Minimum order quantity 20 m

6XV1830-0GH10

##### PROFIBUS FC Robust Cable

2-wire, shielded  
Sold by the meter  
Max. delivery unit 1 000 m  
Minimum order quantity 20 m

6XV1830-0JH10

##### PROFIBUS M12 cable connector

5-pole, B-coded, metal casing  
1 pack = 5 units  
• Female contact insert

6GK1905-0EB00

<sup>1)</sup> An MMC is essential for operating the CPU

<sup>2)</sup> For up-to-date information and download availability, see:  
<http://www.siemens.com/tia-online-software-delivery>

## Overview



- Compact block I/O for processing digital, analog and IO-Link signals for connecting to the PROFINET bus system
- Cabinet-free design with degree of protection IP65/66/67 with M12 connections
- Very rugged and resistant metal enclosure and encapsulated
- Compact module in two types of enclosures:
  - 30 mm x 200 mm x 37 mm (W x H x D, long and narrow enclosure), with 4 x M12 for digital signals
  - 60 mm x 175 mm x 37 mm (W x H x D, short and wide enclosure), with 8 x M12 for digital signals and IO-Link
  - 60 mm x 175 mm x 37 mm (W x H x D, short and wide enclosure) with 4 x M12 or 8 x M12 for analog signals
- PROFINET connection: 2 x M12 and automatic PROFINET address assignment
- Data transmission rate 100 Mbit/s
- LLDP proximity detection without PG and Fast Startup (boot up within approx 0.5 seconds)
- Supply and load voltage connection: 2 x M12
- Module variance:
  - 8 DI
  - 16 DI
  - 8 DO (2 A)
  - 8 DO (1.3 A)
  - 8 DO (0.5 A)
  - 16 DO (1.3 A)
  - 8 DI/DO (1.3 A),
  - 8 AI (U, I, TC, RTD)
  - 8 AI (TC, RTD)
  - 4 AO (U, I)
  - 4 IO-Link + 8 DI + 4 DO (1.3 A)
- Channel-specific diagnostics
- Ambient temperature range -40 °C to 60 °C

## Technical specifications

	<b>6ES7141-6BF00-0AB0</b> <b>8 DE 24 V DC; 4 x M12</b>	<b>6ES7141-6BG00-0AB0</b> <b>8 DE 24 V DC; 8 x M12</b>	<b>6ES7141-6BH00-0AB0</b> <b>8 DE DC 24 V DC; 8 x M12</b>
<b>Digital input modules</b>			
<b>General information</b>			
Vendor identification (VendorID)	002AH	002AH	002AH
Device identifier (DeviceID)	0306H	0306H	0306H
<b>Supply voltage</b>			
24 V DC	Yes	Yes	Yes
permissible range, lower limit (DC)	20.4 V	20.4 V	20.4 V
permissible range, upper limit (DC)	28.8 V	28.8 V	28.8 V
Reverse polarity protection	Yes	Yes	Yes
<b>Input current</b>			
Current consumption, typ.	100 mA	100 mA	100 mA
<b>Encoder supply</b>			
Number of outputs	4	8	8
Output current			
• Output current, rated value	100 mA; per output	100 mA; per output	100 mA; per output
24 V encoder supply			
• short-circuit protection	Yes	Yes	Yes
<b>Power losses</b>			
Power loss, typ.	5.5 W	4.5 W	6.5 W

# PROFINET/Industrial Ethernet

## SIMATIC ET 200eco

### ET 200eco PN

#### Technical specifications (continued)

Digital input modules	6ES7141-6BF00-0AB0 8 DE 24 V DC; 4 x M12	6ES7141-6BG00-0AB0 8 DE 24 V DC; 8 x M12	6ES7141-6BH00-0AB0 8 DE DC 24 V DC; 8 x M12
<b>Digital inputs</b>			
Number of digital inputs	8	8	16
• In groups of	2	1	2
Input characteristic curve in accordance with IEC 61131, type 3	Yes	Yes	Yes
Number of simultaneously controllable inputs			
• all mounting positions			
- up to 60 °C, max.	8	8	16
Input voltage			
• Type of input voltage	DC	DC	DC
• Rated value, DC	24 V	24 V	24 V
• for signal "0"	-3 to +5 V	-3 to +5 V	-3 to +5 V
• for signal "1"	11 to 30 V	11 to 30 V	11 to 30 V
Input current			
• for signal "0", max. (permissible quiescent current)	1.5 mA	1.5 mA	1.5 mA
• for signal "1", typ.	7 mA	7 mA	7 mA
Input delay (for rated value of input voltage)			
• for standard inputs			
- at "0" to "1", max.	typically 3 ms	typically 3 ms	typically 3 ms
- at "1" to "0", max.	typically 3 ms	typically 3 ms	typically 3 ms
Cable length			
• Cable length unshielded, max.	30 m	30 m	30 m
<b>Interfaces</b>			
Transmission procedure	100BASE-TX	100BASE-TX	100BASE-TX
Transmission rate, max.	100 Mbit/s	100 Mbit/s	100 Mbit/s
Supports protocol for PROFINET IO			
• Number of PROFINET interfaces	1	1	1
• Autocrossing	Yes	Yes	Yes
• Automatic detection of transmission speed	Yes	Yes	Yes
• Integrated switch	Yes	Yes	Yes
• PROFINET IO Device			
- IRT with the option "high flexibility" supported	Yes	Yes	Yes
- Prioritized startup	Yes	Yes	Yes
<b>Protocols</b>			
Supports protocol for PROFINET IO	Yes	Yes	Yes
PROFINET CBA	No	No	No
Supports protocol for PROFIsafe	No	No	No
Protocols (Ethernet)			
• SNMP	Yes	Yes	Yes
• DCP	Yes	Yes	Yes
• LLDP	Yes	Yes	Yes
• ping	Yes	Yes	Yes
• ARP	Yes	Yes	Yes
<b>Interrupts/diagnostics/status information</b>			
Status indicator	Yes; Green LED	Yes; Green LED	Yes; Green LED
Alarms			
• Diagnostic alarm	Yes	Yes	Yes
Diagnostic messages			
• Diagnostic functions	Yes	Yes	Yes
• Diagnostic information readable	Yes	Yes	Yes
• Monitoring the supply voltage	Yes; Green "ON" LED	Yes; Green "ON" LED	Yes; Green "ON" LED
• Wire break in signal transmitter cable	Yes	Yes	Yes
• Short circuit encoder supply	Yes; Per channel group	Yes; Per channel group	Yes; Per channel group
• Group error	Yes; Red/yellow "SF/MT" LED	Yes; Red/yellow "SF/MT" LED	Yes; Red/yellow "SF/MT" LED

## Technical specifications (continued)

Digital input modules	6ES7141-6BF00-0AB0 8 DE 24 V DC; 4 x M12	6ES7141-6BG00-0AB0 8 DE 24 V DC; 8 x M12	6ES7141-6BH00-0AB0 8 DE DC 24 V DC; 8 x M12
<b>Galvanic isolation</b>			
between the load voltages	Yes	Yes	Yes
between load voltage and all other switching components	No	No	No
between Ethernet and electronics	Yes	Yes	Yes
Galvanic isolation digital inputs			
• between the channels	No	No	No
<b>Permissible potential difference</b>			
between different circuits	75 V DC / 60 VAC	75 V DC / 60 VAC	75 V DC / 60 VAC
<b>Isolation</b>			
tested with			
• 24 V DC circuits	500 V	500 V	500 V
• Interface	1 500 V; According to IEEE 802.3	1 500 V; According to IEEE 802.3	1 500 V; According to IEEE 802.3
<b>Degree and class of protection</b>			
IP65	Yes	Yes	Yes
IP66	Yes	Yes	Yes
IP67	Yes	Yes	Yes
<b>Connection method</b>			
M12	Yes	Yes	Yes
<b>Dimensions</b>			
Width	30 mm	60 mm	60 mm
Height	200 mm	175 mm	175 mm
Depth	49 mm	49 mm	49 mm
<b>Weights</b>			
Weight (without packaging)	550 g	910 g	910 g

Digital output modules	6ES7142-6BF50-0AB0 8 DA 24 V DC/0.5 A, 4 x M12	6ES7142-6BF00-0AB0 8 DA 24 V DC/1.3 A, 4 x M12	6ES7142-6BG00-0AB0 8 DA 24 V DC/1.3 A, 8 x M12	6ES7142-6BR00-0AB0 8 DA 24 V DC/2 A, 8 x M12	6ES7142-6BH00-0AB0 16 DA 24 V DC/1.3 A, 8 x M12
<b>General information</b>					
Vendor identification (VendorID)	002AH	002AH	002AH	002AH	002AH
Device identifier (DeviceID)	0306H	0306H	0306H	0306H	0306H
<b>Supply voltage</b>					
Load voltage 1L+					
• Rated value (DC)	24 V	24 V	24 V	24 V	24 V
• permissible range, lower limit (DC)	20.4 V	20.4 V	20.4 V	20.4 V	20.4 V
• permissible range, upper limit (DC)	28.8 V	28.8 V	28.8 V	28.8 V	28.8 V
• Reverse polarity protection	Yes	Yes	Yes	Yes	Yes
Load voltage 2L+					
• Rated value (DC)	24 V	24 V	24 V	24 V	24 V
• permissible range, lower limit (DC)	20.4 V	20.4 V	20.4 V	20.4 V	20.4 V
• permissible range, upper limit (DC)	28.8 V	28.8 V	28.8 V	28.8 V	28.8 V
• Reverse polarity protection	Yes	Yes	Yes	Yes	Yes
<b>Input current</b>					
from load voltage 1L+ (unswitched voltage)	100 mA	4 A	4 A	4 A	4 A
from load voltage 2L+, max.	4 A	4 A	4 A	4 A	4 A
<b>Power losses</b>					
Power loss, typ.	3 W	5.5 W	5.5 W	5 W	5.5 W

# PROFINET/Industrial Ethernet

## SIMATIC ET 200eco

### ET 200eco PN

#### Technical specifications (continued)

Digital output modules	6ES7142-6BF50-0AB0 8 DA 24 V DC/0.5 A, 4 x M12	6ES7142-6BF00-0AB0 8 DA 24 V DC/1.3 A, 4 x M12	6ES7142-6BG00-0AB0 8 DA 24 V DC/1.3 A, 8 x M12	6ES7142-6BR00-0AB0 8 DA 24 V DC/2 A, 8 x M12	6ES7142-6BH00-0AB0 16 DA 24 V DC/1.3 A, 8 x M12
<b>Digital outputs</b>					
Number of digital outputs	8	8	8	8	16
• In groups of	8	4	4	4	8
Short-circuit protection	Yes	Yes	Yes	Yes	Yes
• Response threshold, typ.	0,7 A	1,8 A	1,8 A	2,8 A	1,8 A
Limitation of inductive shutdown voltage to	Typ. (L1+, L2+) -47 V	Typ. (L1+, L2+) -47 V	Typ. (L1+, L2+) -47 V	Typ. (L1+, L2+) -47 V	Typ. (L1+, L2+) -47 V
Controlling a digital input	Yes	Yes	Yes	Yes	Yes
Switching capacity of the outputs					
• on lamp load, max.	5 W	5 W	5 W	10 W	5 W
Output current					
• for signal "1" rated value	0.5 A	1.3 A; Maximum	1.3 A; Maximum	2 A	1.3 A; Maximum
• for signal "0" residual current, max.	1.5 mA	1.5 mA	1.5 mA	1.5 mA	1.5 mA
Parallel switching of 2 outputs					
• for increased power	No	No	No	No	No
• for redundant control of a load	Yes	Yes	Yes	Yes	Yes
Switching frequency					
• with resistive load, max.	100 Hz	100 Hz	100 Hz	100 Hz	100 Hz
• with inductive load, max.	0.5 Hz	0.5 Hz	0.5 Hz	0.5 Hz	0.5 Hz
• on lamp load, max.	1 Hz	1 Hz	1 Hz	1 Hz	1 Hz
Aggregate current of outputs (per group)					
• all mounting positions					
- up to 55 °C, max.		3.9 A			
- up to 60 °C, max.	4 A	2.6 A	3.9 A	3.9 A	3.9 A
Cable length					
• Cable length unshielded, max.	30 m	30 m	30 m	30 m	30 m
<b>Interfaces</b>					
Transmission procedure	100BASE-TX	100BASE-TX	100BASE-TX	100BASE-TX	100BASE-TX
Transmission rate, max.	100 Mbit/s	100 Mbit/s	100 Mbit/s	100 Mbit/s	100 Mbit/s
Supports protocol for PROFINET IO					
• Number of PROFINET interfaces	1	1	1	1	1
• Autocrossing	Yes	Yes	Yes	Yes	Yes
• Automatic detection of transmission speed	Yes	Yes	Yes	Yes	Yes
• Integrated switch	Yes	Yes	Yes	Yes	Yes
• PROFINET IO Device					
- IRT with the option "high flexibility" supported	Yes	Yes	Yes	Yes	Yes
- Prioritized startup	Yes	Yes	Yes	Yes	Yes
<b>Protocols</b>					
Supports protocol for PROFINET IO	Yes	Yes	Yes	Yes	Yes
PROFINET CBA	No	No	No	No	No
Supports protocol for PROFI-safe	No	No	No	No	No
Protocols (Ethernet)					
• SNMP	Yes	Yes	Yes	Yes	Yes
• DCP	Yes	Yes	Yes	Yes	Yes
• LLDP	Yes	Yes	Yes	Yes	Yes
• ping	Yes	Yes	Yes	Yes	Yes
• ARP	Yes	Yes	Yes	Yes	Yes
<b>Interrupts/diagnostics/status information</b>					
Status indicator	Yes; Green LED	Yes; Green LED	Yes; Green LED	Yes; Green LED	Yes; Green LED
Alarms					
• Diagnostic alarm	Yes	Yes	Yes	Yes	Yes
Diagnostic messages					
• Diagnostic functions	Yes	Yes	Yes	Yes	Yes
• Diagnostic information readable	Yes	Yes	Yes	Yes	Yes
• Monitoring the supply voltage	Yes; Green "ON" LED	Yes; Green "ON" LED	Yes; Green "ON" LED	Yes; Green "ON" LED	Yes; Green "ON" LED
• Wire break in actuator cable	Yes	Yes	Yes	Yes	Yes
• Short circuit	Yes	Yes	Yes	Yes	Yes
• Group error	Yes; Red/yellow "SF/MT" LED	Yes; Red/yellow "SF/MT" LED	Yes; Red/yellow "SF/MT" LED	Yes; Red/yellow "SF/MT" LED	Yes; Red/yellow "SF/MT" LED



**Technical specifications (continued)**

Digital output modules	6ES7142-6BF50-0AB0 8 DA 24 V DC/0.5 A, 4 x M12	6ES7142-6BF00-0AB0 8 DA 24 V DC/1.3 A, 4 x M12	6ES7142-6BG00-0AB0 8 DA 24 V DC/1.3 A, 8 x M12	6ES7142-6BR00-0AB0 8 DA 24 V DC/2 A, 8 x M12	6ES7142-6BH00-0AB0 16 DA 24 V DC/1.3 A, 8 x M12
<b>Galvanic isolation</b>					
between the load voltages	Yes	Yes	Yes	Yes	Yes
between load voltage and all other switching components	No	No	No	No	No
between Ethernet and electronics	Yes	Yes	Yes	Yes	Yes
Galvanic isolation digital outputs					
• between the channels	No	No	No	No	No
<b>Permissible potential difference</b>					
between different circuits	75 V DC / 60 V AC	75 V DC / 60 V AC	75 V DC / 60 V AC	75 V DC / 60 V AC	75 V DC / 60 V AC
<b>Isolation</b>					
tested with					
• 24 V DC circuits	500 V	500 V	500 V	500 V	500 V
• Interface	1 500 V; According to IEEE 802.3	1 500 V; According to IEEE 802.3	1 500 V; According to IEEE 802.3	1 500 V; According to IEEE 802.3	1 500 V; According to IEEE 802.3
<b>Degree and class of protection</b>					
IP65	Yes	Yes	Yes	Yes	Yes
IP66	Yes	Yes	Yes	Yes	Yes
IP67	Yes	Yes	Yes	Yes	Yes
<b>Connection method</b>					
M12	Yes	Yes	Yes	Yes	Yes
<b>Dimensions</b>					
Width	30 mm	30 mm	60 mm	60 mm	60 mm
Height	200 mm	200 mm	175 mm	175 mm	175 mm
Depth	49 mm	49 mm	49 mm	49 mm	49 mm
<b>Weights</b>					
Weight (without packaging)	550 g	550 g	910 g	910 g	910 g

Digital input/output modules	6ES7147-6BG00-0AB0 8 DE/DA 24 V DC/1.3 A; 8 x M12
<b>General information</b>	
Vendor identification (VendorID)	002AH
Device identifier (DeviceID)	0306H
<b>Supply voltage</b>	
24 V DC	Yes
permissible range, lower limit (DC)	20.4 V
permissible range, upper limit (DC)	28.8 V
Reverse polarity protection	Yes
Load voltage 2L+	
• Rated value (DC)	24 V
• permissible range, lower limit (DC)	20.4 V
• permissible range, upper limit (DC)	28.8 V
• Reverse polarity protection	Yes
<b>Input current</b>	
from load voltage 1L+ (unswitched voltage)	4 A
from load voltage 2L+, max.	4 A
<b>Encoder supply</b>	
Number of outputs	8
Output current	
• Output current, rated value	100 mA; per output
24 V encoder supply	
• short-circuit protection	Yes
<b>Power losses</b>	
Power loss, typ.	6.5 W

Digital input/output modules	6ES7147-6BG00-0AB0 8 DE/DA 24 V DC/1.3 A; 8 x M12
<b>Digital inputs</b>	
Number of digital inputs	8
• In groups of	4
Input characteristic curve in accordance with IEC 61131, type 3	Yes
Number of simultaneously controllable inputs	
• all mounting positions	8
- up to 60 °C, max.	
Input voltage	
• Type of input voltage	DC
• Rated value, DC	24 V
• for signal "0"	-3 to +5 V
• for signal "1"	11 to 30 V
Input current	
• for signal "0", max. (permissible quiescent current)	1.5 mA
• for signal "1", typ.	7 mA
Input delay (for rated value of input voltage)	
• for standard inputs	
- at "0" to "1", max.	typically 3 ms
- at "1" to "0", max.	typically 3 ms
Cable length	
• Cable length unshielded, max.	30 m

# PROFINET/Industrial Ethernet

## SIMATIC ET 200eco

### ET 200eco PN

#### Technical specifications (continued)

Digital input/output modules	6ES7147-6BG00-0AB0 8 DE/DA 24 V DC/1.3 A; 8 x M12
<b>Digital outputs</b>	
Number of digital outputs	8
• In groups of	4
Short-circuit protection	Yes; Electronic
• Response threshold, typ.	1.8 A
Limitation of inductive shutdown voltage to	Typ. (L1+, L2+) -47 V
Controlling a digital input	Yes
Switching capacity of the outputs	
• on lamp load, max.	5 W
Output current	
• for signal "1" rated value	1.3 A; Maximum
• for signal "0" residual current, max.	1.5 mA
Parallel switching of 2 outputs	
• for increased power	No
• for redundant control of a load	Yes
Switching frequency	
• with resistive load, max.	100 Hz
• with inductive load, max.	0.5 Hz
• on lamp load, max.	1 Hz
Aggregate current of outputs (per group)	
• all mounting positions	
- up to 60 °C, max.	3.9 A
Cable length	
• Cable length unshielded, max.	30 m
<b>Interfaces</b>	
Transmission procedure	100BASE-TX
Transmission rate, max.	100 Mbit/s
Supports protocol for PROFINET IO	
• Number of PROFINET interfaces	1
• Autocrossing	Yes
• Automatic detection of transmission speed	Yes
• Integrated switch	Yes
• PROFINET IO Device	
- IRT with the option "high flexibility" supported	Yes
- Prioritized startup	Yes
<b>Protocols</b>	
Supports protocol for PROFINET IO	Yes
PROFINET CBA	No
Supports protocol for PROFI-safe	No
PROFIBUS	No
Protocols (Ethernet)	
• TCP/IP	No
• SNMP	Yes
• DCP	Yes
• LLDP	Yes
• ping	Yes
• ARP	Yes

Digital input/output modules	6ES7147-6BG00-0AB0 8 DE/DA 24 V DC/1.3 A; 8 x M12
<b>Interrupts/diagnostics/status information</b>	
Status indicator	Yes; Green LED
<b>Alarms</b>	
• Diagnostic alarm	Yes
<b>Diagnostic messages</b>	
• Diagnostic functions	Yes
• Diagnostic information readable	Yes
• Monitoring the supply voltage	Yes; Green "ON" LED
• Wire break in actuator cable	Yes
• Wire break in signal transmitter cable	Yes
• Short circuit	Yes
• Short circuit encoder supply	Yes
• Group error	Yes; Red/yellow "SF/MT" LED
<b>Galvanic isolation</b>	
between the load voltages	Yes
between load voltage and all other switching components	No
between Ethernet and electronics	Yes
<b>Galvanic isolation digital inputs</b>	
• between the channels	No
<b>Galvanic isolation digital outputs</b>	
• between the channels	No
<b>Permissible potential difference</b>	
between different circuits	75 V DC / 60 V AC
<b>Isolation</b>	
tested with	
• 24 V DC circuits	500 V
• Interface	1 500 V; According to IEEE 802.3
<b>Degree and class of protection</b>	
IP65	Yes
IP66	Yes
IP67	Yes
<b>Connection method</b>	
M12	Yes
<b>Dimensions</b>	
Width	60 mm
Height	175 mm
Depth	49 mm
<b>Weights</b>	
Weight (without packaging)	910 g

## Technical specifications (continued)

Analog input modules	6ES7144-6KD00-0AB0 8 AE 4 U/I + 4 RTD/TC; 8 x M12	6ES7144-6KD50-0AB0 8 AE RTD/TC; 8 x M12
<b>General information</b>		
Vendor identification (VendorID)	002AH	002AH
Device identifier (DeviceID)	0306H	0306H
<b>Supply voltage</b>		
24 V DC	Yes	Yes
permissible range, lower limit (DC)	20.4 V	20.4 V
permissible range, upper limit (DC)	28.8 V	28.8 V
Reverse polarity protection	Yes	Yes; against destruction
<b>Input current</b>		
Current consumption, typ.	110 mA	110 mA
<b>Encoder supply</b>		
Number of outputs	4	
24 V encoder supply		
• short-circuit protection	Yes; Electronic at 1.4 A	
• Output current, max.	1 A	
<b>Power losses</b>		
Power loss, typ.	2.8 W	2.8 W
<b>Analog inputs</b>		
Number of analog inputs	8	8
Number of analog inputs for voltage/current measurement	4	
Number of analog inputs for resistance/resistance thermometer measurement	4	8
permissible input voltage for voltage input (destruction limit), max.	28.8 V permanent, 35 V for max. 500 ms	
Input ranges (rated values), voltages		
• 0 to +10 V	Yes	
• 1 to 5 V	Yes	
• -10 V to +10 V	Yes	
• -80 mV to +80 mV	Yes	Yes
Input ranges (rated values), currents		
• 0 to 20 mA	Yes	
• -20 to +20 mA	Yes	
• 4 to 20 mA	Yes	
Input ranges (rated values), thermoelements		
• Type E	Yes	Yes
• Type J	Yes	Yes
• Type K	Yes	Yes
• Type N	Yes	Yes
Input ranges (rated values), resistance thermometers		
• Ni 100	Yes	Yes
• Ni 1000	Yes	Yes
• Ni 120	Yes	Yes
• Ni 200	Yes	Yes
• Ni 500	Yes	Yes
• Pt 100	Yes	Yes
• Pt 1000	Yes	Yes
• Pt 200	Yes	Yes
• Pt 500	Yes	Yes
Input ranges (rated values), resistors		
• 0 to 150 ohms	Yes	Yes
• 0 to 300 ohms	Yes	Yes
• 0 to 600 ohms	Yes	Yes
• 0 to 3000 ohms	Yes	Yes

# PROFINET/Industrial Ethernet

## SIMATIC ET 200eco

### ET 200eco PN

#### Technical specifications (continued)

	<b>6ES7144-6KD00-0AB0</b> <b>8 AE 4 U/I + 4 RTD/TC; 8 x M12</b>	<b>6ES7144-6KD50-0AB0</b> <b>8 AE RTD/TC; 8 x M12</b>
<b>Analog input modules</b>		
Thermocouple (TC)		
• Temperature compensation		
- Parameterizable	Yes	Yes
- internal temperature compensation	Yes	Yes
- external temperature compensation with compensations socket	Yes	Yes
- external temperature compensation with Pt100		Yes
- dynamic reference temperature value		Yes
- for definable comparison point temperature		Yes
Cable length		
• Cable length, shielded, max.	30 m	30 m
<b>Analog value creation</b>		
Analog value display	SIMATIC S7 format	SIMATIC S7 format
Measurement principle	integrating	integrating
Integrations and conversion time/resolution per channel		
• Resolution (incl. overrange)	15 bits + sign	15 bits + sign
• Integration time, parameterizable	Yes	Yes
• Integration time, ms	2/16.67/20/100 ms	2/16.67/20/100 ms
• Interference voltage suppression for interference frequency f1 in Hz	500 / 60 / 50 / 10 Hz	500 / 60 / 50 / 10 Hz
• Conversion time (per channel)	4 / 19 / 22 / 102 ms	4 / 19 / 22 / 102 ms
Smoothing of measured values		
• Parameterizable	Yes	Yes
• Step: None	Yes; 1 x cycle time	Yes; 1 x cycle time
• Step: low	Yes; 4 x cycle time	Yes; 4 x cycle time
• Step: Medium	Yes; 16 x cycle time	Yes; 16 x cycle time
• Step: High	Yes; 64 x cycle time	Yes; 64 x cycle time
<b>Encoder</b>		
Number of connectable encoders, max.	8	8
Connection of signal encoders		
• for voltage measurement	Yes	
• for current measurement as 2-wire transducer	Yes	
• for current measurement as 4-wire transducer	Yes	
• for resistance measurement with two-wire connection	Yes	Yes
• for resistance measurement with three-wire connection	Yes	Yes
• for resistance measurement with four-wire connection	Yes	Yes
<b>Errors/accuracies</b>		
Linearity error (relative to input range), (+/-)	0.01 %	0.01 %
Temperature error (relative to input range), (+/-)	U: 0.0035%/°C; I: 0.006%/°C; RTD: 0.0005%/°C; TC: 0.0035%/°C	RTD: 0.0005%/°C; TC: 0.0035%/°C
Crosstalk between the inputs, min.	85 dB	-85 dB
Repeat accuracy in steady state at 25 °C (relative to input area), (+/-)	0.008 %	0.008 %
Interference voltage suppression for f = n x (f1 +/- 1 %), f1 = interference frequency		
• Series mode interference (peak value of interference < rated value of input range), min.	46 dB	46 dB
• Common mode interference, min.	70 dB	70 dB

**Technical specifications (continued)**

<b>Analog input modules</b>	<b>6ES7144-6KD00-0AB0 8 AE 4 U/I + 4 RTD/TC; 8 x M12</b>	<b>6ES7144-6KD50-0AB0 8 AE RTD/TC; 8 x M12</b>
<b>Interfaces</b>		
Transmission procedure	100BASE-TX	100BASE-TX
Transmission rate, max.	100 Mbit/s	100 Mbit/s
Supports protocol for PROFINET IO		
• Number of PROFINET interfaces	1	1
• Autocrossing	Yes	Yes
• Automatic detection of transmission speed	Yes	Yes
• Integrated switch	Yes	Yes
• PROFINET IO Device		
- IRT with the option "high flexibility" supported	Yes	
- Prioritized startup	Yes	Yes
<b>Protocols</b>		
Supports protocol for PROFINET IO	Yes	Yes
PROFINET CBA	No	No
Supports protocol for PROFI-safe	No	No
Protocols (Ethernet)		
• SNMP	Yes	Yes
• DCP	Yes	Yes
• LLDP	Yes	Yes
• ping	Yes	Yes
• ARP	Yes	Yes
<b>Interrupts/diagnostics/ status information</b>		
Status indicator	Yes	
<b>Alarms</b>		
• Diagnostic alarm	Yes	Yes
<b>Diagnostic messages</b>		
• Diagnostic functions	Yes	Yes
• Diagnostic information readable	Yes	Yes
• Monitoring the supply voltage	Yes; Green "ON" LED	Yes; Green "ON" LED
• Short circuit encoder supply	Yes; per module	
• Group error	Yes; Red/yellow "SF/MT" LED	Yes; Red/yellow "SF/MT" LED
• Overflow/underflow	Yes	Yes
<b>Galvanic isolation</b>		
between the load voltages	Yes	Yes
between load voltage and all other switching components	No	No
between Ethernet and electronics	Yes	Yes
<b>Galvanic isolation analog inputs</b>		
• between the channels	No	No
<b>Permissible potential difference</b>		
between inputs and MANA (UCM)	10 Vpp AC	10 Vpp AC
<b>Isolation</b>		
tested with		
• 24 V DC circuits	500 V	500 V
• Interface	1 500 V; According to IEEE 802.3	1 500 V; According to IEEE 802.3
<b>Degree and class of protection</b>		
IP65	Yes	Yes
IP66	Yes	Yes
IP67	Yes	Yes
<b>Connection method</b>		
M12	Yes	Yes
<b>Dimensions</b>		
Width	60 mm	60 mm
Height	175 mm	175 mm
Depth	49 mm	49 mm
<b>Weights</b>		
Weight (without packaging)	930 g	930 g

# PROFINET/Industrial Ethernet

## SIMATIC ET 200eco

### ET 200eco PN

#### Technical specifications (continued)

Analog output modules	6ES7145-6HD00-0AB0 4 AA U/I; 4 x M12
<b>General information</b>	
Vendor identification (VendorID)	002AH
Device identifier (DeviceID)	0306H
<b>Supply voltage</b>	
24 V DC	Yes
permissible range, lower limit (DC)	20.4 V
permissible range, upper limit (DC)	28.8 V
Reverse polarity protection	Yes
<b>Input current</b>	
Current consumption, typ.	280 mA
<b>Encoder supply</b>	
Number of outputs	4
24 V encoder supply	
• short-circuit protection	Yes; Electronic at 1.4 A
• Output current, max.	1 A
<b>Power losses</b>	
Power loss, typ.	5.5 W
<b>Analog outputs</b>	
Number of analog outputs	4
Voltage output, short-circuit protection	Yes
Voltage output, short-circuit current, max.	30 mA
Current output, no-load voltage, max.	20 V
Output ranges, voltage	
• 0 to 10 V	Yes
• 1 to 5 V	Yes
• -10 to +10 V	Yes
Output ranges, current	
• 0 to 20 mA	Yes
• -20 to +20 mA	Yes
• 4 to 20 mA	Yes
Connection of actuators	
• for voltage output two-wire connection	Yes
• for current output two-wire connection	Yes
Load impedance (in rated range of output)	
• with voltage outputs, min.	1 k $\Omega$
• with voltage outputs, capacitive load, max.	1 $\mu$ F
• with current outputs, max.	600 $\Omega$
• with current outputs, inductive load, max.	1 mH
Destruction limits against externally applied voltages and currents	
• Voltages at the outputs towards MANA	28.8 V permanent, 35 V for max. 500 ms
Cable length	
• Cable length, shielded, max.	30 m

Analog output modules	6ES7145-6HD00-0AB0 4 AA U/I; 4 x M12
<b>Analog value creation</b>	
Analog value display	SIMATIC S7 format
Measurement principle	Resistor network
Integrations and conversion time/resolution per channel	
• Resolution (incl. overrange)	15 bits + sign
• Conversion time (per channel)	1 ms
Settling time	
• for resistive load	2 ms
• for capacitive load	1.8 ms
• for inductive load	2 ms
<b>Errors/accuracies</b>	
Output ripple (based on output area, bandwidth 0 to 50 kHz), (+/-)	U: $\pm 0.6$ mVrms; I: $\pm 0.4$ nArms
Linearity error (relative to output range), (+/-)	0.02 %
Temperature error (relative to output range), (+/-)	U: 0.001%/°C; I: 0.0025%/°C
Crosstalk between the outputs, min.	70 dB
Repeat accuracy in steady state at 25 °C (relative to output area), (+/-)	0.008 %
<b>Interfaces</b>	
Transmission procedure	100BASE-TX
Transmission rate, max.	100 Mbit/s
Supports protocol for PROFINET IO	
• Number of PROFINET interfaces	1
• Autocrossing	Yes
• Automatic detection of transmission speed	Yes
• Integrated switch	Yes
• PROFINET IO Device	
- IRT with the option "high flexibility" supported	Yes
- Prioritized startup	Yes
<b>Protocols</b>	
Supports protocol for PROFINET IO	Yes
PROFINET CBA	No
Supports protocol for PROFIsafe	No
Protocols (Ethernet)	
• SNMP	Yes
• DCP	Yes
• LLDP	Yes
• ping	Yes
• ARP	Yes

## Technical specifications (continued)

Analog output modules	6ES7145-6HD00-0AB0 4 AA U/I; 4 x M12
<b>Interrupts/diagnostics/ status information</b>	
Status indicator	Yes
Substitute values connectable	Yes
<b>Alarms</b>	
• Diagnostic alarm	Yes
<b>Diagnostic messages</b>	
• Diagnostic functions	Yes
• Diagnostic information readable	Yes
• Monitoring the supply voltage	Yes; Green "ON" LED
• Wire break	Yes; Channel-by-channel with current output
• Short circuit	Yes; Channel-by-channel with voltage output
• Group error	Yes; Red/yellow "SF/MT" LED
<b>Galvanic isolation</b>	
between the load voltages	Yes
between load voltage and all other switching components	No
between Ethernet and electronics	Yes
<b>Galvanic isolation analog outputs</b>	
• between the channels	No
<b>Permissible potential difference</b>	
between M internally and the outputs	10 V <sub>pp</sub> AC
<b>Degree and class of protection</b>	
IP65	Yes
IP66	Yes
IP67	Yes
<b>Connection method</b>	
M12	Yes
<b>Dimensions</b>	
Width	60 mm
Height	175 mm
Depth	49 mm
<b>Weights</b>	
Weight (without packaging)	930 g

IO-Link master module	6ES7148-6JA00-0AB0 4 IO-L + 8 DE + 4 DA 24 V DC/1.3 A; 8 X M12
<b>General information</b>	
Vendor identification (VendorID)	002AH
Device identifier (DeviceID)	0306H
<b>Supply voltage</b>	
24 V DC	Yes
permissible range, lower limit (DC)	20.4 V
permissible range, upper limit (DC)	28.8 V
Reverse polarity protection	Yes
<b>Load voltage 2L+</b>	
• Rated value (DC)	24 V
• permissible range, lower limit (DC)	20.4 V
• permissible range, upper limit (DC)	28.8 V
• Reverse polarity protection	Yes

IO-Link master module	6ES7148-6JA00-0AB0 4 IO-L + 8 DE + 4 DA 24 V DC/1.3 A; 8 X M12
<b>Input current</b>	
from load voltage 1L+ (unswitched voltage)	4 A
from load voltage 2L+, max.	4 A
<b>Encoder supply</b>	
Number of outputs	6
<b>Output current</b>	
• Output current, rated value	200 mA; 100 mA per output to X5-X6
<b>24 V encoder supply</b>	
• short-circuit protection	Yes
<b>Power losses</b>	
Power loss, typ.	8 W
<b>Digital inputs</b>	
Number of digital inputs	8
Input characteristic curve in accordance with IEC 61131, type 3	Yes
<b>Number of simultaneously controllable inputs</b>	
• all mounting positions - up to 60 °C, max.	8
<b>Input voltage</b>	
• Rated value, DC	24 V
• for signal "0"	-3 to +5 V
• for signal "1"	11 to 30 V
<b>Input current</b>	
• for signal "0", max. (permissible quiescent current)	1.5 mA
• for signal "1", typ.	7 mA
<b>Input delay (for rated value of input voltage)</b>	
• for standard inputs - at "0" to "1", max. - at "1" to "0", max.	typically 3 ms typically 3 ms
<b>Cable length</b>	
• Cable length unshielded, max.	30 m
<b>Digital outputs</b>	
Number of digital outputs	4
<b>Short-circuit protection</b>	
• Response threshold, typ.	Yes; Electronic 1.8 A
<b>Limitation of inductive shutdown voltage to</b>	
Controlling a digital input	Typ. (L1+, L2+) -47 V
<b>Switching capacity of the outputs</b>	
• on lamp load, max.	5 W
<b>Output current</b>	
• for signal "1" rated value	1.3 A; Maximum
• for signal "0" residual current, max.	1.5 mA
<b>Parallel switching of 2 outputs</b>	
• for increased power	No
• for redundant control of a load	Yes
<b>Switching frequency</b>	
• with resistive load, max.	100 Hz
• with inductive load, max.	0.5 Hz
• on lamp load, max.	1 Hz
<b>Aggregate current of outputs (per group)</b>	
• all mounting positions - up to 60 °C, max.	3.9 A
<b>Cable length</b>	
• Cable length unshielded, max.	30 m

# PROFINET/Industrial Ethernet

## SIMATIC ET 200eco

### ET 200eco PN

#### Technical specifications (continued)

IO-Link master module	6ES7148-6JA00-0AB0 4 IO-L + 8 DE + 4 DA 24 V DC/1.3 A; 8 X M12
<b>Interfaces</b>	
Transmission procedure	100BASE-TX
Transmission rate, max.	100 Mbit/s
Supports protocol for PROFINET IO	
• Number of PROFINET interfaces	1
• Autocrossing	Yes
• Automatic detection of transmission speed	Yes
• Integrated switch	Yes
• PROFINET IO Device	
- IRT with the option "high flexibility" supported	Yes
- Prioritized startup	Yes
<b>Protocols</b>	
Supports protocol for PROFINET IO	Yes
PROFINET CBA	No
Supports protocol for PROFI-safe	No
Protocols (Ethernet)	
• SNMP	Yes
• DCP	Yes
• LLDP	Yes
• ping	Yes
• ARP	Yes
<b>IO-Link</b>	
Number of ports	4
• of which simultaneously controllable	4
Transmission rate	4.8 kBd (COM1); 38.4 kBd (COM2)
Cable length unshielded, max.	20 m
Operating modes	
• IO-Link	Yes
• DI	Yes
• DQ	Yes
Connection of IO-Link devices	
• via three-wire connection	Yes
<b>Interrupts/diagnostics/status information</b>	
Status indicator	Yes; Green LED
Alarms	
• Diagnostic alarm	Yes
Diagnostic messages	
• Diagnostic functions	Yes
• Diagnostic information readable	Yes
• Monitoring the supply voltage	Yes; Green "ON" LED
• Wire break in actuator cable	Yes
• Wire break in signal transmitter cable	Yes
• Short circuit	Yes
• Short circuit encoder supply	Yes
• Group error	Yes; Red/yellow "SF/MT" LED

IO-Link master module	6ES7148-6JA00-0AB0 4 IO-L + 8 DE + 4 DA 24 V DC/1.3 A; 8 X M12
<b>Galvanic isolation</b>	
between the load voltages	Yes
between load voltage and all other switching components	No
between Ethernet and electronics	Yes
Galvanic isolation digital inputs	
• between the channels	No
Galvanic isolation digital outputs	
• between the channels	No
<b>Permissible potential difference</b>	
between different circuits	75 V DC / 60 V AC
<b>Isolation</b>	
tested with	
• 24 V DC circuits	500 V
• Interface	1 500 V; According to IEEE 802.3
<b>Degree and class of protection</b>	
IP65	Yes
IP66	Yes
IP67	Yes
<b>Connection method</b>	
M12	Yes
<b>Dimensions</b>	
Width	60 mm
Height	175 mm
Depth	49 mm
<b>Weights</b>	
Weight (without packaging)	910 g

2



Ordering data	Article No.	Article No.
<b>ET 200eco PN digital input module</b> <ul style="list-style-type: none"> <li>• 8 DI 24 V DC; 4 x M12, dual assignment, degree of protection IP67</li> <li>• 8 DI 24 V DC; 8 x M12, degree of protection IP67</li> <li>• 16 DI 24 V DC; 8 x M12, dual assignment, degree of protection IP67</li> </ul>	<b>6ES7141-6BF00-0AB0</b>  <b>6ES7141-6BG00-0AB0</b>  <b>6ES7141-6BH00-0AB0</b>	<b>6ES7148-6CB00-0AA0</b>  <b>6ES7194-6CA00-0AA0</b>  <b>6ES7194-6HB00-0AA0</b>  <b>6ES7194-6GA00-0AA0</b> <b>6ES7194-6MA00-0AA0</b>  <b>3RX9802-0AA00</b>  <b>3RT1900-1SB10</b>
<b>ET 200eco PN digital output module</b> <ul style="list-style-type: none"> <li>• 8 DO 24 V DC/0.5 A; 4 x M12, dual assignment, 1 load voltage supply DO; degree of protection IP67</li> <li>• 8 DO 24 V DC/1.3 A; 4 x M12, dual assignment, degree of protection IP67</li> <li>• 8 DO 24 V DC/1.3 A; 8 x M12, degree of protection IP67</li> <li>• 8 DO 24 V DC/2 A; 8 x M12, degree of protection IP67</li> <li>• 16 DO 24 V DC/1.3 A; 8 x M12, dual assignment, degree of protection IP67</li> </ul>	<b>6ES7142-6BF50-0AB0</b>  <b>6ES7142-6BF00-0AB0</b>  <b>6ES7142-6BG00-0AB0</b>  <b>6ES7142-6BR00-0AB0</b>  <b>6ES7142-6BH00-0AB0</b>	<b>Accessories</b> <ul style="list-style-type: none"> <li>• PD voltage distributor, 24 V DC; 1 X 7/8", 4 X M12</li> <li>• Terminal block for ET 200eco PN, 10 A insulation-piercing terminals</li> <li>• Spare fuses for terminal block, 10 units</li> <li>• Mounting rail 0.5 m</li> <li>• Profile screw for mounting rail, 50 units</li> <li>• Sealing cap M12 for IP67 modules, 10 units</li> <li>• Labels 10 x 7 mm, pastel turquoise, 816 units</li> </ul>
<b>ET 200eco PN digital input/output modules</b> <ul style="list-style-type: none"> <li>• 8 DI/DO 24 V DC/1.3 A; 8 x M12, degree of protection IP67</li> </ul>	<b>6ES7147-6BG00-0AB0</b>	<b>PROFINET M12 connector, for user assembly</b> IE FC M12 connector PRO, for user assembly <ul style="list-style-type: none"> <li>• 1 unit</li> <li>• 8 units</li> </ul>
<b>ET 200eco PN analog input modules</b> <ul style="list-style-type: none"> <li>• 8 AI 4 U/I + 4 RTD/TC; 8 x M12, degree of protection IP67</li> <li>• 8 AI RTD/TC; 8 x M12, degree of protection IP67</li> </ul>	<b>6ES7144-6KD00-0AB0</b>  <b>6ES7144-6KD50-0AB0</b>	<b>PROFINET M12 connecting cables</b> Preassembled connecting cables with 2 M12 connectors (D-coded) in various lengths: <ul style="list-style-type: none"> <li>• 0.3 m</li> <li>• 0.5 m</li> <li>• 1.0 m</li> <li>• 1.5 m</li> <li>• 2.0 m</li> <li>• 3.0 m</li> <li>• 5.0 m</li> <li>• 10.0 m</li> <li>• 15.0 m</li> </ul>
<b>ET 200eco PN analog output modules</b> <ul style="list-style-type: none"> <li>• 4 AO U/I; 4 x M12, degree of protection IP67</li> </ul>	<b>6ES7145-6HD00-0AB0</b>	<b>M12 connector for 24 V DC load power supply</b> Connection socket for 24 V DC incoming supply; 4-pin, A-coded, 3 units  Connector for loop-through of 24 V DC; 4-pin, A-coded, 3 units
<b>ET 200eco PN IO-Link master module</b> <ul style="list-style-type: none"> <li>• 4 IO-L + 8 DI + 4 DO 24 V DC/1.3 A; 8 x M12, degree of protection IP67</li> </ul>	<b>6ES7148-6JA00-0AB0</b>	<b>M12 plug-in power cables</b> Preassembled plug-in power cables, fitted at each end with M12 socket and plug 4 x 0.75 mm <sup>2</sup> , in various lengths: <ul style="list-style-type: none"> <li>• 0.3 m</li> <li>• 0.5 m</li> <li>• 1.0 m</li> <li>• 1.5 m</li> <li>• 2.0 m</li> <li>• 3.0 m</li> <li>• 5.0 m</li> <li>• 10.0 m</li> <li>• 15.0 m</li> </ul>
		<b>M12 coupler plug</b> Can be assembled, for connecting actuators or sensors, 5-pin
		<b>Y cable M12</b> For double connection of I/O by means of single cable to ET 200, 5-pin
		<b>6GK1907-0DC10-6AA3</b>  <b>6GK1907-0DB10-6AA3</b>  <b>6XV1870-8AE30</b> <b>6XV1870-8AE50</b> <b>6XV1870-8AH10</b> <b>6XV1870-8AH15</b> <b>6XV1870-8AH20</b> <b>6XV1870-8AH30</b> <b>6XV1870-8AH50</b> <b>6XV1870-8AN10</b> <b>6XV1870-8AN15</b>  <b>6XV1801-5DE30</b> <b>6XV1801-5DE50</b> <b>6XV1801-5DH10</b> <b>6XV1801-5DH15</b> <b>6XV1801-5DH20</b> <b>6XV1801-5DH30</b> <b>6XV1801-5DH50</b> <b>6XV1801-5DN10</b> <b>6XV1801-5DN15</b>

## PROFINET/Industrial Ethernet Motion Control System SIMOTION

### The SIMOTION system

#### Overview

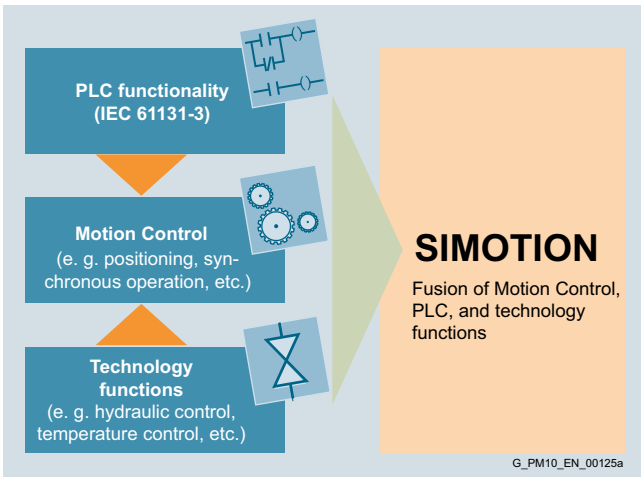

SIMOTION is recommended for all machines with Motion Control tasks – from simple to high-performance. The focus is on a simple and flexible solution for the greatest possible range of Motion Control tasks.

SIMOTION is based on the fusion of Motion Control with two other control functions which are found in most machines: PLC and technology functions.

This approach means that Motion Control of axes and control of the complete machine can be implemented within the same system. The same applies to technology functions, such as pressure control of a hydraulic axis. A seamless switch can be made from position-controlled positioning mode to pressure control.

**Combining the three open-loop control functions of Motion Control, PLC and technology functions has the following benefits:**

- Reduced engineering overhead and increased machine performance
- Fast system response – Time-critical interfaces between the individual components are no longer required
- Simple, uniform and transparent programming as well as diagnostics of the entire machine

The SIMOTION system is made up of three components:

#### **Engineering system**

SCOUT enables Motion Control, PLC and technology functions to be incorporated in one comprehensive, integrated system and provides all the necessary tools: From programming and parameterization through testing and commissioning, to diagnostics.

#### **Runtime software**

The runtime software offers a high-performance execution system for cyclic and sequential tasks. The runtime software modules make the different PLC, Motion Control and technology functions available. By selecting the appropriate modules, the overall functionality of the system can be flexibly adapted to the machine.

#### **Hardware platforms**

The hardware platforms are the basis of the SIMOTION Motion Control System. The application created with the engineering system and the associated runtime software modules can be implemented on different hardware platforms.

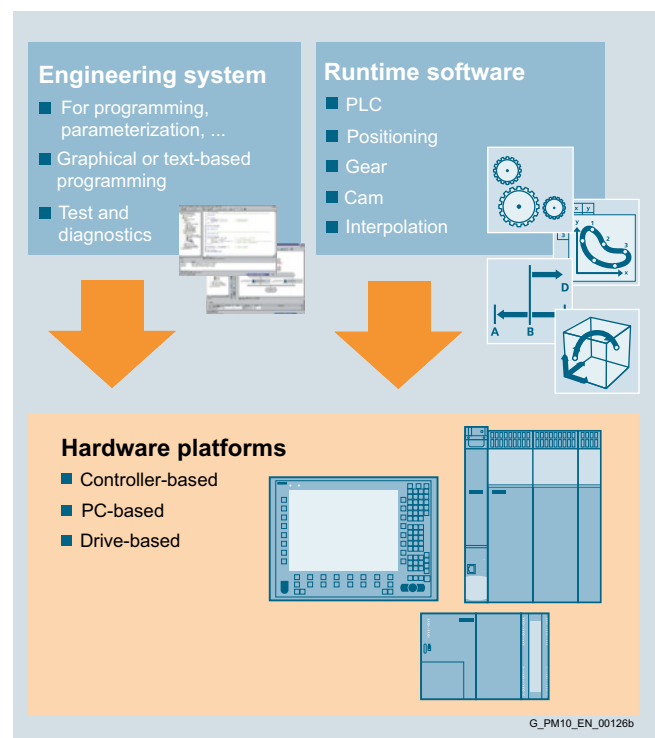

#### **The fast path to the automation solution**

Thanks to our wide range of sector-specific solutions it is possible to reduce engineering costs, speed up project completion times and implement successful automation systems more quickly.

The SIMOTION easyProject project generator enables you to significantly accelerate the creation of a standardized project framework for machine applications.

## Overview

### One concept – 3 platforms

Automation systems are primarily identified by the following characteristics:

- System-specific characteristics, e.g. functionality and engineering
- Hardware-dependent characteristics, e.g. performance, design and expandability

However, mechanical engineering demands vary greatly, depending on the version of the machine in question.

Every hardware platform has its benefits when used in certain applications.

The various platforms can also be combined very easily, which is a particular advantage in modular machines and plants. This is because the individual hardware platforms always have the same system characteristics, i.e. functionality and engineering are always identical, irrespective of the platform used.

PROFIBUS or PROFINET can be used to create the link to the drives and the I/Os remotely.

PROFINET/PROFIBUS can also be used for communication with HMI devices such as SIMATIC HMI or higher-level controllers such as SIMATIC S7. This means that SIMATIC HMI panels as well as PCs with WinCC flexible can be used as operator systems. Even 3rd party applications communicate with SIMOTION by means of the OPC interface.

### SIMOTION D – Compact and integrated in the drive



In SIMOTION D, the SIMOTION functionality is integrated directly in the closed-loop control module of the SINAMICS S120 drive system. Therefore, the complete system (consisting of the open-loop control and the drive) is extremely compact and powerful.

Two SIMOTION D versions are available:

- As a SIMOTION D410-2 single-axis system with multi-axis option (blocksize format)
- As a SIMOTION D4x5-2 multi-axis system in four performance variants for up to 128 axes (booksize format)

This finely graded performance ensures the highest degree of scalability and flexibility. The field of application ranges from single axes to high-performance multi-axis machines. For visualization and operation SIMATIC HMI devices can be connected via PROFINET, Ethernet or PROFIBUS depending on the SIMOTION D variant. Distributed I/O is connected via PROFINET or PROFIBUS.

### SIMOTION C – Modularity and flexibility



SIMOTION C is a Motion Controller based on the SIMATIC S7-300 design.

It is available in two variants which differ in terms of their interfaces, but not with respect to Motion Control functionality or performance. In addition to the already integrated interfaces, both controllers can be expanded using I/O modules from the SIMATIC S7-300 range.

Variant C240 with its four drive and encoder interfaces is ideal for machine automation applications and the operation of drives with analog setpoint interface or stepper drives. As a result, this variant is particularly suitable for machine retrofits.

Variant C240 PN with its three PROFINET ports, which support PROFINET with IRT as well as TCP/IP and RT communication, is used to automate machines on the basis of PROFINET. It is capable of operating PROFINET drives with PROFIdrive, as well as PROFINET I/Os, such as SIMATIC ET 200S High Speed.

Both variants are equipped additionally with two PROFIBUS interfaces via which drives with PROFIdrive profile as well as standard I/Os can be connected. In addition, both controllers feature an Industrial Ethernet interface, thus offering further communication options.

## PROFINET/Industrial Ethernet Motion Control System SIMOTION

### SIMOTION Hardware platforms

#### Overview (continued)

#### **SIMOTION P – Open for multiple tasks**



SIMOTION P is a PC-based Motion Control System. The capabilities of the portfolio of PC-based controllers with SIMOTION P320-3, the embedded PC for Motion Control, and SIMOTION P350-3 with the operating system Windows XP Professional are well-demonstrated in practice – and not just for high-end tasks.

SIMOTION P320-3 has been created for Embedded PC Motion Control applications. Thanks to the Embedded Windows operating system and elimination of rotating parts in the PC, the SIMOTION P320-3 is particularly compact and ideal for applications in harsh environments. Both PCs are equipped with the usual real-time expansion for SIMOTION. This means that in addition to SIMOTION machine applications, it is possible to run other PC applications at any time including, for example, the SIMOTION engineering system, an operator application, a process data evaluation routine or standard PC applications.

With its excellent processor performance, SIMOTION P350-3 is predestined for applications with exacting performance requirements (such as hydraulic applications with highly dynamic position and pressure control loops). SIMOTION P320-3 is particularly suitable for harsh operating environments. Its small footprint makes it the preferred choice for many applications in which available space and rugged design play a key role.

The SIMOTION P350-3 can be operated by a variety of different SIMOTION panel fronts. These are available in various screen sizes and can either be operated using a keyboard and mouse, or a touch screen. The SIMOTION P320-3 can be linked to the SIMOTION fronts by means of the Remote Panel PC Kit. For both PC variants, the SIMATIC flat panel series offers further scope for solutions in which the PC is not directly connected to the front panel.

SIMOTION P350-3 is available in either a PROFINET or PROFIBUS variant for the connection of I/Os, while SIMOTION P320-3 is available only as a PROFINET variant.

#### Overview

#### Motion Control architectures with SIMOTION and SINAMICS

With SIMOTION and SINAMICS, a range of different automation structures can be implemented over PROFINET. In this case, central architectures comprising a controller (e.g. SIMOTION P) are supported as well as decentralized, distributed architectures with several distributed controllers (e.g. SIMOTION D with SINAMICS S120).

When SIMOTION is integrated in a complete automation system, hierarchic automation structures often result.

Thanks to the ability to configure SIMOTION as controller and device concurrently on the same PROFINET interface (I-Device), both hierarchic automation structures and modular machine concepts can be implemented easily and without additional components:

- On the one hand, SIMOTION as a device can communicate with a higher-level controller, e.g. a SIMATIC S7 PLC or a non-Siemens PLC.
- On the other hand, SIMOTION can also communicate with local IO devices, such as drives and I/O modules, in the role of IO Controller.

Via controller-to-controller and controller-to-device relationships based on PROFINET IO with IRT, it is also possible to synchronize large axis quantity structures via several SIMOTION IO Controllers. This functionality is known as distributed synchronous operation.

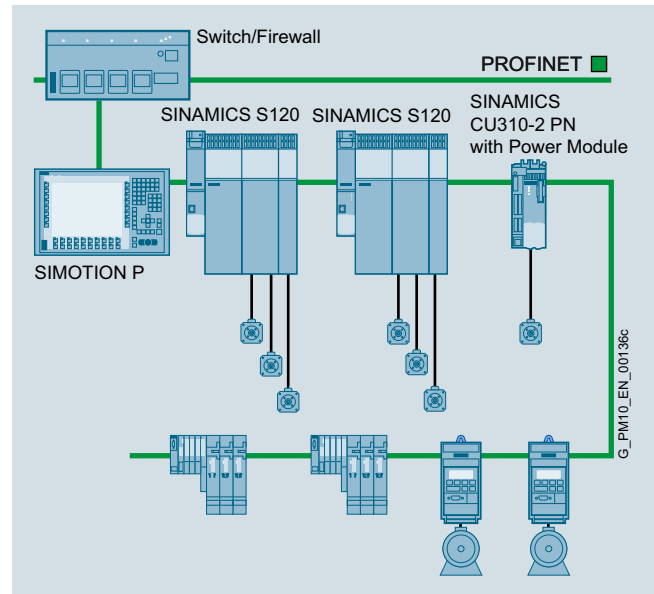

Central Motion Control architecture

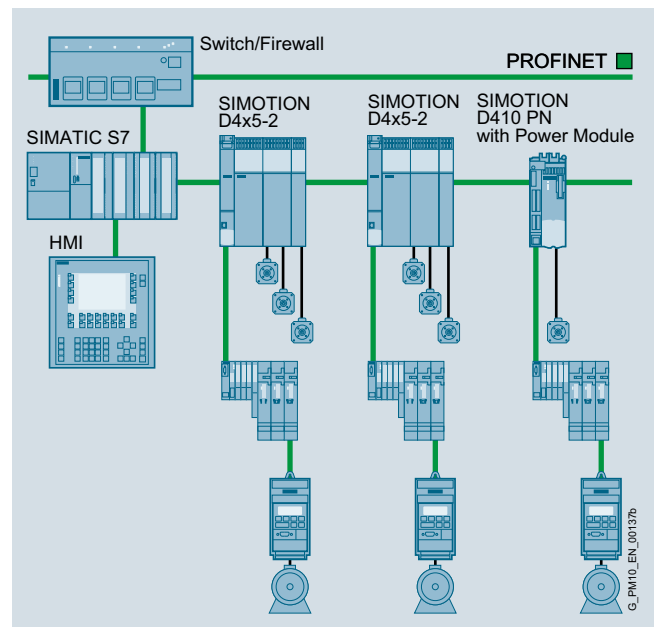

Distributed Motion Control architecture

# PROFINET/Industrial Ethernet

## Motion Control System SIMOTION

### PROFINET for SIMOTION

#### Overview

#### PROFINET – Functions of SIMOTION motion controllers

SIMOTION device	C240 PN	D410-2 DP/PN	D425-2 DP/PN	D435-2 DP/PN	D445-2 DP/PN	D455-2 DP/PN	P350-3	P320-3
Number of PROFINET interfaces	1	1	1 ... 2 (second interface is an option)	1 ... 2 (second interface is an option)	1 ... 2 (second interface is an option)	1 ... 2 (second interface is an option)	1	1

#### Interface 1

PROFINET with IRT (isochronous mode)	✓	✓	✓	✓	✓	✓	✓	✓
Number of ports	3	2	3	3	3	3	4	3
Max. number of devices	64	64	64	64	64	64	64	64
Min. send clock in ms	0.5	0.25	0.25	0.25	0.25	0.25	0.25	0.25
I-Device	✓	✓	✓	✓	✓	✓	✓	✓
Bumpless media redundancy (MRPD) <sup>1)</sup>	✓	–	✓	✓	✓	✓	–	✓
Step-change media redundancy (MRP)	✓	–	✓	✓	✓	✓	–	✓
PROFIsafe routing	✓	✓	✓	✓	✓	✓	✓	✓
PROFInergy (as controller)	✓	✓	✓	✓	✓	✓	✓	✓

#### Interface 2 (option) <sup>2)</sup>

PROFINET with IRT (isochronous mode)	–	–	✓	✓	✓	✓	–	–
Number of ports (CBE30-2 option board)	–	–	4	4	4	4	–	–
Max. number of devices	–	–	64	64	64	64	–	–
Min. send clock in ms	–	–	0.25	0.25	0.25	0.25	–	–
I-Device	–	–	✓	✓	✓	✓	–	–
Bumpless media redundancy (MRPD)	–	–	✓	✓	✓	✓	–	–
Step-change media redundancy (MRP)	–	–	✓	✓	✓	✓	–	–
PROFIsafe routing	–	–	✓	✓	✓	✓	–	–
PROFInergy (as controller)	–	–	✓	✓	✓	✓	–	–

<sup>1)</sup> To establish bumpless media redundancy (MRPD), a separate switch from the SCALANCE X200IRT series is required.

<sup>2)</sup> Optional second PROFINET interface over CBE30-2 (4 ports).

#### PROFINET – Functions of the SINAMICS S120 Control Units

SINAMICS S120	CU320-2 PN	CU320-2 DP (CBE20)	CU310-2 PN
PROFINET with IRT (isochronous mode)	✓	✓	✓
Number of ports	2	4	2
Min. send clock in ms	0.25	0.5	0.25
Shared device	✓	✓	✓
Bumpless media redundancy (MRPD)	✓	✓	✓
Step-change media redundancy (MRP)	✓	✓	✓
PROFIsafe	✓	✓	✓
PROFInergy	✓	✓	✓
PROFIdrive	✓	✓	✓

#### PROFINET for SIMOTION

SIMOTION is fully integrated into the PROFINET communication. Interaction with the following PROFINET components is possible:

- Distributed I/O with SIMOTION
- Drives via PROFIdrive on SIMOTION
- SIMOTION as an IO-Device with a SIMATIC S7 CPU
- Active network components (e.g. SCALANCE) with SIMOTION
- PROFIsafe to a SIMATIC F-CPU. The PROFIsafe message frames are routed from SIMOTION to the lower-level drives.

When an automation topology is configured, the real-time classes RT and IRT can be used alongside each other on the same network or cable. It must be noted that not all devices support both real-time classes RT and IRT. For devices that should be synchronized with IRT, it is important that all the PROFINET components that lie in between support the IRT real-time class.

### Overview

#### **PROFIdrive – The standardized drive interface for PROFINET and PROFIBUS**

PROFIdrive defines the device behavior and the access procedure to internal drive data for electrical drives on PROFINET and PROFIBUS, from simple frequency converters up to high-performance servo controllers.

It contains a detailed description of how the communication functions "slave-to-slave communication", "constant bus cycle time" and "isochronous operation" are used for drive applications. In addition, it clearly specifies all device characteristics which influence interfaces connected to a controller over PROFINET or PROFIBUS. This includes the sequence control, encoder interface, standardization of values, definition of standard messages, and access to drive parameters, etc.

The PROFIdrive profile supports both central as well as distributed motion control concepts.

#### **What are profiles?**

Profiles specify specific properties and responses for devices and systems in automation. In this manner, manufacturers and users pursue the goal of defining common standards. Devices and systems that comply with a multi-vendor profile can interoperate on a fieldbus and can be operated interchangeably to a certain extent.

#### **Do different profile types exist?**

A distinction is made between application profiles (general or specific) and system profiles:

- Application profiles (also known as device profiles) mainly refer to devices (e.g. drives) and contain an agreed selection of bus communication modes, as well as specific device applications.
- System profiles describe system classes and include the master functionality, program interfaces and integration methods.

#### **Is PROFIdrive future-proof?**

PROFIdrive has been specified by PROFIBUS and PROFINET International (PI) and has been laid down in IEC 61800-7 as a future-proof standard.

#### **The basic philosophy: Keep it simple**

The PROFIdrive profile tries to keep the drive interface as simple as possible and free from technology functions. This philosophy ensures that reference models as well as the functionality and performance of the PROFINET/PROFIBUS master have no or very little influence on the drive interface.

#### **One drive profile – Different application categories**

The integration of drives into automation solutions depends strongly upon the drive task. To cover the extensive range of drive applications from the simple frequency converter up to highly dynamic, synchronized multi-axis systems with a single profile, PROFIdrive defines six application categories which define most drive applications:

- Category 1 – Standard drives (such as pumps, fans, stirring units, etc.)
- Category 2 – Standard drives with technology functions
- Category 3 – Positioning drives
- Category 4 – Motion control drives with central, higher-level motion control intelligence and the patented "Dynamic Servo Control" position control concept
- Category 5 – Motion control drives with central, higher-level motion control intelligence and position setpoint interface
- Category 6 – Motion control drives with distributed motion control intelligence integrated in the drives

## PROFINET/Industrial Ethernet Motion Control System SIMOTION

### PROFIdrive for SIMOTION

#### Design

##### The device model of PROFIdrive

PROFIdrive defines a device model based on function modules which cooperate in the device and generate the intelligence of the drive system. These modules have objects assigned to them which are described in the profile and are defined with respect to their functions. The overall functionality of a drive is therefore described through the sum of its parameters.

In contrast to other drive profiles, PROFIdrive defines only the access mechanisms to the parameters as well as a subset of approx. 30 profile parameters such as the fault buffer, drive control and device identification.

All other parameters are vendor-specific which gives drive manufacturers great flexibility with respect to implementing function modules. The elements of a parameter are accessed acyclically via data records.

As a communication protocol, PROFIdrive uses DP-V0, DP-V1, and the DP-V2 expansions for PROFIBUS including the functions "Slave-to-slave communication" and "Isochronous operation", or PROFINET IO with real-time classes RT and IRT.

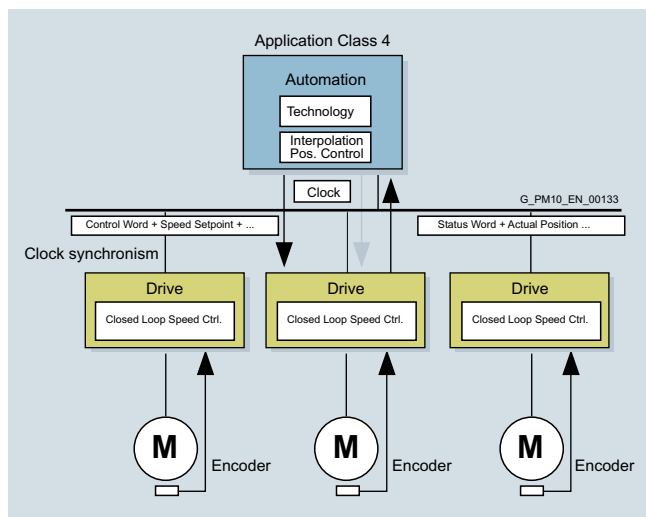

##### PROFIdrive for Motion Control

Utilization category 4 is the most important for highly dynamic and highly complex Motion Control tasks. This application category describes in detail the master/slave relationship between the Controller and the drives which are connected to each other over PROFINET and PROFIBUS.

The DSC (Dynamic Servo Control) function significantly improves the dynamic response and stiffness of the position control loop by minimizing the dead times which usually occur for speed setpoint interfaces with an additional, relatively simple feedback network in the drive. The position control loop is closed in the drive which permits very fast position control cycles (e.g. 125 µs for SINAMICS S120) and thus limits dead times exclusively to the control behavior.

##### PROFIdrive for SIMOTION

In SIMOTION, the drive interface has been implemented according to the PROFIdrive profile V4 and application categories 1 to 4 (category 4 with and without DSC).

When SINAMICS S120 operates with SIMOTION, utilization category 4 with DSC is used as standard.

#### More information

Further information about PROFINET and PROFIBUS can be found at [www.profibus.com](http://www.profibus.com)

See Downloads / Technical descriptions & books / PROFIdrive Technology and Application – System Description

Further information about SIMOTION can be found in catalog PM 21 and on the internet at: [www.siemens.com/simotion](http://www.siemens.com/simotion)



**Overview**

**Compact, strong, straightforward – simply ingenious**

The compact, operator-panel based SINUMERIK 828D BASIC T/BASIC M CNC controls offer maximum ruggedness and easy maintainability.

Powerful CNC functions coupled with a unique 80 bit NANO<sup>FP</sup> accuracy result in maximum workpiece precision and minimum machining time. Thanks to a flexible CNC programming language and the exceptional ShopTurn/ShopMill machining step programming, both mass produced components and individual workpieces can be programmed and machined with the maximum possible efficiency. Pre-configured technology-specific system software and unique servicing functions reduce the costs for commissioning and servicing to an absolute minimum.

Tailored for standard turning machines ...

The SINUMERIK 828D BASIC T CNC control is perfectly tailored to the requirements of modern standard turning machines. With powerful kinematic transformers and a comprehensive selection of technology cycles, the SINUMERIK 828D BASIC T is also well-equipped for sophisticated machining with rotating tools.

Perfectly tailored and pre-configured for:

- Up to 5 axes/spindles in one machining channel
- Front side machining with rotating tools
- Lateral surface machining with rotating tools

... Standard milling machines

The SINUMERIK 828D BASIC M CNC control is perfectly tailored to the requirements of modern standard milling machines. With the integrated SINUMERIK MDynamics technology package including the new intelligent motion and velocity control Advanced Surface, the SINUMERIK 828D BASIC M is also well-equipped for the machining of mold making workpieces.

Perfectly tailored and pre-configured for:

- Up to 5 axes/spindles in one machining channel
- Lateral surface machining with A axis
- Machining and use in mold making

**More information**

- Catalog NC 82
- Interactive Catalog CA 01
- Internet:  
[www.siemens.com/sinumerik](http://www.siemens.com/sinumerik)  
[www.siemens.com/industryrmall](http://www.siemens.com/industryrmall)

## PROFINET/Industrial Ethernet SINUMERIK CNC automation systems

### SINUMERIK 840D sl

#### Overview



SINUMERIK 840D sl offers modularity, openness, flexibility and uniform structures for operation, programming, and visualization. It provides a system platform with trend-setting functions for almost all technologies.

Integrated into the SINAMICS S120 drive system and complemented by the SIMATIC S7-300 automation system, the SINUMERIK 840D sl forms a complete digital system that is optimally suited to the mid and upper performance range.

SINUMERIK 840D sl is characterized by:

- A high level of flexibility
- Maximum dynamics and precision
- Optimum integration into networks

#### Benefits

- Maximum performance and flexibility for medium to complex multi-axis systems, thanks to scalable hardware and software
- Consistent openness in the area of the user interface, the PLC, and the NC core for the integration of your specific know-how
- Integrated safety functions for man and machine: SINUMERIK Safety Integrated
- Comprehensive range of functions for the integration of machine tools into communication, engineering and production processes: SINUMERIK Integrate

#### Application

The SINUMERIK 840D sl can be used globally in the following technologies:

- Turning
- Drilling
- Milling
- Grinding
- Laser cutting
- Nibbling
- Punching
- Toolmaking and moldmaking
- High-speed cutting applications
- Woodworking and glass processing
- Handling
- Transfer lines
- Rotary indexing machines
- Mass series production
- JobShop production

For use in countries requiring approval, there is the export version SINUMERIK 840DE sl.

#### More information

- Catalog NC 62
- Interactive Catalog CA 01
- Internet:  
[www.siemens.com/sinumerik](http://www.siemens.com/sinumerik)  
[www.siemens.com/industrymall](http://www.siemens.com/industrymall)

## Overview

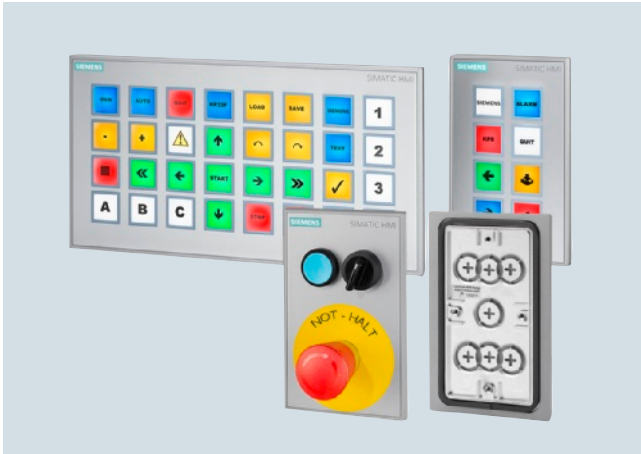

### SIMATIC HMI Key Panels

- Optimum operability thanks to large mechanical keys and multi-colored LED backlighting (daylight readable)
- Over 60% time savings for wiring and installation (Plug&Play)
- More than 30% savings in material costs compared to conventional keypad operator panels
- 2 PROFINET ports (incl. switch) already integrated for setting up line and ring topologies
- Freely configurable digital I/Os on the rear for connecting key-operated switches, indicator lamps, etc.
- Connection of fail-safe emergency stop buttons or other fail-safe signals with KP8F and KP32F (in SIL2 or SIL3)
- Functionally compatible with all standard PROFINET master CPUs, also non-Siemens KP8 and empty front design, also optimized for installation in IPC Extension Units in IP65
- Maximum flexibility due to parameterization
- Empty front design for standardized assembly of flexible operator panels

### SIMATIC HMI Key Panel – Blank front design

- Simple seamless installation with mounting clips
- Rugged design, suitable for harsh industrial environments
- Prepared for installation of 22.5 mm standard components Easy installation, or retrofitting during operation, of standard 22.5 mm operator controls

## Ordering data

## Article No.

### SIMATIC HMI Key Panel KP8 PN

6AV3688-3AY36-0AX0

Key Panel, 8 short-stroke keys with multicolored LEDs, PROFINET interfaces, 2 x parameterizable with STEP 7 V5.5 or higher

### SIMATIC HMI Key Panel KP8F PN

6AV3688-3AF37-0AX0

Key Panel, 8 short-stroke keys with multicolored LEDs, PROFINET interfaces with PROIsafe, parameterizable with STEP 7 V5.5 or higher; 4 additional fail-safe inputs. Can be used as 2 x SIL 2 or 1 x SIL 3

### SIMATIC HMI KP32F PN

6AV3688-3EH47-0AX0

Key Panel, 32 short-stroke keys with multicolored LEDs, PROFINET interfaces with PROIsafe, parameterizable with STEP 7 V5.5 or higher; including 8 fail-safe inputs. Can be used as 4 x SIL 2 or 2 x SIL 3

### Empty front design

6AV3688-3XY38-3AX0

for standard 22.5 mm operator controls, same mounting dimensions as KP8

### Demo case

A5E314777880

(Only by fax to +49 911 750 2411) includes:  
1 x case  
1 x KP8 PN1 x CPU 1211C  
1 x stand, permanently wired, including program;  
Power supply possible with a standard laptop mains adapter (not included in scope of supply)

### 12-pole connector set for KP8 PN

6AV6671-3XY38-4AX0

10 items per packaging unit

### 16-pole connector set for KP8F PN

6AV6671-3XY48-4AX0

10 items per packaging unit

### 16-pole connector set for KP8F PN

6AV6671-3XY58-4AX0

4 items per packaging unit

### Documentation

You can find the manual for the Key Panels on the Internet at:

<http://support.automation.siemens.com/WW/view/en/56652789>

### Note:

For further information see Catalog ST 80 / ST PC and Industry Mall at [www.siemens.com/industrymall](http://www.siemens.com/industrymall)

# PROFINET/Industrial Ethernet

## Operating and Monitoring Devices

### Basic Panels

#### Standard

#### Overview



With their fully developed HMI basic functions, 2nd generation SIMATIC HMI Basic Panels are the ideal entry level series for simple HMI applications.

The device family offers panels with 4", 7", and 9" displays, as well as combined key and touch operation.

The innovative high-resolution widescreen displays with 64 000 colors are also suitable for upright installation, and they can be dimmed down to 100 %.

The innovative operator interface with improved usability opens up a diverse range of options thanks to new controls and graphics.

The new USB interface enables the connection of keyboard, mouse or barcode scanner, and supports the simple archiving of data on a USB stick.

#### Ordering data

#### Article No.

##### SIMATIC HMI Basic Panels 2nd Generation

##### SIMATIC HMI Basic Panels, Key and Touch

• SIMATIC HMI KTP400 Basic	<b>6AV2123-2DB03-0AX0</b>
• SIMATIC HMI KTP700 Basic	<b>6AV2123-2GB03-0AX0</b>
• SIMATIC HMI KTP900	<b>6AV2123-2JB03-0AX0</b>

##### SIMATIC HMI Basic Panels 1st Generation

• SIMATIC HMI KP300 Basic mono PN	<b>6AV6647-0AH11-3AX0</b>
• SIMATIC HMI KTP400 Basic mono PN	<b>6AV6647-0AA11-3AX0</b>
• SIMATIC HMI KTP600 Basic mono PN	<b>6AV6647-0AB11-3AX0</b>
• SIMATIC HMI KTP600 Basic color DP	<b>6AV6647-0AC11-3AX0</b>
• SIMATIC HMI KTP600 Basic color PN	<b>6AV6647-0AD11-3AX0</b>
• SIMATIC HMI KTP1000 Basic color DP	<b>6AV6647-0AE11-3AX0</b>
• SIMATIC HMI KTP1000 Basic color PN	<b>6AV6647-0AF11-3AX0</b>
• SIMATIC HMI TP1500 Basic color PN	<b>6AV6647-0AG11-3AX0</b>

**Starter kit SIMATIC S7-1200 + KP300 Basic mono PN** **6AV6651-7HA01-3AA4**

**Starter kit SIMATIC S7-1200 + KTP400 Basic** **6AV6651-7AA01-3AA4**

**Starter kit SIMATIC S7-1200 + KTP700 Basic** **6AV6651-7DA01-3AA4**

##### Starter kits consisting of:

- the respective SIMATIC HMI Basic Panel
  - SIMATIC HMI KP300 Basic mono PN
  - SIMATIC HMI KTP400 Basic mono PN
  - SIMATIC HMI KTP600 Basic color PN
- SIMATIC S7-1200 CPU 1212C AC/DC/Rly
- SIMATIC S7-1200 Simulator Module SIM 1274
- SIMATIC STEP 7 BASIC CD
- SIMATIC S7-1200 HMI Manual Collection CD
- Ethernet CAT5 cable, 2 m

#### Article No.

##### SIMATIC HMI Basic Panels 1st Generation (continued)

##### Starter kit LOGO! + HMI Basic Panel

consisting of:  
SIMATIC HMI Basic Panel LOGO!  
12/24 RCE  
LOGO! Power 24 V / 1,3 A  
LOGO! Soft Comfort V7  
WinCC Basic (TIA Portal)  
HMI manual CD  
Ethernet cable, 2 m

- LOGO! 0BA7 + KP300 Basic starter kit
- LOGO! 0BA7 + KTP400 Basic starter kit

**6AV2132-0HA00-0AA1**

**6AV2132-0KA00-0AA1**

##### Configuration

All device variants:  
SIMATIC WinCC Basic/Comfort/Professional or  
SIMATIC STEP 7 Basic/Professional (with integrated WinCC Basic)

see catalog ST 80 / ST PC

##### Documentation

You can find the manual for the Basic Panels on the Internet at:

<http://support.automation.siemens.com>

##### Note:

For further information see Catalog ST 80 / ST PC and Industry Mall at [www.siemens.com/industrymall](http://www.siemens.com/industrymall)

## Overview



- Excellent HMI functionality for demanding applications
- Widescreen TFT displays with 4", 7", 9", 12", 15", 19" and 22" diagonals (all 16 million colors) with up to 40% more visualization area as compared to the predecessor devices
- Integrated high-end functionality with archives, scripts, PDF/Word/Excel viewer, Internet Explorer, Media Player and Web Server
- Dimmable displays from 0 to 100% via PROFlenergy, via the HMI project or via a controller
- Modern industrial design, cast aluminum fronts for 7" upwards
- Upright installation for all touch devices
- Optimal selection option: seven touch and five key versions are available
- Data security in the event of a power failure for the device and for the SIMATIC HMI Memory Card
- Innovative service and commissioning concept through second SD card (automatic backup)
- Easy project transfer via standard cable (standard Ethernet cable, standard USB cable)
- Maximum performance with short screen refresh times
- Suitable for extremely harsh industrial environments thanks to extended approvals such as ATEX 2/22 and marine approvals
- Wide range of communication options: PROFIBUS and PROFINET onboard; 2 x PROFINET with integrated switch for 7" models or larger; plus 1 x PROFINET with Gigabit support for 15" models or larger
- All variants can be used as an OPC UA client or as an OPC DA server
- Key-operated devices with LED in every function key and new text input mechanism, similar to the keypads of mobile phones
- All keys have a service life of 2 million operations
- Configuring with the WinCC engineering software of the TIA Portal

## Ordering data

## Article No.

### *SIMATIC HMI Comfort Panels, Touch*

<b>SIMATIC HMI KTP400 Comfort, Key and Touch</b>	<b>6AV2124-2DC01-0AX0</b>
<b>SIMATIC HMI TP700 Comfort</b>	<b>6AV2124-0GC01-0AX0</b>
<b>SIMATIC HMI TP900 Comfort</b>	<b>6AV2124-0JC01-0AX0</b>
<b>SIMATIC HMI TP1200 Comfort</b>	<b>6AV2124-0MC01-0AX0</b>
<b>SIMATIC HMI TP1500 Comfort</b>	<b>6AV2124-0QC02-0AX0</b>
<b>SIMATIC HMI TP1900 Comfort</b>	<b>6AV2124-0UC02-0AX0</b>
<b>SIMATIC HMI TP2200 Comfort</b>	<b>6AV2124-0XC02-0AX0</b>

### *SIMATIC HMI Comfort Panels, Key*

<b>SIMATIC HMI KP400 Comfort</b>	<b>6AV2124-1DC01-0AX0</b>
<b>SIMATIC HMI KP700 Comfort</b>	<b>6AV2124-1GC01-0AX0</b>
<b>SIMATIC HMI KP900 Comfort</b>	<b>6AV2124-1JC01-0AX0</b>
<b>SIMATIC HMI KP1200 Comfort</b>	<b>6AV2124-1MC01-0AX0</b>
<b>SIMATIC HMI KP1500 Comfort</b>	<b>6AV2124-1QC02-0AX0</b>

### *Starter kits for HMI Comfort Panels*

consisting of:  
 the respective SIMATIC HMI Comfort Panel,  
 SIMATIC WinCC Comfort,  
 Ethernet cable, 2 m  
 SIMATIC HMI memory card 2 GB  
 10 protective films  
 for touch screen devices

<b>Starter kit for HMI KTP400 Comfort, Key and Touch</b>	<b>6AV2181-4DB20-0AX0</b>
<b>Starter kit for HMI TP700 Comfort</b>	<b>6AV2181-4GB00-0AX0</b>
<b>Starter kit for HMI TP900 Comfort</b>	<b>6AV2181-4JB00-0AX0</b>
<b>Starter kit for HMI TP1200 Comfort</b>	<b>6AV2181-4MB00-0AX0</b>
<b>Starter kit for HMI TP1500 Comfort</b>	<b>6AV2181-4QB00-0AX0</b>
<b>Starter kit for HMI TP1900 Comfort</b>	<b>6AV2181-4UB00-0AX0</b>
<b>Starter kit for HMI TP2200 Comfort</b>	<b>6AV2181-4XB00-0AX0</b>
<b>Starter kit for HMI KP400 Comfort, key</b>	<b>6AV2181-4DB10-0AX0</b>
<b>Starter kit for HMI KP700 Comfort, key</b>	<b>6AV2181-4GB10-0AX0</b>
<b>Starter kit for HMI KP900 Comfort, key</b>	<b>6AV2181-4JB10-0AX0</b>
<b>Starter kit for HMI KP1200 Comfort, key</b>	<b>6AV2181-4MB10-0AX0</b>
<b>Starter kit for HMI KP1500 Comfort, key</b>	<b>6AV2181-4QB10-0AX0</b>

### Note:

For further information see Catalog ST 80 / ST PC and Industry Mall at [www.siemens.com/industrymall](http://www.siemens.com/industrymall)

## PROFINET/Industrial Ethernet Operating and Monitoring Devices

### Mobile Panels

#### Overview



#### **SIMATIC Mobile Panel**

- Mobile operator panel for direct operator control of the plant and machine from any point
- Supports an optimum view of the workpiece or process and, at the same time, direct access and visual contact with the operator panel
- Versatile use thanks to easy unplugging and replugging during normal operation (Mobile Panel 177 and Mobile Panel 277) or
- Wireless freedom (Mobile Panel 277(F) IWLAN)
- Pixel-graphics, high-luminance color display with touch screen (analog/resistive)
- PROFIBUS or PROFINET communication, PROFINET over WLAN for Mobile Panel 277(F) IWLAN
- Freely-configurable function keys with customized labels (with LED) (not for Mobile Panel 277 10")

#### **SIMATIC Mobile Panel 177 and SIMATIC Mobile Panel 277**

- Two three-stage acknowledgement buttons; Optional versions include:
  - STOP button
  - STOP button, handwheel, key-operated switch and illuminated pushbutton (not for Mobile Panel 277 10")
- Communication is supported via a serial link, MPI/PROFIBUS or PROFINET
- Connection point recognition for local identification of the device based on the connection point ID
- Fast system availability after plugging into the connection boxes
- Connection to the controller and power supply is made via the connection box and the connecting cable

#### **SIMATIC Mobile Panel 277(F) IWLAN**

- Wireless, mobile operator panel for flexible and location-independent system and machine operation
- WLAN communication in accordance with IEEE 802.11 (a/b/g/h) and PROFINET support
- Powerful batteries and flexible concept for changing permit battery replacement "on the fly" without interrupting operation
- Effective range limitation and the local identification of the device by using transponder technology
- Low-cost, safety-related mobile operator control and monitoring via RFID technology (MOBY D) for plants with pre-installed safety resources (e.g. robot cells)
- Optional variants with: Handwheel, key switch and illuminated pushbutton
- Fail-safe operator controls of the SIMATIC Mobile Panel 277F IWLAN using PROFIsafe:
  - Two three-stage acknowledgement buttons
  - Emergency stop button

Ordering data	Article No.	Article No.
<b>SIMATIC Mobile Panel 177 PN (PROFINET)<sup>1)</sup></b> <ul style="list-style-type: none"> <li>With integrated acknowledgement button</li> <li>With integrated acknowledgement button and STOP button</li> <li>With integrated acknowledgement button, STOP button, handwheel, key-operated switch and illuminated pushbutton</li> </ul>	<b>6AV6645-0BA01-0AX0</b> <b>6AV6645-0BB01-0AX0</b> <b>6AV6645-0BC01-0AX0</b>	<b>Starter kit SIMATIC Mobile Panel 277(F) IWLAN (RoW VERSION)</b> for <ul style="list-style-type: none"> <li>Mobile Panel 277 IWLAN V2</li> <li>Mobile Panel 277F IWLAN V2</li> </ul>
<b>SIMATIC Mobile Panel 277 8" <sup>1)</sup></b> <ul style="list-style-type: none"> <li>With integrated acknowledgement button</li> <li>With integrated acknowledgement button and STOP button</li> <li>With integrated acknowledgement button, STOP button, handwheel, key-operated switch and two illuminated pushbuttons</li> </ul>	<b>6AV6645-0CA01-0AX0</b> <b>6AV6645-0CB01-0AX0</b> <b>6AV6645-0CC01-0AX0</b>	<b>6AV6651-5GA01-0AA1</b> <b>6AV6651-5HA01-0AA1</b>
<b>SIMATIC Mobile Panel 277 10"</b> <ul style="list-style-type: none"> <li>With integrated acknowledgement button and STOP button</li> </ul>	<b>6AV6645-0BE02-0AX0</b>	<b>Accessories for Mobile Panel 277 IWLAN/277(F) IWLAN</b> Note: Please order the table-top power supply or charging station as well. Required for charging the battery.
<b>SIMATIC Mobile Panel 277 IWLAN V2 (RoW version)</b> <ul style="list-style-type: none"> <li>Communication via WLAN (PROFINET)</li> <li>Communication via WLAN (PROFINET) with integrated handwheel, key-operated switch and two illuminated pushbuttons</li> </ul>	<b>6AV6645-0DD01-0AX1</b> <b>6AV6645-0DE01-0AX1</b>	<ul style="list-style-type: none"> <li>Power supply unit, external, Mobile Panel IWLAN; Only suitable for operation under laboratory/office conditions</li> <li>Charging station for SIMATIC Mobile Panels</li> <li>Main rechargeable battery for Mobile Panel IWLAN; For contents and matching devices, see Technical Data</li> <li>Transponder V2 incl. batteries (3x AA)</li> <li>Transponder V1 incl. batteries (3x AA) required for the operation of plants with Mobile Panels 277(F) IWLAN V1</li> <li>Service set V2 for Mobile Panel 277(F) IWLAN V2 consists of 2x covers for charging station l/r, 1x connector for charging station, 2x corner seals l/r, 2x gasket corner seals, 4x decorative film corner seals l/r, 1x spare key for charging cradle</li> </ul>
<b>SIMATIC Mobile Panel 277F IWLAN V2 PROFIsafe (RoW version)</b> <ul style="list-style-type: none"> <li>Communication via WLAN (PROFINET) with acknowledgement button and emergency stop button</li> <li>Communication via WLAN (PROFINET) with acknowledgement button and emergency stop button with integrated handwheel, key-operated switch, and two illuminated pushbuttons</li> <li>RFID tag version: Communication via WLAN (PROFINET) with acknowledgement button and emergency stop button with integrated handwheel, key-operated switch, and two illuminated pushbuttons</li> </ul>	<b>6AV6645-0EB01-0AX1</b> <b>6AV6645-0EC01-0AX1</b> <b>6AV6645-0EF01-0AX1</b>	<ul style="list-style-type: none"> <li>Service set V1 for Mobile Panel 277(F) IWLAN V1 consists of 2x covers for charging station l/r, 1x connector for charging station, 2x corner seals l/r, 2x gasket corner seals, 4x decorative film corner seals l/r, 1x backup battery 3.6 V / 1.5 Ah including cover, 1x spare key for charging cradle</li> </ul>
<b>SIMATIC Mobile Panel 277 IWLAN V2 (USA version)</b> <ul style="list-style-type: none"> <li>Communication via WLAN (PROFINET)</li> <li>Communication via WLAN (PROFINET) with integrated handwheel, key-operated switch and two illuminated pushbuttons</li> </ul>	<b>6AV6645-0FD01-0AX1</b> <b>6AV6645-0FE01-0AX1</b>	
<b>SIMATIC Mobile Panel 277F IWLAN V2 PROFIsafe (USA version)</b> <ul style="list-style-type: none"> <li>with acknowledgement button and emergency stop button</li> <li>with acknowledgement button and emergency stop button with integrated handwheel, key-operated switch, and two illuminated pushbuttons</li> <li>with acknowledgement button and emergency stop button with integrated handwheel, key-operated switch, and two illuminated pushbuttons (tag version)</li> </ul>	<b>6AV6645-0GB01-0AX1</b> <b>6AV6645-0GC01-0AX1</b> <b>6AV6645-0GF01-0AX1</b>	

<sup>1)</sup> The system components (connection cable and connection boxes) must be ordered separately

# PROFINET/Industrial Ethernet

## Operating and Monitoring Devices

### Mobile Panels

#### Ordering data

*Access Points SCALANCE W and Power Supplies PS791*

see chapter 6

#### Configuration

with SIMATIC WinCC flexible

see catalog ST 80 / ST PC

*Documentation (to be ordered separately)*

#### User Manual WinCC flexible Compact/Standard/Advanced

- German
- English
- French
- Italian
- Spanish

6AV6691-1AB01-3AA0

6AV6691-1AB01-3AB0

6AV6691-1AB01-3AC0

6AV6691-1AB01-3AD0

6AV6691-1AB01-3AE0

#### User Manual WinCC flexible Communication

- German
- English
- French
- Italian
- Spanish

6AV6691-1CA01-3AA0

6AV6691-1CA01-3AB0

6AV6691-1CA01-3AC0

6AV6691-1CA01-3AD0

6AV6691-1CA01-3AE0

#### Article No.

#### System components for Mobile Panels

#### PN connection box for Mobile Panel (PROFINET)

- Basic
- Plus

6AV6671-5AE01-0AX0

6AV6671-5AE11-0AX0

#### PN (PROFINET) connecting cable

Standard cable

- 2 m
- 5 m
- 8 m
- 10 m
- 15 m
- 20 m
- 25 m

6XV1440-4BH20

6XV1440-4BH50

6XV1440-4BH80

6XV1440-4BN10

6XV1440-4BN15

6XV1440-4BN20

6XV1440-4BN25

#### Accessories

see catalog ST 80 / ST PC

#### Note:

For further information see Catalog ST 80 / ST PC and Industry Mall at [www.siemens.com/industrymall](http://www.siemens.com/industrymall)



## Overview



IPC rack family

Rack PCs are flexible, high-availability industrial PC systems for powerful yet compact applications using 19" technology.

Three device classes are available for various requirements:

**SIMATIC IPC547** –  
maximum performance at an attractive price

**SIMATIC IPC647** –  
maximum compactness combined with maximum industrial functionality

**SIMATIC IPC847** –  
maximum expandability and industrial functionality

### Shared industrial functionality of the IPC series 547, 647 and 847

- Maximum system performance for complex automation tasks and computationally intensive PC tasks in the industrial environment through use of Intel Core processors
- Designed for 24-hour continuous operation
- Monitoring and diagnostics functions (e.g. temperature, fan, watchdog)
- RAID1 configuration (mirrored drives), optionally in hot swap drive bays
- Hard disks with capacities up to 1 TB for large volumes of data
- Solid-state drive (SSD) with MLC technology, optional
- Redundant AC power supply, optional
- Compact dimensions for installation in control cabinets only 500 mm deep
- Dust protection thanks to overpressure ventilation concept with fan on the front and dust filter
- Lockable front panel or front door
- Service-friendly equipment design due to prepared telescopic rail mounting
- Universal implementation as an industrial workstation or server
- Operating system preinstalled and activated for fast startup
- Fast restoration of the delivery status of the HDD thanks to restore DVD
- High flexibility and expandability of components
- PCI and PCI Express expansion slots
- Independent industrial product design

### **SIMATIC IPC547E** – **maximum performance at an attractive price**

- Intel Core i processors 4th generation
- Maximum processor performance in maximum configuration without loss of power (throttling) at ambient temperatures of up to 40 °C
- Optional RAID5 configuration (striping with parity) in hot swap drive bays
- RAID1 and RAID5 configurations with additional hot spare hard disk, optional
- Low noise output thanks to controlled fans
- Status and alarm LEDs at the front for signaling critical system states
- Availability for at least 1.5 years
- Guaranteed spare parts availability for at least 3 years

### **SIMATIC IPC647D** – **maximum compactness combined with maximum industrial functionality**

- Maximum compactness due to 4 free PCI/PCI Express slots for installing long expansion cards and integrated interfaces for communication, e.g. integrated PROFIBUS/MPI or PROFINET interface
- High thermal stability up to 50 °C ambient temperature, even at maximum processor performance
- High vibration/shock resistance thanks to special hard disk holders
- Intel Core i processors 4th generation
- ECC memory, optional
- Service-friendly device design due, for example, to the replacement of filters/fans from the front without the need for tools, or opening of the enclosure with just one screw.
- Front LED concept for efficient self-diagnostics, e.g. monitoring of hard disks in RAID1 configurations, fans or the status display for Ethernet, PROFINET and PROFIBUS.
- Integrated PROFIBUS DP/MPI or PROFINET interface (optional)
- High component/design continuity
- Motherboard developed and manufactured by Siemens
- Availability for up to 6 years
- Guaranteed spare parts availability for at least 5 years

## PROFINET/Industrial Ethernet

Industrial PC

Rack PC

### General data

#### Overview (continued)

##### **SIMATIC IPC847D – maximum expandability and industrial functionality**

- Maximum expandability due to 11 free PCI/PCI Express slots for installing long expansion cards and integrated interfaces for communication, e.g. integrated PROFIBUS/MPI or PROFINET interface
- High thermal stability up to 50 °C ambient temperature, even at maximum processor performance
- High vibration/shock resistance thanks to special hard disk holders
- Intel Core i processors 4th generation
- Optional RAID5 configuration (striping with parity) in hot swap drive bays
- RAID1 and RAID5 configurations with additional hot spare hard disk, optional
- ECC memory, optional
- Service-friendly device design due, for example, to the replacement of filters/fans from the front without the need for tools, or opening of the enclosure with just one screw.
- Front LED concept for efficient self-diagnostics, e.g. monitoring of hard disks in RAID1 configurations, fans or status displays for Ethernet, PROFINET and PROFIBUS
- Integrated PROFIBUS DP/MPI or PROFINET interface (optional)
- High component/design continuity
- Motherboard developed and manufactured by Siemens
- Availability for up to 6 years
- Guaranteed spare parts availability for at least 5 years

#### Benefits

##### **Rugged design**

The overall design aims to achieve maximum safety for electro-magnetic, vibration and shock loads. A well-designed pressurized ventilation concept ensures that even the maximum configuration can support high operating temperatures – and dust protection is included.

##### **Service-friendly device design**

Particular attention was paid to making servicing extremely simple. PC components (e.g. slots, memory modules) are readily accessible. Fan filters and fans can be replaced without tools even when unit is built-in.

##### **Performance**

Thanks to the use of the latest generation of Intel Pentium Dual Core to Core i processors (2nd generation technology), SIMATIC Rack PCs are flexibly scalable for your application.

##### **System availability**

SIMATIC racks can be ordered in custom configurations and are supplied ready for use. The design's high system availability can be further extended by means of additional data backup options (e.g. RAID1 or RAID5 system, redundant power supply, SIMATIC IPC Image & Partition Creator) and efficient self-diagnostics software (SIMATIC IPC DiagMonitor).

##### **Integrated interfaces**

Two onboard Gbit Ethernet interfaces are available for communication in the office world or at the control level. Integrated USB interfaces on the rear and front panels make connecting I/O devices from the PC world (e.g. external hard disks for mobile data backup, keyboard and/or mouse for operation) child's play. For advanced graphics applications, a spare PCI Express slot and a high-performance graphics card for the connection of two monitors are available.

##### **Expandability**

With up to 11 free PC slots, the SIMATIC Rack PC offers maximum leeway for expansions for installation in space-saving cabinets with a depth of just 500 mm.

##### **The continuity with IPC547, IPC647, IPC847**

The SIMATIC Rack PC models can be ordered for a period of at least 1.5 years; spare parts remain obtainable for at least 3 years after active marketing is concluded. Long-term functionality of the hardware and software is also ensured. Long-term availability of PC components from the Intel embedded line ensures high investment protection.

**Technical specifications**

Rack PC	SIMATIC IPC347D	SIMATIC IPC547E Enclosure depth 356 mm	SIMATIC IPC547E Enclosure depth 446 mm	SIMATIC IPC647D	SIMATIC IPC847D
<b>Design</b>					
19" rack	4 HU	4 U	4 U	2 HU	4 HU
Prepared for telescopic rails	•	•	•	•	•
Horizontal/vertical installation	• / -	• / •	• / •	• / -	• / •
19" mounting bracket can be removed from outside	•	•	•	•	•
Tower Kit (optional)	-	•	•	-	•
<b>General features</b>					
Processor	<ul style="list-style-type: none"> <li>Intel Core i5-3340S (4C/4T, 2.8 (3.3) GHz)</li> <li>Intel Pentium G2010 (2C/2T, 2.8 GHz)</li> </ul>	<ul style="list-style-type: none"> <li>Intel Pentium Dual Core G3420 (2C/2T, 3.2 GHz, 3 MB cache)</li> <li>Intel Celeron G1820 (2C/2T, 2.7 GHz, 2 MB cache)</li> </ul>	<ul style="list-style-type: none"> <li>Intel Core i7-4770S (4C/8T, 3.1 (3.9) GHz)</li> <li>Intel Core i5-4570S (4C/4T, 2.9 (3.6) GHz)</li> <li>Intel Pentium G3420 (2C/2T, 3.2 GHz)</li> </ul>	<ul style="list-style-type: none"> <li>Intel Xeon E3-1268L v3 (4C/8T, 2.3 (3.3) GHz)</li> <li>Intel Core i5-4570TE (2C/4T, 2.7 (3.3) GHz)</li> <li>Intel Core i3-4330TE (2C/4T, 2.4 GHz)</li> </ul>	<ul style="list-style-type: none"> <li>Intel Xeon E3-1268L v3 (4C/8T, 2.3 (3.3) GHz)</li> <li>Intel Core i5-4570TE (2C/4T, 2.7 (3.3) GHz)</li> <li>Intel Core i3-4330TE (2C/4T, 2.4 GHz)</li> </ul>
Main memory	<ul style="list-style-type: none"> <li>2 GB or 4 GB, expandable up to 16 GB</li> </ul>	<ul style="list-style-type: none"> <li>2 GB, expandable up to 16 GB</li> </ul>	<ul style="list-style-type: none"> <li>2 GB, expandable up to 32 GB</li> </ul>	<ul style="list-style-type: none"> <li>2 GB, expandable up to 32 GB</li> <li>ECC optional</li> </ul>	<ul style="list-style-type: none"> <li>2 GB, expandable up to 32 GB</li> <li>ECC optional</li> </ul>
Slots for expansions (all long, up to 312 mm)	<ul style="list-style-type: none"> <li>4 x PCI</li> <li>1 x PCI Express x16</li> <li>1 x PCI-Express x8 (1 lane)</li> <li>1 x PCI-Express x1</li> </ul>	<ul style="list-style-type: none"> <li>4 x PCI</li> <li>1 x PCI-Express x16</li> <li>1 x PCI-Express x16 (2 lanes)</li> <li>1 x PCI-Express x8 (1 lane)</li> </ul>	<ul style="list-style-type: none"> <li>4 x PCI</li> <li>1 x PCI-Express x16 Gen 3</li> <li>1 x PCI Express x16 (4 lanes)</li> <li>1 x PCI-Express x8 (1 lane)</li> </ul>	<ul style="list-style-type: none"> <li>2 x PCI</li> <li>2 x PCI-Express x16 (8 lanes)</li> <li>or</li> <li>3 x PCI-Express x16 (4 lanes)</li> <li>1 x PCI-Express x16 (8 lanes)</li> <li>or</li> <li>2 x PCI-Express x16 (4 lanes)</li> </ul>	<ul style="list-style-type: none"> <li>7 x PCI</li> <li>1 x PCI-Express x16</li> <li>3 x PCI-Express x4 (1 lane)</li> <li>or</li> <li>3 x PCI</li> <li>1 x PCI-Express x16 (8 lanes)</li> <li>4 x PCI-Express x16 (4 lanes)</li> <li>3 x PCI Express x4</li> </ul>
Onboard graphics	<ul style="list-style-type: none"> <li>1 x DVI-D</li> <li>1 x VGA</li> </ul>	<ul style="list-style-type: none"> <li>1 x DisplayPort V1.2</li> <li>1 x DVI-I</li> <li>1 x VGA (via adapter cable, optional)</li> </ul>	<ul style="list-style-type: none"> <li>2 x DisplayPort V1.2</li> <li>1 x DVI-I</li> <li>1 x VGA (via adapter cable, optional)</li> </ul>	<ul style="list-style-type: none"> <li>2 x DisplayPort</li> <li>1 x DVI-I</li> <li>1 x VGA (via adapter cable, optional)</li> </ul>	<ul style="list-style-type: none"> <li>2 x DisplayPort</li> <li>1 x DVI-I</li> <li>1 x VGA (via adapter cable, optional)</li> </ul>
Graphics card (optional)	-	<ul style="list-style-type: none"> <li>PCI-Express x16 (2 x VGA or 2 x DVI-D)</li> </ul>	<ul style="list-style-type: none"> <li>PCI Express x16 (2 x VGA or 2 x DVI-D)</li> </ul>	<ul style="list-style-type: none"> <li>PCI Express x16 (2 x VGA or 2 x DVI-D)</li> </ul>	<ul style="list-style-type: none"> <li>PCI Express x 16 (2 x VGA or 2 x DVI-D)</li> </ul>
<b>Operating system</b>					
without	•	•	•	•	•
Preinstalled and activated, supplied on restore DVD	<ul style="list-style-type: none"> <li>Windows 7 Ultimate Multi-Language (64-bit)</li> </ul>	<ul style="list-style-type: none"> <li>Windows 7 Ultimate Multi-Language (32/64-bit)</li> </ul>	<ul style="list-style-type: none"> <li>Windows 7 Ultimate Multi-Language (32/64-bit)</li> <li>Windows Server 2008 R2 incl. 5 Clients Multi-Language (64-bit)</li> </ul>	<ul style="list-style-type: none"> <li>Windows 7 Ultimate Multi-Language (32/64-bit)</li> <li>Windows Server 2008 R2 incl. 5 Clients Multi-Language (64-bit)</li> </ul>	<ul style="list-style-type: none"> <li>Windows 7 Ultimate Multi-Language (32/64-bit)</li> <li>Windows Server 2008 R2 incl. 5 Clients Multi-Language (64-bit)</li> </ul>
Project-specific on request	-	<ul style="list-style-type: none"> <li>Linux <sup>1)</sup></li> <li>Other</li> </ul>	<ul style="list-style-type: none"> <li>Linux <sup>1)</sup></li> <li>Other</li> </ul>	<ul style="list-style-type: none"> <li>Linux <sup>1)</sup></li> <li>Other</li> </ul>	<ul style="list-style-type: none"> <li>Linux <sup>1)</sup></li> <li>Other</li> </ul>
<b>Interfaces</b>					
PROFIBUS/MPI	-	-	-	12 Mbit/s (compatible with CP 5622), optional	12 Mbit/s (compatible with CP 5622), optional
PROFINET	-	-	-	3 x RJ45 (compatible with CP 1616), optional	3 x RJ45 (compatible with CP 1616), optional
Ethernet	2 x Realtek 10/100/1000 Mbps	1 x Intel Gigabit Ethernet (RJ45)	2 x Intel Gigabit Ethernet (RJ45, teaming-capable)	2 x Intel 10/100/1000 Mbps	2 x Intel 10/100/1000 Mbps
USB 3.0 (high current)	-	2 x	4 x, 2 of which at front	4 x, 1 of which at front, 1 x internal	4 x, 1 of which at front, 1 x internal
USB 2.0 (high current)	6 x, 2 of which at front	6 x at the rear	7 x: 6 x rear, 1 x internal, e.g. for USB dongle with optional interlocking	3 x, 1 of which at front	3 x, 1 of which at front
VGA	•	• optional	• optionally via adapter cable	• optional	• optional
DVI	•	• 1 x	• 1 x	•	•
DisplayPort	-	• 1 x	• 2 x	•	•

• Available  
 - Not available

**PROFINET/Industrial Ethernet****Industrial PC****Rack PC****General data****Technical specifications** (continued)

Rack PC	SIMATIC IPC347D	SIMATIC IPC547E Enclosure depth 356 mm	SIMATIC IPC547E Enclosure depth 446 mm	SIMATIC IPC647D	SIMATIC IPC847D
<b>Drives</b>					
SATA hard disks					
• Internal installation	•	•	•	-	•
• Installation at the front in the removable drive bay	-	-	•	•	•
• Internal installation in drive holder (shock and vibration-damped)	-	-	-	•	•
RAID1/5 configuration with onboard RAID	-	-	• / •	• / -	• / •
RAID configuration with additional hot spare hard disk	-	-	•	•	•
Solid-state drive (SSD), MLC	-	•	•	•	•
<b>Optical drives</b>					
DVD-ROM	•	-	•	-	-
DVD±R/RW	•	• (Slim)	• (Slim)	• (Slim)	• (Slim)
<b>AC power supply</b>					
Redundant (optional)	-	-	•	•	•
<b>Ambient conditions <sup>2)</sup></b>					
Vibration/shock load during operation	-	0.2 g / 1 g	0.2 g / 1 g	0.5 g / 5 g	0.5 g / 5 g
Ambient temperature during operation	5 ... 40 °C	With maximum configuration: 5 ... 40 °C	With maximum configuration: 5 ... 40 °C Note: Limitations for operation of DVD±R/RW	With maximum configuration: 5 ... 50 °C	With maximum configuration: 5 ... 50 °C

- Available
- Not available

<sup>1)</sup> Suitable for specific LINUX versions in accordance with the specifications of the Siemens manufacturer's declaration "Suitable for LINUX", see [www.siemens.com/simatic-pc/suited-for-linux](http://www.siemens.com/simatic-pc/suited-for-linux) (LINUX is a trademark of Linus Torvalds)

<sup>2)</sup> Restrictions when using DVD±R/RW and hard disks in removable drive bay.

**More information**

Further information can be found in the Internet under:

<http://www.siemens.com/simatic-pc>

Information material can be ordered or downloaded from the Internet:

<http://www.siemens.com/simatic/printmaterial>

## Overview



IPC547E long and short enclosure design

The SIMATIC IPC547E is a rugged industrial PC in 19" rack design (4 U).

It offers:

- Maximum performance
- Attractive price
- Intel Core i technology

## Benefits

### **Maximum system performance for complex automation and visualization tasks**

- State-of-the-art PC technology (e.g. Intel Core i processors 4th generation with Turbo Boost 2.0, hyper-threading and virtualization technology)
- Memory and graphics controller integrated into processor for extraordinary memory and graphics performance
- Maximum performance (e.g. Intel Q87 chipset, DDR3 1600 memory with support of dual channel technology)
- High data transfer rates (e.g. with serial ATA solid-state drives up to 240 GB, serial ATA hard disks up to 1 TB, dual Gigabit Ethernet, PCI Express 3.0 technology)

### **Reduction in downtimes through high system availability**

- Secure 24-hour operation (high MTBF, variable-speed fan)
- Efficient self-diagnostics (front status LEDs for fan and temperature, SIMATIC IPC DiagMonitor)
- High degree of data security due to RAID1 (mirror disk system) or RAID5 (striping with parity), also with additional hot spare hard disk
- "Hot swap" removable drive bay in RAID configuration (replacement of hard disk during operation)
- Fast identification and replacement of the hard disk in the event of a fault by means of HDD alarm LEDs for RAID configurations
- Solid-state drive option in conjunction with RAID1 (data in the RAID1 network on hard disks, preinstalled and activated operating system on solid-state drive)
- Redundant power supply with "hot swap" functionality (replacement of power supply module during operation)

### **High flexibility and user friendliness during commissioning, operation and service**

- Preinstalled and activated operating system
- IAMT (Intel Active Management Technology) functionality for remote access to the IPC (remote maintenance)
- Fast restoration of the delivery status of the hard disk(s) thanks to restore DVD
- Low noise output thanks to controlled fans
- Universal implementation as an industrial workstation or server
- RAID1/RAID5 onboard (a PCI slot is not occupied by the RAID Controller)
- Flexible applications in many different positions with telescopic rails or as tower industrial PC
- High degree of flexibility and expandability thanks to integrated interfaces and 7 slots (PCI and PCI-Express)

### **High industrial compatibility and compactness for 24-hour use in an industrial environment**

- Maximum processor performance (in maximum configuration) without loss of power (throttling) at ambient temperatures of up to 40 °C
- Distinct product design with dirt-resistant surfaces
- Metal enclosure with a high degree of electromagnetic compatibility for use in industrial areas and in domestic, business and commercial environments
- Suitable for installing in space-saving control cabinets only 400 mm deep
- Dust protection thanks to overpressure ventilation concept with fan on the front and dust filter
- Special hard disk holders and card retainers for protection against vibration and shock

### **Cost reductions through high investment security**

- Availability of at least 1.5 years, guaranteed availability of spare parts for 3 years
- System-tested with SIMATIC components
- Certification for worldwide marketing (cULus)
- Support for legacy interfaces (PS/2, COM, LPT)
- Installation compatible for many device generations
- Worldwide service and support

**PROFINET/Industrial Ethernet**Industrial PC  
Rack PC**SIMATIC IPC547E****Technical specifications**

	<b>IPC547E (enclosure depth 356 mm)</b>	<b>IPC547E (enclosure depth 446 mm)</b>
<b>General features</b>		
Design	19" rack PC, 4 U	
Processors	<ul style="list-style-type: none"> <li>Intel Pentium Dual Core G3420 (2C/2T, 3.2 GHz, 3 MB cache)</li> <li>Intel Celeron G1820 (2C/2T, 2.7 GHz, 2 MB cache)</li> </ul>	<ul style="list-style-type: none"> <li>Intel Core i7-4770S (4C/8T, 3.1 (3.9) GHz, 8 MB cache, iAMT)</li> <li>Intel Core i5-4570S (4C/4T, 2.9 (3.6) GHz, 6 MB cache, iAMT)</li> <li>Intel Pentium Dual Core G3420 (2C/2T, 3.2 GHz, 3 MB cache)</li> </ul>
Chipset	<ul style="list-style-type: none"> <li>Intel H81</li> </ul>	<ul style="list-style-type: none"> <li>Intel Q87</li> </ul>
Main memory	<ul style="list-style-type: none"> <li>From 2 GB DDR3-1600 SDRAM</li> <li>Dual channel support</li> <li>2 DIMM base</li> <li>Expandable up to 16 GB <sup>1)</sup></li> </ul>	<ul style="list-style-type: none"> <li>From 2 GB DDR3-1600 SDRAM</li> <li>Dual channel support</li> <li>4 DIMM base</li> <li>Expandable up to 32 GB <sup>1)</sup></li> </ul>
Spare slots for expansions (all long)	<ul style="list-style-type: none"> <li>1 x PCI-Express x16</li> <li>1 x PCI-Express x16 (2 lanes)</li> <li>1 x PCI-Express x8 (1 lane)</li> <li>4 x PCI</li> </ul>	<ul style="list-style-type: none"> <li>1 x PCI-Express x16</li> <li>1 x PCI-Express x16 (4 lanes)</li> <li>1 x PCI-Express x8 (1 lane)</li> <li>4 x PCI</li> </ul>
Graphics	<ul style="list-style-type: none"> <li>Onboard Intel HD / Intel HD graphics 4600 graphics controller integrated into the processor</li> <li>Dynamic video memory up to 1.7 GB; up to 3840 x 2160 pixels at 60 Hz image refresh rate and 32-bit colors</li> <li>PCI Express graphics card (Dual Head: 2 x VGA or 2 x DVI-D) in the PCIe x16 slot (optional), 512 MB; up to 2048 x 1536 pixels at 60 Hz image refresh rate and 32-bit colors</li> </ul>	
Operating Systems	<ul style="list-style-type: none"> <li>Without</li> </ul> Preinstalled and activated (supplied on restore DVD): <ul style="list-style-type: none"> <li>Windows 7 Ultimate MUI (32/64-bit)</li> </ul> MUI (Multilanguage User Interface, 5 languages): English, German, French, Italian, Spanish Project-specific on request: <ul style="list-style-type: none"> <li>Linux <sup>2)</sup></li> <li>Other</li> </ul>	<ul style="list-style-type: none"> <li>Without</li> </ul> Preinstalled and activated (supplied on restore DVD): <ul style="list-style-type: none"> <li>Windows 7 Ultimate MUI (32/64-bit)</li> <li>Windows Server 2008 R2 incl. 5 Client MUI (64 bit)</li> </ul> MUI (Multilanguage User Interface, 5 languages): English, German, French, Italian, Spanish Project-specific on request: <ul style="list-style-type: none"> <li>Linux <sup>2)</sup></li> <li>Other</li> </ul>
Power supplies	<ul style="list-style-type: none"> <li>100 ... 240 V AC, 50 ... 60 Hz, with bridging of short-term power failures: max. 20 ms at 0.85 % rated voltage</li> </ul>	<ul style="list-style-type: none"> <li>100 ... 240 V AC, 50 ... 60 Hz, with bridging of short-term power failures: max. 20 ms at 0.85 % rated voltage</li> <li>Redundant 2 x 100 ... 240 V AC, 50 ... 60 Hz</li> </ul>
<b>Drives</b>		
Hard disks, SATA 3.5" with NCQ technology	Internal installation <ul style="list-style-type: none"> <li>1 x 500 GB HDD</li> <li>1 x 1 TB HDD</li> <li>2 x 1 TB HDD</li> </ul>	Internal installation <ul style="list-style-type: none"> <li>1 x 500 GB HDD</li> <li>1 x 1 TB HDD</li> <li>2 x 1 TB HDD</li> <li>1 x 240 GB SSD</li> <li>RAID1, 1 TB (2 x 1 TB HDD, mirror disks) <sup>3)</sup></li> </ul>
Solid-state drives, SATA 2.5" with MLC technology		Installation at the front in swap frame (low-profile) <ul style="list-style-type: none"> <li>1 x 500 GB HDD</li> <li>1 x 1 TB HDD</li> <li>2 x 1 TB HDD</li> <li>1 x 240 GB SSD</li> <li>RAID1, 1 TB (2 x 1 TB HDD, mirror disks), "hot swap" <sup>3)</sup></li> <li>RAID1, 1 TB (2 x 1 TB HDD, mirror disks), "hot swap" <sup>3)</sup> + 1 x 1 TB HDD as hot spare</li> <li>RAID1, 1 TB (2 x 1 TB HDD, mirror disks), "hot swap" <sup>3)</sup> + 1 x 240 GB SSD (operating system installed on SSD if configured)</li> <li>RAID5, 2 TB (3 x 1 TB HDD, striping with parity), "hot swap" <sup>3)</sup></li> <li>RAID5, 2 TB (3 x 1 TB HDD, striping with parity), "hot swap" <sup>3)</sup> + 1 x 1 TB HDD as hot spare</li> </ul>
DVD±R/RW, 5.25" (slim), SATA	-	<ul style="list-style-type: none"> <li>8 x 8 x 6 x (DVD media)</li> <li>24 x 10 x 16 x (CD media)</li> </ul>
Slots for drives	Internal: <ul style="list-style-type: none"> <li>2 x 3.5"</li> </ul>	Front: <ul style="list-style-type: none"> <li>3 x 5.25" / 4 x low-profile swap frame</li> <li>1 x 5.25" (slimline)</li> </ul> Internal: <ul style="list-style-type: none"> <li>2 x 3.5"</li> </ul>

2

**Technical specifications (continued)**

	<b>IPC547E (enclosure depth 356 mm)</b>	<b>IPC547E (enclosure depth 446 mm)</b>
<b>Interfaces</b>		
Ethernet	1 x Intel Gigabit Ethernet (RJ45)	2 x Intel Gigabit Ethernet (RJ45, teaming-capable)
USB 3.0	• 2 x front (high current)	• 2 x front (high current) • 2 x rear (high current)
USB 2.0	• 6 x rear (high current)	• 6 x rear (high current) • 1 x internal (high current), e.g. for USB dongle with optional interlocking
Serial	9-pin COM2 (V.24) (optional)	9-pole COM1 (V.24); COM2 (V.24) (optional)
Parallel	LPT (optional)	
VGA	Optionally via adapter cable	
DVI-I	1 x	
DisplayPort V1.2	1 x	2 x
PS/2	2 x (keyboard, mouse)	
Audio	1 x Line In; 1 x Line Out; 1 x Mic.	
<b>Monitoring functions</b>		
Basic functionality	Message locally via DiagBase software	
Temperature	When permitted operating temperature range is exceeded	
Fan	Speed monitoring • 1 x front fan • 1 x CPU fan • 1 x power supply fan	
Watchdog	• Monitoring of program execution • Monitoring time can be parameterized in software	
Monitoring functions via the network	SIMATIC IPC DiagMonitor Version V4.4.x.x or higher (optional) Remote monitoring capability for: • Watchdog • Temperature • Fan speed • Battery • Hard disks (SMART) • System/Ethernet Communication: • Ethernet interface (SNMP protocol) • OPC for integration in SIMATIC software • Client server architecture • Structure of log files	
Front LEDs	• POWER (PC switched on) • HDD (access to hard disk) • TEMP (temperature monitoring) • FAN (fan monitoring)	
<b>Ambient conditions</b>		
Degree of protection	IP30 front, IP20 rear according to EN 60529	
Dust protection	With the front door closed according to IEC 60529 filter class G2 EN 779, 99% of particles > 0.5 mm are filtered	
Protection class	Protection class I according to IEC 61140	
Vibration load during operation <sup>4)</sup>	IEC 60068-2-6, 10 cycles • 20 ... 58 Hz: 0.015 mm • 58 ... 200 Hz: 2 m/s <sup>2</sup> (approx. 0.2 g)	
Shock load in operation <sup>4)</sup>	IEC 60068-2-27 • Half-sine: 9.8 m/s <sup>2</sup> , 20 ms (approx. 1 g), 100 shocks per axis	

**PROFINET/Industrial Ethernet**

Industrial PC

Rack PC

**SIMATIC IPC547E****Technical specifications (continued)**

	<b>IPC547E (enclosure depth 356 mm)</b>	<b>IPC547E (enclosure depth 446 mm)</b>
<b>Electromagnetic compatibility (EMC)</b>		
Emitted interference	EN 61000-6-3; EN 61000-6-4; CISPR 22 / EN 55022 Class B; FCC Class A; EN 61000-3-2 Class D; EN 61000-3-3	
Immunity to conducted interference on the supply lines	<ul style="list-style-type: none"> <li>• ± 2 kV (IEC 61000-4-4, burst)</li> <li>• ± 1 kV (IEC 61000-4-5, symm. surge)</li> <li>• ± 2 kV (IEC 61000-4-5, asymm. surge)</li> </ul>	
Noise immunity on signal lines	<ul style="list-style-type: none"> <li>• ±2 kV (IEC 61000-4-4, burst, length &gt; 30 m)</li> <li>• ± 1 kV (IEC 61000-4-4, burst, length &lt; 30 m)</li> <li>• ± 2 kV (IEC 61000-4-5, Surge, Length &gt; 30 m)</li> </ul>	
Immunity to static discharge	<ul style="list-style-type: none"> <li>• ±4 kV, contact discharge (IEC 61000-4-2)</li> <li>• ± 8 kV, air discharge (IEC 61000-4-2)</li> </ul>	
Immunity to high radio frequency interference	<ul style="list-style-type: none"> <li>• 10 V/m; 80 to 1000 MHz, 80 % AM (IEC 61000-4-3)</li> <li>• 3 V/m; 1.4 to 2 GHz, 80 % AM (IEC 61000-4-3)</li> <li>• 1 V/m, 2 to 2.7 GHz, 80 % AM (IEC 61000-4-3)</li> <li>• 10 V, 150 kHz to 80 MHz, 80 % AM (IEC 61000-4-6)</li> </ul>	
Immunity to magnetic fields	30 A/m, 50/60 Hz (IEC 61000-4-8)	
Ambient temperature during operation	5 ... 40 °C	5 ... 40 °C Note: Limitations for operation of DVD±R/RW
Humidity during operation	5 ... 80 % at 25 °C (no condensation)	
<b>Approvals and safety regulations</b>		
Safety regulations	IEC 60950-1; UL60950; CSA	
Approvals	cULus 60950	
CE mark	For use in industrial areas as well as domestic, business and commercial environments: <ul style="list-style-type: none"> <li>• Emitted interference: EN 61000-6-3:2007</li> <li>• Noise immunity: EN 61000-6-2:2005</li> </ul>	
<b>Dimensions and weights</b>		
Installation dimensions (W x H x D) in mm	434 x 177 x 356	434 x 177 x 446
Weight, approx.	15 kg	19 kg

<sup>1)</sup> Memory information: In order to use a memory expansion with more than 4 GB, a 64-bit operating system is required.

<sup>2)</sup> Suitable for specific LINUX versions in accordance with the specifications of the Siemens manufacturer's declaration "Suitable for LINUX", see <http://www.siemens.com/simatic-pc/suited-for-linux> (LINUX is a trademark of Linus Torvald)

<sup>3)</sup> SATA RAID controller onboard in Intel Q87 chipset

<sup>4)</sup> Restrictions with operation of optical drives and hard disks in swap frames

**Note regarding SIMATIC PC operating system licenses**

The accompanying operating system license is only valid for installation on the respective supplied SIMATIC IPC. Installation can only be performed on these SIMATIC systems in accordance with Microsoft OEM licensing regulations.



Ordering data	Article No.	Article No.
<b>SIMATIC IPC547E<sup>1)</sup></b>	<b>6AG4104 - 3</b>	<b>SIMATIC IPC547E<sup>1)</sup></b>
<b>Interfaces:</b> 2 x USB 3.0 at the front, 1 x DVI-I, 6 x USB 2.0 at the rear, 2 x PS/2, audio; 7 slots: 2 x PCIe x16, 1 x PCIe x8, 4 x PCI; temperature and fan monitoring; watchdog; card retainers;		<b>Memory configuration</b> • 2 GB DDR3 SDRAM (1 x 2 GB), single channel; • 4 GB DDR3 SDRAM (2 x 2 GB), dual channel; • 8 GB DDR3 SDRAM <sup>2)</sup> (2 x 4 GB), dual channel; • 16 GB DDR3 SDRAM <sup>2)</sup> (2 x 8 GB), dual channel; • 32 GB DDR3 SDRAM <sup>2)</sup> (4 x 8 GB), dual channel;
<b>Processors and mainboards</b>		<b>Type of enclosure and swap media</b> • Enclosure (short), painted on the front, no removable media; • Enclosure, painted on the front, no removable media; • Enclosure, painted on the front, + DVD±RW (slimline); • Unpainted enclosure, no remov- able media; • Painted enclosure, + DVD±RW (slimline);
• Celeron G1820 (2C/2T, 2.7 GHz, 2 MB cache); 1 x Gigabit Ethernet (IE/PN), 1 x DisplayPort V1.2 (only in combination with short enclosure)	A	<b>Expansions (hardware)</b> • Without expansions (hardware), onboard graphics; • Without expansions (hardware), onboard graphics; DVI-I adapter cable, VGA-compliant for onboard graphics; • Serial (COM2) & parallel (LPT), onboard graphics; • Serial (COM2) and parallel (LPT), onboard graphics; DVI-I adapter cable, VGA-compliant for onboard graphics; • Serial (COM2) & parallel (LPT) + PCIe x16 graphics card (Dual Head: 2 x VGA or 2 x DVI-D), 512 MB;
• Pentium Dual Core G3420 (2C/2T, 3.2 GHz, 3 MB cache); 1 x Gigabit Ethernet (IE/PN), 1 x DisplayPort V1.2 (only in combination with short enclosure)	C	0
• Pentium Dual Core G3420 (2C/2T, 3.2 GHz, 3 MB cache); 2 x Gigabit Ethernet (IE/PN), 2 x DisplayPort V1.2, 2 x USB 3.0 at rear, 1 x USB 2.0 internal, 1 x COM1;	D	1
• Core i5-4570S (4C/4T, 2.9 (3.6) GHz, 6 MB cache, iAMT); 2 x Gigabit Ethernet (IE/PN), 2 x DisplayPort V1.2, 2 x USB 3.0 at rear, 1 x USB 2.0 internal, 1 x COM1;	H	2
• Core i7-4770S (4C/8T, 3.1 (3.9) GHz, 8 MB cache, iAMT); 2 x Gigabit Ethernet (IE/PN), 2 x DisplayPort V1.2, 2 x USB 3.0 at rear, 1 x USB 2.0 internal, 1 x COM1;	K	3
<b>Drives (SATA)</b>		4
• 1 x 500 GB HDD, internal;	A	<b>Operating systems</b> <b>(preinstalled and activated)</b> • Windows 7 Ultimate, MUI (Eng, Ger, Fr, It, Sp), 32-bit, SP1; • Windows 7 Ultimate, MUI (Eng, Ger, Fr, It, Sp), 64-bit, SP1; • Windows Server 2008 R2 Stan- dard Edition incl. 5 clients, MUI (Eng, Ger, Fr, It, Sp), 64-bit, SP1; • Without operating system;
• 1 x 1 TB HDD, internal;	B	A
• 2 x 1 TB HDD, internal;	D	B
• 1 x 240 GB SSD, internal;	E	F
• RAID1, 1 TB (2 x 1 TB HDD, mirror disks), internal;	G	X
• 1 x 500 GB HDD in removable drive bay, at the front;	H	
• 1 x 1 TB HDD in removable drive bay, at the front;	K	
• 2 x 1 TB HDD in removable drive bay, at the front;	M	
• 1 x 240 GB SSD in removable drive bay, at the front;	N	A
• RAID1, 1 TB (2 x 1 TB HDD, mirror disks) in removable drive bay, hot swap, at the front;	P	B
• RAID1, 1 TB (2 x 1 TB HDD, mirror disks) in removable drive bay; hot swap + 1 x 1 TB HDD as hot spare in removable drive bay, at the front;	Q	C
• RAID1, 1 TB (2 x 1 TB HDD, mirror disks) in removable drive bay, hot swap + 240 GB SSD in removable drive bay, at the front (operating system installed on SSD if config- ured);	R	X
• RAID5, 2 TB (3 x 1 TB HDD, striping with parity) in removable drive bay, hot swap, at the front;	S	Y
• RAID5, 2 TB (3 x 1 TB HDD, striping with parity) in removable drive bay, hot swap + 1 x 1 TB HDD as hot spare in removable drive bay, at the front;	T	
		<b>Expansions (software)</b> • SIMATIC IPC DiagMonitor V4.4 software included; • SIMATIC IPC Image & Partition Creator V3.3 software included; • SIMATIC IPC DiagMonitor V4.4 + Image & Partition Creator V3.3 software included; • Without expansions (software); • Without expansions (software) / TPM (not for China and Russia);
		<b>Country-specific versions/ power supplies:</b> • 100/240 V AC industrial power supply, Europe power cable; • 100/240 V AC industrial power supply, USA power cable; • 100/240 V AC industrial power supply, China power cable; • 2 x 100/240 V AC redundant industrial power supply, without power cable;
		0
		4
		5
		6

<sup>1)</sup> For an up-to-date overview, see the SIMATIC PC Online Configurator at:  
<https://www.siemens.com/ipc-configurator>

<sup>2)</sup> Can only be used with 64-bit operating systems

**PROFINET/Industrial Ethernet****Industrial PC****Rack PC****SIMATIC IPC547E****Ordering data****Article No.****Article No.***Preferred variants (ex-stock)***SIMATIC IPC547E**

- Pentium Dual Core G3420 (2C/2T, 3.2 GHz, 3 MB cache); 2x USB 3.0 on front, 6x USB 2.0 at the rear, 1x Gbit Ethernet, 1x DisplayPort V1.2, 1x DVI-I, 2x PS/2, audio; painted enclosure (short) no removable media; 1x 1 TB HDD, internal (0.2 g vibration, 1 g shock); 2 GB DDR3 SDRAM (1x 2 GB), single-channel; serial (COM2) + parallel (LPT), onboard graphics, DVI-I adapter cable VGA-compliant for onboard graphics; without operating system; without expansions (software); 100/240 V AC industrial power supply, Europe power cable;
- Pentium Dual Core G3420 (2C/2T, 3.2 GHz, 3 MB cache); 2x USB 3.0 on front, 2x USB 3.0 and 6x USB 2.0 at the rear, 1x USB 2.0 internal, 2x Gbit Ethernet, 2x DisplayPort V1.2, 1x DVI-I, 1x COM1, 2x PS/2, Audio; painted enclosure + DVD±RW (slimline); 1x 1 TB HDD, internal; 4 GB DDR3 SDRAM (2x 2 GB), dual channel; serial (COM2) + parallel (LPT), onboard graphics, DVI-I adapter cable VGA-compliant for onboard graphics; without operating system; without expansions (software); 100/240 V AC industrial power supply, Europe power cable;
- Core i5-4570S (4C/4T, 2.9 (3.6) GHz, 6 MB cache, iAMT); 2x USB 3.0 on front, 2x USB 3.0 and 6x USB 2.0 at the rear, 1x USB 2.0 internal, 2x Gbit Ethernet, 2x DisplayPort V1.2, 1x DVI-I, 1x COM1, 2x PS/2, Audio; painted enclosure + DVD±RW (slimline); RAID1, 1 TB (2x 1 TB HDD, mirror disks) in the removable drive bay, hot-swap, on front; 4 GB DDR3 SDRAM (2x 2 GB), dual channel; serial (COM2) + parallel (LPT), onboard graphics, DVI-I adapter cable VGA-compliant for onboard graphics; Windows 7 Ultimate, Multi Language (Eng, Ger, Fr, It, Sp), 32-bit, SP1; without expansions (software); 100/240 V AC industrial power supply, Europe power cable;
- Core i7-4770S (4C/8T, 3.1 (3.9) GHz, 8 MB cache, iAMT); 2x USB 3.0 on front, 2x USB 3.0 and 6x USB 2.0 on rear, 1x USB 2.0 internal, 2x Gbit Ethernet, 2x DisplayPort V1.2, 1x DVI-I, 1x COM1, 2x PS/2, audio; painted enclosure + DVD±RW (slimline); RAID1, 1 TB (2x 1 TB HDD, mirror disks) in removable drive bay, hot-swap, on front; 8 GB DDR3 SDRAM (2x 4 GB), dual channel; serial (COM2) + parallel (LPT) + PCIe x16 graphics card (dual-head); 2x VGA or 2x DVI-D), 512 MB; Windows 7 Ultimate, multi-language (En, Ger, Fr, It, Sp), 64-bit, SP1; without expansions (software); 2x 100/240 V AC redundant industrial power supply, without power cable;

**6AG4104-3CB10-3XX0****6AG4104-3DB24-3XX0****6AG4104-3HP24-3AX0****6AG4104-3KP34-4BX6***Accessories***Memory expansion**

- 2 GB DDR3 SDRAM (1 x 2 GB)
- 4 GB DDR3 SDRAM (1 x 4 GB)
- 8 GB DDR3 SDRAM (1 x 8 GB)

**6ES7648-2AJ50-0MA0****6ES7648-2AJ60-0MA0****6ES7648-2AJ70-0MA0****Tower Kit**

For converting the computer into an industrial tower PC

**6ES7648-1AA00-0XC0****Retainer**

for interlocking the internal USB port

**6ES7648-1AA00-0XK0****Adapter cable**

- DisplayPort to DVI-D for onboard graphics
- DisplayPort to VGA for onboard graphics

**6ES7648-3AF00-0XA0****6ES7648-3AG00-0XA0****Power cable, straight, 3 m long**

- Austria, Belgium, Finland, France, Germany, Netherlands, Spain, Sweden
- United Kingdom
- Switzerland
- USA
- Italy
- China

**6ES7900-0AA00-0XA0****6ES7900-0BA00-0XA0****6ES7900-0CA00-0XA0****6ES7900-0DA00-0XA0****6ES7900-0EA00-0XA0****6ES7900-0FA00-0XA0****Rack unit for low-profile removable drive bay**

for 3.5" hard drive (SATA/SAS) and 2.5" SSD (SATA), without drive

**6ES7648-0EG01-1BA0**

See catalog ST 80/ST PC

*Expansion components*

See Expansion components

Note:

Software Packages with SIMATIC WinCC flexible, SIMATIC WinCC RT Advanced, SIMATIC WinCC, and SIMATIC WinAC RTX (F) can be ordered together with the SIMATIC IPC at favorable prices.

More information under "Embedded Bundles / Packages for industrial PCs".

**More information**

Further information can be found in the Internet at:

<http://www.siemens.com/simatic-pc>

## Overview



The SIMATIC IPC547D is a rugged industrial PC in 19" rack design (4 U).

It offers:

- Maximum performance
- Attractive price
- Intel Core i technology

## Benefits

### **Maximum system performance for complex automation and visualization tasks**

- State-of-the-art PC technology (e.g. Intel Core i processors 2nd generation with Turbo Boost 2.0, hyper-threading and virtualization technology)
- Memory and graphics controller integrated into processor for extraordinary memory and graphics performance
- Maximum performance (e.g. Intel Q67 chipset, DDR3 1333 memory with support of dual channel technology)
- High data transfer rates (e.g. with serial ATA Solid-State Drive (SLC) with 50 GB, serial ATA hard disks up to 1 TB, Dual Gigabit Ethernet, PCI-Express 2.0 technology)

### **Reduction in downtimes through high system availability**

- Secure 24-hour operation (high MTBF, variable-speed fan)
- Efficient self-diagnostics (front status LEDs for fan and temperature, SIMATIC IPC DiagMonitor)
- High degree of data security due to RAID1 (mirror disks system) or RAID5 (striping with parity)
- "Hot swap" removable drive bay in RAID configuration (replacement of hard disk during operation)
- Fast identification and replacement of the hard disk in the event of a fault by means of HDD alarm LEDs for RAID configurations
- Solid-State Drive (SSD) in single level cell (SLC) architecture
- Redundant power supply with "hot swap" functionality (replacement of power supply module during operation)

### **High flexibility and user friendliness during commissioning, operation and service**

- Preinstalled and activated operating system
- IAMT (Intel Active Management Technology) functionality for remote access to the IPC (remote maintenance)
- Fast restoration of the delivery status of the hard disk(s) thanks to restore DVD
- Low noise output thanks to controlled fans
- Universal implementation as an industrial workstation or server
- RAID1/RAID5 onboard (a PCI slot is not occupied by the RAID Controller)
- Flexible applications in many different positions with telescopic rails or as tower industrial PC.
- High degree of flexibility and expandability thanks to integrated interfaces and 7 slots (PCI and PCI-Express)

### **High industrial compatibility and compactness for 24-hour use in an industrial environment**

- Maximum processor performance (in maximum configuration) without loss of power (throttling) at ambient temperatures of up to 40 °C
- Distinct product design with fully-coated, dirt-resistant surfaces
- Metal enclosure with a high degree of electromagnetic compatibility for use in industrial areas and in domestic, business and commercial environments
- Suitable for installing in space-saving control cabinets only 500 mm deep
- Dust protection thanks to overpressure ventilation concept with fan on the front and dust filter
- Special hard disk holders and card retainers for protection against vibration and shock

### **Cost reductions through high investment security**

- Availability of at least 1.5 years, guaranteed availability of spare parts for 3 years
- System-tested with SIMATIC components
- Certification for worldwide marketing (cULus)
- Support for legacy interfaces (PS/2, COM, LPT)
- Installation compatible for many device generations
- Worldwide service and support

**PROFINET/Industrial Ethernet**

Industrial PC

Rack PC

**SIMATIC IPC547D****Technical specifications**

	<b>SIMATIC IPC547D</b>	<b>SIMATIC IPC547D</b>
<b>General features</b>		
Design	19" rack, 4 U, externally painted	
Processor	<ul style="list-style-type: none"> <li>Intel Core i7-2600 (4C/8T, 3.40 GHz, 8 MB Last Level Cache, Turbo Boost 2.0, EM64T, VT-x/-d, iAMT)</li> <li>Intel Core i5-2400 (4C/4T, 3.10 GHz, 6 MB Last Level Cache, Turbo Boost 2.0, EM64T, VT-x/-d, iAMT)</li> <li>Intel Pentium Dual Core G850 (2C/2T, 2.90 GHz, 3 MB Last Level Cache, EM64T, VT)</li> </ul>	Installation in internal drive support <ul style="list-style-type: none"> <li>500 GB</li> <li>1 TB</li> <li>RAID1<sup>2)</sup> <ul style="list-style-type: none"> <li>1 TB (2 x 1 TB, mirror disks)</li> </ul> </li> <li>50 GB solid-state drive</li> </ul> Installation at the front in removable drive bay (low profile) <ul style="list-style-type: none"> <li>500 GB</li> <li>2 x 500 GB</li> <li>RAID1<sup>2)</sup> 1 TB               <ul style="list-style-type: none"> <li>2 x 1 TB, mirror disks), "hot swap"</li> </ul> </li> <li>RAID5<sup>2)</sup> 2 TB               <ul style="list-style-type: none"> <li>(3 x 1 TB, striping with parity), "hot swap"</li> </ul> </li> <li>50 GB solid-state drive</li> <li>RAID1<sup>2)</sup> <ul style="list-style-type: none"> <li>1 TB (2 x 1 TB, mirror disks), "hot swap" + 50 GB solid-state drive (operating system installed on SSD if configured)</li> </ul> </li> </ul>
Chipset	<ul style="list-style-type: none"> <li>Intel Q67</li> </ul>	
Main memory	<ul style="list-style-type: none"> <li>From 1 GB DDR3 1333 SDRAM</li> <li>Dual channel support</li> <li>4 DIMM base</li> <li>Expandable up to 32 GB<sup>1)</sup></li> </ul>	
Spare slots for expansions (all long)	<ul style="list-style-type: none"> <li>4 x PCI</li> <li>1 x PCI Express x16</li> <li>1 x PCI-Express x16 (4 lanes)</li> <li>1 x PCI-Express x8 (1 lane)</li> </ul>	
Graphic	<ul style="list-style-type: none"> <li>Onboard Intel HD 2000 graphics controller integrated into the processor; Shared Video Memory up to 1.7 GB; up to 2560 x 1600 pixels at 60 Hz image refresh rate and 32-bit colors</li> <li>PCI Express graphics card (Dual Head: 2 x VGA or 2 x DVI-D) in the PCIe x16 slot; 512 MB; up to 2048 x 1536 pixels at 85 Hz image refresh rate and 32 bit colors (optional)</li> </ul>	DVD-ROM, 5.25", SATA  DVD±R/RW, 5.25", SATA  Slots for drives  Front: <ul style="list-style-type: none"> <li>3 x 5.25"</li> <li>1 x 3.5"</li> </ul> Internal: <ul style="list-style-type: none"> <li>2 x 3.5"</li> </ul>
Operating system	<ul style="list-style-type: none"> <li>Without</li> </ul> Preinstalled and activated (supplied on restore DVD): <ul style="list-style-type: none"> <li>Windows XP Professional MUI (32-bit)</li> <li>Windows 7 Ultimate MUI (32/64-bit)</li> <li>Windows Server 2008               <ul style="list-style-type: none"> <li>incl. 5 Client MUI (32 bit)</li> </ul> </li> <li>Windows Server 2008 R2               <ul style="list-style-type: none"> <li>incl. 5 Client MUI (64 bit)</li> </ul> </li> </ul> MUI (Multilanguage User Interface, 5 languages): English, German, French, Italian, Spanish Project-specific on request: <ul style="list-style-type: none"> <li>Linux<sup>3)</sup></li> <li>Other</li> </ul>	<b>Ports</b>  Ethernet  USB 2.0  Serial  Parallel  VGA  DVI-I  DisplayPort  Keyboard  Mouse  Audio  2 x Intel Gbit Ethernet (RJ45, teaming-capable)  <ul style="list-style-type: none"> <li>2 x front (high current)</li> <li>8 x rear (high current)</li> <li>1 x internal (high current), e.g. for USB dongle with optional interlocking</li> </ul> 9-pole COM1 (V.24); COM2 (V.24) (optional)  LPT (optional)  Optionally via adapter cable  1 x  1 x  PS/2  PS/2  1 x Line In; 1 x Line Out; 1 x Mic.
Power supply	<ul style="list-style-type: none"> <li>100 ... 240 V AC, 50 ... 60 Hz, with bridging of short-term power failures: max. 20 ms at 0.85% rated voltage</li> <li>Redundant 100 ... 240 V AC, 50 ... 60 Hz</li> </ul>	

2

**Technical specifications (continued)**

SIMATIC IPC547D	
<b>Monitoring functions</b>	
Basic functionality	Message locally via DiagBase software
Temperature	When permitted operating temperature range is exceeded
Fan	Speed monitoring <ul style="list-style-type: none"> <li>• 1 x front fan</li> <li>• 1 x CPU fan</li> <li>• 1 x power supply fan</li> </ul>
Watchdog	<ul style="list-style-type: none"> <li>• Monitoring of program execution</li> <li>• Monitoring time can be parameterized in software</li> </ul>
Monitoring functions via the network	SIMATIC IPC DiagMonitor Version V4.3.x.x or higher (optional) Remote monitoring capability for: <ul style="list-style-type: none"> <li>• Watchdog</li> <li>• Temperature</li> <li>• Fan speed</li> <li>• Battery</li> <li>• Hard disks (SMART)</li> <li>• System/Ethernet</li> </ul> Communication: <ul style="list-style-type: none"> <li>• Ethernet interface (SNMP protocol)</li> <li>• OPC for integration in SIMATIC software</li> <li>• Client server architecture</li> <li>• Structure of log files</li> </ul>
Front LEDs	<ul style="list-style-type: none"> <li>• POWER (PC switched on)</li> <li>• HDD (access to hard disk)</li> <li>• TEMP (temperature monitoring)</li> <li>• FAN (fan monitoring)</li> </ul> Additional HDD alarm LEDs for RAID configurations behind the front flap
<b>Environmental conditions</b>	
Degree of protection	IP30 front, IP20 rear according to EN 60529
Dust protection	With the front door closed according to IEC 60529 filter class G2 EN 779, 99% of particles > 0.5 mm are filtered
Protection class	Protection class I according to IEC 61140
Vibration load during operation <sup>4)</sup>	IEC 60068-2-6, 10 cycles <ul style="list-style-type: none"> <li>• 20 ... 58 Hz: 0.015 mm</li> <li>• 58 ... 200 Hz: 2 m/s<sup>2</sup> (approx. 0.2 g)</li> </ul>
Shock load in operation <sup>4)</sup>	IEC 60068-2-27 <ul style="list-style-type: none"> <li>• Half-sine: 9.8 m/s<sup>2</sup>, 20 ms (approx. 1 g), 100 shocks per axis</li> </ul>

SIMATIC IPC547D	
<b>Electromagnetic compatibility (EMC)</b>	
Emitted interference	EN 61000-6-3; EN 61000-6-4; CISPR 22 / EN 55022 Class B; FCC Class A; EN 61000-3-2 Class D; EN 61000-3-3
Immunity to conducted interference on the supply lines	<ul style="list-style-type: none"> <li>• ± 2 kV (IEC 61000-4-4, burst)</li> <li>• ± 1 kV (IEC 61000-4-5, symm. surge)</li> <li>• ± 2 kV (IEC 61000-4-5, asymm. surge)</li> </ul>
Noise immunity on signal lines	<ul style="list-style-type: none"> <li>• ± 2 kV (IEC 61000-4-4, burst, length &gt; 30 m)</li> <li>• ± 1 kV (IEC 61000-4-4, Burst, Length &lt; 30 m),</li> <li>• ± 2 kV (IEC 61000-4-5, Surge, Length &gt; 30 m)</li> </ul>
Immunity to static discharge	<ul style="list-style-type: none"> <li>• ± 4 kV, contact discharge (IEC 61000-4-2)</li> <li>• ± 8 kV, air discharge (IEC 61000-4-2)</li> </ul>
Immunity to high radio frequency interference	<ul style="list-style-type: none"> <li>• 1 V/m 80% AM; 2 ... 2.7 GHz (IEC 61000-4-3)</li> <li>• 10 V/m 80% AM; 80 MHz ... 1 GHz and 1.4 GHz ... 2 GHz (IEC 61000-4-3);</li> <li>• 10 V, 10 kHz ... 80 MHz (IEC 61000-4-6)</li> </ul>
Immunity to magnetic fields	100 A/m, 50/60 Hz (IEC 61000-4-8)
Ambient temperature during operation	5 ... 40 °C Note: Limitations for operation of DVD±R/RW
Humidity during operation	5 ... 80 % at 25 °C (no condensation)
<b>Approvals and safety regulations</b>	
Safety regulations	IEC 60950-1; UL60950; CSA
Approvals	cULus 60950
CE mark	For use in industrial areas as well as domestic, business and commercial environments: <ul style="list-style-type: none"> <li>• Emitted interference: EN 61000-6-3:2007</li> <li>• Noise immunity: EN 61000-6-2:2005</li> </ul>
<b>Dimensions and weights</b>	
Installation dimensions (W x H x D) in mm	434 x 177 x 446
Weight, approx.	19 kg

<sup>1)</sup> Memory information:

In order to use a memory with more than 4 GB, a 64-bit operating system is required. In the case of configurations with 4 GB, the visible memory can be reduced to about 3.5 GB or less (with 32-bit operating systems). In configurations with 8 GB, the visible memory can be reduced to about 7.5 GB or less.

<sup>2)</sup> SATA RAID controller onboard in Intel Q67 chipset

<sup>3)</sup> Suitable for specific LINUX versions in accordance with the specifications of the Siemens manufacturer's declaration "Suitable for LINUX", see <http://www.siemens.com/simatic-pc/suited-for-linux> (LINUX is a trademark of Linus Torvalds).

<sup>4)</sup> Restrictions in use of optical drives and HDD in removable drive bays.

**Note regarding SIMATIC PC operating system licenses**

The accompanying operating system license is only valid for installation on the respective supplied SIMATIC IPC. Installation can only be performed on these SIMATIC systems in accordance with Microsoft OEM licensing regulations.

# PROFINET/Industrial Ethernet

## Industrial PC

### Rack PC

#### SIMATIC IPC547D

#### Ordering data

#### Article No.

#### SIMATIC IPC547D <sup>3)</sup>

6AG4104 - 2 ■ ■ ■ ■ ■ - ■ ■ ■ ■ ■

#### Interfaces:

2 x Gbit Ethernet (RJ45),  
1 x DisplayPort,  
1 x DVI-I, 8 x USB on the rear,  
2 x USB on the front,  
1 x USB internal, 1 x serial (COM1),  
2 x PS/2, audio;  
7 slots (all long):  
4 x PCI, 1 x PCIe x16,  
1 x PCIe x16 (4 lanes),  
1 x PCIe x8 (1 lane);  
mounting locations: 6 (3 x 5.25",  
1 x 3.5" externally accessible,  
2 x 3.5" internal);  
temperature and fan monitoring;  
watchdog; card retainer

#### Processors

- Pentium Dual Core G850 (2C/2T, 2.90 GHz, 3 MB Last Level Cache, EM64T, VT) **A**
- Core i5-2400 (4C/4T, 3.10 GHz, 6 MB Last Level Cache, Turbo Boost 2.0, EM64T, VT-x/-d, iAMT) **C**
- Core i7-2600 (4C/8T, 3.40 GHz, 8 MB Last Level Cache, Turbo Boost 2.0, EM64T, VT-x/-d, iAMT) **D**

#### Drives

- 500 GB HDD SATA; internal **A**
- 1 TB HDD SATA; internal **B**
- RAID1, 1 TB (2 x 1 TB HDD SATA, mirror disks); internal <sup>1)</sup> **D**
- 50 GB solid-state drive (SLC) SATA; internal **E**
- 500 GB HDD SATA in removable drive bay; front **G**
- 2 x 500 GB HDD SATA in removable drive bay; front **H**
- RAID1, 1 TB (2 x 1 TB HDD SATA, mirror disks) in removable drive bay; for hot swapping; at the front **P**
- RAID5, 2 TB (3 x 1 TB HDD SATA, striping with parity) in removable drive bay; for hot swapping; at the front **R**
- 50 GB solid-state drive (SLC) SATA in removable drive bay; at the front **S**
- RAID1, 1 TB (2 x 1 TB HDD SATA, mirror disks) in removable drive bay; hot swapping; at the front + 50 GB solid-state drive (SLC) SATA in removable drive bay; at the front (operating system installed on SSD, if configured) **T**

#### Memory configuration

- 1 GB DDR3 SDRAM (1 x 1 GB), single channel **0**
- 2 GB DDR3 SDRAM (2 x 1 GB), dual channel **1**
- 4 GB DDR3 SDRAM (2 x 2 GB), dual channel **2**
- 8 GB DDR3 SDRAM <sup>2)</sup> (2 x 4 GB), dual channel **3**
- 16 GB DDR3 SDRAM <sup>2)</sup> (4 x 4 GB), dual channel **4**
- 32 GB DDR3 SDRAM <sup>2)</sup> (4 x 8 GB), dual channel **5**

#### Article No.

#### SIMATIC IPC547D <sup>3)</sup>

6AG4104 - 2 ■ ■ ■ ■ ■ - ■ ■ ■ ■ ■

#### Removable media

- DVD-ROM **1**
- DVD±RW **2**

#### Expansions (hardware)

- Without expansions (HW); onboard graphics **0**
- No expansions (HW); onboard graphics; DVI-I VGA-compliant adapter cable for onboard graphics **1**
- Serial (COM2) & parallel (LPT); onboard graphics **2**
- Serial (COM2) and parallel (LPT); onboard graphics; DVI-I VGA-compliant adapter cable for onboard graphics **3**
- Serial (COM2) & parallel (LPT) + PCIe x16 graphics card (Dual Head: 2 x VGA or 2 x DVI-D), 512 MB **4**

#### Operating systems (preinstalled and activated)

- Windows XP Professional, MUI (Eng, Ger, Fr, It, Sp), 32-bit, SP3 **B**
- Windows 7 Ultimate, MUI (Eng, Ger, Fr, It, Sp), 32-bit, SP1 **E**
- Windows 7 Ultimate, MUI (Eng, Ger, Fr, It, Sp), 64-bit, SP1 **F**
- Windows Server 2008 Standard Edition incl. 5 Client, MUI (Eng, Ger, Fr, It, Sp), 32 bit, SP2 **P**
- Windows Server 2008 R2 Standard Edition including 5 clients, MUI (Eng, Ger, Fr, It, Sp), 64-bit, SP1 **Q**
- Without operating system **X**

#### Expansions (software)

- SIMATIC IPC DiagMonitor V4.3 software included **A**
- SIMATIC IPC Image & Partition Creator V3.2 software included **B**
- SIMATIC IPC DiagMonitor V4.3 + Image & Partition Creator V3.2 software included **C**
- Without expansions (software) **X**

#### Power supply, with country-specific cable:

- 100/240 V AC industrial power supply; power cable for Europe **0**
- 100/240 V AC industrial power supply; USA power cable **4**
- 100/240 V AC industrial power supply; power cable for China **5**
- 2 x 100/240 V AC redundant industrial power supply; without power cable **6**

<sup>1)</sup> Not in combination with redundant power supply

<sup>2)</sup> Can only be used on 64-bit operating systems

<sup>3)</sup> For an up-to-date overview, see the SIMATIC PC online configurator at: [www.siemens.com/ipc-configurator](http://www.siemens.com/ipc-configurator)

Ordering data	Article No.	Article No.
<i>Preferred variants (ex-stock)</i>		<i>Accessories</i>
<b>SIMATIC IPC547D</b>		<b>Memory expansion</b>
<ul style="list-style-type: none"> <li>Pentium Dual Core G850 (2C/2T, 2.90 GHz, 3 MB Last Level Cache, EM64T, VT); 500 GB HDD SATA internal; 1 GB DDR3 SDRAM (1 x 1 GB), single channel; DVD-ROM; interfaces: 2 x Gbit Ethernet (RJ45), 1 x serial, 8 x USB rear, 2 x USB front, 1 x USB internal, 2 x PS/2, audio; 100/240 V industrial power supply, power cable for Europe; without operating system</li> </ul>	<b>6AG4104-2AA01-0XX0</b>	<ul style="list-style-type: none"> <li>1 GB DDR3 1333 SDRAM, DIMM (1 x 1 GB) <b>6ES7648-2AJ40-0LA0</b></li> <li>2 GB DDR3 1333 SDRAM, DIMM, kit for dual-channel technology (2 x 1 GB) <b>6ES7648-2AJ50-0LB0</b></li> <li>4 GB DDR3 1333 SDRAM, DIMM, kit for dual-channel technology (2 x 2 GB) <b>6ES7648-2AJ60-0LB0</b></li> <li>8 GB DDR3 1333 SDRAM, DIMM, kit for dual-channel technology (2 x 4 GB) <b>6ES7648-2AJ70-0LB0</b></li> </ul>
<ul style="list-style-type: none"> <li>Core i5-2400 (4C/4T, 3.10 GHz, 6 MB Last Level Cache, Turbo Boost 2.0, EM64T, VT-x/-d, iAMT); RAID1, 1 TB (2 x 1 TB HDD SATA, mirror disks) in removable drive bay, for hot swapping, at the front; 4 GB DDR3 SDRAM (2 x 2 GB) dual channel; DVD±RW; interfaces: 2 x Gbit Ethernet (RJ45), 2 x serial, 1 x parallel, 8 x USB rear, 2 x USB front, 1 x USB internal, 2 x PS/2, Audio; 100/240 V industrial power supply, power cable for Europe; without operating system</li> </ul>	<b>6AG4104-2CP22-2XX0</b>	<b>Tower Kit</b> For converting the computer into an industrial tower PC <b>6ES7648-1AA00-0XC0</b>
<ul style="list-style-type: none"> <li>Core i7-2600 (4C/8T, 3.40 GHz, 8 MB Last Level Cache, Turbo Boost 2.0, EM64T, VT-x/-d, iAMT); RAID1, 1 TB (2 x 1 TB HDD SATA, mirror disks) in removable drive bay, for hot swapping, at the front; 8 GB DDR3 SDRAM (2 x 4 GB) dual channel; DVD±RW; interfaces: 2 x Gbit Ethernet (RJ45), 2 x serial, 1 x parallel, 8 x USB rear, 2 x USB front, 1 x USB internal, 2 x PS/2, audio; 100/240 V industrial power supply, power cable for Europe, Windows 7 Ultimate MUl (Eng, Ger, Fr, It, Sp), 64-bit, SP1 supplied</li> </ul>	<b>6AG4104-2DP32-2FX0</b>	<b>Retainer</b> for pin assignment of the internal USB port <b>6ES7648-1AA00-0XK0</b>
		<b>Power cable, straight, 3 m long</b> <ul style="list-style-type: none"> <li>Austria, Belgium, Finland, France, Germany, Netherlands, Spain, Sweden <b>6ES7900-0AA00-0XA0</b></li> <li>United Kingdom <b>6ES7900-0BA00-0XA0</b></li> <li>Switzerland <b>6ES7900-0CA00-0XA0</b></li> <li>USA <b>6ES7900-0DA00-0XA0</b></li> <li>Italy <b>6ES7900-0EA00-0XA0</b></li> <li>China <b>6ES7900-0FA00-0XA0</b></li> </ul>
		<b>Rack unit for low-profile HDD removable drive bay</b> for 3.5" hard disk, SATA (without hard disk) <b>6ES7648-0EG00-1BA0</b>
		<b>Expansion components</b> See catalog ST 80 / ST PC
		<b>Note:</b> Software Packages with SIMATIC WinCC flexible, SIMATIC WinCC RT Advanced, SIMATIC WinCC, and SIMATIC WinAC RTX (F) can be ordered together with the SIMATIC IPC at favorable prices. More information under "Embedded Bundles / Packages for industrial PCs".

### More information

Further information can be found on the Internet at:

<http://www.siemens.com/simatic-pc>

**PROFINET/Industrial Ethernet**

Industrial PC  
Rack PC

**SIMATIC IPC647D****Overview**

IPC 647D front view

The SIMATIC IPC647D is a very rugged, high-performance industrial PC in 19" rack design (2 U) with excellent industrial functionality.

It offers:

- Extreme compactness
- Extreme ruggedness
- 4th generation Intel® Core™ i technology

**Benefits*****Extremely compact and industry-compatible for 24-hour continuous use in an industrial environment***

- Compact enclosure design (2 HMs)
- Suitable for installing in space-saving control cabinets only 500 mm deep
- Maximum processor performance (in maximum configuration) without loss of power (throttling) at ambient temperatures of up to 50 °C
- Distinct product design with new front design and fully-coated, dirt-resistant surfaces
- All-metal housing with high EMC for use in industrial environment
- Dust protection thanks to overpressure ventilation concept with fan on the front and dust filter
- Special hard disk holders and card retainers for protection against vibration and shock

***High productivity thanks to faster data processing***

- 4th generation Intel® processors: Xeon, Core i5 or Core i3 with turbo-boost, hyper-threading and virtualization technology
- Graphics controller (HD 4600 graphics) integrated in the processor for exceptionally high graphics performance
- Maximum performance (e.g. Intel C226 Express chipset, DDR3 memory with the support of dual-channel technology)
- High data transfer rates (e.g. PCI-Express technology: Gen 2 and Gen 3, USB 3.0 SuperSpeed (500 Mbit/s), SATA III / 6 Gbit/s)

***Reduction in downtimes through high system availability***

- Secure 24-hour operation (high MTBF, variable-speed fan) at ambient temperature up to 50 °C
- High degree of data security thanks to RAID configurations (RAID controllers onboard)
- RAID1 configuration: data mirroring on two SATA hard disks, also in hot-removable drive bay
- "Hot swap" HDD in removable drive bay in RAID configurations (replacement of hard disk during operation)
- Fast identification and replacement of the hard disk in the event of a fault by means of HDD alarm LEDs for RAID configurations and unambiguous numbering
- Status display (front LEDs) for Ethernet and PROFIBUS or PROFINET; alarm indication for fan, temperature, watchdog and hard disks in RAID1/5 configurations
- Efficient self-diagnostics per SIMATIC PC DiagBased or DiagMonitor software (optional)
- Remote control and maintenance with iAMT 9.0 (Intel® Active Management Technology)
- Solid-state drive (SSD) in multi-level cell (MLC) architecture and ECC memory (optional)
- Redundant power supply with "hot swap" functionality (replacement of power supply module during operation)
- Redundant gigabit LAN connections (teaming capability)
- Securing of the replaceable components at the front (e.g. USB software dongle) against unauthorized access by means of a lockable door
- Locked fan cover: Filter mat and front fan can only be replaced when front door is open
- The enclosure cover can only be opened if the front door is open
- Secure internal USB slot in device for software dongle, for example
- Service-friendly device design (modifications, service) e.g. filter replacement or front fan replacement without tools

***Cost reductions through high investment security***

- Availability of 3 to 6 years, guaranteed availability of spare parts for 5 years
- System-tested with SIMATIC components
- Certification for worldwide marketing (cULus)
- Support for legacy interfaces (PS/2, COM, LPT)
- Installation compatible for many device generations
- Worldwide service and support

***Reduced costs due to time savings for commissioning, operation and servicing***

- High degree of flexibility and expandability thanks to integrated interfaces and up to 4 slots (PCI and PCI-Express)
- Preinstalled and activated operating system
- Fast restoration of the delivery status of the HDD thanks to restore DVD
- Low noise output thanks to controlled fan
- Universal implementation as an industrial workstation or server
- PROFIBUS or PROFINET interface and RAID1 controller onboard (optional)
- 2 x LAN 10/100/1000 Mbit/s connections (Gbit LAN with teaming capability)
- Flexible application options in locations with telescopic rails or as desktop industrial PC
- Remote maintenance with iAMT technology and SIMATIC IPC Remote Manager software



**Technical specifications**

	SIMATIC IPC647D	SIMATIC IPC647D
<b>General features</b>		
Design	19" rack, 2 U, external coating	
Processor	<ul style="list-style-type: none"> <li>Intel® Xeon™ E3-1268L v3 4C/8T, 2.3 (3.3) GHz, 8 MB cache, turbo-boost 2.0, Extended Memory 64 (EM64) and virtualization technology (VT-x/-d), iAMT 9.0</li> <li>Intel® Core™ i5-4570TE 2C/4T, 2.7 (3.3) GHz, 4 MB cache, turbo-boost 2.0, Extended Memory 64 (EM64) and virtualization technology (VT-x/-d), iAMT 9.0</li> <li>Intel® Core™ i3-4330TE 2C/4T, 2.4 GHz, 4 MB cache, Extended Memory 64 (EM64) and virtualization technology (VT-x)</li> </ul>	<b>Drives</b> Serial ATA 3.5" hard disks (HDD) with NCQ technology and serial ATA 2.5" solid-state drive (SSD) with MLC technology Mounted internally on the permanent hard disk support: <ul style="list-style-type: none"> <li>1 x 240 GB SSD</li> </ul> Mounted internally in vibration/shock-absorbing hard disk support <ul style="list-style-type: none"> <li>1 x 500 GB HDD</li> <li>1 x 1 TB HDD</li> <li>2 x 1 TB HDD</li> <li>RAID<sup>13)</sup>, 1 TB (2 x 1 TB HDD, mirror disks)</li> </ul> Installed on the front in the low-profile removable drive bay (hot swapping in RAID configurations): <ul style="list-style-type: none"> <li>1 x 500 GB HDD</li> <li>1 x 1 TB HDD</li> <li>2 x 1 TB HDD</li> <li>1 x 240 GB SSD</li> <li>RAID<sup>13)</sup>, 1 TB (2 x 1 TB HDD, mirror disks)</li> </ul>
Chipset	Intel C226	
Main memory	<ul style="list-style-type: none"> <li>From 2 GB DDR3 1600 SDRAM</li> <li>Dual channel support</li> <li>4 DIMM bases expandable up to 32 GB<sup>1)</sup></li> <li>ECC memory (optional)</li> </ul>	DVD±R/RW, 5.25", SATA <ul style="list-style-type: none"> <li>8 x 8 x 6 x (DVD media)</li> <li>24 x 10 x 16 x (CD media)</li> </ul>
Spare slots for expansions (all long)	PCI slots (2 PCI, 2 PCI-Express): <ul style="list-style-type: none"> <li>2 x PCI</li> <li>2 x PCI-Express x16 (8 lanes) Gen 3</li> </ul> or PCI-Express slots (4 PCI-Express): <ul style="list-style-type: none"> <li>1 x PCI-Express x16 (4 lanes) Gen 3</li> <li>1 x PCI-Express x16 (4 lanes) Gen 2</li> <li>1 x PCI-Express x16 (4 lanes) Gen 3</li> <li>1 x PCI-Express x16 (8 lanes) Gen 3</li> </ul>	<b>Slots for drives</b> Front: <ul style="list-style-type: none"> <li>2 x low profile removable drive bays (for 3.5" HDD)</li> <li>1 x 12.7 mm slimline (for ODD or SSD)</li> </ul> Internal: <ul style="list-style-type: none"> <li>2 x 3.5" as an alternative to removable drive bays (in the optional, shock and vibration-damped drive cage)</li> </ul>
Graphics	<ul style="list-style-type: none"> <li>Onboard Intel HD 4600 graphics controller integrated into the processor Dynamic video memory up to 1.7 GB, up to 3840 x 2160 pixels at 60 Hz image refresh rate and 32-bit colors</li> <li>PCI Express graphics card (Dual Head: 2 x VGA or 2 x DVI-D) in the PCIe x16 slot (optional) 512 MB, up to 2048 x 1536 pixels at 60 Hz image refresh rate and 32-bit colors</li> </ul>	<b>Interfaces</b> PROFINET PROFIBUS/MPI Ethernet USB 3.0 USB 2.0 Serial Parallel VGA DVI-I DisplayPort V1.2 Keyboard Mouse Audio
Operating system	<ul style="list-style-type: none"> <li>without</li> <li>Preinstalled, activated, and supplied on restore DVD</li> <li>Windows 7 Ultimate MUI, 32/64-bit</li> <li>Windows Server 2008 R2 incl. 5 Client MUI, 64-bit (MUI: Multi-Language User Interface; 5 languages (English, French, German, Italian, Spanish)</li> <li>Project-specific on request Linux<sup>2)</sup></li> <li>Other</li> </ul>	3 x RJ45 (CP 1616-compatible), optional 12 Mbit/s (isolated, compatible with CP 5622), optional 2 x 10/100/1000 Mbit/s (RJ45, teaming-capable) <ul style="list-style-type: none"> <li>1 x front (high current)</li> <li>2 x rear (high current)</li> <li>1 x internal (high current), e.g. for USB dongle</li> </ul> <ul style="list-style-type: none"> <li>1 x front (high current), can be used with door closed</li> <li>2 x rear (high current)</li> </ul> <ul style="list-style-type: none"> <li>9-pin COM1 (V.24)</li> <li>9-pin COM2 (V.24) optional</li> </ul> LPT1 (optional) Optionally via adapter cable 1 x 2 x PS/2 PS/2 1 x Line Out; 1 x Micro
Power supply	<ul style="list-style-type: none"> <li>100 ... 240 V AC, 50 ... 60 Hz; with bridging of temporary power failures in accordance with NAMUR: max. 20 ms at 0.85 % rated voltage</li> <li>Redundant 100 ... 240 V AC, 50 ... 60 Hz</li> </ul>	

# PROFINET/Industrial Ethernet

Industrial PC  
Rack PC

## SIMATIC IPC647D

### Technical specifications (continued)

	SIMATIC IPC647D		SIMATIC IPC647D
<b>Monitoring functions</b>		<b>Electromagnetic compatibility (EMC)</b>	
Basic functionality	Message locally via DiagBase software	Emitted interference (AC)	<ul style="list-style-type: none"> <li>EN 61000-6-3, FCC Class A</li> <li>EN 61000-6-4; CISPR 22, EN 55022 Class B</li> <li>EN 61000-3-2 Class D, EN 61000-3-3</li> </ul>
Temperature	<ul style="list-style-type: none"> <li>Overshoot/undershoot of permissible operating temperature range</li> <li>Messages can be evaluated by the application program</li> </ul>	Immunity to conducted interference on the supply lines	<ul style="list-style-type: none"> <li>± 2 kV (IEC 61000-4-4, burst)</li> <li>± 1 kV (IEC 61000-4-5, symm. surge)</li> <li>± 2 kV (IEC 61000-4-5, asymm. surge)</li> </ul>
Fan	<ul style="list-style-type: none"> <li>Speed monitoring</li> <li>2 x enclosure fans</li> <li>1 x fan power supply</li> </ul>	Noise immunity on signal lines	<ul style="list-style-type: none"> <li>± 1 kV (IEC 61000-4-4, burst, length &lt; 30 m)</li> <li>± 2 kV (IEC 61000-4-4, symm. surge, length &gt; 30 m)</li> <li>± 2 kV (IEC 61000-4-5, asymm. surge, length &gt; 30 m)</li> </ul>
Watchdog	<ul style="list-style-type: none"> <li>Monitoring of program execution</li> <li>Monitoring time can be parameterized in software</li> <li>Restart can be parameterized in the event of a fault</li> <li>Messages can be evaluated by the application program</li> </ul>	Immunity to static discharge	<ul style="list-style-type: none"> <li>± 6 kV, contact discharge (IEC 61000-4-2)</li> <li>± 8 kV, air discharge (IEC 61000-4-2)</li> </ul>
Monitoring functions via the network	SIMATIC PC DiagMonitor (optional) Remote monitoring capability for: <ul style="list-style-type: none"> <li>Watchdog</li> <li>Temperature</li> <li>Fan speed</li> <li>Hard disk monitoring (SMART)</li> <li>System/Ethernet monitoring (heartbeat)</li> </ul> Communication: <ul style="list-style-type: none"> <li>Ethernet interface (SNMP protocol)</li> <li>OPC for integration in SIMATIC software</li> <li>Configuration of client/server architectures, configuration of log files</li> </ul>	Immunity to high radio frequency interference	<ul style="list-style-type: none"> <li>10 V/m, 80 to 1000 MHz and 1.4 to 2 GHz, 80% AM (according to IEC 61000-4-3)</li> <li>3 V/m, 2 to 2.7 GHz, 80% AM (according to IEC 61000-4-3)</li> <li>10 V, 10 kHz to 80 MHz, 80% AM (according to IEC 61000-4-6)</li> </ul>
Front LEDs	<ul style="list-style-type: none"> <li>POWER (internal power supply unit, PC switched on)</li> <li>HDD (access to hard disk)</li> <li>ETHERNET1 (Ethernet status, "heartbeat")</li> <li>ETHERNET2 (Ethernet status, "heartbeat")</li> <li>PROFIBUS/MPI (PROFIBUS status)</li> <li>SF PROFINET (PROFINET status)</li> <li>WATCHDOG (ready/fault indication)</li> <li>TEMP (temperature status)</li> <li>FAN (fan speed monitoring)</li> <li>HDD0 ALARM <sup>4)</sup></li> <li>HDD1 ALARM <sup>4)</sup></li> </ul>	Immunity to magnetic fields	100 A/m, 50/60 Hz (IEC 61000-4-8)
		Ambient temperature during operation	5 ... 50 °C Note: Limitations for operation of DVD+/-RW
		Humidity during operation	5 ... 85 % at 30 °C (no condensation)
		<b>Approvals and safety regulations</b>	
		Safety regulations	<ul style="list-style-type: none"> <li>IEC 60950-1</li> <li>EN 60950-1</li> <li>UL 60950-1</li> <li>CSA C22.2 No 60950-1-07</li> </ul>
		Approvals	cULus 60950, KCC
		CE mark	For use in industrial areas as well as domestic, business and commercial environments: <ul style="list-style-type: none"> <li>Emitted interference: EN 61000-6-3: 2007 +A1:2011</li> <li>Noise immunity: EN 61000-6-2:2005</li> </ul>
<b>Ambient conditions</b>		<b>Dimensions and weights</b>	
Degree of protection	IP41 at the front, IP20 at the rear acc. to EN 60529	Installation dimensions (W x H x D) in mm	430 x 88 x 445
Dust protection	with front door closed: G2 EN 779, 99 % of particles > 0.5 mm are held back		
Protection class	Protection class I according to IEC 61140		
Vibration load during operation	DIN EN 60068-2-6, 10 cycles Internal mounting of the hard disk drives in optional, internal drive cage: <ul style="list-style-type: none"> <li>10 ... 58 Hz: 0.0375 mm;</li> <li>58 ... 500 Hz: 5 m/s<sup>2</sup> (approx. 0.5 g)</li> </ul> Note: There are limitations when DVD+/-RW and HDD are operated in a removable drive bay		
Shock loading during operation	DIN EN 60068-2-27, IEC 60068-2-29 Internal mounting of the hard disk drives in optional, internal drive cage: <ul style="list-style-type: none"> <li>Half-sine: 50 m/s<sup>2</sup>, 30 ms (approx. 5 g), 100 shocks per axis</li> </ul> Note: There are limitations when DVD+/-RW and HDD are operated in a removable drive bay		

- Memory information: In order to use a memory with more than 4 GB, a 64-bit operating system is required. In the case of configurations with at least 4 GB, the visible memory can be reduced to about 3.5 GB or less (with 32-bit operating systems)
- Suitable for specific LINUX versions in accordance with the specifications of the Siemens manufacturer's declaration "Suitable for LINUX" (LINUX is a trademark of Linus Torvalds).
- SATA RAID controller on board in Intel chipset
- Hard disk alarm in conjunction with RAID and monitoring software

#### Note regarding SIMATIC PC operating system licenses

The accompanying operating system license is only valid for installation on the respective supplied SIMATIC IPC. Installation can only be performed on these SIMATIC systems in accordance with Microsoft OEM licensing regulations.

Ordering data	Article No.	Article No.
<b>SIMATIC IPC647D<sup>1)</sup></b>	<b>6AG4112 - 2</b>	<b>SIMATIC IPC647D<sup>1)</sup></b>
<b>Interfaces:</b> RACK PC, 19", 2 HU; Interfaces: 2 x GBIT LAN (RJ45); 1 x DVI-I; 2 x DisplayPort; 1 x COM; 2 x PS/2; Audio; 2 x USB 3.0, 2 x USB 2.0 at rear; 1 x USB 3.0, 1 x USB 2.0 at front, 1 x USB 3.0 internal; Temperature and fan monitoring, watchdog, card retainer;		<b>Memory configuration</b> • 2 GB DDR3 SDRAM (1 x 2 GB), single channel • 4 GB DDR3 SDRAM (2 x 2 GB), dual channel • 8 GB DDR3 SDRAM (2 x 4 GB), dual channel • 16 GB DDR3 SDRAM (2 x 8 GB), dual channel • 32 GB DDR3 SDRAM (4 x 8 GB), dual channel • 8 GB DDR3 SDRAM, (2 x 4 GB), ECC, dual channel • 16 GB DDR3 SDRAM, (2 x 8 GB), ECC, dual channel • 32 GB DDR3 SDRAM, (4 x 8 GB), ECC, dual channel
<b>Processor/motherboard</b>		<b>Bus module / swap media / SSD:</b>
• Core i3-4330TE (2C/4T, 2.4 GHz, 4 MB cache); mainboard without fieldbus • Core i3-4330TE (2C/4T, 2.4 GHz, 4 MB, VT-x); mainboard with PROFIBUS/MPI (CP 5622-compatible) • Core i3-4330TE (2C/4T, 2.4 GHz, 4 MB cache); mainboard with PROFINET (3 x RJ45, CP 1616-compatible) • Core i5-4570TE (2C/4T, 2.7 (3.3) GHz, 4 MB Cache, TB, VT-d, AMT); mainboard without fieldbus • Core i5-4570TE (2C/4T, 2.7 (3.3) GHz, 4 MB cache, TB, VT-x, VT-d, AMT); mainboard with PROFIBUS/MPI (CP 5622-compatible) • Core i5-4570TE (2C/4T, 2.7 (3.3) GHz, 4 MB cache, TB, VT-d, AMT); mainboard with PROFINET (3 x RJ45, CP 1616-compatible) • Xeon E3-1268L v3 (4C/8T, 2.3 (3.3) GHz, 8 MB cache, TB, VT-d, AMT); mainboard without fieldbus • Xeon E3-1268L v3 (4C/8T, 2.3 (3.3) GHz, 8 MB cache, TB, VT-x, VT-d, AMT); mainboard with PROFIBUS/MPI (CP 5622-compatible) • Xeon E3-1268L v3 (4C/8T, 2.3 (3.3) GHz, 8 MB cache, TB, VT-d, AMT); mainboard with PROFINET (3 x RJ45, CP 1616-compatible)	D E F G H J K L M	• Bus module 2-slot: 2 x PCIe x16; without drives • Bus module 4-slot: 2 x PCI, 2 x PCIe x16; without drives • Bus module 4-slot: 4 x PCIe x16; without drives • Bus module 2-slot: 2 x PCIe x16; DVD±RW (slim) • Bus module 4-slot: 2 x PCI, 2 x PCIe x16; DVD±RW (slim) • Bus module 4-slot: 4 x PCIe x16; DVD±RW (slim) • Bus module 2-slot: 2 x PCIe x16 / 1 x 240 GB SSD (for operating system), internal • Bus module 4-slot: 2 x PCI, 2 x PCIe x16 / 1 x 240 GB SSD (for operating system), internal • Bus module 4-slot: 4 x PCIe x16 / 1 x 240 GB SSD (for operating system), internal
<b>Hard drives / SSD</b>		<b>Expansion hardware</b>
• 500 GB HDD SATA, internal (0.5 g vibration, 5 g shock) • 1 TB HDD SATA, internal (0.5 g vibration, 5 g shock) • 2 x 1 TB HDD SATA, internal (0.5 g vibration, 5 g shock) • RAID1, 1 TB (2 x 1 TB HDD SATA, mirror disks), internal (0.5 g vibration, 5 g shock) • 500 GB HDD SATA in removable drive bay; front • 1 TB HDD SATA in removable drive bay; front • 2 x 1 TB HDD SAT in removable drive bay; front • RAID1, 1 TB (2 x 1 TB HDD SATA, mirror disks) in removable drive bay, hot-swappable, front • 240 GB SSD SATA, internal • 240 GB SSD SATA in removable drive bay; front	A B C D H K M P S T	• Without expansions (hardware), onboard graphics; • Without expansions (hardware), onboard graphics, DVI-I adapter cable, VGA-compliant for onboard graphics; • Serial (COM2) + parallel (LPT, 1 slot reserved), onboard graphics; • Serial (COM2) + parallel (LPT, 1 slot reserved), onboard graphics; DVI-I adapter cable, VGA-compliant for onboard graphics; • Serial (COM2) + Parallel (LPT, 1 slot reserved) + PCIe x16 Graphics Card (Dual-Head: 2 x VGA or 2 x DVI-D), 512 MB, (1 slot reserved);

<sup>1)</sup> For an up-to-date overview, see the SIMATIC IPC online configurator at:  
<http://www.siemens.com/ipc-configurator>

**PROFINET/Industrial Ethernet**

Industrial PC

Rack PC

**SIMATIC IPC647D****Ordering data****Article No.**

Ordering data	Article No.
<b>SIMATIC IPC647D <sup>1)</sup></b>	<b>6AG4112 - 2</b>
<u>Operating system (preinstalled and activated)</u>	
• Windows 7 Ultimate, 32-bit MUI (Eng, Ger, Fr, It, Sp), SP1	<b>A</b>
• Windows 7 Ultimate, 64-bit MUI (Eng, Ger, Fr, It, Sp), SP1	<b>B</b>
• Windows Server 2008 R2 Standard Edition incl. 5 Clients, 64-bit, MUI (Eng, Ger, Fr, It, Sp), SP1	<b>F</b>
• Without operating system	<b>X</b>
<u>Expansions (software) / Security</u>	
• SIMATIC IPC DiagMonitor software V4.4 included	<b>A</b>
• SIMATIC IPC Image Creator software V3.3 included	<b>B</b>
• SIMATIC IPC DiagMonitor 4.4 and Image Creator Software 3.3 included	<b>C</b>
• Without software	<b>X</b>
• Without expansions (software) / TPM (not for China and Russia)	<b>Y</b>
<u>Power supply, country-specific cable</u>	
• 110 / 240 V industrial power supply unit with NAMUR; power cable for Europe	<b>0</b>
• 110 / 240 V industrial power supply unit with NAMUR; power cable for United Kingdom	<b>1</b>
• 110 / 240 V industrial power supply unit with NAMUR; power cable for Switzerland	<b>2</b>
• 110 / 240 V industrial power supply unit with NAMUR; power cable for USA	<b>3</b>
• 110 / 240 V industrial power supply unit with NAMUR; power cable for Italy	<b>4</b>
• 110 / 240 V industrial power supply unit with NAMUR; power cable for China	<b>5</b>
• 2 x 110 / 240 V redundant power supply; without power cable	<b>6</b>

<sup>1)</sup> For an up-to-date overview, see the SIMATIC IPC online configurator at: <http://www.siemens.com/ipc-configurator>

**Article No.****Accessories****Memory expansions**

- 2 GB DDR3 1600 DIMM
- 4 GB DDR3 1600 DIMM
- 8 GB DDR3 1600 DIMM
- 8 GB DDR3 1600 DIMM, ECC

**6ES7648-2AJ50-0MA0**  
**6ES7648-2AJ60-0MA0**  
**6ES7648-2AJ70-0MA0**  
**6ES7648-2AJ70-1MA0**

**Hardware accessories****Rack unit for low-profile removable drive bay**

For 3.5" hard drive (SATA/SAS) and 2.5" SSD (SATA), without drive

**6ES7648-0EG01-1BA0****Filter mats**

for SIMATIC IPC647D (packing unit: 10 units)

**A5E02396171****Adapter cable**

- Adapter cable DisplayPort to DVI-D for onboard graphics
- Adapter cable DisplayPort to VGA for onboard graphics

**6ES7648-3AF00-0XA0****6ES7648-3AG00-0XA0****Power cable, straight, 3 m long**

- Austria, Belgium, Finland, France, Germany, Netherlands, Spain, Sweden
- United Kingdom
- Switzerland
- USA
- Italy
- China

**6ES7900-0AA00-0XA0****6ES7900-0BA00-0XA0****6ES7900-0CA00-0XA0****6ES7900-0DA00-0XA0****6ES7900-0EA00-0XA0****6ES7900-0FA00-0XA0****USB retainer**

for interlocking the internal USB port

**6ES7648-1AA00-0XK0****Expansion components**

See catalog ST 80 / ST PC

**Note:**

Software Packages with SIMATIC WinCC flexible, WinCC RT Advanced, SIMATIC WinCC, and SIMATIC WinAC RTX (F) can be ordered together with the SIMATIC IPC at a price advantage. More information under "Embedded Bundles / Packages for industrial PCs".

**More information**

Additional information is available on the Internet at:

<http://www.siemens.com/simatic-pc>

## Overview



IPC 847D front view

The SIMATIC IPC847D is an extremely robust, high-performance industrial PC in 19" rack design (4 U) with excellent industrial functionality.

It offers:

- Maximum expandability
- Extreme ruggedness
- 4th generation Intel® Core™ i technology

## Benefits

### **Maximum industrial compatibility and compactness for 24-hour use in an industrial environment**

- Maximum processor performance (in maximum configuration) without loss of power (throttling) at ambient temperatures of up to 50 °C
- Distinct product design with new front design and fully-coated, dirt-resistant surfaces
- All-metal housing with high EMC for use in industrial environment
- Suitable for installing in space-saving control cabinets only 500 mm deep
- Dust protection thanks to overpressure ventilation concept with fan on the front and dust filter
- Special hard disk holders and card retainers for protection against vibration and shock

### **High productivity thanks to faster data processing**

- 4th generation Intel® processors: Xeon, Core i5 or Core i3 with turbo-boost, hyper-threading and virtualization technology
- Graphics controller (HD graphics 4600) integrated in the processor for exceptionally high graphics performance
- Maximum performance (e.g. Intel C226 Express chipset, DDR3 memory with the support of dual-channel technology)
- High data transfer rates (e.g. PCI-Express technology: Gen 2 and Gen 3, USB 3.0 SuperSpeed (500 Mbit/s), SATA III/6 Gbit/s)

### **Reduction in downtimes through high system availability**

- Secure 24-hour operation (high MTBF, variable-speed fan) at ambient temperature up to 50° C
- High data security thanks to RAID configurations (RAID controller onboard)
- RAID1 configuration: Redundant data storage on two SATA hard disks, also in hot-removable drive bays and with additional SSD (for operating system) or hot spare hard disk option

- RAID5 configuration: Striping with parity on three SATA hard disks for increased memory capacity in hot-removable drive bays, with additional hot spare hard disk option
- "Hot swap" HDD in removable drive bay in RAID configurations (replacement of hard disk during operation)
- "Hot spare" HDD in removable drive bay in RAID configurations (the rebuild process on the "hot spare" hard disk starts up automatically)
- Fast identification and replacement of the hard disk in the event of a fault by means of HDD alarm LEDs for RAID configurations and unambiguous numbering
- Status display (front LEDs) for Ethernet and PROFIBUS or PROFINET; alarm indication for fan, temperature, watchdog and hard disks in RAID1/5 configurations
- Efficient self-diagnostics per SIMATIC PC DiagBased or DiagMonitor software (optional)
- Remote control and maintenance with iAMT 9.0 (Intel® Active Management Technology)
- Solid-state drive (SSD) in multi-level cell (MLC) architecture and ECC memory (optional)
- Redundant power supply with "hot swap" functionality (replacement of power supply module during operation)
- Redundant Gbit LAN connections (teaming capability)
- Securing of the replaceable components at the front (e.g. USB software dongle) against unauthorized access by means of a lockable door
- Locked fan cover: Filter mat and front fan can only be replaced when front door is open
- The enclosure cover can only be opened if the front door is open
- Secure internal USB slot in device for software dongle, for example
- Service-friendly device design (modifications, service) e.g. filter replacement or front fan replacement without tools

### **Cost reductions through high investment security**

- Platform with long-term stability and embedded Intel components
- Availability of 3 to 6 years, guaranteed availability of spare parts for 5 years
- System-tested with SIMATIC components
- Certification for worldwide marketing (cULus)
- Support for legacy interfaces (PS/2, COM, LPT)
- Installation compatible for many device generations
- Worldwide service and support

### **Reduced costs due to time savings for commissioning, operation and servicing**

- High degree of flexibility and expandability thanks to integrated interfaces and up to 11 slots (PCI and PCI-Express)
- Preinstalled and activated operating system
- Fast restoration of the delivery status of the HDD thanks to restore DVD
- Low noise output thanks to controlled fan
- Universal implementation as an industrial workstation or server
- PROFIBUS or PROFINET interface and RAID1/5 controller onboard (optional)
- 2 x LAN 10/100/1000 Mbit/s connections (Gbit LAN with teaming capability)
- Flexible applications in many different positions with telescopic rails or as tower industrial PC
- Remote maintenance with iAMT technology and SIMATIC IPC Remote Manager software

# PROFINET/Industrial Ethernet

Industrial PC  
Rack PC

## SIMATIC IPC847D

### Technical specifications

	SIMATIC IPC847D	SIMATIC IPC847D
<b>General features</b>		
Design	19" rack, 4 U, externally painted	
Processor	<ul style="list-style-type: none"> <li>Intel® Xeon™ E3-1268L v3 4C/8T, 2.3 (3.3) GHz, 8 MB cache, turbo-boost 2.0, Extended Memory 64 (EM64) and virtualization technology (VT-x/-d), iAMT 9.0</li> <li>Intel® Core™ i5-4570TE 2C/4T, 2.7 (3.3) GHz, 4 MB cache, turbo-boost 2.0, Extended Memory 64 (EM64) and virtualization technology (VT-x/-d), iAMT 9.0</li> <li>Intel® Core™ i3-4330TE 2C/4T, 2.4 GHz, 4 MB cache, Extended Memory 64 (EM64) and virtualization technology (VT-x)</li> </ul>	<b>Drives</b> Serial ATA 3.5" hard disks (HDD) with NCQ technology and serial ATA 2.5" solid-state drive (SSD) with MLC technology Mounted internally on the permanent hard disk support: <ul style="list-style-type: none"> <li>1 x 500 GB HDD</li> <li>1 x 240 GB SSD</li> </ul> Can be installed in internal shock and vibration-damped drive cage (optional) <ul style="list-style-type: none"> <li>1 x 500 GB HDD</li> <li>1 x 1 TB HDD</li> <li>2 x 1 TB HDD</li> <li>RAID1<sup>(3)</sup>, 1 TB (2 x 1 TB HDD, mirror disks)</li> <li>RAID1<sup>(3)</sup>, 1 TB (2 x 1 TB HDD, mirror disks) + 1 x 240 GB SSD (for operating system) in removable drive bay</li> </ul> Installed on the front in the low-profile removable drive bay (hot swapping in RAID configurations): <ul style="list-style-type: none"> <li>1 x 500 GB HDD</li> <li>1 x 1 TB HDD</li> <li>2 x 1 TB HDD</li> <li>1 x 240 GB SSD</li> <li>RAID1<sup>(3)</sup>, 1 TB (2 x 1 TB HDD, mirror disks)</li> <li>RAID1<sup>(3)</sup>, 1 TB (2 x 1 TB HDD, mirror disks) + 1 x 1 TB HDD as hot spare</li> <li>RAID1<sup>(3)</sup>, 1 TB (2 x 1 TB HDD, mirror disks) + 1 x 240 GB SSD (for operating system)</li> <li>RAID5<sup>(3)</sup>, 2 TB (3 x 1 TB HDD, striping with parity)</li> <li>RAID5<sup>(3)</sup>, 2 TB (3 x 1 TB HDD, striping with parity) + 1 x 1 TB HDD as hot spare</li> </ul>
Chipset	Intel C226	
Main memory	<ul style="list-style-type: none"> <li>From 2 GB DDR3 1600 SDRAM</li> <li>Dual channel support</li> <li>4 DIMM base</li> <li>Expandable up to 32 GB <sup>1)</sup></li> <li>ECC memory (optional)</li> </ul>	
Spare slots for expansions (all 312 mm long)	More PCI slots (7 PCI, 4 PCI-Express): <ul style="list-style-type: none"> <li>7 x PCI</li> <li>1 x PCI-Express x16 (16 lanes) Gen 3</li> <li>3 x PCI-Express x4 (1 lane) Gen 2</li> </ul> or More PCI-Express slots (8 PCI-Express, 3 PCI): <ul style="list-style-type: none"> <li>3 x PCI</li> <li>1 x PCI-Express x16 (8 lanes) Gen 3</li> <li>2 x PCI-Express x16 (4 lanes) Gen 3</li> <li>2 x PCI-Express x16 (4 lanes) Gen 2</li> <li>3 x PCI-Express x4 (4 lane) Gen 2</li> </ul>	
Graphics	Onboard Intel HD 4600 graphics controller integrated into the processor Dynamic Video Memory up to 1.7 GB Up to 3840 x 2160 pixels at 60 Hz image refresh rate and 32-bit colors PCI Express graphics card (Dual Head: 2 x VGA or 2 x DVI-D) in the PCIe x16 slot (optional) 512 MB, up to 2048 x 1536 pixels at 60 Hz image refresh rate and 32-bit colors	DVD+/-R/RW, slim, SATA Slots for drives Front: <ul style="list-style-type: none"> <li>3 x 5.25" / 4 x low-profile removable drive bay</li> <li>1 x slim (ODD)</li> </ul> Internal: <ul style="list-style-type: none"> <li>2 x 3.5"</li> </ul> or 2 x 3.5" (in the optional, vibration-damping drive cage)
Operating system	<ul style="list-style-type: none"> <li>without</li> <li>Preinstalled and activated / supplied on restore DVD</li> <li>Windows 7 Ultimate MUI, 32/64-bit</li> <li>Windows Server 2008 R2 incl. 5 client MUI, 64-bit</li> </ul> MUI: Multi-language User Interface; 5 languages (English, French, German, Italian, Spanish) <ul style="list-style-type: none"> <li>Project-specific on request</li> <li>Linux <sup>2)</sup></li> <li>Other</li> </ul>	<b>Interfaces</b> PROFINET 3x RJ45 (CP 1616-compatible), optional PROFIBUS/MPI 12 Mbit/s (isolated, compatible with CP 5622), optional Ethernet 2 x 10/100/1000 Mbit/s (RJ45, teaming-capable) USB 3.0 <ul style="list-style-type: none"> <li>1 x front (high current)</li> <li>2 x rear (high current)</li> <li>1 x internal (high current), e.g. for USB dongle</li> </ul> USB 2.0 <ul style="list-style-type: none"> <li>1 x front (high current), can be used with door closed</li> <li>2 x rear; (high current)</li> </ul> Serial <ul style="list-style-type: none"> <li>9-pin COM1 (V.24)</li> <li>9-pin COM2 (V.24) (optional)</li> </ul> Parallel <ul style="list-style-type: none"> <li>LPT1 (optional)</li> </ul> VGA Optionally via adapter cable DVI-I <ul style="list-style-type: none"> <li>1 x</li> </ul> DisplayPort V1.2 <ul style="list-style-type: none"> <li>2 x</li> </ul> Keyboard PS/2 Mouse PS/2 Audio 1 x Line Out; 1 x Micro
Power supply	<ul style="list-style-type: none"> <li>100 ... 240 V AC, 50 ... 60 Hz with bridging of temporary power failures in accordance with NAMUR: max. 20 ms at 0.85 % rated voltage</li> <li>Redundant 100 ... 240 V AC, 50 ... 60 Hz</li> </ul>	

**Technical specifications (continued)**

SIMATIC IPC847D		SIMATIC IPC847D	
<b>Monitoring functions</b>			
Basic functionality	Message locally via DiagBase software	Shock loading during operation	DIN EN 60068-2-27, IEC 60068-2-29
Temperature	<ul style="list-style-type: none"> <li>• Overshoot/undershoot of permissible operating temperature range</li> <li>• Messages can be evaluated by the application program</li> </ul>		Internal mounting of the hard disk drives in optional, internal drive cage: <ul style="list-style-type: none"> <li>• Half-sine: 50 m/s<sup>2</sup>, 30 ms (approx. 5 g), 100 shocks per axis</li> <li>• Permanently installed internal hard disk drives: 30 m/s<sup>2</sup>, 30 ms (approx. 3 g)</li> </ul>
Fan	<ul style="list-style-type: none"> <li>• Speed monitoring</li> <li>• 2 x enclosure fans</li> <li>• 1 x fan power supply</li> </ul>		Note: There are limitations when DVD+/-RW and HDD are operated in a removable drive bay
Watchdog	<ul style="list-style-type: none"> <li>• Monitoring of program execution</li> <li>• Monitoring time can be parameterized in software</li> <li>• Restart can be parameterized in the event of a fault</li> <li>• Messages can be evaluated by the application program</li> </ul>	<b>Electromagnetic compatibility (EMC)</b>	
Monitoring functions via the network	SIMATIC PC DiagMonitor (optional) Remote monitoring capability for: <ul style="list-style-type: none"> <li>• Watchdog</li> <li>• Temperature</li> <li>• Fan speed</li> <li>• Hard disk monitoring (SMART)</li> <li>• System/Ethernet monitoring (Heartbeat)</li> </ul> Communication: <ul style="list-style-type: none"> <li>• Ethernet interface (SNMP protocol)</li> <li>• OPC for integration in SIMATIC software</li> <li>• Configuration of client/server architectures</li> <li>• Structure of log files</li> </ul>	Emitted interference (AC)	<ul style="list-style-type: none"> <li>• EN 61000-6-3, FCC Class A</li> <li>• EN 61000-6-4;</li> <li>• CISPR 22, EN 55022 Class B</li> <li>• EN 61000-3-2 Class D, EN 61000-3-3</li> </ul>
Front LEDs	<ul style="list-style-type: none"> <li>• POWER (internal power supply unit, PC switched on)</li> <li>• ETHERNET1 (Ethernet status, "Heartbeat")</li> <li>• ETHERNET2 (Ethernet status, "Heartbeat")</li> <li>• PN / MPI/DP (PROFINET/PROFIBUS status)</li> <li>• WATCHDOG (ready/fault indication)</li> <li>• TEMP (temperature status)</li> <li>• FAN (fan speed monitoring)</li> <li>• HDD0 ALARM <sup>4)</sup></li> <li>• HDD1 ALARM <sup>4)</sup></li> <li>• HDD2 ALARM <sup>4)</sup></li> <li>• HDD (access to hard disk) / HDD3 ALARM <sup>4)</sup></li> </ul>	Immunity to conducted interference on the supply lines	<ul style="list-style-type: none"> <li>• ± 2 kV (IEC 61000-4-4, burst)</li> <li>• ± 1 kV (IEC 61000-4-5, symm. surge)</li> <li>• ± 2 kV (IEC 61000-4-5, asymm. surge)</li> </ul>
		Noise immunity on signal lines	<ul style="list-style-type: none"> <li>• ± 1 kV (IEC 61000-4-4, burst, length &lt; 30 m)</li> <li>• ± 2 kV (IEC 61000-4-4, symm. surge, length &gt; 30 m)</li> <li>• ± 2 kV (IEC 61000-4-5, asymm. surge, length &gt; 30 m)</li> </ul>
		Immunity to static discharge	<ul style="list-style-type: none"> <li>• ± 6 kV, contact discharge (IEC 61000-4-2)</li> <li>• ± 8 kV, air discharge (IEC 61000-4-2)</li> </ul>
		Immunity to high radio frequency interference	<ul style="list-style-type: none"> <li>• 10 V/m, 80 to 1000 MHz and 1.4 to 2 GHz, 80% AM (according to IEC 61000-4-3)</li> <li>• 3 V/m, 2 to 2.7 GHz, 80% AM (to IEC 61000-4-3)</li> <li>• 10 V, 10 kHz to 80 MHz, 80% AM (according to IEC 61000-4-6)</li> </ul>
		Immunity to magnetic fields	100 A/m, 50/60 Hz (IEC 61000-4-8)
		Ambient temperature during operation	5 ... 50 °C Note: Limitations for operation of DVD+/-RW
		Relative humidity during operation	5 ... 80 % at 25 °C (no condensation)
<b>Ambient conditions</b>		<b>Approvals and safety regulations</b>	
Degree of protection	IP41 at the front, IP20 at the rear acc. to EN 60529	Safety regulations	<ul style="list-style-type: none"> <li>• IEC 60950-1</li> <li>• EN 60950-1</li> <li>• UL 60950-1</li> <li>• CSA C22.2 No 60950-1-07</li> </ul>
Dust protection	With front door closed: G2 EN 779, 99 % of particles > 0.5 mm are held back	Approvals	cULus 60950-1 Second Edition, KCC
Protection class	Protection class I according to IEC 61140	CE mark	<ul style="list-style-type: none"> <li>• Emitted interference: EN 61000-6-3: 2007 +A1:2011</li> <li>• Noise immunity: EN 61000-6-2:2005</li> </ul>
Vibration load during operation	DIN EN 60068-2-6, 10 cycles Internal mounting of the hard disk drives in optional, internal drive cage: <ul style="list-style-type: none"> <li>• 10 ... 58 Hz: 0.0375 mm;</li> <li>• 58 ... 500 Hz: 5 m/s<sup>2</sup> (approx. 0.5 g)</li> </ul> Permanently installed internal hard disk drives: <ul style="list-style-type: none"> <li>• 10 ... 58 Hz: 0.019 mm;</li> <li>• 58 ... 500 Hz: 3 m/s<sup>2</sup> (approx. 0.3 g)</li> </ul> Note: There are limitations when DVD+/-RW and HDD are operated in a removable drive bay	<b>Dimensions and weights</b>	
		Installation dimensions (W x H x D) in mm	430 x 177 x 448
		1) Memory information: in order to use a memory with more than 4 GB, a 64-bit operating system is required. In the case of configurations with at least 4 GB, the visible memory can be reduced to about 3.5 GB or less (with 32-bit operating systems).	
		2) Suitable for specific LINUX versions in accordance with the specifications of the Siemens manufacturer's declaration "Suitable for LINUX" (LINUX is a trademark of Linus Torvalds).	
		3) SATA RAID controller on board in Intel chipset	
		4) Hard disk alarm in conjunction with RAID and monitoring software	
		<b>Note regarding SIMATIC PC operating system licenses</b>	
		The accompanying operating system license is only valid for installation on the respective supplied SIMATIC IPC. Installation can only be performed on these SIMATIC systems in accordance with Microsoft OEM licensing regulations.	

## PROFINET/Industrial Ethernet

## Industrial PC

## Rack PC

## SIMATIC IPC847D

## Ordering data

## Article No.

## Article No.

SIMATIC IPC847D <sup>1)</sup>

6AG4114 - 2

Interfaces:  
RACK PC, 19", 4 U;  
Interfaces: 2 x GBIT LAN (RJ45);  
1 x DVI-I; 2 x DisplayPort;  
1 x COM; 2 x PS/2; Audio;  
2 x USB 3.0, 2 x USB 2.0 at rear;  
1 x USB 3.0, 1 x USB 2.0 at front,  
1 x USB 3.0 internal;  
Temperature and fan monitoring,  
watchdog, card retainer;

Processor/motherboard

- Core i3-4330TE (2C/4T, 2.4 GHz, 4 MB cache);  
mainboard without fieldbus **D**
- Core i3-4330TE (2C/4T, 2.4 GHz,  
4 MB cache, VT-x);  
mainboard with PROFIBUS/MPI  
(CP 5622-compatible) **E**
- Core i3-4330TE (2C/4T, 2.4 GHz, 4 MB cache);  
mainboard with PROFINET  
(3 x RJ45, CP 1616-compatible) **F**
- Core i5-4570TE (2C/4T, 2.7 (3.3) GHz,  
4 MB Cache, TB, VT-d, AMT);  
mainboard without fieldbus **G**
- Core i5-4570TE (2C/4T, 2.7 (3.3) GHz, 4 MB  
cache, TB, VT-x, VT-d, AMT);  
mainboard with PROFIBUS/MPI  
(CP 5622-compatible) **H**
- Core i5-4570TE (2C/4T, 2.7 (3.3) GHz,  
4 MB cache, TB, VT-d, AMT);  
mainboard with PROFINET  
(3 x RJ45, CP 1616-compatible) **J**
- Xeon E3-1268L v3 (4C/8T, 2.3 (3.3) GHz,  
8 MB cache, TB, VT-d, AMT);  
mainboard without fieldbus **K**
- Xeon E3-1268L v3 (4C/8T, 2.3 (3.3) GHz,  
8 MB cache, TB, VT-x, VT-d, AMT);  
mainboard with PROFIBUS/MPI  
(CP 5622-compatible) **L**
- Xeon E3-1268L v3 (4C/8T, 2.3 (3.3) GHz, 8 MB  
cache, TB, VT-d, AMT);  
mainboard with PROFINET  
(3 x RJ45, CP 1616-compatible) **M**

Drives

- 500 GB HDD SATA, internal (0.3 g vibration, 3 g shock) **A**
- 500 GB HDD SATA, internal (0.5 g vibration, 5 g shock) **B**
- 1 TB HDD SATA, internal (0.5 g vibration, 5 g shock) **C**
- 2 x 1 TB HDD SATA, internal (0.5 g vibration, 5 g shock) **D**
- RAID1, 1 TB (2 x 1 TB HDD SATA, mirror disks), internal (0.5 g vibration, 5 g shock) **E**
- 500 GB HDD SATA in removable drive bay; front **F**
- 1 TB HDD SATA in removable drive bay; front **G**
- 2 x 1 TB HDD SAT in removable drive bay; front **H**
- RAID1, 1 TB (2 x 1 TB HDD SATA, mirror disks) in removable drive bay, hot-swappable, front; **J**
- RAID5, 2 TB (3 x 1 TB HDD, SATA, striping with parity) in removable drive bay, hot-swappable, front **K**

SIMATIC IPC847D <sup>1)</sup>

6AG4114 - 2

Drives (continued)

- RAID5, 2 TB (3 x 1 TB HDD, SATA, striping with parity) in removable drive bay, hot swap + 1 TB SATA HDD as hot spare in removable drive bay, front; **L**
- 240 GB SSD SATA, internal **M**
- 240 GB SSD SATA in removable drive bay; front **N**
- RAID1, 1 TB (2 x 1 TB HDD SATA, mirror disks), internal (0.5 g vibration, 5 g shock) + 240 GByte SSD SATA (for operating system) in removable drive bay **P**
- RAID1, 1 TB (2 x 1 TB HDD, SATA, mirror disks) in removable drive bay, hot swap + 1 TB HDD SATA as hot spare in removable drive bay, front; **Q**
- RAID1, 1 TB (2 x 1 TB HDD SATA, mirror disks) + 240 GByte SSD SATA (for operating system) in removable drive bay, hot-swap; front **R**

Memory configuration

- 2 GB DDR3 SDRAM (1 x 2 GB), single channel **1**
- 4 GB DDR3 SDRAM (2 x 2 GB), dual channel **2**
- 8 GB DDR3 SDRAM (2 x 4 GB), dual channel **3**
- 16 GB DDR3 SDRAM (2 x 8 GB), dual channel **4**
- 32 GB DDR3 SDRAM (4 x 8 GB), dual channel **5**
- 8 GB DDR3 SDRAM, (2 x 4 GB), ECC, dual channel **6**
- 16 GB DDR3 SDRAM, (2 x 8 GB), ECC, dual channel **7**
- 32 GB DDR3 SDRAM, (4 x 8 GB), ECC, dual channel **8**

Bus module / swap media

- Bus module 11-slot: 7 x PCI, 3 x PCIe x4, 1 x PCIe x16; without swap media **0**
- Bus module 11-slot: 3 x PCI, 3 x PCIe x4, 5 x PCIe x16; without swap media **1**
- Bus module 11-slot: 7 x PCI, 3 x PCIe x4, 1 x PCIe x16; DVD±RW (slim) **2**
- Bus module 11-slot: 3 x PCI, 3 x PCIe x4, 5 x PCIe x16; DVD±RW (slim) **3**

Expansion hardware

- Without expansions (hardware), onboard graphics; **0**
- Without expansions (hardware), onboard graphics, DVI-I adapter cable, VGA-compliant for onboard graphics; **1**
- Serial (COM2) + parallel (LPT, 1 slot reserved), onboard graphics; **2**
- Serial (COM2) + parallel (LPT, 1 slot reserved), onboard graphics; DVI-I adapter cable, VGA-compliant for onboard graphics; **3**
- Serial (COM2) + Parallel (LPT, 1 slot reserved) + PCIe x16 Graphics Card (Dual-Head: 2 x VGA or 2 x DVI-D), 512 MB, (1 slot reserved); **4**

<sup>1)</sup> For an up-to-date overview, see the SIMATIC IPC online configurator at:  
<http://www.siemens.com/ipc-configurator>



**Ordering data****Article No.****Article No.**

Ordering data	Article No.
<b>SIMATIC IPC847D <sup>1)</sup></b>	<b>6AG4114 - 2</b>
<u>Operating system (preinstalled and activated)</u>	
• Windows 7 Ultimate, 32-bit MUI (Eng, Ger, Fr, It, Sp), SP1	<b>A</b>
• Windows 7 Ultimate, 64-bit MUI (Eng, Ger, Fr, It, Sp), SP1	<b>B</b>
• Windows Server 2008 R2 Standard Edition incl. 5 Clients, 64-bit, MUI (Eng, Ger, Fr, It, Sp), SP1	<b>F</b>
• Without operating system	<b>X</b>
<u>Expansions (software) / Security</u>	
• SIMATIC IPC DiagMonitor software V4.4 included	<b>A</b>
• SIMATIC IPC Image Creator software V3.3 included	<b>B</b>
• SIMATIC IPC DiagMonitor 4.4 and Image Creator Software 3.3 included	<b>C</b>
• Without software (software)	<b>X</b>
• Without expansions (software) / TPM (not for China and Russia)	<b>Y</b>
<u>Power supply, country-specific cable</u>	
• 110 / 240 V industrial power supply unit with NAMUR; power cable for Europe	<b>0</b>
• 110 / 240 V industrial power supply unit with NAMUR; power cable for United Kingdom	<b>1</b>
• 110 / 240 V industrial power supply unit with NAMUR; power cable for Switzerland	<b>2</b>
• 110 / 240 V industrial power supply unit with NAMUR; power cable for USA	<b>3</b>
• 110 / 240 V industrial power supply unit with NAMUR; power cable for Italy	<b>4</b>
• 110 / 240 V industrial power supply unit with NAMUR; power cable for China	<b>5</b>
• 2 x 110 / 240 V redundant power supply; without power cable	<b>6</b>

<sup>1)</sup> For an up-to-date overview, see the SIMATIC IPC online configurator at: <http://www.siemens.com/ipc-configurator>

Accessories**Memory expansions**

- 2 GB DDR3 1600 DIMM
- 4 GB DDR3 1600 DIMM
- 8 GB DDR3 1600 DIMM
- 8 GB DDR3 1600 DIMM, ECC

**6ES7648-2AJ50-0MA0**  
**6ES7648-2AJ60-0MA0**  
**6ES7648-2AJ70-0MA0**  
**6ES7648-2AJ70-1MA0**

Hardware accessories**Rack unit for low-profile removable drive bay**

For 3.5" hard drive (SATA/SAS) and 2.5" SSD (SATA), without drive

**6ES7648-0EG01-1BA0****Filter mats**

for SIMATIC IPC847D (packing unit: 10 units)

**A5E01064980****Adapter cable**

- DisplayPort to DVI-D for onboard graphics
- DisplayPort to VGA for onboard graphics

**6ES7648-3AF00-0XA0****6ES7648-3AG00-0XA0****Power cable, straight, 3 m long**

- Austria, Belgium, Finland, France, Germany, Netherlands, Spain, Sweden
- United Kingdom
- Switzerland
- USA
- Italy
- China

**6ES7900-0AA00-0XA0****6ES7900-0BA00-0XA0****6ES7900-0CA00-0XA0****6ES7900-0DA00-0XA0****6ES7900-0EA00-0XA0****6ES7900-0FA00-0XA0****Tower Kit**

for converting the computer into an industrial tower PC

**6ES7648-1AA00-0XD0****USB retainer**

for interlocking the internal USB port

**6ES7648-1AA00-0XK0**Expansion components

See catalog ST 80 / ST PC

Note:

Software Packages with SIMATIC WinCC flexible, WinCC RT Advanced, SIMATIC WinCC, and SIMATIC WinAC RTX (F) can be ordered together with the SIMATIC IPC at a price advantage. More information under "Embedded Bundles / Packages for industrial PCs".

**More information**

Additional information is available on the Internet at:

<http://www.siemens.com/simatic-pc>

**PROFINET/Industrial Ethernet**

Industrial PC

Box PC

## General data

## Overview

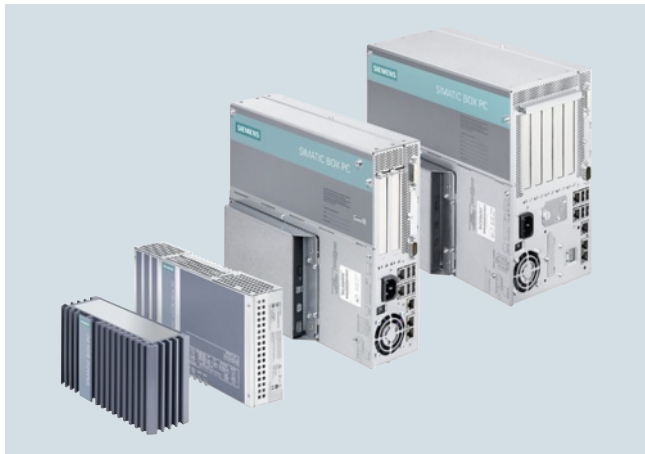

SIMATIC Box PC family

SIMATIC Box PCs provide mechanical engineers, plant engineers and control cabinet makers with particularly rugged industrial PC systems for use in powerful yet compact applications.

The following device classes are available for various requirements:

- **SIMATIC IPC227 (Nanobox PC):**  
The compact embedded IPC – maintenance-free and dust-proof with versatile mounting
- **SIMATIC IPC427 (Microbox PC):**  
The powerful embedded IPC – maintenance-free with versatile configuration
- **SIMATIC IPC627/IPC827 (Box PC):**  
The high-end IPC – with maximum performance, functional scope, and expansion capability

Shared industrial functionality:

- Extreme compactness
- Certification for global marketing
- System-tested with SIMATIC components
- High vibration/shock load during operation
- Wide operational temperature range
- Robust data storage with CompactFlash/CFast or Solid-State Drive (SSD)
- Integrated PROFIBUS or PROFIBUS/MPI interface (optional)
- Varied mounting possibilities for flexibility with installation
- Designed for 24-hour continuous operation
- Integrated parameterizable monitoring functions (temperature, fan, watchdog)
- High service friendliness
- Operating system preinstalled and activated for fast startup
- Motherboard developed and manufactured by Siemens
- Availability for 3 to 6 years
- Repairs and spare parts service for 5 years
- High component/design continuity
- Installation and software compatible with predecessor model
- Long-term availability of PC components from the Intel embedded line

**SIMATIC IPC227 (Nanobox PC):**  
**The compact embedded IPC – maintenance-free and dust-proof with versatile mounting**

- Maximum compactness with approx. 1 liter enclosure volume with integrated industrial power supply for minimum space requirements in the control cabinet
- Maximum flexibility thanks four mounting options and interfaces on one side suitable for every installation situation
- Optimum variety of interfaces due to a large number of integrated interfaces such as selectable serial ports (RS 232/RS 485/CAN) and 2 x teaming-capable Gigabit Ethernet
- Maximum industrial functionality due to closed enclosure for optimum dust protection and non-volatile retentive memory
- Further device options for optimum adaptation to the application with additional PCIe slot or RS 232 interfaces or digital I/O

**SIMATIC IPC427 (Microbox PC):**  
**The powerful embedded IPC – maintenance-free with versatile configuration**

- Fan-free operation
- High performance with maximum compactness and ruggedness for direct installation in the machine
- Optimized for embedded applications
- Flexibility expandable using one or two PCIe I/O cards (optional)
- Flexible installation options due to DIN rail/wall/front upright mounting, even outside a control cabinet
- NVRAM for retentive data storage (optional)

**SIMATIC IPC627/IPC827 (Box PC):**  
**The high-end IPC – with maximum performance, functional scope, and expansion capability**

- Maximum system performance for complex measuring, control and visualization tasks
- High flexibility with expansion slots and integral interfaces
- Flexible, space-saving installation with mounting brackets or portrait assembly kits
- Rugged design for direct installation in the machine
- RAID1 controller onboard
- Maximum processor performance up to ambient temperature of 55 °C
- High system availability
- Battery-backed SRAM as memory for WinAC data
- 4 signaling LEDs

## Benefits

### Compact dimensions

The SIMATIC IPC227D is a particularly compact and energy-efficient PC in the Nano format. The heart of the Nanobox PC with particularly many mounting options are high-performance Intel Atom processors of the latest generation.

The SIMATIC IPC427 (Microbox PC) is an ultra-compact and rugged device for DIN rail mounting, portrait or wall mounting, and for use in the machine: mounting depth from 47 mm.

With a maximum mounting depth of 100 mm (80 mm without DVD drive), the SIMATIC IPC627 (Box PC) can be used even in the smallest of spaces. In addition, space-saving portrait mounting is possible with the SIMATIC Box IPC627/IPC827.

### Rugged design

All designs aim to achieve maximum safety in the case of vibration and shock loads. For example, a special vibration-absorbing suspension of the hard disk ensures operational reliability, even at very high mechanical loads. A flash drive slot, which is easily accessible from outside, or the solid-state drive (SSD) in the single level cell (SLC) architecture, which is particularly suitable for industrial applications, is available for setting up low-maintenance, fault-tolerant, diskless systems. Thanks to its fan-free design and use of CompactFlash cards, the Microbox PC and the new Nanobox PC are especially suitable for maintenance-free 24-hour continuous operation.

### Service-friendly device design

The Box PC can simply be folded out for speedy component replacement. The inside of the device is easily accessible for future expansions.

### Integrated interfaces

On Box PCs, all interfaces are located on one side. Box PCs can be interfaced with the control/cell level via onboard Ethernet interfaces and communicate in the field via an integrated PROFIBUS interface, which is available as an option. External monitors or displays can be connected via a VGA or DVI-I interface.

### Flexibility

Especially the SIMATIC IPC827 with its 5 free PC slots offers many expansion options. All Box PCs have CE certification for use in industrial applications and domestic/commercial applications and can therefore be used in building automation or public installations in addition to industrial applications.

### Continuity

Thanks to motherboards developed and manufactured in-house, the SIMATIC Box PCs offer very high continuity and security of investment. The SIMATIC Box PC models can normally be ordered for a period of three years and spare parts are obtainable for at least 5 years after active marketing is concluded.

### System availability

SIMATIC Box PCs can be ordered in custom configurations and are supplied ready for use. The high system availability by design can be further extended by means of additional data backup options (e.g. RAID system, SIMATIC IPC Image & Partition Creator) and efficient software for self-diagnostics (SIMATIC IPC DiagMonitor).

## Technical specifications

	SIMATIC IPC227D (Nanobox PC)	SIMATIC IPC427D (Microbox PC)	SIMATIC IPC627D (Box PC)	SIMATIC IPC827D (Box PC)
<b>Design</b>				
Rail or wall mounting	•	•	-	-
Wall or portrait mounting	• Also: Side mounting	•	•	•
<b>General features</b>				
Processor	<ul style="list-style-type: none"> <li>Intel Atom E620 600 MHz</li> <li>Intel Atom E640 1.0 GHz</li> <li>Intel Atom E660 1.3 GHz</li> </ul>	<ul style="list-style-type: none"> <li>Intel Core i7-3517UE, 1.7 GHz, 4 MB SLC</li> <li>Intel Core i3-3217UE, 1.6 GHz, 3 MB SLC</li> <li>Intel Celeron 827E 1.4 GHz, 1.5 MB SLC</li> </ul>	<ul style="list-style-type: none"> <li>Intel Xeon processor E3-1268L v3 (4 cores, 8 threads, 2.3 (3.3) GHz, 8 MB cache, VT-d, AMT)</li> <li>Intel Core i3-4330TE processor (2 cores, 4 threads, 2.4 GHz, 4 MB cache, VT-x)</li> <li>Intel Celeron G1820TE (2C/2T, 2.2 GHz, 2 MB cache)</li> </ul>	<ul style="list-style-type: none"> <li>Intel Xeon processor E3-1268L v3 (4 cores, 8 threads, 2.3 (3.3) GHz, 8 MB cache, VT-d, AMT)</li> <li>Intel Core i3-4330TE (2 cores, 4 threads, 2.4 GHz, 4 MB cache, VT-x)</li> <li>Intel Celeron G1820TE (2C/2T, 2.2 GHz, 2 MB cache)</li> </ul>
Main memory	512 MB, 1 GB, 2 GB	1 GB, 2 GB, 4 GB, 8 GB	2 GB, expandable up to 16 GB, optional ECC	2 GB, expandable up to 16 GB, optional ECC
Static RAM	512 KB	512 KB	2 MB	2 MB
Free slots for expansions	1 x PCIe with PCIe enclosure option	Up to 2 x PCIe (enclosure option)	2 x PCI or 1 x PCIe x16 / 1 x PCI 2 x PCIe (x16/x4)	2 x PCI (240 mm) 1 x PCI (185 mm) 2 x PCI-Express x16 / x4 (185 mm)
Graphics	Onboard	Onboard	Onboard	Onboard

# PROFINET/Industrial Ethernet

## Industrial PC

### Box PC

#### General data

#### Technical specifications (continued)

	<b>SIMATIC IPC227D (Nanobox PC)</b>	<b>SIMATIC IPC427D (Microbox PC)</b>	<b>SIMATIC IPC627D (Box PC)</b>	<b>SIMATIC IPC827D (Box PC)</b>
<b>Operating system</b>				
without	•	•	•	•
Preinstalled and activated / supplied on restore CD	<ul style="list-style-type: none"> <li>Windows Embedded Standard 2009 (CF card ≥ 2 GB, SSD, hard disk)</li> <li>Windows XP Professional MUI (SSD, hard disk)</li> <li>Windows Embedded Standard 7, 32-bit (CF card ≥ 4 GB, SSD, hard disk)</li> <li>Windows 7 Ultimate MUI, 32-bit (SSD, hard disk)</li> </ul>	<ul style="list-style-type: none"> <li>Windows 7 Ultimate 32-bit MUI</li> <li>Windows 7 Ultimate 64-bit MUI</li> <li>Windows Embedded Standard 7, 32-bit (CFast ≥ 4 GB, SSD, hard disk)</li> <li>Windows Embedded Standard 7 Professional, 32-bit, MUI (CFast ≥ 8 GB, SSD, hard disk)</li> </ul>	<ul style="list-style-type: none"> <li>Windows 7 Ultimate 32-bit MUI</li> <li>Windows 7 Ultimate 64-bit MUI</li> </ul>	<ul style="list-style-type: none"> <li>Windows 7 Ultimate 32-bit MUI</li> <li>Windows 7 Ultimate 64-bit MUI</li> </ul>
Order separately	RMOS3 V3.50	RMOS3 V3.50	-	-
Project-specific on request	<ul style="list-style-type: none"> <li>Linux <sup>1)</sup></li> <li>Other</li> </ul>	<ul style="list-style-type: none"> <li>Linux <sup>1)</sup></li> <li>Other</li> </ul>	<ul style="list-style-type: none"> <li>Linux <sup>1)</sup></li> <li>Other</li> </ul>	<ul style="list-style-type: none"> <li>Linux <sup>1)</sup></li> <li>Other</li> </ul>
<b>Interfaces</b>				
PROFINET onboard	-	3 x RJ45 (CP 1616 compatible) onboard, optional	3 x RJ45 (CP 1616 compatible) onboard, optional	3 x RJ45 (CP 1616 compatible) onboard, optional
PROFIBUS/MPI	-	12 Mbps (CP 5622-compatible), optional	12 Mbps (CP 5622-compatible) onboard, optional	12 Mbps (CP 5622-compatible) onboard, optional
Ethernet	2 x 10/100/1000 Mbps	2 x 10/100/1000 Mbps	2 x 10/100/1000 Mbps	2 x 10/100/1000 Mbps
USB	4 x USB 2.0	-	4 x USB 3.0	4 x USB 3.0
Graphics	1 x DVI-D	<ul style="list-style-type: none"> <li>1 x DVI-I (DVI and VGA)</li> <li>1 x DisplayPort</li> </ul>	<ul style="list-style-type: none"> <li>1 x DVI-I (DVI and VGA)</li> <li>1 x DisplayPort</li> </ul>	<ul style="list-style-type: none"> <li>1 x DVI-I (DVI and VGA)</li> <li>1 x DisplayPort</li> </ul>
<b>Drives</b>				
Hard disks	1 x 2.5" (optional)	1 x 2.5" (optional)	<ul style="list-style-type: none"> <li>1 x 3.5"</li> <li>2 x 2.5"</li> <li>RAID1/2 x 2.5"</li> </ul>	<ul style="list-style-type: none"> <li>1 x 3.5"</li> <li>2 x 2.5"</li> <li>RAID1/2 x 2.5"</li> </ul>
Solid-state drive	1 x 2.5" SATA (optional)	1 x 2.5" SATA (optional)	1 x 2.5" SATA (optional)	1 x 2.5" SATA (optional)
FlashDrive	1 x CF externally accessible	<ul style="list-style-type: none"> <li>1 x CFast externally accessible</li> <li>1 x CFast internal, in place of HDD, SSD (optional)</li> </ul>	-	-
Optical drives	-	-	DVD R/W	DVD R/W
<b>Ambient conditions</b>				
Vibration/shock load during operation	1 g / 15 g (with FlashDrive)	1 g / 15 g (with FlashDrive)	1 g / 5 g	1 g / 5 g
Ambient temperature during operation	0 °C ... 50 °C (with FlashDrive) 0 °C ... 40 °C (with hard disk)	With maximum configuration: 0 ... 50/55 °C (with FlashDrive) 5 ... 40 °C (with hard disk)	With maximum configuration: 5 ... 45 °C 5 ... 50/55 °C (with 20/10 W load on USB, PCI(e) bus)	With maximum configuration: 5 ... 45 °C 5 ... 50/55 °C (with 20/10 W load on USB, PCI(e) bus)

• Available

- Not available

<sup>1)</sup> Suitable for specific Linux versions in accordance with the specifications of the Siemens manufacturer's declaration "Suitable for Linux", see [www.siemens.com/simatic-pc/suited-for-linux](http://www.siemens.com/simatic-pc/suited-for-linux) (Linux is a trademark of Linus Torvalds).

#### More information

Further information can be found on the Internet at:

<http://www.siemens.com/simatic-pc>

Information material can be ordered or downloaded from the Internet:

<http://www.siemens.com/simatic/printmaterial>

## Overview

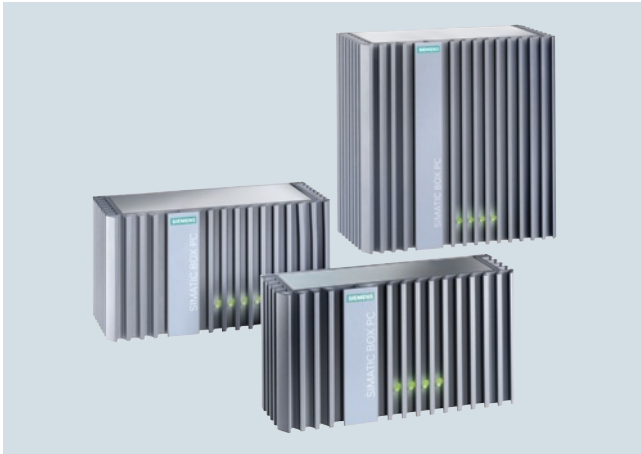

**SIMATIC IPC227D (Nanobox PC):**  
**The compact embedded IPC – maintenance-free and dust-proof with versatile mounting**

- Maximum compactness with approx. 1 liter enclosure volume or more with integrated industrial power supply for minimum space requirements in the control cabinet
- Maximum flexibility thanks four mounting options and interfaces on one side suitable for every installation situation
- Optimum variety of interfaces due to a large number of integrated interfaces such as a selectable serial port (RS 232/RS 485/CAN) and 2 x teaming-capable Gigabit LAN
- Maximum industrial functionality due to closed enclosure for optimum dust protection and non-volatile retentive memory
- Further device options for optimum adaptation to the application with additional PCIe slot or RS 232 interfaces or digital I/O

## Benefits

- Flexible installation (rail, wall, portrait, side mounting); all mounting positions are allowed
- Minimum space requirements (installation space of approx. 1 liter or more; all interfaces on one side, integrated industrial power supply)
- Up to 50 °C ambient temperature; dust protection due to closed enclosure
- LED for efficient self-diagnostics (e.g. using WinAC: Run/Stop, Error, Maintenance); optimized for headless operation
- Device options for optimum adaptation to the application (optional)
  - Simple expansion by means of a PCIe slot or
  - three additional RS232 interfaces or
  - four additional digital inputs and outputs each, 24 V DC

### High-performance data processing at low power consumption

- Intel Atom technology of the Power-Optimized family E6xx
- Power consumption from 8 W (low waste heat in protective enclosure/control cabinet)
- Wake-on-LAN for remote-controlled switching between standby and active state
- Support of Sleep States/SpeedStep (dynamic power adaptation depending on the required computing performance)
- Intel VT-x technology for virtualization

### High degree of industrial functionality and flexibility for implementing the embedded solution

- Flexible memory concepts: CompactFlash or more, Solid-State Drive, or hard drive
- 2 Gbit Ethernet (teaming-capable); PROFINET with RT functionality (via Standard Ethernet)
- 4 high-speed USB 2.0 ports
- 1 RS232; alternatively as: RS485 or CAN (optional)
- Ready-to-run embedded bundles with WinAC RTX2010 (F) and/or WinCC RT Advanced (optional)
- 512 KB retentive memory (MRAM), of which 128 KB can be written to within the buffer time (optional)
- Embedded and standard operating systems for selection: Windows Embedded Standard 2009 and Windows XP Prof. MUI; Windows Embedded Standard 7 32 bit and Windows 7 MUI 32 bit
- Suited for Linux certificate for simple, secure implementation of proprietary Linux-based solutions

### High system availability in order to reduce the risk of potential failures and maintenance costs

- Maintenance-free since there are no rotating parts (fans, HDD)
- Battery-free operation even if retentive memory option is selected (with time-of-day synchronization over network)
- Comprehensive self-diagnostics thanks to pre-installed local diagnostics software SIMATIC IPC DiagBase

### High investment security in order to reduce engineering costs

- Long-term availability: Service & Support period of 8 – 10 years after market launch

**PROFINET/Industrial Ethernet**

Industrial PC

Box PC

**SIMATIC IPC227D****Technical specifications**

	<b>6ES7647-8A...-....</b>
<b>Processor</b>	
Processor	Intel Atom E6x0
<b>Drives</b>	
Hard disk	CF or SSD or HD
<b>Memory</b>	
Main memory	512 MB to 2 GB
<b>Data areas and their retentivity</b>	
retentive data area in total (incl. times, counters, flags), max.	512 kbyte
<b>Interfaces</b>	
USB port	4x USB 2.0 high speed/high current
free slots	1x PCIe x1 (optional)
Connection for keyboard/mouse	USB / USB
serial interface	COM1: 1 x RS232 or RS485 or CAN
Video interfaces	
• Graphics interface	DVI-D
Industrial Ethernet	
• Industrial Ethernet interface	2 x Fast Ethernet
- 100 Mbps	Yes
- 1000 Mbps	Yes
<b>Monitoring functions</b>	
Temperature	Yes
Watchdog	Yes
Status LEDs	Yes

	<b>6ES7647-8A...-....</b>
<b>Degree and class of protection</b>	
IP (at the front)	20
<b>Standards, approvals, certificates</b>	
Approval	CE (industry), UL, cULus
CE mark	Yes
KC approval	Yes
Marine approval	
• Germanischer Lloyd (GL)	Yes
• American Bureau of Shipping (ABS)	Yes
• Bureau Veritas (BV)	Yes
• Det Norske Veritas (DNV)	Yes
• Lloyds Register of Shipping (LRS)	Yes
<b>Ambient conditions</b>	
Operating temperature	
• Ambient temperature during operation	
- during operating phase, min.	0 °C
- during operating phase, max.	50 °C
<b>Operating systems</b>	
Pre-installed operating system	Yes
Windows XP Prof.	Yes
without operating system	Yes

2

**Ordering data****Article No.****Article No.****SIMATIC IPC227D****6ES7647 - 8 A**

Atom E620 (600 MHz),  
512 MB RAM,  
without drive, with CF slot,  
COM1: RS232,  
without operating system,  
device version:  
Base, DIN rail,  
1 x DVI-D graphics interface  
2 x 10/100/1000 Mbps  
Ethernet RJ45  
4 x USB V2.0 (high current)  
CompactFlash slot  
24 V DC industrial power supply

Processors / memory configuration / NVRAM

- Atom E620 (600 MHz), 512 MB RAM **A**
- Atom E620 (600 MHz), 512 MB RAM, NVRAM **B**
- Atom E640 (1.0 GHz), 1 GB RAM **E**
- Atom E640 (1.0 GHz), 1 GB RAM, NVRAM **F**
- Atom E660 (1.3 GHz), 2 GB RAM **G**
- Atom E660 (1.3 GHz), 2 GB RAM, NVRAM **H**

Drives

- Without drive, with CF slot **0**
- 320 GB HDD SATA **1**
- 160 GB Solid-State Drive SATA **2**
- 80 GB Solid-State Drive SATA **4**
- 2 GB SIMATIC IPC CompactFlash **5**
- 4 GB SIMATIC IPC CompactFlash **6**
- 8 GB SIMATIC IPC CompactFlash **7**
- 16 GB SIMATIC IPC CompactFlash **8**

COM interface

- COM1: RS232 **0**
- COM1: RS485 **1**
- COM1: CAN **2**

Operating system

- Without operating system **0**
- Windows Embedded Standard 2009 preinstalled (CF from 2 GB/SSD/HD) **1**
- XP Prof. MUI preinstalled on SSD/HD **2**
- Windows Embedded Standard 7 (32-bit) preinstalled (CF from 4 GB/SSD/HD) **3**
- Windows 7 (32-bit) MUI preinstalled on SSD/HD **4**

**SIMATIC IPC227D****6ES7647 - 8 A**Software bundles

- Without RTX/HMI software **A**
- RTX: WinAC RTX 2010 **B**
- RTX-F: WinAC RTX F 2010 **C**
- HMI: WinCC RT Advanced 128 PT **F**
- HMI: WinCC RT Advanced 512 PT **G**
- HMI: WinCC RT Advanced 2048 PT **H**
- HMI/RTX: RT 128 PT **M**
- HMI/RTX: RT 512 PT **N**
- HMI/RTX: RT 2048 PT **P**
- HMI/RTX-F: RT 128 PT **R**
- HMI/RTX-F: RT 512 PT **S**
- HMI/RTX-F: RT 2048 PT **T**

Device versions

- Device version: Base line **A**
- Device version: PCIe (1 slot) **B**
- Device version: COM (COM2-4: RS232) **D**
- Device version: IO (4x dig. in/out each) **E**

Mounting accessories

- Standard mounting rail **1**
- Wall mounting **2**
- Portrait mounting **3**
- Side mounting **4**

Release for individual order variants:  
See releases in the ordering procedure.

Accessories**Cable strain relief set for IPC227D 6ES7648-1AA50-0XL0**

Packing unit: 5 units

**Dust protection set for IPC227D 6ES7648-1AA50-0XG0****More information**

Further information can be found on the Internet at:

<http://www.siemens.com/simatic-pc>

**PROFINET/Industrial Ethernet**

Industrial PC

Box PC

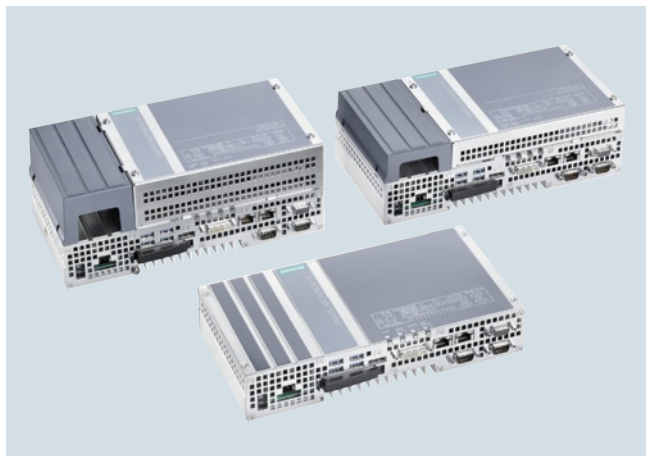
**SIMATIC IPC427D****Overview**

**SIMATIC IPC427D (Microbox PC):**  
**The powerful embedded IPC – maintenance-free**  
**with versatile configuration**

Ready-to-run, complete solutions (software is already installed and preconfigured) for visualization and automation in connection with WinCC RT Advanced and/or WinAC RTX:

- Ultra-compact
- Maintenance-free
- Third generation Intel Core i technology

**Benefits****High data processing speed for high productivity**

- Up to Core I 7, fan-free
- DDR3 memory technology up to 8 GB

**Maximum compactness and ruggedness for use directly on the machine**

- Low mounting depth, ambient temperature up to 55 °C
- Upright mounting as second standard mounting position (ambient temperature 50 °C)
- Solid State Drive (SSD) (50 GB high endurance or 80 GB standard, optional), SATA hard disk, or up to 2 CFAST cards with 16 GB

**High degree of industrial functionality and flexibility for implementing embedded solutions**

- Flexible memory concepts (e.g. 2 mass storage units possible)
- 2 x LAN 10/100/1 000 Mbit/s connections; teaming-capable
- Onboard PROFIBUS or PROFINET interface (optional)
- 4 x high-speed USB 3.0 ports; 2 serial interfaces (2nd interface is optional)
- Flexible installation with mounting options (rail, wall, front upright mounting)
- Simple expansion capability (up to 2 PCIe slots)
- On/off switch

**High system availability in order to reduce the risk of potential failures and maintenance costs**

- Maintenance-free since no rotating parts (fans, hard disks) and operation without battery possible
- 512 KB NVRAM can be written by WinAC RTX
- Front LED for efficient self-diagnostics; optimized for headless operation through special BIOS properties
- SIMATIC software system-tested

**High investment security in order to reduce engineering costs**

- Long-term availability: Service and support period of 8 to 10 years after market launch
- Installation and interface compatibility with predecessor versions as of 2004



**Technical specifications**

6AG4 140-.....0	
<b>Supply voltage</b>	
Type of supply voltage	24 V DC
Supply voltage	24 V
<b>Processor</b>	
Processor	Intel® Celeron® Processor 827E (1.5MB Cache, 1.40 GHz); Intel® Core™ i3-3217UE Processor (3MB Cache, 1.60 GHz); Intel® Core™ i7-3517UE Processor (4MB Cache, up to 2.80 GHz)
<b>Drives</b>	
Hard disk	2.5" SATA hard disk, at least 250 GB
<b>Memory</b>	
Main memory	1 GB to 8 GB, ECC optional
<b>Interfaces</b>	
PROFIBUS/MPI	Onboard, isolated, max. 12 Mbit/s, CP5611-compatible
USB port	4x USB 3.0 high speed/high current
free slots	1xPCIe (x4), 1xPCIe (x1)
Connection for keyboard/mouse	USB / USB
serial interface	1 x RS232; 2 x RS232 (optional); CAN (optional)
Video interfaces	
• Graphics interface	1x DisplayPort and 1x DVI-I; 1x VGA via adapter cable (optional)
<b>PROFINET IO</b>	
• Number of PROFINET interfaces	1; 3 ports (incl. switch)
<b>Industrial Ethernet</b>	
• Industrial Ethernet interface	2 x Fast Ethernet
- 100 Mbps	Yes
- 1000 Mbps	Yes
<b>Monitoring functions</b>	
Temperature	Yes
Watchdog	Yes
Status LEDs	Yes
<b>Degree and class of protection</b>	
IP (at the front)	20

6AG4 140-.....0	
<b>Standards, approvals, certificates</b>	
Approval	CE, cULus (508), C-Tick
CE mark	Yes
KC approval	Yes
cULus	Yes
EMC	CE, EN 55022A, EN 61000-6-4, EN 61000-6-2
EN 61000-6-2	Yes
<b>Marine approval</b>	
• Germanischer Lloyd (GL)	Yes
• American Bureau of Shipping (ABS)	Yes
• Bureau Veritas (BV)	Yes
• Det Norske Veritas (DNV)	Yes
• Lloyds Register of Shipping (LRS)	Yes
<b>Ambient conditions</b>	
Operating temperature	
• Ambient temperature during operation	0 °C to +55 °C
- during operating phase, min.	0 °C
- during operating phase, max.	55 °C
Relative humidity	
• Relative humidity	Tested to DIN IEC 60068-2-3, DIN IEC 60068-2-30, DIN IEC 60068-2-56: 5% to 80% at 25 °C (no condensation)
<b>Vibrations</b>	
• Vibration load in operation	Tested to DIN IEC 60068-2-6: 10 Hz to 58 Hz: 0.075 mm, 58 Hz to 200 Hz: 9.8 m/s <sup>2</sup> (1 g)
<b>Shock testing</b>	
• Shock load during operation	Tested to DIN IEC 60068-2-29: 50 m/s <sup>2</sup> (5g), 30 ms, 100 shocks
<b>Operating systems</b>	
Operating system	Windows 7 Ultimate (Multi Language) 32-bit/64-bit, Windows Embedded Standard 7 32-bit/64-bit
Pre-installed operating system	Yes
<b>Software</b>	
SIMATIC Software	Optionally with pre-installed software bundle SIMATIC WinCC RT Advanced / WinAC RTX

## PROFINET/Industrial Ethernet

## Industrial PC

## Box PC

## SIMATIC IPC427D

## Ordering data

## Article No.

## Article No.

SIMATIC IPC427D (Box PC) <sup>1) 2)</sup>

6AG4140 -

## Processor and fieldbus:

- Celeron U827E (1C/1T, 1.4 GHz, 1.5 MB cache); 2 x Gigabit Ethernet (IE/PN) 0
- Celeron U827E (1C/1T, 1.4 GHz, 1.5 MB cache); 2 x Gigabit Ethernet (IE/PN); PROFIBUS DP12 1
- Celeron U827E (1C/1T, 1.4 GHz, 1.5 MB cache); 2 x Gigabit Ethernet (IE/PN); CAN interface 2
- Core i3-3217UE (2C/4T, 1.6 GHz, 3 MB cache); 2 x Gigabit Ethernet (IE/PN) 3
- Core i3-3217UE (2C/4T, 1.6 GHz, 3 MB cache); 2 x Gigabit Ethernet (IE/PN); PROFIBUS DP12 4
- Core i3-3217UE (2C/4T, 1.6 GHz, 3 MB cache); 1 x Gigabit Ethernet (IE/PN); 1 x PROFINET (IRT, 3 ports) 5
- Core i7-3517UE (2C/4T, 1.7 (2.8) GHz, 3 MB cache); 2 x Gigabit Ethernet (IE/PN) (optional ECC only here) 6
- Core i7-3517UE (2C/4T, 1.7 (2.8) GHz, 3 MB cache); 2 x Gigabit Ethernet (IE/PN); PROFIBUS DP12 7
- Core i7-3517UE (2C/4T, 1.7 (2.8) GHz, 3 MB cache); 1 x Gigabit Ethernet (IE/PN); 1 x PROFINET (IRT, 3 ports) 8

## Mounting accessories:

- without mounting accessories A
- DIN rail mounting B
- Wall mounting D
- Portrait mounting E

## Work memory/NVRAM/ECC:

- 1 GB A
- 2 GB B
- 4 GB C
- 8 GB D
- 4 GB with ECC (only with Core i7, 2 x Gigabit Ethernet (IE/PN)) G
- 8 GB with ECC (only with Core i7, 2 x Gigabit Ethernet (IE/PN)) H
- 1 GB and NVRAM J
- 2 GB and NVRAM K
- 4 GB and NVRAM L
- 8 GB and NVRAM M
- 4 GB with ECC and NVRAM (only with Core i7, 2 x Gigabit Ethernet (IE/PN)) N
- 8 GB with ECC and NVRAM (only with Core i7, 2 x Gigabit Ethernet (IE/PN)) P

## Expansions/interface:

- One RS 232, without PCIe 0
- One RS 232 and one PCIe 1
- One RS 232 and two PCIe 2
- Second RS 232, without PCIe 3
- Second RS 232 and one PCIe 4
- Second RS 232 and second PCIe 5

## Operating system:

- Without operating system 0
- Windows Embedded Standard 7 Professional, 32-bit, MUI 3
- Windows Embedded Standard 7 SP1, English, 32-bit 4
- Windows Embedded Standard 7 SP1, English, 64-bit 5
- Windows 7 Ultimate SP1, 32-bit, MUI (Eng, Ger, Fr, It, Sp) 6
- Windows 7 Ultimate SP1, 64-bit, MUI (Eng, Ger, Fr, It, Sp) 7

SIMATIC IPC427D (Box PC) <sup>1) 2)</sup>

6AG4140 -

## Mass storage, externally accessible:

- Without external mass storage 0
- CFast 2 GB Without operating system 1
- CFast 4 GB (only optionally with operating system if no internal mass storage) 2
- CFast 8 GB (only optionally with operating system if no internal mass storage) 3
- CFast 16 GB (only optionally with operating system if no internal mass storage) 4

## Internal mass storage:

- Without internal mass storage A
- CFast 2 GB, without software B
- CFast 4 GB, without software C
- CFast 8 GB, without software D
- CFast 16 GB, without software E
- SSD 50 GB High Endurance (SLC) G
- SSD 80 GB Standard H
- HDD 250 GB K
- SSD 160 GB Standard P

## SIMATIC software preinstalled (bundles, only with Windows Embedded Standard 7):

- Without SIMATIC software A
- WinAC RTX 2010 <sup>3)</sup> B
- WinCC RT Advanced, 128 PT C
- WinCC RT Advanced, 512 PT D
- WinCC RT Advanced, 2 048 PT E
- WinCC RT Advanced, 4 096 PT F
- WinCC RT Advanced 128 PT, WinAC RTX 2010 <sup>3)</sup> J
- WinCC RT Advanced 512 PT, WinAC RTX 2010 <sup>3)</sup> K
- WinCC RT Advanced 2 048 PT, WinAC RTX 2010 <sup>3)</sup> L
- WinCC RT Advanced 4 096 PT, WinAC RTX 2010 <sup>3)</sup> M
- WinAC RTX F 2010 <sup>3)</sup> N
- WinCC RT Advanced 128 PT, WinAC RTX F 2010 <sup>3)</sup> P
- WinCC RT Advanced 512 PT, WinAC RTX F 2010 <sup>3)</sup> Q
- WinCC RT Advanced 2 048 PT, WinAC RTX F 2010 <sup>3)</sup> R
- WinCC RT Advanced 4 096 PT, WinAC RTX F 2010 <sup>3)</sup> S
- WinCC RT Professional Client/ single-user station 128 PT Y

## Power supply:

- 24 V DC industrial power supply 0
- 24 V DC and TPM (not for China and Russia) 8

<sup>1)</sup> "Built to order" – versions with a delivery time of max. 15 working days and with identified repair, if not preferred type.

<sup>2)</sup> For an up-to-date overview, see the SIMATIC PC online configurator at: [www.siemens.com/ipc-configurator](http://www.siemens.com/ipc-configurator)

<sup>3)</sup> Only with "main memory and NVRAM".

## Note:

Bundles with SIMATIC software only with Windows Embedded Standard 7, main memory and NVRAM (with RTX and RTX F), and CFast mass storage of 4 GB or more / SSD.

2

## Overview



IPC627D with DVD drive

**SIMATIC IPC627D (Box PC):**  
**The high-end IPC – with maximum performance,**  
**functional scope and expansion capability**

It offers:

- Maximum performance in the smallest space
- Intel Xeon technology

## Benefits

**Maximum system performance for complex measuring, control and visualization tasks**

- Intel processors: Xeon, Core i3 or Celeron; in each case with 4 or 2 cores, with turbo-boost technology and AMT (Xeon) and hyper-threading (Xeon, i3)
- Intel DH82C226 PCH Platform Controller Hub (PCH)
- DDR3 1600 memory technology up to 16 GB RAM
- Intel HD 4600 (Xeon, i3) graphics for high graphics performance
- PCI Express x16 slot for x16 graphics card support
- SATA hard disks with up to 500 GB capacity and NCQ technology (Native Command Queuing) for larger data volumes

**Highly compact design for space-saving and flexible installation**

- Compact housing design (volume 6 liters)
- Flexible installation in many different positions with mounting brackets or portrait installation kits
- Free expansion slots: 2 x PCI or 2 x PCIe or 1 x PCIe and 1 x PCI
- 3 X PROFINET interfaces onboard (optional, IRT-capable, 3-port, switching-enabled, CP 1616-compatible)
- 1 x PROFIBUS interface onboard (optional, CP 5622-compatible)
- 2 x LAN 10/100/1000 Mbit/s connections (Gigabit Ethernet with teaming capability), PROFINET RT-compatible
- 4 x USB 3.0 (SuperSpeed)
- DisplayPort and DVI-I interface (for VGA or DVI-D monitors)

**Rugged design for direct installation in the machine**

- Maximum processor performance up to ambient temperature of 55 °C
- High shock/vibration resistance in all possible mounting positions
- High EMC for safe operation
- SATA Solid-State Drive (SSD) with 240 GB for high reliability and speed
- Strain relief for all cables/connectors

**High system availability, fast startup, maintenance and servicing**

- High degree of data security thanks to mirror disk system (RAID1, optional) or Solid State Drive (SSD, optional)
- ECC memory (optional, for 1-bit error correction)
- 2 MB battery-buffered SRAM, 128 KB of which can be used as memory for retentive WinAC RTX data
- Active Management Technology (Intel AMT) for Xeon versions (remote access to the device, also in shut-down state)
- CMOS buffer battery accessible from outside, replaceable during operation. Status can be scanned by software.
- 4 LEDs – 1 x power and 3 x applications (WinAC)
- Operating system preinstalled, ready to run, and already activated (eliminates need for usual product activation via the Internet or by telephone)
- Following system failure, fast restoration of hard disk contents to as-delivered status using supplied recovery and restore CD
- Worldwide service and support

**Cost reductions through high investment security**

- Platform with long-term stability and embedded Intel components
- Availability of 3 to 6 years, then guaranteed availability of spare parts for further 5 years
- Part of the scalable Box PC range with identical performance features and footprint
- System-tested with SIMATIC components
- Certification for worldwide marketing (e.g.: cULus)
- Installation compatible for all device generations, software compatible with predecessor model

# PROFINET/Industrial Ethernet

## Industrial PC

### Box PC

#### SIMATIC IPC627D

#### Technical specifications

SIMATIC IPC627D	
<b>General features</b>	
Processor	<ul style="list-style-type: none"> <li>Intel Xeon Processor E3-1268L v3 (4C, 2.3 (3.3) GHz, HT, 8 MB cache, HT, VT-d, AMT)</li> <li>Intel Core i3-4330TE (2C, 2.4 GHz, 4 MB cache, HT, VT-x)</li> <li>Intel Celeron G1820TE (2C, 2.2 GHz, 2 MB cache)</li> </ul>
Main memory	2 GB; DDR3 1600, DIMM; expandable up to 16 GB (2 memory receptacles); ECC memory 8/16 GB optional
Free slots for expansions	<ul style="list-style-type: none"> <li>1 x PCI (185 mm) and 1 x PCI (185 mm) or</li> <li>1 x PCI (185 mm) and 1 x PCIe x16 (185 mm)</li> <li>2 x PCI-Express (x16/x4, 185/185 mm)</li> </ul>
<b>Operating system</b>	
Operating system	<ul style="list-style-type: none"> <li>Without</li> <li>Windows 7 Ultimate Multi-Language – 32-bit or 64-bit variant, SP1</li> </ul>
Supply voltage	100 V / 230 V / 240 V AC (widerange) 50/60 Hz; optional 24 V DC
<b>Drives</b>	
Optical drives	SATA DVD±RW/DL Drive, optional (Depth increases from 80 mm to 100 mm)
SATA hard disks	None; 250 GB, 500 GB, RAID1 (2 x 250 GB)
Solid state drive	240 GB SATA 2.5"
<b>Approvals</b>	
cULus508, cULus1950, FCC Class A	
<b>Ports</b>	
DisplayPort	1 x DisplayPort
DVI-I	1 x (analog OR digital)
VGA	Via adapter cable, DVI-I to VGA adapter (available as accessory)
Dual Monitor	Via DisplayPort and DVI-I
Parallel interface	PC slot cover (available as accessory)
Serial interface	1 x COM1
PROFIBUS/MPI	12 Mbit/s (isolated, CP 5622-compatible, optional)
PROFINET	3 x RJ45 (CP 1616-compatible, optional) <sup>1)</sup>
USB	4 x USB 3.0, SuperSpeed; 2 x USB 2.0 (optional)
Ethernet	2 x Gigabit Ethernet (IE, PN, RJ45, teaming-capable)

<sup>1)</sup> Note:  
The PROFINET and PROFIBUS options are supplied with 2 MB battery-backed SRAM

SIMATIC IPC627D	
<b>Monitoring functions</b>	
Temperature and Watchdog	Onboard
Status LEDs	4 LEDs
<b>Ambient conditions</b>	
<b>Degree of protection</b>	
IP20 according to EN 60529 (front/rear)	
Vibration load during operation <sup>2)</sup>	<ul style="list-style-type: none"> <li>10 ... 58 Hz: 0.75 mm<sub>rms</sub></li> <li>58 ... 500 Hz: 9.8 m/s<sup>2</sup> (approx. 1 g)</li> <li>with DVD operation: <ul style="list-style-type: none"> <li>10 ... 58 Hz: 0.018 mm<sub>rms</sub></li> <li>58 ... 500 Hz: 2.5 m/s<sup>2</sup> (approx. 0.25 g)</li> </ul> </li> </ul>
Shock load during operation <sup>3)</sup>	<ul style="list-style-type: none"> <li>Tested according to DIN IEC 68-2-29: 50 m/s<sup>2</sup> (5 g),</li> <li>with DVD operation: 50 ms<sup>2</sup>, 11 ms (5 g)</li> </ul>
Relative humidity during operation	5 % to 80 % at 25°C (no condensation);
Relative humidity during transport / storage	5% to 95% at 25 °C (no condensation)
<b>Electromagnetic compatibility (EMC)</b>	
Emitted interference	EN 61000-6-3, EN 61000-3-2 Class D, EN 61000-3-3; FCC Class A
Immunity to interference	<ul style="list-style-type: none"> <li>to conducted interference on the supply cables <ul style="list-style-type: none"> <li>± 2 kV (IEC 61000-4-4, burst),</li> <li>± 1 kV (IEC 61000-4-5, surge symm.),</li> <li>± 2 kV (IEC 61000-4-5, surge asymm.)</li> </ul> </li> <li>on signal cables <ul style="list-style-type: none"> <li>± 1 kV (IEC 61000-4-4, burst, length &lt; 3 m),</li> <li>± 2 kV (IEC 61000-4-4, burst, length &gt; 3 m),</li> <li>± 2 kV (IEC 61000-4-5, surge, length &gt; 30 m)</li> </ul> </li> <li>to discharge of static electricity <ul style="list-style-type: none"> <li>± 6 kV contact discharge (IEC 61000-4-2),</li> <li>± 8 kV air discharge (IEC 61000-4-2)</li> </ul> </li> <li>to high-frequency radiation <ul style="list-style-type: none"> <li>10 V/m 80% AM, 80-1000 MHz and 1.4 - 2 GHz (IEC 61000-4-3);</li> <li>1 V/m 80% AM, 2.0-2.7 GHz (IEC 61000-4-3),</li> <li>10 V, 10 kHz to 80 MHz (IEC 61000-4-6)</li> </ul> </li> <li>to magnetic fields <ul style="list-style-type: none"> <li>100 A/m, 50/60 Hz (IEC 61000-4-8)</li> </ul> </li> <li>Ambient temperature during operation <ul style="list-style-type: none"> <li>5 to 45 °C (maximum configuration);</li> <li>5 to 50 °C (up to 20 W load on PCI bus),</li> <li>5 to 55 °C (up to 10 W load on PCI bus)</li> </ul> </li> </ul>
<b>Dimensions</b>	
Device dimensions (W x H x D) in mm	312 x 301 (incl. mounting rail) x 105 without DVD drive; 312 x 301 (incl. mounting rail) x 80
<b>Weight</b>	approx. 7 kg

<sup>2)</sup> No vibration permitted when burning DVDs;

<sup>3)</sup> No shock permitted when burning DVDs

Ordering data	Article No.	Article No.
<b>SIMATIC IPC627D<sup>1)</sup></b>	<b>6AG4131 - 2</b>	<b>SIMATIC IPC627D<sup>1)</sup></b>
HD graphics onboard (Xeon, i3: HD4600); 2 x Gigabit Ethernet (IE/PN) RJ45; 4 x USB V3.0; 1 x serial (COM1); RAID controller onboard; watchdog, temp./fan monitoring;  <u>Processor:</u> <ul style="list-style-type: none"> <li>Core i3-4330TE (2C/4T, 2.4 GHz, 4 MB cache, VT-x);</li> <li>Core i3-4330TE (2C/4T, 2.4 GHz, 4 MB cache, VT-x); PROFIBUS/MPI (CP 5622-compatible); 2 MB battery-backed SRAM;</li> <li>Core i3-4330TE (2C/4T, 2.4 GHz, 4 MB cache, VT-x); PROFINET (IRT, 3 ports, CP 1616-compatible); 2 MB battery-backed SRAM;</li> <li>Xeon E3-1268Lv3 (4C/8T, 2.3 (3.3) GHz, 8 MB cache, VT-d, AMT);</li> <li>Xeon E3-1268Lv3 (4C/8T, 2.3 (3.3) GHz, 8 MB cache, VT-d, AMT); PROFIBUS/MPI (CP 5622-compatible); 2 MB battery-backed SRAM;</li> <li>Xeon E3-1268Lv3 (4C/8T, 2.3 (3.3) GHz, 8 MB cache, VT-d, AMT); PROFINET (IRT, 3 ports, CP 1616-compatible); 2 MB battery-backed SRAM;</li> </ul>		<u>Operating system</u> <ul style="list-style-type: none"> <li>Windows 7 Ultimate, 32-bit SP1, MUI (Eng, Ger, Fr, It, Sp);</li> <li>Windows 7 Ultimate, 64-bit SP1, MUI (Eng, Ger, Fr, It, Sp);</li> <li>Without</li> </ul>
<u>Drives</u> <ul style="list-style-type: none"> <li>250 GB HDD SATA;</li> <li>250 GB HDD SATA; DVD+/-RW;</li> <li>500 GB HDD SATA;</li> <li>500 GB HDD SATA; DVD+/-RW;</li> <li>RAID1 2 x 250 GB SATA (2.5");</li> <li>RAID1 2 x 250 GB SATA (2.5"); DVD+/-RW;</li> <li>Solid-state drive 240 GB;</li> <li>Solid-state drive 240 GB; 250 GB HDD SATA (2.5");</li> <li>Solid-state drive 240 GB; 250 GB HDD SATA (2.5"); DVD+/-RW;</li> </ul>		<u>expansions (SW)</u> <ul style="list-style-type: none"> <li>SIMATIC IPC DiagMonitor V4.x enclosed;</li> <li>SIMATIC IPC Image &amp; Partition Creator V3.x enclosed;</li> <li>SIMATIC IPC DiagMonitor V4.x, Image &amp; Partition Creator V3.x enclosed;</li> <li>Without</li> <li>TPM module (not for China and Russia);</li> </ul>
<u>Memory configuration</u> <ul style="list-style-type: none"> <li>2 GB DDR3 1600 DIMM;</li> <li>4 GB DDR3 1600 DIMM;</li> <li>8 GB DDR3 1600 DIMM;</li> <li>16 GB DDR3 1600 DIMM;</li> <li>8 GB DDR3 1600 DIMM; ECC;</li> <li>16 GB DDR3 1600 DIMM; ECC;</li> </ul>		<u>Country-specific version/ power supply</u> <ul style="list-style-type: none"> <li>110/230 V AC industrial power supply with NAMUR; European power cable;</li> <li>110/230 V AC industrial power supply with NAMUR; UK power cable;</li> <li>110/230 V AC industrial power supply with NAMUR; power cable for Switzerland;</li> <li>110/230 V AC industrial power supply NAMUR; US power cable;</li> <li>110/230 V AC industrial power supply NAMUR; power cable for Italy;</li> <li>110/230 V AC industrial power supply with NAMUR; power cable for China</li> <li>24 V DC industrial power supply;</li> </ul>
<u>Expansion 1 (HW)</u> <ul style="list-style-type: none"> <li>2 x PCI;</li> <li>1 x PCIe (x16); 1 x PCI;</li> <li>1 x PCIe (x16); 1 x PCIe (x4);</li> </ul>		
<u>Expansion 2 (HW)</u> <ul style="list-style-type: none"> <li>Without expansions (HW);</li> <li>2 x USB in addition (1 slot occupied);</li> <li>COM2; LPT (1 slot occupied);</li> <li>2 x USB in addition; COM2; LPT (2 slots occupied);</li> </ul>		
		<u>Accessories</u> <b>Memory expansion</b> <ul style="list-style-type: none"> <li>2 GB DDR3 1600 SDRAM, DIMM</li> <li>4 GB DDR3 1600 SDRAM, DIMM</li> <li>8 GB DDR3 1600 SDRAM, DIMM</li> <li>8 GB DDR3 1600 SDRAM, DIMM, ECC</li> </ul> <b>Assembly kit for portrait mounting</b> <ul style="list-style-type: none"> <li>Upward or downward interface outlet</li> <li>Interface outlet to the front</li> </ul> <b>SIMATIC PC graphics adapter cable</b> DVI-I acc. to VGA, 250 mm long  <b>SIMATIC PC power cable</b> for Box PC and Panel PC, 230 V AC, angled, 3 m <ul style="list-style-type: none"> <li>for Germany, France, Spain, the Netherlands, Belgium, Sweden, Austria, Finland</li> <li>for United Kingdom</li> <li>For Switzerland</li> <li>For the USA</li> <li>For Italy</li> <li>For China</li> </ul>

### More information

Additional information is available on the Internet at:

<http://www.siemens.com/simatic-pc>

**PROFINET/Industrial Ethernet**

Industrial PC

Box PC

**SIMATIC IPC827D****Overview**

**SIMATIC IPC827D (Box PC):**  
**The high-end IPC – with maximum performance,**  
**functional scope and expansion capability**

It offers:

- Maximum performance and high expandability
- with Intel Xeon technology

**Benefits**

**Maximum system performance for complex measuring,**  
**control and visualization tasks**

- Intel processors: Xeon, Core i3 or Celeron; in each case with 2 cores, with turbo-boost technology and AMT (Xeon) and hyper-threading (Xeon, i3)
- Intel DH82C226 PCH Platform Controller Hub (PCH)
- DDR3 1600 memory technology up to 16 GB RAM
- Intel HD 4600 (Xeon, i3) graphics for high graphics performance
- PCI Express x16 slot for x16 graphics card support
- SATA hard disks with up to 500 GB capacity and NCQ technology (Native Command Queuing) for a larger data volume

**High flexibility and expandability**

- Flexible installation in many different positions with mounting brackets or portrait assembly kit
- Vacant expansion slots: 3 x PCI, 1 x PCIe Express (x16) and 1 x PCIe (x4)
- 3 x PROFINET interfaces onboard (optional, IRT-capable, 3-port, switching-enabled, CP1616-compatible)
- 1 x PROFIBUS interface onboard (optional, CP5622-compatible)
- RAID1 controller onboard (no occupation of a PC slot)
- 2 x LAN 10/100/1000 Mbit/s connections (Gigabit Ethernet with teaming capability), PROFINET RT-compatible
- 4 x USB-3.0 ports (SuperSpeed)
- DisplayPort and DVI-I interface (for VGA and/or DVI-D monitors)

**Rugged design for direct installation in the machine**

- Maximum processor performance up to an ambient temperature of 55 °C
- High shock/vibration resistance in all possible mounting positions
- High EMC for safe operation
- SATA Solid-State Drive (SSD) with 240 GB for high reliability and speed
- Strain relief for all cables/connectors

**High system availability, fast startup, maintenance and servicing**

- High degree of data security thanks to mirror disk system (RAID1, optional) or Solid State Drive (SSD, optional)
- ECC memory (optional, for 1-bit error correction)
- 2 MB battery-backed SRAM, of which 128 KB can be used as memory for retentive WinAC RTX data
- Active Management Technology (Intel AMT) for Xeon versions (remote access to the device, also in shut-down state)
- Externally accessible CMOS backup battery, replaceable during operation, status can be scanned by software
- 4 LEDs – 1 x power and 3 x applications (WinAC)
- Operating system preinstalled, ready to run, and already activated (eliminates need for usual product activation via the Internet or by telephone)
- Following system failure, fast restoration of hard disk contents to factory status using supplied recovery and restore DVD
- Worldwide service and support

**Cost reductions through high investment security**

- Long-term platform with Intel embedded components
- Availability of 3 to 6 years, then guaranteed availability of spare parts for further 5 years
- Part of the scalable Box PC range with identical performance features and footprint
- System-tested with SIMATIC hardware and software
- Certification for worldwide marketing (e.g.: cULus)
- Installation compatible for all device generations, software compatible with predecessor model

**Technical specifications**

SIMATIC IPC827D	
<b>General features</b>	
Processor	<ul style="list-style-type: none"> <li>Intel Xeon Processor E3-1268L v3 (4C, 2.3 (3.3) GHz, HT, 8 MB cache, HT, VT-d, AMT)</li> <li>Intel Core i3-4330TE (2C, 2.4 GHz, 4 MB cache, HT, VT-x)</li> <li>Intel Celeron G1820TE (2C, 2.2 GHz, 2 MB cache)</li> </ul>
Main memory	2 GB; DDR3 1600, DIMM; expandable up to 16 GB (2 memory receptacles); ECC memory 8/16 GB optional
Free slots for expansions	2 x PCI (240 mm) 1 x PCI (185 mm) 2 x PCI-Express (x16/x4, 185/185 mm)
<b>Operating system</b>	
Operating system	<ul style="list-style-type: none"> <li>Without</li> <li>Windows 7 Ultimate Multi-Language – 32-bit or 64-bit variant, SP1</li> </ul>
Supply voltage	100 V / 230 V / 240 V AC (widerange) 50/60 Hz; optional 24 V DC
<b>Drives</b>	
Optical drives	DVD±RW/DL SATA, optional (depth increases from 155 mm to 179 mm)
SATA hard disks	None; 250 GB, 500 GB, RAID1 (2 x 250 GB)
Solid state drive	240 GB SATA 2.5*
<b>Approvals</b>	
cULus508, cULus1950, FCC Class A	
<b>Ports</b>	
DisplayPort	1 x DisplayPort
DVI-I	1 x (analog OR digital)
VGA	Via adapter cable, DVI-I to VGA adapter (available as accessory)
Dual Monitor	Via DisplayPort and DVI-I
Parallel interface	PC slot cover (available as accessory)
Serial interface	1 x COM1
PROFIBUS/MPI	12 Mbit/s (isolated, CP 5622-compatible, optional)
PROFINET	3 x RJ45 (CP 1616-compatible, optional) <sup>1)</sup>
USB	4 x USB 3.0, SuperSpeed; 2 x USB 2.0 (optional)
Ethernet	2 x Gigabit Ethernet (IE, PN, RJ45, teaming-capable)
<b>Monitoring functions</b>	
Temperature and Watchdog	Onboard
Status LEDs	4 LEDs

SIMATIC IPC827D	
<b>Ambient conditions</b>	
<b>Degree of protection</b>	
IP20 according to EN 60529 (front/rear)	
Vibration load in operation <sup>2)</sup>	<ul style="list-style-type: none"> <li>10 ... 58 Hz: 0.75 mm<sub>rms</sub></li> <li>58 ... 500 Hz: 9.8 m/s<sup>2</sup> (approx. 1 g)</li> <li>with DVD operation: <ul style="list-style-type: none"> <li>10 ... 58 Hz: 0.018 mm<sub>rms</sub></li> <li>58 ... 500 Hz: 2.5 m/s<sup>2</sup> (approx. 0.25 g)</li> </ul> </li> </ul>
Shock load during operation <sup>3)</sup>	<ul style="list-style-type: none"> <li>Tested according to DIN IEC 68-2-29: 50 m/s<sup>2</sup> (5 g),</li> <li>with DVD operation: 50 ms<sup>2</sup>, 11 ms (5 g)</li> </ul>
Relative humidity during operation	5 % to 80 % at 25°C (no condensation);
Relative humidity during transport / storage	5% to 95% at 25°C (no condensation)
<b>Electromagnetic compatibility (EMC)</b>	
Emitted interference	EN 61000-6-3, EN 61000-3-2 Class D, EN 61000-3-3; FCC Class A
Immunity to interference	
<ul style="list-style-type: none"> <li>to conducted interference on the supply cables</li> </ul>	<ul style="list-style-type: none"> <li>± 2 kV (IEC 61000-4-4, burst),</li> <li>± 1 kV (IEC 61000-4-5, surge symm.),</li> <li>± 2 kV (IEC 61000-4-5, surge asymm.)</li> </ul>
<ul style="list-style-type: none"> <li>on signal cables</li> </ul>	<ul style="list-style-type: none"> <li>± 1 kV (IEC 61000-4-4, burst, length &lt; 3 m),</li> <li>± 2 kV (IEC 61000-4-4, burst, length &gt; 3 m),</li> <li>± 2 kV (IEC 61000-4-5, surge, length &gt; 30 m)</li> </ul>
<ul style="list-style-type: none"> <li>to discharge of static electricity</li> </ul>	<ul style="list-style-type: none"> <li>± 6 kV contact discharge (IEC 61000-4-2),</li> <li>± 8 kV air discharge (IEC 61000-4-2)</li> </ul>
<ul style="list-style-type: none"> <li>to high-frequency radiation</li> </ul>	<ul style="list-style-type: none"> <li>10 V/m 80% AM, 80-1000 MHz and 1.4 - 2 GHz (IEC 61000-4-3);</li> <li>1 V/m 80% AM, 2.0-2.7 GHz (IEC 61000-4-3),</li> <li>10 V, 10 kHz to 80 MHz (IEC 61000-4-6)</li> </ul>
<ul style="list-style-type: none"> <li>to magnetic fields</li> </ul>	<ul style="list-style-type: none"> <li>100 A/m, 50/60 Hz (IEC 61000-4-8)</li> </ul>
<ul style="list-style-type: none"> <li>Ambient temperature during operation</li> </ul>	<ul style="list-style-type: none"> <li>5 to 45 °C (maximum configuration);</li> <li>5 to 50 °C (up to 20 W load on PCI bus),</li> <li>5 to 55 °C (up to 10 W load on PCI bus)</li> </ul>
<b>Dimensions</b>	
Device dimensions (W x H x D) in mm	312 x 301 (incl. mounting rail) x 179 without DVD drive; 312 x 301 (incl. mounting rail) x 155
<b>Weight</b>	
approx. 8 kg	

<sup>1)</sup> Note: The PROFINET and PROFIBUS options are supplied with 2 MB battery-backed SRAM

<sup>2)</sup> No vibration permitted when burning DVDs;

<sup>3)</sup> No shock permitted when burning DVDs

## PROFINET/Industrial Ethernet

## Industrial PC

## Box PC

## SIMATIC IPC827D

## Ordering data

## Article No.

## Article No.

SIMATIC IPC827D <sup>1)</sup>

## 6AG4132 - 2

HD graphics onboard  
(Xeon, i3: HD4600);  
2 x Gigabit Ethernet (IE/PN) RJ45;  
4 x USB V3.0;  
1x serial (COM1);  
RAID controller onboard;  
watchdog, temp./fan monitoring;

## Processor:

- Celeron G1820TE (2C/2T, 2.2 GHz, 2 MB cache) **A**
- Celeron G1820TE (2C/2T, 2.2 GHz, 2 MB cache); PROFIBUS/MPI (CP 5622-compatible); 2 MB battery-backed SRAM <sup>2)</sup> **B**
- Celeron G1820TE (2C/2T, 2.2 GHz, 2 MB cache); PROFINET (IRT, 3 ports, CP 1616-compatible); 2 MB battery-backed SRAM **C**
- Core i3-4330TE (2C/4T, 2.4 GHz, 4 MB cache, VT-x) **D**
- Core i3-4330TE (2C/4T, 2.4 GHz, 4 MB cache, VT-x); PROFIBUS/MPI (CP 5622-compatible); 2 MB battery-backed SRAM <sup>2)</sup> **E**
- Core i3-4330TE (2C/4T, 2.4 GHz, 4 MB cache, VT-x); PROFINET (IRT, 3 ports, CP 1616-compatible); 2 MB battery-backed SRAM **F**
- Xeon E3-1268Lv3 (4C/8T, 2.3 (3.3) GHz, 8 MB cache, VT-d, AMT) **G**
- Xeon E3-1268Lv3 (4C/8T, 2.3 (3.3) GHz, 8 MB cache, VT-d, AMT); PROFIBUS/MPI (CP 5622-compatible); 2 MB battery-backed SRAM <sup>2)</sup> **H**
- Xeon E3-1268Lv3 (4C/8T, 2.3 (3.3) GHz, 8 MB cache, VT-d, AMT); PROFINET (IRT, 3 ports, CP 1616-compatible); 2 MB battery-backed SRAM **J**

## Drives

- 250 GB HDD SATA; **A**
- 250 GB HDD SATA; DVD+/-RW; **B**
- 500 GB HDD SATA; **D**
- 500 GB HDD SATA; DVD+/-RW; **E**
- RAID1 2 x 250 GB SATA (2.5"); **G**
- RAID1 2 x 250 GB SATA (2.5"); DVD+/-RW **H**
- Solid-state drive 240 GB; **M**
- Solid-state drive 240 GB; 250 GB HDD SATA (2.5"); **N**
- Solid-state drive 240 GB; 250 GB HDD SATA (2.5"); DVD+/-RW; **P**

## Memory configuration

- 2 GB DDR3 1600 DIMM; **1**
- 4 GB DDR3 1600 DIMM; **2**
- 8 GB DDR3 1600 DIMM; **3**
- 16 GB DDR3 1600 DIMM; **4**
- 8 GB DDR3 1600 DIMM; ECC; **5**
- 16 GB DDR3 1600 DIMM; ECC; **6**

## Expansions (HW)

- 1 x PCIe (x16); 1 x PCIe (x4); 3 x PCI **0**

## Expansion 2 (HW)

- Without expansions (HW); **0**
- 2 x USB in addition (1 slot occupied); **1**
- COM2: LPT (1 slot occupied); **2**
- 2 x USB in addition; COM2; LPT (2 slots occupied); **3**

SIMATIC IPC827D <sup>1)</sup>

## 6AG4132 - 2

## Operating system

- Windows 7 Ultimate, 32-bit SP1, MUI (Eng, Ger, Fr, It, Sp); **A**
- Windows 7 Ultimate 64-bit SP1, MUI (Eng, Ger, Fr, It, Sp); **B**
- Without **X**

## expansions (SW)

- SIMATIC IPC DiagMonitor V4.x enclosed; **A**
- SIMATIC IPC Image & Partition Creator V3.x enclosed; **B**
- SIMATIC IPC DiagMonitor V4.x, Image & Partition Creator V3.x enclosed; **C**
- Without **X**
- TPM module (not for China and Russia); **Y**

Country-specific version/  
power supply

- 110/230 V AC industrial power supply with NAMUR; European power cable; **0**
- 110/230 V AC industrial power supply with NAMUR; UK power cable; **1**
- 110/230 V AC industrial power supply with NAMUR; power cable for Switzerland; **2**
- 110/230 V AC industrial power supply NAMUR; US power cable; **3**
- 110/230 V AC industrial power supply NAMUR; power cable for Italy; **4**
- 110/230 V AC industrial power supply with NAMUR; power cable for China **5**
- 24 V DC industrial power supply; **6**

<sup>1)</sup> For an up-to-date overview, see the SIMATIC PC online configurator at: [www.siemens.com/ipc-configurator](http://www.siemens.com/ipc-configurator)

<sup>2)</sup> Expected start of delivery: 2nd quarter 2014

## Accessories

## Memory expansion

- 2 GB DDR3 1600 SDRAM, DIMM **6ES7648-2AJ50-0MA0**
- 4 GB DDR3 1600 SDRAM, DIMM **6ES7648-2AJ60-0MA0**
- 8 GB DDR3 1600 SDRAM, DIMM **6ES7648-2AJ70-0MA0**
- 8 GB DDR3 1600 SDRAM, DIMM, ECC **6ES7648-2AJ70-1MA0**

## Assembly kit for portrait mounting

- Upward or downward interface outlet **6ES7648-1AA30-1YA0**
- Interface outlet to the front **6ES7648-1AA30-1YB0**

## SIMATIC PC graphics adapter cable

DVI-I acc. to VGA, 250 mm long **6ES7648-3AB00-0XA0**

## SIMATIC PC power cable

- for Box PC and Panel PC, 230 V AC, angled, 3 m
- for Germany, France, Spain, the Netherlands, Belgium, Sweden, Austria, Finland **6ES7900-1AA00-0XA0**
  - for the United Kingdom **6ES7900-1BA00-0XA0**
  - For Switzerland **6ES7900-1CA00-0XA0**
  - For the USA **6ES7900-1DA00-0XA0**
  - For Italy **6ES7900-1EA00-0XA0**
  - For China **6ES7900-1FA00-0XA0**

## More information

Additional information is available on the Internet at: <http://www.siemens.com/simatic-pc>



## Overview

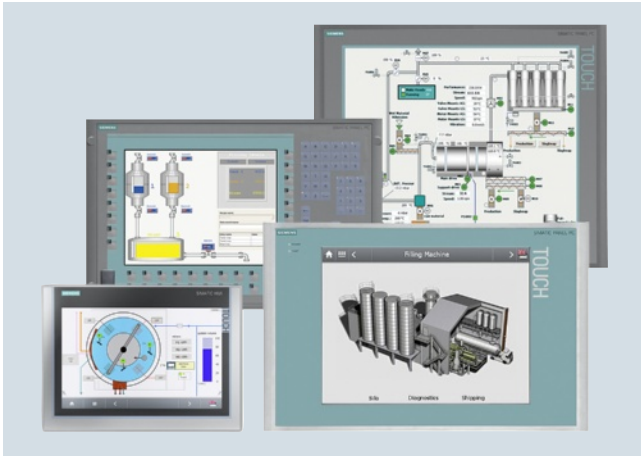

SIMATIC Panel PCs are suitable thanks to their high industrial compatibility for use in control cabinets, consoles and control panels, as well as directly on the machine. Typical areas of application can be found in both factory and process automation.

There is a broad range of robust, high-performance SIMATIC Panel PCs available for different requirements.

### Shared industrial functionality

- High-quality components and modules with a high MTBF (mean time between failure), which also ensure 24-hour operation in the extended temperature range.
- High swing/shock capacity of the devices through special hard-disk suspensions, locked connectors and card retainers
- Rugged housing model with high electromagnetic compatibility (EMC) and integrated industrial power supplies (also as per NAMUR)
- Service-friendly device design
- Bright, brilliant displays in different sizes up to 19"
- Same front panel mounting dimensions and uniform front design across all device families
- Rugged fronts protected from dust, humidity and chemical substances (front-side IP65 / NEMA 4 degrees of protection)

### SIMATIC IPC277:

#### **The embedded Nanopanel PC – maintenance-free and compact with displays starting from 7"**

- High degree of flexibility for selecting rugged widescreen fronts from 7" to 19" for a more freely configurable display area
- High resolution, large viewing angle, and up to 100% dimmable backlighting for a brilliant display with optimized power consumption
- Absolutely maintenance-free due to the use of CompactFlash or SSD as mass storage and fanless operation up to 50 °C ambient temperature
- Maximum industrial functionality due to non-volatile retentive memory (option)
- Ready-to-use embedded bundles with visualization and/or control software

### SIMATIC IPC477D:

#### **The powerful embedded Panel PC – maintenance-free with versatile configuration**

- Compact design
- High performance with highly compact design and ruggedness
- Flexible expansion using a PCIe I/O card (optional)
- No rotating parts (without fan and hard disk)
- High security due to use of the operating system
- Windows Embedded Standard 7
- Ready-to-use devices with optionally preinstalled software
- HMI: Innovative HMI software WinCC RT Advanced (including logging and recipes)
- RTX: with real-time capable software PLC WinAC RTX
- Retentive memory on-board
- (NV-RAM, usable with WinAC RTX)

### SIMATIC HMI IPC477C: The powerful embedded Panel PC – maintenance-free with versatile configuration

- Compact design
- High performance with highly compact design and ruggedness

#### (optional)

- Also available as PRO version (all-round IP65 degree of protection) with 15" and 19" Touch displays
- No rotating parts (without fan and hard disk)
- High security due to Microsoft Windows Embedded Standard 2009 or Windows Embedded Standard 7 operating systems
- Ready-to-use devices with optionally preinstalled software
  - HMI: Innovative HMI software WinCC flexible (incl. archives and recipes)
  - RTX: with real-time capable software PLC WinAC RTX
- Retentive memory on board (NV-RAM, usable with WinAC RTX)

### SIMATIC HMI IPC577:

#### **Industrial functionality and openness at an attractive price**

- Full PC openness and performance boost with Intel Core2 Duo processors
- Rugged design for industrial use
- Can be expanded using a PCI slot and additional interfaces
- More rugged due to SSD (solid-state drive) or CompactFlash
- The configurator (best-fit for the customer) makes ordering more flexible
- Compact design

### SIMATIC HMI IPC677: The high-end Panel PC – with maximum performance, functional scope and expansion capability

- Rugged, expandable industrial PC with different front panels
- Rugged design for industrial use
- Complete PC openness
- Optional PROFIBUS or PROFINET onboard
- All processors with dual core

## PROFINET/Industrial Ethernet

### Industrial PC

### SIMATIC Panel PC

#### General data

#### Benefits

##### High degree of industrial capability

The entire construction is designed for purely industrial use. Thus, for example, a special vibration-absorbing suspension of the hard disk ensures operational reliability, even at high mechanical loads. This makes that the SIMATIC Panel PCs are designed for a vibration load of 1 g and a shock load of 5 g.

##### Performance

Thanks to the use of the latest Intel processors from ULV (Ultra Low Voltage) to Intel Core technology, SIMATIC Panel PCs are flexibly scalable for your application.

- Scalable computing power
- Highest computing power
- Latest Intel processor technology
- Core i, Dual Core, ULV, Atom

##### Investment security

High component continuity and guaranteed availability of spare parts for up to 5 years after product phase-out are ensured e.g. through the development and production of our own motherboards. This enables long-lasting machine concepts without renewed engineering effort.

##### Service-friendly device design

Upgrades and exchange of components are easy thanks to the device design.

##### Integrated interfaces

The different already-integrated interfaces allow for various communication and expansion options. Many models are already equipped with Gigabit Ethernet and PROFIBUS DP/MPI interface.

##### Expandability

Depending on the model, ISA, PCI, PCI Express, PC/104 Plus and PC/104 slots are available for individual expandability. This enables the further use of existing and new expansion cards.

##### Compact dimensions

Considering the desired expandability, SIMATIC Panel PCs have an extremely low mounting depth and can thus be used in very narrow installation locations.

##### Options

Various options enable an individual solution for your industrial application. Thus, the operator control unit can be operated separately from the computer unit by up to 30 m. The direct control key module increases the operating safety in that it can be used to run the process independently of the operating system and without delay directly on PROFIBUS DP/MPI.

##### Individually expandable system availability

- RAID1 configuration - high system stability through redundant data management
- SIMATIC IPC DiagMonitor – Monitoring of the operating states and early detection of problems locally and in the network
- SIMATIC IPC Image & Partition Creator – downtime minimization through preventive data backup
- SITOP and Masterguard power supply (UPS) – Bridging of voltage dips

#### Technical specifications

	SIMATIC IPC277D	SIMATIC IPC477D	SIMATIC HMI IPC477C	SIMATIC HMI IPC577C	SIMATIC HMI IPC677D <sup>7)</sup>
<b>Design</b>					
Centralized configuration	•	•	•	•	•
<b>Display</b>					
Size	7"/9"/12"/15"/19" Widescreen TFT	12"/15"/19"/22" Widescreen TFT	12"/15"/19" TFT	12"/15"/19" TFT	22" Widescreen TFT
Resolution	800 x 480 / 800 x 480 / 1280 x 800 / 1280 x 800 / 1366 x 768	1280 x 800 / 1280 x 800 / 1366 x 768/ 1920 x 1080	800 x 600 / 1024 x 768 / 1280 x 1024	800 x 600 / 1 024 x 768 / 1 280 x 1 024	1 920 x 1 080
<b>Operator controls</b>					
Membrane keyboard	-	• <sup>8)</sup>	• <sup>1)</sup>	• <sup>1)</sup>	-
Touch screen	•	•	•	•	•
<b>General features</b>					
Power supply 24 V DC / 110/240 V AC	•/-	•/-	•/-	•/•	•/•
Processor	<ul style="list-style-type: none"> <li>• Intel Atom E640, 1.0 GHz;</li> <li>• Intel Atom E660, 1.3 GHz</li> </ul>	<ul style="list-style-type: none"> <li>• Intel Core i7-3517UE, 1.7 GHz, 4 MB SLC</li> <li>• Intel Core i3-3217UE, 1.6 GHz, 3 MB SLC</li> <li>• Intel Celeron 827E 1.4 GHz, 1.5 MB SLC</li> </ul>	<ul style="list-style-type: none"> <li>• Intel Celeron M 1.2 GHz</li> <li>• Intel Core2 Solo 1.2 GHz</li> <li>• Intel Core2 Duo 1.2 GHz</li> </ul>	<ul style="list-style-type: none"> <li>• Intel Celeron M 1.2 GHz</li> <li>• Intel Core2 Solo 1.2 GHz</li> <li>• Intel Core2 Duo 1.86 GHz</li> </ul>	<ul style="list-style-type: none"> <li>• Intel Xeon E3-1268L v3 (4C, 2.3 (3.3) GHz, HT, 8 MB cache, VT-d, AMT)</li> <li>• Intel Core i3-4330TE, (2C, 2.4 GHz, 4 MB cache, HT, VT-x)</li> <li>• Intel Celeron G1820TE (2C, 2.2 GHz, 2 MB cache)</li> </ul>

**Technical specifications** (continued)

	<b>SIMATIC IPC277D</b>	<b>SIMATIC IPC477D</b>	<b>SIMATIC HMI IPC477C</b>	<b>SIMATIC HMI IPC577C</b>	<b>SIMATIC HMI IPC677D <sup>7)</sup></b>
Main memory	1 GB, 2 GB	1 GB, 2 GB, 4 GB, 8 GB	1 GB, 2 GB, 4 GB	1 GB, 2 GB, 4 GB	2 GB, expandable up to 16 GB, optional ECC
Expansion slots	1 x CF slot for CompactFlash card (externally accessible)	• 2 x CFast slot (externally accessible)	2 x CF slot for CompactFlash Card (internally and externally accessible)	• 1 x PCI <sup>2)</sup> • 1 x CF slot for CompactFlash card (externally accessible)	• 2 x PCI or 1 x PCIe • 1 x PCI or • 2 x PCIe x16/x4
Operating system	• Windows Embedded Standard 2009 or XP Professional MUI • Windows Embedded Standard 7 (32-bit) or Windows 7 Ultimate MUI (32-bit)	• Without • Windows 7 Ultimate MUI (32-bit or 64-bit) • Windows Embedded Standard 7 (32-bit)	• Windows Embedded 2009 or XP Professional MUI • Windows 7 Ultimate MUI (32-bit) or Windows Embedded Standard 7 (32-bit)	• Without • Windows Embedded 2009 or XP Professional MUI	• Without • Windows 7 Ultimate 32-bit MUI • Windows 7 Ultimate 64-bit MUI
<b>Interfaces</b>					
PROFIBUS/MPI	-	•	•	•	•
PROFINET (RT/IRT)	• / -	• / •	• / •	• / •	• / •
Ethernet	2 x 10/100/1 000 Mbps	2 x 10/100/1 000 Mbps	2 x 10/100/1 000 Mbps	2 x 10/100/1 000 Mbps	2 x 10/100/1 000 Mbps
USB	•	•	•	•	•
Serial interface	•	•	•	•	•
Graphics interface	-	•	•	•	•
<b>Ambient conditions</b>					
Vibration load during operation	<b>1 g</b>	<b>1 g</b>	<b>1 g</b>	<b>1 g</b> <sup>3)</sup>	<b>1 g</b> <sup>3)</sup>
Shock loading during operation	<b>5 g</b>	<b>5 g</b>	<b>5 g</b>	<b>5 g</b> <sup>3)</sup>	<b>5 g</b>
Permissible temperature during operation with maximum configuration	+0 °C ... +50 °C <sup>7)</sup>	+0 °C ... +50 °C <sup>7)</sup>	+0 °C ... +50 °C <sup>7)</sup>	+0 °C ... +45 °C <sup>7)</sup>	+5 °C ... +45 °C <sup>6) 8)</sup>
<b>Power loss in maximum configuration</b>					
7" display	27 W				
9" display	29 W				
12" display	34 W	55 W	40 W <sup>4)</sup>	55 W <sup>5)</sup>	
15" display	42 W	56 W	45 W <sup>4)</sup>	57 W <sup>5)</sup>	
19" display	45 W	65 W	60 W <sup>4)</sup>	84 W <sup>5)</sup>	
22" display		74 W			170 W <sup>5)</sup>

- Available
- Not available

<sup>1)</sup> 12"/15" displays

<sup>2)</sup> All slots with card retainer

<sup>3)</sup> Valid with CF or SSD; with HDD: 5 g / 0.5 g;

<sup>4)</sup> 3 W taken into account for each PCI/PCIe slot

<sup>5)</sup> 15 W taken into account for each PCI/PCIe slot

<sup>6)</sup> +0 °C to +50 °C; max. +50 °C in installation space; max. 40 °C if at the front

<sup>7)</sup> +0 °C to +45 °C for 19"

<sup>8)</sup> 15" display optionally as Touch/Key version

<sup>9)</sup> With 12" and 15", vertical installation and use of CFast or SSD

**More information**

Additional information is available on the Internet at:

<http://www.siemens.com/simatic-panel-pc>

**Note:**

Do you need a specific modification or extension to the products described here? Then refer to "Customized Automation". There you will find information about additional and generally available sector-specific products as well as options for customer-specific modification and adaptation.

Examples are:

- Specific front panels for SIMATIC Panel PC, e.g. honing oil-resistant or with lateral function/movement keys
- SIMATIC HMI Net Panel with 46" large-scale display

**PROFINET/Industrial Ethernet**

Industrial PC

SIMATIC Panel PC

**SIMATIC IPC277D****Overview**

**SIMATIC IPC277D:**  
**The embedded Nanopanel PC – maintenance-free and compact with displays starting from 7"**

- Offers great flexibility in the selection of rugged widescreen fronts
- From 7" to 19" for more freely configurable display area
- High resolution, large viewing angle, and up to 100% dimmable backlighting for a brilliant display with optimized power consumption
- Absolutely maintenance-free due to the use of CompactFlash and SSD as mass storage and fanless operation up to 50 °C ambient temperature
- Maximum industrial functionality due to non-volatile retentive memory
- Ready-to-use embedded bundles with visualization or/and control software

The following front installation versions are available:

- 7" Touch
- 9" Touch
- 12" Touch
- 15" Touch with USB interface on the front
- 19" Touch with USB interface on the front
- All fronts as widescreen version

**Benefits****SIMATIC IPC277D Nanopanel PC**

- Rugged, industry-standard widescreen displays (Touch) with 7" / 9" / 12" / 15" / 19"
- High resolution, 16 million colors, large viewing angle, can be dimmed from 0 to 100% (this also optimizes the power consumption)
- Integrated front concept (Panel PC, Comfort Panels)
- Fanless up to 50 °C ambient temperature
- 15" / 19" with front USB interface available soon

**High-performance data processing at low power consumption**

- Intel Atom technology of the Power-Optimized family E6xx
- Wake-on-LAN for remote-controlled switching between standby and active state
- Support of Sleep States/SpeedStep -> (dynamic power adaptation depending on the required computing performance)
- Intel VT-x technology for virtualization

**High degree of industrial functionality and flexibility for implementing the embedded solution**

- Flexible memory concepts: CompactFlash or Solid-State Drive
- 2 Gbit Ethernet (teaming-capable); PROFINET with RT functionality (via Standard Ethernet)
- 3 high-speed USB 2.0 ports
- 1 RS232
- Ready-to-run embedded bundles with WinAC RTX2010 (F) and/or WinCC RT Advanced (optional)
- 512 KB retentive memory (MRAM), of which 128 KB can be written to within the buffer time (optional)

**High system availability in order to reduce the risk of potential failures and maintenance costs**

- Maintenance-free since there are no rotating parts (fans, HDD)
- Battery-free operation even if retentive memory option is selected (with time-of-day synchronization over network)
- Comprehensive self-diagnostics thanks to pre-installed local diagnostics software SIMATIC IPC DiagBase

**High investment security in order to reduce engineering costs**

- Long-term availability: Service & Support period of 8 – 10 years after market launch

**Technical specifications**

SIMATIC IPC277D	
<b>General features</b>	
Processors	<ul style="list-style-type: none"> <li>Intel Atom E660 1.3 GHz, 2 GB RAM</li> <li>Intel Atom E640 1.0 GHz, 1 GB RAM</li> </ul>
Chipset	Intel Controller Hub EG20T
NVRAM optional	512 KB, of which 128 KB can be written within the buffer time
Operating system	<ul style="list-style-type: none"> <li>Windows Embedded Standard 2009 preinstalled, in combination with CF card of 2 GB or more, or solid-state drive, or hard drive (optional)</li> <li>Windows XP Professional MUI (in connection with solid-state drive or hard drive; MUI: Multi Language User Interface (optional))</li> <li>Windows Embedded Standard 7 32-bit, preinstalled, in combination with CF card or solid-state drive (optional)</li> <li>Windows 7 Ultimate MUI 32-bit (in combination with solid-state drive; MUI: Multi Language User Interface (optional))</li> <li>Linux<sup>1)</sup> (project-specific, on request)</li> </ul> Others on request project-specifically
Power supply	<ul style="list-style-type: none"> <li>24 V DC (20.4 V ... 28.8 V)</li> <li>Isolated</li> <li>With buffering of temporary power failures: max. 10 ms</li> <li>Line side switch</li> <li>With power failure indication by means of Power Fail signal</li> </ul>
<b>Drives</b>	
FlashDrive	Optional; replaceable, accessible, diagnosable <ul style="list-style-type: none"> <li>2 GB</li> <li>4 GB</li> <li>8 GB</li> <li>16 GB</li> </ul>
Solid-state drive (SSD)	Optional <ul style="list-style-type: none"> <li>80 GB SATA, 2.5"</li> <li>160 GB SATA, 2.5"</li> </ul>
CD/DVD/Floppy	Via USB (not included in scope of delivery)
<b>Ports</b>	
PROFINET	PROFINET RT via Standard Ethernet controller
Ethernet	<ul style="list-style-type: none"> <li>2 x 10/100/1000 Mbps (RJ 45)</li> <li>Two independent Intel Controllers: Intel 82574L / Intel Controller Hub EG20T</li> </ul> With teaming function
USB	V2.0, 3 x
Serial	COM1 (V.24)
Keyboard	Via USB (not included in scope of delivery)
Mouse	Via USB (not included in scope of delivery)

SIMATIC IPC277D	
<b>Monitoring functions</b>	
Temperature	<ul style="list-style-type: none"> <li>Processor temperature</li> <li>Motherboard</li> </ul> Messages can be evaluated by the application program
Watchdog	<ul style="list-style-type: none"> <li>Monitoring of program execution</li> <li>Monitoring time can be parameterized in software</li> <li>Can be parameterized for a fault or restart</li> </ul> Messages can be evaluated by the application program
Monitoring functions via the network	<ul style="list-style-type: none"> <li>DiagBase</li> <li>SIMATIC IPC DiagMonitor</li> </ul> Remote monitoring capability for: <ul style="list-style-type: none"> <li>Watchdog</li> <li>Temperature</li> <li>Mass memory monitoring (SMART)</li> <li>System/Ethernet monitoring (Heart Beat)</li> <li>Runtime meter</li> </ul> Communication: <ul style="list-style-type: none"> <li>Ethernet interface (SNMP protocol)</li> <li>OPC for integration in SIMATIC software</li> <li>Configuration of client/server architectures</li> <li>Structure of log files</li> </ul>
<b>Supply voltage</b>	
Supply voltage	24 V DC
<b>Monitoring functions</b>	
Temperature	Yes
Watchdog	Yes
Mass storage	Yes
<b>Ambient conditions</b>	
Vibration load during operation	Requirements according to: IEC 61131-2, tested according to: IEC 60068-2-6, Test Fc 10-58: 0.0375 mm, 58-200: 9.8 m/s <sup>2</sup> , 10x /axis
Shock loading during operation	Requirements according to: IEC 61131-2, tested according to: IEC 60068-2-27, Test Ea, 50 m/s <sup>2</sup>
Relative humidity	Tested in accordance with DIN IEC 68-78, DIN IEC 60068-2-30: 5% to 80% at 25 °C (no condensation)
Maximum permissible installation angle +/-	45° over vertical
Ambient temperature during operation	0 °C ... +50° C in maximum configuration; no fan (19°: 0 °C ... +45 °C)
<b>Certifications &amp; standards</b>	
Approvals	CE, cULus (508), marine approval available for 7"/9"/12" (GL, LRS, BV, DNV, ABS, ClassNK)
EMC	CE, FFC A, 55022A, EN 61000-6-4, EN 61000-6-2

<sup>1)</sup> for specific LINUX versions in accordance with the specifications of the Siemens manufacturer's declaration "Suitable for LINUX", see <http://www.siemens.com/simatic-pc/suited-for-linux> (LINUX is a trademark of Linus Torvald)

**PROFINET/Industrial Ethernet**

Industrial PC

SIMATIC Panel PC

**SIMATIC IPC277D****Technical specifications** (continued)

	<b>SIMATIC IPC277D</b>				
<b>Front panel</b>	<b>7" TFT Touch, widescreen</b>	<b>9" TFT Touch, widescreen</b>	<b>12" TFT Touch, widescreen</b>	<b>15" TFT Touch, widescreen</b>	<b>19" TFT Touch, widescreen</b>
<b>Display</b>					
Resolution (W x H in pixels)	800 x 480	800 x 480	1 280 x 800	1 280 x 800	1 366 x 768
<b>General features</b>					
Accessories	Touch pen, touch protective films	Touch pen, touch protective films	Touch pen, touch protective films	Touch pen, touch protective films	Touch pen, touch protective films
<b>Type of operation</b>					
Function keys	No	No	No	No	No
Alphanumeric keyboard	No	No	No	No	No
Touch screen (analog/resistive)	Yes	Yes	Yes	Yes	Yes
USB port on the front	No	No	No	Yes	Yes
<b>Design</b>					
Centralized configuration	Yes	Yes	Yes	Yes	Yes
Distributed configuration	No	No	No	No	No
<b>Dimensions</b>					
Mounting dimensions in centralized configuration (W x H x D) in mm	197 x 141 x 71	251 x 166 x 71	310 x 221 x 66	396 x 291 x 73	465 x 319 x 73
Operator control unit (W x H) in mm	214 x 158	274 x 190	330 x 241	415 x 310	483 x 337
<b>Weight</b>	1500 g	1950 g	2750 g	4000 g	5700 g
<b>Max. power loss in maximum configuration</b>	27 W	29 W	37 W	42 W	45 W

**Ordering data****Article No.**

Ordering data	Article No.
<b>SIMATIC IPC277D Nanopanel PC</b>	<b>6AV7881- - A A 0 0 - - - 0</b>
<b>Interfaces:</b> 2 x Gbit LAN (RJ45), 1 x serial (COM1), 3 x USB	
<b>Operating unit</b>	
• Touch 7" TFT	1
• Touch 9" TFT	2
• Touch 12" TFT	3
• Touch 15" TFT, front USB interface	4
• Touch 19" TFT, front USB interface	5
<b>Processors / memory configuration / NVRAM</b>	
• Atom E640 (1.0 GHz), 1 GB RAM	A
• Atom E640 (1.0 GHz), 1 GB RAM, NVRAM	B
• Atom E660 (1.3 GHz), 2 GB RAM	E
• Atom E660 (1.3 GHz), 2 GB RAM, NVRAM	F
<b>Drives</b>	
• Without drive, with CF slot	0
• 2 GB SIMATIC PC CompactFlash	1
• 4 GB SIMATIC PC CompactFlash	2
• 8 GB SIMATIC PC CompactFlash	3
• 16 GB SIMATIC PC CompactFlash	4
• 160 GB Solid-State Drive SATA	6
• 80 GB Solid-State Drive SATA	8
<b>Operating system</b>	
• Without operating system	A
• WES 2009 preinstalled (CF from 2 GB/SSD)	B
• XP-Prof. MUI preinstalled on SSD	C
• WES 7 32 bit preinstalled (CF from 4 GB/SSD)	D
• Windows 7 MUI 32 bit preinstalled on SSD	E
<b>Software bundles</b>	
• Without RTX/HMI software	A
• RTX: WinAC RTX 2010	B
• RTX-F: WinAC RTX F 2010	C
• HMI: WinCC RT Advanced 128 PT	F
• HMI: WinCC RT Advanced 512 PT	G
• HMI: WinCC RT Advanced 2048 PT	H
• HMI/RTX: RT 128 PT	M
• HMI/RTX: RT 512 PT	N
• HMI/RTX: RT 2048 PT	P
• HMI/RTX-F: RT 128 PT	R
• HMI/RTX-F: RT 512 PT	S
• HMI/RTX-F: RT 2048 PT	T

**Article No.****Accessories**

<b>Touch protective films 7" <sup>1)</sup></b>	<b>6AV2124-6GJ00-0AX0</b>
<b>Touch protective films 9" <sup>1)</sup></b>	<b>6AV2124-6JJ00-0AX0</b>
<b>Touch protective films 12" <sup>1)</sup></b>	<b>6AV2124-6MJ00-0AX0</b>
<b>Touch protective films 15" <sup>1)</sup></b>	<b>6AV2124-6QJ00-0AX1</b>
<b>Touch protective films 19" <sup>1)</sup></b>	<b>6AV2124-6UJ00-0AX1</b>
<b>Bracket clamp, long</b> for 15", 19" and 22" widescreen, Comfort Panels, IPC, Flat Panel monitors and Thin Client (except SCD1900 19" widescreen)	<b>6AV6671-8XK00-0AX4</b>
<b>Touch pen</b> Captive pen for operation of the touch devices, mounting of the support on the control cabinet or directly on the PRO unit	<b>6AV7672-1JB00-0AA0</b>

<sup>1)</sup> 10 units per packing unit

**Please be sure to note:**

The IPC277D with bundled software is always supplied with inserted CF card.  
The licenses are on the supplied USB flash drive.

**More information**

Further information can be found on the Internet at:

<http://www.siemens.com/simatic-panel-pc>

# PROFINET/Industrial Ethernet

## Industrial PC

### SIMATIC Panel PC

#### SIMATIC IPC477D

#### Overview



#### **SIMATIC IPC477D:** **The powerful embedded Panel PC – maintenance-free with versatile configuration**

- Embedded PC platform with extremely high industrial compatibility for demanding tasks in the field of PC-based automation
- Maintenance-free (no rotating components such as fan and hard disk)
- Rugged construction: The PC is resistant to even the harshest mechanical stress and is extremely reliable in operation
- Compact design
- Battery-independent retentive memory onboard
- High degree of investment security
- Fast integration capability

The following front versions are available:

- Built-in versions
  - 12" TFT Touch
  - 15" TFT Touch
  - 15" TFT Touch/Key
  - 19" TFT Touch
  - 22" TFT Touch
  - 19" TFT Multi-Touch
  - 22" TFT Multi-Touch

#### Benefits

- Excellent industrial compatibility due to rugged construction, even when subjected to extreme vibration and shock
- High degree of investment protection thanks to assured availability of spare parts for a period of 5 years following the end of active marketing
- Excellent continuity of components for machine concepts with a long service life without any new engineering costs
- Cost and time savings due to service-friendly device design:
  - Front and rear USB 2.0 ports for quick and easy connection of additional hardware components
- High degree of industrial functionality thanks to integral PROFIBUS DP/MPI and PROFINET interfaces
- Maintenance-free due to lack of rotating components (fan and hard disk)
- High flexibility thanks to expansions (optional) such as PCIe, second RS 232, DVD (not with 12" TFT Touch)
- Minimization of downtimes thanks to high system availability
  - Efficient self-diagnostics (DiagBase and SIMATIC IPC DiagMonitor)
  - High reliability and security of an embedded platform
- An integral component of Totally Integrated Automation (TIA):
  - Enhanced productivity, minimization of engineering costs, reduction of lifecycle costs
- Supply of ready-to-run complete solutions (the software is preinstalled and preconfigured) for visualization and automation in combination with WinCC flexible, WinCC RT Advanced and/or WinAC RTX and WinCC.

#### Technical specifications

SIMATIC IPC477D	
<b>General features</b>	
Supply voltage <sup>1)</sup>	<ul style="list-style-type: none"> <li>• 24 V DC (-20 % / +20 %) <sup>1)</sup></li> <li>• 100 - 240 V AC (-15 % / +20 %); 50 - 60 Hz</li> </ul>
Brief voltage interruption in accordance with NAMUR	<ul style="list-style-type: none"> <li>• Min. 20 ms (DC)</li> <li>• Min. 20 ms (AC); max. 10 events per hour; min. 1 s recovery time</li> </ul>
Power consumption (DC) of devices (without expansions):	
• 12" display	55 W
• 15" display	56 W
• 19" display	65 W
• 22" display	74 W
Additional power consumption of devices with expansions:	
• DVD drive	1 W
• PCIe card	5 W

SIMATIC IPC477D	
<b>Processor</b>	<ul style="list-style-type: none"> <li>• Intel Celeron 827E 1.4 GHz; 1.5 MB SLC or</li> <li>• Intel Core i3-3217UE 1.6 GHz; 3 MB SLC or</li> <li>• Intel Core i7-3517UE 1.7 GHz; 4 MB SLC</li> </ul>
Main memory	<ul style="list-style-type: none"> <li>• SO-DIMM module; 1024 MB DDR3-SDRAM or</li> <li>• SO-DIMM module; 2048 MB DDR3-SDRAM or</li> <li>• SO-DIMM module; 4096 MB DDR3-SDRAM or</li> <li>• SO-DIMM module; 8192 MB DDR3-SDRAM</li> </ul>
Buffer memory <sup>2)</sup>	512 KB MRAM



**Technical specifications (continued)**

SIMATIC IPC477D		SIMATIC IPC477D	
<b>Drive and storage media</b>		<b>Ethernet</b> <sup>3)</sup>	
SATA drive	1 slot	Ethernet	<ul style="list-style-type: none"> <li>• 2 x RJ45 connection, Intel 82579LM and Intel 82574L 10/100/1000 Mbps, electrically isolated, teaming-capable<sup>4)</sup></li> <li>or</li> <li>• For PROFINET versions: 1 x Ethernet</li> </ul>
Solid-state drive	<ul style="list-style-type: none"> <li>• 1 x ≥ 80 GB; 2.5" SATA-SSD, standard or</li> <li>• 1 x ≥ 160 GB; 2.5" SATA-SSD, standard</li> </ul>	Slot for PCIe expansion cards	Only for device with expansions: 1 x PCIe-x4 expansion card can be used, max. permissible power loss: 5 W
Hard disk drive (HDD)	<ul style="list-style-type: none"> <li>• 1 x ≥ 250 GB, 2.5"-SATA-HD</li> </ul>	<b>Degree of protection</b>	<ul style="list-style-type: none"> <li>• IP 20 to IEC 60529 (enclosure)</li> <li>• IP 65 (front)</li> </ul>
CFast card	<ul style="list-style-type: none"> <li>• 2 GB or</li> <li>• 4 GB or</li> <li>• 8 GB or</li> <li>• 16 GB</li> </ul>	<b>Quality assurance</b>	In accordance with ISO 9001
DVD drive, RW	1 slot for devices with expansion	<b>Electromagnetic compatibility</b>	
<b>Graphics</b>		Emitted interference S	EN 61000-6-4; CISPR 22 Class A; FCC Class A
Display, resolution	<ul style="list-style-type: none"> <li>• 12" screen diagonal with LED backlighting, resolution 1 280 x 800 pixels, WXGA (Wide XGA)</li> <li>• 15" screen diagonal with LED backlighting, resolution 1 280 x 800 pixels, WXGA (Wide XGA)</li> <li>• 19" screen diagonal with LED backlighting, resolution 1 366 x 768 pixels</li> <li>• 22" screen diagonal with LED backlighting, resolution 1 920 x 1 080 pixels</li> </ul>	Immunity with regard to conducted interference on the supply lines	<ul style="list-style-type: none"> <li>• ± 2 kV to IEC 61000-4-4; burst</li> <li>• ± 1 kV to IEC 61000-4-5; surge symmetrical</li> <li>• ± 2 kV to IEC 61000-4-5; surge asymmetrical</li> </ul>
Touch controller	Analog-resistive or capacitive touch	Noise immunity on signal lines	<ul style="list-style-type: none"> <li>• ± 2 kV to IEC 61000-4-4; burst, length &gt; 3 m</li> <li>• ± 1 kV to IEC 61000-4-4; burst, length &lt; 3 m</li> <li>• ± 2 kV to IEC 61000-4-5; symmetrical surge, length &gt; 30 m</li> </ul>
Backlighting (MTBF)	LED	Immunity to static discharge	<ul style="list-style-type: none"> <li>• ± 6 kV, contact discharge at the front to IEC 61000-4-2</li> <li>• ± 4 kV contact discharge at the rear to IEC 61000-4-2</li> <li>• ± 8 kV air discharge to IEC 61000-4-2</li> </ul>
Half brightness life time, typical	Min. 50 000 h at 50 °C, 50 % brightness	Immunity to high radio frequency interference	<ul style="list-style-type: none"> <li>• 10 V/m, 80 ... 1000 MHz 80 % AM to IEC 61000-4-3</li> <li>• 1 V/m, 2 ... 2.7 GHz</li> <li>• 3 V/m, 2 ... 2.7 GHz</li> <li>• 10 V, 10 kHz ... 80 MHz to IEC 61000-4-6</li> </ul>
Graphics controller	<ul style="list-style-type: none"> <li>• Intel HD 2000 or</li> <li>• Intel HD 4000</li> </ul>	Immunity to magnetic fields	<ul style="list-style-type: none"> <li>• 100 A/m, 50/60 Hz to IEC 61000-4-8</li> </ul>
Graphics memory	<ul style="list-style-type: none"> <li>• 32 ... 512 MB shared memory</li> </ul>	<b>Weight</b>	<ul style="list-style-type: none"> <li>• IPC477D, touch device, 12" display approx. 3 200 g</li> <li>• IPC477D, touch device, 15" display approx. 4 920 g</li> <li>• IPC477D, touch/key device (without expansions), 15" display approx. 5 750 g</li> <li>• IPC477D, touch device, 19" display approx. 6 400 g</li> <li>• IPC477D, touch device, 22" display approx. 7 000 g</li> </ul>
Resolutions, frequency, colors	<ul style="list-style-type: none"> <li>• DVI-I: 640 x 480 ... 1 920 x 1 200, 60 Hz</li> <li>• DP display port: 1 920 x 1 200, 60 Hz</li> </ul>		
<b>Interfaces</b>			
COM 1 and COM 2	RS 232, max. 115 kbps, 9-pin, sub-D connector		
DVI	Connection of VDUs with DVI connection		
Display port (DPP)	Connection of VDUs with DPP connection		
Keyboard	Connection via USB port		
Mouse	Connection via USB port		
USB	<ul style="list-style-type: none"> <li>• Rear of device: 4 x USB 3.0, max. 2 high-current at the same time</li> <li>• Front of device (only with IPC477D with 15", 19" or 22" display): 1 x USB 2.0, high-current</li> </ul>		
PROFIBUS/MPI	9-pole, 2 rows, electrically isolated, Sub-D socket, compatible with CP 5622		
<ul style="list-style-type: none"> <li>• Transmission rate</li> <li>• Operating modes</li> </ul>	9.6 Kbps ... 12 Mbps DP master: DP-V0, DP-V1 with SOFTNET-DP DP slave: DP-V0, DP-V1 with SOFTNET-DP slave		
PROFINET	3 x RJ45 interface, CP 1616 compatible onboard interface based on ERTEC 400 10/100 Mbps, electrically isolated		

<sup>1)</sup> The generation of the supply voltage by the line-side power supply must be realized as safety extra-low voltage with safe electrical isolation, isolated according to IEC 60364 4 41, or as SELV according to IEC/UL/EN/DIN-EN 60950-1.

<sup>2)</sup> For devices with retentivity

<sup>3)</sup> For unambiguous labeling, the Ethernet ports are numbered on the enclosure. The numbering by the operating system can differ.

<sup>4)</sup> Teaming can be set and initiated in the configuration interface. In teaming operation, jumbo frames, e.g. for the camera application, are not supported

# PROFINET/Industrial Ethernet

## Industrial PC

### SIMATIC Panel PC

#### SIMATIC IPC477D

#### Ordering data

#### Article No.

#### Article No.

#### SIMATIC IPC477D <sup>1)</sup>

#### 6AV7240 -

#### Processor and fieldbus:

- Celeron U827E (1C/1T, 1.4 GHz, 1.5 MB cache); 2 x Gigabit Ethernet (IE/PN) **0**
- Celeron U827E (1C/1T, 1.4 GHz, 1.5 MB cache); 2 x Gigabit Ethernet (IE/PN); PROFIBUS DP12 **1**
- Core i3-3217UE (2C/4T, 1.6 GHz, 3 MB cache); 2 x Gigabit Ethernet (IE/PN) **3**
- Core i3-3217UE (2C/4T, 1.6 GHz, 3 MB cache); 2 x Gigabit Ethernet (IE/PN); PROFIBUS DP12 **4**
- Core i3-3217UE (2C/4T, 1.6 GHz, 3 MB cache); 1 x Gigabit Ethernet (IE/PN); 1 x PROFINET (IRT, 3 ports) **5**
- Core i7-3517UE (2C/4T, 1.7 (2.8) GHz, 3 MB cache); 2 x Gigabit Ethernet (IE/PN) **6**
- Core i7-3517UE (2C/4T, 1.7 (2.8) GHz, 3 MB cache); 2 x Gigabit Ethernet (IE/PN); PROFIBUS DP12 **7**
- Core i7-3517UE (2C/4T, 1.7 (2.8) GHz, 3 MB cache); 1 x Gigabit Ethernet (IE/PN); 1 x PROFINET (IRT, 3 ports) **8**

#### Operator control unit:

- 12" Touch (1 280 x 800) (caution, restrictions regarding options: HDD, PCI, AC, DVD) **A**
- 15" Touch (1 280 x 800) with front USB **B**
- 15" Touch/Key (1 280 x 800) with front USB **C**
- 19" Touch (1 366 x 768) with front USB **D**
- 22" Touch (1 920 x 1 080) with front USB **E**
- 19" Multi-Touch (1 366 x 768) without front USB **K**
- 22" Multi-Touch (1 920 x 1 080) without front USB **L**

#### Main memory/NVRAM

- 1 GB **A**
- 2 GB **B**
- 4 GB **C**
- 8 GB **D**
- 1 GB and NVRAM **J**
- 2 GB and NVRAM **K**
- 4 GB and NVRAM **L**
- 8 GB and NVRAM **M**

#### Expansions/interface:

- 1 x RS 232, without PCIe **0**
- 1 x RS 232 and 1 x PCIe **1**
- Second RS 232, without PCIe **3**
- Second RS 232 and 1 x PCIe **4**

#### Operating system:

- Without operating system **0**
- Windows Embedded Standard 7 Professional, 32-bit, MUI **3**
- Windows Embedded Standard 7 SP1, English, 32-bit **4**
- Windows Embedded Standard 7 SP1, English, 64-bit **5**
- Windows 7 Ultimate SP1, 32-bit, MUI (Eng, Ger, Fr, It, Sp) **6**
- Windows 7 Ultimate SP1, 64-bit, MUI (Eng, Ger, Fr, It, Sp) **7**

#### SIMATIC IPC477D <sup>1)</sup>

#### 6AV7240 -

#### Externally accessible mass storage (without operating system):

- Without external mass storage **0**
- CFAST 2 GB, without software **1**
- CFAST 4 GB **2**
- CFAST 8 GB **3**
- CFAST 16 GB **4**
- DVD **6**

#### Internal mass storage:

- Without internal mass storage **A**
- CFAST 2 GB **B**
- CFAST 4 GB **C**
- CFAST 8 GB **D**
- CFAST 16 GB **E**
- SSD 80 GB Standard **H**
- HDD 250 GB **K**
- DVD **L**
- SSD 80 GB standard with DVD **N**
- SSD 160 GB standard without DVD **P**
- HDD min. 250 GB with DVD **Q**

#### SIMATIC software preinstalled (bundles):

- Without SIMATIC software **A**
- WinAC RTX 2010 <sup>2)</sup> **B**
- WinCC RT Advanced 128 PT **C**
- WinCC RT Advanced 512 PT **D**
- WinCC RT Advanced 2 048 PT **E**
- WinCC RT Advanced 4 096 PT **F**
- WinCC RT Advanced 128 PT, WinAC RTX <sup>2)</sup> **J**
- WinCC RT Advanced 512 PT, WinAC RTX <sup>2)</sup> **K**
- WinCC RT Advanced 2 048 PT, WinAC RTX <sup>2)</sup> **L**
- WinCC RT Advanced 4 096 PT, WinAC RTX <sup>2)</sup> **M**
- WinAC RTX 2010 F <sup>2)</sup> **N**
- WinCC RT Advanced 128 PT, WinAC RTX F <sup>2)</sup> **P**
- WinCC RT Advanced 512 PT, WinAC RTX F <sup>2)</sup> **Q**
- WinCC RT Advanced 2 048 PT, WinAC RTX F <sup>2)</sup> **R**
- WinCC RT Advanced 4 096 PT, WinAC RTX F <sup>2)</sup> **S**
- WinCC RT Professional Client/single-user station 128 PT **Y**

#### Power supply:

- 24 V DC industrial power supply **0**
- 110/230 V AC industrial power supply with Namur; no power cable **1**
- 110/230 V AC industrial power supply with Namur; European power cable **2**
- 110/230 V AC industrial power supply with Namur; US power cable **3**
- 110/230 V AC industrial power supply with Namur; Chinese power cable **4**
- 110/230 V AC industrial power supply with Namur; Italian power cable **5**
- 110/230 V AC industrial power supply with Namur; Swiss power cable **6**
- 110/230 V AC industrial power supply with Namur; UK power cable **7**
- 24 V DC industrial power supply and TPM (not for China and Russia) **8**

<sup>1)</sup> Built to order versions with a delivery time of max. 15 working days and with identified repair.

<sup>2)</sup> Only with main memory and NVRAM.

## Overview

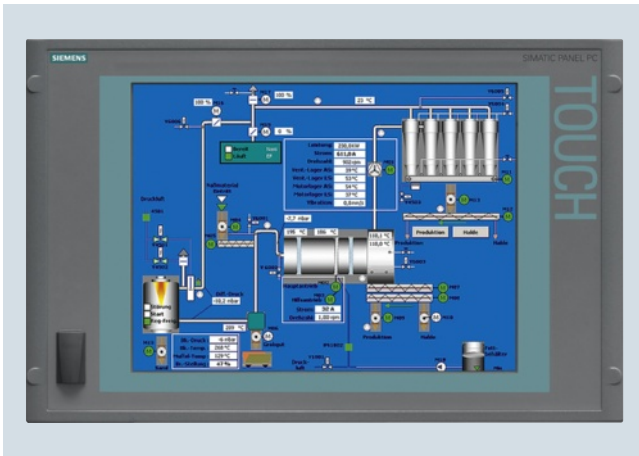

Rugged, expandable industry PC for demanding tasks in the area of PC-based automation with various control units (front panels):

- Rugged and compact design for industrial use
- Full PC openness
  - Windows Embedded Standard or Windows XP Professional, or without operating system
  - CF card, HDD, SSD
  - DVD drive
- Expandable using a PCI slot
- Optionally with PROFIBUS or PROFINET (RT/IRT) onboard
- Installation-compatible with Panel PC 577B
  - Touch screen control units with 12", 15" and 19" TFT display
  - 12" and 15" TFT Key
- High degree of investment protection

## Benefits

- High performance due to powerful processor
- Low-cost entry-level industry PC with full PC openness.
- Ideal for applications in industrial environments due to
  - Excellent operational reliability – even when subjected to extreme vibration and shock
  - High degree of chemical resistance to oils and grease
  - Smooth front, therefore no dirt can accumulate
  - Brilliant displays for good clearness of display, even when lighting conditions and viewing angles change.
- High degree of investment protection due to
  - A long marketing period (4-6 years) and high continuity of components for long-term machine concepts
  - Assured availability of spare parts (for a period of 5 years following the end of active marketing)
  - Simple migration from the predecessor product with minimum engineering overhead
  - Same installation dimensions as predecessor
  - Early detection of faults and minimized downtimes due to self-diagnostics (DiagBase)
- High level of flexibility due to
  - Expandable by the customer thanks to diverse interfaces (PCI, CompactFlash, Gbit Ethernet, and others)
  - USB interfaces on the front and rear for quick and easy connection of additional hardware components
  - User-friendly and easy integration in the fieldbus level, thanks to integrated PROFIBUS DP/MPI and 2 Gigabit Ethernet interfaces (onboard)

**PROFINET/Industrial Ethernet**

Industrial PC

SIMATIC Panel PC

**SIMATIC HMI IPC577C****Technical specifications**

	<b>6AV7885-0.....-.... SIMATIC HMI IPC577C</b>	<b>6AV7885-1.....-.... SIMATIC HMI IPC577C</b>	<b>6AV7885-2.....-.... SIMATIC HMI IPC577C</b>	<b>6AV7885-3.....-.... SIMATIC HMI IPC577C</b>	<b>6AV7885-5.....-.... SIMATIC HMI IPC577C</b>
<b>Operator control and monitoring</b>					
Accessory components	Touch protective foil	Slide-in keyboard labels	Touch protective foil	Slide-in keyboard labels	Touch protective foil
<b>Display</b>					
Screen diagonal	12 in	12 in	15 in	15 in	19 in
Resolution (pixels)					
• Resolution (WxH in pixel)	800 x 600	800 x 600	1024 x 768	1024 x 768	1280 x 1024
General features					
• Front panel	12" TFT touch display	12" TFT Key	15" TFT touch display	15" TFT Key	19" TFT Touch
Backlighting					
• MTBF backlighting (at 25 °C)	about 50,000 hours	about 50,000 hours	about 50,000 hours	about 50,000 hours	about 50,000 hours
<b>Control elements</b>					
Function keys	No	36	No	36	No
Mouse, at front	No	Yes	No	Yes	No
Keyboard fonts					
• alphanumeric keyboard	No	Yes	No	Yes	No
Touch operation					
• Design as touch screen	Yes	No	Yes	No	Yes
<b>Installation type/mounting</b>					
central design	Yes	Yes	Yes	Yes	Yes
distributed design	No	No	No	No	No
<b>Power loss</b>					
Power loss in full configuration	24V DC: Max. 80 W (incl. USB interfaces)	24V DC: Max. 80 W (incl. USB interfaces)	24V DC: Max. 80 W (incl. USB interfaces)	24V DC: Max. 80 W (incl. USB interfaces)	24V DC: Max. 80 W (incl. USB interfaces)
<b>Dimensions</b>					
Mounting cutout/device depth (W x H x D)	368 mm x 290 mm x 115 mm	450 mm x 290 mm x 115 mm	450 mm x 290 mm x 120 mm	450 mm x 321 mm x 115 mm	450 mm x 380 mm x 125 mm
additional mounting depth (optical drive)	23 mm	23 mm	23 mm	23 mm	23 mm
<b>Weights</b>					
Panel PC in central design, approx.	8.1 kg	8.6 kg	9 kg	9.3 kg	11.6 kg

Ordering data	Article No.	Article No.
<b>SIMATIC HMI IPC577C</b>	<b>6AV7885</b>	<b>SIMATIC HMI IPC577C</b>
<b>Front Panels</b>		<b>6AV7885</b>
<ul style="list-style-type: none"> <li>• 12" TFT Touch</li> <li>• 12" TFT Key</li> <li>• 15" TFT Touch</li> <li>• 15" TFT Key</li> <li>• 19" TFT Touch</li> </ul>	0 1 2 3 5	
<b>Mainboards (processor with fieldbus interfaces)</b>		
<ul style="list-style-type: none"> <li>• Celeron M 1.2 GHz, 1 MB cache, 800 MHz FSB <ul style="list-style-type: none"> <li>- with PROFINET (Industrial Ethernet); 2x LAN 1 Gbps</li> </ul> </li> <li>• Core2 Solo 1.2 GHz, 3 MB cache, 800 MHz FSB <ul style="list-style-type: none"> <li>- with PROFINET (Industrial Ethernet), 2x LAN 1 Gbps</li> <li>- with PROFIBUS DP12/MPI (CP5611-compatible), 2x LAN 1 Gbps</li> <li>- with PROFINET (RT/IRT) 3 ports, 1x LAN 1 Gbps</li> </ul> </li> <li>• Core2 Duo 1.86 GHz, 6 MB cache, 1 066 MHz FSB <ul style="list-style-type: none"> <li>- with PROFINET (Industrial Ethernet), 2x LAN 1 Gbps</li> <li>- with PROFIBUS DP12/MPI (CP5611-compatible), 2x LAN 1 Gbps</li> <li>- with PROFINET (RT/IRT) 3 ports, 1x LAN 1 Gbps</li> </ul> </li> </ul>	A A A D A E A F A K A L A M	
<b>RAM</b>		
<ul style="list-style-type: none"> <li>• 1 GB RAM, DDR3</li> <li>• 2 GB RAM, DDR3</li> <li>• 4 GB RAM, DDR3</li> </ul>	1 2 3	
<b>Second mass storage and/or drive (formatted without operating system)</b>		
<ul style="list-style-type: none"> <li>• No second mass storage/driver</li> <li>• DVD-RW drive</li> <li>• HDD + DVD-RW drive</li> <li>• SSD 50 GB High Endurance+ DVD-RW drive</li> <li>• SSD 80 GB Standard+ DVD-RW drive</li> <li>• SSD 50 GB High Endurance</li> <li>• SSD 80 GB Standard</li> <li>• HDD min. 250 GB</li> </ul>	0 1 2 3 4 6 7 8	
<b>First mass storage (formatted, optionally with operating system)</b>		
<ul style="list-style-type: none"> <li>• without</li> <li>• HDD min. 250 GB (not if 2nd mass storage HDD or SSD)</li> <li>• 2 GB CompactFlash</li> <li>• 4 GB CompactFlash</li> <li>• 8 GB CompactFlash</li> <li>• 16 GB CompactFlash</li> <li>• SSD 50 GB High Endurance (not if 2nd mass storage HDD or SSD)</li> <li>• SSD 80 GB Standard (not if 2nd mass storage HDD or SSD)</li> </ul>	0 1 2 3 4 5 6 7	
<b>Operating system (pre-installed on first mass storage)</b>		
<ul style="list-style-type: none"> <li>• Without operating system</li> <li>• Windows Embedded Standard</li> <li>• Windows XP Professional Multi-Language <sup>1)</sup></li> <li>• Windows Embedded Standard 7</li> <li>• Windows 7 Ultimate Multi-Language <sup>1)</sup></li> </ul>		A B D E G
<b>Expansion (software)</b>		
<ul style="list-style-type: none"> <li>• Without expansion</li> <li>• IPC DiagMonitor V4.3 enclosed</li> <li>• IPC Image &amp; Partition Creator</li> <li>• IPC DiagMonitor V4.3 and Image &amp; Partition Creator V3.2 enclosed</li> </ul>		A B C D
<b>Power supply</b>		
<ul style="list-style-type: none"> <li>• 100/240 V AC industrial power supply with Namur</li> <li>• 100/240 V AC industrial power supply with Namur; power cable for Europe</li> <li>• 100/240 V AC industrial power supply with Namur; power cable for the USA</li> <li>• 100/240 V AC industrial power supply with Namur; CN power cable</li> <li>• 100/240 V AC industrial power supply with Namur; IT power cable</li> <li>• 100/240 V AC industrial power supply with Namur; CH cable</li> <li>• 100/240 V AC industrial power supply with Namur; UK cable</li> <li>• 24 V DC industrial power supply</li> </ul>		1 2 3 4 5 6 7 8
<sup>1)</sup> Multi-Language means: D/E/F/I/SP/CHIN traditional/CHIN simplified/Korean/Japanese		
<b>Note:</b>		
Software Packages with SIMATIC WinCC flexible, SIMATIC WinCC and SIMATIC WinAC RTX (F) can be ordered together with the SIMATIC IPC with a price advantage.		
More information under "Embedded Bundles / Packages for industrial PCs".		
<b>Accessories</b>		
<b>Protective film for SIMATIC HMI IPC577C</b>		
For protecting the touch screen against dirt/scratches, set of 10		
<ul style="list-style-type: none"> <li>• for 12" Touch</li> <li>• for 15" Touch</li> <li>• for 19" Touch</li> </ul>		6AV7671-2BA00-0AA0 6AV7671-4BA00-0AA0 6AV7672-1CE00-0AA0
<b>Labeling strips for Key devices</b>		
For labeling soft keys and function keys, blank, supplied in sets of 10		6AV7672-0DA00-0AA0
<b>Touch pen</b>		
Captive pen for operation of the touch devices, mounting of the support on the control cabinet		6AV7672-1JB00-0AA0
<b>Expansion components</b>		See catalog ST 80 / ST PC

**More information**

Additional information is available in the Internet under:

<http://www.siemens.com/simatic-panel-pc>

## PROFINET/Industrial Ethernet

Industrial PC

SIMATIC Panel PC

SIMATIC IPC677D

### Overview



IPC 677D front view

### **SIMATIC IPC677D: The high-end Panel PC – with maximum performance, functional scope and expansion capability**

Rugged construction: The PC is resistant to even the harshest mechanical stress and is reliable in operation.

- Compact design
- High degree of investment protection
- Fast integration capability
- Widescreen front panel versions:
  - 22" Touch (other front panels available soon: 15", 19" Touch and 15", 19" and 22" Multi-Touch)

### Benefits

- Excellent industrial compatibility due to rugged construction, even when subjected to extreme vibration and shock
- High degree of investment protection thanks to assured availability of spare parts (for a period of 5 years following the end of active marketing)
- Excellent continuity of components for machine concepts with a long service life without any new engineering costs
- Savings in time and costs due to service-friendly equipment construction:
  - Operator control unit and computer unit are easy to separate for speedy component replacement
  - Front and rear USB 3.0 interfaces for quick and easy connection of additional hardware components
- High degree of industrial functionality thanks to integrated PROFIBUS DP/MPI or PROFINET (CP 1616-compatible) and 2 Gigabit Ethernet interfaces
- 2 x ≥ 250 GB SATA hard disk system (configured as single-disk system or RAID1)
- 240 GB SSD as rugged and high-speed hard disk substitute
- Reduction in downtimes through high system availability
- Minimized energy consumption thanks to support for Wake-On-LAN, shutdown or dimming of the display during operation, and use of Notebook components
- Efficient self-diagnostics (SIMATIC IPC DiagMonitor or DiagBase):
  - Solutions for preventive data backup
- Integral component of Totally Integrated Automation (TIA):
  - increases productivity, minimizes the engineering outlay, reduces the lifecycle costs

**Technical specifications**

6AV7260-...		6AV7260-...	
<b>General features</b>		<b>Monitoring functions</b>	
Processor	<ul style="list-style-type: none"> <li>Xeon E3-1268Lv3 (4C/8T, 2.3 (3.3) GHz, 8 MB cache, VT-d, AMT)</li> <li>Core i3-4330TE (2C/4T, 2.4 GHz, 4 MB cache, VT-x)</li> <li>Celeron G1820TE (2C/2T, 2.2 GHz, 2 MB cache)</li> </ul>	Temperature	Yes
Main memory	2 GB, optionally 4, 8 or 16 GB, or 8 or 16 GB with ECC	Watchdog	Yes
Free slots for expansions	<ul style="list-style-type: none"> <li>2 x PCI (slot with card retainer) or</li> <li>1 x PCI and 1 x PCIe x16 or</li> <li>1 x PCIe x16 and 1 x PCIe x4</li> </ul>	<b>Ambient conditions</b>	
Operating system	Windows 7 Ultimate 32-bit or 64-bit	Degree of protection	Front: IP65, Rear: IP20
Power supply	24 V DC or 110/240 V AC (autorange), 50/60 Hz	Vibration load during operation	Tested according to DIN IEC 60068-2-6: 10 - 58 Hz: 0.075 mm, 58 to 500 Hz: 10 m/s <sup>2</sup> (1 g) <sup>1)</sup>
MTBF backlighting	Typ. 80 000 h (at 24 h continuous operation, temperature-dependent)	Shock loading during operation	Tested to DIN IEC 60068-2-27, IEC 60068-2-29: 50 m/s <sup>2</sup> (5 g), 30 ms, 100 shocks
<b>Drives</b>		EMC	CE, FCC A, EN 61000-6-4, EN 61000-6-3, CISPR22
Optical drives	Optional DVD±RW±R combo drive, at the rear, operable from the side	Ambient temperature during operation	<ul style="list-style-type: none"> <li>5 °C ... +45 °C in maximum configuration</li> </ul>
Hard disk/mass storage	<ul style="list-style-type: none"> <li>3.5" SATA hard disk ≥ 250 GB;</li> <li>optional 3.5" SATA hard disk ≥ 500 GB,</li> <li>Dual hard disk module 2 x ≥ 250 GB SATA as single disk configuration or RAID1 preconfigured,</li> <li>240 GB SSD (solid-state drive)</li> </ul>	Relative humidity	Tested according to DIN IEC 60068-78, DIN IEC 60068-2-30: 5% to 80% at 25 °C (no condensation)
<b>Interfaces</b>		Maximum permissible installation angle +/-	20° over vertical
Graphics interface	DVI-I and DisplayPort	<b>Certifications &amp; standards</b>	
Connection for keyboard/mouse	USB / USB	Approvals	CE, cULus(508), FCC, KC, C-Tick
Serial interface	COM1: 1 x V.24 (RS232)	Expansion components	Uninterruptible power supply (UPS), SIMATIC NET communication modules, SIMATIC IPC DiagMonitor, SIMATIC IPC Image & Partition Creator, SIMATIC IPC USB FlashDrive
PROFIBUS DP/MPI	Onboard (optional), isolated, max. 12 Mbit/s, compatible with CPC5622, not upgradeable		
PROFINET (IRT)	Onboard (optional), 3 x RJ 45, CPC1616-compatible, not upgradeable		
PROFINET (IE), Ethernet	Onboard, 2 x 10/100/1000 Mbit		
USB	1 x on front, 4 x on rear, USB 3.0 (500 mA)		
Audio	Possible via USB (external)		
Multimedia	No		

<sup>1)</sup> Valid with SSD; with HDD: 5 g/0.5 g

# PROFINET/Industrial Ethernet

## Industrial PC

### SIMATIC Panel PC

#### SIMATIC IPC677D

#### Ordering data

Article No.

Article No.

#### SIMATIC IPC677D

(Production and delivery as per order)

SIMATIC IPC677D	6AV7260 - ■ ■ ■ ■ ■ - 0 ■ ■ ■ ■ ■	SIMATIC IPC677D	6AV7260 - ■ ■ ■ ■ ■ - 0 ■ ■ ■ ■ ■
HD graphics onboard; 2 x Gigabit Ethernet (IE/PN) RJ45; 4 x USB V3.0; 1x serial (COM1); RAID controller onboard; watchdog, temp./fan monitoring  Operating unit • 22" Touch (1 920 x 1 080)		Memory configuration • 2 GB DDR3 1600 DIMM; • 4 GB DDR3 1600 DIMM; • 8 GB DDR3 1600 DIMM; • 16 GB DDR3 1600 DIMM; • 8 GB DDR3 1600 DIMM; ECC; • 16 GB DDR3 1600 DIMM; ECC.	1 2 3 4 5 6
Processor • Celeron G1820TE (2C/2T, 2.2 GHz, 2 MB cache); • Celeron G1820TE (2C/2T, 2.2 GHz, 2 MB cache); PROFIBUS/MPI (CP 5622-compatible); 2 MB battery-backed SRAM; • Celeron G1820TE (2C/2T, 2.2 GHz, 2 MB cache); PROFINET (IRT, 3 ports, CP 1616-compatible); 2 MB battery-backed SRAM; • Core i3-4330TE(2C/4T, 2.4 GHz, 4 MB cache, VT-x); • Core i3-4330TE (2C/4T, 2.4 GHz, 4 MB cache, VT-x); PROFIBUS/MPI (CP 5622-compatible); 2 MB battery-backed SRAM; • Core i3-4330TE (2C/4T, 2.4 GHz, 4 MB cache, VT-x); PROFINET (IRT, 3 ports, CP 1616-compatible); 2 MB battery-backed SRAM; • Xeon E3-1268Lv3 (4C/8T, 2.3 (3.3) GHz, 8 MB cache, VT-d, AMT); • Xeon E3-1268Lv3 (4C/8T, 2.3 (3.3) GHz, 8 MB cache, VT-d, AMT); PROFIBUS/MPI (CP 5622-compatible); 2 MB battery-backed SRAM; • Xeon E3-1268Lv3 (4C/8T, 2.3 (3.3) GHz, 8 MB cache, VT-d, AMT); PROFINET (IRT, 3 ports, CP 1616-compatible); 2 MB battery-backed SRAM.	A B C D E F G H J	Expansions (HW) • 2 x PCI; • 1 x PCIe (x16); 1 x PCI; • 1 x PCIe (x16); 1 x PCIe (x4).  2. Expansions (HW) • Without expansion (HW) • 2 x USB in addition (1 slot occupied) • COM2; LPT (1 slot occupied) • 2 x USB in addition (1 slot occupied); COM2; LPT (2 slots occupied).	0 1 2 3
Drives • 250 GB HDD SATA; • 250 GB HDD SATA; DVD+/-RW; • 500 GB HDD SATA; • 500 GB HDD SATA; DVD+/-RW; • RAID1 2 x 250 GB SATA (2.5"); • RAID1 2 x 250 GB SATA (2.5"); DVD+/-RW; • Solid-state drive 240 GB; • Solid-state drive 240 GB; 250 GB HDD SATA (2.5") • Solid-state drive 240 GB; 250 GB HDD SATA (2.5"); DVD+/-RW; • Solid-state drive 160 GB.	A B D E G H M N P Y	Operating system • Windows 7 Ultimate, 32-bit SP1, MUI (Eng, Ger, Fr, It, Sp); • Windows 7 Ultimate, 64-bit SP1, MUI (Eng, Ger, Fr, It, Sp); • without.	A B X
		expansions (SW) • SIMATIC IPC DiagMonitor V4.x enclosed; • SIMATIC IPC Image & Partition Creator V3.x enclosed; • SIMATIC IPC DiagMonitor V4.x, Image & Partition Creator V3.x enclosed; • without; • TPM module; (not for China and Russia).	A B C X Y
		Country-specific version/ power supply • 110/230 V AC industrial power supply with NAMUR; European power cable; • 110/230 V AC industrial power supply with NAMUR; UK power cable; • 110/230 V AC industrial power supply with NAMUR; power cable for Switzerland; • 110/230 V AC industrial power supply NAMUR; US power cable; • 110/230 V AC industrial power supply NAMUR; power cable for Italy; • 110/230 V AC industrial power supply with NAMUR; power cable for China; • 24 V DC industrial power supply.	0 1 2 3 4 5 6



**Ordering data****Article No.***Accessories***Memory expansion**

- 2 GB DDR3 1600 SDRAM, DIMM
- 4 GB DDR3 1600 SDRAM, DIMM
- 8 GB DDR3 1600 SDRAM, DIMM
- 8 GB DDR3 1600 SDRAM, DIMM, ECC

**6ES7648-2AJ50-0MA0****6ES7648-2AJ60-0MA0****6ES7648-2AJ70-0MA0****6ES7648-2AJ70-1MA0****Non-heating apparatus cable for SIMATIC Box and Panel PC**

SIMATIC PC power cable, 230 V AC, angled, 3 m, for:

- Germany
- United Kingdom
- Switzerland
- USA
- Italy
- China

**6ES7900-1AA00-0XA0****6ES7900-1BA00-0XA0****6ES7900-1CA00-0XA0****6ES7900-1DA00-0XA0****6ES7900-1EA00-0XA0****6ES7900-1FA00-0XA0****Touch pen**

Captive pen for operation of the touch devices, mounting of the support on the control cabinet

**6AV7672-1JB00-0AA0***Expansion components*

See catalog ST 80 / ST PC

**More information**

Additional information is available on the Internet at:

<http://www.siemens.com/simatic-panel-pc>

Note

Do you need a specific modification or option for the products described here? Under "Customized products", you will find information about additional sector-specific products that can be ordered as well as about options for customer-specific modification and adaptation.

## PROFINET/Industrial Ethernet

### Industry monitors and Thin Clients

#### SIMATIC Industrial Flat Panel MT

#### Overview

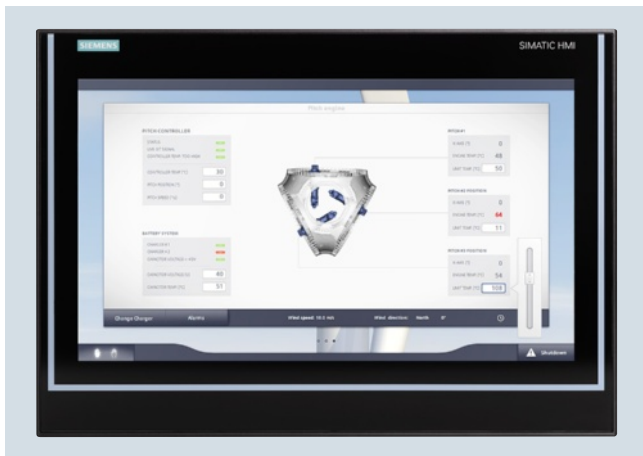

SIMATIC IFP1900 MT Flat Panel Monitor – industrial monitors with innovative multi-touch operation and brilliant display for the next generation of operating concepts.

- Installation:
  - Equally suited to installation in machines, control cabinets, consoles, and gantries or in 19" racks
- Operator input options:
  - Innovative projected capacitive touch technology (PCT)
  - Optimized touch technology for industrial requirements with multi-touch operation
  - High protection against incorrect operation thanks to detection and filtering out of ball of hand, drops of water, and cleaning operations

#### Benefits

- Detection of 5 fingers simultaneously with high touch resolution for exact operation
- Can also be used as a single touch device
- Intelligent detection of operator errors (e.g. detection of ball of hand, detection of drops, contamination, etc.)
- Touch operation without pressure
- Pleasing tactile feedback during operation
- Anti-glare surface for good readability from large viewing angle
- Operation possible with appropriate work gloves
- High-quality and modern front design
- Widescreen display for clear GUI design
- Sharp and high-contrast displays, LED backlighting for uniform brightness improves readability
- High shock and vibration resistance as well as high electromagnetic compatibility ensure failure safety and a long service life
- All-round metal frame protects glass edge from mechanical damage
- Software support
  - Individual programming using the tablet functions of Windows 7/8
  - SIMATIC WinCC V7.2 with Windows 7
  - SIMATIC WinCC Version 12.5 or higher
- Long service life

#### Technical specifications

<b>6AV7 466-7TB01-0AA0 IFP1900 MT</b>	
<b>General information</b>	
Short designation	Flat Panel 19" Multitouch ext.
<b>Display</b>	
Screen diagonal	18.5 in
Screen diagonal (cm)	47 cm
Display width	409.8 mm
Display height	230.4 mm
visible area (HxV) in mm	230 x 410
Viewing angle	170° x 170°
Type	TFT widescreen display, LED backlighting
On Screen Display (OSD) configuration	No, can be set with the software configuration
Number of colors (bit levels)	24 bit
Number of colors	16 777 200
Resolution (pixels)	
• Horizontal image resolution	1 366
• Vertical image resolution	768
• Resolution (WxH in pixel)	1366 x 768
<b>General features</b>	
• Detachable from computer unit	30 mm
• Brightness/contrast	300cd/m <sup>2</sup> / 1000:1
• Brightness, max.	300 cd/m <sup>2</sup>
<b>Backlighting</b>	
• Backlighting (type)	LED
• MTBF backlighting (up to 50%, at 25 °C)	50 000 h; At 25°C
• Dimmable backlight	Yes; 0-100 %
<b>Control elements</b>	
Function keys	No
<b>Mouse/cursor control</b>	
• external mouse	USB
<b>Touch operation</b>	
• Touch keyboard	Yes
<b>Installation type/mounting</b>	
Built-in unit	Yes
• Permissible angle to the vertical backward (console)	35°
• Permissible angle to the vertical forward (ceiling mounting)	35°
<b>Supply voltage</b>	
Type of supply voltage	AC, DC
Rated value (DC)	24 V
permissible range, lower limit (DC)	19.2 V
permissible range, upper limit (DC)	28.8 V
Rated value (AC)	0 V; 100 - 240V, 50/60Hz
permissible range, lower limit (AC)	85 V
permissible range, upper limit (AC)	265 V
<b>Power losses</b>	
<b>Power loss AC</b>	
• Typical	40 W
• Maximum	60 W
<b>Power loss DC</b>	
• Typical	40 W
• Maximum	65 W

### Technical specifications (continued)

6AV7 466-7TB01-0AA0 IFP1900 MT	
<b>Interfaces</b>	
USB on the rear	2
Video interfaces	
• DVI-D	Yes
• Display port	Yes; Display port V1.1
Touch interfaces	
• USB	Yes
<b>Degree and class of protection</b>	
IP65 at front	Yes
Enclosure Type 4 at the front	Yes
NEMA4 at the front	No
NEMA4X at the front	No
IP20 rear	Yes
<b>Standards, approvals, certificates</b>	
UL approval	
• UL 508	Yes
EN 50081-1	Yes
EN 50081-2	Yes
EN 50082-1	Yes
EN 50082-2	Yes
<b>Ambient conditions</b>	
Min. ambient temperature	0 °C
Max. ambient temperature	45 °C
Relative humidity	
• Relative humidity during operation	95 %
Vibrations	
• Vibration load in operation	g (m/s <sup>2</sup> )
• Vibration load during transport/storage	g (m/s <sup>2</sup> )
Shock testing	
• Shock loading in operation	g (m/s <sup>2</sup> )
• Shock load during transport/storage	g (m/s <sup>2</sup> )
<b>Connection method</b>	
Connector for cooling devices	Yes
<b>Mechanics/material</b>	
Type of housing (front)	aluminum
• Aluminum	Yes
<b>Dimensions</b>	
Width of the housing front	483 mm
Height of housing front	337 mm
Mounting cutout/device depth (W x H x D)	
• Mounting cutout, width	465 mm
• Mounting cutout, height	319 mm
Device depth	62.5 mm
<b>Weights</b>	
Weight without packaging	6.34 kg
Weight incl. packaging	9.52 kg

### Ordering data

#### SIMATIC IFP1900 MT

Flat Panel, 19" display (16:9), operation using multitouch gestures, extended version up to 30 m, 1366 x 768 pixels, for 24 V DC and 100-240 V AC, display port/DVI interface, incl. 1.8 m DVI/USB cable

### Article No.

6AV7466-7TB01-0AA0

## PROFINET/Industrial Ethernet

### Industry monitors and Thin Clients

#### SIMATIC Industrial Flat Panel

#### Overview



The Industrial Flat Panels are rugged industry-standard LCD monitors in a wide screen design.

- Installation:
  - Equally suited for installation in the machine, in control cabinets, in consoles, to gantries, or in 19" racks.
- Type of operator control:
  - Simple display devices without operator functionality
  - Optional devices with touch control
  - Optional devices with multi-touch control
  - Rear-mounted connection of I/O devices (optional).

#### Benefits

- Rugged industrial design:
  - High shock and vibration resistance as well as extremely high electromagnetic compatibility ensure failure safety and a long service life
  - Enclosure front in IP65/NEMA4 degree of protection, resistant to dust and humidity
  - Scratch-resistant, anti-glare mineral glass screen, providing high mechanical protection against pressure and scratching
  - Meets CE standard "Industry"
- Variety of versions
- Lower energy requirement
- Fatigue-proof operation:
  - Wide reading angle of up to 170° horizontal and vertical
  - Sharp and high-contrast graphic display
  - No flickering, uniform brightness
  - Automatic display adjustment (Auto Adjust)
- Configuration using On-Screen Display (OSD)
- Minimal space requirement and low weight
- Long service life

#### Technical specifications

	6AV7863-2AA00-0AA0 IFP1500	6AV7863-2AB10-0AA0 IFP1500	6AV7863-2BB10-0AA0 IFP1500	6AV7863-2TA00-0AA0 IFP1500	6AV7863-2TB10-0AA0 IFP1500
<b>General information</b>					
Short designation	Flat Panel 15" display	Flat Panel 15" display ext.	Flat Panel 15" Touch/keys	Flat Panel 15" Touch	Flat Panel 15" Touch ext.
<b>Display</b>					
Screen diagonal	15.4 in	15.4 in	15.4 in	15.4 in	15.4 in
Screen diagonal (cm)	40 cm	40 cm	40 cm	40 cm	40 cm
Display width	331.2 mm	331.2 mm	331.2 mm	331.2 mm	331.2 mm
Display height	207 mm	207 mm	207 mm	207 mm	207 mm
Viewing angle	170° x 170°	170° x 170°	170° x 170°	170° x 170°	170° x 170°
Type	TFT widescreen display, LED backlighting	TFT widescreen display, LED backlighting	TFT widescreen display, LED backlighting	TFT widescreen display, LED backlighting	TFT widescreen display, LED backlighting
On Screen Display (OSD) configuration	No, can be set with the software	No, can be set with the software	No, can be set with the software	No, can be set with the software	No, can be set with the software
Number of colors (bit levels)	24 bit	24 bit	24 bit	24 bit	24 bit
Number of colors	16 777 200	16 777 200	16 777 200	16 777 200	16 777 200
Resolution (pixels)					
• Horizontal image resolution	1 280	1 280	1 280	1 280	1 280
• Vertical image resolution	800	800	800	800	800
• Resolution (WxH in pixel)	1280 x 800	1280 x 800	1280 x 800	1280 x 800	1280 x 800
• Pixel size, horizontal	0.259 mm	0.259 mm	0.259 mm	0.259 mm	0.259 mm
• Pixel size, vertical	0.259 mm	0.259 mm	0.259 mm	0.259 mm	0.259 mm
<b>General features</b>					
• Non-reflective and tempered mineral glass screen	Yes	Yes	Yes		
• Detachable from computer unit	5 m	30 m	5 m	5 m	5 m
• Brightness/contrast	400 cd/m <sup>2</sup> / 1000:1	400 cd/m <sup>2</sup> / 1000:1	400 cd/m <sup>2</sup> / 1000:1	400 cd/m <sup>2</sup> / 1000:1	400 cd/m <sup>2</sup> / 1000:1
• Brightness, max.	400 cd/m <sup>2</sup>	400 cd/m <sup>2</sup>	400 cd/m <sup>2</sup>	400 cd/m <sup>2</sup>	400 cd/m <sup>2</sup>
<b>Backlighting</b>					
• Backlighting (type)	LED	LED	LED	LED	LED
• MTBF backlighting (up to 50%, at 25 °C)	50 000 h; At 25°C	50 000 h; At 25°C	50 000 h; At 25°C	50 000 h; At 25°C	50 000 h; At 25°C
• Dimmable backlight	Yes; 0-100 %	Yes; 0-100 %	Yes; 0-100 %	Yes; 0-100 %	Yes; 0-100 %

**Technical specifications** (continued)

	6AV7863-2AA00-0AAA IFP1500	6AV7863-2AB10-0AAA IFP1500	6AV7863-2BB10-0AAA IFP1500	6AV7863-2TA00-0AAA IFP1500	6AV7863-2TB10-0AAA IFP1500
<b>Control elements</b>					
Function keys	No	No	36	No	No
Mouse/cursor control					
• external mouse		USB	USB		USB
Keyboard fonts					
• Alphanumeric and numeric block		Yes			
Touch operation					
• Touch keyboard			Yes	Yes	Yes
<b>Installation type/mounting</b>					
Built-in unit	Yes; Portrait mode possible	Yes; Portrait mode possible	Yes	Yes; Portrait mode possible	Yes; Portrait mode possible
• Permissible angle to the vertical backward (console)	35°	35°	35°	35°	35°
• Permissible angle to the vertical forward (ceiling mounting)	35°	35°	35°	35°	35°
<b>Supply voltage</b>					
Type of supply voltage	DC	DC	DC	DC	DC
Rated value (DC)	24 V	24 V	24 V	24 V	24 V
permissible range, lower limit (DC)	19.2 V	19.2 V	19.2 V	19.2 V	19.2 V
permissible range, upper limit (DC)	28.8 V	28.8 V	28.8 V	28.8 V	28.8 V
Rated value (AC)		100 V; Up to 240V 50/60Hz	100 V; Up to 240V 50/60Hz		
permissible range, lower limit (AC)		90 V	90 V		90 V
permissible range, upper limit (AC)		264 V	264 V		264 V
<b>Power losses</b>					
Power loss AC					
• Typical		40 W	40 W		40 W
• Maximum		60 W	60 W		60 W
Power loss DC					
• Typical	40 W	40 W	40 W	40 W	40 W
• Maximum	65 W	65 W	65 W	65 W	65 W
<b>Interfaces</b>					
USB on the rear		2	1		2
USB at the front			1		
Video interfaces					
• DVI-D	Yes	Yes	Yes	Yes	Yes
• Display port	Yes; Display port V1.1	Yes; Display port V1.1	Yes; Display port V1.1	Yes; Display port V1.1	Yes; Display port V1.1
Touch interfaces					
• USB	No	No	Yes	Yes	Yes
<b>Degree and class of protection</b>					
IP65 at front	Yes	Yes	Yes	Yes	Yes
Enclosure Type 4 at the front	Yes	Yes	Yes	Yes	Yes
NEMA4 at the front	No	No	No	No	No
NEMA4X at the front	No	No	No	No	No
IP20 rear	Yes	Yes	Yes	Yes	Yes
<b>Standards, approvals, certificates</b>					
CE mark	Yes	Yes	Yes	Yes	Yes
KC approval	Yes	Yes	Yes	Yes	Yes
cULus	Yes; Corresponds to UL 508	Yes; Corresponds to UL 508	Yes; Corresponds to UL 508	Yes; Corresponds to UL 508	Yes; Corresponds to UL 508
RCM (former C-TICK)	Yes	Yes	Yes	Yes	Yes
Use in hazardous areas					
• FM Class I Division 2	Yes	No	No	Yes	No

## PROFINET/Industrial Ethernet

### Industry monitors and Thin Clients

#### SIMATIC Industrial Flat Panel

#### Technical specifications (continued)

	6AV7863-2AA00-0AA0 IFP1500	6AV7863-2AB10-0AA0 IFP1500	6AV7863-2BB10-0AA0 IFP1500	6AV7863-2TA00-0AA0 IFP1500	6AV7863-2TB10-0AA0 IFP1500
<b>Ambient conditions</b>					
Min. ambient temperature	0 °C	0 °C	0 °C	0 °C	0 °C
Max. ambient temperature	50 °C; Vertical installation (horizontal)	50 °C; Vertical installation (horizontal)	50 °C; Vertical installation (horizontal)	50 °C; Vertical installation (horizontal)	50 °C; Vertical installation (horizontal)
Storage/transport temperature					
• Min.	-20 °C	-20 °C	-20 °C	-20 °C	-20 °C
• max.	60 °C	60 °C	60 °C	60 °C	60 °C
Relative humidity					
• Relative humidity during operation	95 %; Non-condensing	95 %; Non-condensing	95 %; Non-condensing	95 %; Non-condensing	95 %; Non-condensing
Vibrations					
• Vibration load in operation	1 g	1 g	1 g	1 g	1 g
• Vibration load during transport/storage	1 g	1 g	1 g	1 g	1 g
Shock testing					
• Shock loading in operation	15 g	15 g	15 g	15 g	15 g
• Shock load during transport/storage	15 g	15 g	15 g	15 g	15 g
<b>Connection method</b>					
Connector for cooling devices		Yes	Yes		
<b>Mechanics/material</b>					
Type of housing (front)	aluminum	aluminum	aluminum	aluminum	aluminum
• Aluminum	Yes	Yes	Yes	Yes	Yes
<b>Dimensions</b>					
Width of the housing front	415 mm	415 mm	483 mm	415 mm	415 mm
Height of housing front	310 mm	310 mm	310 mm	310 mm	310 mm
Mounting cutout/device depth (W x H x D)					
• Mounting cutout, width	396 mm; Tolerance: +1 mm	396 mm; Tolerance: +1 mm	450 mm; Tolerance: +1 mm	396 mm; Tolerance: +1 mm	396 mm; Tolerance: +1 mm
• Mounting cutout, height	291 mm; Tolerance: +1 mm	291 mm; Tolerance: +1 mm	291 mm; Tolerance: +1 mm	291 mm; Tolerance: +1 mm	291 mm; Tolerance: +1 mm
Device depth	62.5 mm	62.5 mm	62.5 mm	62.5 mm	62.5 mm
<b>Weights</b>					
Weight without packaging	3.9 kg	3.9 kg	4.3 kg	3.9 kg	3.9 kg
Weight incl. packaging	5 kg	5 kg	5.4 kg	5 kg	5 kg

**Technical specifications** (continued)

	<b>6AV7 863-3AA00-0AA0 IFP1900</b>	<b>6AV7 863-3AB10-0AA0 IFP1900</b>	<b>6AV7 863-3TA00-0AA0 IFP1900</b>	<b>6AV7 863-3TB10-0AA0 IFP1900</b>
<b>General information</b>				
Short designation	Flat Panel 19" display	Flat Panel 19" display ext.	Flat Panel 19" Touch	Flat Panel 19" Touch ext.
<b>Display</b>				
Screen diagonal	18.5 in	18.5 in	18.5 in	18.5 in
Screen diagonal (cm)	47 cm	47 cm	47 cm	47 cm
Display width	409.8 mm	409.8 mm	409.8 mm	409.8 mm
Display height	230.4 mm	230.4 mm	230.4 mm	230.4 mm
Viewing angle	170° x 160°	170° x 160°	170° x 160°	170° x 160°
Type	TFT	TFT	TFT	TFT
On Screen Display (OSD) configuration	No, can be set with the software	No, can be set with the software	No, can be set with the software	No, can be set with the software
Number of colors (bit levels)	24 bit	24 bit	24 bit	24 bit
Number of colors	16 777 200	16 777 200	16 777 200	16 777 200
Resolution (pixels)				
• Horizontal image resolution	1 366	1 366	1 366	1 366
• Vertical image resolution	768	768	768	768
• Resolution (WxH in pixel)	1366 x 768	1366 x 768	1366 x 768	1366 x 768
• Pixel size, horizontal	0.3 mm	0.3 mm	0.3 mm	0.3 mm
• Pixel size, vertical	0.3 mm	0.3 mm	0.3 mm	0.3 mm
General features				
• Non-reflective and tempered mineral glass screen	Yes	Yes		
• Detachable from computer unit	5 m	30 m	5 m	30 m
• Brightness/contrast	300cd/m <sup>2</sup> / 1000:1	300cd/m <sup>2</sup> / 1000:1	300cd/m <sup>2</sup> / 1000:1	300cd/m <sup>2</sup> / 1000:1
• Brightness, max.	300 cd/m <sup>2</sup>	300 cd/m <sup>2</sup>	300 cd/m <sup>2</sup>	300 cd/m <sup>2</sup>
Backlighting				
• Backlighting (type)	LED	LED	LED	LED
• MTBF backlighting (up to 50%, at 25 °C)	50 000 h; At 25°C	50 000 h; At 25°C	50 000 h; At 25°C	50 000 h; At 25°C
• Dimmable backlight	Yes; 0-100 %	Yes; 0-100 %	Yes; 0-100 %	Yes; 0-100 %
<b>Control elements</b>				
Function keys	No	No	No	No
Mouse/cursor control				
• external mouse		USB		USB
Touch operation				
• Touch keyboard			Yes	Yes
<b>Installation type/mounting</b>				
Built-in unit	Yes; Portrait mode possible	Yes; Portrait mode possible	Yes; Portrait mode possible	Yes; Portrait mode possible
• Permissible angle to the vertical backward (console)	35°	35°	35°	35°
• Permissible angle to the vertical forward (ceiling mounting)	35°	35°	35°	35°
<b>Supply voltage</b>				
Type of supply voltage	DC	DC	DC	DC
Rated value (DC)	24 V	24 V	24 V	24 V
permissible range, lower limit (DC)	19.2 V	19.2 V	19.2 V	19.2 V
permissible range, upper limit (DC)	28.8 V	28.8 V	28.8 V	28.8 V
Rated value (AC)		100 V; Up to 240V 50/60Hz		100 V; Up to 240V 50/60Hz
permissible range, lower limit (AC)		90 V		90 V
permissible range, upper limit (AC)		264 V		264 V
<b>Power losses</b>				
Power loss AC				
• Typical		40 W		40 W
• Maximum		60 W		60 W
Power loss DC				
• Typical	40 W	40 W	40 W	40 W
• Maximum	65 W	65 W	65 W	65 W

## PROFINET/Industrial Ethernet

### Industry monitors and Thin Clients

#### SIMATIC Industrial Flat Panel

#### Technical specifications (continued)

	6AV7 863-3AA00-0AA0 IFP1900	6AV7 863-3AB10-0AA0 IFP1900	6AV7 863-3TA00-0AA0 IFP1900	6AV7 863-3TB10-0AA0 IFP1900
<b>Interfaces</b>				
USB on the rear		2		2
Video interfaces				
• DVI-D	Yes	Yes	Yes	Yes
• Display port	Yes; Display port V1.1	Yes; Display port V1.1	Yes; Display port V1.1	Yes; Display port V1.1
Touch interfaces				
• USB	No	No	Yes	Yes
<b>Degree and class of protection</b>				
IP65 at front	Yes	Yes	Yes	Yes
Enclosure Type 4 at the front	Yes	Yes	Yes	Yes
NEMA4 at the front	No	No	No	No
NEMA4X at the front	No	No	No	No
IP20 rear	Yes	Yes	Yes	Yes
<b>Standards, approvals, certificates</b>				
CE mark	Yes	Yes	Yes	Yes
KC approval	Yes	Yes	Yes	Yes
cULus	Yes; Corresponds to UL 508	Yes; Corresponds to UL 508	Yes; Corresponds to UL 508	Yes; Corresponds to UL 508
RCM (former C-TICK)	Yes	Yes	Yes	Yes
Use in hazardous areas				
• FM Class I Division 2	Yes	No	Yes	Yes
<b>Ambient conditions</b>				
Min. ambient temperature	0 °C	0 °C	0 °C	0 °C
Max. ambient temperature	45 °C; Vertical installation (horizontal)	45 °C; Vertical installation (horizontal)	45 °C; Vertical installation (horizontal)	45 °C; Vertical installation (horizontal)
Storage/transport temperature				
• Min.	-20 °C	-20 °C	-20 °C	-20 °C
• max.	60 °C	60 °C	60 °C	60 °C
Relative humidity				
• Relative humidity during operation	95 %; Non-condensing	95 %; Non-condensing	95 %; Non-condensing	95 %; Non-condensing
Vibrations				
• Vibration load in operation	1 g	1 g	1 g	1 g
• Vibration load during transport/storage	1 g	1 g	1 g	1 g
Shock testing				
• Shock loading in operation	15 g	15 g	15 g	15 g
• Shock load during transport/storage	15 g	15 g	15 g	15 g
<b>Connection method</b>				
Connector for cooling devices		Yes		Yes
<b>Mechanics/material</b>				
Type of housing (front)	aluminum	aluminum	aluminum	aluminum
• Aluminum	Yes	Yes	Yes	Yes
<b>Dimensions</b>				
Width of the housing front	483 mm	483 mm	483 mm	483 mm
Height of housing front	337 mm	337 mm	337 mm	337 mm
Mounting cutout/device depth (W x H x D)				
• Mounting cutout, width	465 mm; Tolerance: +1 mm	465 mm; Tolerance: +1 mm	465 mm; Tolerance: +1 mm	465 mm; Tolerance: +1 mm
• Mounting cutout, height	319 mm; Tolerance: +1 mm	319 mm; Tolerance: +1 mm	319 mm; Tolerance: +1 mm	319 mm; Tolerance: +1 mm
Device depth	62.5 mm	62.5 mm	62.5 mm	62.5 mm
<b>Weights</b>				
Weight without packaging	5.5 kg	5.5 kg	5.5 kg	5.5 kg
Weight incl. packaging	6.5 kg	6.5 kg	6.5 kg	6.5 kg



**Technical specifications** (continued)

	6AV7 863-4AA00-0AA0 IFP2200	6AV7 863-4AB10-0AA0 IFP2200	6AV7 863-4TA00-0AA0 IFP2200	6AV7 863-4TB10-0AA0 IFP2200
<b>General information</b>				
Short designation	Flat Panel 22" display	Flat Panel 22" display ext.	Flat Panel 22" Touch	Flat Panel 22" Touch ext.
<b>Display</b>				
Screen diagonal	21.5 in	21.5 in	21.5 in	21.5 in
Screen diagonal (cm)	56 cm	56 cm	56 cm	56 cm
Display width	476 mm	476 mm	476 mm	476 mm
Display height	268 mm	268 mm	268 mm	268 mm
Viewing angle	170° x 170°	170° x 170°	170° x 170°	170° x 170°
Type	TFT	TFT	TFT	TFT
On Screen Display (OSD) configuration	No, can be set with the software	No, can be set with the software	No, can be set with the software	No, can be set with the software
Number of colors (bit levels)	24 bit	24 bit	24 bit	24 bit
Number of colors	16 777 200	16 777 200	16 777 200	16 777 200
Resolution (pixels)				
• Horizontal image resolution	1 920	1 920	1 920	1 920
• Vertical image resolution	1 080	1 080	1 080	1 080
• Resolution (WxH in pixel)	1920 x 1080	1920 x 1080	1920 x 1080	1920 x 1080
• Pixel size, horizontal	0.2475 mm	0.2475 mm	0.2475 mm	0.2475 mm
• Pixel size, vertical	0.2475 mm	0.2475 mm	0.2475 mm	0.2475 mm
<b>General features</b>				
• Non-reflective and tempered mineral glass screen	Yes	Yes		
• Detachable from computer unit	5 m	30 m	5 m	30 m
• Brightness/contrast	250 cd/m <sup>2</sup> / 1000:1	250 cd/m <sup>2</sup> / 1000:1	250 cd/m <sup>2</sup> / 1000:1	250 cd/m <sup>2</sup> / 1000:1
• Brightness, max.	250 cd/m <sup>2</sup>	250 cd/m <sup>2</sup>	250 cd/m <sup>2</sup>	250 cd/m <sup>2</sup>
<b>Backlighting</b>				
• Backlighting (type)	LED	LED	LED	LED
• MTBF backlighting (up to 50%, at 25 °C)	50 000 h; At 25°C	50 000 h; At 25°C	50 000 h; At 25°C	50 000 h; At 25°C
• Dimmable backlight	Yes; 0-100 %	Yes; 0-100 %	Yes; 0-100 %	Yes; 0-100 %
<b>Control elements</b>				
Function keys	No	No	No	No
Mouse/cursor control				
• external mouse		USB		USB
Touch operation				
• Touch keyboard			Yes	Yes
<b>Installation type/mounting</b>				
Built-in unit	Yes; Portrait mode possible	Yes; Portrait mode possible	Yes; Portrait mode possible	Yes; Portrait mode possible
• Permissible angle to the vertical backward (console)	35°	35°	35°	35°
• Permissible angle to the vertical forward (ceiling mounting)	35°	35°	35°	35°
<b>Supply voltage</b>				
Type of supply voltage	DC	DC	DC	DC
Rated value (DC)	24 V	24 V	24 V	24 V
permissible range, lower limit (DC)	19.2 V	19.2 V	19.2 V	19.2 V
permissible range, upper limit (DC)	28.8 V	28.8 V	28.8 V	28.8 V
Rated value (AC)		100 V; Up to 240V 50/60Hz		100 V; Up to 240V 50/60Hz
permissible range, lower limit (AC)		90 V		90 V
permissible range, upper limit (AC)		264 V		264 V
<b>Power losses</b>				
<b>Power loss AC</b>				
• Typical		40 W		40 W
• Maximum		60 W		60 W
<b>Power loss DC</b>				
• Typical	40 W	40 W	40 W	40 W
• Maximum	65 W	65 W	65 W	65 W

## PROFINET/Industrial Ethernet

### Industry monitors and Thin Clients

#### SIMATIC Industrial Flat Panel

#### Technical specifications (continued)

	6AV7 863-4AA00-0AA0 IFP2200	6AV7 863-4AB10-0AA0 IFP2200	6AV7 863-4TA00-0AA0 IFP2200	6AV7 863-4TB10-0AA0 IFP2200
<b>Interfaces</b>				
USB on the rear		2		2
Video interfaces				
• DVI-D	Yes	Yes	Yes	Yes
• Display port	Yes; Display port V1.1	Yes; Display port V1.1	Yes; Display port V1.1	Yes; Display port V1.1
Touch interfaces				
• USB	No	No	Yes	Yes
<b>Degree and class of protection</b>				
IP65 at front	Yes	Yes	Yes	Yes
Enclosure Type 4 at the front	Yes	Yes	Yes	Yes
NEMA4 at the front	No	No	No	No
NEMA4X at the front	No	No	No	No
IP20 rear	Yes	Yes	Yes	Yes
<b>Standards, approvals, certificates</b>				
CE mark	Yes	Yes	Yes	Yes
KC approval	Yes	Yes	Yes	Yes
cULus	Yes; Corresponds to UL 508	Yes; Corresponds to UL 508	Yes; Corresponds to UL 508	Yes; Corresponds to UL 508
RCM (former C-TICK)	Yes	Yes	Yes	Yes
Use in hazardous areas				
• FM Class I Division 2	Yes	No	Yes	No
<b>Ambient conditions</b>				
Min. ambient temperature	0 °C	0 °C	0 °C	0 °C
Max. ambient temperature	45 °C; Vertical installation (horizontal)	45 °C; Vertical installation (horizontal)	45 °C; Vertical installation (horizontal)	45 °C; Vertical installation (horizontal)
Storage/transport temperature				
• Min.	-20 °C	-20 °C	-20 °C	-20 °C
• max.	60 °C	60 °C	60 °C	60 °C
Relative humidity				
• Relative humidity during operation	95 %; Non-condensing	95 %; Non-condensing	95 %; Non-condensing	95 %; Non-condensing
Vibrations				
• Vibration load in operation	1 g	1 g	1 g	1 g
• Vibration load during transport/storage	1 g	1 g	1 g	1 g
Shock testing				
• Shock loading in operation	15 g	15 g	15 g	15 g
• Shock load during transport/storage	15 g	15 g	15 g	15 g
<b>Connection method</b>				
Connector for cooling devices		Yes		Yes
<b>Mechanics/material</b>				
Type of housing (front)	aluminum	aluminum	aluminum	aluminum
• Aluminum	Yes	Yes	Yes	Yes
<b>Dimensions</b>				
Width of the housing front	560 mm	560 mm	560 mm	560 mm
Height of housing front	380 mm	380 mm	380 mm	380 mm
Mounting cutout/device depth (W x H x D)				
• Mounting cutout, width	542 mm; Tolerance: +1 mm	542 mm; Tolerance: +1 mm	542 mm; Tolerance: +1 mm	542 mm; Tolerance: +1 mm
• Mounting cutout, height	362 mm; Tolerance: +1 mm	362 mm; Tolerance: +1 mm	362 mm; Tolerance: +1 mm	362 mm; Tolerance: +1 mm
Device depth	62.5 mm	62.5 mm	62.5 mm	62.5 mm
<b>Weights</b>				
Weight without packaging	6.5 kg	6.5 kg	6.5 kg	6.5 kg
Weight incl. packaging	7.6 kg	7.6 kg	7.6 kg	7.6 kg

Ordering data	Article No.	Article No.
<b>Industrial Flat Panel Monitor</b>	<b>6AV7863 - ■ ■ ■ ■ 0 - 0 A A 0</b>	
<u>Display size</u>		
• 15" (multi-touch available soon)	2	
• 19"	3	
• 22"	4	
<u>Operator functionality</u>		
• Display devices without operator functionality	A	
• Touch screen (capacitive) multi-touch	M	
• Touch screen (analog/resistive)	T	
• Touch screen + function keys, 15" only and extended special functions	B B 1	
<u>Special functions</u>		
• Standard, can be located up to 5 m away	A 0	
• Extended, for positioning at a distance of up to 30 m, 100 ... 230 V AC (without supply cable) + special functions	B 1	
		<b>Accessories</b>
		<b>Set of protective films for ITC/IFP/TP1500</b>
		6AV2124-6QJ00-0AX1
		<b>Set of protective films for ITC/IFP/TP1900</b>
		6AV2124-6UJ00-0AX1
		<b>Set of protective films for ITC/IFP/TP2200</b>
		6AV2124-6XJ00-0AX1
		<b>Touch pen</b>
		6AV7672-1JB00-0AA0
		Undetachable pen for operation of the touch devices, mounting of the support on the control cabinet or directly on the PRO unit
		<i>Accessories for standard variants up to 5 m (6AV7863-..A0.-0AA0)</i>
		<b>DisplayPort cable (industrial quality)</b>
		• 3 m
		6AV7860-0DH30-0AA0
		• 5 m
		6AV7860-0DH50-0AA0
		<b>DVI-D cable (industrial quality)</b>
		• 3 m
		6AV7860-0BH30-0AA0
		• 5 m
		6AV7860-0BH50-0AA0
		<b>USB cable (industrial quality)</b>
		• 3 m
		6AV7860-0CH30-0AA0
		• 5 m
		6AV7860-0CH50-0AA0
		<i>Accessories for extended variants up to 30 m (6AV7863-..B1.-0AA0)</i>
		<b>Cable set (USB/Cat5; sender module, DVI)</b>
		• 10 m
		6AV7860-1EX21-0AA1
		• 15 m
		6AV7860-1EX21-5AA1
		• 20 m
		6AV7860-1EX22-0AA1
		• 30 m
		6AV7860-1EX23-0AA1
		<b>Cable set 90°</b>
		6AV7860-1EX22-0BA1
		USB/Cat5; sender module, DVI 90° angle, 20 m
		<b>USB host extender</b>
		6AV7671-1EX02-0AA0
		incl. 20 cm USB cable (USB to Cat5)

## PROFINET/Industrial Ethernet

### Industry monitors and Thin Clients

#### SIMATIC Flat Panels

#### Overview

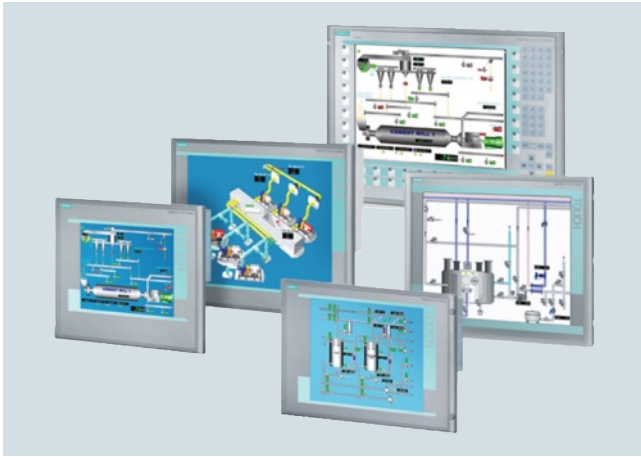

The Flat Panels are rugged industry-standard LCD monitors.

- Installation:
  - They are equally suited to installation in the machine, in control cabinets, consoles and gantries or in 19" racks.
  - As a device with all-round IP65 protection for mounting on a supporting arm/stand
- Type of operator control:
  - Simple display devices without operator functionality
  - Optional devices with touch control
  - Rear connection of I/O devices (optional)

#### Benefits

- Rugged industrial design:
  - High shock and vibration resistance as well as extremely high electromagnetic compatibility make for a fail-safe and long-lasting design
  - Enclosure front in degree of protection IP65/NEMA4, resistant against dust and humidity
  - Enclosure version complete in degree of protection IP65 for mounting on supporting arm
  - Scratch-resistant, anti-glare mineral glass screen, providing high mechanical protection against pressure and scratching
  - Meets CE standard "Industry"
- Variety of versions
- No X-rays
- Lower energy requirement
- Fatigue-proof operation:
  - Wide reading angle of up to 170° horizontal and vertical
  - Sharp and high-contrast graphic display
  - No flickering, uniform brightness
  - Automatic display adjustment (Auto Adjust)
- Configuration using on-screen display (OSD)
- Small space requirement and low weight
- Long service life

### Technical specifications

	6AV7861-1AA00-1AA0	6AV7861-1AB00-1AA0	6AV7861-1AB10-1AA0	6AV7861-1KB10-1AA0	6AV7861-1TA00-1AA0	6AV7861-1TB00-1AA0	6AV7861-1TB10-1AA0
<b>Display</b>							
Screen diagonal	12 in	12 in	12 in	12 in	12 in	12 in	12 in
visible area (HxV) in mm	246 x 184,5	246 x 184,5	246 x 184,5	246 x 184,5	246 x 184,5	246 x 184,5	246 x 184,5
Viewing angle	140° x 120°	140° x 120°	140° x 120°	140° x 120°	140° x 120°	140° x 120°	140° x 120°
On Screen Display (OSD) configuration	Yes	Yes	Yes	Yes	Yes	Yes	Yes
Number of colors (bit levels)	262k	262k	262k	262k	262k	262k	262k
Number of colors	262 000; 262k	262 000; 262k	262 000; 262k	262 000; 262k	262 000; 262k	262 000; 262k	262 000; 262k
Resolution (pixels)							
• Horizontal image resolution	800	800	800	800	800	800	800
• Vertical image resolution	600	600	600	600	600	600	600
• Resolution (WxH in pixel)	800 x 600	800 x 600	800 x 600	800 x 600	800 x 600	800 x 600	800 x 600
General features							
• Brightness/contrast	> 350 cd/m <sup>2</sup> / 450:1	> 350 cd/m <sup>2</sup> / 450:1	> 350 cd/m <sup>2</sup> / 450:1	> 350 cd/m <sup>2</sup> / 450:1	> 350 cd/m <sup>2</sup> / 450:1	> 350 cd/m <sup>2</sup> / 450:1	> 350 cd/m <sup>2</sup> / 450:1
<b>Control elements</b>							
Function keys	No	No	No	No	No	No	No
Operating mode							
• integrated mouse cursor control	No	No	No	No	No	No	No
<b>Installation type/mounting</b>							
Rack mounting possible	No	No	No	No	No	No	No
Desktop device	No	No	No	No	No	No	No
VESA mounting	No	No	No	No	No	No	No
<b>Supply voltage</b>							
Type of supply voltage	AC, DC	AC, DC	AC, DC	AC, DC	AC, DC	AC, DC	AC, DC
permissible range, lower limit (DC)	19.2 V	19.2 V	19.2 V	19.2 V	19.2 V	19.2 V	19.2 V
permissible range, upper limit (DC)	28.8 V	28.8 V	28.8 V	28.8 V	28.8 V	28.8 V	28.8 V
permissible range, lower limit (AC)	90 V	90 V	90 V	90 V	90 V	90 V	90 V
permissible range, upper limit (AC)	264 V	264 V	264 V	264 V	264 V	264 V	264 V
<b>Interfaces</b>							
Video interfaces							
• analog video signal (VGA)	Yes	Yes	Yes	Yes	Yes	Yes	Yes
<b>Degree and class of protection</b>							
IP54 at front	Yes; For screw mounting in 19" rack	Yes; For screw mounting in 19" rack	Yes; For screw mounting in 19" rack	Yes; For screw mounting in 19" rack	Yes; For screw mounting in 19" rack	Yes; For screw mounting in 19" rack	Yes; For screw mounting in 19" rack
IP65 at front	Yes; if mounted with the supplied latch fasteners	Yes; if mounted with the supplied latch fasteners	Yes; if mounted with the supplied latch fasteners	Yes; if mounted with the supplied latch fasteners	Yes; if mounted with the supplied latch fasteners	Yes; if mounted with the supplied latch fasteners	Yes; if mounted with the supplied latch fasteners
IP20 rear	Yes	Yes	Yes	Yes	Yes	Yes	Yes
<b>Standards, approvals, certificates</b>							
UL	Yes	Yes	Yes	Yes	Yes	Yes	Yes
EAC (former Gost-R)	No	No	No	No	No	No	No
Marine approval							
• Germanischer Lloyd (GL)	Yes; Optional	Yes; Optional	Yes; Optional	Yes; Optional	Yes; Optional	Yes; Optional	Yes; Optional
• American Bureau of Shipping (ABS)	Yes; Optional	Yes; Optional	Yes; Optional	Yes; Optional	Yes; Optional	Yes; Optional	Yes; Optional
• Bureau Veritas (BV)	Yes; Optional	Yes; Optional	Yes; Optional	Yes; Optional	Yes; Optional	Yes; Optional	Yes; Optional
• Det Norske Veritas (DNV)	Yes; Optional	Yes; Optional	Yes; Optional	Yes; Optional	Yes; Optional	Yes; Optional	Yes; Optional
• Lloyds Register of Shipping (LRS)	Yes; Optional	Yes; Optional	Yes; Optional	Yes; Optional	Yes; Optional	Yes; Optional	Yes; Optional
• Polski Rejestr Statkow (PRS)	Yes; Optional	Yes; Optional	Yes; Optional	Yes; Optional	Yes; Optional	Yes; Optional	Yes; Optional
<b>Ambient conditions</b>							
Max. ambient temperature	50 °C	50 °C	50 °C	50 °C	50 °C	50 °C	50 °C
<b>Dimensions</b>							
Width of the housing front	400 mm	400 mm	400 mm	483 mm	400 mm	400 mm	400 mm
Height of housing front	310 mm	310 mm	310 mm	310 mm	310 mm	310 mm	310 mm
Mounting cutout/device depth (W x H x D)	368 x 290 x 51	368 x 290 x 51	368 x 290 x 51	368 x 290 x 51	368 x 290 x 51	368 x 290 x 51	368 x 290 x 51
Device depth	51 mm	51 mm	51 mm	49 mm	50 mm	51 mm	51 mm

# PROFINET/Industrial Ethernet

## Industry monitors and Thin Clients

### SIMATIC Flat Panels

#### Technical specifications (continued)

	6AV7861-2AA00-1AA0	6AV7861-2AB00-1AA0	6AV7861-2AB10-1AA0	6AV7861-2KB10-1AA0	6AV7861-2TA00-1AA0	6AV7861-2TB00-1AA0	6AV7861-2TB10-1AA0
<b>Display</b>							
Screen diagonal	15 in	15 in	15 in	15 in	15 in	15 in	15 in
visible area (HxV) in mm	304 x 228	304 x 228	304 x 228	304 x 228	304 x 228	304 x 228	304 x 228
Viewing angle	100° x 90° (min)	100° x 90° (min)	100° x 90° (min)	100° x 90° (min)	100° x 90° (min)	100° x 90° (min)	100° x 90° (min)
On Screen Display (OSD) configuration	Yes	Yes	Yes	Yes	Yes	Yes	Yes
Number of colors (bit levels)	16.2 million	16.2 million	16.2 million	16.2 million	16.2 million	16.2 million	16.2 million
Number of colors	16 000 000; 16.2 million	16 000 000; 16.2 million	16 000 000; 16.2 million	16 000 000; 16.2 million	16 000 000; 16.2 million	16 000 000; 16.2 million	16 000 000; 16.2 million
Resolution (pixels)							
• Horizontal image resolution	1 024	1 024	1 024	1 024	1 024	1 024	1 024
• Vertical image resolution	768	768	768	768	768	768	768
• Resolution (WxH in pixel)	1024 x 768	1024 x 768	1024 x 768	1024 x 768	1024 x 768	1024 x 768	1024 x 768
General features							
• Brightness/contrast	> 260 cd/m <sup>2</sup> / 350:1	> 260 cd/m <sup>2</sup> / 350:1	> 260 cd/m <sup>2</sup> / 350:1	> 260 cd/m <sup>2</sup> / 350:1	> 260 cd/m <sup>2</sup> / 350:1	> 260 cd/m <sup>2</sup> / 350:1	> 260 cd/m <sup>2</sup> / 350:1
<b>Control elements</b>							
Function keys	No	No	No	No	No	No	No
Operating mode							
• integrated mouse cursor control	No	No	No	No	No	No	No
<b>Installation type/mounting</b>							
Rack mounting possible	Yes	Yes	Yes	Yes	Yes	Yes	Yes
Desktop device	No	No	No	No	No	No	No
VESA mounting	No	No	No	No	No	No	No
<b>Supply voltage</b>							
Type of supply voltage	AC, DC	AC, DC	AC, DC	AC, DC	AC, DC	AC, DC	AC, DC
permissible range, lower limit (DC)	19.2 V	19.2 V	19.2 V	19.2 V	19.2 V	19.2 V	19.2 V
permissible range, upper limit (DC)	28.8 V	28.8 V	28.8 V	28.8 V	28.8 V	28.8 V	28.8 V
permissible range, lower limit (AC)	90 V	90 V	90 V	90 V	90 V	90 V	90 V
permissible range, upper limit (AC)	264 V	264 V	264 V	264 V	264 V	264 V	264 V
<b>Interfaces</b>							
Video interfaces							
• analog video signal (VGA)	Yes	Yes	Yes	Yes	Yes	Yes	Yes
<b>Degree and class of protection</b>							
IP54 at front	Yes; For screw mounting in 19" rack	Yes; For screw mounting in 19" rack	Yes; For screw mounting in 19" rack	Yes; For screw mounting in 19" rack	Yes; For screw mounting in 19" rack	Yes; For screw mounting in 19" rack	Yes; For screw mounting in 19" rack
IP65 at front	Yes; if mounted with the supplied latch fasteners	Yes; if mounted with the supplied latch fasteners	Yes; if mounted with the supplied latch fasteners	Yes; if mounted with the supplied latch fasteners	Yes; if mounted with the supplied latch fasteners	Yes; if mounted with the supplied latch fasteners	Yes; if mounted with the supplied latch fasteners
<b>Standards, approvals, certificates</b>							
UL	Yes	Yes	Yes	Yes	Yes	Yes	Yes
EAC (former Gost-R)	No	No	No	No	No	No	No
Marine approval							
• Germanischer Lloyd (GL)	Yes; Optional	Yes; Optional	Yes; Optional	Yes; Optional	Yes; Optional	Yes; Optional	Yes; Optional
• American Bureau of Shipping (ABS)	Yes; Optional	Yes; Optional	Yes; Optional	Yes; Optional	Yes; Optional	Yes; Optional	Yes; Optional
• Bureau Veritas (BV)	Yes; Optional	Yes; Optional	Yes; Optional	Yes; Optional	Yes; Optional	Yes; Optional	Yes; Optional
• Det Norske Veritas (DNV)	Yes; Optional	Yes; Optional	Yes; Optional	Yes; Optional	Yes; Optional	Yes; Optional	Yes; Optional
• Lloyds Register of Shipping (LRS)	Yes; Optional	Yes; Optional	Yes; Optional	Yes; Optional	Yes; Optional	Yes; Optional	Yes; Optional
<b>Ambient conditions</b>							
Max. ambient temperature	50 °C	50 °C	50 °C	50 °C	50 °C	50 °C	50 °C
<b>Dimensions</b>							
Width of the housing front	483 mm	483 mm	483 mm	483 mm	483 mm	483 mm	483 mm
Height of housing front	310 mm	310 mm	310 mm	355 mm	310 mm	310 mm	310 mm
Mounting cutout/device depth (W x H x D)	450x290x54	450x290x54	450x290x54	450x290x54	450x290x54	450x290x54	450x290x54
Device depth	55 mm	55 mm	55 mm	49 mm	55 mm	55 mm	55 mm

**Technical specifications (continued)**

	6AV7861-3AA00-1AA0	6AV7861-3AB00-1AA0	6AV7861-3AB10-1AA0	6AV7861-3TA00-1AA0	6AV7861-3TB00-1AA0	6AV7861-3TB10-1AA0
<b>Display</b>						
Screen diagonal	19 in	19 in	19 in	19 in	19 in	19 in
visible area (HxV) in mm	376 x 301	376 x 301	376 x 301	376 x 301	376 x 301	376 x 301
Viewing angle	170° x 170°	170° x 170°	170° x 170°	170° x 170°	170° x 170°	170° x 170°
On Screen Display (OSD) configuration	Yes	Yes	Yes	Yes	Yes	Yes
Number of colors (bit levels)	16.7 million	16.7 million	16.7 million	16.7 million	16.7 million	16.7 million
Number of colors	16 000 000; 16.7 million	16 000 000; 16.7 million	16 000 000; 16.7 million	16 000 000; 16.7 million	16 000 000; 16.7 million	16 000 000; 16.7 million
Resolution (pixels)						
• Horizontal image resolution	1 280	1 280	1 280	1 280	1 280	1 280
• Vertical image resolution	1 024	1 024	1 024	1 024	1 024	1 024
• Resolution (WxH in pixel)	1280 x 1024	1280 x 1024	1280 x 1024	1280 x 1024	1280 x 1024	1280 x 1024
General features						
• Brightness/contrast	> 300 cd/m <sup>2</sup> / 300:1	> 300 cd/m <sup>2</sup> / 300:1	> 300 cd/m <sup>2</sup> / 300:1	> 300 cd/m <sup>2</sup> / 300:1	> 300 cd/m <sup>2</sup> / 300:1	> 300 cd/m <sup>2</sup> / 300:1
<b>Control elements</b>						
Function keys	No	No	No	No	No	No
Operating mode						
• integrated mouse cursor control	No	No	No	No	No	No
<b>Installation type/mounting</b>						
Rack mounting possible	Yes	Yes	Yes	Yes	Yes	Yes
Desktop device	No	No	No	No	No	No
VESA mounting	No	No	No	No	No	No
<b>Supply voltage</b>						
Type of supply voltage	AC, DC	AC, DC	AC, DC	AC, DC	AC, DC	AC, DC
permissible range, lower limit (DC)	19.2 V	19.2 V	19.2 V	19.2 V	19.2 V	19.2 V
permissible range, upper limit (DC)	28.8 V	28.8 V	28.8 V	28.8 V	28.8 V	28.8 V
permissible range, lower limit (AC)	90 V	90 V	90 V	90 V	90 V	90 V
permissible range, upper limit (AC)	264 V	264 V	264 V	264 V	264 V	264 V
<b>Interfaces</b>						
Video interfaces						
• analog video signal (VGA)	Yes	Yes	Yes	Yes	Yes	Yes
<b>Degree and class of protection</b>						
IP54 at front	Yes; For screw mounting in 19" rack	Yes; For screw mounting in 19" rack	Yes; For screw mounting in 19" rack	Yes; For screw mounting in 19" rack	Yes; For screw mounting in 19" rack	Yes; For screw mounting in 19" rack
IP65 at front	Yes; if mounted with the supplied latch fasteners	Yes; if mounted with the supplied latch fasteners	Yes; if mounted with the supplied latch fasteners	Yes; if mounted with the supplied latch fasteners	Yes; if mounted with the supplied latch fasteners	Yes; if mounted with the supplied latch fasteners
IP20 rear	Yes	Yes	Yes	Yes	Yes	Yes
<b>Standards, approvals, certificates</b>						
UL	Yes	Yes	Yes	Yes	Yes	Yes
EAC (former Gost-R)	No	No	No	No	No	No
Marine approval						
• Germanischer Lloyd (GL)	Yes; Optional	Yes; Optional	Yes; Optional	Yes; Optional	Yes; Optional	Yes; Optional
• American Bureau of Shipping (ABS)	Yes; Optional	Yes; Optional	Yes; Optional	Yes; Optional	Yes; Optional	Yes; Optional
• Bureau Veritas (BV)	Yes; Optional	Yes; Optional	Yes; Optional	Yes; Optional	Yes; Optional	Yes; Optional
• Det Norske Veritas (DNV)	Yes; Optional	Yes; Optional	Yes; Optional	Yes; Optional	Yes; Optional	Yes; Optional
• Lloyds Register of Shipping (LRS)	Yes; Optional	Yes; Optional	Yes; Optional	Yes; Optional	Yes; Optional	Yes; Optional
<b>Ambient conditions</b>						
Max. ambient temperature	45 °C	45 °C	45 °C	45 °C	45 °C	45 °C
<b>Dimensions</b>						
Width of the housing front	483 mm	483 mm	483 mm	483 mm	483 mm	483 mm
Height of housing front	400 mm	400 mm	400 mm	400 mm	400 mm	400 mm
Mounting cutout/device depth (W x H x D)	449 x 380 x 56	449 x 380 x 56	449 x 380 x 56	449 x 380 x 56	449 x 380 x 56	449 x 380 x 56
Device depth	57 mm	57 mm	57 mm	57 mm	57 mm	57 mm

## PROFINET/Industrial Ethernet

### Industry monitors and Thin Clients

#### SIMATIC Flat Panels

Ordering data	Article No.
<b>Flat Panel Monitor</b>	<b>6AV7861 - 0 - 1 - A A 0</b>
Display size	1 2 3
Operator functionality:	A T
Power supply	A B
Version	0 1

#### Special versions

Flat Panel Monitor	Article No.
• 12" Key	<b>6AV7861-1KB10-1AA0</b>
• 15" Key	<b>6AV7861-2KB10-1AA0</b>
• PRO 15" Touch	<b>6AV7861-5TB10-1BA0</b>
• PRO 19" Touch	<b>6AV7861-6TB10-1BA0</b>

#### Accessories

<b>Protective films</b> For protecting the touch screen against dirt and scratches Pack with 10 units • for 12" Touch • for 15" Touch • for 19" Touch	<b>6AV7671-2BA00-0AA0</b> <b>6AV7671-4BA00-0AA0</b> <b>6AV7672-1CE00-0AA0</b>
<b>Touch pen</b> Undetachable pen for operation of the touch devices, mounting of the support on the control cabinet or directly on the PRO unit	<b>6AV7672-1JB00-0AA0</b>
<b>Connection cables for Standard, Extended and PRO versions</b>  Video (VGA) • 3.0 m • 5.0 m  Video (DVI-D) • 3.0 m • 5.0 m  USB for optional touch screen • 3.0 m • 5.0 m	<b>6AV7860-0AH30-0AA0</b> <b>6AV7860-0AH50-0AA0</b>  <b>6AV7860-0BH30-0AA0</b> <b>6AV7860-0BH50-0AA0</b>  <b>6AV7860-0CH30-0AA0</b> <b>6AV7860-0CH50-0AA0</b>
<b>Connection cables for Extended and PRO versions</b> • Cable set 10 m (DVI-D, CAT5 cable (USB), USB transmitter module) • Cable set 15 m (DVI-D, CAT5 cable (USB), USB transmitter module) • Cable set 20 m (DVI-D, CAT5 cable (USB), USB transmitter module) • Cable set 30 m (DVI-D, CAT5 cable (USB), USB transmitter module)	<b>6AV7860-1EX21-0AA1</b>  <b>6AV7860-1EX21-5AA1</b>  <b>6AV7860-1EX22-0AA1</b>  <b>6AV7860-1EX23-0AA1</b>

#### More information

Additional information is available on the Internet at:

<http://www.siemens.com/industrial-lcd>

#### Note:

Do you need a specific modification or extension to the products described here? Then refer to "Customized Automation". There you will find information about additional and generally available sector-specific products as well as options for customer-specific modification and adaptation.

Examples are:

- SIMATIC SCD monitor 1900 for portrait operation
- SIMATIC Flat Panels with 6" and 10" Touch



### Overview

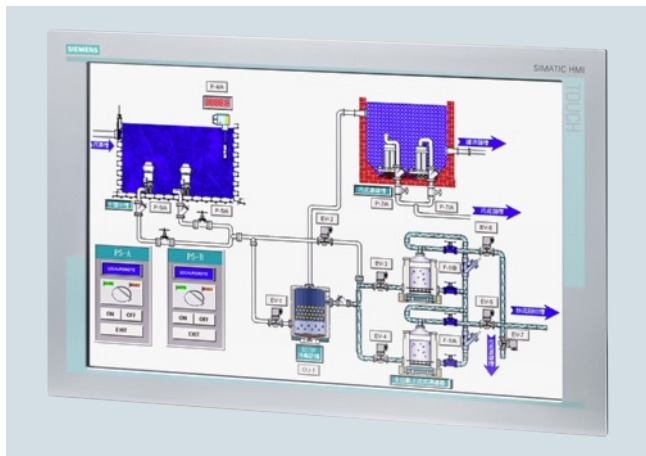

The SIMATIC HMI SCD 1900 is a rugged, industry-standard PC monitor.

It is used as an operator control unit in all types of industrial and standard PC, including for portrait mounting. Standard interfaces permit a wide range of possible applications.

#### Built-in versions:

- Built-in unit (for control cabinets, control desks, and gantries)
- Built-in portrait for portrait mounting (for control cabinets, control desks and gantries)
- 19" built-in units (for 19" racks)

#### Type of operator control:

- Panels with touch control

### Benefits

- Rugged industrial design, also designed for portrait operation:
  - High shock and vibration resistance as well as extremely high electromagnetic compatibility ensure failure safety and a long service life
  - Enclosure with IP65 degree of protection at the front, resistant against dust and humidity
  - Meets CE standard "Industry"
- No X-rays
- Lower energy requirement
- Fatigue-proof operation:
  - Large reading angle
  - Sharp and high-contrast graphic display
  - No flickering, uniform brightness
  - Automatic display adjustment (Auto Adjust)
- Configuration using on-screen display (OSD)
- Minimal space requirement and low weight
- Long service life

### Technical specifications

<b>6AV7862-2TA00-1AA0</b> <b>SCD 1900</b>	
<b>General information</b>	
Short designation	Flat Panel 19" Touch
<b>Display</b>	
Screen diagonal	19 in
visible area (HxV) in mm	255 x 408
Viewing angle	160° x 170°
Type	TFT widescreen display, LED backlighting
On Screen Display (OSD) configuration	Yes
Number of colors (bit levels)	24 bit
Number of colors	16 777 200; 16.7 million
Resolution (pixels)	
• Horizontal image resolution	1 440
• Vertical image resolution	900
• Resolution (WxH in pixel)	1440 x 900
<b>General features</b>	
• Brightness/contrast	300cd/m <sup>2</sup> / 1000:1
• Brightness, max.	300 cd/m <sup>2</sup>
<b>Backlighting</b>	
• MTBF backlighting (up to 50%, at 25 °C)	50 000 h
<b>Installation type/mounting</b>	
Rack mounting possible	Yes
Built-in unit	Yes
VESA mounting	No
<b>Supply voltage</b>	
Type of supply voltage	DC
permissible range, lower limit (DC)	21.6 V
permissible range, upper limit (DC)	26.4 V
<b>Interfaces</b>	
Video interfaces	
• analog video signal (VGA)	Yes
• DVI-D	Yes
Touch interfaces	
• USB	Yes
<b>Degree and class of protection</b>	
IP65 at front	Yes
IP20 rear	Yes
<b>Standards, approvals, certificates</b>	
CE mark	Yes; Industry
CSA approval	No
UL	Yes
cULus	Yes
<b>Ambient conditions</b>	
Storage/transport temperature	
• Min.	-20 °C
• max.	60 °C
Shock testing	
• Shock loading in operation	10 g
• Shock load during transport/storage	10 g
<b>Mechanics/material</b>	
Type of housing (front)	
• Aluminum	Yes
<b>Weights</b>	
Weight without packaging	6 kg

## PROFINET/Industrial Ethernet

### Industry monitors and Thin Clients

#### SCD monitors 1900

Ordering data	Article No.
<b>SCD monitor 1900</b>	<b>6AV7862-2TA00-1AA0</b>
<b>Portrait SCD monitor 1900</b>	<b>6AV7466-2TA17-1AA0</b>
<i>Accessories</i>	
<b>Cable for connecting to the graphics interface of the PC</b>	
<ul style="list-style-type: none"> <li>VGA cable, 3.0 m</li> <li>VGA cable, 5.0 m</li> <li>DVI-D cable, 3.0 m</li> <li>DVI-D cable, 5.0 m</li> </ul>	<b>6AV7860-0AH30-0AA0</b> <b>6AV7860-0AH50-0AA0</b> <b>6AV7860-0BH30-0AA0</b> <b>6AV7860-0BH50-0AA0</b>
<b>USB cable for connecting the touch screen</b>	
<ul style="list-style-type: none"> <li>3.0 m</li> <li>5.0 m</li> </ul>	<b>6AV7860-0CH30-0AA0</b> <b>6AV7860-0CH50-0AA0</b>
<b>External power supply for SCD 1900</b>	<b>6AV7860-2AD06-0AA0</b>
100-230 V AC, 50-60 Hz; incl. mounting accessories for optional installation at the device.	

#### More information

Additional information is available in the Internet under:  
<http://www.siemens.com/industrial-lcd>

### Overview



SIMATIC ITC Industrial Thin Clients are powerful operating units for flexible use in distributed visualization applications. All devices are equipped with high-resolution, brilliant widescreen displays, and due to the diverse communication protocols they can be used both for challenging machine-level operator control & monitoring and for the connection to control systems, e.g. in the SCADA environment. They can be used as (additional) operator stations on a SIMATIC Industrial PC, Panel PC, or server, and on a SIMATIC Panel.

The following installation versions are available:

- SIMATIC ITC1200 – 12" Touch
- SIMATIC ITC1500 – 15" Touch
- SIMATIC ITC1900 – 19" Touch
- SIMATIC ITC2200 – 22" Touch

The SIMATIC HMI Thin Client Ex is available for hazardous areas. This device differs technically from the devices mentioned above. For more details, refer to catalog ST 80/ST PC, chapter 3.

### Benefits

SIMATIC Industrial Thin Clients offer a wide range of possible applications, whether as additional operator stations for plant visualization on a Multi Panel or Comfort Panel, or as classical "client" which communicates with a server (e.g. SIMATIC IPC) using standard protocols such as RDP or VNC. The web browser functionality permits simple and fast access to any available web server in the network (e.g. S7 controller, intranet).

Very cost-effective client-server architectures can be implemented with SIMATIC ITCs. A further advantage of SIMATIC ITCs: They communicate exclusively via Ethernet, thus permitting extremely simple and cost-effective coverage of even large distances to the server.

The possibility of using SCADA and Office functionalities (e.g. WinCC, SAP, MS Excel) directly on-site on the machine supports the vertical integration of the data flow from higher-level systems all the way down to the machine level (e.g. warehouse utilization).

With Multisession it is possible to switch between several servers connected to a SIMATIC ITC any time. On the other hand, of course, it is possible to connect several thin clients to a server to implement multi-user solutions. The SIMATIC ITC itself requires no installations, licenses, and additional software.

The following communication options are supported

- Sm@rtServer for plant visualization with SIMATIC WinCC / SIMATIC WinCC flexible
- RDP (Remote Desktop Protocol) for SCADA and Office functionalities
- VNC (Virtual Network Computing) for remote operation of a PC
- Web browser functionality for operator control and monitoring of web-based applications
- As a Thin Client Unit on a SINUMERIK PCU/NCU

## PROFINET/Industrial Ethernet

### Industry monitors and Thin Clients

#### SIMATIC Industrial Thin Client

#### Technical specifications

	6AV6646-1AA22-0AX0	6AV6646-1AB22-0AX0	6AV6646-1AC22-0AX0	6AV6646-1AD22-0AX0
<b>Display</b>				
Screen diagonal	12.1 in	15.4 in	18.5 in	21.5 in
Display width	261.1 mm	331.2 mm	409.8 mm	495.6 mm
Display height	163.2 mm	207 mm	230.4 mm	292.2 mm
Type	TFT widescreen display, LED backlighting	TFT widescreen display, LED backlighting	TFT widescreen display, LED backlighting	TFT widescreen display, LED backlighting
Number of colors	16 777 200	16 777 200	16 777 200	16 777 200
Resolution (pixels)				
• Horizontal image resolution	1 280	1 280	1 366	1 920
• Vertical image resolution	800	800	768	1 080
<b>General features</b>				
• PDF reader	Yes	Yes	Yes	Yes
<b>Backlighting</b>				
• Backlighting (type)	LED, dimmable	LED, dimmable	LED, dimmable	LED, dimmable
• Dimmable backlight	Yes; 5-100 %	Yes; 5-100 %	Yes; 5-100 %	Yes; 5-100 %
<b>Control elements</b>				
<b>Mouse/cursor control</b>				
• external mouse				
- USB	Yes	Yes	Yes	Yes
<b>Keyboard fonts</b>				
• external keyboard				
- USB	Yes	Yes	Yes	Yes
<b>Touch operation</b>				
• Design as touch screen	Yes	Yes	Yes	Yes
- Touch screen (analog/resistive)	Yes	Yes	Yes	Yes
• Touch keyboard	Yes	Yes	Yes	Yes
<b>Installation type/mounting</b>				
Built-in unit	Yes	Yes	Yes	Yes
<b>Supply voltage</b>				
Type of supply voltage	24 V DC	24 V DC	24 V DC	24 V DC
permissible range, lower limit (DC)	19.2 V	19.2 V	19.2 V	19.2 V
permissible range, upper limit (DC)	28.8 V	28.8 V	28.8 V	28.8 V
<b>Input current</b>				
Current consumption, max.	1.2 A	1.5 A	1.3 A	2.2 A
Inrush current A <sup>2</sup> s	0.5 A <sup>2</sup> s	0.5 A <sup>2</sup> s	0.5 A <sup>2</sup> s	0.5 A <sup>2</sup> s
<b>Interfaces</b>				
USB on the rear	2	2	2	2
USB at the front	0	0	0	0
<b>Industrial Ethernet</b>				
• Transmission rate, max.	1 000 Mbit/s	1 000 Mbit/s	1 000 Mbit/s	1 000 Mbit/s
• Number of industrial Ethernet interfaces	1	1	1	1
<b>Protocols</b>				
<b>Protocols (Ethernet)</b>				
• TCP/IP	Yes	Yes	Yes	Yes
• DHCP	Yes	Yes	Yes	Yes
• SNMP	Yes	Yes	Yes	Yes
• DCP	Yes	Yes	Yes	Yes
• LLDP	Yes	Yes	Yes	Yes
<b>WEB characteristics</b>				
• HTTP	Yes	Yes	Yes	Yes
• HTML	Yes; HTML5	Yes; HTML5	Yes; HTML5	Yes; HTML5
• XML	Yes	Yes	Yes	Yes
• CSS	Yes	Yes	Yes	Yes
• JavaScript	Yes	Yes	Yes	Yes
<b>Protocols (terminal link)</b>				
• Sm@rtService	Yes	Yes	Yes	Yes
• RDP	Yes	Yes	Yes	Yes
• VNC viewer	Yes	Yes	Yes	Yes
• Citrix	No	No	No	No
• SINUMERIK	Yes	Yes	Yes	No

**Technical specifications (continued)**

	6AV6646-1AA22-0AX0	6AV6646-1AB22-0AX0	6AV6646-1AC22-0AX0	6AV6646-1AD22-0AX0
<b>Protocols</b>				
PROFINET IO Device				
• Services				
- PROFinergy	No	No	No	No
<b>Degree and class of protection</b>				
IP65 at front	Yes	Yes	Yes	Yes
IP20 rear	Yes	Yes	Yes	Yes
<b>Standards, approvals, certificates</b>				
CE mark	Yes	Yes	Yes	Yes
KC approval	Yes	Yes	Yes	Yes
cULus	Yes	Yes	Yes	Yes
RCM (former C-TICK)	Yes	Yes	Yes	Yes
Use in hazardous areas				
• cULus Class I Zone 1	No	No	No	No
• cULus Class I Zone 2, Division 2	Yes; Available soon	Yes; Available soon	Yes; Available soon	Yes; Available soon
• FM Class I Division 2	Yes; Available soon	Yes; Available soon	Yes; Available soon	Yes; Available soon
<b>Ambient conditions</b>				
Min. ambient temperature	0 °C	0 °C	0 °C	0 °C
Max. ambient temperature	50 °C	50 °C	45 °C	45 °C
Storage/transport temperature				
• [Fehlender Merkmalstext PMD_ACE481_001_000]	-20 °C	-20 °C	-20 °C	-20 °C
• [Fehlender Merkmalstext PMD_ACE483_001_000]	60 °C	60 °C	60 °C	60 °C
Relative humidity				
• Relative humidity during operation	90 %	90 %	90 %	90 %
<b>Software</b>				
Web browser	Yes	Yes	Yes	Yes
<b>Configuration</b>				
Configuration				
• On-board	Yes	Yes	Yes	Yes
• Remote administration	Yes; With Remote Configuration Center (RCC) as of V2.0	Yes; With Remote Configuration Center (RCC) as of V2.0	Yes; With Remote Configuration Center (RCC) as of V2.0	Yes; With Remote Configuration Center (RCC) as of V2.0
<b>Languages</b>				
Online languages				
• German	Yes	Yes	Yes	Yes
• English	Yes	Yes	Yes	Yes
<b>I/O/Options</b>				
I/O devices				
• USB memory	Yes; USB storage medium can be connected	Yes; USB storage medium can be connected	Yes; USB storage medium can be connected	Yes; USB storage medium can be connected
<b>Mechanics/material</b>				
Type of housing (front)				
• Aluminum	Yes	Yes	Yes	Yes
<b>Dimensions</b>				
Housing diameter/depth (mm)				
• Width	330 mm	415 mm	483 mm	560 mm
• Height	241 mm	310 mm	337 mm	380 mm
Mounting cutout (W x H x D)				
• Mounting cutout, width	310 mm	396 mm	465 mm	542 mm
• Mounting cutout, height	221 mm	291 mm	319 mm	362 mm
• Mounting cutout, depth	82 mm	75 mm	75 mm	75 mm
<b>Weights</b>				
Weight without packaging	3.4 kg	5.2 kg	6.5 kg	7.1 kg
Weight incl. packaging	4.1 kg	5.7 kg	7.1 kg	7.8 kg

## PROFINET/Industrial Ethernet

### Industry monitors and Thin Clients

#### SIMATIC Industrial Thin Client

##### Ordering data

##### Article No.

##### Industrial Thin Client

• SIMATIC ITC1200 12" Touch device	<b>6AV6646-1AA22-0AX0</b>
• SIMATIC ITC1500 15" Touch device	<b>6AV6646-1AB22-0AX0</b>
• SIMATIC ITC1900 19" Touch device	<b>6AV6646-1AC22-0AX0</b>
• SIMATIC ITC2200 22" Touch device	<b>6AV6646-1AD22-0AX0</b>

##### Accessories

See HMI accessories

##### More information

Additional information is available on the Internet at:

<http://www.siemens.com/simatic-itc>

## Overview



SIMATIC RF640R is a powerful UHF reader with integral antenna that is suitable for applications at single recording stations, in conveyor systems or production plants. Due to its high maximum transmission power of up to 2 W ERP (ETSI) / 4 W EIRP (FCC), longer ranges can also be achieved. The high degree of protection of the overall system is a guarantee for problem-free use, even under the most difficult environmental conditions. Instead of the integral antenna, an external antenna of the RF600 series (SIMATIC RF620A, RF640A, RF642A, RF660A) can be used. The reader offers 2 digital inputs (24 V) and 2 digital outputs (typ. 24 V/0.5 A) that have protection circuits for industrial use.

The integrated processing logic of the reader enables numerous functions to be executed in the device itself. For example, the reader offers extensive, intelligent filter functions, a parameterizable state machine for forwarding the data, the automatic control of the digital outputs for signaling functions, and the extensive configuration of response message frames. The advantage: Thanks to its intelligence, this considerably reduces the cost for additional software modules (RFID middleware). The reader is configured by means of the easy-to-use SIMATIC RF-MANAGER Basic software, which is provided on a free CD supplied with each reader.

Data communication takes place via an XML protocol with TCP/IP; the reader provides an Ethernet interface for this purpose. The protocol is compatible with the SIMATIC RF670R.

## Application

The stationary SIMATIC RF640R UHF reader with its integral antenna is suitable for applications in production (with PC/IT interface), production-level logistics, distribution, supply chain management, asset management, service processes or material flow control.

The digital inputs and outputs (DI/DO) are used for simple process interfacing (sensors, actuators).

The SIMATIC RF640R supports the established EPCglobal Class 1, Gen 2 standard and is offered in three versions: compliant with ETSI for Europe, compliant with FCC for USA/ Canada, and compliant with CMIIT for China.

## Technical specifications

Article No.	6GT2811-3BA00-0AA0	6GT2811-3BA00-1AA0	6GT2 811-3BA00-2AA0
Product-type designation	RF640R ETSI reader	RF640R FCC reader	RF640R reader CMIIT
<b>Suitability for installation</b>	RF600 transponder, for connecting to Ethernet networks	RF600 transponder, for connecting to Ethernet networks	RF600 transponder, for connecting to Ethernet networks
<b>Wireless frequencies</b>			
Operating frequency	865 ... 868 MHz	902 ... 928 MHz	920 ... 925 MHz
Transmit power	50 ... 1 000 mW	50 ... 1 250 mW	50 ... 1 000 mW
Effective radiant power for each external antenna maximum	2 000 mW	-	2 000 mW
Equivalent isotropic radiant power for each external antenna maximum	-	4 000 mW	-
<b>Electrical data</b>			
Range maximum	8 m	8 m	8 m
Range note	Refer to RF600 system manual, over-range is possible	Refer to RF600 system manual, over-range is possible	Refer to RF600 system manual, over-range is possible
Protocol for radio transmission	EPCglobal Class 1 Gen 2 / ISO 18000-6C	EPCglobal Class 1 Gen 2 / ISO 18000-6C	EPCglobal Class 1 Gen 2 / ISO 18000-6C
Transfer rate with radio transmission maximum	320 kbit/s	320 kbit/s	320 kbit/s
Product property multitag-capable	Yes	Yes	Yes
Polarization	Internal: circular, external: according to antenna	Internal: circular, external: according to antenna	Internal: circular, external: according to antenna
Transmission time for user data			
• for write access per byte typical	6.3 ms	6.3 ms	6.3 ms
• for read access per byte typical	1 ms	1 ms	1 ms

# PROFINET/Industrial Ethernet

## SIMATIC Identification systems

### RFID systems

#### SIMATIC RF640R

#### Technical specifications (continued)

Article No.	6GT2811-3BA00-0AA0	6GT2811-3BA00-1AA0	6GT2 811-3BA00-2AA0
Product-type designation	RF640R ETSI reader	RF640R FCC reader	RF640R reader CMIIT
<b>Interfaces</b>			
Number of external antennas	1	1	1
Design of electrical connection	-	-	-
• for external antenna(s)			
• for supply voltage	M12, 4-pin, female connector	M12, 4-pin, female connector	M12, 4-pin, female connector
Standard for interfaces for communication	Ethernet	Ethernet	Ethernet
Design of electrical connection			
• for communications interface	Push-pull RJ45	Push-pull RJ45	Push-pull RJ45
• at the digital inputs/outputs	M12, 8-pin, female connector	M12, 8-pin, female connector	M12, 8-pin, female connector
Number of digital inputs	2	2	2
Number of digital outputs	2	2	2
<b>Mechanical data</b>			
Material	Aluminum, ABS (GF20)	Aluminum, ABS (GF20)	Aluminum, ABS (GF20)
Color	Silver/anthracite	Silver/anthracite	Silver/anthracite
Mounting distance for metal surfaces recommended minimum	0 mm	0 mm	0 mm
<b>Supply voltage, current consumption, power loss</b>			
Supply voltage for DC			
• rated value	24 V	24 V	24 V
• minimum	20 V	20 V	20 V
• maximum	30 V	30 V	30 V
Consumed current at 24 V DC			
• typical	0.45 A	0.45 A	0.45 A
• maximum	1.5 A	1.5 A	1.5 A
<b>Permitted ambient conditions</b>			
Ambient temperature			
• during operating	-25 ... +55 °C	-25 ... +55 °C	-25 ... +55 °C
• during storage	-40 ... +85 °C	-40 ... +85 °C	-40 ... +85 °C
• during transport	-40 ... +85 °C	-40 ... +85 °C	-40 ... +85 °C
Ambient condition for (standard) operation mode	With operating temperature below -20 °C: Warming-up time at least 10 minutes	With operating temperature below -20 °C: Warming-up time at least 10 minutes	With operating temperature below -20 °C: Warming-up time at least 10 minutes
Protection class IP	IP65	IP65	IP65
Resistance against shock	EN 60068-2-27, EN 60068-2-6	EN 60068-2-27, EN 60068-2-6	EN 60068-2-27, EN 60068-2-6
Resistance against shock	500 m/s <sup>2</sup>	500 m/s <sup>2</sup>	500 m/s <sup>2</sup>
Resistance against vibration	200 m/s <sup>2</sup>	200 m/s <sup>2</sup>	200 m/s <sup>2</sup>
<b>Design, dimensions and weight</b>			
Width	193 mm	193 mm	193 mm
Height	252 mm	252 mm	252 mm
Depth	52 mm	52 mm	52 mm
Net weight	2.02 kg	2.01 kg	1.99 kg
Mounting type	4 x M6 screws, Vesa 100 with 4 x M4 screws	4 x M6 screws, Vesa 100 with 4 x M4 screws	4 x M6 screws, Vesa 100 with 4 x M4 screws
Cable length of antenna cable			
• minimum	3 m	3 m	3 m
• maximum	20 m	20 m	20 m
<b>Product properties, functions, components general</b>			
Type of display	3-color LED	3-color LED	3-color LED
Product feature silicon-free	Yes	Yes	Yes
<b>Standards, specifications, approvals</b>			
Verification of suitability	Wireless acc. to R&TTE guideline, CE, IEC 60950	Wireless according to FCC, IC (Canada), cULus	Wireless according to CMIIT
<b>Accessories</b>			
	optional: External antenna	optional: External antenna	optional: External antenna



Ordering data	Article No.
<b>SIMATIC RF640R reader (ETSI)</b> UHF RFID reader for frequencies from 865 to 868 MHz with integrated antenna, suitable for inclusion in PC systems via Ethernet with TCP/IP and XML protocol.	<b>6GT2811-3BA00-0AA0</b>
<b>SIMATIC RF640R reader (FCC)</b> UHF RFID reader for frequencies from 902 to 928 MHz with integrated antenna, suitable for inclusion in PC systems via Ethernet with TCP/IP and XML protocol.	<b>6GT2811-3BA00-1AA0</b>
<b>SIMATIC RF640R reader (CMIIT)</b> UHF RFID reader for frequencies from 920 to 925 MHz with integrated antenna, suitable for inclusion in PC systems via Ethernet with TCP/IP and XML protocol.	<b>6GT2811-3BA00-2AA0</b>
<b>Accessories</b>	
<b>DI/DO cable</b> For the connection of digital sensors and actuators to SIMATIC RF640R. M12 connector on reader side, open stranded wires on the sensor side. DI/DO cable, PUR material, black, shielded, M12, 8 x 0.14 mm <sup>2</sup> , length 5 m.	<b>6GT2891-0DH50</b>
<b>Set of protective caps</b> For achieving IP65 degree of protection if not all connections on the reader are assigned. Content: 3x protective caps for antenna connection, 1x protective cap for DI/DO connection; design: Metal.	<b>6GT2898-4AA00</b>
<b>Wide-range power supply</b> Primary side: 100 ... 240 V AC, 120 ... 353 V DC, secondary side: 24 V DC, 3 A, with no-load protection and continuous short-circuit protection. <ul style="list-style-type: none"> <li>• EU connector version</li> <li>• UK connector version</li> <li>• US connector version</li> </ul>	<b>6GT2898-0AA00</b> <b>6GT2898-0AA10</b> <b>6GT2898-0AA20</b>
<b>Cable for wide-range power supply</b> 24 V DC, material: PUR, length 5 m NOTICE: This cable is not suitable for SIMATIC RF660R.	<b>6GT2891-0NH50</b>
<b>Ethernet connection</b> <ul style="list-style-type: none"> <li>• Twisted connecting cable, IP65 on reader side, length 10 m.</li> <li>• Push-pull cable connector for RJ45, not pre-assembled.</li> <li>• Covers for push-pull sockets, RJ45, 5 units per pack. Price per pack.</li> </ul>	<b>6GT2891-1HN10</b> <b>6GK1901-1BB10-6AA0</b> <b>6ES7194-4JD50-0AA0</b>

**More information**

All current approvals can be found on the Internet at:

<http://www.siemens.com/rfid-approvals>

# PROFINET/Industrial Ethernet

## SIMATIC Identification systems

### RFID systems

#### SIMATIC RF670R

#### Overview



SIMATIC RF670R is a high-performance RFID reader with four antenna connections which can be configured as required for individual read stations, detecting at conveyor systems, or as gates. The high transmit power of up to 2 W ERP / 4 W EIRP (dependent on antenna and cable) permits large ranges of up to 10 m in gate applications. The high degree of protection of the overall system is a guarantee for problem-free use, even under the most difficult environmental conditions.

Due to the monostatic antenna principle, as many as four independent read stations can be implemented. All antennas of the RF600 series are supported (SIMATIC RF620A, RF640A, RF642A, RF660A). The reader offers 4 digital inputs (24 V) and 4 digital outputs (typ. 24 V/0.5 A) that have protection circuits for industrial use.

The integrated processing logic of the reader enables numerous functions of the higher-level software layers to be executed in the device itself. For example, the reader offers extensive, intelligent filter functions, a parameterizable state machine for forwarding the data, the automatic control of the digital outputs for signaling functions, and the extensive configuration of response message frames. The advantage: Thanks to its intelligence, this considerably reduces the cost for additional software modules (RFID middleware). The reader is configured by means of the easy-to-use SIMATIC RF-MANAGER Basic software, which is provided on a free CD supplied with each reader.

Data communication for the RF670R is performed by means of an XML protocol with TCP/IP; the reader provides an Ethernet interface for this purpose.

#### Application

With up to four antennas, the stationary SIMATIC RF670R UHF portal reader is suitable for applications in production (with PC/IT interface), production-level logistics, distribution, supply chain management, asset management, service processes, or material flow control.

The digital inputs and outputs (DI/DO) are used for simple process interfacing (sensors, actuators).

The SIMATIC RF670R supports the established EPCglobal Class 1, Gen 2 standard and is offered in three versions: compliant with ETSI for Europe, compliant with FCC for USA/Canada, and compliant with CMIIT for China.

#### Technical specifications

Article No.	6GT2811-0AB00-0AA0	6GT2811-0AB00-1AA0	6GT2811-0AB00-2AA0
Product-type designation	RF670R ETSI reader	RF670R FCC reader	RF670R CMIIT reader
<b>Suitability for installation</b>	RF600 transponder, for connecting to Ethernet networks	RF600 transponder, for connecting to Ethernet networks	RF600 transponder, for connecting to Ethernet networks
<b>Wireless frequencies</b>			
Operating frequency	865 ... 868 MHz	902 ... 928 MHz	920 ... 925 MHz
Transmit power	50 ... 1000 mW	50 ... 1250 mW	50 ... 1000 mW
Effective radiant power for each external antenna maximum	2000 mW	-	2000 mW
Equivalent isotropic radiant power for each external antenna maximum	-	4000 mW	-
<b>Electrical data</b>			
Range maximum	8 m	8 m	8 m
Range note	Refer to RF600 system manual, overrange is possible	Refer to RF600 system manual, overrange is possible	Refer to RF600 system manual, overrange is possible
Protocol for radio transmission	EPCglobal Class 1 Gen 2 / ISO 18000-6C	EPCglobal Class 1 Gen 2 / ISO 18000-6C	EPCglobal Class 1 Gen 2 / ISO 18000-6C
Transfer rate with radio transmission maximum	320 kbit/s	320 kbit/s	320 kbit/s
Product property multitag-capable	Yes	Yes	Yes
Transmission time for user data			
• for write access per byte typical	6.3 ms	6.3 ms	6.3 ms
• for read access per byte typical	1 ms	1 ms	1 ms

**Technical specifications (continued)**

Article No.	6GT2811-0AB00-0AA0	6GT2811-0AB00-1AA0	6GT2811-0AB00-2AA0
Product-type designation	RF670R ETSI reader	RF670R FCC reader	RF670R CMIIT reader
<b>Interfaces</b>			
Design of the electrical connection for external antenna(s)	RP-TNC	RP-TNC	RP-TNC
Number of external antennas	4	4	4
Design of electrical connection • for supply voltage	M12, 4-pin, female connector	M12, 4-pin, female connector	M12, 4-pin, female connector
Standard for interfaces for communication • for communications interface • at the digital inputs/outputs	Ethernet Push-pull RJ45 M12, 12-pin, female connector	Ethernet Push-pull RJ45 M12, 12-pin, female connector	Ethernet Push-pull RJ45 M12, 12-pin, female connector
Number of digital inputs	4	4	4
Number of digital outputs	4	4	4
<b>Mechanical data</b>			
Material	Aluminum, ABS (GF20)	Aluminum, ABS (GF20)	Aluminum, ABS (GF20)
Color	Silver/anthracite	Silver/anthracite	Silver/anthracite
<b>Supply voltage, current consumption, power loss</b>			
Supply voltage for DC • rated value • minimum • maximum	24 V 20 V 30 V	24 V 20 V 30 V	24 V 20 V 30 V
Consumed current at 24 V with DC • typical • maximum	0.45 A 2 A	0.45 A 2 A	0.45 A 2 A
<b>Permitted ambient conditions</b>			
Ambient temperature • during operating • during storage • during transport	-25 ... +55 °C -40 ... +85 °C -40 ... +85 °C	-25 ... +55 °C -40 ... +85 °C -40 ... +85 °C	-25 ... +55 °C -40 ... +85 °C -40 ... +85 °C
Protection class IP	IP65	IP65	IP65
Resistance against shock	EN 60068-2-27, EN 60068-2-6	EN 60068-2-27, EN 60068-2-6	EN 60068-2-27, EN 60068-2-6
Resistance against shock	500 m/s <sup>2</sup>	500 m/s <sup>2</sup>	500 m/s <sup>2</sup>
Resistance against vibration	200 m/s <sup>2</sup>	200 m/s <sup>2</sup>	200 m/s <sup>2</sup>
<b>Design, dimensions and weight</b>			
Width	193 mm	193 mm	193 mm
Height	252 mm	252 mm	252 mm
Depth	52 mm	52 mm	52 mm
Net weight	1.8 kg	1.8 kg	1.8 kg
Mounting type	4 x M6 screws, Vesa 100 with 4 x M4 screws	4 x M6 screws, Vesa 100 with 4 x M4 screws	4 x M6 screws, Vesa 100 with 4 x M4 screws
Cable length of antenna cable • minimum • maximum	3 m 20 m	3 m 20 m	3 m 20 m
<b>Product properties, functions, components general</b>			
Type of display	3-color LED	3-color LED	3-color LED
Product feature silicon-free	Yes	Yes	Yes
<b>Standards, specifications, approvals</b>			
Verification of suitability	Wireless acc. to R&TTE guideline, CE, IEC 60950	Wireless according to FCC, IC (Canada), cULus	Wireless according to CMIIT
<b>Accessories</b>			
Accessories	One or 4 external antennas	One or 4 external antennas	One or 4 external antennas

# PROFINET/Industrial Ethernet

## SIMATIC Identification systems

### RFID systems

#### SIMATIC RF670R

Ordering data	Article No.
<b>SIMATIC RF670R reader (ETSI)</b> UHF RFID reader for frequencies from 865 to 868 MHz for connecting up to four external antennas, suitable for inclusion in PC systems via Ethernet with TCP/IP and XML protocol.	<b>6GT2811-0AB00-0AA0</b>
<b>SIMATIC RF670R reader (FCC)</b> UHF RFID reader for frequencies from 902 to 928 MHz for connecting up to four external antennas, suitable for inclusion in PC systems via Ethernet with TCP/IP and XML protocol.	<b>6GT2811-0AB00-1AA0</b>
<b>SIMATIC RF670R reader (CMIIT)</b> UHF RFID reader for frequencies from 920 to 925 MHz for connecting up to four external antennas, suitable for inclusion in PC systems via Ethernet with TCP/IP and XML protocol.	<b>6GT2811-0AB00-2AA0</b>
<b>Accessories</b> Note: For proper functioning of the SIMATIC RF670R reader, we recommend using the SIMATIC RF620A / 640A / 642A / 660A antennas.	
<b>DI/DO cable</b> For the connection of digital sensors and actuators to SIMATIC RF670R. M12 connector on reader side, open stranded wires on the sensor side. DI/DO cable, PUR material, black, shielded, M12, 12 x 0.14 mm <sup>2</sup> , length 5 m.	<b>6GT2891-0CH50</b>
<b>Wide-range power supply</b> Primary side: 100 ... 240 V AC, 120 ... 353 V DC, secondary side: 24 V DC, 3 A, with no-load protection, with continuous short-circuit protection <ul style="list-style-type: none"> <li>• EU connector version</li> <li>• UK connector version</li> <li>• US connector version</li> </ul>	<b>6GT2898-0AA00</b> <b>6GT2898-0AA10</b> <b>6GT2898-0AA20</b>
<b>Cable for wide-range power supply</b> 24 V DC, PUR material, length 5 m. NOTICE: This cable is not suitable for SIMATIC RF660R.	<b>6GT2891-0NH50</b>
<b>Ethernet connection</b> <ul style="list-style-type: none"> <li>• Twisted connecting cable, IP65 on reader side, length 10 m.</li> <li>• Push-pull cable connector for RJ45, not pre-assembled.</li> <li>• Covers for push-pull sockets, RJ45, 5 units per pack. Price per pack.</li> </ul>	<b>6GT2891-1HN10</b> <b>6GK1901-1BB10-6AA0</b> <b>6ES7194-4JD50-0AA0</b>
<b>Set of protective caps</b> For achieving IP65 degree of protection if not all connections on the reader are assigned. Content: 3x protective caps for antenna connection, 1x protective cap for DI/DO connection; design: Metal.	<b>6GT2898-4AA00</b>

#### More information

All current approvals can be found on the Internet at:

<http://www.siemens.com/rfid-approvals>

## Overview



SIMATIC RF180C / RF182C and RFID 181EIP are communication modules for direct connection of SIMATIC identification systems to PROFINET IO/Ethernet and Ethernet/IP. The readers (SLGs) of the RFID systems MOBY D/U, SIMATIC RF200 / RF300 / RF600 as well as the MV400 code reading systems (RF180C and RFID 181EIP only) can be operated on the communication modules.

Due to their high degree of protection and ruggedness, the SIMATIC RF180C / RF182C and RFID 181EIP are ideally suitable for use at the machine level. The uniform plug-in connection system ensures rapid commissioning.

## Benefits



- Two parallel reader channels ensure real-time mode at dynamic read points.
- Reader connection using an 8-pin M12 connector for fast installation of all components.
- Different connection systems to suit any application:
  - M12, 7/8", the well-proven round connectors.
  - Push-pull connectors for quick assembly with RJ45 data connectors and 24 V connectors.
- Easy changeover from PROFIBUS applications to PROFINET with SIMATIC RF180C thanks to software compatibility.
- The integrated switch allows several PROFINET/Ethernet modules to be installed in a star or bus topology. Each application can then be set up quickly and inexpensively.
- Powerful hardware ensures rapid data communication with the reader (SLG). Consequently, data is available for the application even faster.
- Simple firmware downloading in the case of function expansions and error rectification ensures high availability of the identification system.
- Adjustable and parameterizable identification-system-specific diagnostics facilitate easy commissioning and troubleshooting.
- A broad selection of pre-assembled connecting cables can be ordered for connecting PROFINET/Ethernet and readers to SIMATIC RF180C/RF182C. This saves time and money during installation and assures better quality.

## Application

The Ethernet-based communication modules have been specially designed for a wide range of applications in industrial automation and logistics. Due to their high IP67 degree of protection, the SIMATIC RF180C/RF182C and RFID 181EIP can be installed in the process outside the control cabinet.

Main applications for SIMATIC RF180C/RF182C and RFID 181EIP:

- Mechanical engineering, automation systems, conveyor systems
- Ancillary assembly lines in the automotive industry / suppliers
- Small assembly lines

## Design

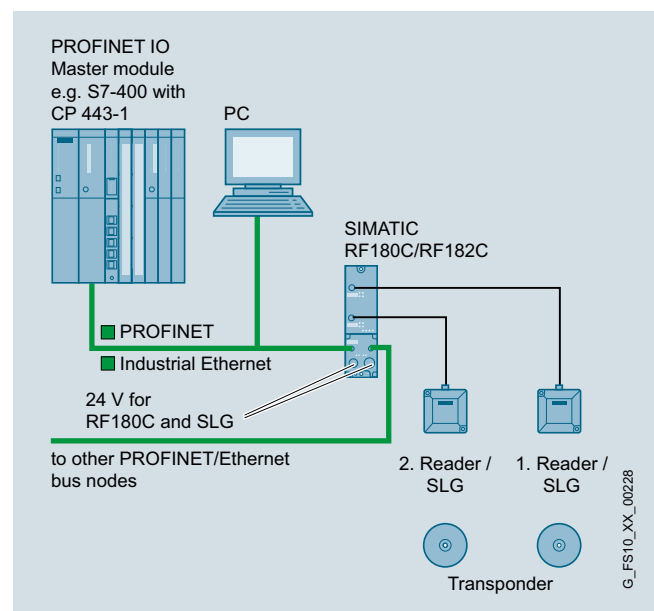

RFID integration into PROFINET/Ethernet network

## PROFINET/Industrial Ethernet

### SIMATIC Identification systems

### RFID systems

#### SIMATIC RF180C/RF182C

#### Function

The SIMATIC RF180C / RF182C and RFID 181EIP communication modules consist of a basic module and a connection block that must be ordered separately.

The connection block is available in three versions:

- M12, 7/8" (5-pole):  
PROFINET/Ethernet is connected by means of an M12 connector, the power supply is connected by means of a 5-pole 7/8" connector. There are 2 connections each for PROFINET/Ethernet as well as for the power supply. This ensures that the SIMATIC RF180C/RF182C can be connected to additional bus nodes without the need for external distributors. The removable connection block allows a base module to be replaced without interrupting the supply voltage to other bus stations.
- Push-pull connector (according to IEC 61918):  
PROFINET/Ethernet and the power supply are connected by means of a push-pull connector. There are 2 connections each for PROFINET/Ethernet as well as for the power supply. This ensures that the SIMATIC RF180C/RF182C can be connected to additional bus nodes without the need for external distributors. The supply voltage connectors can conduct currents of up to 12 A (1L+ and 2L+). The removable connection block allows a base module to be replaced without interrupting the supply voltage to other bus stations.
- M12, 7/8" (4-pole; not recommended for RF180C):  
Ethernet is connected by means of an M12 connector, the power supply is connected by means of a 4-pole 7/8" connector. There are 2 connections for Ethernet and one connection is available for the power supply. This connection block can be used in applications where the 5-pole 7/8" connector is already being used for other functions and therefore cannot be used for the power supply.

A pre-assembled reader cable is used to connect one or two readers to the communication module. The standard cable length is 2 m. If other reader cable lengths are required, an extension cable from 2 to 50 m in length can be used. The cable can also be assembled by the customer as required.

The data in the transponder can be accessed as follows:  
Direct addressing via absolute addresses.

Error messages and operating states (transponder in the field, transmission, etc.) are indicated additionally by means of LEDs and simplify commissioning and service.

SIMATIC RF180C/RF182C and RFID 181EIP have two reader interfaces from which the readers are also supplied with voltage. In the communication module, the power supply of the readers has an electronic fuse. The maximum permissible current per communication module for the readers is 1 A. It is of no importance here whether the current is drawn by 1 or 2 readers.

#### **SIMATIC RF180C**

The SIMATIC RF180C is designed for use in PROFINET networks. SIMATIC RF180C is integrated in SIMATIC STEP 7 via the GSDML file. SIMATIC RF180C can then be configured via the SW tool HW Config of SIMATIC Manager or another PROFINET tool.

The application accesses the tag via FB45. FB45 accesses the tag/Data Matrix Code via absolute addresses. For large volumes of data and complex tag operations, the FB45 can process chained commands.

Data is exchanged between SIMATIC RF180C and the application by means of acyclic data records. This ensures that a large quantity of data can be transferred from/to SIMATIC RF180C without loading the bus cycle. This is advantageous when large volumes of data are being transferred. SIMATIC RF180C can also process chained tag commands in this mode extremely quickly.

#### **SIMATIC RF182C**

The SIMATIC RF182C is designed for use in Ethernet networks based on TCP/IP. The IP address of the SIMATIC RF182C is set using the "Primary Setup Tool". The RF182C is then ready for operation. This tool can be downloaded from

<http://support.automation.siemens.com/WW/view/en/19440762>

Communication with the SIMATIC RF182C is implemented using XML commands. XML commands have a very simple structure. This makes programming of the RF182C under any operating system very easy. The simple command command set of the RF182C can also be programmed easily in any Ethernet-capable controller.

#### **RFID 181EIP**

The communication module RFID 181EIP is for use in Ethernet/IP networks. A DHCP server automatically assigns an IP address to the RFID 181EIP. Alternatively, the user can assign static IP addresses on the DHCP server. The standard tool for assigning IP addresses is called the BOOTP/DHCP server and is included in the RSLinx software package.

The RFID 181EIP communicates with the reader by means of implicit and explicit messages. Commands and results are transferred with explicit messages. The user sets up the commands directly in the application program.

**Technical specifications**

Article No.	6GT2002-0JD00	6GT2002-0JD10	6GT2002-0JD20
Product-type designation	RF180C communication module	RF182C communication module	RFID 181EIP communication module
<b>Suitability for installation</b>	PROFINET in conjunction with RF200/300/600, MOBY D/E/I/U, MV	Industrial Ethernet in conjunction with RF200/300/600, MOBY D/U	Ethernet/IP in conjunction with RF200/300/600, MOBY D/E/I/U, MV
Transmission rate • with Industrial Ethernet • at point-to-point connection serial maximum	10 ... 100 Mbit/s 115.2 kbit/s	10 ... 100 Mbit/s 115.2 kbit/s	10 ... 100 Mbit/s 115.2 kbit/s
<b>Interfaces</b>			
Design of interface for point-to-point connection	RS422	RS422	RS422
Number of readers connectable	2	2	2
Design of the electrical connection the Industrial Ethernet Interface	(according to the connection block)	(according to the connection block)	(according to the connection block)
Design of electrical connection for supply voltage	(according to the connection block)	(according to the connection block)	(according to the connection block)
Version of the interface to the reader for communication	M12, 8-pin	M12, 8-pin	M12, 8-pin
<b>Mechanical data</b>			
Material	Thermoplastic (Valox 467, fiberglass reinforced)	Thermoplastic (Valox 467, fiberglass reinforced)	Thermoplastic (Valox 467, fiberglass reinforced)
Color	IP Basic 714	IP Basic 714	IP Basic 714
Tightening torque of screw for mounting the equipment maximum	3 N·m	3 N·m	3 N·m
<b>Supply voltage, current consumption, power loss</b>			
Supply voltage for DC • rated value • minimum • maximum	24 V 20 V 30 V	24 V 20 V 30 V	24 V 20 V 30 V
Current consumed at 24 V DC • without connected devices typical • including connected devices maximum	0.1 A 1.1 A	0.1 A 1.1 A	0.1 A 1.1 A
<b>Permitted ambient conditions</b>			
Ambient temperature • during operating • during storage • during transport	0 ... 60 °C -40 ... +70 °C -40 ... +70 °C	0 ... 60 °C -40 ... +70 °C -40 ... +70 °C	0 ... 60 °C -40 ... +70 °C -40 ... +70 °C
Protection class IP	IP 67	IP 67	IP 67
Resistance against shock	According to IEC 61131-2	According to IEC 61131-2	According to IEC 61131-2
Resistance against shock	300 m/s <sup>2</sup>	300 m/s <sup>2</sup>	300 m/s <sup>2</sup>
Resistance against vibration	100 m/s <sup>2</sup>	100 m/s <sup>2</sup>	100 m/s <sup>2</sup>

# PROFINET/Industrial Ethernet

## SIMATIC Identification systems

### RFID systems

#### SIMATIC RF180C/RF182C

#### Technical specifications (continued)

Article No.	6GT2002-0JD00	6GT2002-0JD10	6GT2002-0JD20
Product-type designation	RF180C communication module	RF182C communication module	RFID 181EIP communication module
<b>Design, dimensions and weight</b>			
Width	60 mm	60 mm	60 mm
Height	30 mm	30 mm	30 mm
Depth	210 mm	210 mm	210 mm
Net weight	0.21 kg	0.21 kg	0.21 kg
Mounting type	2 x M5 screws	2 x M5 screws	2 x M5 screws
Cable length for RS 422 interface maximum	1000 m	1000 m	1000 m
<b>Product properties, functions, components general</b>			
Type of display	4 LEDs per reader connection, 4 LEDs for device status	4 LEDs per reader connection, 4 LEDs for device status	4 LEDs per reader connection, 4 LEDs for device status
Product function			
• Media Redundancy Protocol (MRP)	No	No	No
• transponder file handler can be addressed	Yes	No	Yes
Protocol			
• is supported			
- LLDP	Yes	No	No
- PROFINET IO protocol	Yes	No	No
- TCP/IP	No	Yes	No
EtherNet/IP protocol	No	No	Yes
<b>Product functions management, configuration</b>			
Type of parameterization	GSDML	XML	EDS file
Type of programming	FB 45, FB 55, Ident profile (PIB)	XML commands	Data records via implicit/explicit messages
Type of computer-mediated communication	acyclic communication	XML	Implicit/explicit messaging
<b>Standards, specifications, approvals</b>			
Verification of suitability	CE, FCC, cULus, PNO: Conformance Class B	CE, FCC, cULus	CE, FCC, cULus
<b>Accessories</b>			
Accessories	Connection block M12 d-coded, 7/8" 5-pin or push-pull	Connection block M12 d-coded, 7/8" 5-pin or push-pull or M12 d-coded, 7/8" 4-pin	Connection block M12 d-coded, 7/8" 5-pin or push-pull or M12 d-coded, 7/8" 4-pin



**Technical specifications (continued)**

Article No.	6GT2002-1JD00	6GT2002-2JD00	6GT2002-4JD00
Product-type designation	Connection block for RF18xC, M12, 7/8" 5-pin	Connection block for RF18xC, push-pull	Connection block for RF18xC, M12, 7/8" 4-pin
<b>Suitability for installation</b>	Connection block for RF180C, RF182C, RFID 181EIP	Connection block for RF180C, RF182C, RFID 181EIP	Connection block for RF180C, RF182C, RFID 181EIP
Transmission rate with Industrial Ethernet	10 ... 100 Mbit/s	10 ... 100 Mbit/s	10 ... 100 Mbit/s
<b>Interfaces</b>			
Design of the electrical connection the Industrial Ethernet Interface	M12, d-coded	push-pull, RJ 45	M12, d-coded
Design of electrical connection for supply voltage	7/8" 5-pin	push-pull, 5-pin	7/8" 4-pin
<b>Mechanical data</b>			
Material	Die-cast zinc	Thermoplastic (Valox 467, fiberglass reinforced)	Die-cast zinc
Color	Silver	IP Basic 714	Silver
Tightening torque of screw for mounting the equipment maximum	1.3 N·m	1 N·m	1.3 N·m
<b>Supply voltage, current consumption, power loss</b>			
Supply voltage for DC			
• rated value	24 V	24 V	24 V
• minimum	20 V	20 V	20 V
• maximum	30 V	30 V	30 V
Continuous current for loop-through to further bus nodes with DC, maximum	8 A	12 A	8 A
<b>Permitted ambient conditions</b>			
Ambient temperature			
• during operating	0 ... 60 °C	0 ... 60 °C	0 ... 60 °C
• during storage	-40 ... +70 °C	-40 ... +70 °C	-40 ... +70 °C
• during transport	-40 ... +70 °C	-40 ... +70 °C	-40 ... +70 °C
Protection class IP	IP 67	IP 67	IP 67
Resistance against shock	According to IEC 61131-2	According to IEC 61131-2	According to IEC 61131-2
Resistance against shock	300 m/s <sup>2</sup>	300 m/s <sup>2</sup>	300 m/s <sup>2</sup>
Resistance against vibration	100 m/s <sup>2</sup>	100 m/s <sup>2</sup>	100 m/s <sup>2</sup>
<b>Design, dimensions and weight</b>			
Width	60 mm	60 mm	60 mm
Height	24 mm	70 mm	24 mm
Depth	79 mm	85 mm	79 mm
Net weight	0.23 kg	0.12 kg	0.23 kg
Mounting type	4 screws included	4 screws included	4 screws included
<b>Product properties, functions, components general</b>			
Type of display	4 LEDs for Ethernet status	4 LEDs for Ethernet status	4 LEDs for Ethernet status
<b>Accessories</b>			
Accessories	-	-	-

# PROFINET/Industrial Ethernet

## SIMATIC Identification systems

### RFID systems

#### SIMATIC RF180C/RF182C

Ordering data	Article No.	Article No.
<b>SIMATIC RF180C communication module</b> For PROFINET, for connecting 2 readers, without a connection block.	6GT2002-0JD00	<b>IE M12 control cabinet bushing</b> For conversion from M12 (D-coded) to RJ45, pack with 5 units, minimum ordering quantity 1 pack.
<b>SIMATIC RF182C communication module</b> For Ethernet, for connecting 2 readers, without a connection block.	6GT2002-0JD10	<b>IE Connecting Cable M12-180/IE FC RJ45 Plug 145</b> Pre-assembled IE FC TP trailing cable GP 2 x 2 (PROFINET type C) with M12 plug (D-coded) and IE FC RJ45 plug, IP65/IP67 degree of protection, length 2 m.
<b>Communication module SIMATIC RFID 181EIP</b> For Ethernet/IP, for connecting 2 readers, without a connection block.	6GT2002-0JD20	<b>IE FC RJ45 PLUG 180 RJ45 plug</b> With rugged metal housing and FC connection system, straight cable outlet.
<b>PROFINET connection block</b> For SIMATIC RF180C/RF182C, M12 d-coded, 7/8" (5-pole).	6GT2002-1JD00	<b>Sealing caps 7/8"</b> Pack with 10 units, minimum ordering quantity 1 pack.
<b>PROFINET connection block</b> For SIMATIC RF180C/RF182C, push-pull RJ45.	6GT2002-2JD00	<i>Accessories for push pull RJ45 network connection</i>
<b>PROFINET connection block</b> For SIMATIC RF182C, RFID 181EIP, M12 d-coded, 7/8" (4-pole).	6GT2002-4JD00	<b>Push-pull cable connector for 1L+/2L+</b> Unassembled.
<i>Accessories for network connection M12, 7/8" (5-pole)</i>		<b>Push-pull cable connector for RJ45</b> Unassembled.
<b>IE M12-180/M12-180 connecting cable</b> Pre-assembled IE FC TP trailing cable GP 2x2 (PROFINET Type C), with two 4-pin M12 plugs (D-coded), maximum length 85 m, IP65/IP67 degree of protection. Lengths:		<b>Cover caps for push-pull female connectors</b> (1L+/ 2L+), pack of 5.
0.3 m	6XV1870-8AE30	<b>Cover caps for push-pull female connectors</b> RJ45, pack of 5.
0.5 m	6XV1870-8AE50	<i>Accessories for network connection M12, 7/8" (4-pole)</i>
1 m	6XV1870-8AH10	<b>Network wiring with M12</b> Accessories as for M12, 7/8" (5-pole)
1.5 m	6XV1870-8AH15	<b>Power supply with 7/8" (4-pole)</b> No cables and connectors from Siemens
2 m	6XV1870-8AH20	<i>Accessories for PROFINET bus components</i>
3 m	6XV1870-8AH30	<b>SCALANCE X204-2 Industrial Ethernet Switch</b> Industrial Ethernet switches with integral SNMP access, Web diagnostics, copper cable diagnostics, and PROFINET diag- nostics for configuring line, star and ring topologies, with integrated redundancy manager (exception: SCALANCE X208PRO), including operating instructions, Industrial Ethernet network manual, and configuration software on CD-ROM.  With electrical and optical ports for glass multi-mode fiber-optic cable up to 5 km: four 10/100 Mbit/s RJ45 ports and two fiber-optic ports.
5 m	6XV1870-8AH50	
10 m	6XV1870-8AN10	
15 m	6XV1870-8AN15	
<b>7/8" connecting cable to power supply</b> Pre-assembled with two 5-pin 7/8" male and female connectors. Lengths:		<b>SCALANCE X204IRT PRO Industrial Ethernet switch</b> Managed Industrial Ethernet switch, isochronous real-time, LED diagnostics, fault signaling contact with SET button, redundant power supply, incl. operating instructions, Industrial Ethernet network manual, and configuration software on CD-ROM.  Four 10/100 Mbit/s RJ45 push-pull ports
0.3 m	6XV1822-5BE30	
0.5 m	6XV1822-5BE50	
1 m	6XV1822-5BH10	
1.5 m	6XV1822-5BH15	
2 m	6XV1822-5BH20	
3 m	6XV1822-5BH30	
5 m	6XV1822-5BH50	
10 m	6XV1822-5BN10	
15 m	6XV1822-5BN15	
<b>PROFINET M12 plug-in connectors</b> Rugged metal housing; axial cable outlet; D-coded.	6GK1901-0DB20-6AA0	
<b>7/8" cable connector, for voltage</b> Pack with 5 units, minimum ordering quantity 1 pack. • With male insert • With female insert	6GK1905-0FA00 6GK1905-0FB00	

Ordering data	Article No.	Article No.
<i>Accessories for PROFINET bus components</i>		<i>Accessories for RFID</i>
<b>IE FC TP standard cable GP 2x2</b> 4-core, shielded TP installation cable for connection to IE, FC outlet RJ45/IE FC RJ45 plug, PROFINET-compatible, with UL approval, sold by the meter, max. delivery unit 1000 m, minimum ordering quantity 20 m.	<b>6XV1840-2AH10</b>	<b>MOBY U reader cable</b> PUR material, CMG approval, suitable for cable carriers. Lengths: 2 m 5 m
<b>Power line</b> 5-core, 5 x 1.5 mm <sup>2</sup> , trailing type, sold by the meter, minimum ordering quantity 20 m, maximum ordering quantity 1000 m.	<b>6XV1830-8AH10</b>	<b>MOBY D reader cable</b> PUR material, CMG approval, suitable for cable carriers, 2 m.
<i>General accessories</i>		<b>Reader cable for SIMATIC RF200 / RF300 / RF600 / MV420 / MV440</b> Or extension cable MOBY U/D and SIMATIC RF200 / RF300 / RF600 / MV400, PUR material, CMG approval, suitable for cable carriers, straight connector. Lengths: 2 m 5 m 10 m 20 m 50 m 2 m, plug angled at reader 5 m, plug angled at reader
<b>Stainless steel screws for connection blocks</b> Optional screws made of V4A steel for securing the connection blocks on the basic module. For use in wet areas. Pack with 40 units is sufficient for 10 connection blocks.	<b>6GT2090-0VB00</b>	<b>Sealing caps M12 for unused reader connections</b> Minimum ordering quantity 10 units.
		<b>DVD "RFID Systems Software &amp; Documentation"</b>
		<b>6GT2091-4FH20</b> <b>6GT2091-4FH50</b> <b>6GT2691-4FH20</b> <b>6GT2891-4FH20</b> <b>6GT2891-4FH50</b> <b>6GT2891-4FN10</b> <b>6GT2891-4FN20</b> <b>6GT2891-4FN50</b> <b>6GT2891-4JH20</b> <b>6GT2891-4JH50</b> <b>3RX9802-0AA00</b> <b>6GT2080-2AA20</b>

## PROFINET/Industrial Ethernet

### SIMATIC Identification systems

### Code reading systems

#### SIMATIC MV420

#### Overview



The SIMATIC MV420 is a particularly compact code reading system suitable for close-up to mid-range reading distances (approx. 10 mm to 400 mm).

SIMATIC MV420 has been specifically designed for detecting and evaluating a variety of machine readable codes in the packaging industry (e.g. F&B, pharmaceuticals, and tobacco) and industrial production (e.g. automotive, electronics, and solar). The list of readable codes includes all standard matrix codes and bar codes which can be reliably detected - mostly independent of the printing technology applied and carrier medium used. One key feature of the unit is its ability to read data matrix codes (DMC). The SIMATIC MV420 device family is flexible, reliable and easy to use.

Highlights at a glance:

- Compact design with IP67 degree of protection.
- Variety of lenses with variable reading distances.
- Integrated high-performance lighting.
- Web server technology: Parameterizable with regular Web browser.
- Interfaces: Ethernet, PROFINET, RS232, DI/DO, and direct connection to RFID communication modules (ASM).
- Exceptionally high reading speeds, depending on the model.

Further important product characteristics are:

- Excellent read algorithms based on the SIMATIC MV440 and VS130-2 code reading systems and many years of experience in industrial applications.
- No special knowledge required for reliable parameterization of reading features. Parameterization usually unnecessary, and is only required for difficult to read codes. "Setup" is performed automatically by presenting a readable code pattern.
- Code quality evaluation: displays the key quality parameters of the code to be read.
- Customized user interface can be easily generated with SIMATIC WinCC flexible/WinCC.
- Web-based user interface; can run on a variety of platforms meeting the following requirements: Internet browser (IE 6.0 or higher), JAVA-VM (MS, SUN).
- Password protected user interface with integrated access rights administration.
- Web-based user interface available for easy integration with an HMI device. The browser and JAVA VM requirements previously mentioned also apply in this case.
- 6 language versions (operator interface, manual and online help are each available in German, English, French, Spanish, Italian, and Chinese).

In addition, SIMATIC MV420 SR-P offers the following highlights:

- Autotrigger mode: Automatic detection of a code without an external trigger signal
  - Saving of sensor technology and cabling
  - Reduced potential for error as there are fewer components
  - Solution for applications where proximity switches and light barriers cannot be used
- Open web API interface for comfortable creation of customized applications and PC based camera remote control
- Multicode: reads multiple codes in one step within the same field of view.
  - ID-Genius: a high-performance code reading algorithm for poorly legible directly marked data matrix codes (DPM: Direct Part Marking)

#### Application

Key features of the SIMATIC MV420:

- Code reading
- Comparing the read result with a preset value
- Formatting of read results for further use

The range of application for the SIMATIC MV420 product family extends to practically all areas of industrial production. The possibilities for use range from identification of stationary parts to fast moving parts on conveyor systems. The high-performance integrated lighting allows for an extremely compact design. The unit is protected from environmental influences with a degree of protection IP67. The SIMATIC MV420 code readers are therefore suitable for all industrial applications, also for direct marking (Direct Part Marking - DPM). In addition to industrial production, thanks to its small size and flexibility, the SIMATIC MV420 code reader is also ideally suited to the packaging industry (e.g. F&B, pharmaceuticals and tobacco).

### Application (continued)

The MV420 code readers include all common communication interfaces, such as Ethernet or PROFINET, and can therefore be connected to a wide variety of systems. An integrated RS422 interface makes it possible to use all of the RFID communication modules, such those required for the PROFIBUS connection. In this case, the combination of code reader and RFID reader is also possible on one communication module.

The reading devices are particularly easy to use and commission despite the wide variety of options for use. Parameters are automatically configured for most applications. If reconfiguration is required, however, parameterization can be carried out without the need for pre-installed software via the integrated Web server using an Internet browser.

Due to the properties and functions described, the emphasis for MV420 is on the following sectors and applications:

- Automobile industry:
  - Needle markings on various drive components (DPM), e.g. cylinder heads, cylinder blocks, manifolds.
  - Laser markings on various power train components (DPM), e.g. camshafts, crankshafts, cylinder piston, connecting rods, gearbox components.
  - Laser markings on electronic components, printed circuit boards, or enclosures.
- Pharmaceutical industry, food industry (F&B), tobacco industry:
  - Print or laser markings on medicines (DPM, OCR).
  - Recording the contents of cartons (up to 150 codes).
  - Read portal by linking several cameras.
- Aerospace industry:
  - Needle or laser markings on gas turbine blades (DPM).
  - Needle or laser markings on jet engine components (DPM).
- Medical equipment:
  - Laser markings on heart pacemakers and other implants (DPM).
  - Laser markings on medical devices (DPM).
- Electronics:
  - Needle or laser markings on hard disk components.
  - Lasered or etched markings on hard disk components (DPM).
- Semiconductors:
  - Laser markings on rigid and flexible circuit boards (DPM).
  - Laser markings on enclosed semiconductor components, heat sinks or heat exchangers (DPM).

More information is available in the accompanying manual.

### Design

SIMATIC MV420 is a particularly compact code reading system. The device can be assembled from individual components or ordered as a ready-assembled unit. The MV420 is available in two versions:

- Basic model: SIMATIC MV420 SR-B
- Performance model: SIMATIC MV420 SR-P

For the individually configurable models the following individual components are available in addition to the basic units (body):

- Lenses
- Ring lights

The basic units include the protective barrel for the lens.

The preconfigured models include an integrated lens (6 mm, aperture 5.6) and a red ring light including protective barrel.

The following accessories are available for the connection and installation:

- Flexible mounting angle
- Power DIO RS232 cable (M16 connector on open end)
- M12 Ethernet cable (varying lengths)
- Ethernet cable (M12 to RJ45) for commissioning/lab operation; 2 m in length
- Special communication module cable for M16 connector (M16 to M12) for connecting to RFID communication modules (ASM). Can be expanded using standard communication module cables, if required.
- Plug-in power supply for demonstration and lab operation (for office environment only)
- CD with installation/operating instructions (supplied with unit)

Further information can be found in the supplied manual.

### Function

Key features of the SIMATIC MV420:

- Code reading (refer to "Overview" and "Range of application")
- Formatting of read results for further use and/or comparison
- Comparing the read result with a preset value
  - Specification of a comparison string via one of the serial ports (PROFINET (ASM and onboard), PROFIBUS (ASM), RS232)
  - Comparison of the formatted read results with the comparison string

The functions can be used individually or they can be combined.

# PROFINET/Industrial Ethernet

## SIMATIC Identification systems

### Code reading systems

#### SIMATIC MV420

#### Function (continued)

The SIMATIC MV420 reads the following codes:

- 1D codes (barcodes):
  - Int. 2/5 (no checksum)
  - Int. 2/5+CS (checksum included)
  - Code 128
  - Code 39 (no checksum)
  - Code 39+CS (checksum included)
  - EAN 13
  - EAN 8
  - UPC-A
  - UPC-E
  - GS1 Databar 14
  - GS1 Databar Stacked
  - GS1 Databar Limited
  - GS1 Databar Expanded
- 2D codes:
  - DMC
  - PDF417
  - QR
  - DotCode
  - Vericode

The SIMATIC MV420 reads the codes found on a wide variety of components and surfaces, including:

- Paper or plastic labels
- Plastic parts
- Circuit boards
- Metallic objects

The SIMATIC MV420 reads codes of a wide variety of marking types, such as:

- Printed
- Dot peened
- Laser
- Stamped
- Bored

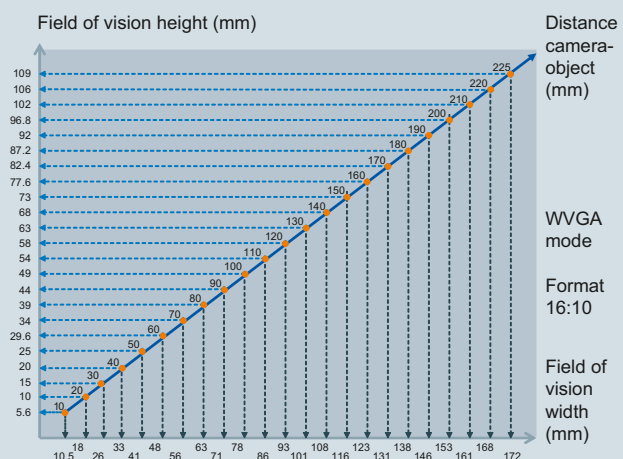
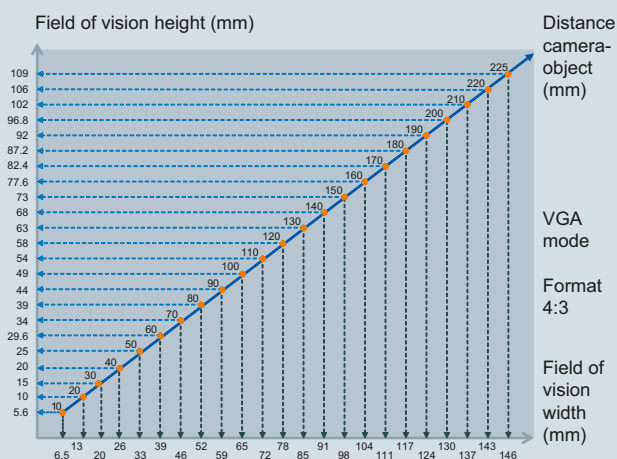

SIMATIC MV420 field of view dimensions for the 6 mm lens

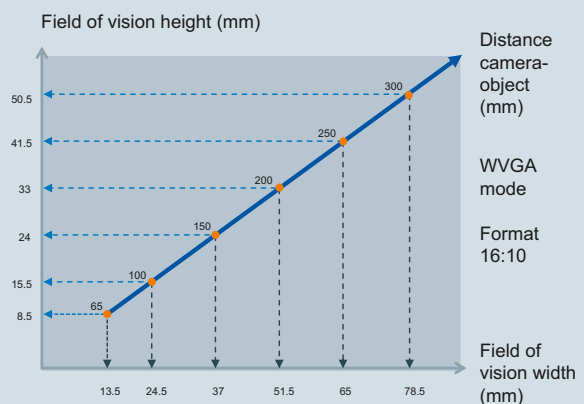
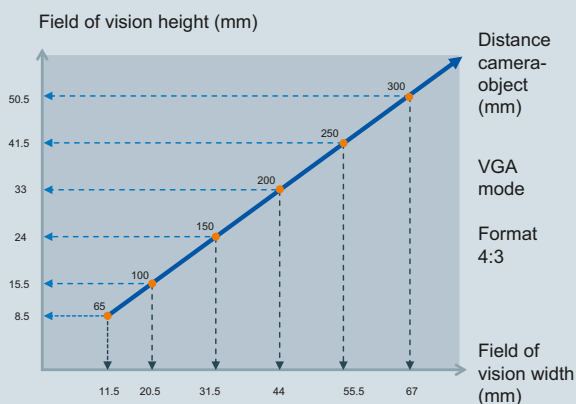

SIMATIC MV420 field of view dimensions for the 16 mm lens

Further information can be found in the supplied manual.

## Integration

Various onboard connection options and convenient function blocks are available for the integration into the automation level.

In the case of SIMATIC MV420, direct connection via PROFINET, Ethernet or RS232 is possible.

In addition, communication modules are available for connection to other bus systems or the shared interface with RFID readers.

For further details on the communication modules, see the section "Communication modules".

2

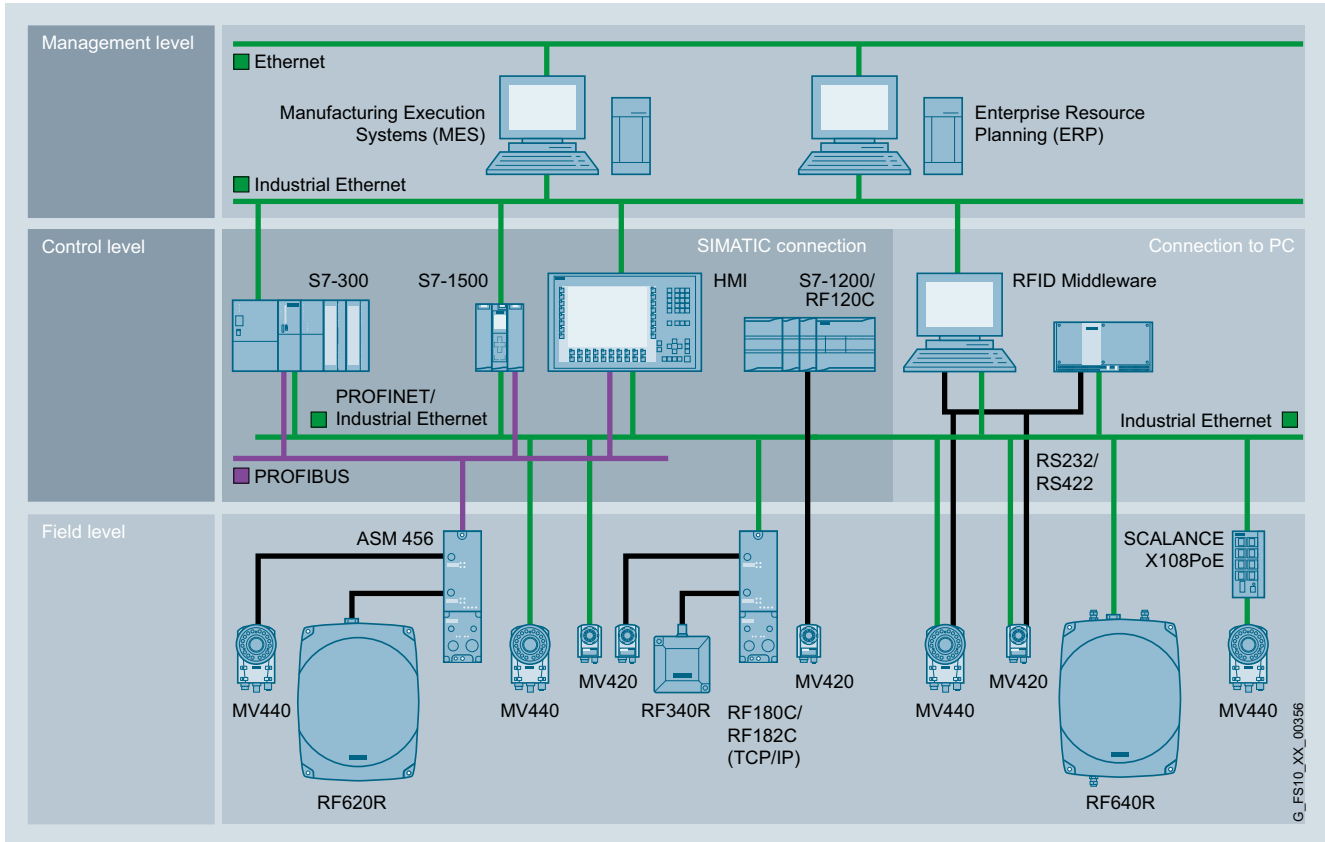

Integration of the SIMATIC MV420 in the automation environment

## Technical specifications

Article No.	6GF3420-0AA20	6GF3420-0AA40
<b>Product-type designation</b>	<b>MV420 SR-B code reader</b>	<b>MV420 SR-P code reader</b>
<b>Suitability for installation</b>	1D codes: Int. 2/5, Code 128, Code 39, EAN 13, EAN 8, UPC-A, UPC-E, GS1, 2D codes: DMC, PDF417 (without: Truncated, Micro and Macro), QR (without: Micro and Macro), Vericode	1D codes: Int. 2/5, Code 128, Code 39, EAN 13, EAN 8, UPC-A, UPC-E, GS1, 2D codes: DMC, PDF417 (without: Truncated, Micro and Macro), QR (without: Micro and Macro), Vericode
<b>Interfaces</b>		
Design of the electrical connection the Industrial Ethernet Interface	M12, d-coded	M12, d-coded
Design of the electrical connection of the PROFIBUS interface	-	-
Design of electrical connection of RS 422 interface	M16, 12-pin	M16, 12-pin
Design of electrical connection of RS 232 interface	M16, 12-pin	M16, 12-pin
Design of electrical connection for supply voltage	M16, 12-pin	M16, 12-pin
Design of electrical connection at the digital inputs/outputs	M16, 12-pin	M16, 12-pin
Number of digital inputs	1	1
Number of digital outputs	3	3
Design of digital inputs	One high-speed trigger input	One high-speed trigger input
Design of digital outputs	2 isolated outputs 50 mA, 1 high-speed trigger input for external lighting	2 isolated outputs 50 mA, 1 high-speed trigger input for external lighting

# PROFINET/Industrial Ethernet

## SIMATIC Identification systems

### Code reading systems

#### SIMATIC MV420

#### Technical specifications (continued)

Article No.	6GF3420-0AA20	6GF3420-0AA40
Product-type designation	MV420 SR-B code reader	MV420 SR-P code reader
<b>Optical data</b>		
Design of image sensor of camera	CMOS chip, VGA (640 x 480), WVGA (752 x 480)	CMOS chip, VGA (640 x 480), WVGA (752 x 480)
Type of image capture	Global shutter	Global shutter
Range	10 ... 400 mm	10 ... 400 mm
• note	Adjustable within the range	Adjustable within the range
Mounting type of lens	Fixed (M12)	Fixed (M12)
Nature of fluorescent material	Integrated lighting or external lighting according to accessories list	Integrated lighting or external lighting according to accessories list
Image acquisition frequency maximum	50 Hz	80 Hz
Code reading rate maximum	29 1/s	50 1/s
Type of focusing	Manual adjustment on the lens cover	Manual adjustment on the lens cover
<b>Supply voltage, current consumption, power loss</b>		
Supply voltage for DC rated value	24 V	24 V
Supply voltage		
• for DC	19.2 ... 28.8 V	19.2 ... 28.8 V
Consumed current At 24 V with DC		
• typical	0.17 A	0.17 A
• maximum	2 A	2 A
Stored energy time supply voltage failure minimum	0.01 s	0.01 s
<b>Mechanical data</b>		
Material	Die-cast aluminum	Die-cast aluminum
Color	petrol blue	petrol blue
<b>Permitted ambient conditions</b>		
Ambient temperature		
• during operating	0 ... 50 °C	0 ... 50 °C
• during storage	-30 ... +70 °C	-30 ... +70 °C
• during transport	-30 ... +70 °C	-30 ... +70 °C
Relative humidity at 25 °C without condensation during operating maximum	95 %	95 %
Protection class IP	IP67	IP67
Resistance against shock	According to IEC 60068-2	According to IEC 60068-2
Resistance against shock	150 m/s <sup>2</sup>	150 m/s <sup>2</sup>
Resistance against vibration	10 m/s <sup>2</sup>	10 m/s <sup>2</sup>
<b>Design, dimensions and weight</b>		
Width	52.5 mm	52.5 mm
Height	70.7 mm	70.7 mm
Depth	39.5 mm	39.5 mm
Net weight	0.25 kg	0.25 kg
Mounting type	2 x M4 screws	2 x M4 screws
<b>Product properties, functions, components general</b>		
Product feature silicon-free	Yes	Yes
Type of display	4 LEDs	4 LEDs
<b>Standards, specifications, approvals</b>		
Verification of suitability	CE, KCC, F&B suitable, UL	CE, KCC, F&B suitable, UL
<b>Accessories</b>		
Accessories	Mounting brackets, built-in ring lamps, M12 lenses	Mounting brackets, built-in ring lamps, M12 lenses



Ordering data	Article No.		Article No.
<b>SIMATIC MV420 SR-B</b> Pre-configured basic model: Including lens (6 mm, aperture 5.6) and a red ring light, without multicode and ID-Genius algorithm	<b>6GF3420-0AA20</b>		
<b>SIMATIC MV420 SR-P</b> Preconfigured performance model Including lens (6 mm, aperture 5.6) and a red ring light, for very fast read rates, with multicode and ID-Genius algorithm	<b>6GF3420-0AA40</b>		
<b>SIMATIC MV420 SR-B</b> Basic model body: Does not include multicode or the ID-Genius algorithm	<b>6GF3420-0AX20</b>		
<b>SIMATIC MV420 SR-P</b> Performance model body: For very high read rates; includes multicode reading and the ID-Genius algorithm	<b>6GF3420-0AX40</b>		
<b>Lens accessories</b>			
<b>Lens kit 6 mm</b> Lens 6 mm, aperture 5.6, including protective barrel	<b>6GF3420-0AC00-0LK0</b>		
<b>Lens kit 16 mm</b> Lens 16 mm, aperture 4, including protective barrel	<b>6GF3420-0AC00-1LK0</b>		
<b>Protective barrels for lenses</b>			
<b>Protective barrel replacement set</b> Contains: 2x protective barrel, 3x O-rings, 8x mounting screws, offset screwdriver	<b>6GF3420-0AC00-2AA0</b>		
<b>Built-in ring lights</b>			
<b>Built-in ring lamp, red</b>	<b>6GF3420-0AC00-1LT0</b>		
<b>Built-in ring lamp, white</b>	<b>6GF3420-0AC00-2LT0</b>		
<b>Built-in ring lamp, infrared</b>	<b>6GF3420-0AC00-3LT0</b>		
		<b>Cables</b>	
		<b>IE connecting cable M12-180/IE FC RJ45 plug-145 for commissioning, service and installation</b>	<b>6XV1871-5TH20</b>
		Pre-assembled IE FC TP trailing cable GP 2 x 2 (PROFINET type C) with M12 plug (D-coded) and IE FC RJ45 plug, IP65/IP67 degree of protection, length: 2 m	
		<b>IE Connecting Cable M12-180/M12-180</b>	
		Pre-assembled IE FC TP Trailing Cable GP 2 x 2 (PROFINET Type C) with two 4-pin M12 plugs (D-coded) up to 85 m, IP65/IP67 degree of protection. Lengths:	
		0.3 m	<b>6XV1870-8AE30</b>
		0.5 m	<b>6XV1870-8AE50</b>
		1 m	<b>6XV1870-8AH10</b>
		1.5 m	<b>6XV1870-8AH15</b>
		2 m	<b>6XV1870-8AH20</b>
		3 m	<b>6XV1870-8AH30</b>
		5 m	<b>6XV1870-8AH50</b>
		10 m	<b>6XV1870-8AN10</b>
		15 m	<b>6XV1870-8AN15</b>
		<b>Industrial Ethernet FastConnect plug connector, 2x2, 180° cable outlet</b>	<b>6GK1901-1BB10-2AA0</b>
		RJ45 plug connector (10/100 Mbit/s) with rugged metal enclosure and FastConnect technology, for Industrial Ethernet FastConnect cable 2x2. For further cables, see under "Passive network components".	
		<b>Cable 24 V power supply</b>	
		Power cable, M16 pre-assembled, push-pull. Various lengths:	
		1.5 m	<b>6GF3400-0BH15</b>
		2 m	<b>6GF3400-1BH20</b>
		<b>Power supply cable DIO-RS232</b>	
		Power IO RS232 cable, M16 assembled on one end, open on other end Various lengths:	
		10 m	<b>6GF3440-8BA2</b>
		30 m	<b>6GF3440-8BA4</b>
		<b>Adapter cable for RFID communication modules (ASM):</b>	<b>6GF3420-0AC00-2CB0</b>
		M16 connector (MV420) to M12 connector (communication module); length: 2 m; expandable to any length with standard communication module cables.	
		<b>Cable for communication module interface</b>	
		Standard communication module cable for installation, pre-assembled connecting cable for ASM 456, RF160C, RF170C, RF180C, and RF182C. Various lengths:	
		2 m	<b>6GT2891-4FH20</b>
		5 m	<b>6GT2891-4FH50</b>
		10 m	<b>6GT2891-4FN10</b>
		20 m	<b>6GT2891-4FN20</b>
		50 m	<b>6GT2891-4FN50</b>

**PROFINET/Industrial Ethernet**

SIMATIC Identification systems

Code reading systems

**SIMATIC MV420****Ordering data****Article No.****Article No.***Supports***Mounting bracket for SIMATIC MV420****6GF3420-0AC00-1AA0***Additional accessories***SCALANCE X204-2 Industrial Ethernet Switch**

Industrial Ethernet switches with integral SNMP access, Web diagnostics, copper cable diagnostics, and PROFINET diagnostics for configuring line, star and ring topologies; with integrated redundancy manager (Exception: SCALANCE X208PRO); including operating instructions, Industrial Ethernet network manual and configuration software on CD-ROM.

With electrical and optical ports for glass multimode FOC up to max. 5 km:  
Four 10/100 Mbit/s RJ45 ports and two fiber-optic cable ports

**6GK5204-2BB10-2AA3****Plug-in power supply (EU, US)**

For demo and lab operation (for office environment only)

**6GF3420-0AC00-1PS0****2**

## Overview



SIMATIC MV440 with built-in ring light and D65 protective barrel and with external ring light and D65 protective barrel

The SIMATIC MV440 readers have been specially developed for use in industrial production. The devices offer professional decoding algorithms for machine-readable codes and text recognition in one device for production and logistics. The SIMATIC MV440 device family is characterized by flexibility, reliability and ease of use.

The list of readable codes includes all common matrix and barcodes which, regardless of the printing technology and the carrier medium used, are recognized reliably. A special feature of this device is its ability to read data matrix code (DMC) which is frequently used, especially in production, for direct part marking (DPM) and places the highest demands on the readers.

The operating range of the devices extends from close range 70 mm to distant range 3000 mm. Due to the freely selectable lenses and lighting, the working range as well as implementation in applications with special requirements is almost unrestricted. Integration in industrial automation environments is via standardized fieldbus technology, but open interfaces are also supported.

## Benefits

get **Designed for Industry**

Highlights at a glance:

- Compact design with IP67 degree of protection.
- Very high reading reliability and read rates thanks to Siemens decoding algorithms.
- Different screen resolutions can be selected specific to the application.
- Flexible adaptation to the application by means of freely selectable lenses and lighting.
- Option of integrated or external high-performance lighting
- Variety of interfaces: Ethernet (PoE), PROFINET (PoE), RS232, DI/DO, communication module interface.
- Wide range of connector technology can be used by means of communication modules.
- Function block for PROFINET/PROFIBUS can be used with SIMATIC and SIMOTION.
- Web-based user interface can be used for parameter assignment and monitoring, without the need for installation.

Further important product characteristics are:

- No special knowledge required for reliable parameterization of reading features. Automatic "setup" by presenting a readable code pattern.
- Autotrigger mode: automatic detection of a code without an external trigger signal
  - Savings in sensor technology and cabling.
  - Reduced potential for error as there are fewer components.
  - Solution for applications in which proximity switches and light barriers cannot be used.
- Multicode: Reads multiple codes in one step within the same field of view.
- ID-Genius: a high-performance code reading algorithm for poorly legible directly marked data matrix codes (DPM: Direct Part Marking).
- Code quality evaluation: Displays the key quality parameters of the code to be read.
- Customized user interface can be generated with SIMATIC WinCC flexible/WinCC.
- Open web API interface for comfortable creation of customized applications and PC based camera remote control
- Web-based user interface; can run on a variety of platforms meeting the following requirements: Internet browser (IE 6.0 or higher), JAVA-VM (MS, SUN).
- Extensive diagnostics functions ensure operation at the maximum read rate.
- User/password-protected operator interface with integrated management of access rights.
- 6 language versions (operator interface, manual and online help are each available in English, German, French, Spanish, Italian and Chinese).

## PROFINET/Industrial Ethernet

### SIMATIC Identification systems

### Code reading systems

#### SIMATIC MV440

#### Application

The main functions of SIMATIC MV440 are:

- Reading 1D and 2D codes.
- Optical character recognition (OCR).
- Object detection.
- Verification (measuring the code quality).
- Comparing the read result with a preset value.
- Formatting of read results for further use.

The application range of the SIMATIC MV440 product family covers all sectors and areas of industrial production and logistics. The possible applications include the identification of stationary parts through to extremely fast moving parts on a conveyor belt. The powerful integrated lighting allows a very compact design. The device has IP67 degree of protection and is therefore equipped for harsh industrial environments.

Due to its particularly powerful lighting, lenses and sensor technology, MV440 specializes in direct part marking (DPM) applications. Due to the high picture quality, MV440 recommends itself for measuring the marking quality (verification) in the area of DPM.

Due to the properties and functions described, the emphasis for MV440 is on the following sectors and applications:

- Automobile industry:
  - Needle markings on various drive components (DPM), e.g. cylinder heads, cylinder blocks, manifolds.
  - Laser markings on various power train components (DPM), e.g. camshafts, crankshafts, cylinder piston, connecting rods, gearbox components.
  - Laser markings on electronic components, printed circuit boards, or enclosures.
- Pharmaceutical industry, food industry (F&B), tobacco industry:
  - Print or laser markings on medicines (DPM, OCR).
  - Recording the contents of cartons (up to 150 codes).
  - Read portal by linking several cameras.
- Aerospace industry:
  - Needle or laser markings on gas turbine blades (DPM).
  - Needle or laser markings on jet engine components (DPM).
- Medical equipment:
  - Laser markings on heart pacemakers and other implants (DPM).
  - Laser markings on medical devices (DPM).
- Electronics:
  - Needle or laser markings on hard disk components.
  - Lasered or etched markings on hard disk components (DPM).
- Semiconductors:
  - Laser markings on rigid and flexible circuit boards (DPM).
  - Laser markings on enclosed semiconductor components, heat sinks or heat exchangers (DPM).

Further information can be found in the supplied manual.

#### Design

SIMATIC MV440 is a compact, stationary code reading system. It consists of one basic unit, which can be configured with other individual components (lens, ring light and protective barrel). This allows the MV440 to be optimally adapted to the application conditions.

The SIMATIC MV440 basic unit is available in three versions that differ only with regard to the resolution of the CCD sensor and the associated recording speed mode and read rate. All three versions of the basic unit have identical functionality:

- SIMATIC MV440 SR  
640 pixels x 480 pixels, 50 full screens/s
- SIMATIC MV440 HR  
1024 pixels x 768 pixels, 20 full screens/s
- SIMATIC MV440 UR  
1600 pixels x 1200 pixels, 15 full screens/s

Using the following accessories, the SIMATIC MV440 basic units can be tailored to the requirements of the application. For a detailed listing of the individual accessories, please refer to the section entitled "Accessories":

- Lenses
- Protective barrel for lens
- Ring lights

The following accessories are available for the connection and installation:

- Flexible mounting plate
- Power DIO RS232 cable (M16 connector on open end)
- M12 Ethernet cable (varying lengths)
- Ethernet cable (M12 to RJ45) for commissioning/lab operation; 2 m in length
- Special communication module cable for M16 connector (M16 to M12) for connecting to RFID communication modules (ASM). Can be expanded using standard communication module cables if required.
- Plug-in power supply for demonstration and lab operation (for office environment only)
- CD with installation/operating instructions (supplied with unit)

**Design** (continued)

The following configurations are recommended for the close or distant ranges:

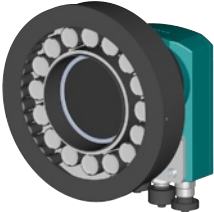
Configuration for close range	Lenses	Ring lights	Protective barrel for lens
	Mini lens 8.5 mm	The built-in ring light cannot be used (alternative: external mounting of a ring light).	D65 protective barrels for lenses can be used.
	Mini lens 6 mm		
	Mini lens 12 mm	Built-in ring lights can be used.	
	Mini lens 16 mm		
	Mini lens 25 mm		
	Mini lens 35 mm		
	Mini lens 50 mm		
Mini lens 75 mm	Use of the protective barrel extender required (on request).		
Configuration for distant range	Lenses	Ring lights	Protective barrel for lens
	Mini lens 6 mm	External ring lights can be used.	D65 protective barrels for lenses can be used.
	Mini lens 8.5 mm		
	Mini lens 12 mm		
	Mini lens 16 mm		
	Mini lens 25 mm		
	Mini lens 35 mm		
	Mini lens 50 mm		
Mini lens 75 mm			

**Function**

The main functions of SIMATIC MV440 are:

- **Reading** 1D and 2D codes
- **Verification** (required license "Veri-Genius")
- **Text recognition** (required license "Text-Genius")
- **Comparison** of the read result with a default value
- **Object recognition** (required license "Pat-Genius")
- **Formatting** the read result for forwarding

The functions can be used individually or they can be combined.

**Read**

The SIMATIC MV440 reads the following 1D and 2D codes (detailed information can be found in the manual):

- 1D codes (barcodes):
  - Int. 2/5 (with/without checksum)
  - Code 128
  - Code 93
  - Code 39 (with/without checksum)
  - Code 32
  - EAN 13
  - EAN 8
  - UPC-A
  - UPC-E
  - CodaBar
  - GS1 DataBar (Omnidirectional, Stacked, Limited, Expanded)
  - Pharmacode (0° and 180°)
  - Postnet
- 2D codes:
  - Data Matrix Code (ECC 0 - 200)
  - PDF417 (without: Truncated, Micro and Macro)
  - QR (without: Micro and Macro)
  - DotCode
  - Vericode (demo mode/VeriCode license)

**Verification**

**Code verification** is the term used for measuring the marking quality of 1D and 2D codes. This additional functionality is subject to license and is available for every SIMATIC MV440 by installing the "Veri-Genius license". The following verification methods are supported:

- ISO/IEC TR29158 (previously AIM DPM-1-2006)
- Siemens DPM
- ISO/IEC 15415
- AS9132 Rev. A (previously IAQG)
- ISO/IEC 15416 (previously ANSI X3.182-1990)

For more detailed information, refer to the chapter "Verification systems".

**Optical character recognition**

**Text recognition** is used to detect plain text (Optical Character Recognition: OCR). This additional functionality is subject to license and is available for every SIMATIC MV440 by installing the "Text-Genius license" or the "Text-Genius-Plus License". Text recognition with the "Text-Genius-Plus license" is able to recognize many fonts without training immediately after installation. Particularly suitable fonts are:

- OCR-A
- Semifont M13
- and similar fonts

With training ("Text-Genius-Plus license"), text recognition is able to recognize just about all fonts even with distortion and other influences resulting in varied representation. By contrast, this version requires training overhead but offers almost unlimited potential in expanding the characters to be recognized. For more detailed information, refer to the chapter "Text recognition".

## PROFINET/Industrial Ethernet

### SIMATIC Identification systems

### Code reading systems

#### SIMATIC MV440

#### Function (continued)

##### Object detection

**Object recognition** is used for finding and recognizing trained patterns in the picture. This functionality can be used in stand-alone mode or in combination with all the other named functions, and therefore has different application areas. Shape recognition offers the following functionality:

- Object recognition (classification) ·
- Position detection (position, orientation, scaling) ·
- Presence check (object recognition and position check with setpoint specification) ·
- Completeness check (multiple presence check with setpoint specification) ·
- Text recognition (based on the contour of any character or symbol. However, shape recognition can also be used in combination with text recognition, for example. In this case, the text recognition read area can track the current position of an object or label.

For more detailed information, refer to the chapter "Shape recognition".

##### Note:

In demo mode, the full functionality of the devices is available. Testing of a licensed function is therefore possible at any time. However, the output result is unusable, because one or more characters of the result will be randomly replaced by the character "?". Binary results are completely suppressed.

#### Integration

Various onboard connection options and convenient function blocks are available for the integration into the automation level.

In the case of SIMATIC MV440, for example, direct connection via PROFINET, Ethernet or RS232 is possible.

In addition, communication modules are available for connection to other bus systems or the shared interface with RFID readers.

Further information can be found in the section "Communication modules".

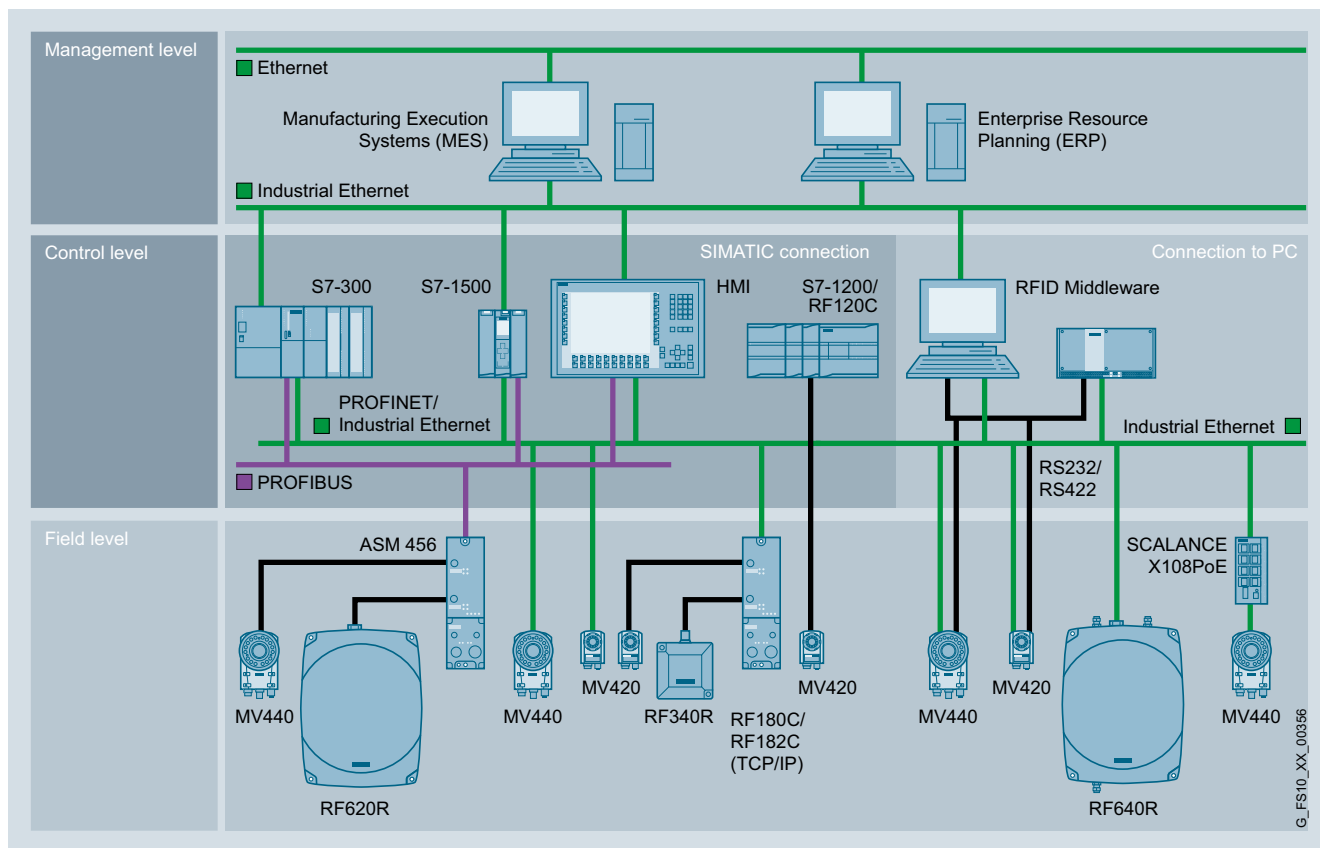

RFID integration into PROFINET/Ethernet network

#### Configuration tool for SIMATIC MV440

You will find a compact configuration tool here for assembling the SIMATIC MV440.

**Technical specifications**

Article No.	6GF3440-1CD10	6GF3440-1GE10	6GF3440-1LE10
Product-type designation	Code reader MV440 SR	MV440 HR code reader	Code reader MV440 UR
<b>Suitability for installation</b>	1D codes: Int. 2/5, Code 128, Code 93, Code 39, Code 32, EAN 13, EAN 8, UPC-A, UPC-E, GS1, Pharmacode, Postnet, 2D codes: DMC, PDF417 (without: Truncated, Micro and Macro), QR (without: Micro and Macro), Vericode, text recognition: OCR-A, Semifont M13, similar fonts, code verification: AIM DPM-1-2006, Siemens DPM, ISO/IEC 15415, AS9132 Rev. A, ISO/IEC 16416	1D codes: Int. 2/5, Code 128, Code 93, Code 39, Code 32, EAN 13, EAN 8, UPC-A, UPC-E, GS1, Pharmacode, Postnet, 2D codes: DMC, PDF417 (without: Truncated, Micro and Macro), QR (without: Micro and Macro), Vericode, text recognition: OCR-A, Semifont M13, similar fonts, code verification: AIM DPM-1-2006, Siemens DPM, ISO/IEC 15415, AS9132 Rev. A, ISO/IEC 16416	1D codes: Int. 2/5, Code 128, Code 93, Code 39, Code 32, EAN 13, EAN 8, UPC-A, UPC-E, GS1, Pharmacode, Postnet, 2D codes: DMC, PDF417 (without: Truncated, Micro and Macro), QR (without: Micro and Macro), Vericode, text recognition: OCR-A, Semifont M13, similar fonts, code verification: AIM DPM-1-2006, Siemens DPM, ISO/IEC 15415, AS9132 Rev. A, ISO/IEC 16416
<b>Interfaces</b>			
Design of the electrical connection the Industrial Ethernet Interface	M12, d-coded, PoE	M12, d-coded, PoE	M12, d-coded, PoE
Design of the electrical connection of the PROFIBUS interface	-	-	-
Design of electrical connection of RS 422 interface	M12, 8-pin	M12, 8-pin	M12, 8-pin
Design of electrical connection of RS 232 interface	M16, 12-pin	M16, 12-pin	M16, 12-pin
Design of electrical connection for supply voltage	M16, 12-pin	M16, 12-pin	M16, 12-pin
Design of electrical connection at the digital inputs/outputs	M16, 12-pin	M16, 12-pin	M16, 12-pin
Number of digital inputs	5	5	5
Number of digital outputs	5	5	5
Design of digital inputs	4 opto isolated inputs (NPN, PNP capability) optionally as output, one high-speed trigger input	4 opto isolated inputs (NPN, PNP capability) optionally as output, one high-speed trigger input	4 opto isolated inputs (NPN, PNP capability) optionally as output, one high-speed trigger input
Design of digital outputs	4 isolated outputs optionally as input, short-circuit-proof, max. 50 mA, 1 high-speed trigger input for external lighting	4 isolated outputs optionally as input, short-circuit-proof, max. 50 mA, 1 high-speed trigger input for external lighting	4 isolated outputs optionally as input, short-circuit-proof, max. 50 mA, 1 high-speed trigger input for external lighting
<b>Optical data</b>			
Design of image sensor of camera	CCD chip 1/3", 640 x 480	CCD chip 1/3", 1024 x 769	CCD chip 1/1.8", 1600 x 1200
Type of image capture	Global shutter with manual or automatic exposure time	Global shutter with manual or automatic exposure time	Global shutter with manual or automatic exposure time
Range	0.07 ... 3 m	0.07 ... 3 m	0.07 ... 3 m
Range note	Using C-mount lenses and lens accessories, the range can be exactly matched to the application	Using C-mount lenses and lens accessories, the range can be exactly matched to the application	Using C-mount lenses and lens accessories, the range can be exactly matched to the application
Mounting type of lens	C mount lens connection with Plexiglas lens protection, 65 mm diameter	C mount lens connection with Plexiglas lens protection, 65 mm diameter	C mount lens connection with Plexiglas lens protection, 65 mm diameter
Nature of fluorescent material	Integrated lighting or external lighting according to accessories list	Integrated lighting or external lighting according to accessories list	Integrated lighting or external lighting according to accessories list
Image acquisition frequency maximum	80 Hz	30 Hz	25 Hz
Code reading rate maximum	80 1/s	30 1/s	25 1/s
Type of focusing	Manual adjustment on the lens	Manual adjustment on the lens	Manual adjustment on the lens

# PROFINET/Industrial Ethernet

## SIMATIC Identification systems

### Code reading systems

#### SIMATIC MV440

#### Technical specifications (continued)

Article No.	6GF3440-1CD10	6GF3440-1GE10	6GF3440-1LE10
Product-type designation	Code reader MV440 SR	MV440 HR code reader	Code reader MV440 UR
<b>Supply voltage, current consumption, power loss</b>			
Supply voltage for DC rated value	24 V	24 V	24 V
Supply voltage			
• for DC	19.2 ... 28.8 V	19.2 ... 28.8 V	19.2 ... 28.8 V
Consumed current At 24 V with DC			
• typical	0.27 A	0.27 A	0.27 A
• maximum	2 A	2 A	2 A
Stored energy time supply voltage failure minimum	0.01 s	0.01 s	0.01 s
<b>Mechanical data</b>			
Material	Die-cast aluminum	Die-cast aluminum	Die-cast aluminum
Color	petrol blue	petrol blue	petrol blue
<b>Permitted ambient conditions</b>			
Ambient temperature			
• during operating	0 ... 50 °C	0 ... 50 °C	0 ... 50 °C
• during storage	-30 ... +70 °C	-30 ... +70 °C	-30 ... +70 °C
• during transport	-30 ... +70 °C	-30 ... +70 °C	-30 ... +70 °C
Relative humidity at 25 °C without condensation during operating maximum	95 %	95 %	95 %
Protection class IP	IP67	IP67	IP67
Resistance against shock	According to IEC 60068-2	According to IEC 60068-2	According to IEC 60068-2
Resistance against shock	100 m/s <sup>2</sup>	100 m/s <sup>2</sup>	100 m/s <sup>2</sup>
Resistance against vibration	10 m/s <sup>2</sup>	10 m/s <sup>2</sup>	10 m/s <sup>2</sup>
<b>Design, dimensions and weight</b>			
Width	68 mm	68 mm	68 mm
Height	122 mm	122 mm	122 mm
Depth	45 mm	45 mm	45 mm
Net weight	0.55 kg	0.55 kg	0.55 kg
Mounting type	4 x M4 screws	4 x M4 screws	4 x M4 screws
<b>Product properties, functions, components general</b>			
Product feature silicon-free	Yes	Yes	Yes
Type of display	5 LEDs	5 LEDs	5 LEDs
<b>Standards, specifications, approvals</b>			
Verification of suitability	CE, KCC, F&B suitable, UL	CE, KCC, F&B suitable, UL	CE, KCC, F&B suitable, UL
<b>Accessories</b>			
Accessories	Licenses (verification and text recognition), mounting brackets, built-in ring lights, external ring lights, C-mount lenses, protective barrels for lenses	Licenses (verification and text recognition), mounting brackets, built-in ring lights, external ring lights, C-mount lenses, protective barrels for lenses	Licenses (verification and text recognition), mounting brackets, built-in ring lights, external ring lights, C-mount lenses, protective barrels for lenses



Ordering data	Article No.		Article No.
<b>SIMATIC MV440 SR</b> For one- and two-dimensional codes. Optional: Text recognition (OCR), object detection and verification of barcodes and data matrix codes. Variable image field and distance. Resolution: 640 x 480 pixels. PoE; IP67 using protective barrel for lens and sealing caps, otherwise IP40; package comprises reader, CD and plastic protective barrel for lens.	6GF3440-1CD10	<i>Optional software modules</i> <b>Text recognition module "Text-Genius"</b> License for the module "Text-Genius", supplied on USB flash drive; executable on SIMATIC MV440 firmware V3.0 and higher (MV440 not included in the scope of supply). Description see Catalog ID 10.	6GF3400-0SL01
<b>SIMATIC MV440 HR</b> For one- and two-dimensional codes. Optional: Text recognition (OCR), object detection and verification of barcodes and data matrix codes. Variable image field and distance. Resolution: 1024 x 768 pixels. PoE; IP67 using protective barrel for lens and sealing caps, otherwise IP40; package comprises reader, CD and plastic protective barrel for lens.	6GF3440-1GE10	<b>Text recognition module "Text-Genius Plus"</b> License for the module "Text-Genius Plus", supplied on USB flash drive; executable on SIMATIC MV440 firmware V5.0 and higher (MV440 not included in the scope of supply). Description see Catalog ID 10.	6GF3400-1SL01
<b>SIMATIC MV440 UR</b> For one- and two-dimensional codes. Optional: Text recognition (OCR), object detection and verification of barcodes and data matrix codes. Variable image field and distance. Resolution: 1600 x 1200 pixels PoE; IP67 using protective barrel for lens and sealing caps, otherwise IP40; package comprises reader, CD and plastic protective barrel for lens.	6GF3440-1LE10	<b>Verification module "Veri-Genius"</b> License for the module "Veri-Genius", supplied on USB flash drive; executable on SIMATIC MV440 firmware V4.0 and higher (MV440 not included in the scope of supply). Description see Catalog ID 10.	6GF3400-0SL02
		<b>Shape recognition module "Pat-Genius"</b> License for the module "Pat-Genius", supplied on USB flash drive; executable on SIMATIC MV440 firmware V6.0 and higher (MV440 not included in the scope of supply). Description see Catalog ID 10.	6GF3400-0SL03

# PROFINET/Industrial Ethernet

## SIMATIC Identification systems

### Code reading systems

#### SIMATIC MV440

#### Ordering data

#### Article No.

#### Article No.

##### Accessories

##### Lens accessories

Mini lenses with fixed focal length, adjustable aperture and focus (see also "Lenses" section in Catalog ID 10).



- Mini lens 6 mm, 1: 1.4  
D = 32 mm, L = 37.5 mm
- Mini lens 8.5 mm, 1:1.5  
D = 42 mm, L = 47 mm,  
not suitable in combination with  
built-in ring lights
- Mini lens 12 mm, 1:1.4  
D = 29.5 mm, L = 35.7 mm
- Mini lens 16 mm, 1:1.4  
D = 29.5 mm, L = 37.2 mm
- Mini lens 25 mm, 1:1.4  
D = 29.5 mm, L = 38.9 mm
- Mini lens 35 mm, 1:1.6  
D = 29.5 mm, L = 41.4 mm
- Mini lens 50 mm, 1:2.8  
D = 29.5 mm, L = 38 mm
- Mini lens 75 mm, 1:2.8  
D = 34 mm, L = 63.6 mm,  
an extension piece is required  
when using the D65 lens  
protective barrel (on request)

6GF9001-1BB01

6GF9001-1BE01

6GF9001-1BL01

6GF9001-1BF01

6GF9001-1BG01

6GF9001-1BH01

6GF9001-1BJ01

6GF9001-1BK01

##### Accessories for utilizing mini lenses at close range

**Set of intermediate rings**  
with 0.5 mm, 1.0 mm, 5.0 mm,  
10.0 mm, 20.0 mm and 40 mm rings  
with 31 mm diameter C thread,  
to be screwed in between the lens  
and the camera body for image  
capture in the macro range.

6GF9001-1BU

**Set of intermediate rings**  
with 0.5 mm and 2 x 1.0 mm rings  
with 31 mm diameter C thread,  
to be screwed in between the lens  
and the camera body for image  
capture in the close range.

6GF9001-1BU01

##### Protective barrels for lenses

##### Protective barrel for lens D65

made of metal,  
for built-in ring lights,  
internal diameter 57 mm,  
max. lens length 57 mm,  
IP67 degree of protection.

- Glass front pane
- Plastic front pane

6GF3440-8AC11  
6GF3440-8AC21



##### Protective barrel for lens D65

made of plastic; to achieve IP67  
degree of protection;  
suitable for all variants of MV440  
and for use with built-in ring lights;  
max. internal diameter 55 mm,  
max. lens length 48 mm.

6GF3440-8AC12



##### Built-in ring lights

##### • Built-in ring light, red

Light source: LED red (630 nm)  
Flash duration 20  $\mu$ s to 10 ms,  
range of illumination 800 mm,  
mounting materials included,  
IP67 degree of protection when  
using protective barrel for lens.

6GF3440-8DA11

##### • Built-in white ring light

Light source: White LED  
(440 nm to 650 nm)  
Flash duration 20  $\mu$ s to 10 ms,  
range of illumination 800 mm,  
mounting materials included,  
IP67 degree of protection when  
using protective barrel for lens.

6GF3440-8DA21

##### • Built-in ring light, green

Light source: Green LED  
(500 nm to 570 nm)  
Flash duration 20  $\mu$ s to 10 ms,  
range of illumination 800 mm,  
mounting materials included,  
IP67 degree of protection when  
using protective barrel for lens.

6GF3440-8DA31

##### • Built-in ring lamp, infrared

Light source: Infrared LED  
(850 nm to 880 nm)  
Flash duration 20  $\mu$ s to 10 ms,  
range of illumination 800 mm,  
mounting materials included,  
IP67 degree of protection when  
using protective barrel for lens.

6GF3440-8DA41

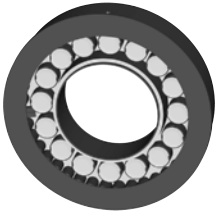
**Ordering data****Article No.****Article No.***External ring lights*

SIMATIC MV400 ring light

- **Ring light, metal, infrared, clear**  
light source LED infrared,  
light source 850 nm,  
light source 500 mm  
to 23 000 mm,  
suitable for D65 lens protective  
barrel,  
supply voltage: 24 V (18 V ... 30 V),  
dimensions B x H x T (mm):  
142 x 142 x 42.4,  
degree of protection IP67.
- **Ring light, metal, red, clear**  
light source LED infrared,  
light source 500 mm to 3 000 mm,  
suitable for D65 lens protective  
barrel,  
supply voltage: 24 V (18 V ... 30 V)  
dimensions W x H x D (mm)  
142 x 142 x 42.4,  
degree of protection IP67.

**6GF3400-OLT01-7BA1****6GF3400-OLT01-8DA1***Cables***IE connecting cable  
M12-180/IE FC RJ45 plug-145  
for commissioning, service and  
installation**

Pre-assembled IE FC TP trailing  
cable GP 2 x 2 (PROFINET type C)  
with M12 plug (D-coded) and  
IE FC RJ45 plug,  
IP65/IP67 degree of protection.  
Length: 2 m

**6XV1871-5TH20****IE M12-180/M12-180  
connecting cable**

Pre-assembled IE FC TP trailing  
cable GP 2 x 2 (PROFINET type C)  
with two 4-pin M12 connectors  
(D-coded) up to max. 85 m,  
IP65/IP67 degree of protection,  
RJ45 assembly possible  
with plug-in connector  
6GK1901-1BB10-2AA0  
(see below).  
length:

0.3 m  
0.5 m  
1 m  
1.5 m  
2 m  
3 m  
5 m  
10 m  
15 m

**6XV1870-8AE30****6XV1870-8AE50****6XV1870-8AH10****6XV1870-8AH15****6XV1870-8AH20****6XV1870-8AH30****6XV1870-8AH50****6XV1870-8AN10****6XV1870-8AN15***Cables (continued)***Industrial Ethernet  
FastConnect plug connector, 2x2,  
180° cable outlet**

RJ45 plug connector  
(10/100 Mbit/s)  
with rugged metal enclosure and  
FastConnect connection method.  
For Industrial Ethernet  
FastConnect cable 2x2.

For further cables, see under  
"Passive network components".

**6GK1901-1BB10-2AA0****Cable for communication module  
interface**

Communication module cable  
for connection to communication  
modules, e.g. ASM 456, RF160C,  
RF170C, RF180C, and RF182C.  
Plug-in cable pre-assembled  
for SIMATIC MV440.  
Available in the following lengths:

2 m  
5 m  
10 m  
20 m  
50 m

**6GT2891-4FH20****6GT2891-4FH50****6GT2891-4FN10****6GT2891-4FN20****6GT2891-4FN50****Cable 24 V power supply**

Power cable, M16 pre-assembled,  
push-pull.  
Various lengths:

1.5 m  
2 m

**6GF3400-0BH15****6GF3400-1BH20****Cable power supply DIO RS232**

Power IO RS232 cable, M16 pre-  
assembled at one end, other end  
unconnected.  
Various lengths:

Length 10 m  
Length 30 m

**6GF3440-8BA2****6GF3440-8BA4****Cable for external ring lights**

suitable for 6GF3400-OLT0-7DA1,  
6GF3400-OLT0-8DA1,  
M12, open end, 4-pole,  
not suitable for drag cables,  
cable connects external ring lights  
with the control cabinet  
(24 V, Gnd, strobe),  
length 10 m.

**6GF3440-8BC4****Adapter cable  
for external ring lights**

Suitable for 6GF3400-OLT0-7DA1,  
6GF3400-OLT0-8DA1  
enables direct connection of  
external ring lights to MV420 and  
MV440 when using the power sup-  
ply cable DIO-RS232 (see above)  
M16, 12-pole socket;  
M16, 12-pole connector;  
M12, 4-pole socket,  
length 25 cm.

**6GF3440-8BD1**

# PROFINET/Industrial Ethernet

## SIMATIC Identification systems

### Code reading systems

#### SIMATIC MV440

#### Ordering data

#### Article No.

#### Article No.

##### Mounting accessories

##### Reader mounting plate

Dimensions W x H x D (mm)  
80 x 80 x 60, plate thickness: 4 mm



6GF3440-8CA

##### Further accessories

##### SCALANCE X108PoE Industrial Ethernet Switch

Industrial Ethernet Switch  
for 10/100 Mbit/s,  
including operating instructions,  
Industrial Ethernet network manual  
and configuration software  
on CD-ROM;  
6 x 10/100 Mbit/s RJ45 ports,  
electrical 2 x 10/100 Mbit/s  
RJ45 PoE ports, electrical.

6GK5108-0PA00-2AA3

##### Mounting plate for external ring lights

Dimensions W x H x D (mm)  
96 x 76 x 46, plate thickness: 4 mm.



6GF3440-8CD01

##### Support system, tri-plate

Dimensions W x H x D (mm)  
80 x 80 x 60, plate thickness: 4 mm



6GF9002-7AD

2

**Overview**

3RW44 soft starter with PROFINET communication module

The solid-state SIRIUS 3RW44 soft starters are suitable for the torque-controlled soft starting and ramp-down as well as braking of three-phase asynchronous motors.

Optionally, SIRIUS 3RW44 soft starters can be upgraded with a PROFIBUS DP or PROFINET module. Thanks to their communication capability and their programmable control inputs and relay outputs the SIRIUS 3RW44 soft starters can be very easily and quickly integrated in higher-level controllers.

In addition to soft starting and soft ramp-down, the 3RW44 soft starters provide numerous functions for higher-level requirements. They cover a performance range up to 710 kW (at 400 V) in the inline circuit and up to 1 200 kW (at 400 V) in the inside-delta circuit.

The 3RW44 soft starters are characterized by a compact design for space-saving and clearly arranged control cabinet layouts. For optimized motor starting and stopping the innovative SIRIUS 3RW44 soft starters are an attractive alternative with considerable savings potential compared to applications with a frequency converter. The new torque control and adjustable current limiting enable the High-Feature soft starters to be used in nearly every conceivable task. They guarantee the reliable avoidance of sudden torque applications and current peaks during motor starting and stopping. This creates savings potential when calculating the size of the switchgear and when servicing the machinery installed. Be it for inline circuits or inside-delta circuits – the SIRIUS 3RW44 soft starter offers savings especially in terms of size and equipment costs.

The bypass contacts already integrated in the soft starter bypass the thyristors after a motor ramp-up is detected. This results in a further great reduction in the heat loss occurring during operation of the soft starter at rated value.

Combinations of various starting, operating and ramp-down possibilities ensure an optimum adaptation to the application-specific requirements. Operation and commissioning can be performed with the user-friendly keypad and a menu-prompted, multi-line graphic display with background lighting. The optimized motor ramp-up and ramp-down can be effected quickly, easily and reliably by means of just a few settings with a previously selected language. Four-key operation and plain-text displays for each menu option guarantee full clarity at every moment of the parameterization and operation.

**Applicable standards**

- IEC 60947-4-2
- UL/CSA

**Functionality**

Equipped with modern, ergonomic user prompting the 3RW44 soft starters can be commissioned quickly and easily using a keypad and a menu-prompted, multi-line graphic display with background lighting. The optimized motor ramp-up and ramp-down can be effected quickly, easily and reliably by means of just a few settings with a selectable language. Four-key operation and plain-text displays for each menu option guarantee full clarity at every moment of the parameterization and operation. During operation and when control voltage is applied, the display field continuously presents measured values and operating values as well as warnings and fault messages. An external display and operator module can be connected by means of a connection cable to the soft starter, thus enabling active indications and the like to be read directly from the control cabinet door.

The SIRIUS 3RW44 soft starters are equipped with optimum functionality. An integral bypass contact system reduces the power loss of the soft starter during operation. This reliably prevents heating of the switchgear environment. The SIRIUS 3RW44 soft starters have internal device overload protection. This prevents thermal overloading of the power section's thyristors, e.g. due to unacceptably high closing operations.

Wiring outlay for installing an additional motor overload relay is no longer needed as the SIRIUS 3RW44 soft starters perform this function too. In addition they offer adjustable trip classes and a thermistor motor protection function. As an option the thyristors can also be protected by SITOR semiconductor fuses from short-circuiting so that the soft starter is still functional after a short circuit (type of coordination "2"). And even inrush current peaks are reliably avoided thanks to adjustable current limiting.

In addition a creep speed function is available for positioning and setting jobs. With this function the motor can be controlled in both directions of rotation with reduced torque and an adjustable low speed.

On the other hand the SIRIUS 3RW44 soft starters offer a new, combined DC braking function for the fast stopping of driving loads.

## PROFINET/Industrial Ethernet Soft Starters

### 3RW44 soft starters for High-Feature applications

#### Overview (continued)

##### Highlights

- Soft starting with breakaway pulse, torque control or voltage ramp, adjustable torque or current limiting as well as any combination of these, depending on load type
- Integrated bypass contact system to minimize power loss
- Various setting options for the starting parameters such as starting torque, starting voltage, ramp-up and ramp-down time, and much more in three separate parameter sets
- Start-up detection
- Inside-delta circuit for savings in terms of size and equipment costs
- Various ramp-down modes selectable: free ramp-down, torque-controlled pump stop, combined DC braking
- Solid-state motor overload and intrinsic device protection
- Thermistor motor protection
- Keypad with a menu-prompted, multi-line graphic display with background lighting
- Interface for communication with the PC for more accurate setting of the parameters as well as for control and monitoring
- Simple integration into the motor feeder
- Simple mounting and commissioning
- Display of operating states and fault messages
- Connection to PROFIBUS and PROFINET with optional PROFIBUS DP or PROFINET module
- External display and operator module
- Mains voltages from 200 to 690 V, 50 to 60 Hz
- Can be used up to 60 °C (derating from 40 °C)

#### Ordering data

Version	Article No.
 <p><b>PROFINET communication module</b> For 3RW44 soft starter integration in the PROFINET network, suitable for devices with firmware version E12 or higher</p>	<b>3RW4900-0NC00</b>

#### More information

For more information, refer to Catalog IC 10, Chapter 6 "Switching Devices – Soft Starters and Solid-State Switching Devices", Industry Mall or Interactive Catalog CA 01.

### Soft starters – Soft Starter ES software

#### Overview

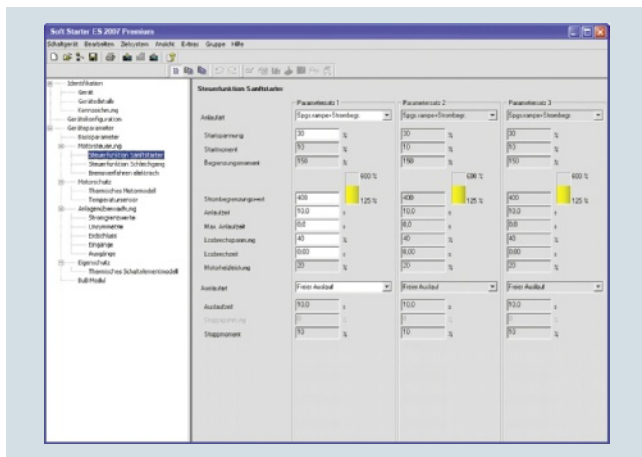

Easy and clearly arranged parameter setting of the 3RW44 soft starter with Soft Starter ES 2007

The Soft Starter ES software permits the quick and easy parameterization, monitoring and diagnostics of SIRIUS 3RW44 High-Feature soft starters for service purposes. The device parameters can be configured directly on the PC and transferred to the soft starter through a serial cable or an optional PROFIBUS/PROFINET interface.

#### More information

For more information, refer to Chapter 3 "PROFIBUS", Catalog IC 10, Chapter 14 "Parameterization, Configuration and Visualization with SIRIUS", Industry Mall or Interactive Catalog CA 01.

### Overview

The intelligent, highly flexible M200D PROFIBUS/PROFINET motor starters are the most functional motor starters of the SIRIUS motor starter family in the high degree of protection IP65 for PROFIBUS/PROFINET communication.

They start and protect motors and loads up to 5.5 kW. Direct-on-line and reversing starter variants are available in a mechanical version and also an electronic version (the latter with soft start function).

The particularly robust M200D PROFIBUS/PROFINET motor starters are characterized by numerous functions which can be flexibly parameterized. Their modular design comprises a motor starter module and a communication module.

The M200D PROFINET motor starters enable TIA-integrated parameterization through PROFINET from STEP 7 – in familiar, user-friendly manner with the same look-and-feel as PROFIBUS.

### Functionality

- Basic functionality see Chapter 4 "AS-Interface" → "M200D Motor Starters" → "General Data" → "Overview"
- Electronic version also with soft start function
- Robust and widely used M12 connection method for the digital inputs and outputs and the PROFIBUS/PROFINET bus connection
- All four digital inputs and two digital outputs also exist in the cyclic process image. This provides complete transparency of the process on the control level
- Full TIA integration: All digital inputs and outputs exist in the cyclic process image and are visible through the bus, providing maximum flexibility and excellent adaptability to the application
- Flexible assignment of the digital inputs and outputs with all available assignable input actions
- Extensive diagnostics concept using LEDs and through the bus with the TIA-compatible mechanisms
- Expanded diagnostics using data records
- Complete plant monitoring using statistics data record and current value monitoring by means of data records
- Parameterization through PROFIBUS/PROFINET bus with the help of data records from the user program
- Control of the motor starter using a command data record from the user program
- Removable modular control unit – quicker device replacement and therefore lower costs when device outages occur – since existing wiring is on the control unit and only one device needs to be replaced
- Parameterization in STEP 7 HW Config using Motor Starter ES (ordering option for start-up software)
- Start-up and diagnostics with the help of Motor Starter ES (ordering option for start-up software)
- Trace function through Motor Starter ES for optimized start-up and tracking of process and device values

Only with PROFINET:

- Just one bus system from the MES level to the devices – no routers
- More stations on the bus and possible configuration of flexible bus structures
- Automatic re-parameterization in case of device replacement thanks to proximity detection
- Wireless integration of plant segments in difficult environments using WLAN
- Easier expansion of the system thanks to a higher number of stations on the bus and elimination of terminating resistors



M200D motor starter modules for PROFIBUS/PROFINET (without communication module)



M200D communication module for PROFINET

### Mounting and installation

The M200D PROFINET/PROFINET motor starter is comprised of a communication module and a motor starter module. Only the motor starter module has to be replaced therefore when replacing devices. This saves time and money. The communication module remains as an active station on the bus and all other system components continue running. This prevents downtimes.

The integrated plug-in technology enables far lower wiring outlay: Connecting cables can be plugged directly onto the motor starter module. The PROFINET bus is connected cost-effectively using an M12 connection on the device. All versions have identical enclosure dimensions for easier system design and conversion.

## PROFINET/Industrial Ethernet

### Motor starters for use in the field, high degree of protection

#### M200D motor starters for PROFINET

##### Overview (continued)

###### Parameterization and configuration

All motor protection functions, limit values and reactions can be defined by parameterization.

The user has several user-friendly options for the parameterization. In addition to parameterization directly from STEP 7, which also permits automatic re-parameterization in case of device replacement, it is possible to use the user-friendly Motor Starter ES start-up software. By connecting a programming device directly to PROFIBUS/PROFINET and the Motor Starter ES start-up software, the devices can also be conveniently programmed from a central point through the bus. Also, parameters can be changed during operation from the user program using the data record mechanism so that the function of the motor starter is adapted to the process when required. With the help of a PC and the Motor Starter ES software it is also possible to perform the parameterization through the local point-to-point interface on-site.

Functions can be flexibly assigned to the digital inputs and outputs, adapting them to all possible conveyor applications. All digital inputs and outputs exist in the cyclic process image. All limit values for monitoring functions and their reactions are parameterizable and therefore adaptable to the application. Consistency with other products of the SIRIUS M200D motor starter range and with the frequency converter and ET 200pro I/O system is assured.

###### **Only with the M200D PROFINET motor starter**

Thanks to the integrated proximity detection, the device name does not need to be issued manually when a device is replaced. The name is issued automatically by the neighboring devices which note the "names" of the devices in their proximity. No additional start-up measures are required therefore when replacing a device.

The new motor starter generation is characterized by high functionality, maximum flexibility and the highest level of automation. The PROFINET is recommended in particular for expansive and highly automated system components because the possibility of monitoring devices and systems with data records (statistical data, measured values and device diagnostics) guarantees an in-depth view of the plant from the control room and therefore increases plant availability.

###### Operation

The motor starters record the actual current flow. Evaluating the current of the parameterizable solid-state overload protection increases the availability of the drives, as do reliable signals concerning the overshooting or undershooting of setpoint values.

###### Diagnostics and maintenance

Diagnostics is provided through numerous mechanisms – and can be used as the customer prefers.

The motor starter is TIA-diagnostics compatible, which means that when a fault is identified, a diagnostics alarm is distributed, which invokes the diagnostics-OB with a SIMATIC control. The fault can be evaluated as usual in the user program.

The M200D motor starter offers a large variety of diagnostics data through data records. Its functionality is without equal on the market. There are extensive options for reading out data from the motor starter for monitoring devices, systems or processes.

The motor starter is equipped internally with 3 logbooks for device faults, motor starter trips and events, which are issued with a time stamp. These logbooks can be read out of the motor starter at any time in the form of data records and provide the plant operator with plenty of information about the state of his plant and process which he can use to carry out improvements.

With the slave pointer and statistical data functions it is possible to read out, for example, the maximum internal current values or the number of motor starter connection operations for plant monitoring purposes. This allows deviations in the process to be monitored, but also optimum initial commissioning to take place. The user can draw conclusions about the actual load conditions of the devices in his process and on this basis can optimize his plant maintenance intervals.

The device diagnostics data record contains details of all the states of the motor starter, the device configuration and the communication status as a basis for central device and plant monitoring.

With installation and maintenance functions (I&M), information (I&M) on modules employed is stored in the motor starter on the one hand, and on the other, data (I&M), which can be specified by the user during configuration, such as location designations. I&M functions serve for troubleshooting faults and localizing changes in hardware at a plant or checking the system configuration. Reordering a device is particularly easy as the result.

The integrated maintenance timer can be used to implement preventative maintenance and avoid plant downtimes through look-ahead servicing.

Another new feature is the integrated TRACE function with the Motor Starter ES software. It can be used to record measured values as a function of time following a trigger event. This enables process flows to be recorded and their timing optimized.

Local control of a drive is possible using the ordering option with integrated manual operation. This is yet another new development which distinguishes the M200D PROFIBUS/PROFINET motor starter from the rest of the market and adds innovative technology, maximum availability and transparency to the system.



### Overview (continued)

#### **M200D PROFINET motor starters with PROFlenergy**

Increasing energy prices, far-reaching ecological problems worldwide and the threat of climate change make it necessary for you to be more conscious about your use of energy.

Active and effective energy management is possible with PROFlenergy.

PROFlenergy is a manufacturer-independent profile on PROFINET, which can be used by all manufacturers, has been standardized by PNO<sup>1)</sup> and supports the switching off of electrical devices during dead time and the measurement of energy flow.

#### Switching off during dead times

PROFlenergy supports the targeted switching-off of loads during dead time.

These can be planned short breaks of a few minutes (such as lunch breaks), longer periods of dead time (such as nights) or unplanned dead time. Energy is always saved when no power is required.

<sup>1)</sup> In the PNO (PROFIBUS Nutzerorganisation e. V. - PROFIBUS User Organization), manufacturers and users have come together to agree on the standardized communication technologies PROFIBUS and PROFINET.

#### Measuring and visualizing the energy flow as a basis of energy management

The objective of energy management is to optimize the use of energy in a company – from the purchasing of energy through to the consumption of energy – economically and ecologically.

Analyses of energy consumption over time can be used to control energy flows, avoid energy peaks, improve ratings and thus save costs.

PROFlenergy enables consumption data to be read off from the devices in a unified form. This is recorded during operation and can be displayed on a control panel, for example, or on higher-level energy management software packages. This ensures that these measured variables are in a uniform manufacturer-independent form and structure that is available to the user for further processing. These PROFlenergy functions thus provide the basis for active load and energy management during operation.

#### PROFlenergy in the M200D PROFINET motor starter

The M200D PROFINET motor starter supports "switching during dead time" and "current measurement values" of the motor current using PROFlenergy. These are called commands, because they trigger a reaction in the M200D motor starter.

**PROFINET/Industrial Ethernet**

Motor starters for use in the field, high degree of protection

**M200D motor starters for PROFINET****Overview** (continued)SIRIUS M200D  
PROFIBUSSIRIUS M200D  
PROFINET**Device functions (firmware features)****Slave on the bus**

Fieldbus	✓ PROFIBUS to M12	✓ PROFINET to M12
Adjustable number of stations	✓ 1 ... 125	✓ 1 ... 128 with CPU 315, CPU 317 1 ... 1256 with CPU 319

**Parameterization**

DIP switches	✓ For address setting and terminating resistor	--
Motor Starter ES	✓ Through bus, optical interface	
PROFIBUS/PROFINET data records	✓	
From STEP 7 / HW Config	✓	

**Diagnostics**

Acyclic through data records	✓
Diagnostic interrupt support	✓

**Process image**

Process image	✓ 2Byte PII/ 2Byte PIQ
---------------	------------------------

**Data channels**

Local optical interface (manual local)	✓
Through Motor Starter ES local interface	✓
Using Motor Starter ES through bus	✓

**Data records (acyclic)**

Parameterization	✓ Using DS 131 (DS = data record)	
Diagnostics	✓ Device-specific DS 92	
Measured values	✓ Measured values DS 94	
Statistics	✓ Statistical data DS 95	
Commands	✓ Using DS 93	
Slave pointer	✓ Slave pointer DS 96	
Logbook	✓ Using Motor Starter ES and data records: Device faults DS 72, tripping operations DS 73, events DS 75	
Device identification	✓ Using DS 100	
I&M data	✓ Using DS 231 ... 234	✓ Using data records 0xAFF0 ... 0xAFF3

**Inputs**

Number	✓ 4
• Of which in the process image	✓ 4
Input action	✓ Parameterizable: flexibly assignable action, see manual
Quick stop	✓ Parameterizable: latching, non-latching

✓ Function available

-- Function not available

### Overview (continued)



SIRIUS M200D  
PROFIBUS



SIRIUS M200D  
PROFINET

#### Device functions (firmware features)

##### Outputs

Number	✓ 2
• Of which in the process image	✓ 2
Output action	✓ Parameterizable: flexibly assignable action, see manual

##### Brake output

180 V DC / 230/400 V AC / none

✓

##### Motor protection

Overload protection	✓ Electronic, wide range 1:10
Short-circuit protection	✓
Full motor protection	✓
Temperature sensor	✓ Parameterizable using Motor Starter ES, data record: PTC or Thermoclick or deactivated

##### Device function

Repair switch	✓
Lower current limit monitoring	✓ Parameterizable
Upper current limit monitoring	✓ Parameterizable
Zero current detection	✓ Parameterizable: tripping, warning
Blocking current	✓ Parameterizable
Unbalance	✓ Parameterizable
Load type	✓ Parameterizable: 1 and 3-phase
Tripping class	✓ Parameterizable using Motor Starter ES, data record: CLASS 5, 10, 15, 20
Protection against voltage failure	✓ Parameterizable: activated/deactivated

##### Support for PROFlenergy profile

Switching during dead times	--	✓
Measured motor current values	--	✓

##### Soft starter control function

Soft start function	✓
Bypass function	✓ Only solid-state version

✓ Function available

-- Function not available

## PROFINET/Industrial Ethernet

Motor starters for use in the field, high degree of protection

M200D motor starters for PROFINET

Communication module, motor starter modules

### Benefits

#### M200D PROFINET motor starters with PROFlenergy

Both standards and laws are making environmental protection and energy management increasingly important, as is the desire to cut energy costs in production facilities and thus ensure a sustainable competitive advantage.

It is thus an objective within the industry to save energy and actively reduce CO<sub>2</sub> emissions. By the careful use of valuable resources, the manufacturer-independent PROFlenergy profile on PROFINET can make an active contribution to environmental protection.

### Application

The M200D PROFIBUS/PROFINET motor starters are particularly suitable for fully TIA-integrated, highly automated conveyor applications which meet all needs with regard to the monitoring of devices and systems and preventative maintenance.

Adaptability of the motor starter functions and maximum flexibility of the device enable a broad range of applications without any limits. The PROFINET-specific expansions are the best assurance of a future-proof investment.

### Ordering data



M200D PROFIBUS/PROFINET motor starter module (without communication module)

M200D PROFINET motor starter

Version

Article No.

#### M200D communication module for PROFINET

Communication module for PROFINET

3RK1335-0AS01-0AA0

M12 termination 7/8"

#### M200D PROFIBUS/PROFINET motor starter modules

Electromechanical starters (with integrated contactor)

3RK1395-6 S41- AD

Setting range for rated operational current / A

- 0.15 ... 2
- 1.5 ... 12

K  
L

Direct-on-line starters/reversing starters

- Direct-on-line starters
- Reversing starters
- Direct-on-line starters with manual local operation
- Reversing starters with manual local operation

0  
1  
2  
3

Brake actuation

- Without brake actuation
- Brake actuation (230/400 V AC)
- Brake actuation (180 V DC)

0  
3  
5

Electronic starters (with thyristors)

3RK1395-6 S71- AD

- 0.15 ... 2
- 1.5 ... 12

K  
L

Direct-on-line starters/reversing starters

- Direct-on-line starters
- Reversing starters
- Direct-on-line starters with manual local operation
- Reversing starters with manual local operation

0  
1  
2  
3

Brake actuation

- Without brake actuation
- Brake actuation (230/400 V AC)
- Brake actuation (180 V DC)

0  
3  
5

## Overview

### Note:

For accessories for all SIRIUS M200D motor starters (irrespective of the communication connection) see Chapter 4 "AS-Interface" => "SIRIUS M200D Motor Starters" => "Accessories"

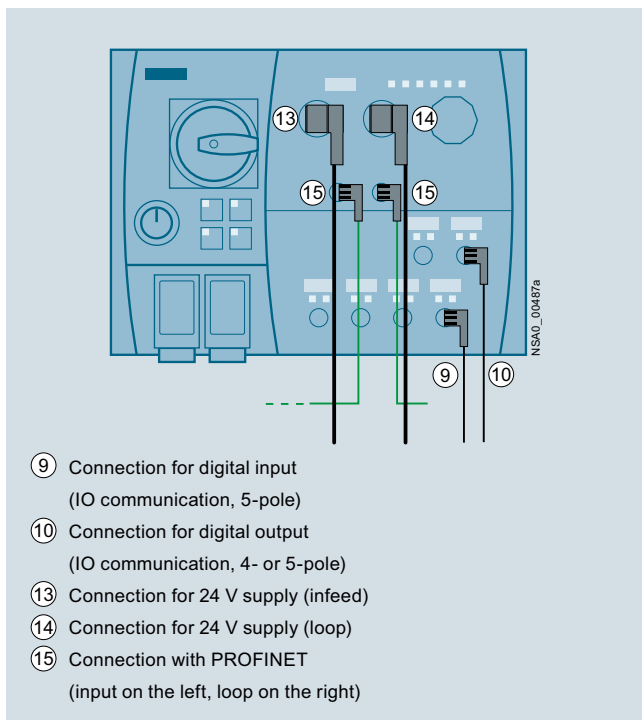

Communication connection using PROFINET and digital inputs and outputs

## PROFINET/Industrial Ethernet

Motor starters for use in the field, high degree of protection  
M200D motor starters for PROFINET

### Accessories

#### Overview (continued)

Version	Article No.	
<b>Motor control with PROFINET</b>		
 3RK1902-2H.   3RK1902-2N.	<p>⑮ <b>M12 plugs, angular</b> Screw fixing, 4-pole screw terminals, max. 0.75 mm<sup>2</sup>, angular, D-coded,</p> <ul style="list-style-type: none"> <li>• 4 male contacts</li> </ul> <p>⑮ <b>Control cables, assembled at one end</b> M12, screw fixing, angular, 4-pole, D coded,</p> <ul style="list-style-type: none"> <li>• 4 male contacts, 3 m</li> <li>• 4 male contacts, 5 m</li> <li>• 4 male contacts, 10 m</li> </ul> <p>⑮ <b>Control cables, assembled at both ends</b> M12, screw fixing, angular at both ends, 4-pole, D coded, male contacts at both ends</p> <ul style="list-style-type: none"> <li>• 3 m</li> <li>• 5 m</li> <li>• 10 m</li> </ul>	<p><b>3RK1902-2DA00</b></p> <p><b>3RK1902-2HB30</b> <b>3RK1902-2HB50</b> <b>3RK1902-2HC10</b></p> <p><b>3RK1902-2NB30</b> <b>3RK1902-2NB50</b> <b>3RK1902-2NC10</b></p>
<b>Further accessories</b>		
<b>PROFINET IE FC TP standard cable GP 2 x 2</b> sold by the meter	<b>6XV1840-2AH10</b>	
<b>PROFINET IE FC TP trailing cable 2 x 2</b> sold by the meter	<b>6XV1840-3AH10</b>	
<b>PROFINET IE FC TP trailing cable GP 2 x 2</b> sold by the meter	<b>6XV1870-2D</b>	
<b>PROFINET IE FC TP torsion cable 2 x 2</b> sold by the meter	<b>6XV1870-2F</b>	
<b>PROFINET IE FC TP marine cable, 4-core</b> sold by the meter	<b>6XV1840-4AH10</b>	
<b>Power cables</b> 5-core, 5 x 1.5 mm <sup>2</sup> , trailing, sold by the meter, minimum order quantity 20 m, maximum order quantity 1 000 m	<b>6XV1830-8AH10</b>	
Version	Article No.	
<b>Connection for 24 V power supply of the M200D PROFIBUS/PROFINET</b>		
 3RK1902-3DA00   3RK1902-3BA00   3RK1902-3G.   3RK1902-3N.   6ES7194-3JA00-0AA0	<p><b>Plugs</b> On M200D, 7/8" for screw fixing, angular, screw terminal, 1.5 mm<sup>2</sup></p> <ul style="list-style-type: none"> <li>• ⑮ 5 female contacts</li> <li>• ⑭ 5 male contacts</li> </ul> <p>⑬ <b>Supply lines, assembled at one end</b> 7/8" for screw fixing, angular, 1.5 mm<sup>2</sup></p> <ul style="list-style-type: none"> <li>• 5 female contacts, 3 m</li> <li>• 5 female contacts, 5 m</li> <li>• 5 female contacts, 10 m</li> </ul> <p>⑬ ⑭ <b>Supply lines, assembled at both ends</b> 7/8" for screw fixing, angular at both ends, 5-pole pin/socket, 1.5 mm<sup>2</sup></p> <ul style="list-style-type: none"> <li>• 3 m</li> <li>• 5 m</li> <li>• 10 m</li> </ul> <p><b>7/8" sealing caps</b> 1 pack = 10 units</p>	<p><b>3RK1902-3DA00</b></p> <p><b>3RK1902-3BA00</b></p> <p><b>3RK1902-3GB30</b> <b>3RK1902-3GB50</b> <b>3RK1902-3GC10</b></p> <p><b>3RK1902-3NB30</b> <b>3RK1902-3NB50</b> <b>3RK1902-3NC10</b></p> <p><b>6ES7194-3JA00-0AA0</b></p>

## Overview

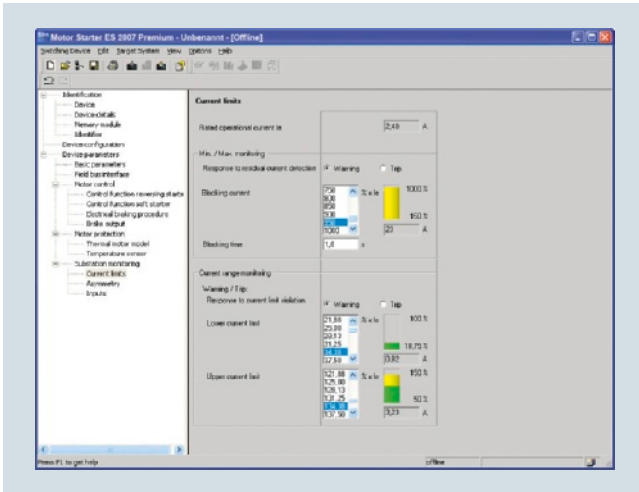

Motor Starter ES for parameterization, monitoring, diagnostics and testing of motor starters

Motor Starter ES is used for start-up, parameterization, diagnostics, documentation and the preventative maintenance of the motor starters in the SIMATIC ET 200S, ET 200pro, ECOFAST and M200D product families.

Interfacing is performed

- Through the local interface on the device
- With PROFIBUS DP V1 capable motor starters from any point in PROFIBUS or in PROFINET (applies to ET 200S DP V1/ET 200pro/ECOFAST/M200D)
- With PROFINET-capable motor starters from any point in PROFINET or in PROFIBUS (applies to ET 200S DP V1, ET 200pro/M200D)

Using Motor Starter ES, the communication-capable motor starters are easily parameterized during start-up, monitored during normal operation and successfully diagnosed for service purposes. Preventative maintenance is supported by a function for reading out diverse statistical data (e. g. operating hours, operating cycles, cut-off currents, etc.). The user is supported during these procedures with comprehensive Help functions and plain text displays.

Motor Starter ES can either be used as a stand-alone program or it can be integrated into STEP 7 via an Object Manager.

## More information

For more information, refer to Chapter 3 "PROFIBUS", Catalog IC 10, Chapter 14 "Parameterization, Configuration and Visualization with SIRIUS", Industry Mall or Interactive Catalog CA 01.

## SIRIUS motor starter block library for SIMATIC PCS 7

## Overview

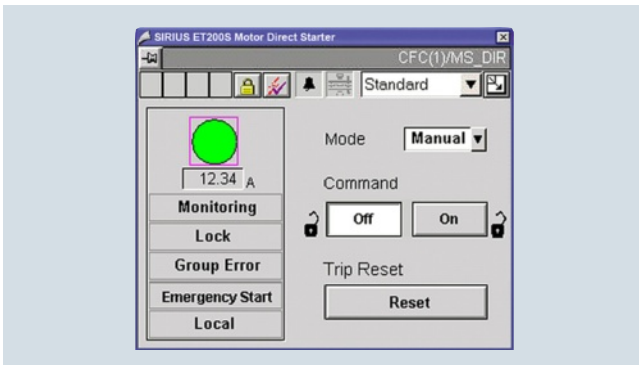

Faceplate of the motor block

With the SIRIUS motor starter PCS 7 block library, SIRIUS ET 200S and ET 200pro motor starters can be easily and simply integrated into the SIMATIC PCS 7 process control system. The SIRIUS motor starter PCS 7 block library contains the diagnostics and driver blocks corresponding to the SIMATIC PCS 7 diagnostics and driver concept as well as the elements (symbols and faceplates) required for operator control and process monitoring.

## More information

For more information, refer to Chapter 3 "PROFIBUS", Catalog IC 10, Chapter 14 "Parameterization, Configuration and Visualization with SIRIUS", Industry Mall or Interactive Catalog CA 01.

## PROFINET/Industrial Ethernet

### SITOP DC UPS 24 V DC uninterruptible power supplies

#### SITOP UPS1600

#### Overview



By combining one DC UPS module SITOP UPS1600 with at least one UPS1100 battery module and a SITOP power supply unit, longer power failures can be bridged without any interruption. The intelligent battery management automatically detects the UPS1100 energy storage unit, ensures optimized temperature-specific charging and continuous monitoring. The compact DC UPS modules have overload capability, for example, to supply the inrush current of industrial PCs. In stand-alone mode, they support starting from the battery.

The DC UPS communicates openly over a USB or Ethernet/PROFINET port. It is easily integrated into the PC or PLC environment over the two Ethernet/PROFINET ports. Total integration in TIA provides user-friendly engineering in the TIA Portal and is supported with ready-to-use function blocks for S7 user programs and WinCC faceplates for fast visualization.

SITOP UPS Manager supports easy monitoring and configuration in PC systems, e.g. shutdown of several PCs in accordance with the master-slave principle. The integrated web server supports remote monitoring of the DC UPS.

#### Benefits

- 24 V buffering for a few hours for the purpose of continuing processes
- Open communication over USB or two Ethernet/PROFINET ports
- High-performance DC UPS modules in space-saving, slim design
- High overload capability for mains and buffering operation
- Starting from the battery module supports stand-alone mode, e.g. for starting generators
- Easy configuration thanks to automatic detection of battery modules
- High reliability and availability due to monitoring of the operational readiness, battery feeder, aging and charging status
- Battery protecting charging due to temperature-specific charging characteristic
- Defined shutdown of several PCs or controllers on one UPS (versions with Ethernet/PROFINET)
- Remote monitoring via integrated web server (versions with Ethernet/PROFINET)
- Time-saving engineering in PC-based systems via SITOP UPS Manager (versions with USB or Ethernet/PROFINET)
- Full integration in TIA saves time and costs during the planning stage and in operation (versions with Ethernet/PROFINET)
- User-friendly engineering in the TIA Portal
- SIMATIC S7 function blocks for easy integration in STEP 7 user programs
- Fast integration in operator control and monitoring with WinCC faceplates

#### Application

The battery modules that can be connected in parallel bridge power failures for a few hours. This supports the continued operation of processes or parts of them. The function "Starting from the battery" means that the UPS1600 can also be used in stand-alone mode without connection to the supply.

Depending on the communication requirements between the DC UPS and the automation components to be protected against power failure, the version of UPS1600 can be selected accordingly.



### Application (continued)

#### Buffering of simple automation applications

In simple applications with mini PLCs (e.g. obstruction lights, stand-alone hydro-electric plants), 24 V buffering is performed by the UPS1600 without a communications interface. The status messages are transferred to the PLC via the digital outputs (isolated).

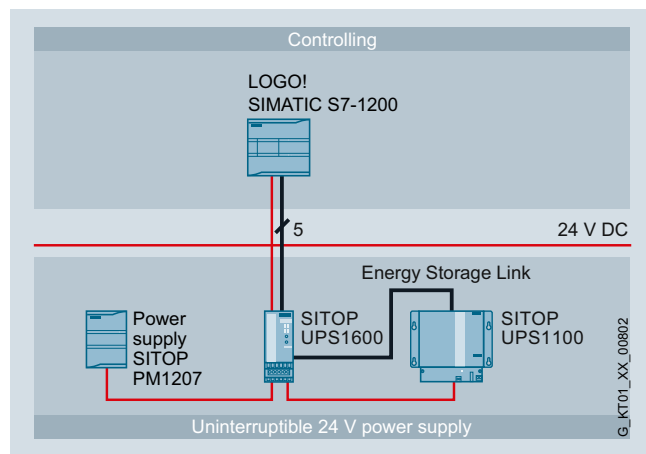

#### Buffering of applications with automation computer

The UPS1600 with a USB interface is used to buffer automation solutions that are controlled by an industrial PC. All operating and configuring data is communicated over the PC interface.

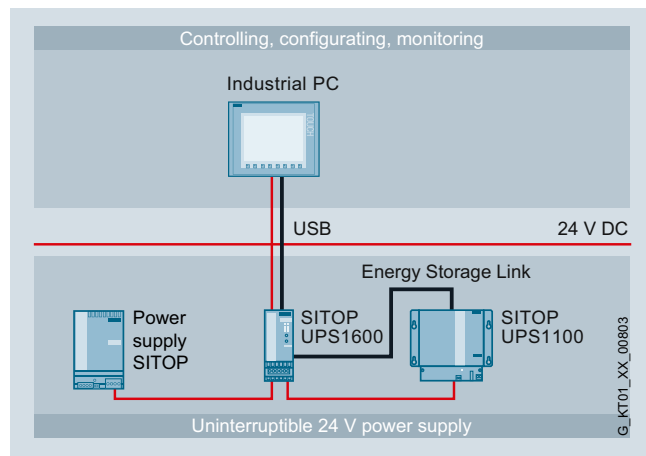

Communication over Ethernet/PROFINET offers the most comprehensive possibilities for diagnostics and system integration. The UPS1600 can be directly integrated into the LAN infrastructure over its two ports.

#### Buffering of applications with networked (Industrial Ethernet) automation computers

The UPS1600 with Industrial Ethernet interface protects complex PC-based applications from power failure. Configuration and monitoring is performed using the PC software SITOP UPS Manager. It also supports defined shutdown of several PCs in accordance with the master-slave principle.

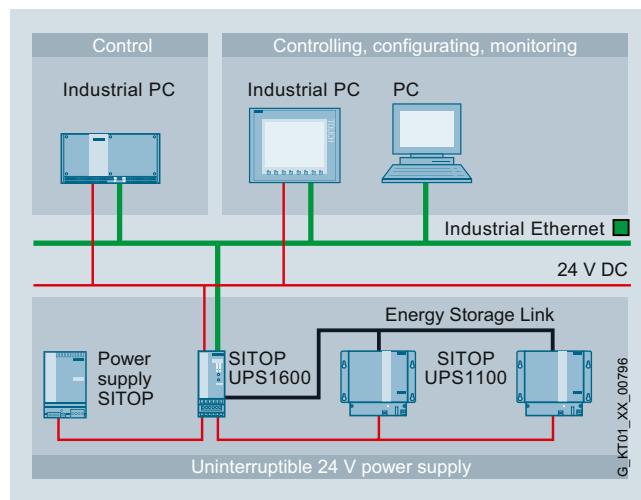

#### Buffering of applications with networked (PROFINET) automation components

For buffering sensitive plant components (e.g. a pumping station with telecontrol) or complete controller solutions (e.g. machine tools) that are integrated into a networked automation solution, the UPS1600 with PROFINET is the perfect choice. Total integration in TIA offers unique advantages for engineering and operation (e.g. diagnostics or visualization). For example, in buffer mode, several controllers can be brought to a defined independently of each other.

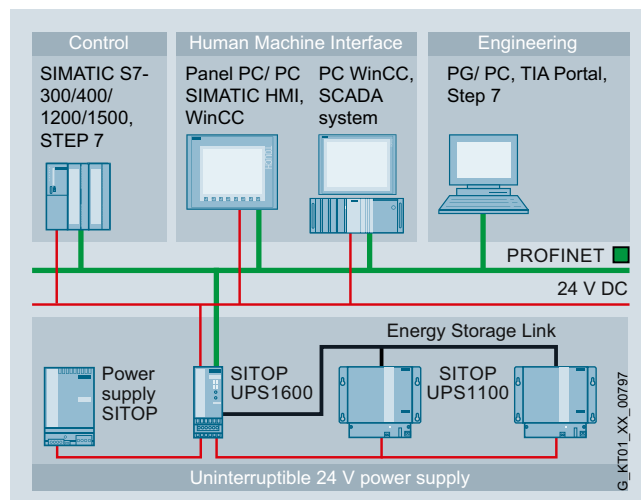

## PROFINET/Industrial Ethernet

### SITOP DC UPS 24 V DC uninterruptible power supplies

#### SITOP UPS1600

#### Design



- Compact DC UPS modules UPS1600 24 V/10 A, 20 A with digital inputs and outputs, optionally with USB interface or two Ethernet/PROFINET ports
- UPS1100 battery modules 1.2 Ah, 3.2 Ah, 7 Ah with lead rechargeable batteries of corrosion-resistant lead-calcium high-performance grid plates and glass fiber

#### Function

##### SITOP UPS1600 web server

The SITOP UPS1600 with Ethernet/PROFINET has an integrated web server that supports remote monitoring of the uninterruptible power supply.

Remote monitoring of

- Hardware configuration data
- Operating data of the UPS1600 basic unit and the connected UPS1100 battery module
- Alarm messages

Remote access via

- Firefox or Internet Explorer 9 (IE 8 with charging of SVG player)
- IP address
- Password



The password-protected web server supports viewing of the configuring and operating data.

##### SITOP UPS1600 software

Software tools support convenient integration of the SITOP UPS1600 in both PC-based and PLC-based systems. They make configuring and visualizing the DC UPS easier and the user benefits from the high performance of the SITOP UPS1600.

##### Software for open, PC-based automation systems

###### SITOP UPS Manager

Configuration and monitoring is performed easily using the free PC software SITOP UPS Manager. It enables the reactions of the PC to the operating states of the DC UPS to be freely selected and offers comprehensive diagnostic options:

- Configuration
  - Connection via USB or Ethernet
  - All the relevant parameters can be configured in UPS Manager and transferred to the UPS1600
  - Configuration of "non-coded" rechargeable batteries is possible
  - The reactions of the PC to the operating states of the UPS can be freely selected, e.g. termination of software applications
  - Support for reliable downloading of several PCs according to the master-slave principle
  - The configurations can be saved locally
  - Integrated OPC server (available soon)
  - Updating of the UPS1600 firmware is possible
  - Executable on Windows XP, Windows 7 and Windows 8 operating systems
- Monitoring
  - Readout and display of alarms, statuses and operating variables of the UPS1600 and the connected energy storage unit
  - Tracing of history in trend diagrams

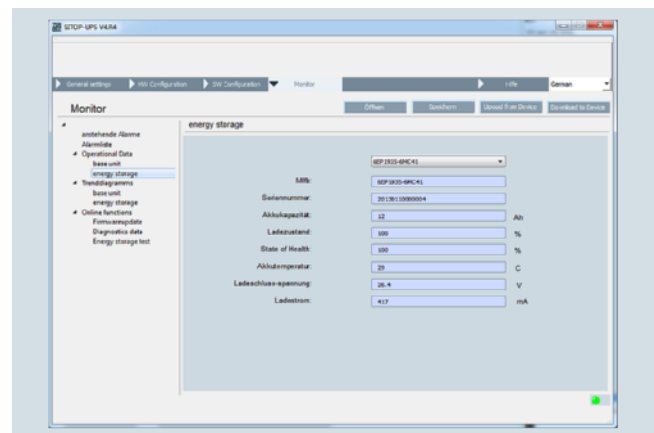

Monitor window for battery status in SITOP UPS Manager



Trend diagram for load current in SITOP UPS Manager

### Function (continued)

#### Software for TIA-based automation systems

For convenient integration of the DC UPS in the TIA environment, different software modules are available.

Engineering is simple via the TIA Portal. The data for UPS1600 is stored in the hardware catalog version V14 and higher. Special function blocks for SIMATIC S7-300, S7-400, S7-1200 and S7-1500 also support integration in the STEP 7 user program.

The comprehensive diagnostics data of the UPS1600 power supply can be visualized using prepared UPS faceplates for WinCC.

#### TIA Portal

- Convenient and fail-safe integration of SITOP UPS1600 in the PROFINET network by means of drag-and-drop
- Convenient configuration of SITOP UPS1600 basic units with Ethernet/PROFINET and the UPS1100 battery module simply by selecting from the TIA Portal hardware catalog
- Free download of HSP (Hardware Support Package) for TIA Portal version V12 SP1 available at <http://support.automation.siemens.com/WW/view/en/75854608>
- Free download of GSD file (generic station description) for STEP 7 V 5.5 available from <http://support.automation.siemens.com/WW/view/en/75854605>

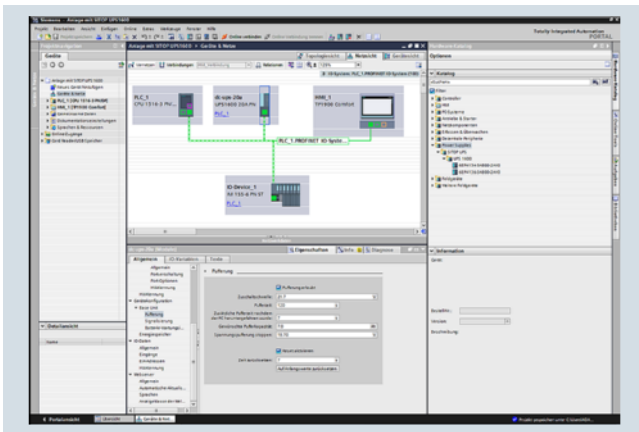

Establishing the PROFINET connection between the SITOP UPS1600 and the controller is easy and fail-safe in the TIA Portal

#### STEP 7 function blocks

Function blocks are available for STEP 7 user programs on SIMATIC S7-300/400/1200/1500. They allow further processing of the DC UPS operating data. Free download at: <http://support.automation.siemens.com/WW/view/en/75854608>

#### Faceplates for WinCC

Ready-to-use faceplates save programming time for visualization of the uninterruptible power supply. The faceplates show all relevant statuses and values of the DC UPS. They are available for the following systems:

- WinCC V7.2 + STEP 7 Professional 2010
- WinCC flexible 2008 SP3 + STEP 7 Professional 2010
- WinCC Comfort/Advanced/ Professional V11 SP2 + STEP 7 Professional V11 SP2
- WinCC V12 + STEP 7 V12

Free download at:

<http://support.automation.siemens.com/WW/view/en/75854608>



The pre-compiled WinCC faceplates show all the relevant UPS data in a clearly comprehensible display. An icon with color coding for the operating status is also available

## PROFINET/Industrial Ethernet

### SITOP DC UPS 24 V DC uninterruptible power supplies

#### SITOP UPS1600

#### Technical specifications

The table shows the maximum buffering times for the SITOP UPS1100 battery modules for different load currents: The SITOP Selection Tool offers detailed selection guidance according to criteria such as the required backup time, nominal current, peak current and battery connection threshold:

<http://www.siemens.com/sitop-selection-tool>

SITOP	UPS1100 24 V, 1.2 Ah (6EP4131-0GB00-0AY0)	UPS1100 24 V, 3.2 Ah (6EP4133-0GB00-0AY0)	UPS1100 24 V, 7 Ah (6EP4134-0GB00-0AY0)
<b>Load current</b>	<b>Buffer times</b>		
1 A	34.5 min	2.6 h	5.4 h
2 A	15.5 min	1 h	2.6 h
3 A	9 min	39.3 min	1.6 h
4 A	6.5 min	27.1 min	1.2 h
6 A	3.5 min	17.5 min	41 min
8 A	2 min	12.1 min	28.6 min
10 A	1 min	9 min	21.8 min
12 A	-	7 min	17.3 min
14 A	-	5 min	15.1 min
16 A	-	4 min	12.5 min
20 A	-	1 min	9.1 min

#### Important information for selecting the battery capacity:

Determination of the mains buffering times is based on the discharge period of new or non-aged, completely charged battery modules at a battery temperature not below +25 °C to the shutdown of the DC UPS.

Battery aging reduces the still available battery capacity up until the end of the service life to typically around 50% of the original capacity value when new (1.2 Ah/3.2 Ah/7 Ah, etc.) and the internal resistance increases. When the message "Battery charge > 85%" appears, only around 50% x 85% = approx. 43% of the originally available capacity can be assumed at the end of the battery service life.

At battery temperatures below +25 °C, the available capacity drops approximately by another 30% at +5 °C battery temperature, to approximately 70% of the approximately remaining 43%. There is then only around 30% of the original capacity available.

A significantly larger battery capacity must therefore be selected when configuring the plant: A drop to approx. 50% is compensated for by selecting 1 / approx. 0.5 = approx. double the battery capacity (required as per the table for the relevant load current and the relevant buffering time). Available capacity of approx. 43% is compensated for by selecting 1 / approx. 0.43 = approx. 2.33 times the battery capacity. Available capacity of approx. 30% is compensated for by selecting 1 / approx. 0.3 = approx. 3.33 times the battery capacity.

Battery temperature	Drop to approx. 50% of residual capacity	Recommendation: Replace (at 100% of residual capacity) all	Alternative recommendation
+20 °C	4 years	2 years	
+30 °C	2 years	1 year	
+40 °C	1 year	0.5 years	Install double capacity and replace (1 x per year)

In normal cases (installation in the coolest location in the control cabinet at approx. +30 °C), the battery should be replaced with single installed battery capacity in accordance with the selection table after 1 year of operation!

After a power failure, the battery module is disconnected from the loads at the end of the selected buffering time either automatically or electronically by opening the On/Off control circuit, and as soon as the 24 V input voltage is available again, it is

#### Recommendation:

Instead of installing double the battery capacity, regular battery replacement halfway through the expected service life (reduction of capacity to approx. 50%) can be more advisable for the following reasons: Capacity does not drop below 100% until the halfway point of the expected battery life (or slightly beyond). With regular replacement after this point, only the single battery capacity (instead of double capacity) must be installed due to aging (-> neutral in price with regard to battery module costs, but only requires half the space).

Replacing the battery after half its service life dispenses above all with the large scatter range of the residual capacity at the end of the service life, which is not accurately defined by battery manufacturers (after the full time, many batteries are above, but many are also below the average 50% residual capacity, that is to say, even if double the capacity is installed, the influence of aging at the end of service life is not reliably compensated for, rather only typically) -> When replacing after half the expected service life, the configured buffering time is maintained with considerably greater reliability.

In the case of batteries stored in cool conditions (not above +25 °C) and for not longer than approximately 4 months, the following service life can be assumed, strongly dependent on battery temperature:

quickly re-charged with the charge current of the relevant DC UPS module (with I-U charge characteristic: First constant current I for fast charging, and changeover to constant voltage U to maintain the charge when the battery is almost full).

### Technical specifications (continued)

DC UPS modules	SITOP UPS1600 24 V/ 10 A	SITOP UPS1600 24 V/ 20 A
<b>Article No.</b>	6EP4134-3AB00-0AY0 6EP4134-3AB00-1AY0 (with USB interface) 6EP4134-3AB00-2AY0 (with 2 Ethernet/ PROFINET interfaces)	6EP4136-3AB00-0AY0 6EP4136-3AB00-1AY0 (with USB interface) 6EP4136-3AB00-2AY0 (with 2 Ethernet/ PROFINET interfaces)
<b>Input data</b>		
Input voltage $V_{in \text{ rated}}$ / range <sup>1)</sup>	24 V DC/ 21 ... 29 V	24 V DC/ 21 ... 29 V
Connection threshold for buffering	22.5 V DC $\pm$ 3% (factory setting), adjustable: 21 V, 21.5 V, 22 V, 22.5 V, 23 V, 24 V, 25 V DC or via software.	22.5 V DC $\pm$ 3% (factory setting), adjustable: 21 V, 21.5 V, 22 V, 22.5 V, 23 V, 24 V, 25 V DC or via software.
Input current $I_{out \text{ rated}}$	Approx. 14 A for max. charging current (3 A)	Approx. 25 A for max. charging current (4 A)
<b>Mains buffering</b>		
Adjustable range using rotary coding switch	0.5 min, 1 min, 2 min, 5 min, 10 min, 20 min, max. buffering time or via software	0.5 min, 1 min, 2 min, 5 min, 10 min, 20 min, max. buffering time or via software
Behavior on restoration of input voltage after buffering time	Interruption of $U_{out}$ for 5 s for the automatic restart of PCs or optionally no interruption	Interruption of $U_{out}$ for 5 s for the automatic restart of PCs or optionally no interruption
On/off control circuit (via external isolated NO contact)	by opening the circuit the buffer mode is terminated	by opening the circuit the buffer mode is terminated
Starting from battery with input voltage missing (over external isolated NO contact)	by closing the circuit the buffer mode is started	by closing the circuit the buffer mode is started
<b>Energy storage units</b>		
Connectable batteries	– coded Siemens types SITOP UPS1100 (max. 6 via Energy Storage Link) – non-coded Siemens types 6EP1935-6M... – other manufacturers	– coded Siemens types SITOP UPS1100 (max. 6 via Energy Storage Link) – non-coded Siemens types 6EP1935-6M... – other manufacturers
<b>Output data</b>		
Output voltage in normal operation	Input voltage $V_{in}$ minus approx. 0.2 V	Input voltage $V_{in}$ minus approx. 0.2 V
Output voltage in buffering mode	27 V DC (no load); 24 V (50% battery rated current); 22 V (100% battery rated current); 18.5 V (exhaustive discharge protection)	27 V DC (no load); 24 V (50% battery rated current); 22 V (100% battery rated current); 18.5 V (exhaustive discharge protection)
Output +Bat/-Bat in normal operation	I-U charging characteristic (first rapid charging current, then charge retention)	I-U charging characteristic (first rapid charging current, then charge retention)
End-of-charge voltage	Automatic temperature-specific setting with SITOP UPS1100 battery modules	Automatic temperature-specific setting with SITOP UPS1100 battery modules
Rated output current	<b>0 ... 10 A</b>	<b>0 ... 20 A</b>
• Power boost for 30 ms	30 A	60 A
• Extra power for 5 s/min	15 A	30 A
Charging current	Max. 3 A automatic adjustment with UPS1100; otherwise selectable 0.3 A, 0.8 A, 3 A	Max. 4 A automatic adjustment with UPS1100; otherwise selectable 0.8 A, 1.75 A, 4 A
Efficiency for normal operation and charged battery	>97%	>98%
<b>Protection and monitoring</b>		
Reverse polarity protection	against input voltage $U_{in}$ and against batteries	against input voltage $U_{in}$ and against batteries
Overload / short-circuit protection	Yes, restart in normal operation	Yes, restart in normal operation
<b>Signaling</b>		
Normal operation/buffer mode	LED 1 (OK/BAT) green/yellow and isolated changeover switch 1	LED 1 (OK/BAT) green/yellow and isolated changeover switch 1
Charging status (over 85% charged)	LED 2 (BAT>85%) green and isolated changeover switch 3	LED 2 (BAT>85%) green and isolated changeover switch 3
Alarm (not ready for buffering)	LED 3 (Alarm) red and isolated changeover switch 2	LED 3 (Alarm) red and isolated changeover switch 2
Battery status	LED 4 (BAT.FAULT) red and isolated changeover switch 2: Battery defective, yellow: selected buffering time not assured, yellow flashing: Overtemperature	LED 4 (BAT.FAULT) red and isolated changeover switch 2: Battery defective, yellow: selected buffering time not assured, yellow flashing: Overtemperature
PROFINET interface	LED 5 (SF) green and LED 6 (RUN)	LED 5 (SF) green and LED 6 (RUN)
Ethernet	LED 7 (P1) green/yellow and LED 8 (P2) green/yellow, link and activity	LED 7 (P1) green/yellow and LED 8 (P2) green/yellow, link and activity

# PROFINET/Industrial Ethernet

## SITOP DC UPS 24 V DC uninterruptible power supplies

### SITOP UPS1600

#### Ordering data Article No. Article No. (continued)

DC UPS modules	SITOP UPS1600 24 V/ 10 A	SITOP UPS1600 24 V/ 20 A
<b>General data</b>		
Radio interference level (EN 55022) / noise immunity	Class B / Noise immunity to EN 61000-6-2	Class B / Noise immunity to EN 61000-6-2
Safety class	Class III (ext. circuit and power supply unit: SELV in accordance with EN 60950 required)	Class III (ext. circuit and power supply unit: SELV in accordance with EN 60950 required)
Degree of protection (EN 60529)	IP20	IP20
Ambient temperature during operation with natural convection	-25 ... +70 °C (derating from 60 °C)	-25 ... +70 °C (derating from 60 °C)
Transport/storage temperature	-40 ... +85 °C	-40 ... +85 °C
Dimensions (W x H x D) in mm	50 x 125 x 125	50 x 125 x 125
Weight, approx.	0.4 kg without interface, 0.42 kg with USB, 0.45 kg with Ethernet/PROFINET interfaces	0.4 kg without interface, 0.42 kg with USB, 0.45 kg with Ethernet/PROFINET interfaces
Installation	Snaps onto DIN rail EN 50022-35x15/7.5	Snaps onto DIN rail EN 50022-35x15/7.5
Approvals	CE, cULus, C-Tick; KCC; GL, ABS, ATEX	CE, cULus, C-Tick; KCC; GL, ABS, ATEX

1) All SITOP 24 V DC power supplies are permissible without restriction

Product	SITOP UPS1100 battery module 24 V, 1.2 Ah	SITOP UPS1100 battery module 24 V, 3.2 Ah	SITOP UPS1100 battery module 24 V, 7 Ah
<b>For SITOP UPS1600</b>	<b>10 A</b>	<b>10 A</b>	<b>10 A and 20 A</b>
<b>Article No.</b>	<b>6EP4131-0GB00-0AY0</b>	<b>6EP4133-0GB00-0AY0</b>	<b>6EP4134-0GB00-0AY0</b>
Recommended end of charge voltage (set automatically by SITOP UPS1600):	26.4 ... 27.3 V DC (> +20 °C), 27.3 ... 29.0 V DC (< +20 °C)	26.4 ... 27.3 V DC (> +20 °C), 27.3 ... 29.0 V DC (< +20 °C)	26.4 ... 27.3 V DC (> +20 °C), 27.3 ... 29.0 V DC (< +20 °C)
Charging current	max. 0.3 A	max. 0.8 A	max. 1.75 A
Rated output voltage	24 V DC, 22 ... 27.0 V DC (no load)	24 V DC, 22 ... 27.0 V DC (no load)	24 V DC, 22 ... 27.0 V DC (no load)
Rated output current	10 A	15 A	30 A
Integral battery fuse	15 A/32 V	15 A/32 V	30 A/32 V
Signaling	LED green: Battery OK, flashing green: Error or warning, OFF: No communication	LED green: Battery OK, flashing green: Error or warning, OFF: No communication	LED green: Battery OK, flashing green: Error or warning, OFF: No communication
Degree of protection (EN 60529)	IP00	IP00	IP00
Ambient temperature	0 ... +40 °C	0 ... +40 °C	0 ... +40 °C
Transport/storage temperature	-40 ... +85 °C	-40 ... +85 °C	-40 ... +85 °C
Service life (when capacity falls to 50% of original capacity), depending on battery temperature, approx.	+20 °C: 4 years, +30 °C: 2 years, +40 °C: 1 year, +50 °C: 0.5 years	+20 °C: 4 years, +30 °C: 2 years, +40 °C: 1 year, +50 °C: 0.5 years	+20 °C: 4 years, +30 °C: 2 years, +40 °C: 1 year, +50 °C: 0.5 years
Installation	DIN rail or wall mounting	DIN rail or wall mounting	Wall mounting
Dimensions (W x H x D) in mm	89 x 130 x 107	190 x 169 x 79	186 x 186 x 110
Weight, approx.	1.9 kg	3.8 kg	6.1 kg
Certification	CE, cURus-recognized, C-Tick; KCC; GL, ABS, ATEX	CE, cURus-recognized, C-Tick; KCC; GL, ABS, ATEX	CE, cURus-recognized, C-Tick; KCC; GL, ABS, ATEX

#### Ordering data

**SITOP UPS1600 24 V/ 10 A**  
 • With USB interface  
 • With 2 Ethernet/ Profinet interfaces

**Article No.**  
**6EP4134-3AB00-0AY0**  
**6EP4134-3AB00-1AY0**  
**6EP4134-3AB00-2AY0**

**SITOP UPS1600 24 V/ 20 A**  
 • With USB interface  
 • With 2 Ethernet/ Profinet interfaces

**Article No.**  
**6EP4136-3AB00-0AY0**  
**6EP4136-3AB00-1AY0**  
**6EP4136-3AB00-2AY0**

**SITOP UPS1100 battery module 24 V, 1.2 Ah**

**Article No.**  
**6EP4131-0GB00-0AY0**

For SITOP UPS1600 10 A

**SITOP UPS1100 battery module 24 V, 3.2 Ah**

**Article No.**  
**6EP4133-0GB00-0AY0**

For SITOP UPS1600 10 A

**SITOP UPS1100 battery module 24 V, 7 Ah**

**Article No.**  
**6EP4134-0GB00-0AY0**

For SITOP UPS1600 10 A and 20 A

**SITOP UPS1600 starter kit**

**Article No.**  
**6EP4134-3AB00-2AP0**

Consisting of:  
 SITOP UPS1600 DC UPS, 24 V DC/10 A with Ethernet/PROFINET interface;  
 SITOP UPS1100 battery module 3.2 Ah;  
 Industrial Ethernet cable;  
 software tools and documentation on CD

### Overview

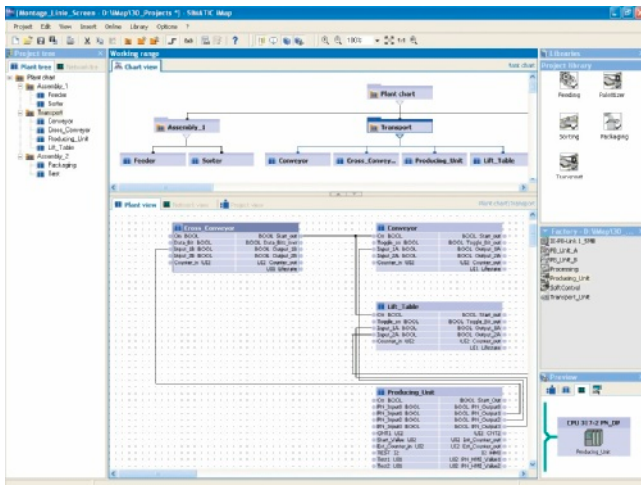

- Component-based software tool for configuring the communication in distributed automation solutions
- For easy graphical configuration of the communication between subsystems and machine-to-machine communication in the production line
- Based on the PROFINET standard
- Open for PROFINET devices from various manufacturers on Industrial Ethernet
- Runs under Windows XP Professional and Windows 7 Ultimate/Professional

### Benefits

The clear advantage of SIMATIC iMap over programmed communication lies in the simple programming of the communication (graphically using lines interconnecting the technology interfaces of the devices).

### Technical specifications

Engineering tool	SIMATIC iMap
Current version	V3.0
Software class	A
<b>Application areas</b>	
Keyword	SIMATIC iMap is an engineering tool for configuring communication between automation and field devices in distributed automation solutions.
Marketing message	"Time and cost savings in modular machine and plant construction with Component based Automation." "Modularization and machine-to-machine communication along the production line."
Advantages	<ul style="list-style-type: none"> <li>• Open component-based engineering tool to the PROFINET standard.</li> <li>• Simple communication between intelligent automation and field devices on PROFIBUS DP and on Ethernet.</li> <li>• Graphical configuration of communication on PROFIBUS DP and on Ethernet</li> <li>• Extremely high reusability of software components (technology modules)</li> <li>• Graphical structuring of the plant using "chart-in-chart" function</li> <li>• Convenient navigation through the project tree</li> <li>• Easy creation and structuring of technology libraries</li> <li>• PROFIBUS and Ethernet in the overview of the network view</li> <li>• Fast start-up thanks to downloading and testing directly on Ethernet (also of PROFIBUS slaves)</li> <li>• Online display of values of the technology modules on the interfaces and in the variable table</li> <li>• Diagnosis of communication in the diagnostics window</li> </ul>
Sectors	<ul style="list-style-type: none"> <li>• Automotive industry (especially in assembly, conveyor systems and in the paint shop)</li> <li>• Complex food and packaging machines</li> <li>• Conveyor systems based on PROFIBUS DP</li> <li>• Production lines with several interlinked machines</li> </ul>

# PROFINET/Industrial Ethernet

## Software and tools

### SIMATIC iMap

#### Technical specifications (continued)

Engineering tool	SIMATIC iMap
<b>Target systems</b>	<ul style="list-style-type: none"> <li>• SIMATIC S7 CPU 31x-2 PN/DP and SIMATIC S7 CPU 319-3 PN/DP (with integrated PROFINET interface. This can be used as a proxy function for the devices of a complete PROFIBUS segment, one line only)</li> <li>• SIMATIC WinAC PN (can be used as a proxy function for the devices of a complete PROFIBUS segment, one line only)</li> <li>• SIMATIC NET IE/PB Link (can be used as a proxy function for the devices of a complete PROFIBUS segment)</li> <li>• SIMATIC NET CP 343-1 and CP 343-1 Advanced (for connecting SIMATIC S7-300 to Ethernet), CP443-1 Advanced (for connecting SIMATIC S7-400 to Ethernet)</li> <li>• Distributed I/O stations with separate CPU (all intelligent field devices on PROFIBUS such as SIMATIC CPU 313C-2DP, CPU 314C-2DP, CPU 315-2DP, CPU 316-2DP, ET 200 IM 151 CPU, ET 200S BM 147 CPU),</li> <li>• PROFINET CBA OPC Server (for access from PC applications to data in PROFINET devices)</li> <li>• Devices on Industrial Ethernet based on the PROFINET CBA standard</li> <li>• SIMATIC OPs (within the components)</li> <li>• SIMATIC ProTool/Pro, WinCC or any other visualization system with OPC client function</li> </ul>
<b>System prerequisites</b>	
Operating system	Windows XP Prof. with Service Pack 2 or Windows 7 Ultimate/Professional; PC administration rights are required for installation
PG/PC hardware	Pentium processor, 1 GHz or higher
Recommended expansion of main memory in PG/PC	RAM: 512 MB or more
Hard disk space required in PG/PC	Approx. 200 MB
Software required	<ul style="list-style-type: none"> <li>• STEP 7 V5.3 Service Pack 3 or higher</li> <li>• PN OPC-Server V6.3 or higher</li> </ul> <p>The following software must be installed before iMap (included in the iMap package):</p> <ul style="list-style-type: none"> <li>• MS Internet Explorer V6.0 Service Pack 1 and higher</li> <li>• Adobe Acrobat Reader V5.0</li> </ul>
<b>Delivery format</b>	
Languages	English, German, French, Italian and Spanish
Single License (SL)	Yes
Upgrade License (UL)	Yes, from V2.0 to V3.0
Paper manuals	Electronically on CD
<b>Authorization/licenses</b>	
Authorization	Yes
Single License (SL)	Yes
Upgrade License (UL)	Yes
Software Update Service	Yes
Unlock Copy License	No

#### Ordering data

#### Article No.

##### SIMATIC iMap V3.0

**Target system:**  
 CPU 31x-2 PN/DP,  
 CPU 319-3 PN/DP,  
 SIMATIC WinAC PN,  
 SIMATIC NET IE/PB Link,  
 SIMATIC NET CP 343-1,  
 SIMATIC NET CP 343-1 Advanced,  
 SIMATIC NET CP 443-1 Advanced,  
 distributed I/O devices  
 with own CPU,  
 PROFINET CBA OPC server,  
 devices on the  
 Industrial Ethernet based on the  
 PROFINET CBA standard,  
 SIMATIC OPs,  
 SIMATIC ProTool/Pro

**Requirements:**  
 Windows XP Prof.  
 with Service Pack 2 or  
 Windows 7 Ultimate/Professional;  
 on PG or PC with  
 Pentium processor, min. 1 GHz;  
 STEP 7 V5.3 or higher with  
 Service Pack 3,  
 PN OPC Server V6.3 or higher  
**Type of delivery:**  
 German, English,  
 with electronic documentation

Floating License

**6ES7820-0CC04-0YA5**

Software Update Service (requires  
 current software version)<sup>1)</sup>

**6ES7820-0CC01-0YX2**

Upgrade to V3.0, floating license

**6ES7820-0CC04-0YE5**

<sup>1)</sup> For more information on the software update service, see Catalog ST 70.



## Overview

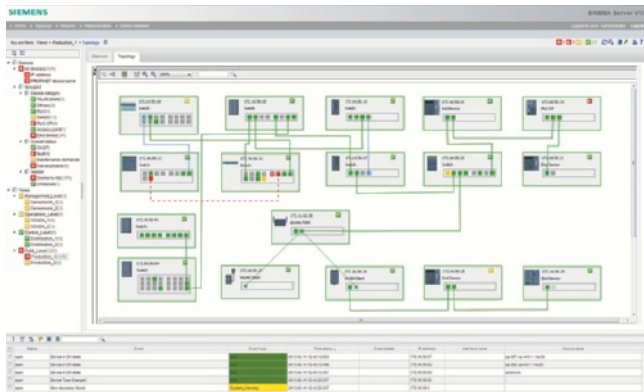

SINEMA Server is a web-based network monitoring software that significantly reduces the response time to communications problems in industrial networks, and thus avoids downtimes and saves costs.

- Simple operator input even for plant operators or service personnel, to enable autonomous detection and correction of communications problems
- Graphical representation of industrial networks (automatic topology detection and layout)
- Standardized network documentation (reports for inventory, availability and utilization)
- Simple operation via web browser or via an HMI/SCADA application, without special IT knowledge
- Network data such as network topology and device information automatically saved to a database
- Low installation and maintenance costs, especially thanks to the use of pre-installed industrial PCs (Microbox PC)
- High degree of flexibility for graphical representation thanks to automatic and customizable topology views
- Monitoring can be adapted to devices and users

## Benefits

get **Designed for Industry**

- Reporting and analysis of changes and faults in the network
  - Alarm messages
  - Clear visualization
  - Prevention of downtimes
  - Error localization
- Cost savings
  - Reduced standstill costs
  - Low procurement costs
  - Low installation costs
  - No consequential costs
  - Scalable licenses
- Monitoring functionality can be adapted to the application, devices and users
  - Application-specific structuring and visualization
  - Intuitive operation via Web browser
  - Can be integrated into HMI
  - No specialist IT know-how/IT personnel required
- Automatic documentation of networks
  - Increased understanding
  - Continuous logging/documentation
  - Any time period selectable
  - Verification of availability

## Design

### Product versions

The number of Ethernet devices (IP nodes) to be monitored must be taken into account when selecting the software license. The licenses can be combined in any way to increase the number of monitored devices up to a maximum of 500 IP nodes per installation.

#### SINEMA SERVER 50

- Supports the diagnosis of up to 50 IP devices

#### SINEMA SERVER 100

- Supports the diagnosis of up to 100 IP devices

#### SINEMA SERVER 250

- Supports the diagnosis of up to 250 IP devices

#### SINEMA SERVER 500

- Supports the diagnosis of up to 500 IP devices

#### SINEMA Server Upgrade (V12)

- Upgrade SINEMA Server V11 to V12

#### Note:

Each SINEMA Server can display the status of up to 100 other SINEMA Servers. Up to 50,000 devices can thus be monitored.

## PROFINET/Industrial Ethernet

### Software and tools

#### SINEMA server

#### Function

##### ***Intuitive operation***

SINEMA Server is network management for industry. Attention was paid here to the most important functions for the industrial environment, and implementation is with a clear interface for intuitive operation. Users can monitor their networks in the shortest time possible. Costly and time-intensive IT training is not necessary.

##### ***Automatic device detection and generation of network topologies***

With the help of DCP and SNMP, SINEMA Server automatically detects PROFINET and Ethernet devices on the network and represents them graphically in a Web browser. This means the maintenance personnel in process and production plants can monitor the current status of the devices and their connections (topology) at all times without time-consuming configuring.

##### ***User-specific topology display***

As well as automatic display of the topology, SINEMA Server also gives users the option of representing the network nodes in any arrangement. These user-specific topologies can also be supplemented with background images (e.g. building or plant diagrams). In the case of faults, this means the relevant network components can be found and, if required, replaced or repaired more quickly.

##### ***Event-triggered alarms***

For gap-free and instantaneous monitoring of the network, network messages must be detected immediately and the user must be informed. For this purpose, SINEMA Server offers event handling with which all network event messages are acquired and processed. Users of SINEMA Server are thus supplied with all the important event information concerning the network.

##### ***User-defined display***

Different personnel with different roles (e.g. administrators, maintenance personnel, etc.) can use SINEMA Server in their daily work.

The administrator defines different groups to whom the appropriate rights and views are assigned. Up to 10 people with different tasks can work simultaneously with SINEMA Server.

##### ***Comprehensible network reports***

Network diagnostics encompasses not only the current status of the network, but also the analysis of historical values. SINEMA Server saves to a database all values read out from the network components. Time-based filtering and evaluation with comprehensible reports can then take place. In this way, all past events can also be analyzed and used to prevent future failures.

##### ***Diagnostics via Web browser***

Access to network diagnostics should not be locally restricted, particularly in the case of large networks. That's why SINEMA Server has been developed on the basis of a server architecture. This enables access to the network management software via commonly used Web browsers. In this way, the network to be checked can also be diagnosed from any location. This enables the network diagnostics tasks of several plant sections to be bundled in one control room.

##### ***Integration into HMI/SCADA systems***

To have everything in view, network diagnostics should be integrated in the HMI/SCADA plant solution. SINEMA Server offers full integration of the topology via the Web browser. In addition, all parameters such as warnings and faults can be transferred via the integrated OPC interface. This enables users to integrate network diagnostics into HMI/SCADA systems without a high engineering outlay.

**Function** (continued)

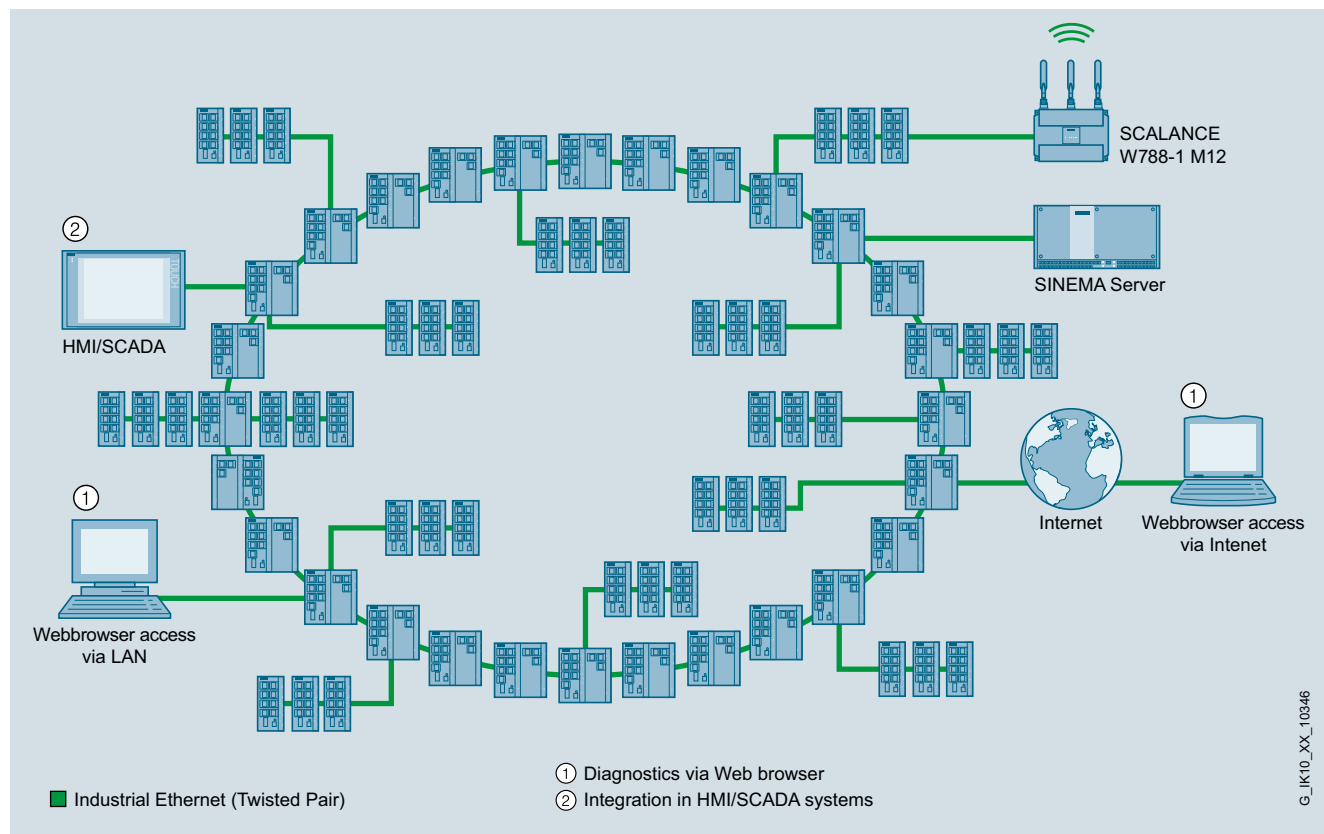

The network information prepared by SINEMA Server can be called up by any clients via a Web browser or OPC interface.

**Adaptable device profiles**

Users have the option of optimizing the device display by means of the profile concept, particularly for non-Siemens network components represented by SINEMA Server via standard SNMP information. Scanning of device-specific data via SNMP can also be set via the profile. This means that an industrial network comprising devices from different manufacturers can be optimally monitored with SINEMA Server.

**Adaptable quantity structure with up to 50,000 network nodes**

Different SINEMA Server licenses can be selected depending on the size of the network. SINEMA Server thus monitors large networks with up to 500 stations with one installation. With extremely large production networks, SINEMA Server is able to display up to 100 further SINEMA Servers. In this way, individual production cells can be monitored centrally from a single SINEMA Server station.

**Ordering data**

**SINEMA Server V12**

Network monitoring software for industrial Ethernet and PROFINET networks, runtime software, software and electronic manual on DVD (not with download), license key on USB flash memory (not with download); software for installation on PC hardware with Win7 Professional and Windows Server 2008 R2+SP1, Windows XP/SP3 (32-bit), Windows 7 Professional/Ultimate/Enterprise SP1 (32/64-bit), and Windows Server 2008 R2 + SP1 (64-bit) English/German/French/Chinese. Other languages possible on request.

**For 50 devices that can be identified via IP address**

- On DVD
- Download <sup>1)</sup>

**Article No.**

**6GK1781-1BA12-0AA0**  
**6GK1781-1BA12-0AK0**

**Article No.**

**For 100 devices that can be identified via IP address**

- On DVD
- Download <sup>1)</sup>

**6GK1781-1DA12-0AA0**  
**6GK1781-1DA12-0AK0**

**For 250 devices that can be identified via IP address**

- On DVD
- Download <sup>1)</sup>

**6GK1781-1JA12-0AA0**  
**6GK1781-1JA12-0AK0**

**For 500 devices that can be identified via IP address**

- On DVD
- Download <sup>1)</sup>

**6GK1781-1TA12-0AA0**  
**6GK1781-1TA12-0AK0**

**Upgrade SINEMA Server V11 to V12**

- On DVD
- Download <sup>1)</sup>

**6GK1781-2AA12-0AA0**  
**6GK1781-2AA12-0AK0**

<sup>1)</sup> For more details of online software delivery, visit: [www.siemens.com/tia-online-software-delivery](http://www.siemens.com/tia-online-software-delivery) under Ordering Data

G\_IK10\_XX\_10346

# PROFINET/Industrial Ethernet

## Software and tools

### PN IO Bus Analyzer

#### Overview



- Network analysis with the bus analyzer
- Comprising hardware and software components
- USB memory expansion possible
- Frame recording with 10 ns resolution
- Automatic PROFINET analysis
- Online value tracking
- Packet generator with feedback analysis
- Control interface using script or TCP commands

#### Benefits

- Direct and immediate online analysis in real time and precise statement of the quality of the network.
- Recording at all speeds without losses and exact time stamping by hardware-based processing.
- When analyzing and monitoring PROFINET components, it is possible to match and verify the frame structure, the frame times and the frame synchronization.
- Fast error analyses and improved performance in plant operation, in particular in networks in which products of different vendors are being used.
- Active measurements on the network with a packet generator: Feed in of frame sequences, delay time measurements, network reactions.
- Simple reproduction or automation of test scenarios / measurements controlled by scripts.

#### Application

Bus Analyzer is the analysis tool for Ethernet / PROFINET. It is made up of a hardware component and a Windows application that communicate with each other over Ethernet. The hardware is controlled and has parameters assigned by the application (triggers, filters, start, stop etc.), the application also downloads the recorded data and statistics to the analysis computer where they are interpreted, displayed and saved.

The many functions of the bus analyzer are implemented in individual modules. The modular structure allows target-oriented localization of error sources and the detection of weak points long before problems occur. The following modules are available:

- **Frame recording** allows the precise recording of frames on Ethernet / PROFINET.
- **PROFINET analysis** automatically detects all relevant bus parameters (number of frames, bus cycles, etc.) online in real time and displays them in tables and graphically.
- **Online value tracking** allows the user to extract and record any sizes and values of the communication partners from the frame traffic.
- With the **packet generator**, recorded or self-generated frame sequences can be fed into the Ethernet network and the reaction of the network measured automatically.
- Control of all functions by script or a remote interface (Ethernet, TCP) is possible.

#### Design

- Module in housing without fan (with bracket for mounting on a DIN rail)
- Power supply 24 V (does not ship with product)
- Four independent RJ45 analysis interfaces for connection to Ethernet
- One RJ45 interface for Ethernet connection of the module to the host PC
- Internal memory with 2 GB (can be set as a ring buffer)
- Binary hardware inputs and outputs (can be used as trigger inputs and outputs)
- USB Interface for connection of external storage media

#### Product versions

Standard version:

Includes the frame recording and PROFINET analysis modules.

Premium version:

Includes the frame recording, PROFINET analysis, online value tracking and packet generator modules.

The option of controlling with a script or by applications is available with both variants.

## Function

All bus analyzer functions are controlled by the Bus Analyzer Scope program that ships with the product. This Windows application is connected to the bus analyzer sys module via an Ethernet connection. This is possible via a direct connection, via a network or via a VPN tunnel.

The four analysis ports can be used by all function modules but not at the same time. They need to be enabled and assigned to the module being used.

On completion of the parameter assignment and after starting the relevant analysis function, the connection between Bus Analyzer and Bus Analyzer Scope can be terminated, in other words, the module then works alone.

The **frame recording** provides a comfortable option of recording communication on Ethernet connections at speeds from Fast Ethernet to gigabit Ethernet.

The FPGA technology design of the Bus Analyzer throughout allows error-free, gapless recording of all data with 10 ns time stamping. Even bad frames are not automatically discarded but can be saved and evaluated.

The four recording ports can be used independently for recording. If a Test Access Point (TAP) is used to decouple the frames instead of a hub or a switch mirror port, it is possible to interconnect ports; in other words, to bundle their data streams and to save and evaluate them together.

To allow the recording to be controlled effectively, freely programmable filters and triggers are available. Apart from standards such as addresses, protocols and patterns, there are also special functions that can trigger on frame timeouts and bad frames (CRC error, undersize error etc.). The integrated hardware inputs can also be used to fire triggers using external binary signals.

The data is saved in the internal RAM (2 GB capacity) that can also be set as a ring buffer. At the end of the recording, the data is loaded and saved either on the PC via the Ethernet host connection or on an external storage medium connected via USB. If it is necessary to record larger volumes of data, the data can also be streamed to the PC during the recording and saved there.

All frames are saved in a file in "pcap" format that can, for example, be read by Wireshark.

**PROFINET analysis** automatically detects all important parameters of a PROFINET system. The Bus Analyzer analyzes the frame traffic in real time in terms of frame type, cycle times and many other important characteristics of the network.

During the analysis, all PROFINET nodes are listed in table. The following information is displayed and updated cyclically for each node:

PROFINET class, number of sent/received packets, desired cycle time, min/max cycle time, min/max cycle time deviation.

The number of frames sent by each node per time unit can be visualized in a cycle time diagram. These are displayed graphically in a distribution curve. At a glance, it is possible to see how well the PROFINET component keeps to the cycle.

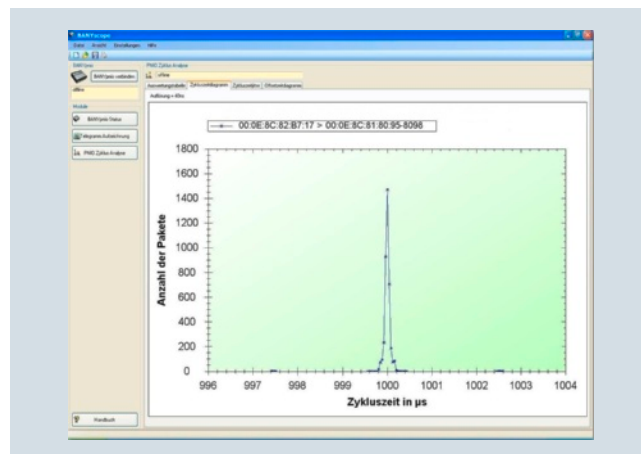

During the analysis of PROFINET IRT, not only the degree to which individual components adhere to the cycle is important, but also the offset of the time of sending within the cycle; in other words, its behavior in conjunction with the other communications partners in the network. The offset diagram can display the distribution curves of all nodes in the cycle to allow a statement to be made regarding the quality within the entire network and the time slice distribution of its nodes.

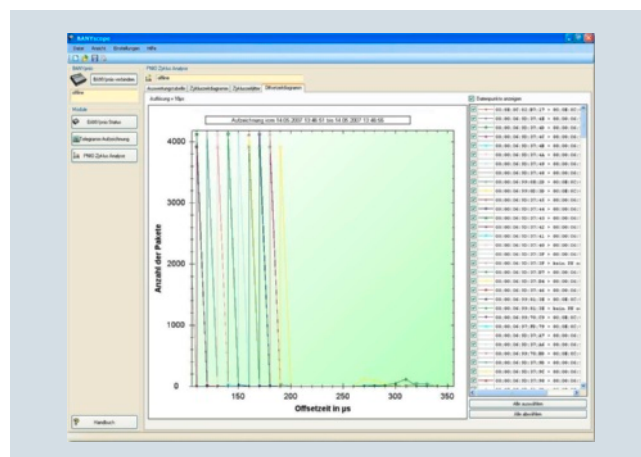

Based on intuitively structured filter menus, the **online value tracking** provides a simple and uncomplicated means of extracting data from the frame traffic. In contrast to the frame recording, complete frames are not saved here but rather individual values of the relevant communications partners transferred via PROFINET.

This means, for example, that the setpoint of a controller, the speed of a motor etc. can be read directly from PROFINET and saved with a time stamp (resolution 10 ns). This is displayed in a table or graphically in the form of a curve that represents the values over time online and in real time.

To be able to select the values, the address of the node, the byte position of the value within the frame and the number of bytes to be read must be specified in the filter. The size of the values is limited to 8 bytes. All available formats can be interpreted (binary, integer, analog, ...).

Up to four values can be recorded simultaneously. There is no limit to the recording time.

## PROFINET/Industrial Ethernet

### Software and tools

#### PN IO Bus Analyzer

##### Function (continued)

The **packet generator** allows any Ethernet frames to be injected into the network. To allow this, all four analysis ports are available and are independent of each other. As an alternative, the ports can also be coupled together in pairs as sender/receiver to be able to read in sent frames and to verify the read frames with the sent frames.

The frames to be sent are transferred to the module as input in the form of "pcap" files. These inputs can either be generated by recording or can be created as new frames using the integrated pcap editor.

Each port has its own menu for setting the relevant send options. Among other things, the packets can be sent as follows:

- Cyclically (with breaks)
- As a fixed percentage of bus load
- With a specified number of repetitions
- For a specified time etc.

At the end of the action, all important parameters (bus load, duration etc.) are output as statistics.

The packet generator only executes with the Bus Analyzer without TAP.

All the modules listed above can also be remotely controlled by a **script**. To allow this, each action taken by the user is logged in the integrated script window. The log can be saved, edited and transferred later to Bus Analyzer Scope when this is called. All the instructions in the script are then executed. This allows automated test sequences, for example for setting up test automats. The manual contains an overview of all the script commands that can be used.

As an alternative, the script commands can also be transferred using a remote interface (via TCP/IP) from another application to Bus Analyzer Scope. When TCP is used as the transfer interface, the application does not need to be located on the same computer as Bus Analyzer Scope, only in the same network. A sample program in C# ships with the product.

##### Ordering data

##### Article No.

###### Bus analyzer hardware agent for 2 channels without TAP

9AE4140-1BA00

For PROFINET diagnosis (100 Mbit) of 2 fieldbuses or Ethernet diagnosis (up to 1 Gbit) of 2 network segments

###### Bus analyzer hardware agent with 2-channel TAP

9AE4140-1BA01

For reaction-free PROFINET diagnosis of 2 fieldbuses

### Overview

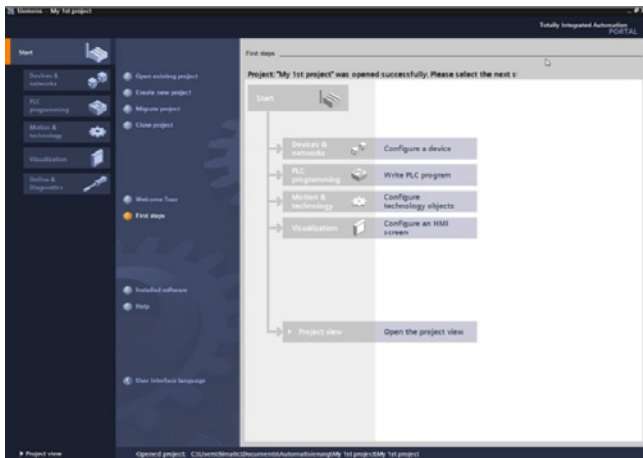

STEP 7 V13 (TIA Portal), portal view

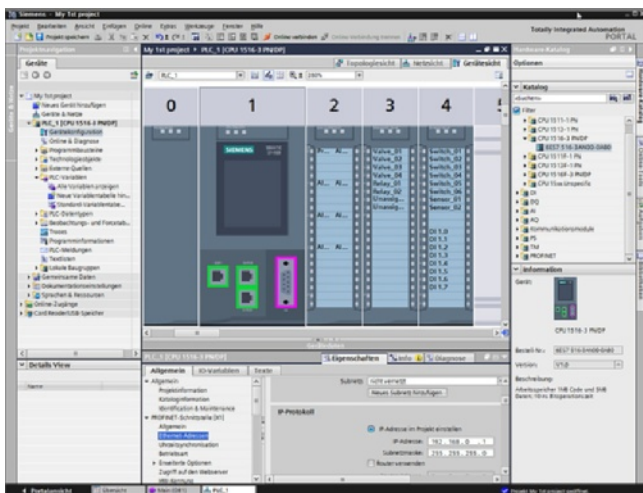

STEP 7 V13 (TIA Portal), device view: configuring and parameterizing in photographically realistic representation

### **Intuitive, efficient and future-oriented – the engineering software for programming the SIMATIC controllers**

SIMATIC STEP 7 Professional V13 is the engineering system for the SIMATIC controllers S7-1200, S7-300, S7-400, WinAC, and also optimally supports the new SIMATIC S7-1500 controllers.

SIMATIC STEP 7 Basic V13 is the engineering system for the S7-1200.

STEP 7 V13 is based on the central engineering framework Totally Integrated Automation Portal (TIA Portal), which offers the user a uniform, efficient and intuitive solution to all automation tasks.

### Benefits

- Powerful programming editors for efficient engineering
- Scalability across all series of controllers
- Optimum interaction between the controller, HMI and drive in a working environment
- Shared data management and uniform symbols
- System diagnostics as an integral component
- Variables trace for effective commissioning
- Scalable and flexible motion control functionality
- Comprehensive library concept
- Security Integrated
- Migration support for existing hardware and software products

### Application

SIMATIC STEP 7 Professional V13 is the easy-to-use, integrated engineering system for the current SIMATIC controllers S7-1200, S7-1500, S7-300, S7-400, WinAC, and ET 200 CPU. PLCSIM for simulating the S7-1500 CPU and WinCC Basic for the configuration of Basic Panels are included in the scope of delivery.

SIMATIC STEP 7 Basic V13, the easy-to-use engineering system for the modular SIMATIC S7-1200 micro PLC, as well as the associated I/O. It contains SIMATIC WinCC Basic for the configuration of the SIMATIC Basic Panels.

STEP 7 V13 thus provides support in all phases of the automation project:

- Configuring and parameterizing the hardware
- Specifying the communication
- Programming in IEC programming editors
- Configuration of the visualization
- Test, commissioning and service

## PROFINET/Industrial Ethernet

### Engineering / Network management / Diagnostics

#### STEP 7 (TIA Portal)

#### Function

##### **Excellent integration of the new SIMATIC S7-1500 controller**

With its many innovations, the new SIMATIC S7-1500 controller from the SIMATIC S7 controller family sets new standards for maximum productivity. The SIMATIC S7-1500 is perfectly integrated into SIMATIC STEP 7 V13 Professional for maximum engineering efficiency. With its unique system performance and PROFINET as standard interface, the SIMATIC S7-1500 is the new benchmark for performance.

##### **Powerful programming editors for efficient engineering**

STEP 7 V13 provides powerful programming editors with optimized compilers for the programming of the S7 controllers.

For all controllers:

- Ladder diagram (LAD)
- Function block diagram (FBD)
- Structured text (SCL)

Additionally for SIMATIC S7-1500, S7-300, S7-400, and WinAC:

- Statement list (STL)

New functions such as

- Instructions for the Variant Pointer, for the programming of flexible library functions
- Reflexion instructions for reading out program information during runtime (e.g. instance names),
- local constants
- etc.

enable users to create their applications efficiently. Even complex technological functions, such as controllers or positioning controllers can easily be implemented in the engineering software.

##### **Variables trace for effective commissioning**

The Trace Editor provides the ability to record signals in chronological order from the user program of an S7-1500 CPU. The graphical evaluation of the signals simplifies, for example, the commissioning of drives and helps search for sporadic errors in the application or user program.

##### **Scalable and flexible motion functionality**

Motion Control applications with SIMATIC STEP 7 V13 and S7-1500 become child's play, even for beginners. The intuitive graphical user interfaces of the technology objects in STEP 7 V13 offer the best support in the configuration and commissioning of analog and PROFIdrive-capable drives as well as in troubleshooting. The instructions for controlling the motion sequence are standardized according to PLCopen Motion Control. The following functions are supported in STEP 7 V13:

- Positioning (absolute and relative)
- Speed specification (e.g. jogging)
- Homing (active, on-the-fly, etc.)
- Support of incremental and absolute encoders

##### **Comprehensive library concept**

For the reuse and simple standardization of frequently used program sections, the system has a comprehensive library concept.

Elements such as blocks, tags, alarms, HMI graphics, graphic objects, individual modules or entire stations can be stored along with their parameter assignment in local or global libraries. This means they are available for further programming tasks.

##### **Security Integrated**

STEP 7 V13 has password-based know-how protection against unauthorized reading and changing the contents of program blocks.

Copy protection offers greater protection against unauthorized copying of program blocks. These can be tied to the serial number of a memory card so that the block can only run if the configured memory card is inserted into the CPU.

In addition, multiple user groups with different access rights can be assigned to the controller by means of four different authorization levels.

Improved manipulation protection offers a greater degree of security against unauthorized changes to the data transferred between STEP 7 and the controller.

##### **Migration support for existing hardware and software products**

A migration tool integrated in SIMATIC STEP 7 Professional V13 provides support in switching from the S7-300/S7-400 to the S7-1500 controller and converts the program code automatically. Program code that cannot be converted automatically is logged and can be adapted manually. STEP 7 V12 SP1 projects can continue to be used with STEP 7 V13 in compatibility mode.



**Technical specifications**

	<b>STEP 7 Professional / Basic V13 (TIA Portal)</b>
Type of license	Floating license
Software class	A
Current version	V13
Target system	SIMATIC S7-1200, S7-1500, S7-300, S7-400, WinAC
Operating system	Windows 7 (64-bit) <ul style="list-style-type: none"> <li>• Windows 7 Professional SP1</li> <li>• Windows 7 Enterprise SP1</li> <li>• Windows 7 Ultimate SP1</li> </ul> Windows 8.1 (64-bit) <ul style="list-style-type: none"> <li>• Windows 8.1</li> <li>• Windows 8.1 Professional</li> <li>• Windows 8.1 Enterprise</li> </ul> Windows Server (64-bit) <ul style="list-style-type: none"> <li>• Windows Server 2008 R2 StdE SP1 (full installation)</li> <li>• Windows Server 2012 R2 StdE (full installation)</li> </ul>
Computer	SIMATIC Field PG M4 PREMIUM or higher (or comparable PC)
Processor	Intel Core i5-3320M 3.3GHz or higher
RAM	min. 8 GB
Hard disk	300 GB SSD
Screen	15.6" widescreen display (1920 x 1080)
Note	Includes the IEC programming languages SCL, LAD, FBD, STL and GRAPH

**Compatibility with other SIMATIC products**

STEP 7 Professional / Basic V13 (incl. WinCC Basic V13) can be installed on a PC in parallel with other versions of STEP 7 V12, V5.4 or V5.5, STEP 7 Micro/WIN, WinCC flexible (from 2008) and WinCC (V7.0 SP2 or higher).

2

**Ordering data**
**STEP 7 Professional / Basic V13**

*Target system:*  
SIMATIC S7-1200, S7-1500, S7-300, S7-400, WinAC

*Requirement:*  
Windows 7 Professional SP1 (64 bit),  
Windows 7 Enterprise SP1 (64 bit),  
Windows 7 Ultimate SP1 (64 bit),  
Windows 8.1 (64 bit),  
Windows 8.1 Professional (64 bit),  
Windows 8.1 Enterprise (64 bit),  
Windows Server 2008 R2 StdE (full installation),  
Windows Server 2012 StdE (full installation)

*Form of delivery:*  
German, English, Chinese, Italian, French, Spanish

**STEP 7 Professional V13, Floating License**      **6ES7822-1AA03-0YA5**

**STEP 7 Professional V13, Floating License, software download incl. license key <sup>1)</sup>**      **6ES7822-1AE03-0YA5**

E-mail address required for delivery

**STEP 7 Professional V13, Trial License**      **6ES7822-1AA03-0YA7**

**Article No.**
**Article No.**
**STEP 7 Professional V13 promotional package**

Only valid if ordered together with a Software Update Service 6ES7810-5CC04-0YE2 (STEP 7 Professional and STEP 7 Professional in TIA Portal).

- PowerPack & upgrade from STEP 7 V5.5 to STEP 7 Professional 2010/V13, Floating License. Prerequisite is an existing STEP 7 Software Update Service.

**6ES7822-1AA03-0XC2**

- PowerPack & upgrade from STEP 7 V5.5 to STEP 7 Professional 2010/V13, Floating License. Prerequisite is an existing STEP 7 Software Update Service.

**6ES7822-1AE03-0XC2**

- Software download incl. license key <sup>1)</sup>  
E-mail address required for delivery

**6ES7822-1AA03-0XC3**

- PowerPack & upgrade from STEP 7 V5.4/V5.5, ... to STEP 7 Professional 2010/V13, Floating License. Prerequisite is an existing STEP 7 Standard/Professional installation.

**6ES7822-1AE03-0XC3**

- PowerPack & upgrade from STEP 7 V5.4/V5.5, ... to STEP 7 Professional 2010/V13, Floating License. Prerequisite is an existing STEP 7 Standard/Professional. Software download incl. license key <sup>1)</sup>  
E-mail address required for delivery

<sup>1)</sup> For up-to-date information and download availability, see: <http://www.siemens.com/tia-online-software-delivery>

# PROFINET/Industrial Ethernet

## Engineering / Network management / Diagnostics

### STEP 7 (TIA Portal)

Ordering data	Article No.	Article No.
Upgrade STEP 7 Professional V12 to STEP 7 Professional V13, Floating License	6ES7822-1AA03-0YE5	<b>Software Update Service</b>  For a period of 12 months and for a fixed price, the customer is automatically provided with all upgrades and service packs for each installed software package. The contract is automatically extended by a further year unless canceled at least 12 weeks prior to expiration. Requires the current software version
Upgrade from STEP 7 Prof. V12 to STEP 7 Professional V13, Floating License, software download incl. license key <sup>1)</sup>  E-mail address required for delivery	6ES7822-1AE03-0YE5	
Upgrade from STEP 7 Prof. 2006/2010 to STEP 7 Professional 2010/V13, Floating License	6ES7822-1AA03-0XE5	<b>Software Update Service (Standard Edition)<sup>2)</sup></b>  The delivery is implemented according to the number of ordered SUS products (e.g. 10 upgrade packages with 10 DVDs, 10 USB flash drives, etc.) • STEP 7 Professional V1x • STEP 7 Professional and STEP 7 Professional in the TIA Portal • STEP 7 Basic
Upgrade from STEP 7 Prof. 2006/2010 to STEP 7 Professional 2010/V13, Floating License, software download incl. license key <sup>1)</sup>  E-mail address required for delivery	6ES7822-1AE03-0XE5	
<b>PowerPack &amp; upgrade from STEP 7 V5.4/V5.5 to STEP 7 Professional 2010/V13, Floating License</b>	6ES7822-1AA03-0XC5	<b>Software Update Service (Compact Edition)<sup>2)</sup></b>  The delivery items are combined. For several contracts, only 1 package with 1 data medium set, 1 USB flash drive with the corresponding number of licenses and the corresponding number of COLs will be supplied. Delivery items to be combined must be ordered as one item. • STEP 7 Professional V1x • STEP 7 Professional and STEP 7 Professional in the TIA Portal • STEP 7 Basic
<b>PowerPack &amp; upgrade from STEP 7 V5.4/V5.5 to STEP 7 Professional 2010/V13, Floating License, software download incl. license key<sup>1)</sup>  E-mail address required for delivery</b>	6ES7822-1AE03-0XC5	
<b>PowerPack STEP 7 Basic V13 to STEP 7 Professional V13, Floating License</b>	6ES7822-1AA03-0YC5	<b>Software Update Service (download)<sup>2)</sup></b>  The upgrades and service packs are available for downloading. E-mail address required for delivery • STEP 7 Professional V1x • STEP 7 Professional and STEP 7 Professional in the TIA Portal • STEP 7 Basic
<b>PowerPack STEP 7 Basic V13 to STEP 7 Professional V13, Floating License, software download incl. license key<sup>1)</sup>  E-mail address required for delivery</b>	6ES7822-1AE03-0YC5	
<b>STEP 7 Basic V13, Floating License</b>	6ES7822-0AA03-0YA5	6ES7822-1AA00-0YL5 6ES7810-5CC04-0YE2 6ES7822-0AA00-0YL0
<b>STEP 7 Basic V13, Floating License, software download incl. license key<sup>1)</sup>  E-mail address required for delivery</b>	6ES7822-0AE03-0YA5	
<b>STEP 7 Basic V13, Trial License</b>	6ES7822-0AA03-0YA7	6ES7822-1AA00-0YM5 6ES7810-5CC00-0YM2 6ES7822-0AA00-0YM0
<b>Upgrade STEP 7 Basic V12 to STEP 7 Basic V13, Floating License</b>	6ES7822-0AA03-0YE5	
<b>Upgrade STEP 7 Basic V12 to STEP 7 Basic V13, Floating License, software download incl. license key<sup>1)</sup>  E-mail address required for delivery</b>	6ES7822-0AE03-0YE5	6ES7822-1AE00-0YY0 6ES7810-5CC04-0YY2 6ES7822-0AE00-0YY0

<sup>1)</sup> For up-to-date information and download availability, see: <http://www.siemens.com/tia-online-software-delivery>

<sup>2)</sup> For more information on the Software Update Service, see Catalog ST 70.

#### More information

##### Brochures

Informative material for downloading can be found on the Internet:

<http://www.siemens.com/simatic/printmaterial>

##### Software download

For up-to-date information and download availability, see:

<http://www.siemens.com/tia-online-software-delivery>

## Overview

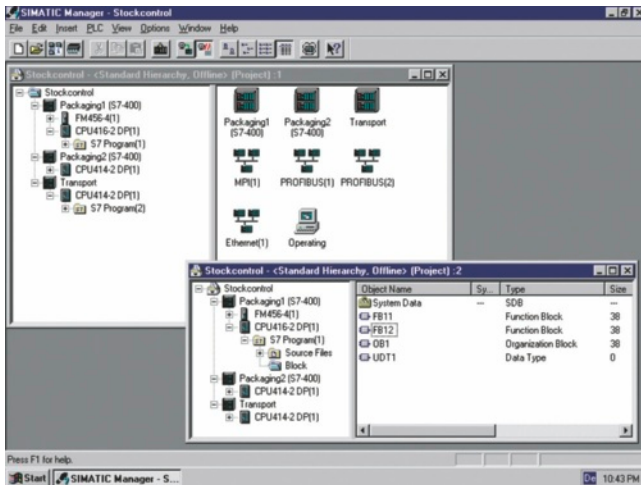

- STEP 7 basic software:  
The standard tool for the SIMATIC S7, SIMATIC C7 and SIMATIC WinAC automation systems.
- Makes use of the full performance capabilities of the systems
- User-friendly functions for all phases of an automation project:
  - Configuring and parameterizing the hardware
  - Definition of communication
  - Programming
  - Testing, commissioning and service
  - Documentation, archiving
  - Operating, diagnostics functions

## Application

STEP 7 basic software is the standard tool for the SIMATIC S7, SIMATIC C7 and SIMATIC WinAC automation systems. It enables the user to use the performance capability of these systems easily and conveniently.

STEP 7 contains convenient functions for all phases of an automation project:

- Configuring and parameterizing the hardware.
- Specifying the communication.
- Programming.
- Test, start-up and service.
- Documentation, archiving.
- Operating/diagnostics functions.

All functions are supported by the extensive online help.

STEP 7 is installed as standard on the Field PG M programming device. It is also available as a software package for a PC installation. For use with a PC, a PC module or PC adapter is required. STEP 7 allows several users to work on a project simultaneously. Write access from more than one user is prevented.

## STEP 7 trial license

If the customer wishes to test that STEP 7 can run on the intended system before it is implemented, the STEP 7 trial license is available for a token fee.

## STEP 7 Professional

STEP 7 Professional provides a software package that, in addition to STEP 7, includes the options of S7-SCL, S7-GRAPH and S7-PLCSIM. STEP 7 Professional is available as an upgrade package for STEP 7. If a common software update package is used, all the languages in the current version can be maintained.

### Note:

Screenshots for the individual tools can be found in the form of a PDF in the detailed information.

## Design

STEP 7 basic software provides users with different tools for carrying out their automation projects:

- **SIMATIC Manager:**  
For the common and orderly management of all tools and data for the SIMATIC S7, SIMATIC C7 and SIMATIC WinAC
- **Symbol editor:**  
For defining symbolic designations, data types and comments of global tags
- **Hardware configuration:**  
For configuration of the automation system and for parameterization of all settable modules
- **Communication:**  
For configuring connections. Cyclic data transmission between automation components via MPI or for event-driven data transmission by means of either MPI, via PROFIBUS or Industrial Ethernet
- **Information functions:**  
For a fast overview of CPU data and the causes of trouble during execution of a user program

For the creation of a user-written program, STEP 7 offers the following field-proven, standardized PLC programming languages:

- Statement list (STL)
- Ladder diagram (LAD)
- Function Block Diagram (FBD)

Furthermore, for special tasks, additional programming languages or technology-oriented configurations can be employed.

## PROFINET/Industrial Ethernet

### Engineering / Network management / Diagnostics

#### STEP 7

#### Function

##### STEP 7 blocks

STEP 7 files all user-written programs and all the data required by those programs in blocks. The possibility of calling other blocks within one block, as though they were subroutines, enables the structuring of the user program. This increases considerably the organizational clarity, the comprehensibility and the ease of maintenance of PLC programs. The following types of blocks are available:

- Organization blocks (OBs) control program execution.
  - OBs are divided into classes (e.g., time-driven, alarm-driven), independently of the triggering event. These classes have levels of priority. Depending on their respective priority levels, one can interrupt another.
  - When an OB is started, detailed information about the event initiating the start is provided. This information can be evaluated in the user-written program.
- Function blocks (FBs) contain the actual user program.
  - Function blocks can be supplied with different data each time they are called (the so-called instance). These data, as well as internal variables (e.g., for intermediate values) and results are stored in the assigned instance-data block and are automatically managed by the system.
- When an FB/SFB is called, instance data blocks (instance DBs) are assigned to the block. They are automatically generated when these blocks are compiled.
  - The user can access these instance data (symbolically as well, of course) from any point in his user program or from an HMI system.
- Functions (FCs) contain program routines for frequently used functions.
  - Every function has a fixed function value (a number of initial parameters are possible, in addition to the IEC standard). The output parameters must be processed immediately after the call. Thus functions do not require any instance-data blocks.
- Data blocks (DBs) are data areas for storing user data.
  - In addition to the data that is assigned in each case to a function block (instance data), global data can be defined and can be used by any of the software modules (e.g., for recipes).
  - An elementary or structured data type can be assigned to the components of a data block. Elementary data types are, for example, BOOL, REAL or INTEGER. Structured data types (fields and structures) comprise elementary data types (e.g. a recipe). The data in a data block can be addressed symbolically. This facilitates the programming and the readability of the program.
- System function blocks (SFBs); function blocks (see above) that are integrated in the CPU's operating system, e.g. SEND, RECEIVE, controller. The variables of the SFBs are also filed in IDBs.
- System functions (SFCs); functions (see above) that are integrated in the CPU's operating system, e.g., time functions, block transfer.
- System data blocks (SDBs) are data for the CPU's operating system containing the system settings, e.g., module parameters.

##### Tools

##### SIMATIC Manager

The SIMATIC Manager manages all data belonging to an automation project, regardless of the target system (SIMATIC S7, SIMATIC C7 or SIMATIC WinAC) on which they are implemented.

It provides a common entry point for all SIMATIC S7, C7 or WinAC tools. The SIMATIC software tools that are necessary for processing the selected data are automatically started by SIMATIC Manager.

##### Symbol Editor

With the tool Symbol Editor all global variables (in contrast to the local formal parameters that are declared when the blocks are programmed) are managed. The following functions are available:

- Definition of symbolic designations and comments for the process signals (inputs/outputs), flags and blocks
- Sorting functions
- Data exchange with other Windows programs.

The symbol charts that are generated when this tool is used are available to all applications. Changes to a symbol parameter are therefore automatically recognized by all tools.

##### Hardware configuration

The tool Hardware Configuration is used for configuring and parameterizing the hardware used for an automation project. The following functions are available:

- Configuration of the automation system
  - Racks are selected from an electronic catalog and the selected modules are assigned to the required slots in the racks.
- The configuration of the distributed I/Os is done in the same way as the configuration of the non-distributed I/Os; channel-granular I/O modules are also supported.
- CPU parameter assignment:
  - Properties such as restart characteristics and cycle-time monitoring can be set menu-driven. multicomputing is supported. The entered data are filed in system data blocks in the CPU.
- Module parameter assignment:
  - The user can specify all the adjustable parameters of the modules in input screen forms. Adjustments via DIP switches become unnecessary. Parameterization of hardware modules occurs automatically during the CPU's acceleration. Thus, a change of a module can be made without another parameterization.
- Function module (FM) and communications processor (CP) parameter assignment:
  - This parameterization also occurs within the hardware configuration in the same way as the parameterization of the other modules. For this parameterization hardware-module-specific screen forms and rules are provided for each FM and CP (is included in the FM/CP functions package). The system prevents faulty inputs by offering only allowed entry options on the parameter assignment screen forms.

**Function** (continued)

System diagnostics

System diagnostics offer the user an overview of the status of the automation system. The display can be in two different forms:

- Display of text messages, which can be output directly and quickly
- Pixel-graphics display within the Hardware Config display, offering the following options:
  - Display of general module information (e.g., order number, version, designation) and module status (e.g., faulty)
  - Display of module faults (e.g., channel faults) of the central I/O and DP slaves
  - Display of alarms from the diagnostics buffer

For CPUs, additional information is displayed:

- Causes of malfunction during user program execution
- Display of cycle duration (longest, shortest and last cycle)
- Display of the reserved and free memory
- Capabilities and usage of MPI communication
- Display of the performance data (number of possible inputs/outputs, flags, counters, timers and blocks)

Communication configuration

- Configuring and display of communication links
- Time-driven cyclic data transmission via MPI
  - Selection of communication partners
  - Entering of data source and data destination in a table. Generation of all system data blocks (SDBs) to be loaded and their complete transmission to all CPUs take place automatically.
- Event-driven data transmission:
  - Definition of the communication links
  - Selection of the communication function blocks (CFBs) from the integrated block library
  - Parameterization of the selected communication blocks in the customary programming language (e.g., LAD).

Programming languages

The well-proven programming languages Ladder (LAD), Function Block Diagram (FBD) and Instruction List (IL) are available for programming. Programs that comply with DIN EN 6.1131-3 can be created in the classical PLC programming languages Ladder Diagram (LAD) and Function Block Diagram (FBD).

The user-friendly, pixel-graphics LAD and FBD editors support the programmer with:

- Uncomplicated and intuitive operation:  
The creation of ladder diagrams/function block diagrams is characterized by the user-friendliness familiar from PCs, such as drag and drop, cut and paste.
- Library of predefined complex functions (such as PID controllers) or user-specific standard solutions

The Statement List (STL) textual programming language makes it possible for the user to create programs in which operating time and memory location are optimized and which are "close to the hardware." When creating these programs, the programmer is supported by the following user-friendly editing functions:

- Entry option in incremental mode and free text mode:  
the user can either have each input immediately checked "incrementally" for correctness, or create the complete program using only symbols in a text editor and subsequently have it translated by means of the appropriate symbol chart.

**Operation set**

The STEP 7 programming languages have a comprehensive set of instructions, similar to STEP 5. This allows even complex functions to be programmed easily (i.e., without having great programming knowledge) and quickly

The following functions are provided:

- Binary logic (incl. edge evaluation)
- Word operation
- Timers/counters
- Comparison functions
- Conversion functions
- Shift/rotate
- Mathematical functions (incl. trigonometry, exponents, logarithms)
- Program control (branches, branch distribution, calls, Master Control Relays).

In addition, improved testing and service functions make programming easier:

- Setting breakpoints (only S7-400)
- Forcing of inputs/outputs (only S7-400)
- Rewiring
- Display of cross-references

STEP 7 supports multicomputing with the S7-400

Status functions:

- Download and testing of blocks directly from the editor
- Status of several blocks at the same time
- Search functions:  
Specific locations within the program can be found quickly using search criteria (such as symbolic name, operand) (XRef).

Online Help (F1) is available for all functions and blocks.

Note:

Screenshot views are available for the individual tools.

## PROFINET/Industrial Ethernet

### Engineering / Network management / Diagnostics

#### STEP 7

#### Integration

##### **Components for connecting a PC to MPI and PROFIBUS**

The components described below are used to connect programming devices and PCs (incl. notebooks) to PROFIBUS and to the multipoint SIMATIC S7 MPI interface in conjunction with STEP 7.

##### PC adapter USB

- To connect a PC to the SIMATIC S7 programmable controller via the USB port.
- For connection to USB 1.1 and 2.0 interfaces.
- Can be used for SIMATIC S7-200, S7-300, S7-400 and C7.
- Supports routing.
- Automatic transmission rate and profile search.
- Noticeably improved performance (up to three times faster than the PC adapter via RS 232).
- Including subsequently updatable firmware (e.g. for function expansions or troubleshooting).
- Can be used under Windows XP, Windows Vista, Windows 7 (32/64-bit).
- Scope of delivery:
  - PC adapter USB.
  - CD "SIMATIC Software PC Adapter USB" including software and documentation.
  - USB cable, 5 m.
  - MPI cable, 0.3 m.

##### CP 5512

- For programming devices/ PCs/notebooks with PCMCIA slot.
- PCMCIA slot Type II (32 bit cardbus).
- Incl. adapter with 9-pin sub-D socket for connection to PROFIBUS.

##### CP 5611/CP 5611-MPI

- For programming devices/PCs with PCI slot
- Short PCI card (32 bit).
- CP 5611-MPI including MPI cable.

##### **Components for connecting the PC to Industrial Ethernet**

The PC modules described below are used to connect programming devices and AT-compatible PCs/notebooks to Industrial Ethernet in conjunction with STEP 7 and SOFTNET-PG (as of V6.0).

##### CP 1512

- For programming devices/ PCs/notebooks with PCMCIA slot.
- PCMCIA slot Type II (32 bit cardbus); 10/100 Mbit/s.
- Incl. adapter with RJ45 socket for connection to Industrial Ethernet.

##### CP 1612

- For programming devices/PCs with PCI slot
- Short PCI card (32 bit); 10/100 Mbit/s
- Incl. RJ45 socket for connection to Industrial Ethernet.

Please refer to the respective product catalog for technical information regarding product versions and supported operating systems.

You will find additional information about the online connection of PCs and SIMATIC S7/C7 controllers under "SIMATIC NET Communication Systems".

**Technical specifications**

6ES7972-0CB20-0XA0	
<b>Supply voltage</b> 24 V DC	Yes
<b>Input current</b> Current consumption, typ.	100 mA
<b>Power</b> Power consumption, typ.	max. 2.5 W
<b>EMC</b>	
Interference immunity against discharge of static electricity	
• Interference immunity against discharge of static electricity acc. to IEC 61000-4-2	Yes
Interference immunity to cable-borne interference	
• on the supply lines acc. to IEC 61000-4-4	Yes
• Interference immunity on signal lines acc. to IEC 61000-4-4	Yes
Surge immunity	
• on the supply lines acc. to IEC 61000-4-5	Yes; 1 kV (to IEC 61000-4-5; surge symm.); 2 kV (to IEC 61000-4-5; surge asymm.)
Immunity against high-frequency electromagnetic fields	
• Interference immunity against high-frequency radiation acc. to IEC 61000-4-3	Yes; 10 V/m, 80 to 1000 MHz (to IEC 61000-4-3); 10 V/m, 900 MHz, 1.89 GHz, 50% ED (to IEC 61000-4-3)
Immunity against conducted interference induced by high-frequency fields	
• Interference immunity against high frequency current feed acc. to IEC 61000-4-6	Yes; 10 V, 9 kHz to 80 MHz (to IEC 61000-4-6)
Immunity to magnetic field interference	
• Interference immunity to magnetic fields at 50 Hz	30 A/m; to IEC 61000-4-8
Emission of radio interference acc. to EN 55 022	
• Interference emission acc. to EN 55022, class B	Yes

6ES7972-0CB20-0XA0	
<b>Ambient conditions</b>	
Operating temperature	
• Min.	5 °C
• max.	40 °C
• Permissible temperature change	10 °C/h; Operation: 10 K/h; storage/transport: 20 K/h
Storage/transport temperature	
• Min.	-20 °C
• max.	60 °C
Relative humidity	
• Operation, min.	5 %
• max. relative humidity	80 %
• Storage/transport, min.	5 %
• Storage/transport, max.	95 %; At 25 °C (no condensation)
Vibrations	
• Operation, checked according to IEC 60068-2-6	Yes; 10 to 58 Hz: Amplitude 0.075 mm; 58 to 500 Hz: Acceleration 9.8 m/s <sup>2</sup>
• Transport tested checked to IEC 60068-2-6	Yes; (packed) 5 to 9 Hz, amplitude 3.5 mm; 9 to 500 Hz, acceleration 9.8 m/s <sup>2</sup>
Shock test	
• Shock test	Tested to DIN IEC 60068-2-2; Operation: 950 m/s <sup>2</sup> (10 g), 30 ms, 100 Shocks; Transport (packaged): 250 m/s <sup>2</sup> (25 g), 6 ms, 1000 shocks
<b>Dimensions</b>	
Width	105 mm
Height	58 mm
Depth	26 mm
<b>Weights</b>	
Weight, approx.	100 g

# PROFINET/Industrial Ethernet

## Engineering / Network management / Diagnostics

### STEP 7

2

#### Ordering data

#### Article No.

#### Article No.

#### STEP 7 Version 5.5

##### Target system:

SIMATIC S7-300/400, SIMATIC C7,  
SIMATIC WinAC

##### Requirements:

Windows XP Prof.,  
Windows 7 Professional / Ultimate

##### Delivery package:

German, English, French, Spanish,  
Italian;  
incl. license key on USB stick,  
with electronic documentation

Floating license on DVD

**6ES7810-4CC10-0YA5**

Floating License, license key  
download without software and  
documentation<sup>1)</sup>; email address  
required for delivery

**6ES7810-4CE10-0YB5**

Rental license for 50 hours

**6ES7810-4CC10-0YA6**

Rental License for 50 hours,  
license key download without  
software and documentation<sup>1)</sup>;  
email address required for delivery

**6ES7810-4CE10-0YB6**

Upgrade Floating License  
3.x/4.x/5.x to V5.5; on DVD

**6ES7810-4CC10-0YE5**

Trial License STEP 7 V5.5;  
on DVD, 14 day trial

**6ES7810-4CC10-0YA7**

#### STEP 7 Version 5.5 Japanese

##### Target system:

SIMATIC S7-300/400, SIMATIC C7,  
SIMATIC WinAC

##### Requirements:

Windows XP Professional Japanese

##### Delivery package:

English, Japanese;  
incl. license key on USB stick,  
with electronic documentation

Floating License Japanese on DVD

**6ES7810-4CC10-0JA5**

Upgrade Floating License  
Japanese 3.x/4.x/5.x to V5.5;  
on DVD

**6ES7810-4CC10-0JE5**

#### STEP 7 Version 5.5, Chinese

##### Target system:

SIMATIC S7-300/400, SIMATIC C7,  
SIMATIC WinAC

##### Requirements:

Windows XP Professional Chinese

##### Delivery package:

English, Chinese;  
incl. license key on USB stick,  
with electronic documentation

Floating License Chinese on DVD

**6ES7810-4CC10-0KA5**

Upgrade Floating License Chinese  
3.x/4.x/5.x to V5.5; on DVD

**6ES7810-4CC10-0KE5**

#### Documentation package STEP 7 basic information

Comprising Getting Started,  
hardware configuration manual,  
programming manual, migration  
manual

German

**6ES7810-4CA10-8AW0**

English

**6ES7810-4CA10-8BW0**

French

**6ES7810-4CA10-8CW0**

Spanish

**6ES7810-4CA10-8DW0**

Italian

**6ES7810-4CA10-8EW0**

#### STEP 7 reference manuals

Consisting of STL, LAD and FBD  
manuals as well as a reference  
manual for standard and system  
functions for SIMATIC S7-300/400

German

**6ES7810-4CA10-8AW1**

English

**6ES7810-4CA10-8BW1**

French

**6ES7810-4CA10-8CW1**

Spanish

**6ES7810-4CA10-8DW1**

Italian

**6ES7810-4CA10-8EW1**

#### SIMATIC Manual Collection

Electronic manuals on DVD,  
multilingual: LOGO!,  
SIMADYN,  
SIMATIC bus components,  
SIMATIC C7,  
SIMATIC distributed I/O,  
SIMATIC HMI,  
SIMATIC Sensors,  
SIMATIC NET,  
SIMATIC PC Based Automation,  
SIMATIC PCS 7,  
SIMATIC PG/PC,  
SIMATIC S7,  
SIMATIC Software, SIMATIC TDC

**6ES7998-8XC01-8YE0**

#### SIMATIC Manual Collection update service for 1 year

Current "Manual Collection" DVD  
and the three subsequent updates

**6ES7998-8XC01-8YE2**

#### EPROM programming device, USB prommer

For programming SIMATIC memory  
cards and EPROM modules

**6ES7792-0AA00-0XA0**

#### MPI cable

For linking SIMATIC S7 and PG  
through MPI (5 m)

**6ES7901-0BF00-0AA0**

#### Components for connecting a PC to MPI and PROFIBUS

For PCs with a free PCI slot:

##### • CP 5612

**6GK1561-2AA00**

##### • CP 5612 MPI

**6GK1561-2AM00**

incl. MPI cable (5 m)

For PCs with a free PCMCIA slot:

##### • CP 5512

**6GK1551-2AA00**

For Windows XP Professional

For PCs without a free PCI slot:

##### • USB A2 PC adapter

**6GK1571-0BA00-0AA0**

for connecting a PG/PC or  
Notebook to PROFIBUS or MPI;  
USB cable included in scope of  
delivery

#### Components for connecting the PC to Industrial Ethernet

For PCs with a free PCI slot:

##### • Layer 2 Ethernet cards

For PCs with a free PCMCIA slot:

##### • SOFTNET-IE RNA V7.1 (Win XP/Vista/Server2003)

**6GK1704-1PW71-3AA0**

##### • SOFTNET-IE RNA V8.1 (Win 7/server2008)

**6GK1704-1PW08-1AA0**

<sup>1)</sup> For up-to-date information and download availability, see:  
<http://www.siemens.com/tia-online-software-delivery>



## More information

### **Brochures**

Informative material for downloading can be found on the Internet:

<http://www.siemens.com/simatic/printmaterial>

### **Software download**

For up-to-date information and download availability, see:

<http://www.siemens.com/tia-online-software-delivery>

## PROFINET/Industrial Ethernet

### PROFINET Technology components

#### Enhanced Real-Time Ethernet Controller ERTEC

##### Overview

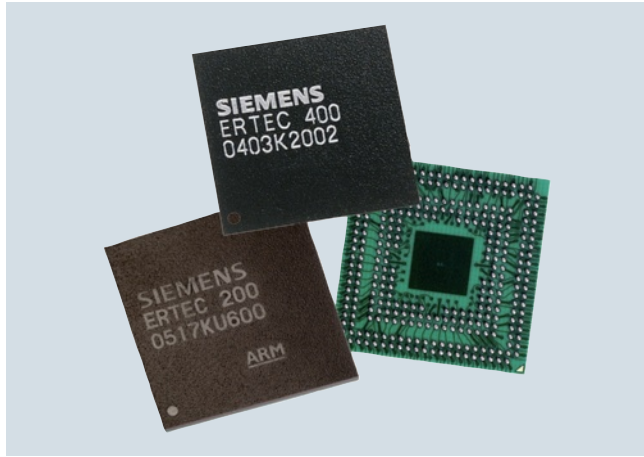

With the Industrial Ethernet ASICs of the ERTEC family (Enhanced Real-Time Ethernet Controller), devices and systems can be connected to PROFINET without great effort. The high-performance Ethernet controllers with 32-bit microprocessor as well as integral real-time switch for Real Time Ethernet have been specially developed for industrial use.

These Ethernet controllers handle all the data transmission for PROFINET with Real-Time (RT) and Isochronous Real-Time (IRT) and thus offload the application processor. Thanks to the integral 2-port switch (ERTEC 200 and ERTEC 200P) or 4-port switch (ERTEC 400), there are no costs for external switches. Flexible topologies such as star, tree and linear topologies can be implemented without any other external network components.

- **ERTEC 200P**  
with integral 2-port switch and maximum performance for compact and modular PROFINET field devices. The ERTEC 200P is designed for cycle times up to 31.25 µs. In conjunction with a high-speed ARM 926 CPU, it meets all the requirements for powerful PROFINET implementation.
- **ERTEC 200**  
with an integral 2-port switch for developing compact or modular PROFINET field devices.
- **ERTEC 400**  
with 4 integral ports and one integral PCI interface for developing network components and field devices with specific requirements regarding communication capabilities.

The EK-ERTEC 200P PN IO, DK-ERTEC 200 PN IO and DK-ERTEC 400 PN IO development kits enable the uncomplicated development of PROFINET field devices thanks to fast and simple integration of the PROFINET IO functionalities based on the ERTEC.

##### Benefits

- Full support for the PROFINET functionalities Real-Time (RT) and Isochronous Real-Time (IRT)
- Space-saving implementation thanks to the high degree of integration
- Complete communication processing for cyclic data transmission
- Wide application range thanks to extensive interfaces
- Openness due to compatibility with IEEE 802
- Industry-compatible environmental characteristics (RoHS compatibility)
- Unlimited support for IT communication and real-time data communication on the same medium.
- Powerful, integral ARM microprocessor
- No external network components necessary due to integration of switch in the device
- Integrated PHYs (for ERTEC200P and ERTEC 200)
- Technology benefits over standard Ethernet controllers due to the support for time-critical applications such as IRT
- Development support from the Siemens Competence Centers in Europe and the USA.

### Technical specifications

	ERTEC 400	ERTEC 200	ERTEC 200P
Transmission rate	10/100 Mbit/s	10/100 Mbit/s	100 Mbit/s
Interfaces			
• Ethernet / PHY interface	4 x PHY interface	2 x Ethernet interface (PHY integrated) or alternatively 2 x PHY interface (for connection of optical PHYs)	2 x Ethernet interface (PHY integrated) or alternatively 2 x PHY interface (for connection of optical PHYs)
- In connection with the corresponding PHY types:	• Half/full duplex Support for copper and fiber-optic cables; autosensing; autocrossover	• Half/full duplex Support for copper and fiber-optic cables (PHY for copper integrated); autosensing; autocrossover	Half/full duplex Support for copper and fiber-optic cables (PHY for copper integrated); autosensing; autocrossover
• Local Bus Unit (LBU)	Local bus master interface for connecting an external host with access to internal areas of the ERTEC; 16 bit data bit width	Local bus master interface for connecting an external host with access to internal areas of the ERTEC; 16 bit data bit width	XHIG (external host interface); 16/32 bit data bit width
• External memory interface (EMIF)			
- SDRAM controller	128 MB/16 bit or 256 MB/32 bit	64 MB/16 bit or 128 MB/32 bit	128 MB/16 bit or 256 MB/32 bit
- SRAM controller	4 x 16 MB for asynchronous blocks (SRAM, flash, I/O 8/16/32 bit)	4 x 16 MB for asynchronous blocks (SRAM, flash, I/O 8/16/32 bit)	4 x 16 MB for asynchronous blocks (SRAM, flash, I/O 8/16/32 bit)
- Chip-select support	yes	yes	yes
• IO interfaces	32 parameterizable I/O (GPIO); multifunctional outputs	45 parameterizable I/O (GPIO); multifunctional outputs	up to 96 parameterizable I/O (GPIO); multifunctional outputs
• Intelligent switching and PROFINET IRT prioritization/timing	yes	yes	yes
ARM processor			
• Integral ARM946 processor	32-bit ARM system	32-bit ARM system	32-bit ARM system
- Adjustable operating frequency	50/100/150 MHz	50/100/150 MHz	125/250 MHz
Supply voltage			
• Core (VDD Core)	1.5 V +/- 10 %	1.5 V +/- 10 %	1.2 V +5 %/-0.1 V
• I/Os (VDD IO)	3.3 V +/- 10 %	3.3 V +/- 10 %	3.3 V +5 %/-10 %
• External host interface (XHIF)	-	-	1.8 V +5 %/-10 %
• PHY	-	-	1.5 V +5 %/-10 %
• External host interface (XHIF)	-	-	1.8 V/3.3 V +5 %/-10 %
Perm. ambient conditions			
• Operating temperature	-40 °C to +85 °C	-40 °C to +85 °C	-40 °C to +85 °C
• Transport/storage temperature	-40 °C to +85 °C	-40 °C to +85 °C	-40 °C to +85 °C
• Relative humidity	Max. 95 % at +25 °C	Max. 95 % at +25 °C	Max. 95 % at +25 °C
Constructional design			
• Housing	Plastic FBGA 304 Pin	Plastic FBGA 304 Pin	Plastic FBGA 400 Pin
• Pinning Ball Pitch	0.8 mm	0.8 mm	0.8 mm
Dimensions (W x H x D) in mm	19 x 1 x 19	19 x 1 x 19	17 x 1 x 17
- ERTEC			
Supported communications protocols			
• General Ethernet protocols	In accordance with the respective software implementation that uses the ERTEC as Ethernet controller	In accordance with the respective software implementation that uses the ERTEC as Ethernet controller	In accordance with the respective software implementation that uses the ERTEC as Ethernet controller
• PROFINET in combination with a PROFINET Software Stack	Real-Time communication (RT); Isochronous Real-Time communication (IRT)	Real-Time communication (RT); Isochronous Real-Time communication (IRT)	Real-Time communication (RT); Isochronous Real-Time communication (IRT)

## PROFINET/Industrial Ethernet

### PROFINET Technology components

#### Enhanced Real-Time Ethernet Controller ERTEC

Ordering data	Article No.
<b>ERTEC 200P</b> ASIC for connection to Switched Ethernet 100 Mbit/s, Ethernet controller with integral 2-port switch, ARM 926 processor and integral PHYs <ul style="list-style-type: none"> <li>• 10 units (Evaluation Pack)</li> <li>• 90 units (individual tray)</li> <li>• 450 units (drypack, 5 trays)</li> </ul>	<b>6ES7195-0BH00-0XA0</b> <b>6ES7195-0BH10-0XA0</b> <b>6ES7195-0BH20-0XA0</b>
<b>Evaluation Kit EK-ERTEC 200P PN IO</b>	<b>6ES7195-3BE00-0YA0</b>
<b>ERTEC 200</b> ASIC ERTEC 200 for connection to Switched Ethernet 10/100 Mbit/s, Ethernet controller with integral 2-port switch, ARM 946 processor and integral PHYs <ul style="list-style-type: none"> <li>• 70 units (individual tray),</li> <li>• 350 units (drypack, 5 trays),</li> <li>• 3500 units (package, 10 drypacks)</li> </ul>	<b>6GK1182-0BB01-0AA1</b> <b>6GK1182-0BB01-0AA2</b> <b>6GK1182-0BB01-0AA3</b>
<b>Development Kit DK-ERTEC 200 PN IO</b>	<b>6GK1953-0BA00</b>
<b>ERTEC 200 PN IO Starter Kit</b>	<b>6ES7195-3BD00-0YA0</b>
<b>ERTEC 400</b> ASIC ERTEC 400 for connection to switched Ethernet 10/100 Mbit/s, Ethernet controller with integrated 4-port switch, ARM 946 RISC and PCI interface (V2.2), data preparation for real-time and isochrone real-time for PROFINET IO <ul style="list-style-type: none"> <li>• 70 units (individual tray),</li> <li>• 350 units (drypack, 5 trays),</li> </ul>	<b>6GK1184-0BB01-0AA1</b> <b>6GK1184-0BB01-0AA2</b>
<b>Development kit DK-ERTEC 400 PN IO</b>	<b>6GK1953-0CA00</b>

#### More information

You can find further information, technical data and manuals on the Enhanced Real-Time Ethernet Controller ERTEC on the Internet:

<http://www.siemens.com/ertec>

You can find more information on the Internet at:

<http://support.automation.siemens.com/WW/view/en/18977720/133300>

#### Support

The competent and experienced staff at the PROFINET Competence Centers in Europe and the U.S. offer free telephone advice as well as individual and agreed development and support on-site – from the initial information all the way to conclusion of the development with certification.

If you have any questions, your contact partner will be pleased to help:

#### Germany and Europe

Siemens AG  
 Communication, Development & Certification (ComDeC)  
 P.O. Box 2355  
 90713 Fürth  
 Tel.: +49 (911) 750-2080  
 Fax: +49 (911) 750-2100  
 E-mail: [comdec@siemens.com](mailto:comdec@siemens.com)

#### USA and International

PROFI Interface Center (PIC)  
 One Internet Plaza  
 PO Box 4991  
 Johnson City, TN 37604  
 Tel.: +1 (423) - 262 - 2687  
 Fax: +1 (423) - 262 - 2103  
 E-mail: [pic.industry@siemens.com](mailto:pic.industry@siemens.com)

### Overview



With the development packages for PROFINET, compact or modular PROFINET field devices can be developed quickly and with little effort. Depending on the application, different development packages are available.

The development packages for the ASICs of the ERTEC family (Enhanced Real-Time Ethernet Controller) are suitable for the development of field devices with an integrated IRT switch (Isochronous Real-Time). The demand for real-time capability, linear topology capability, and for IT integration is therefore met perfectly.

With the help of the development package for standard Ethernet controllers, PROFINET devices can be developed on the basis of a standard Ethernet controller. Devices with RT (Real-Time) can be implemented in the field device without special hardware.

The PROFI-safe StarterKit permits the implementation of fail-safe devices. In so doing, the PROFI-safe Stack applicatively builds on the PROFINET stack.

### Benefits

- Easy development of PROFINET field devices with Real-Time (RT) and Isochronous Real-Time (IRT).
- Perfectly matched hardware and software components.
- A quick start of the development thanks to the supplied software examples, documentation, and circuit diagrams.
- Easy creation of a specific GSD file thanks to the supplied example GSD file.
- Development boards as PN IO device test environment (only with ERTEC).
- Complete development environment contained in the scope of delivery, including a run-capable example application.
- Easy portability to any Ethernet controllers and real-time operating systems.

## PROFINET/Industrial Ethernet

### PROFINET Technology components

#### Development kits

Ordering data	Article No.
<b>ERTEC development kits</b>	
Evaluation Kit EK-ERTEC 200P PN IO	<b>6ES7195-3BE00-0YA0</b>
Development kit DK-ERTEC 200 PN IO	<b>6GK1953-0BA00</b>
Development kit DK-ERTEC 400 PN IO	<b>6GK1953-0CA00</b>
ERTEC 200 PN IO Starter Kit	<b>6ES7195-3BD00-0YA0</b>
Development kit for standard Ethernet controller	<b>6ES7195-3BC00-0YA0</b>
PROFIsafe starter kit V3.4	<b>6ES7195-3BF02-0YA0</b>
<b>ERTEC ASICs</b>	
<b>ERTEC 200P</b>	
ASIC for connection to Switched Ethernet 100 Mbit/s, Ethernet controller with integral 2-port switch, ARM 926 processor and integral PHYs	
<ul style="list-style-type: none"> <li>• 10 units (Evaluation Pack)</li> <li>• 90 units (individual tray)</li> <li>• 450 units (drypack, 5 trays)</li> </ul>	<b>6ES7195-0BH00-0XA0</b> <b>6ES7195-0BH10-0XA0</b> <b>6ES7195-0BH20-0XA0</b>
<b>ERTEC 200</b>	
ASIC ERTEC 200 for connection to Switched Ethernet 10/100 Mbit/s, Ethernet controller with integral 2-port switch, ARM 946 processor and integral PHYs	
<ul style="list-style-type: none"> <li>• 70 units (individual trays),</li> <li>• 350 units (drypack, 5 trays),</li> <li>• 3500 units (package, 10 drypacks)</li> </ul>	<b>6GK1182-0BB01-0AA1</b> <b>6GK1182-0BB01-0AA2</b> <b>6GK1182-0BB01-0AA3</b>
<b>ERTEC 400</b>	
ASIC ERTEC 400 for connection to Switched Ethernet 10/100 Mbit/s, Ethernet controller with integral 4-port switch, ARM 946 processor and PCI interface (V2.2)	
<ul style="list-style-type: none"> <li>• 70 units (individual trays),</li> <li>• 350 units (drypack, 5 trays),</li> </ul>	<b>6GK1184-0BB01-0AA1</b> <b>6GK1184-0BB01-0AA2</b>
<b>Accessories</b>	
PROFINET IO product line license for one product line	<b>6ES7195-3BC10-0YA0</b>

#### More information

You can find more detailed information, technical data, and manuals for ERTEC 200P, ERTEC 200, ERTEC 400, EK-ERTEC 200P, DK/SK-ERTEC 200 PN IO, DK-ERTEC 400 PN IO and DK Standard Ethernet Controller on the Internet:

<http://www.siemens.com/ertec>

You can find more information on the Internet at:

<http://support.automation.siemens.com/WW/view/en/18977720/133300>

#### **ERTEC 200 PN IO starter kit expansion option**

The supplied controller test partner SOFTNET PN IO is suitable for developing PROFINET IO Devices with RT thanks to its communication connection via a standard Ethernet interface on the developer PC.

For testing the IRT functionality, the controller test partner CP1616 is needed, article number: 6GK1161-6AA01.

When using the CP1616, the same evaluation options are available as on the DK-ERTEC 200 PN IO.

The necessary and released test software of the CP1616 must be received for successful evaluation with the CP1616. The necessary software components and documentation expansions are available free when you return the completed registration form of the ERTEC 200 PN IO starter kit as well as the delivery notes of the ERTEC 200 PN IO starter kit and CP1616.

The software is supplied by the Support Center ComDeC via a secure download connection following successful registration.

#### **Licensing**

All of the development packages contain a development license which authorizes the user to develop and test PROFINET devices on the basis of the stack provided.

For the production of series devices, one product line license must also be obtained for each product line under the Article No. 6ES7195-3BC10-0YA0.

For detailed information on the currently applicable licensing rules, contact our Competence Centers ComDeC and PIC.

#### **Support**

The competent and experienced staff at the PROFINET Competence Centers in Europe and the U.S. offer free telephone advice as well as individual and agreed development and support on-site – from the initial information all the way to conclusion of the development with certification.

If you have any questions, your contact partner will be pleased to help:

#### Germany and Europe

Siemens AG  
Communication, Development & Certification (ComDeC)  
P.O. Box 2355  
90713 Fürth  
Tel.: +49 (911) 750-2080  
Fax: +49 (911) 750-2100  
E-mail: [comdec@siemens.com](mailto:comdec@siemens.com)

#### USA and International

PROFI Interface Center (PIC)  
One Internet Plaza  
PO Box 4991  
Johnson City, TN 37604  
Tel.: +1 (423) - 262 - 2687  
Fax: +1 (423) - 262 - 2103  
E-mail: [pic.industry@siemens.com](mailto:pic.industry@siemens.com)

### Overview

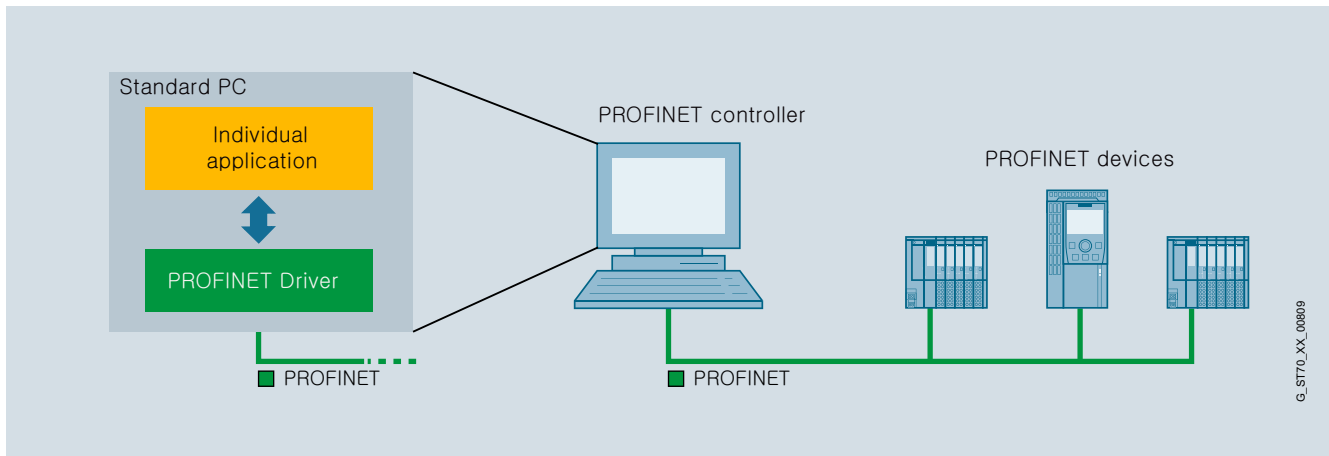

- For connecting distributed I/O and drives to user-specific control applications via PROFINET
- Operation of the control software on a standard PC using the standard Ethernet interface of the PC;
- Supplied as portable source code and can therefore be used with any operating system
- Sample application for Windows included in the scope of delivery; uses SIMATIC IPCs as example hardware

### Benefits

- Configuration via open XML interface, no engineering tool required (TIA Portal, STEP 7, etc.).
- Simplified handling when using the TIA Portal
- Operation on a standard PC using the standard Ethernet interface reduces costs and offers flexibility and performance benefits
- Delivery as portable source code enables use with different operating systems. This enables connection to a host of user-specific control programs.
- Supports PROFINET with Real-Time (RT)
- Cycle times up to 1 ms when using a real-time operating system

### Ordering data

#### PROFINET Driver

For connecting distributed I/O and drives to user-specific control applications via PROFINET

Development license

Runtime licenses

- 10 units
- 50 units
- 200 units
- 500 units

### Article No.

**6ES7195-3AA00-0YA0**

**6ES7195-3AA10-0XA0**

**6ES7195-3AA20-0XA0**

**6ES7195-3AA30-0XA0**

**6ES7195-3AA40-0XA0**

### More information

#### Support

The competent and experienced staff at the PROFINET Competence Centers in Europe and the U.S. offer free telephone advice as well as individual and agreed development and support on-site – from the initial information all the way to conclusion of the development with certification.

If you have any questions, your contact partner will be pleased to help:

#### Germany and Europe

Siemens AG  
Communication, Development & Certification (ComDeC)  
P.O. Box 2355  
90713 Fürth  
Tel.: +49 (911) 750-2080  
Fax: +49 (911) 750-2100  
E-mail: [comdec@siemens.com](mailto:comdec@siemens.com)

#### USA and International

PROFI Interface Center (PIC)  
One Internet Plaza  
PO Box 4991  
Johnson City, TN 37604  
Tel.: +1 (423) - 262 - 2687  
Fax: +1 (423) - 262 - 2103  
E-mail: [pic.industry@siemens.com](mailto:pic.industry@siemens.com)

## PROFINET/Industrial Ethernet Network transitions

### IE/PB Link PN IO

#### Overview



PN	DP-M	DP-S	ASI-M		
●	●				

- Compact network transition between Industrial Ethernet and PROFIBUS
- Connection to Industrial Ethernet with 10/100 Mbit/s full/half duplex connection with autosensing for automatic switchover
- Connection to PROFIBUS with 9.6 kbit/s to 12 Mbit/s incl. 45.45 kbit/s for PROFIBUS PA
- PROFINET IO proxy; connection of PROFIBUS DP slaves to PROFINET IO controller according to PROFINET standard:
  - From the viewpoint of the IO controller, all DP slaves are handled like I/O devices with Ethernet interface, i.e. the IE/PB Link PN IO is their proxy.
- Cross-network programming device/operator panel communication by S7 routing, i.e. all S7 stations can be remotely programmed by the programming device on the Industrial Ethernet or PROFIBUS.
- Cross-network access to data of S7 stations for visualization by means of S7 OPC server and S7 routing;
  - Via the IE/PB Link PN IO access can be made from the PC on the Industrial Ethernet (e.g. for HMI applications with OPC Client interface) by means of S7 OPC server, to all data of the S7 stations on the PROFIBUS.
- Module replacement without the need for a programming device, using the C-PLUG swap media for backing up the configuration data



### Benefits

get **Designed for Industry**

### PROFINET applications

- Protection of investment due to simple connection of PROFIBUS DP slaves to PROFINET IO controller
- Enables the use also in plants with PROFIsafe applications
- Independence from individual vendors through support of the PROFINET standard for distributed field devices

2

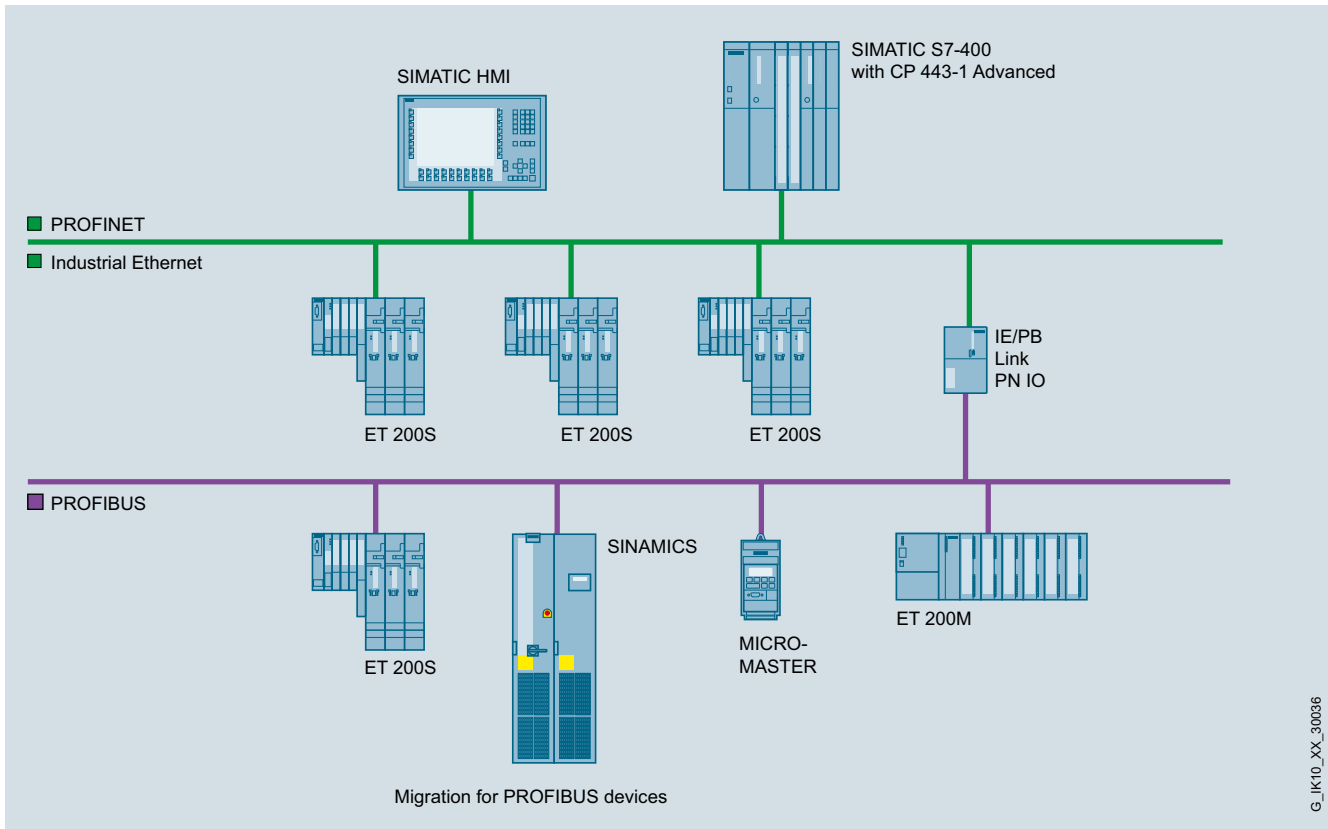

Configuration example of PROFIBUS and PROFINET:  
PROFIBUS devices can be seamlessly integrated into PROFINET over the IE/PB Link PN IO as proxy.

### Applications in the case of vertical integration

- Worldwide access to data of the PROFIBUS stations via Industrial Ethernet and Internet for vertical integration
- Optimization of a plant from a central location
- Access to process data from all enterprise levels
- Loading of STEP 7 programs from a central location

## PROFINET/Industrial Ethernet Network transitions

### IE/PB Link PN IO

#### Application

As an autonomous component, the IE/PB Link PN IO provides a seamless transition between Industrial Ethernet and PROFIBUS.

Using the IE/PB Link PN IO as a proxy, you can continue to use existing PROFIBUS devices (also with PROFI-safe functionality, V2.0 or higher) and integrate them into a PROFINET application.

The IE/PB Link PN IO also offers the following functions:

- S7 routing
  - permits cross-network PG/OP communication, in other words, all S7 stations on Industrial Ethernet or PROFIBUS can be programmed remotely using the programming device
  - Access can be made to visualization data of the S7 stations on the PROFIBUS from HMI stations on the Industrial Ethernet.
- Data record routing (PROFIBUS DP)
  - It is possible, for example, to use SIMATIC PDM (on the PC) on Industrial Ethernet to parameterize and diagnose a PROFIBUS field device via the IE/PB Link PN IO.

#### Design

The IE/PB Link PN IO exhibits all the advantages of the SIMATIC design:

- Compact design; the rugged plastic casing features on the front:
  - one RJ45 port for connection to Industrial Ethernet.
  - one 9-pin Sub-D socket for connection to PROFIBUS
  - one 2-pin terminal strip for connecting the external supply voltage of 24 V DC.
  - Diagnostic LEDs
- Connection is by means of the IE FC RJ45 Plug 180 with 180° cable exit or by means of a standard patch cable
- Simple mounting; the IE/PB Link PN IO is mounted on an S7-300 DIN rail.
- Can be operated without a fan
- Fast device replacement in the event of a fault by using the optional C-PLUG swap medium (not included in scope of supply)

#### Function

##### PROFINET

- PROFINET IO proxy; connection of PROFIBUS DP slaves to PROFINET IO controller with real-time property, according to PROFINET standard

##### Additional functionality for vertical integration

- S7 routing
    - permits cross-network PG communication, in other words, all S7 stations on Industrial Ethernet or PROFIBUS can be programmed remotely using the programming device.
    - Access can be made to visualization data of S7 stations on the PROFIBUS from HMI stations on the Industrial Ethernet.
  - Data record routing (PROFIBUS DP)
    - Using this option, the IE/PB Link PN IO can be used as a router for data records that are forwarded to field devices (DP slaves). SIMATIC PDM (Process Device Manager) is a tool that creates data sets of this type for parameterizing and diagnosing field devices.
- Application:  
It is possible, for example, to use SIMATIC PDM (on the PC) on Industrial Ethernet to set parameters and run diagnostics for PROFIBUS PA field device over the IE/PB Link PN IO and DP/PA coupler.

The additional functions for vertical integration can also be used in an existing PROFIBUS application without PROFINET for connection to a higher-level Industrial Ethernet.

In this case, the IE/PB Link PN IO is used as an additional DP-Master Class 2 on a PROFIBUS segment for linking to the Industrial Ethernet and offers the above functions.

##### Diagnosis

Extensive diagnostic options are available via STEP 7 or SNMP, including:

- Diagnosis of the assigned PROFIBUS field devices; using the IE/PB Link PN IO as a proxy, the connected DP slaves can be diagnosed in the same manner as PROFINET IO devices (even in the user program of the PROFINET IO controller)
- General diagnostics and statistics functions
- Connection diagnostics
- Diagnostic buffer
- Integration into network management systems through the support of SNMP V1 MIB-II

##### Configuration

STEP 7 V5.4 or higher or the TIA Portal V11.0 is required for configuring the full functional scope of the IE/PB Link PN IO.

For the IE/PB Link PN IO, STEP 7 automatically generates the necessary parameters, e.g. the ones that assign addresses, and all necessary routing information.

The configuration data for PROFINET IO created with STEP 7 is saved on the IO controller. Attention must however be paid to the memory capacity. The initialization data for the Ethernet interface is backed up on the C-PLUG (Configuration Plug) swap media. The IE/PB Link PN IO can be swapped in the event of failure without a programming device, because the relevant user and configuration data is saved on the IO controller or on the C-PLUG.

### Technical specifications

Article No.	<b>6GK1411-5AB00</b>
Product-type designation	<b>IE/PB Link PN IO</b>
Data transmission rates	
• Industrial Ethernet	10/100 Mbit/s autosensing
• PROFIBUS	9.6 kbit/s to 12 Mbit/s incl. 45.45 kbit/s (PROFIBUS PA)
Interfaces	
• Connection to Industrial Ethernet	
- 10BaseT/100BaseT	RJ45
• Connection to PROFIBUS	9-pin Sub-D socket
• Connection for power supply	2-pin terminal block
Voltage supply	24 V DC (+/-5 %)
Current consumption (at rated voltage)	
• external from 24 V DC, max.	600 mA
Power loss	approx. 10 W
Perm. ambient conditions	
• Operating temperature	0 °C ... + 60 °C
• Transport/storage temperature	- 40 °C ... + 70 °C
• Relative humidity, max.	95 % at +25 °C
Design	
• Module format	S7-300 construction
• Dimensions (W x H x D) in mm	80 x 125 x 120
• Weight	approx. 600 g
Degree of protection	IP20
Configuration	
Configuration software for PROFINET and additional functions	STEP 7/NCM S7, V5.3 SP1 or higher
<b>Performance data</b>	
<b>PROFINET communication</b>	
PROFINET IO performance data	
• Number of DP slaves on the IE/PB Link PN IO (PROFINET IO-Devices for PROFINET IO)	64
• Number of DP inputs, max.	2048 byte
• Number of DP outputs, max.	2048 byte
Additional functionality	
• Number of S7 connections	max. 32
• Number of DSGW connections	max. 32

### Ordering data

### Article No.

<b>IE/PB Link PN IO</b>	<b>6GK1411-5AB00</b>
Network transition between Industrial Ethernet and PROFIBUS with PROFINET IO functionality, TCP/IP, S7 routing and data record routing, 10/100 Mbit/s Fast Ethernet, 9.6 to 12 Mbit/s PROFIBUS; including electronic manual on CD-ROM German, English, French, Spanish, Italian	
<b>IE FC TP Standard Cable GP 2 x 2 (Type A)</b>	<b>6XV1840-2AH10</b>
4-core, shielded TP installation cable for connection to IE FC Outlet RJ45/IE FC RJ45 Plug; PROFINET-compliant; with UL approval <b>Sold by the meter</b> max. length 1 000 m minimum order 20 m	
<b>IE FC RJ45 Plug 180</b>	
RJ45 plug connector for Industrial Ethernet with a rugged metal enclosure and integrated insulation displacement contacts for connecting Industrial Ethernet FC installation cables; with 180° cable outlet; for network components and CPs/CPUs with Industrial Ethernet interface	
• 1 pack = 1 unit	<b>6GK1901-1BB10-2AA0</b>
• 1 pack = 10 units	<b>6GK1901-1BB10-2AB0</b>
• 1 pack = 50 units	<b>6GK1901-1BB10-2AE0</b>
<b>IE FC Stripping Tool</b>	<b>6GK1901-1GA00</b>
Preadjusted stripping tool for fast stripping of the Industrial Ethernet FC cables	
<b>CSM 377 Compact Switch Module</b>	<b>6GK7377-1AA00-0AA0</b>
Unmanaged switch for connection of a SIMATIC S7-300-CPU, ET 200M and up to three further nodes to Industrial Ethernet operating at 10/100 Mbit/s; 4 x RJ45 ports; external 24 V DC power supply, LED diagnostics, S7-300 module including electronic manual on CD-ROM	
<b>C-PLUG</b>	<b>6GK1900-0AB00</b>
Swap medium for simple replacement of devices in the event of a fault; for storing configuration or engineering and application data; can be used for SIMATIC NET products with C-PLUG slot	

## PROFINET/Industrial Ethernet

### Network transitions

#### IE/PB Link PN IO

Ordering data	Article No.	Article No.
<b>PROFIBUS FC Standard Cable GP</b> Standard type with special design for fast mounting, 2-core, shielded	<b>6XV1830-0EH10</b>	<b>STEP 7 Professional V12 Engineering Software</b>  <i>Target system:</i> SIMATIC S7-1200, S7-1500, S7-300, S7-400, WinAC <i>Requirement:</i> Windows XP Home SP3 (STEP 7 Basic only), Windows XP Professional SP3 (32 bit), Windows 7 Home Premium SP1 (STEP 7 Basic only), Windows 7 Professional SP1 (32/64 bit), Windows 7 Enterprise SP1 (32/64 bit), Windows 7 Ultimate SP1 (32/64 bit), Microsoft Server 2003 R2 Std. SP2 (32 bit), Microsoft Server 2008 Std. SP2 (32/64 bit) <i>Form of delivery:</i> German, English, Chinese, Italian, French, Spanish  <i>for CP 1543-1, CP 343-1 Lean, CP 343-1, CP 343-1 Advanced, CP 343-1 ERPC, CP 443-1, CP 443-1 Advanced</i> <ul style="list-style-type: none"> <li>STEP 7 Professional V12, Floating License</li> <li>STEP 7 Professional V12, Trial License</li> <li>Upgrade STEP 7 Professional V11 to STEP 7 Professional V12, Floating License</li> <li>Upgrade STEP 7 Professional 2006/2010 to STEP 7 Professional V12, Floating License</li> <li>PowerPack &amp; upgrade from STEP 7 V5.4/V5.5 to STEP 7 Professional V12, Floating License</li> <li>PowerPack STEP 7 Basic V12 to STEP 7 Professional V12, Floating License</li> </ul>
<b>PROFIBUS FastConnect bus connector RS 485 Plug 180</b> With insulation displacement terminals, with 180° cable outlet, for industrial PC, SIMATIC HMI OP, OLM; max. transmission rate 12 Mbit/s	<b>6GK1500-0FC10</b>	
<b>PROFIBUS FastConnect Stripping Tool</b> Preadjusted stripping tool for fast stripping of PROFIBUS FastConnect bus cables	<b>6GK1905-6AA00</b>	
<b>S7-300 mounting rail</b>	<b>6ES7390-1AB60-0AA0</b>	
<b>S7-300 PS 307 load power supply</b> 24 V DC	<b>6ES7307-1BA01-0AA0</b>	
<b>STEP 7 Version 5.5</b> <i>Target system:</i> SIMATIC S7-300/-400, SIMATIC C7, SIMATIC WinAC <i>Requirements:</i> Windows XP Prof., Windows 7 Professional/Ultimate <i>Type of delivery:</i> German, English, French, Spanish, Italian Including license key on USB stick, with electronic documentation  <i>for CP 343-1 Lean, CP 343-1, CP 343-1 Advanced, CP 343-1 ERPC, CP 443-1, CP 443-1 Advanced, CP 443-1 RNA</i> <ul style="list-style-type: none"> <li>Floating License on DVD</li> <li>Rental License for 50 hours</li> <li>Software Update Service on DVD (requires current software version)</li> <li>Upgrade Floating License 3.x/4.x/5.x to V5.5; on DVD</li> <li>Trial License STEP 7 V5.5; on DVD, 14 day trial</li> </ul>	<b>6ES7810-4CC10-0YA5</b> <b>6ES7810-4CC10-0YA6</b> <b>6ES7810-4BC01-0YX2</b>  <b>6ES7810-4CC10-0YE5</b>  <b>6ES7810-4CC10-0YA7</b>	

Ordering data	Article No.	Article No.
<p><b>STEP 7 Professional Engineering Software V12; software download incl. license key 2</b></p> <p>E-mail address required for the delivery</p> <ul style="list-style-type: none"> <li>• STEP 7 Professional V12, Floating License</li> <li>• STEP 7 Professional V12, Trial License;</li> <li>• Upgrade STEP 7 Professional V11 to STEP 7 Professional V12, Floating License</li> <li>• Upgrade STEP 7 Professional 2006/2010 to STEP 7 Professional V12, Floating License</li> <li>• PowerPack &amp; upgrade from STEP 7 V5.4/V5.5 to STEP 7 Professional V12, Floating License</li> <li>• PowerPack STEP 7 Basic V12 to STEP 7 Professional V12, Floating License</li> </ul>	<p><b>6ES7822-1AE02-0YA5</b></p> <p><b>6ES7822-1AE02-0YA7</b></p> <p><b>6ES7822-1AE02-0YE5</b></p> <p><b>6ES7822-1AE02-0XE5</b></p> <p><b>6ES7822-1AE02-0XC5</b></p> <p><b>6ES7822-1AE02-0YC</b></p>	<p><b>STEP 7 Professional Engineering Software V13</b></p> <p><i>Target system:</i> SIMATIC S7-300/-400, SIMATIC S7-1200/1500, SIMATIC C7, SIMATIC WinAC</p> <p><i>Requirement:</i> Windows 7 Professional (32 bit) Windows 7 Enterprise (32 bit) Windows 7 Ultimate (32 bit) Microsoft Server 2003 R2 Std. SP2 (32 bit) Microsoft Server 2008 Std. SP2 (32 bit)</p> <p><i>Form of delivery:</i> German, English, Chinese, Italian, French, Spanish</p> <p><i>for CP 1243-1, CP 1543-1, CM 1542-1, CP 343-1 Lean, CP 343-1, CP 343-1 Advanced, CP 343-1 ERPC, CP 443-1, CP 443-1 Advanced</i></p> <ul style="list-style-type: none"> <li>• STEP 7 Professional V13, Floating License</li> <li>• STEP 7 Professional V13, Trial License</li> <li>• Upgrade STEP 7 Professional 2006/2010 to STEP 7 Professional V13, Floating License</li> <li>• PowerPack &amp; upgrade STEP 7 V5.4/V5.5 to STEP 7 Professional V13, Floating License</li> <li>• PowerPack STEP 7 Basic V13 to STEP 7 Professional V13, Floating License</li> <li>• STEP 7 Professional V13, Software Update Service, 1 year; current software version required</li> <li>• STEP 7 Professional V13, Software Update Service Compact, 1 year; current software version required</li> <li>• STEP 7 Professional Software Update Service; 1 year; for STEP 7 Professional and STEP 7 Professional in the TIA Portal, requires current software version</li> <li>• STEP 7 Professional Software Update Service Compact; 1 year; for STEP 7 Professional and STEP 7 Professional in the TIA Portal, requires current software version</li> </ul>
		<p><b>6ES7822-...</b></p> <p><b>6ES7822-...</b></p> <p><b>6ES7822-...</b></p> <p><b>6ES7822-...</b></p> <p><b>6ES7822-...</b></p> <p><b>6ES7822-...</b></p> <p><b>6ES7822-...</b></p> <p><b>6ES7810-...</b></p> <p><b>6ES7810-...</b></p>

**More information**
<http://www.siemens.com/profinet>

## PROFINET/Industrial Ethernet

### Industrial Network Services

#### Network validation and monitoring

##### Overview

##### Network validation and monitoring

Siemens Industry Services offers network validation and network monitoring services based on reaction-free hardware and the corresponding software for validation, continuous monitoring and diagnosis of the network status.

##### Network validation

Validation ensures the operational reliability of the fieldbus systems by checking all of the relevant parameters in great detail. Siemens Industry Services offers a service for testing plant networks for compliance with network standards and for increasing the availability and reliability of the plant through regular validation. This is done on site, after setting up the plant on the end customer's premises. On request, also in close collaboration with the OEM.

Scope of services:

- Creation of an overview of networks and components
- Checking the components used and the engineering against the specifications of the PI, requirement specification and customer references
- Visual and mechanical checks on the hardware
- Checking the physical network structure
- PROFINET compatibility of the network structure (offline and online)
- Checking the data communication (failures, cycle times, CRC errors, etc.)
- PROFI-safe compatibility (optional)
- Measurements of the PROFINET copper / FOC (optional) cabling
- Checking the MRP functionality (Media Redundancy Protocol)
- Report complete with the optimization potential discovered for the network under investigation

##### Network monitoring

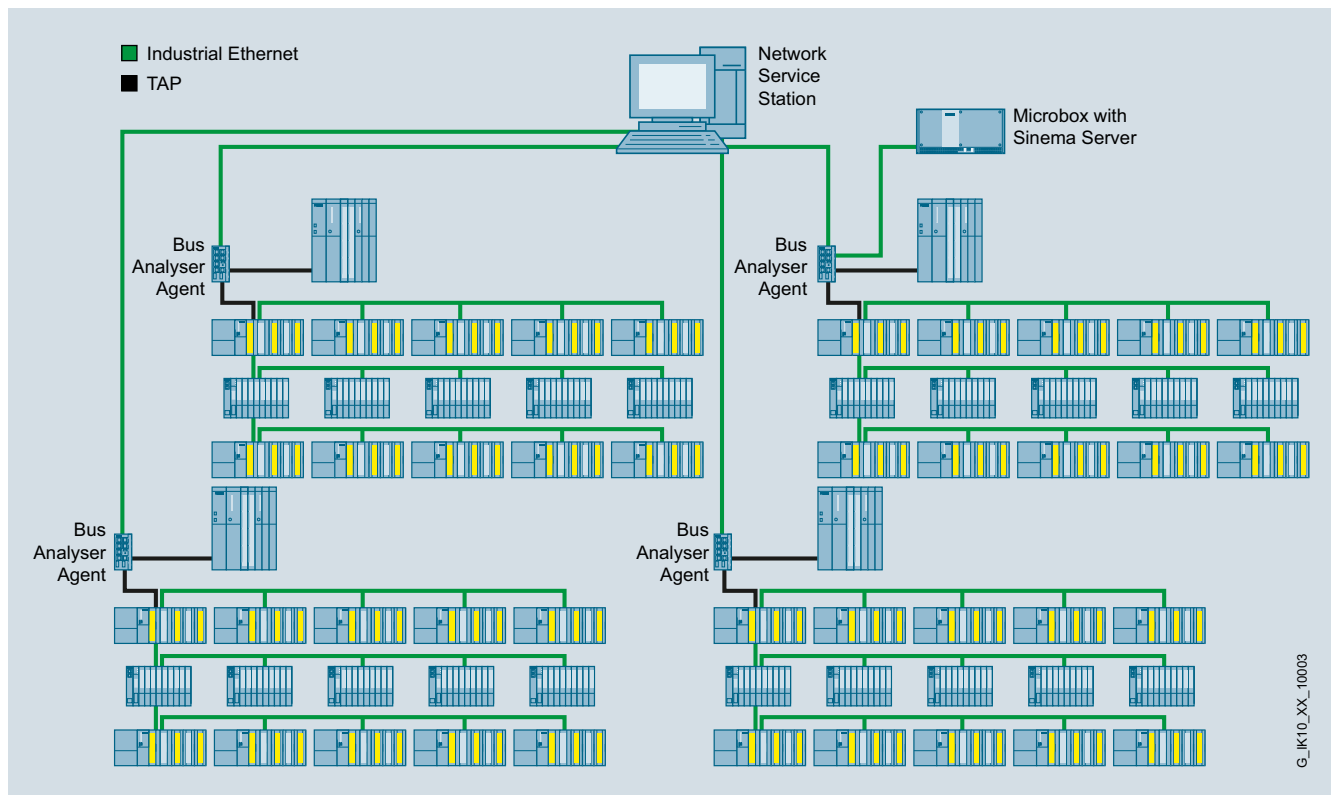

Network monitoring with bus analyzer

### Overview (continued)

Siemens Industry Services offers you the bus analyzer agent analysis hardware for your existing network. Using the associated software, you can monitor your system at the message frame level, scan data in real time and integrate it into pre-existing software. In order to allow the administration and data analysis of several agents distributed throughout the network, the "Network Service Station" platform solution is additionally available. This allows you to clearly process your data, output alarms in the event of errors, and integrate them into your process visualization system (e.g. WinCC, PCS 7). The integrated, fully programmable Reporting function guarantees that a summary of the key parameters is presented to you in a clear form. An open and scalable module system allows individual adaptation of the service station to all network sizes and topological forms. If necessary, Siemens Industry Service experts will support you in assembling the right combination for you, and in designing your own reports and the analysis of error messages.

Scope of services:

- Monitoring of PROFINET (status, events, cycle time, jitter, sporadic errors, etc.)
- Monitoring of Industrial Ethernet (port status, load, etc.)
- Data acquisition in real time with the bus analyzer agent (hardware)
- Network diagnostics in real time
- Network monitoring
- Backup and restoring of switch configurations
- Firmware update for selected network components
- WinCC / PCS 7 integration
- Reporting
- Remote access and support (optional extra, on request)
- Implementation and installation support (optional extra, on request)

### Ordering data

### Article No.

<b>PROFINET validation package, basic</b> For a maximum of 2 networks	<b>9AE4100-4BD30</b>
<b>PROFINET validation package, standard</b> For a maximum of 5 networks	<b>9AE4100-4BD40</b>
<b>PROFINET validation package, extended</b> For a maximum of 10 networks	<b>9AE4100-4BD50</b>
<b>PROFINET validation package, maximum</b> For a maximum of 20 networks	<b>9AE4100-4BD60</b>
<b>Bus analyzer hardware agent for 2 channels without TAP</b> For PROFINET diagnosis (100 Mbit) of 2 fieldbuses or Ethernet diagnosis (up to 1 Gbit) of 2 network segments	<b>9AE4140-1BA00</b>
<b>Bus analyzer hardware agent for 2 channels with TAP</b> For reaction-free PROFINET diagnosis of 2 fieldbuses	<b>9AE4140-1BA01</b>
<b>Network Service Station – STANDARD</b> NSS standard software for continuous monitoring and reporting of PROFINET fieldbuses (BANY Agent required). Includes license for 50 devices and connection of an operating client.	<b>9AE4110-1SA00</b>
<b>Network Service Station – ADVANCED</b> Standard functional scope plus the monitoring of Ethernet networks, switch management, port monitoring and long-term archive. Includes license for 50 nodes and connection of an operating client.	<b>9AE4110-1SB00</b>
<b>Network Service Station – ADVANCED + Bus Analyzer</b> Hardware agent with 2-channel TAP incl. NSS, for reaction-free PROFINET diagnosis of 2 fieldbuses, only available within the framework of service contracts	<b>9AE4140-1BA10</b>
<b>Network Service Station – OPERATING CLIENT</b> Expansion license for connecting an additional operating client to the Network Service Station	<b>9AE4110-1SY00</b>
<b>Network Service Station – POWERPACK</b> Expansion license for connecting an additional 50 devices to the Network Service Station	<b>9AE4110-1SX00</b>

## PROFINET/Industrial Ethernet Partner solutions

### deviceWISE Embedded Edition for SIMATIC S7

#### Overview

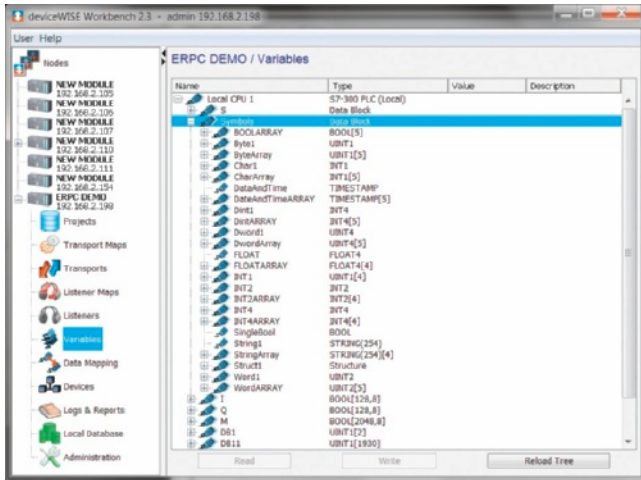

- deviceWISE Embedded for S7 is a software package that can be loaded into the CP 343-1 ERP communications processor as a firmware extension
- It facilitates intelligent and direct communication from the S7-300 to IT applications at the management level (e.g. databases)
- No programming is required in SIMATIC

#### Benefits

- High-speed integration of machine controllers into IT applications, e.g. reading or writing to databases by means of parameterization without any programming effort in the S7-300
- Reliable delivery of critical process data by means of store & forward functionality as well as in-built local database.
- Complex preprocessing of data in the PLC with numerous trigger options
- Supports standard protocols such as OPC UA or XML-DA directly from the PLC

#### Application

deviceWISE Embedded for S7 offers the database interface of the SIMATIC S7 with CP 343-1 ERP to various ERP or MES systems for vertical integration.

##### Database communication

deviceWISE Embedded for S7 establishes direct connections from the PLC to the leading database systems. The user can perform a host of operations on the linked databases, such as:

- Documentation of production data in the database
- Updating of existing entries, e.g. recording and saving new data as the production of a component progresses
- Retrieval of data from the database, e.g. recipes or configuration data for the current production

##### Message-queue communication

The software enables the user to communicate directly with the Enterprise Service Bus (ESB) and transfer data from the controller to applications in the enterprise IT system. Messages can be sent and received in ASCII or XML. User-specific data formats can also be defined.

##### Device communication

deviceWISE Embedded for S7 is used predominantly for communication with enterprise applications. In addition, the software can establish connections to other automation devices and transfer data from other PLC systems, RFID readers, or cameras into the data area of the S7-CPU. This is done via the backplane bus and enables flexible mapping of data from the widest variety of devices into the data blocks of the PLC.



## Function

The deviceWISE Embedded for S7 software includes a user-friendly tool – the workbench – for the configuration and management of data.

This enables one or more deviceWISE modules to be addressed without any programming overhead.

The workbench offers a wide range of drag & drop mechanisms and enables trigger conditions to be defined. This significantly reduces the possibilities of errors when entering addresses or field names. In addition, it is possible in the workbench to process raw data into useful information and transport it from programmable controllers to databases or message queues in the IT environment of an enterprise.

deviceWISE Embedded for S7 offers the following functions:

### Direct connection to the following SQL databases:

- IBM DB2
- IBM DB2/400 (for OS/400 systems)
- PostgreSQL Database
- Bea Weblogic
- Oracle
- Oracle Manufacturing Operations Center
- Microsoft SQL Server
- MySQL

### Direct connection to the following messaging systems:

- IBM Websphere MQ
- IBM MQTT
- IBM SIB/JMS
- TCP

### Extensive preprocessing of the data

Using deviceWISE Embedded for S7, extensive preprocessing of data (e.g. mathematical operations, flow diagram processing), the use of a local SQL database, and an in-built FTP server/client functionality are possible.

### Error handling and correction by means of:

- Store and forward for all enterprise transactions
- E-mail notification in the event of faults
- Fault signaling to the PLC

### Direct connection to other terminals

deviceWISE Embedded for S7 allows the direct connection of the CP 343-1 ERPC communications processor to the following terminals:

- PLC systems (Siemens, Rockwell, Mitsubishi, Omron)
- Camera systems
- RFID readers

In addition, open-standard protocols such as Modbus TCP, OPC UA or XML-DA are supported.

## More information

The software is available at:

ILS Technology LLC;  
 5300 Broken Sound Blvd.  
 Suite 150  
 Boca Raton, FL, U.S.A., 33487

Phone: +1-561-982-9898 x124  
 Fax.: +1-561-982-8638

E-mail: [devicewise@ilstechnology.com](mailto:devicewise@ilstechnology.com)

You can find further information in the Internet at:  
<http://www.ilstechnology.com/erpc>

## PROFINET/Industrial Ethernet

### Notes

2



<b>3/4</b>	<b>Introduction</b>	<b>3/88</b>	<b>Optical networks with OLM</b>
3/5	Process or field communication	3/88	Overview of FC-FOCs
3/9	Data communication	3/90	FC glass fiber-optic cables
3/11	Communication overview	3/95	FC FO termination kit
3/13	Topologies	3/96	Glass fiber-optic cable
<b>3/15</b>	<b>Network components</b>	3/111	Plastic and PCF fiber-optic cable
3/15	Overview of network components	3/118	PCF-FOC termination kit
3/17	Network selection criteria	3/121	OLM Optical Link Module
3/20	Connection examples	<b>3/134</b>	<b>Optical networks with OBT and integrated interface</b>
<b>3/22</b>	<b>Electrical networks (RS 485)</b>	3/134	Plastic and PCF fiber-optic cable
3/22	PROFIBUS FastConnect	3/140	PCF-FOC termination kit
3/24	PROFIBUS bus cables	3/143	Optical bus terminal OBT
3/35	ECOFAS <sup>T</sup> bus cables	<b>3/146</b>	<b>System interfaces for SIMATIC S7</b>
3/40	Hybrid fieldbus connections	3/146	Introduction
3/42	Energy cables	3/148	<u>Communication for SIMATIC S7-1200</u>
3/47	RS485 bus connector	3/148	CM 1242-5
3/52	830-1T connecting cable	3/148	CM 1243-5
3/53	830-2 connecting cable	3/152	CM 1243-5
3/54	PROFIBUS M12 and 7/8" connecting cable/connector	3/156	<u>Communication for SIMATIC S7-1500</u>
3/61	Bus terminals	3/156	CM 1542-5
3/64	Active RS 485 terminating element	3/161	CP 1542-5
3/65	Repeater RS 485 for PROFIBUS	3/165	<u>Communication for SIMATIC S7-300</u>
3/67	Diagnostics repeater for PROFIBUS DP	3/165	CP 342-5
<b>3/70</b>	<b>Electrical networks (PROFIBUS PA)</b>	3/169	CP 342-5 FO
3/70	Introduction	3/173	<u>Communication for SIMATIC S7-400</u>
3/73	SpliTConnect	3/173	CP 443-5 Extended
3/77	Bus cables	3/178	Communication for SIMATIC S7 – software
3/80	Active field distributors		
<b>3/85</b>	<b>Electrical networks (FOUNDATION Fieldbus)</b>		
3/85	Bus cables		

# PROFIBUS

## 3/179 System interfaces for PG/PC/IPC

- 3/179 Overview
- 3/180 Communication for PC-based systems
- 3/180 Performance data
- 3/181 Connection options to SIMATIC PCs
- 3/182 CP 5603
- 3/187 CP 5613 A3
- 3/191 CP 5614 A3
- 3/196 CP 5623
- 3/201 CP 5624
- 3/206 CP 5612
- 3/210 CP 5622
- 3/214 CP 5711
- 3/219 SOFTNET for PROFIBUS
- 3/222 OPC server for PROFIBUS
- 3/225 S7 OPC Redundancy for PROFIBUS
- 3/227 Software
- 3/229 PC adapter USB A2

## 3/231 System interfaces for SIMATIC HMI

- 3/231 System interfaces with WinCC (TIA Portal)
- 3/232 SIMATIC S7
- 3/234 SIMATIC WinCC (TIA Portal) Runtime
- 3/235 WinCC Runtime Communication
- 3/238 System interfaces with WinCC flexible
- 3/238 SIMATIC WinCC flexible RT
- 3/243 System interfaces with WinCC
- 3/243 SIMATIC WinCC

## 3/255 Network transitions

- Ch. 2 IE/PB Link PN IO
- 3/255 DP/DP coupler
- 3/256 PA routers
- Ch. 4 DP/AS-i LINK Advanced
- Ch. 4 DP/AS-Interface Link 20E
- Ch. 4 DP/AS-i F-Link

## 3/261 Industrial Controls

- 3/261 Soft Starters
- 3/261 3RW44 soft starters for High-Feature applications
- 3/263 Software
- 3/263 – Soft Starter ES
- 3/267 – SIRIUS 3RW44 Soft Starter block library for SIMATIC PCS 7
- 3/270 Motor starters for use in the field, high degree of protection
- 3/270 M200D motor starters for PROFIBUS
- 3/273 – Communication module, motor starter modules
- 3/274 – Accessories
- 3/276 Software
- 3/276 – Motor Starter ES
- 3/280 – SIRIUS motor starter block library for SIMATIC PCS 7
- 3/282 SIMOCODE 3UF Motor Management and Control Devices
- 3/282 SIMOCODE pro 3UF
- 3/282 – General data
- 3/288 – Basic units
- 3/290 – Expansion modules
- 3/292 – Fail-safe expansion modules
- 3/293 – Accessories
- 3/300 3UF18 current transformers for overload protection
- 3/301 SIRIUS 3RK3 Modular Safety System
- 3/301 General data
- 3/306 3RK31 central units
- 3/307 3RK32/33 expansion modules, 3RK35 interface modules, 3RK36 operating and monitoring modules
- 3/308 Accessories

**3/310 Switching and Protection Devices for Power Distribution**

3/310 SENTRON Communication-Capable Circuit Breakers

3/311 Power Monitoring

3/311 PC-based Power Monitoring System

3/314 SIMATIC-based Power Data Management System

3/316 SENTRON Measuring Devices

3/316 7KM PAC3200 Measuring Devices

3/318 7KM PAC4200 Measuring Devices

3/320 7KM PAC Switched Ethernet PROFINET Expansion Module

3/321 7KM PAC PROFIBUS DP Expansion Module

3/322 7KM PAC RS485 Expansion Module

3/323 7KM PAC 4DI/2DO Expansion Module for PAC4200

3/324 Configuring, Visualizing and Controlling with SIMATIC

3/324 Library 7KM PAC3200 for SIMATIC PCS

3/325 Library 3WL/3VL for SIMATIC PCS 7

3/326 Library 7KM PAC3200 for SIMATIC WinCC

3/327 Configuring, Visualizing and Controlling with SENTRON

3/327 powermanager

3/331 powerconfig

**3/333 Industrial Identification Systems**

3/333 ASM 456, SIMATIC RF160C

**3/338 Engineering/Network Management/Diagnostics**

Ch. 2 STEP 7 Professional/Basic V13 (TIA Portal)

Ch. 2 STEP 7

3/338 SIMATIC PDM

**3/351 PROFIBUS Components**

3/351 PROFIBUS DP ASICs

3/354 Connections/interfaces

3/355 Development kits

# PROFIBUS

## Introduction

### Introduction

#### Overview

- Bus system
  - for process and field communication with field devices from different manufacturers
  - and for data communication acc. to IEC 61158/61784
- PROFIBUS – the fieldbus standard in production and process engineering comprises:
  - Specification of the standards for the physical characteristics of the bus and the access procedure
  - Specification of the user protocol and the user interface
- Offers openness for interfacing to standardized non-Siemens components
- Process or field communication
  - PROFIBUS DP for fast, cyclic data exchange with field devices
  - PROFIBUS PA for applications in process automation and in the intrinsically safe area
- Data communication
  - PROFIBUS FMS for data communication between programmable controllers of different manufacturers

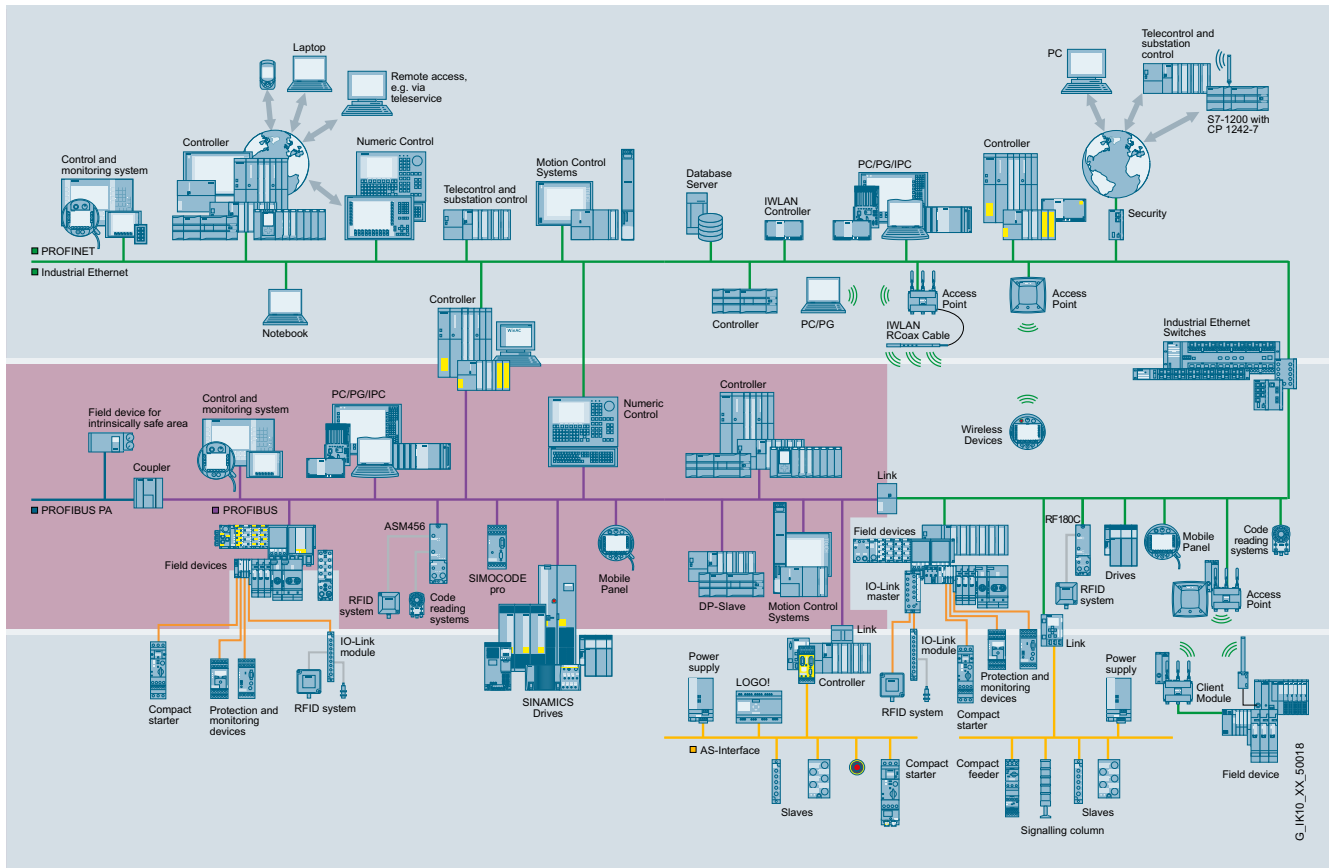

PROFIBUS in the communication landscape

#### Benefits

- get** Designed for Industry
- PROFIBUS is a powerful, open, and rugged bus system that ensures trouble-free communication.
  - The system is fully standardized, which enables trouble-free connection of standardized components from a variety of manufacturers.
  - Configuration, commissioning, and troubleshooting can be carried out from any location. This results in user-defined communication relationships that are very versatile, simple to implement, and easy to change.
  - Fast assembly and commissioning on site with the help of the FastConnect wiring system.
  - Continuous monitoring of network components through a simple and effective signaling concept.
  - High security of investment since existing networks can be extended without any adverse effects.
  - High availability through ring redundancy with OLM.

#### More information

Please always note the supplementary conditions for the specified SIMATIC NET products (order numbers 6GK..., 6XV1...), which you can view on the Internet pages below:

<http://www.siemens.com/simatic-net/ik-info>

## Overview

### Communication functions

Process or field communication (PROFIBUS DP, PROFIBUS PA) is used to link field devices to a programmable controller, HMI system or control system.

Interfacing is performed over integrated interfaces on the CPU or through interface modules (IMs) and communications modules (CPs, CMs).

With modern high-performance automation systems, it is often more effective to link more than one PROFIBUS DP line to one system, not just to increase the number of I/O devices that can be connected, but also to enable individual production areas to be handled independently of one another (segmentation).

PROFIBUS standardized to IEC 61158/61784 is a high-performance, open, rugged fieldbus system with short response times and the following protocols:

#### PROFIBUS DP

(Distributed I/O) is used to connect distributed I/O stations, such as SIMATIC ET 200 with extremely fast response times in accordance with the IEC 61158/EN 50170 standard.

#### PROFIBUS PA

(Process Automation) extends PROFIBUS DP with failsafe transmission technology in accordance with the international standard IEC 61158-2.

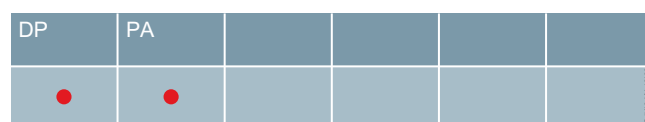

# PROFIBUS

## Introduction

### Process or field communication

#### Overview (continued)

PROFIBUS is used to connect field devices, e.g. distributed I/O devices or drives, to automation systems such as SIMATIC S7, or PCs.

PROFIBUS is used when I/O devices are widely distributed on the machine or in the plant (e.g. at the field level) and can be combined into one station (e.g. ET 200), typically more than 16 inputs/outputs.

The actuators and sensors are connected to field devices. The field devices are supplied with output data in accordance with the master/slave technique and transfer input data to the programmable controller or PC.

High-performance tools such as STEP 7 are available for configuring and parameterizing the I/O devices. Testing and start-up is possible over PROFIBUS DP from any connection point using these tools.

3

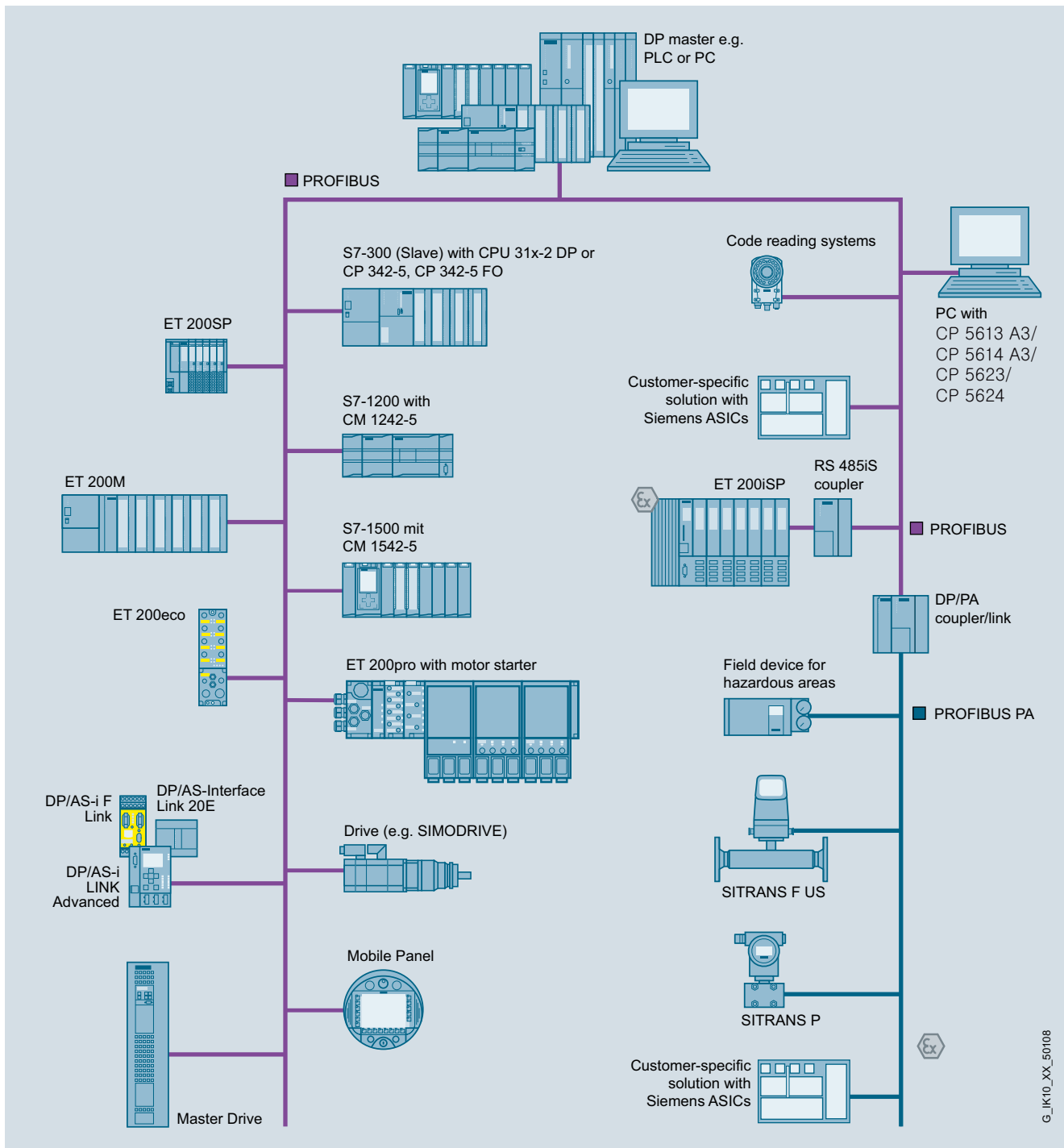

PROFIBUS DP slaves

G\_IK10\_XX\_50108



**Overview** (continued)

**DP device types**

PROFIBUS DP distinguishes between two different master classes and different DP functions:

**DP Master Class 1**

The DP master Class 1 is the central component on PROFIBUS DP. The central controller or PC exchanges information with distributed stations (DP slaves) in a fixed, repeated message cycle.

**DP Master Class 2**

Devices of this type are used (programming, configuration or control devices) during start-up, for configuring the DP system or for controlling the plant during normal operation (diagnostics). A DP master Class 2 can be used, for example, to read the input, output, diagnostics and configuration data of the slaves.

**DP slave**

A DP slave is an I/O device that reads in input data and forwards output data to the I/O. The volume of input and output data depends on the device and can be up to 244 bytes.

The functional scope can differ between DP masters of Class 1 and 2 or DP slaves. This determines the performance and availability of a communications processor.

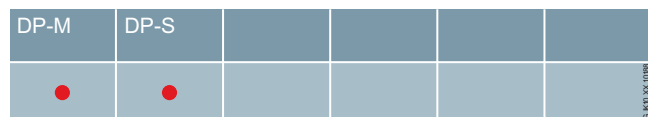
**DP-V0**

The DP master functions (DP-V0) comprise configuration, parameterization, read input data and write outputs in cycles, read diagnostics data.

**DP-V1**

The additional DP function expansions (DP-V 1) make it possible to perform non-isochronous read and write functions as well as acknowledgement of alarms at the same time as processing cyclic data communication. These extended DP functions comprise acyclic access to the parameters and measured values of a slave (e.g. field devices of process automation and intelligent HMI devices). This type of slave must be supplied with extensive parameter data during start-up and during normal operation. Data transferred in acyclic mode (e.g. parameterization data) are only rarely changed, in comparison to the cyclic measured values, and are transferred at lower priority in parallel with the cyclic high-speed useful data transfer. Alarm acknowledgement by the master ensures reliable transfer of the alarms from DP slaves.

**DP-V2**

The DP master functions (DP-V2) comprise functions for isochronous mode and direct data communication between DP slaves.

**Isochronous mode**

Isochronous mode is implemented by means of a signal with a constant bus cycle for the bus system. This isochronous, constant cycle is sent by the master to all bus stations in the form of a global control message. The master and slave can then synchronize their applications with this signal. The jitter of this signal from cycle to cycle must be less than 1  $\mu$ s for typical drive applications.

**Direct data communication between DP slaves**

The publisher/subscriber model is used to implement the direct data communication between slaves. Slaves declared as publishers make their input data (corresponds to response message to their own master) available to other slaves, the subscribers, for reading. Direct slave-to-slave communication is performed cyclically.

# PROFIBUS

## Introduction

### Process or field communication

### Integration

3

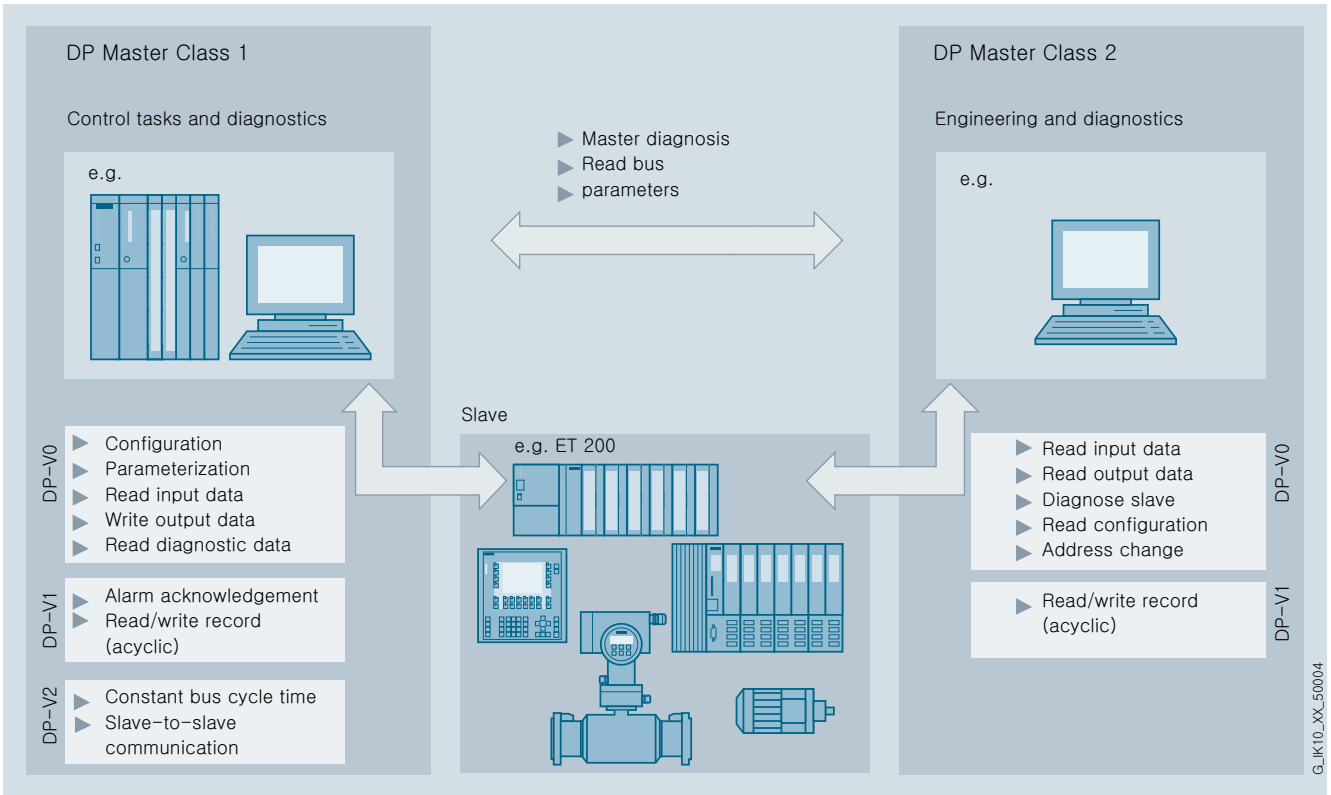

G\_IK10\_XX\_50004

DP Master Classes

## Overview

### Communication functions

Data communication (e.g. PROFIBUS FMS) serves to exchange data between programmable controllers or between a programmable controller and intelligent partners (PC, computers, etc.).

The following communication functions are available for this purpose:

#### FMS communication

This is a standardized protocol for data communication via PROFIBUS.

- PROFIBUS FMS (Fieldbus Message Specification)

This is ideally suited to communication from different automation systems (e.g. PLCs, PCs) from different manufacturers at the cell level with only a few stations (max. 16). Communication with field devices using the FMS interface is also possible.

With the FMS services READ, WRITE and INFORMATION REPORT, read or write access to variables of the communication partner is possible from the user program by means of a variable index or variable name, or the user program can transfer its own variable values to a communications partner. Partial access to variables is supported. The communication is processed over acyclic connections (master-to-master, master-to-slave), over acyclic connections with a slave initiative or with cyclic connections (master-to-slave). The INFORMATION REPORT is can also be used to send a message to all stations on the network using a broadcast service. The FMS service IDENTIFY (request for identification characteristics of the partner) and STATUS (request partner status) can also be activated.

#### OPC-Server

The basic principle of OPC (Openness, Productivity & Collaboration) is that OPC client applications communicate with the OPC server over a standardized, open and manufacturer-independent interface.

The appropriate OPC servers are included in the scope of supply of the respective communication software.

#### PG/OP communication

Comprises integral communication functions that are used by the SIMATIC programmable controllers to perform data communication with HMI devices (e.g. TD/OP) and SIMATIC PG (STEP 7). PG/OP communication is supported by MPI, PROFIBUS and Industrial Ethernet networks.

#### S7 routing

With the aid of S7 routing it is possible to use the programming device communication across networks.

#### S7 communication

S7 communication is the integral communications function, which has been optimized within the SIMATIC. It enables PCs and workstations to be connected. The maximum volume of useful data per task is 64 KB. S7 communication offers simple, powerful communication services and provides a network-independent software interface for MPI, PROFIBUS and Industrial Ethernet networks.

#### Open communication

The open communication (SEND/RECEIVE) allows the SIMATIC S7 controllers to communicate with other SIMATIC S7 and SIMATIC S5 controllers, PCs, and third-party systems.

		FMS	OPC	PG/OP	S7/S5
		●	●	●	●

# PROFIBUS

## Introduction

### Data communication

#### Overview (continued)

#### System connections

For many data terminals, communications processors (CPs) are available that already have the communications functions implemented in the firmware and that therefore relieve the data terminal of communications tasks (e.g. flow control, blocking, etc.).

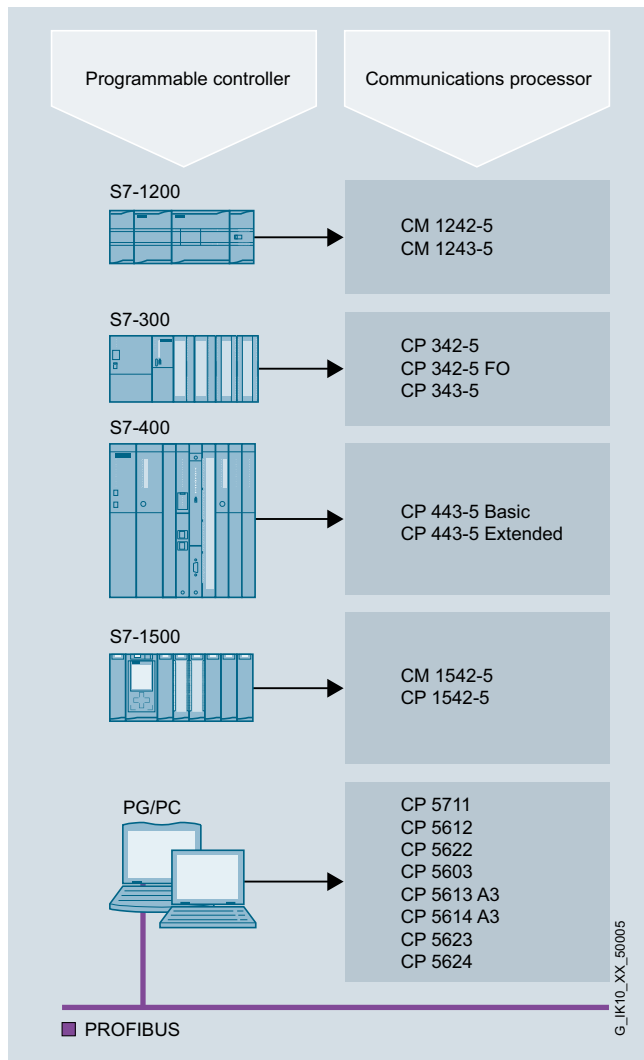

PROFIBUS system connections for SIMATIC and PC

**Function**

	Hardware	PROFIBUS DP			Open communication	S7 communication	PG/OP communication		Usage		Time		
		DP master cl.1	DP master cl.2	DP slave	Send/Receive			S7 routing	F system	H system	Sender	Receiver	Transfer
SIMATIC S7-1200	S7-1200 CPUs	No PB SS integrated !											
	CM 1243-5	• <sup>1)</sup>				•	•	•					
	CM 1242-5			•									
SIMATIC S7-1500	CPU 1511-1 PN	No PB SS integrated !											
	CPU 1513-1 PN	No PB SS integrated !											
	CPU 1516-3 PN/DP	•	•			•	•	•	• <sup>3)</sup>		•	•	
	CM 1542-5	•	•	•		•	•	•	•		•	•	•
	CP 1542-5	• <sup>2)</sup>	•	•			•	•	•		•	•	•
SIMATIC S7-300	S7-300 CPUs	•	•	•		○	•		• <sup>3)</sup>		•	•	
	CP 343-5	•	•	•	•	•	•	•					
	CP 343-5 FO	•	•	•	•	•	•	•					
SIMATIC S7-400	S7-400 CPUs	•	•	•		•	•	•	• <sup>3)</sup>	• <sup>3)</sup>	•	•	
	CP 443-5 Extended	•	•		•	•	•	•	•	•		•	•
SIMATIC S7mEC	CP 5603	•	•	•	•	•	•						

1) 16 DP slaves maximum  
 2) 32 DP slaves maximum  
 3) special F- or H-CPU

• applies  
 ○ with restrictions

G...IK10...XX\_50199

Communications overview for SIMATIC

# PROFIBUS

## Introduction

### Communication overview

#### Function (continued)

Hardware	Software	Operation system (64 Bit)				Operation system (32 Bit)					Other operation systems	OPC	PROFIBUS DP <sup>5)</sup>			PG/OP	S7 communication	Open communication <sup>7)</sup>
		Windows 8 Pro <sup>7)</sup>	Windows 7 Professional / Ultimate <sup>7)</sup>	Windows Server 2012 <sup>7)</sup>	Windows Server 2008 R2 <sup>7)</sup>	Windows 8 Pro <sup>7)</sup>	Windows 7 Professional / Ultimate	Vista Business / Ultimate + SP1/2 <sup>8)</sup>	Windows XP Pro + SP3 <sup>8)</sup>	Windows Server 2008 + SP2 <sup>8)</sup>			Windows Server 2003 SP2 <sup>8)</sup>	DP MasterClass 1	DP MasterClass 2			
CP 5603 (PCI-104)  CP 5613 A3 CP 5614 A3 (PCI 32 Bit)  CP 5623 CP 5624 (PCIe x1)	CP with DP-Base <sup>1) 4)</sup>	•	•	•	•	•	•	•	•	•	•	•	•	•	•	•	•	•
	DK-5613											○ <sup>5)</sup>	•	•	•			
	HARDNET-PB DP (DP-5613) <sup>4)</sup>	•	•	•	•	•	• <sup>9)</sup>	• <sup>9)</sup>	• <sup>9)</sup>	• <sup>9)</sup>		•	•	•		•	•	•
	HARDNET-PB S7 (S7-5613)	•	•	•	•	•	• <sup>9)</sup>	• <sup>9)</sup>	• <sup>9)</sup>	• <sup>9)</sup>		•				•	•	•
	S7 OPC Redundancy for PROFIBUS				•							•					•	
CP 5612 (PCI 32 Bit)  CP 5622 (PCIe x1)  CP 5711 (USB V2.0)	SOFTNET-PB DP <sup>2)</sup>	•	•	•	•	•	•	•	•	•		•	• <sup>3)</sup>	• <sup>3)</sup>		•	•	•
	SOFTNET-PB DP <sup>2)</sup> Slave	•	•	•	•	•	•	•	•	•		•			•			
	SOFTNET-PB S7	•	•	•	•	•	•	•	•	•		•				•	•	•
	S7 OPC Redundancy for PROFIBUS				•							•					•	
	STEP 7		•		•		•	•	•	•						•		
<p>You can find more information on the Internet <a href="http://www.siemens.com/simatic-net/ik-info">http://www.siemens.com/simatic-net/ik-info</a> If you have questions on LINUX projects please contact via e-mail <a href="mailto:it4industry@siemens.com">it4industry@siemens.com</a></p>		<p>1) Included in scope of supply of the hardware 2) DP master and DP slaves cannot be operated simultaneously 3) Master Class 1 and Master Class 2 cannot be operated simultaneously on one CP (Exceptions: CP 5614 A3/CP 5624) 4) DP-Base and DP-5613 cannot be operated simultaneously</p>										<p>5) With porting via DK-5613 6) SEND/RECEIVE based on the FDL interface 7) on SIMATIC NET-DVD V12 8) on SIMATIC NET CD Edition 2008 SP6 9) not with CP 5613 A3/ CP 5614 A3</p>			<p>• suitable ○ suitable under certain conditions not applicable</p>			G_IK10_XX_50058

Communications overview for PG/PC

3

**Overview**

Siemens offers a comprehensive range of PROFIBUS network components for electrical and optical transmission technology.

PROFIBUS is standardized in accordance with IEC 61158/EN 50170 for universal automation (PROFIBUS FMS and PROFIBUS DP), and in accordance with IEC 61158-2 for process automation (PROFIBUS PA).

**Electrical network**

- The electrical network uses a shielded twisted pair cable. The RS 485 interface works with voltage differences. It is therefore less sensitive to interference than a voltage or current interface. With PROFIBUS, the stations are connected to the bus via a bus terminal or a bus connector (max. 32 stations per segment).
- The individual segments are connected via repeaters.
- The transmission rate can be set in steps from 9.6 Kbit/s to 12 Mbit/s.
- The maximum segment length depends on the transmission rate.
- The electrical network can be configured as a bus or tree structure
- For applications in the intrinsically-safe area, the transmission technology compliant with IEC 61158-2 is used with PROFIBUS PA. The transmission rate in this case is 31.25 Kbit/s.

**Characteristics**

- High-grade bus cable
- Transmission method: RS 485 (acc. to EIA)
- Bus topology with bus terminals and bus connectors for connecting PROFIBUS stations
- Transmission method in accordance with IEC 61158/EN 50170 for universal automation (PROFIBUS FMS/DP), and in accordance with IEC61158-2 for the intrinsically-safe area (PROFIBUS PA)
- The DP transmission system of RS 485 (bit coding by means of differential voltage signals) is converted to IEC 61158-2 (bit coding by means of current signals) using the network components (DP/PA coupler or DP/PA link)
- Simple, universal installation and grounding concept
- Easy installation

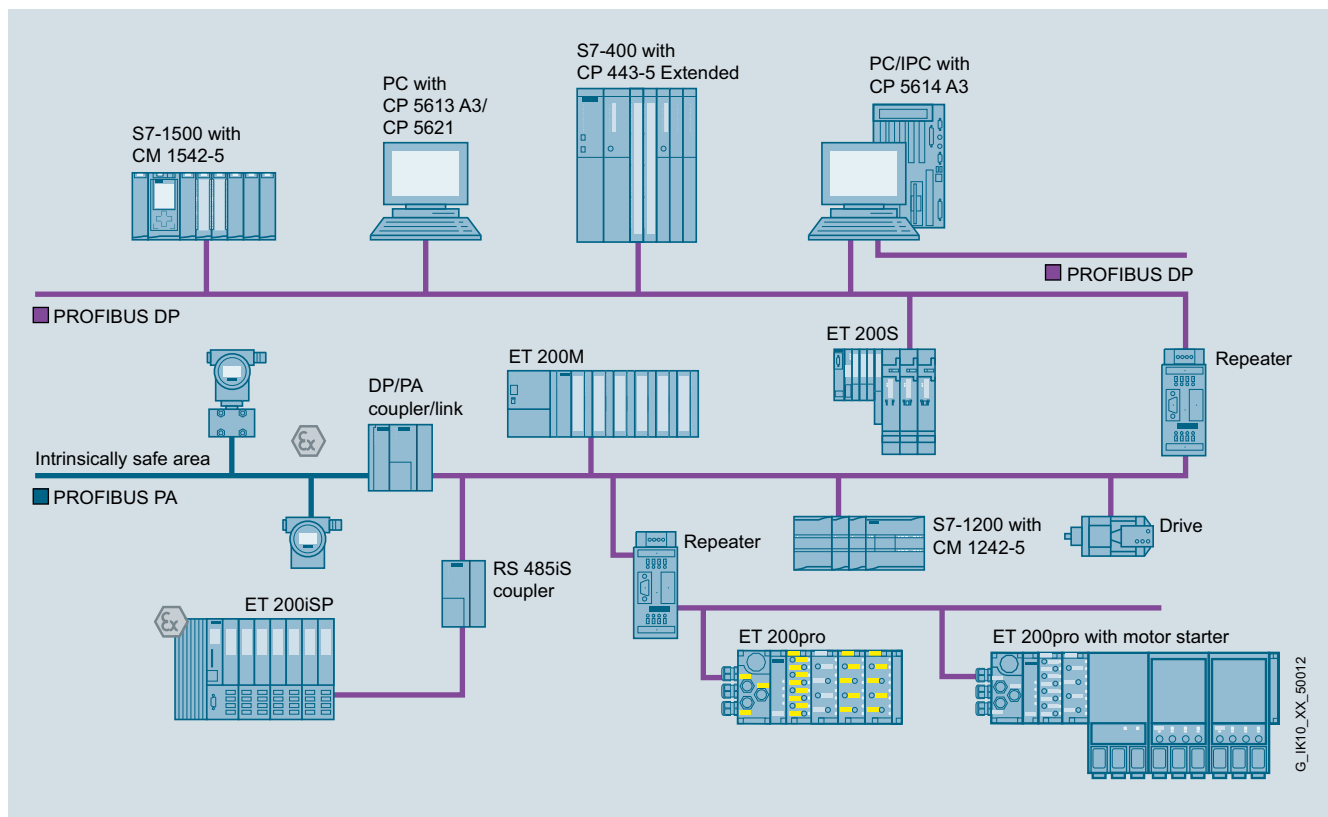

Electrical PROFIBUS network configuration

## PROFIBUS

### Introduction

#### Topologies

##### Overview (continued)

##### Optical network

The fiber-optic cable variant of PROFIBUS has the following characteristics:

- Transmission link is insensitive to electromagnetic influences
- Suitable for long ranges
- Galvanic isolation
- Uses either plastic, PCF or glass fiber-optic cables
- Avoidance of overvoltage and equipotential bonding problems

##### Optical PROFIBUS with OLMs

Using optical link modules (OLMs) it is possible to construct an optical network in a linear, ring, or star topology. The maximum distance between two OLMs is 15 km. The transmission rate can be set in steps from 9.6 Kbit/s to 12 Mbit/s.

##### Optical PROFIBUS with integral interface and OBT

The optical PROFIBUS with integral interface and OBT is constructed in a linear topology. A cost-optimized solution is available for this in the form of devices with integral optical interface. Terminal equipment with an RS 485 interface can be connected via an Optical Bus Terminal (OBT). The maximum distance between two nodes is 50 m in the case of plastic fiber-optic cables. Special fiber-optic cables are available to cover distances of up to 400 m.

##### Hybrid network

Hybrid electrical and optical networks are possible. The transition between both media is implemented by the OLM.

In station-to-station communication on the bus, there is no difference between two-wire technology and fiber-optic technology. A maximum of 127 stations can be connected to one PROFIBUS network.

The optical transmission technology offers the following advantages:

- Fiber-optic cables made of plastic or glass are not susceptible to electromagnetic interference and therefore render the EMC measures required for electrical networks unnecessary
- No additional lightning protection concept is required in the outdoor area
- The potentials on the modules are automatically separated thanks to the characteristics of the conductor
- With fiber-optic cables, long distances to field devices can be bridged.

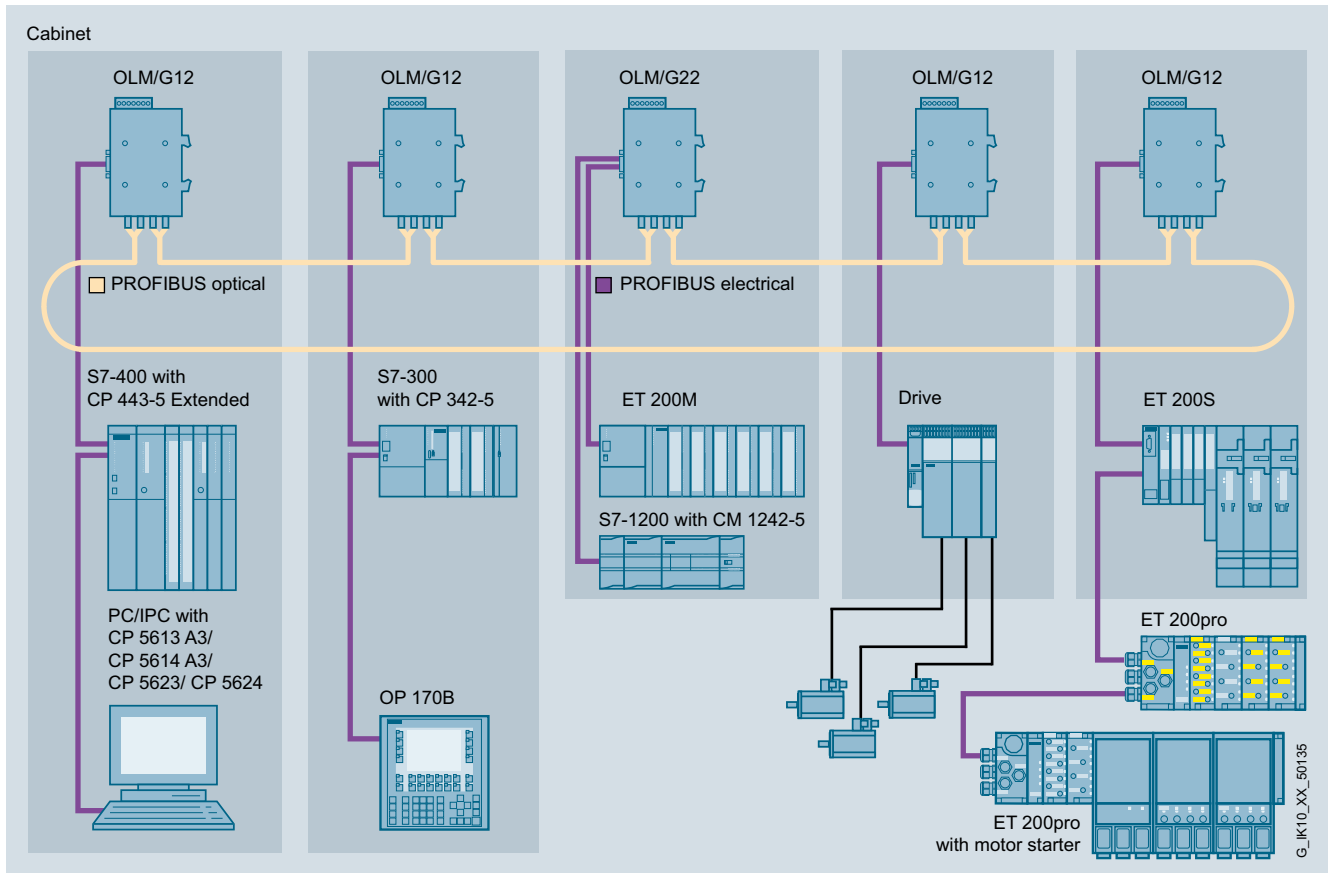

Network configuration combining electrical and optical PROFIBUS

##### More information

Please always note the supplementary conditions for the specified SIMATIC NET products (order number 6GK..., 6XV1...) that you can view on the Internet pages shown below:

<http://www.siemens.com/simatic-net/ik-info>



### Overview

PROFIBUS	Maximum cable length for PROFIBUS connections						
	Type of fibre	0 - 80 m	0 - 100 m	0 - 200 m	0 - 400 m	0 - 3,000 m	0 - 10,000 m
<b>PB FC Bus Cables</b>							
PB FC Standard Cable GP / PB FC Standard Cable GP IS			● <sup>4)</sup>	● <sup>5)</sup>			
PB FC Robust Cable			● <sup>4)</sup>	● <sup>5)</sup>			
PB FC Food Cable			● <sup>4)</sup>	● <sup>5)</sup>			
PB FC Ground Cable			● <sup>4)</sup>	● <sup>5)</sup>			
PB FC Flexible Cable			● <sup>4)</sup>	● <sup>5)</sup>			
PB FC Trailing Cable			● <sup>4)</sup>	● <sup>5)</sup>			
PB FC FRNC Cable GP			● <sup>4)</sup>	● <sup>5)</sup>			
PB Festoon Cable GP			● <sup>4)</sup>	● <sup>5)</sup>			
PB Torsion Cable			● <sup>4)</sup>	● <sup>5)</sup>			
PYR FR Marine Cable			● <sup>4)</sup>	● <sup>5)</sup>			
PB Hybrid Standard Cable GP <sup>1)</sup>							
PB Hybrid Robust Cable <sup>1)</sup>							
PB FC Process Cable <sup>1)</sup>							
PB Cable for ET 200X <sup>1)</sup>							
<b>PB ECOFAST Bus Cables</b>							
PB ECOFAST Hybrid Cable <sup>1)</sup>							
PB ECOFAST Hybrid Cable GP <sup>1)</sup>							
<b>PB Glass FOC with PB OLM</b>							
FO Standard Cable GP	Multimode (50/125)					● <sup>2)</sup>	● <sup>3)</sup>
FO Ground Cable	Multimode (50/125)					● <sup>2)</sup>	● <sup>3)</sup>
FO Trailing Cable	Multimode (50/125)					● <sup>2)</sup>	● <sup>3)</sup>
FO Trailing Cable GP	Multimode (50/125)					● <sup>2)</sup>	● <sup>3)</sup>
INDOOR FO Indoor cable	Multimode (62.5/125)					● <sup>2)</sup>	● <sup>3)</sup>
FO Standard cable	Multimode (62.5/125)					● <sup>2)</sup>	● <sup>3)</sup>
Flexible FO Trailing cable	Multimode (62.5/125)					● <sup>2)</sup>	● <sup>3)</sup>
<b>PB Plastic/POF/PCF FOC with PB OLM</b>							
PB Plastic FO Standard Cable	Step index (980/1000)	●					
PB PCF FO Standard Cable	Step index (200/230)				●		
PCF Standard Cable GP	Step index (200/230)				●		
PCF Trailing Cable	Step index (200/230)				●		
PCF Trailing Cable GP	Step index (200/230)				●		
		1) Dependent on current load    2) at 860 nm    3) at 1310 nm    4) at 12 Mbit/s    5) at 1.5 Mbit/s Longer cables possible if data rate is reduced; see PROFIBUS Manual for further information					

G\_IK10\_XX\_50196



# PROFIBUS

## Network components

### Overview of network components

#### Overview (continued)

3

		Options for connecting PROFIBUS cables with plugs, terminals or devices													
		Electrical							Optical						
		PROFIBUS FC bus cables	PROFIBUS bus cables	Connecting cables	ECOFAST cable	Hybrid cable	Power cable	PROFIBUS FC Bus cable (PROFIBUS PA)	Bus terminal	Fiber-optic cable 50/125 µm	Fiber-optic cable 62.5/125 µm	PCF fiber optic cable 200/230 µm	POF-FOC 980/1000 µm	Fiber-optic cable with BFOC connector	Fiber-optic cable with Simplex connector
		PROFIBUS FC Standard Cable PROFIBUS FC Standard Cable IS GP PROFIBUS FC Robust Cable PROFIBUS FC Food Cable PROFIBUS FC Ground Cable PROFIBUS FC FRNC Cable PROFIBUS FC Trailing Cable	PROFIBUS Feestoon Cable PROFIBUS Flexible Cable	Connecting cable 830-2 Connecting cable 830-1T PROFIBUS M12 plug-in cable	ECOFAST Hybrid Cable ECOFAST Hybrid Cable GP	PROFIBUS Hybrid Standard Cable GP PROFIBUS Hybrid Robust Cable	Power Cable 5 x 1.5	PB FC Process Cable	12M bus terminal	FO Standard Cable GP FO Trailing Cable GP FO Ground Cable	FIBER OPTIC standard cable INDOOR Fiber optic trailing cable Flexible Fiber Optic trailing cable SIENOPYR marine duplex fiber-optic cable	PCF Standard Cable GP PCF Trailing Cable GP PCF Trailing Cable GP	Plastic fiber optic standard cable	Preassembled FOC with BFOC connector	Preassembled FOC with simplex connector
Electrical		PB FastConnect connector	•	•											
		PB bus connector	•	•											
		ECOFAST connector				•									
		PB M12 plug/socket (B-coded)	•	•											
		7/8" Power con						•							
		PB devices with Sub-D / M12 connector			•					•					
		ET 200pro	•	•											
	Bus terminal 12M	•	•												
	SplitConnect system							•							
Optical		BFOC connector								•	•	•			
		PB devices with BFOC connection											•		
		Simplex connector										•	•		
		PB devices with simplex connection												•	

G\_IK10\_XX\_50013

**Overview**

Criteria	Electrical network		Optical network			
	RS 485 conforming to IEC 61158/ 61784	IEC 61158-2 (PA)	Plastic	PCF	Glass	
EMC	● ● ● ○	● ● ● ○	● ● ● ●	● ● ● ●	● ● ● ●	
Inter-building networking	● ● ○ ○ <sup>1)</sup>	● ● ○ ○	● ○ ○ ○	● ● ● ○ <sup>5)</sup>	● ● ● ● <sup>5)</sup>	
Operating distance	● ● ○ ○ <sup>2)</sup>	● ● ○ ○	● ○ ○ ○	● ● ○ ○	● ● ● ●	
Suitability for high transmission rate	● ● ● ○ <sup>4)</sup>	-	● ● ● ●	● ● ● ●	● ● ● ●	
Simple plug fitting	● ● ● ●	● ● ● ●	● ● ● ○	● ● ● ○ <sup>3)</sup>	● ● ● ○ <sup>3)</sup>	
Simple cable laying	● ● ● ○	● ● ● ○	● ● ○ ○	● ● ○ ○	● ● ○ ○	
Equipotential bonding measures required	Yes	Yes	No	No	No	
Performance spectrum for special applications	● ● ● ●	● ○ ○ ○	● ○ ○ ○	● ○ ○ ○	● ● ○ ○	
Used for moving nodes	● ● ○ ○ <sup>6)</sup>	-	● ● ○ ○ <sup>6)</sup>	● ● ○ ○ <sup>6)</sup>	● ● ○ ○ <sup>6)</sup>	
Use in intrinsically safe area	-	● ● ● ●	-	-	-	
1) Lightning protection measures required 2) Depending on transmission rate 3) Trained personnel and special tools necessary 4) Careful cable laying necessary 5) Outdoor cable required 6) Trailing cable required			● ● ● ● suitable ● ● ● ○ ● ● ○ ○ partly suitable ● ○ ○ ○ - not applicable			G_IK10_XX_50010

Summary of network selection criteria for transmission media



# PROFIBUS

## Network components

### Network selection criteria

#### Overview (continued)

Criteria		Electrical network	Optical network	
		Electrical PROFIBUS	with OLM	with integr. interface/ OBT
Transition media	Plastic <sup>1)</sup>	-	●	●
	PCF	-	●	●
	Glass	-	●	-
	Shielded two-core cable	●	-	-
Distances	max. network size	9,6 km <sup>5)</sup>	90 km	9,6 km
	between two nodes	up to 1 km <sup>3)</sup>	up to 15 km <sup>2)</sup>	up to 300 m <sup>2)</sup>
Topology	Bus	●	-	-
	Line	-	●	●
	Tree	●	●	-
	Ring	-	●	-
Transmission protocols		all	all	DP
Connection of nodes via	OLM	-	●	-
	Integrated interfaces	●	-	● <sup>4)</sup>
	Bus terminal	●	-	●
	Bus connector	●	-	-
Electr. network segments connectable		●	●	-
1) Plastic optical fiber is also referred to as polymer optical fiber (POF) 2) Depending on type of cable used 3) Depending on data rate used and performance 4) Integrated interfaces (ET 200M, ET 200X) 5) for PROFIBUS PA 1.9 km		● suitable - Irrelevant to this application		G_IK10_XX_50133

Selection criteria for electrical and optical networks

#### Overview (continued)

	Electrical network		Optical network	
	RS 485 in accordance with IEC 61158/EN 50170	IEC 61158-2 (PA)	with OLM	with integral interface/OBT
Network topology	Bus, tree	Bus, tree	Linear bus, star, ring	Linear bus
Transmission media	Shielded twisted-pair cable	Shielded twisted-pair cable for intrinsically-safe and non-intrinsically-safe areas	Plastic fiber optic cable PCF optic cable Glass fiber optic cable	Plastic fiber optic cable PCF optic cable
Tools and accessories	FastConnect stripping tool	FastConnect stripping tool	Tools for preparing BFOC connectors for plastic fiber optic cables	Tools for preparing Simplex connectors for plastic fiber optic cables
Connectors	Bus connector	SplitConnect system	BFOC connector	Simplex connector
Connection components	Bus terminal	SplitConnect system	OLM	OBT
Prepared cables	830-1T connecting cable 830-2 connecting cable	—	INDOOR cable with BFOC Standard glass cable with BFOC Trailing cable with BFOC Standard PCF cable with BFOC Standard plastic cable with BFOC	Standard PCF cable with Simplex connectors and pull cord feature
Lightning protection	Primary protection Secondary protection	to be implemented through design measures	Not required	Not required
Electrical network segment can be connected via	repeater	—	Optical Link Module (OLM)	Optical Bus Terminal (OBT)
Diagnostics tool	BT 200 hardware test device	Not available	Signal contact and integral measuring sockets; level measuring device on request	Level measuring device on request
Documentation	Manual for PROFIBUS networks	Manual for PROFIBUS networks	Manual for PROFIBUS networks	Manual for PROFIBUS networks

G\_IK10\_XX\_50016

#### PROFIBUS network components and accessories

	Electrical PROFIBUS	Optical PROFIBUS/OLM	Optical PROFIBUS/int./OLM
Electrical PROFIBUS	Repeater	OLM	OBT
Optical PROFIBUS/OLM	OLM	OLM	OBT + OLM
Optical PROFIBUS/int./OBT	OBT	OBT + OLM	OBT, integr. optics

G\_IK10\_XX\_50017

#### Transitions between the transmission media

# PROFIBUS

## Network components

### Connection examples

#### Integration

3

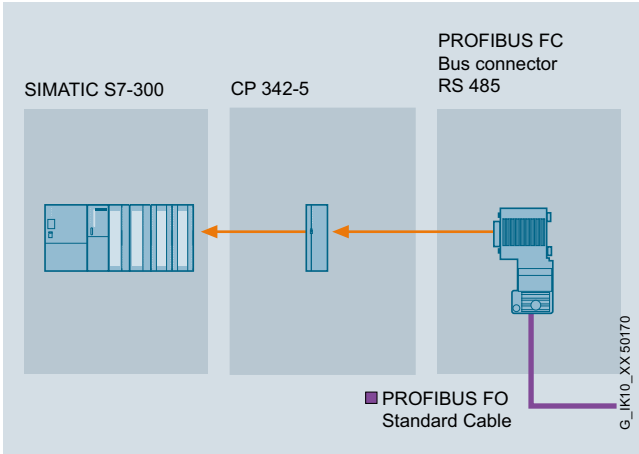

Typical connection for electrical networking with PROFIBUS FastConnect RS485 bus connector

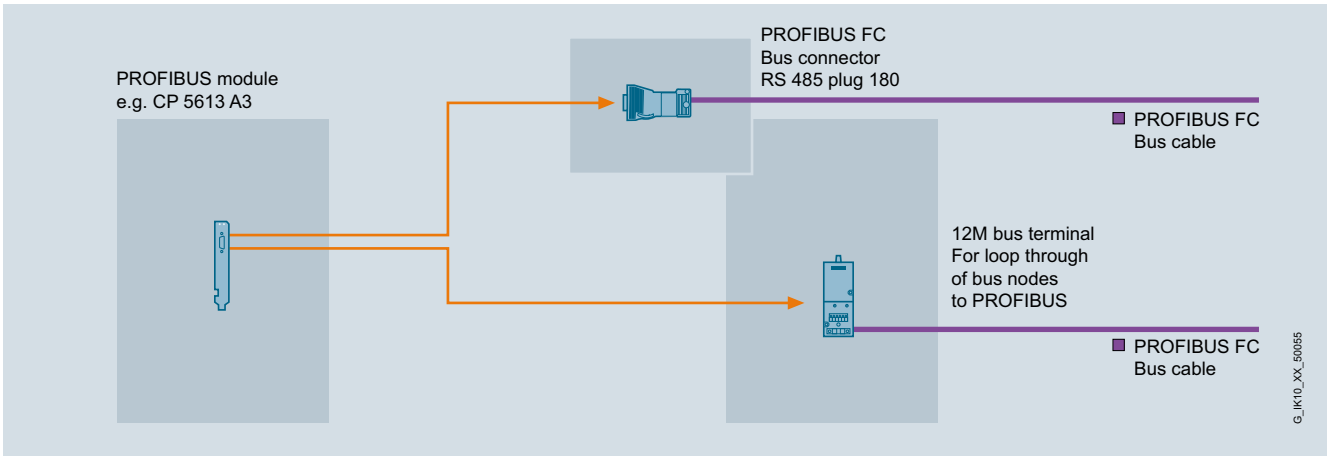

Typical connection for electrical networking with PROFIBUS FastConnect RS485 bus connector or bus terminal

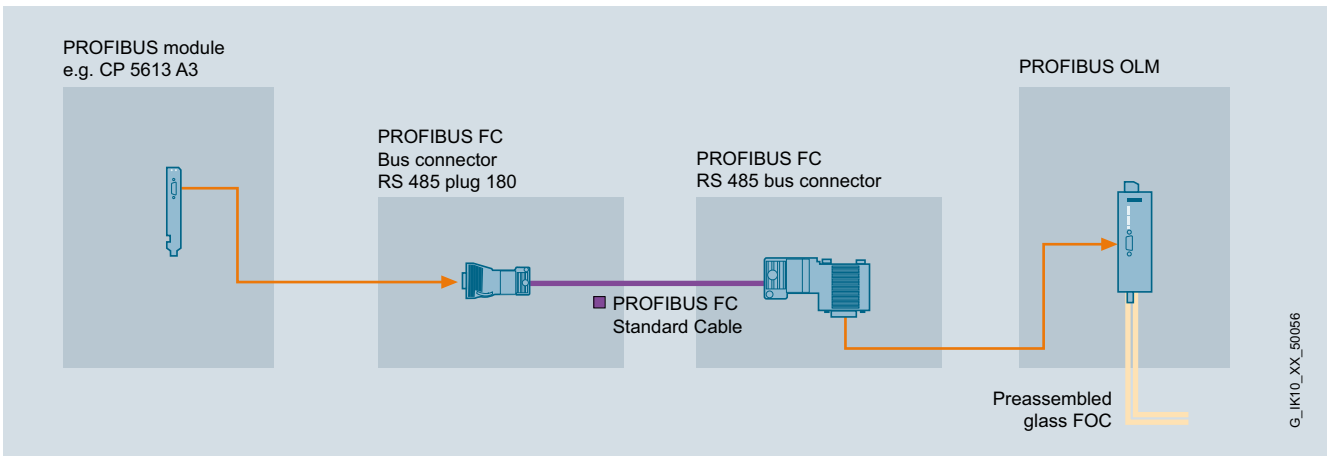

Connection example of optical networking

**Integration** (continued)

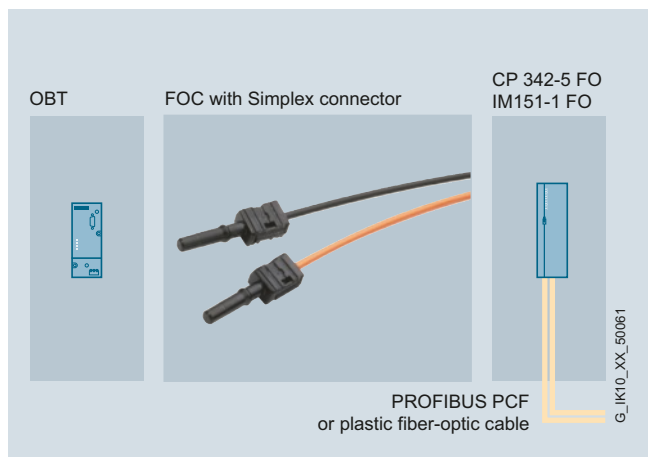

Connection example of optical networking with fiber-optic cables and Simplex connectors

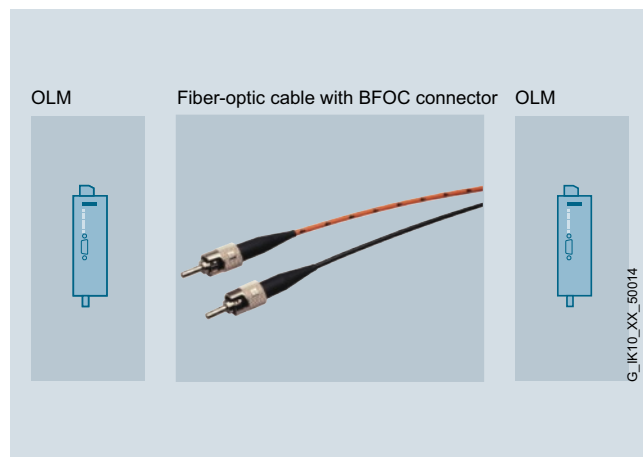

Connection example of optical networking with fiber-optic cables and BFOC connectors

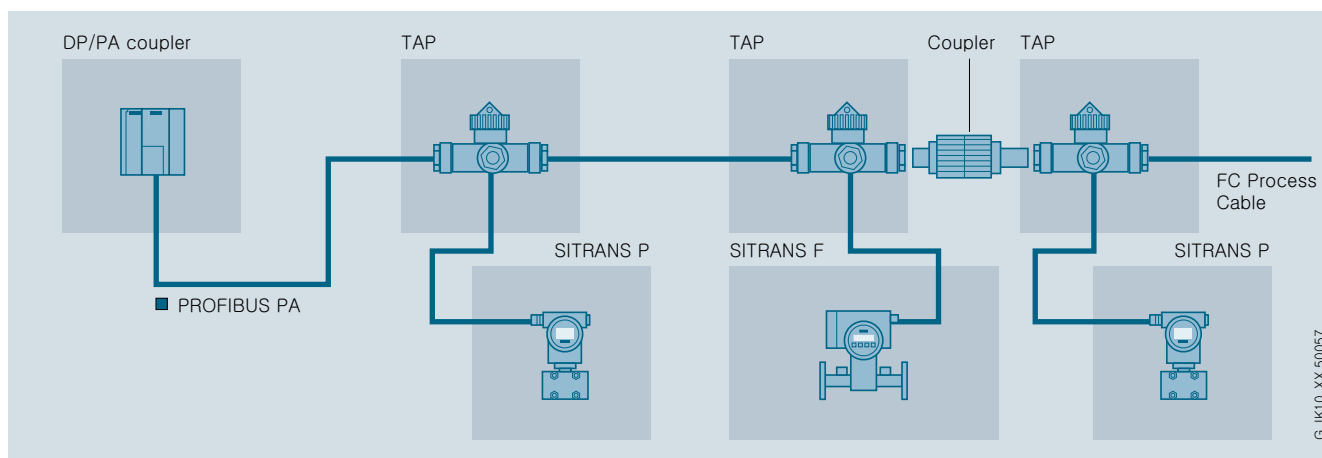

Connection example of an intrinsically-safe network with PROFIBUS PA

## PROFIBUS

### Electrical networks (RS485)

#### PROFIBUS FastConnect

##### Overview



- Quick and easy assembly of PROFIBUS copper cables
- Assembly mistakes such as short-circuits between the shield and core are excluded

##### Benefits

get **Designed for Industry**

- Shorter connection times for terminals by stripping of the outer cladding and woven shield in one step
- Installation faults, such as short-circuits between the shield and cores, are excluded
- Easy assembly due to preset insulation stripping tool (FC stripping tool)
- Termination can be checked in the assembled state through the transparent cover for the insulation piercing terminals thanks to color coding.

##### Design

The system comprises 3 compatible components:

- FastConnect bus cables for rapid installation
- FastConnect stripping tool
- FastConnect bus connector for PROFIBUS

The PROFIBUS FastConnect bus cables can also be connected to conventional bus connectors.

##### Function

The FastConnect stripping method enables fast and easy connection of PROFIBUS connectors to the PROFIBUS cables.

The special structure of the FastConnect bus cables enables the use of the FastConnect stripping tool with which the outer casing and the woven shield can be stripped in one operation with perfect precision. The cable prepared in this way is connected in the FastConnect bus connector using the insulation displacement method.



**Application**

PROFIBUS FastConnect is a system for fast and easy assembly of PROFIBUS copper cables.

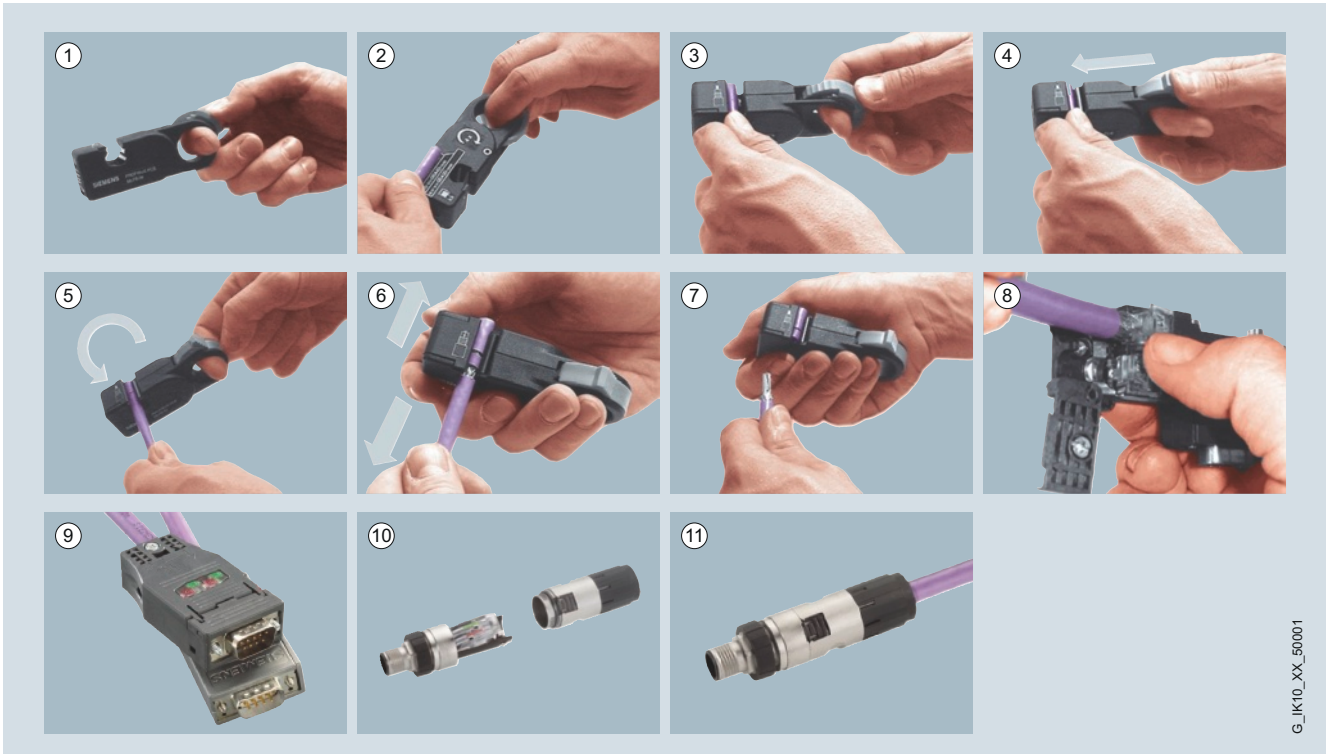

Steps in assembling PROFIBUS copper cables with PROFIBUS FastConnect

## PROFIBUS

### Electrical networks (RS 485)

#### PROFIBUS bus cables

##### Overview



- Different variants for different application areas (e.g. underground cables, trailing cables, hazardous area Zone 1 and Zone 2)
- High interference immunity thanks to double shielding
- Flame-retardant bus cable (halogen-free)
- Easy length measurement thanks to printed meter markings
- UL approvals

##### Benefits



- Flexible application possibilities thanks to special bus cables
- Network is immune to interference thanks to double shielded cables and a uniform grounding concept
- Time saving due to simple and fast connector assembly with FastConnect cables
- Silicon-free, therefore particularly suitable for use in the automotive industry (e.g. on paint shop conveyors)

##### Application

For the construction of PROFIBUS DP networks, different cable types are offered to suit the different types of applications. The listed bus cables should always be used. For further information on network configuration, see the PROFIBUS network manual.

##### UL approvals

UL listing (safety standard) for network cables is especially necessary for the American and Canadian markets. The requirements for the appropriate approvals depend on where the cable is routed within the building. This applies to all cables which have to be routed from a machine to a remote control cabinet and are positioned on cable racks secured on the building. Cables with UL approval have "GP" (General Purpose) added to their name.

##### Ex approval

Cables for intrinsically safe PROFIBUS DP applications have "IS" (intrinsically safe) added to their names

##### Design

Shielded, twisted-pair cable with circular cross-section

The following applies for all PROFIBUS bus cables:

- The double shield makes it especially suitable for routing through industrial areas with strong electro-magnetic fields
- System-wide grounding concept can be implemented using the external shield of the bus cable and the grounding terminals on the bus terminal
- Printed meter marks

##### Cable types

The shape of the FastConnect (FC) bus cables is radially symmetric and allows an insulation stripping tool to be used. This means that bus connectors can be assembled quickly and easily.

- PROFIBUS FC Standard Cable GP: Standard bus cable specially designed for fast installation
- PROFIBUS FC Standard Cable IS GP: Standard bus cable with special design for quick installation for intrinsically safe distributed I/O systems
- PROFIBUS FC Robust Cable: Special cable for use in corrosive atmospheres and under severe mechanical loading
- PROFIBUS FC Food Cable: The PE casing of the cable makes this cable suitable for use in the food and tobacco industry
- PROFIBUS FC Ground Cable: Special cable for laying underground. It differs from the PROFIBUS bus cable in that it has an additional sheath
- PROFIBUS FC Flexible Cable: Flexible (stranded conductors), halogen-free bus cable with PUR sheath for occasional moving
- PROFIBUS FC Trailing Cable: Bus cable specially designed for forced motion control in a trailing cable, e.g. with continuously moving machine parts (stranded core)
- PROFIBUS FC FRNC Cable GP: Two-core, shielded, flame-retardant, halogen-free bus cable with Copolymer outer sheath FRNC (Flame Retardant Non Corrosive)

Bus cables without FastConnect technology (due to type of construction)

- PROFIBUS Festoon Cable GP: Flexible bus cable (stranded cores) specially designed for festoon suspension. For round cables, cable-carrying trolleys are recommended
- PROFIBUS Torsion Cable: Bus cable for highly flexible applications: Special cable (stranded cores) for use on moving parts of machines (5 million torsion movements on 1 m length of cable,  $\pm 180^\circ$ )
- PROFIBUS Hybrid Cable GP: Rugged hybrid cable suitable for trailing with two copper conductors for data transmission and two copper conductors for the power supply of ET 200pro
- SIENOPYR FR marine cable: Halogen-free, non-crush, flame-retardant, marine-approved cable for permanent installation on ships and offshore platforms indoors and on open deck. Sold by the meter.

### Technical specifications

Article No.	6XV1830-0EH10	6XV1831-2A	6XV1830-0JH10	6XV1830-0GH10
Product-type designation	PROFIBUS FC Standard Cable GP	PROFIBUS FC Standard Cable IS GP	PROFIBUS FC Robust Cable	PROFIBUS FC Food Cable
Product description	Standard bus cable (2-core), sold by the meter, in bulk	Standard bus cable (2-core), sold by the meter, in bulk	Standard bus cable (2-core), sold by the meter, in bulk	Standard bus cable (2-core), sold by the meter, in bulk
Acceptability for application	Standard cable specially designed for fast, permanent installation	Used for intrinsically safe distributed I/O systems for permanent installation	For use in chemically and mechanically demanding environments	For use in the food, beverages and tobacco industries
Cable designation	02YSY (ST) CY 1x2x0.64/2.55-150 VI KF 40 FR	02YSY (ST) CY 1x2x0.64/2.55 BL KF40 FR	02YSY (ST) C11Y 1x2x0.64/2.55-150 VI KF 40 FR	02YSY (ST) C2Y 1x2x0.64/2.55-150 KF 40
<b>Electrical data</b>				
Damping ratio per length				
• at 9.6 kHz maximum	2.5 dB/km	2.5 dB/km	2.5 dB/km	2.5 dB/km
• at 38.4 kHz maximum	4 dB/km	4 dB/km	4 dB/km	4 dB/km
• at 4 MHz maximum	22 dB/km	22 dB/km	22 dB/km	22 dB/km
• at 16 MHz maximum	42 dB/km	42 dB/km	42 dB/km	42 dB/km
Impedance				
• Nominal value	150 Ω	150 Ω	150 Ω	150 Ω
• at 9.6 kHz	270 Ω	270 Ω	270 Ω	270 Ω
• at 38.4 kHz	185 Ω	185 Ω	185 Ω	185 Ω
• for frequency range 3 MHz ... 20 MHz	150 Ω	150 Ω	150 Ω	150 Ω
Relative symmetrical tolerance				
• of the surge impedance at 9.6 kHz	10 %	10 %	10 %	10 %
• of the surge impedance at 38.4 kHz	10 %	10 %	10 %	10 %
• of the surge impedance at 3 MHz ... 20 MHz	10 %	10 %	10 %	10 %
Loop resistance per length maximum	110 Ω/km	110 Ω/km	110 Ω/km	110 Ω/km
Shield resistance per length maximum	9.5 Ω/km	9.5 Ω/km	9.5 Ω/km	9.5 Ω/km
Capacity per length at 1 kHz	28.5 pF/m	28.5 pF/m	28.5 pF/m	28.5 pF/m
Operating voltage RMS value	100 V	100 V	100 V	100 V
<b>Mechanical data</b>				
Number of electrical wires	2	2	2	2
Design of shield	Overlapped aluminum-clad foil, sheathed in a braided screen of tin-plated copper wires	Overlapped aluminum-clad foil, sheathed in a braided screen of tin-plated copper wires	Overlapped aluminum-clad foil, sheathed in a braided screen of tin-plated copper wires	Overlapped aluminum-clad foil, sheathed in a braided screen of tin-plated copper wires
Design of the electrical connection FastConnect	Yes	Yes	Yes	Yes
Outer diameter				
• of the inner conductor	0.65 mm	0.64 mm	0.65 mm	0.65 mm
• of the wire insulation	2.55 mm	2.55 mm	2.55 mm	2.55 mm
• of the inner sheath of the cable	5.4 mm	5.4 mm	5.4 mm	5.4 mm
• of the cable sheath	8 mm	8 mm	8 mm	8 mm
Symmetrical tolerance of outer diameter of cable sheath	0.4 mm	0.4 mm	0.4 mm	0.4 mm
Material				
• of the wire insulation	PE	PE	PE	PE
• of the inner sheath of the cable	PVC	PVC	PVC	PVC
• of the cable sheath	PVC	PVC	-	PE
- Note	-	-	-	Outer PE sheath particularly suitable for the food sector

**PROFIBUS****Electrical networks (RS 485)****PROFIBUS bus cables****Technical specifications (continued)**

Article No.	6XV1830-0EH10	6XV1831-2A	6XV1830-0JH10	6XV1830-0GH10
Product-type designation	PROFIBUS FC Standard Cable GP	PROFIBUS FC Standard Cable IS GP	PROFIBUS FC Robust Cable	PROFIBUS FC Food Cable
Color				
• of the insulation of data wires	red / green	red / green	red / green	red / green
• of the cable sheath	Violet	Blue	Violet	Black
Bending radius				
• with single bend	37.5 mm	37.5 mm	37.5 mm	30 mm
• with multiple bends	75 mm	75 mm	75 mm	60 mm
Traction stress maximum	100 N	100 N	100 N	100 N
Weight per length	80 kg/km	80 kg/km	71 kg/km	67 kg/km
<b>Permitted ambient conditions</b>				
Ambient temperature				
• during operating	-40 ... +75 °C	-40 ... +75 °C	-40 ... +60 °C	-40 ... +60 °C
• during storage	-40 ... +75 °C	-40 ... +75 °C	-40 ... +60 °C	-40 ... +60 °C
• during transport	-40 ... +75 °C	-40 ... +75 °C	-40 ... +60 °C	-40 ... +60 °C
• during installation	-40 ... +75 °C	-40 ... +75 °C	-40 ... +60 °C	-40 ... +60 °C
Burning behaviour	flame resistant according to IEC 60332-3-24 (Category C) and UL 1685 (CSA FT 4)	flame resistant according to IEC 60332-3-24 (Category C)	flame resistant according to IEC 60332-1	inflammable
Chemical resistance				
• to mineral oil	oil resistant according to IEC 60811-2-1 (4 hours / 70°C)	oil resistant according to IEC 60811-2-1 (4 hours / 70°C)	oil resistant according to IEC 60811-2-1 (7x24 hours / 90°C)	oil resistant according to IEC 60811-2-1 (4 hours / 70°C)
• to grease	Conditional resistance	Conditional resistance	Resistant	Conditional resistance
• to water	Conditional resistance	Conditional resistance	Conditional resistance	Conditional resistance
Radiological resistance to UV radiation	Resistant	Resistant	Resistant	Resistant
<b>Product properties, functions, components general</b>				
Product feature				
• halogen-free	No	No	No	No
• silicon-free	Yes	Yes	Yes	Yes
Cable length				
<b>Standards, specifications, approvals</b>				
UL/ETL listing with 300 V rating	Yes: c(UL)us, CMG / CL3 / Sun Res	Yes: CMG / CL3 / Sun Res	Yes: c(UL)us, CMX	No
UL/ETL style with 600 V rating	Yes	Yes	No	No
Verification of suitability				
• CE mark	Yes	Yes	Yes	Yes
• UL-registration	Yes	-	-	-
• RoHS conformity	Yes	Yes	Yes	Yes
Marine classification association				
• Germanische Lloyd (GL)	No	No	No	No
• Lloyds Register of Shipping (LRS)	No	No	No	No

### Technical specifications (continued)

Article No.	6XV1830-3FH10	6XV1831-2K	6XV1830-3EH10	6XV1831-2L
Product-type designation	PROFIBUS FC Ground Cable	PROFIBUS FC Flexible Cable	PROFIBUS FC Trailing Cable	PROFIBUS FC Trailing Cable
Product description	Special bus cable (2-core) with additional outer shield, sold by the meter, in bulk	Flexible bus cable (4-core), sold by the meter, in bulk	Highly flexible bus cable (2-core), sold by the meter, in bulk	Highly flexible bus cable (2-core), sold by the meter, in bulk
Acceptability for application	Used for buried cables	For occasionally moved machine parts	Continuous motion control in a cable carrier	Continuous motion control in a cable carrier
Cable designation	02YSY (ST) CY2Y 1x2x0.64/2.55-150 SW KF 40	02YH (ST) C11Y 1x2x0.65/2.56-150 LI KF40 FRNC FC VI	02YY (ST) C11Y 1x2x0.65/2.56-150 LI KF 40 FR petrol	02YY (ST) C11Y 1x2x0.65/2.56-150 LI KF 40 FR VT FC
<b>Electrical data</b>				
Damping ratio per length				
• at 9.6 kHz maximum	2.5 dB/km	3 dB/km	3 dB/km	3 dB/km
• at 38.4 kHz maximum	4 dB/km	4 dB/km	4 dB/km	4 dB/km
• at 4 MHz maximum	22 dB/km	25 dB/km	25 dB/km	25 dB/km
• at 16 MHz maximum	42 dB/km	49 dB/km	49 dB/km	49 dB/km
Impedance				
• Nominal value	150 Ω	150 Ω	150 Ω	150 Ω
• at 9.6 kHz	270 Ω	270 Ω	270 Ω	270 Ω
• at 38.4 kHz	185 Ω	185 Ω	185 Ω	185 Ω
• for frequency range 3 MHz ... 20 MHz	150 Ω	150 Ω	150 Ω	150 Ω
Relative symmetrical tolerance				
• of the surge impedance at 9.6 kHz	10 %	10 %	10 %	10 %
• of the surge impedance at 38.4 kHz	10 %	10 %	10 %	10 %
• of the surge impedance at 3 MHz ... 20 MHz	10 %	10 %	10 %	10 %
Loop resistance per length maximum	110 Ω/km	133 Ω/km	133 Ω/km	133 Ω/km
Shield resistance per length maximum	9.5 Ω/km	15 Ω/km	14 Ω/km	14 Ω/km
Capacity per length at 1 kHz	28.5 pF/m	28 pF/m	28 pF/m	28 pF/m
Operating voltage RMS value	100 V	100 V	100 V	100 V
<b>Mechanical data</b>				
Number of electrical wires	2	2	2	2
Design of shield	Overlapped aluminum-clad foil, sheathed in a braided screen of tin-plated copper wires	Overlapped aluminum-clad foil, sheathed in a braided screen of tin-plated copper wires	Overlapped aluminum-clad foil, sheathed in a braided screen of tin-plated copper wires	Overlapped aluminum-clad foil, sheathed in a braided screen of tin-plated copper wires
Design of the electrical connection FastConnect	Yes	Yes	Yes	Yes
Outer diameter				
• of the inner conductor	0.65 mm	0.67 mm	0.67 mm	0.67 mm
• of the wire insulation	2.55 mm	2.56 mm	2.56 mm	2.56 mm
• of the inner sheath of the cable	5.4 mm	5.4 mm	5.4 mm	5.4 mm
• of the cable sheath	10.8 mm	8 mm	8 mm	8 mm
Symmetrical tolerance of outer diameter of cable sheath	0.5 mm	0.4 mm	0.4 mm	0.4 mm
Outer diameter of the cable sheath Note	The cable (diameter 8.0 mm +/-0.4 mm) has an additional, black, outer sheath (diameter 10.8 mm +/-0.5 mm) as protection against damage caused by routing underground. Due to outer diameter > 8 mm: Bus connectors can only be connected after the outer sheath has been stripped	-	-	-

**PROFIBUS****Electrical networks (RS 485)****PROFIBUS bus cables****Technical specifications (continued)**

Article No.	6XV1830-3FH10	6XV1831-2K	6XV1830-3EH10	6XV1831-2L
Product-type designation	PROFIBUS FC Ground Cable	PROFIBUS FC Flexible Cable	PROFIBUS FC Trailing Cable	PROFIBUS FC Trailing Cable
Material				
• of the wire insulation	PE	PE	PE	PE
• of the inner sheath of the cable	PVC	FRNC	PVC	PVC
• of the cable sheath	PE/PVC	PUR	PUR	PUR
- Note	PVC (cable casing), PE (additional outer sheath)	-	-	-
Color				
• of the insulation of data wires	red / green	red / green	red / green	red / green
• of the cable sheath	Black	Violet	Petrol	Violet
Bending radius				
• with single bend	41 mm	40 mm	40 mm	40 mm
• with multiple bends	81 mm	120 mm	-	-
• with continuous bending	-	-	120 mm	120 mm
Number of bending cycles	-	-	3 000 000	3 000 000
• Note	-	-	-	For use in cable carriers, for 3 million bending cycles with a bending radius of 120 mm (15x D) and an acceleration of 4 m/s <sup>2</sup>
Traction stress maximum	100 N	100 N	100 N	100 N
Weight per length	117 kg/km	70 kg/km	77 kg/km	77 kg/km
<b>Permitted ambient conditions</b>				
Ambient temperature				
• during operating	-40 ... +60 °C	-20 ... +60 °C	-40 ... +60 °C	-40 ... +60 °C
• during storage	-40 ... +60 °C	-40 ... +60 °C	-40 ... +60 °C	-40 ... +60 °C
• during transport	-40 ... +60 °C	-40 ... +60 °C	-40 ... +60 °C	-40 ... +60 °C
• during installation	-40 ... +60 °C	-40 ... +60 °C	-40 ... +60 °C	-40 ... +60 °C
Ambient condition for (standard) operation mode	-	Limited segment length (see manual for PROFIBUS networks)	Limited segment length (see manual for PROFIBUS networks)	Limited segment length (see manual for PROFIBUS networks)
Burning behaviour	inflammable	flame resistant according to IEC 60332-1-2	flame resistant according to IEC 60332-1-2	flame resistant according to IEC 60332-1-2
Chemical resistance				
• to mineral oil	oil resistant according to IEC 60811-2-1 (4 hours / 70°C)	oil resistant according to IEC 60811-2-1 (7x24h/90°C)	oil resistant according to IEC 60811-2-1 (7x24h/90°C)	oil resistant according to IEC 60811-2-1 (7x24h/90°C)
• to grease	Conditional resistance	Resistant	Resistant	Resistant
• to water	Conditional resistance	Conditional resistance	Conditional resistance	Conditional resistance
Radiological resistance to UV radiation	Resistant	Resistant	Resistant	Resistant
<b>Product properties, functions, components general</b>				
Product feature				
• halogen-free	No	Yes	No	No
• silicon-free	Yes	Yes	Yes	Yes
<b>Standards, specifications, approvals</b>				
UL/ETL listing with 300 V rating	No	Yes: c(UL)us, CMX	Yes: c(UL)us, CMX	Yes: CMX
UL/ETL style with 600 V rating	No	No	No	No
Verification of suitability				
• CE mark	Yes	Yes	Yes	Yes
• RoHS conformity	Yes	Yes	Yes	Yes
Marine classification association				
• Germanische Lloyd (GL)	No	No	No	No
• Lloyds Register of Shipping (LRS)	No	No	No	No

### Technical specifications (continued)

Article No.	6XV1830-0LH10	6XV1830-3GH10	6XV1830-0PH10	6XV1830-0MH10
Product-type designation	PROFIBUS FC FRNC Cable GP	PROFIBUS Festoon Cable GP	PROFIBUS Torsion Cable	SIENOPYR FR Marine Cable
Product description	Highly flamed retardant, halogen-free bus cable (2-core), sold by the meter, in bulk	Flexible bus cable (2-core), sold by the meter, in bulk	Highly flexible bus cable (2-core), sold by the meter, in bulk	Bus cable (2-core), sold by the meter, in bulk
Acceptability for application	Halogen-free cable, suitable for use in buildings	Specially for festoon attachment	For use in moving machine components	
Cable designation	02YSH (ST) CH 1x2x0.64/2.55-150 VI KF 25 FRNC FC	02YS (ST) CY 1x2x0.65/2.56 LI petrol FR	02Y (ST) C 11Y 1x2x0.8/2.56-150 LI FR VI	M-02Y (ST) CH X 1 x 2 x 0.35 100 V
<b>Electrical data</b>				
Damping ratio per length				
• at 9.6 kHz maximum	2.5 dB/km	3 dB/km	2.5 dB/km	3 dB/km
• at 38.4 kHz maximum	4 dB/km	4 dB/km	3 dB/km	5 dB/km
• at 4 MHz maximum	22 dB/km	25 dB/km	25 dB/km	22 dB/km
• at 16 MHz maximum	42 dB/km	49 dB/km	49 dB/km	45 dB/km
Impedance				
• Nominal value	150 Ω	150 Ω	150 Ω	150 Ω
• at 9.6 kHz	270 Ω	270 Ω	270 Ω	250 Ω
• at 38.4 kHz	185 Ω	185 Ω	185 Ω	185 Ω
• for frequency range 3 MHz ... 20 MHz	150 Ω	150 Ω	150 Ω	150 Ω
Relative symmetrical tolerance				
• of the surge impedance at 9.6 kHz	10 %	10 %	10 %	10 %
• of the surge impedance at 38.4 kHz	10 %	10 %	10 %	10 %
• of the surge impedance at 3 MHz ... 20 MHz	10 %	10 %	10 %	10 %
Loop resistance per length maximum	110 Ω/km	133 Ω/km	98 Ω/km	110 Ω/km
Shield resistance per length maximum	9.5 Ω/km	19 Ω/km	14 Ω/km	-
Capacity per length at 1 kHz	28.5 pF/m	28 pF/m	29 pF/m	-
Operating voltage RMS value	100 V	100 V	100 V	100 V
<b>Mechanical data</b>				
Number of electrical wires	2	2	2	2
Design of shield	Overlapped aluminum-clad foil, sheathed in a braided screen of tin-plated copper wires	Overlapped aluminum-clad foil, sheathed in a braided screen of tin-plated copper wires	Overlapped aluminum-clad foil, sheathed in a braided screen of tin-plated copper wires	Overlapped aluminum-clad foil, sheathed in a braided screen of tin-plated copper wires
Design of the electrical connection FastConnect	Yes	No	No	No
Outer diameter				
• of the inner conductor	0.65 mm	0.67 mm	0.8 mm	0.67 mm
• of the wire insulation	2.55 mm	2.56 mm	2.56 mm	-
• of the inner sheath of the cable	5.4 mm	5.8 mm	6 mm	8 mm
• of the cable sheath	8 mm	8 mm	8 mm	9.8 mm
Symmetrical tolerance of outer diameter of cable sheath	0.4 mm	0.3 mm	0.4 mm	0.5 mm
Outer diameter of the cable sheath Note	-	-	-	Outer diameter > 8 mm: Bus connectors can only be connected after the outer sheath has been stripped
Material				
• of the wire insulation	PE	PE	PE	PE
• of the inner sheath of the cable	FRNC	-	-	Halogen-free polymer (HM4)
• of the cable sheath	FRNC	PVC	-	Halogen-free, cross-linked polymer
Color				
• of the insulation of data wires	red / green	red / green	red / green	red / green
• of the cable sheath	Violet	Petrol	Violet	Black
Bending radius				
• with single bend minimum permissible	60 mm	30 mm	30 mm	98 mm
• with multiple bends minimum permissible	80 mm	70 mm	60 mm	196 mm
• with continuous bending	-	70 mm	60 mm	-
• Note	-	-	Not suitable for installation in festoons	-

# PROFIBUS

## Electrical networks (RS 485)

### PROFIBUS bus cables

#### Technical specifications (continued)

Article No.	6XV1830-0LH10	6XV1830-3GH10	6XV1830-0PH10	6XV1830-0MH10
Product-type designation	PROFIBUS FC FRNC Cable GP	PROFIBUS Festoon Cable GP	PROFIBUS Torsion Cable	SIENOPYR FR Marine Cable
Number of torsion cycles with torsion by $\pm 180^\circ$ on 1 m cable length	-	-	5 000 000	-
Traction stress maximum	100 N	80 N	100 N	100 N
Weight per length	72 kg/km	64 kg/km	65 kg/km	110 kg/km
<b>Permitted ambient conditions</b>				
Ambient temperature				
• during operating	-25 ... +80 °C	-40 ... +80 °C	-25 ... +75 °C	-35 ... +80 °C
• during storage	-25 ... +80 °C	-40 ... +80 °C	-40 ... +80 °C	-35 ... +80 °C
• during transport	-25 ... +80 °C	-40 ... +80 °C	-40 ... +80 °C	-35 ... +80 °C
• during installation	-25 ... +80 °C	-40 ... +80 °C	-25 ... +75 °C	-15 ... +80 °C
Ambient condition for (standard) operation mode	-	-	-	At ambient temperatures below -15 degrees Celsius, the cable must not be subjected to any movements other than the normal vibration levels encountered on board ship
Burning behaviour	flame resistant according to IEC 60332-3-24 (Category C), IEC 60332-3-22 (Category A), EN 50267-2-1/2, IEC 61034	flame resistant according to IEC 60332-3-24 (Category C)	flame resistant according to IEC 60332-1-2	flame resistant according to IEC 60332-3-24, IEC 607542, IEC 61031
Chemical resistance				
• to mineral oil	oil resistant according to IEC 60811-2-1 (4 h / 70°C)	Conditional resistance	oil resistant according to IEC 60811-2-1 (7x24h/90°C)	Resistant to diesel fuel according to DIN VDE 51601, ASTM oil No. 2 according to DIN 53521, oil, NATOCode 0178, BWTL 91500031/2 according to VG 95214 Part 4, hydraulic fluid, NATOCode H515, BWTL 91500020 according to VG 95214 Part 4, cold cleaning solvent, BW-TL 68500017 according to VG 95214 Part 4, deionized water according to VG 95214 Part 4, deionized water with 3.5% NaCl
• to grease	Conditional resistance	Conditional resistance	Resistant	Resistant
• to water	Conditional resistance	Conditional resistance	Conditional resistance	Conditional resistance
Radiological resistance to UV radiation	Resistant	Resistant	Resistant	Resistant
<b>Product properties, functions, components general</b>				
Product feature				
• halogen-free	Yes	No	Yes	Yes
• silicon-free	Yes	Yes	Yes	Yes
<b>Standards, specifications, approvals</b>				
UL/ETL listing with 300 V rating	Yes: c(UL)us, CM / CL3 / Sun Res	Yes: CMG / PLCT / Sun Res / Oil Res	Yes: CMX	No
UL/ETL style with 600 V rating	Yes	Yes	No	No
Verification of suitability				
• CE mark	Yes	Yes	Yes	-
• RoHS conformity	Yes	-	Yes	-
Marine classification association				
• Germanische Lloyd (GL)	No	No	No	Yes
• Lloyds Register of Shipping (LRS)	No	No	No	Yes



**Technical specifications (continued)**

Article No.	6XV1860-2R	6XV1860-2S
Product-type designation	PROFIBUS Hybrid Standard Cable GP	PROFIBUS Hybrid Robust Cable
Product description	Hybrid cable (data and power cores), sold by the meter, in bulk	Hybrid cable (data and power cores), sold by the meter, in bulk
Acceptability for application	Trailing-type, hybrid cable used for supplying data and power to ET 200pro	Rugged cable for supplying data and power to ET 200pro under conditions of high mechanical loading. Cable resistance to weld spatter according to HD22.2 S3 / 5
Cable designation	02Y(ST)C 1x2x0.65/2.56-150LI LIY-Z Y 2x1x1.5 VI	02Y(ST)C 1x2x0.65/2.56-150LI LIH-Z 11Y 2x1x1.5 VI FRNC
<b>Electrical data</b>		
Damping ratio per length		
• at 9.6 kHz maximum	4 dB/km	4 dB/km
• at 38.4 kHz maximum	4 dB/km	4 dB/km
• at 4 MHz maximum	25 dB/km	25 dB/km
• at 16 MHz maximum	49 dB/km	49 dB/km
Impedance		
• Nominal value	150 Ω	150 Ω
• at 9.6 kHz	270 Ω	270 Ω
• at 38.4 kHz	185 Ω	185 Ω
• for frequency range 3 MHz ... 20 MHz	150 Ω	150 Ω
Relative symmetrical tolerance		
• of the surge impedance at 9.6 kHz	10 %	10 %
• of the surge impedance at 38.4 kHz	10 %	10 %
• of the surge impedance at 3 MHz ... 20 MHz	10 %	10 %
Loop resistance per length maximum	138 Ω/km	138 Ω/km
Shield resistance per length maximum	10 Ω/km	10 Ω/km
Capacity per length at 1 kHz	30 pF/m	30 pF/m
Operating voltage RMS value	300 V	300 V
Conductor cross section of the power wires	1.5 mm <sup>2</sup>	1.5 mm <sup>2</sup>
Continuous current of the power wires	7.5 A	7.5 A
<b>Mechanical data</b>		
Design of shield	Overlapped aluminum-clad foil, sheathed in a braided screen of tin-plated copper wires	Overlapped aluminum-clad foil, sheathed in a braided screen of tin-plated copper wires
Number of electrical wires	4	4
Design of the electrical connection FastConnect	No	No
Outer diameter		
• of the wire insulation	2.56 mm	2.56 mm
• of the cable sheath	11 mm	11 mm
Symmetrical tolerance of outer diameter of cable sheath	0.5 mm	0.5 mm
Material		
• of the wire insulation	PE	PE
Material	PVC	PUR
Color		
• of the insulation of data wires	red / green	red / green
• of the power wire insulation	Black	Black
• of the cable sheath	Violet	Violet
Bending radius Bending radius		
• with single bend minimum permissible	44 mm	44 mm
• with multiple bends minimum permissible	125 mm	125 mm
Number of bending cycles	1 000 000	3 000 000
• Note	For use in cable carriers, for 1 million bending cycles with a bending radius of 125 mm and an acceleration of 2.5 m/s <sup>2</sup>	For use in cable carriers, for 3 million bending cycles with a bending radius of 125 mm and an acceleration of 2.5 m/s <sup>2</sup>
Traction stress maximum	450 N	450 N
Weight per length	140 kg/km	135 kg/km

**PROFIBUS**

## Electrical networks (RS 485)

## PROFIBUS bus cables

**Technical specifications** (continued)

Article No.	6XV1860-2R	6XV1860-2S
Product-type designation	PROFIBUS Hybrid Standard Cable GP	PROFIBUS Hybrid Robust Cable
<b>Permitted ambient conditions</b>		
Ambient temperature		
• during operating	-40 ... +75 °C	-40 ... +75 °C
• during storage	-40 ... +75 °C	-40 ... +75 °C
• during transport	-40 ... +75 °C	-40 ... +75 °C
• during installation	-40 ... +75 °C	-40 ... +75 °C
Burning behaviour	flame resistant according to IEC 60332-1-2	flame resistant according to IEC 60332-1-2
Chemical resistance		
• to mineral oil	Conditional resistance	Resistant
• to grease	Conditional resistance	Resistant
Radiological resistance to UV radiation	not resistant	resistant
<b>Product properties, functions, components general</b>		
Product feature		
• halogen-free	No	Yes
• silicon-free	Yes	Yes
<b>Standards, specifications, approvals</b>		
UL/ETL listing with 300 V rating	Yes: CMG	Yes: CMX
UL/ETL style with 600 V rating	No	No
Verification of suitability		
• RoHS conformity	Yes	Yes

Ordering data	Article No.	Article No.	
<b>PROFIBUS FC Standard Cable GP</b> Standard type with special design for fast mounting, 2-core, shielded, Sold by the meter; max. length 1 000 m, minimum order 20 m <u>Not pre-assembled</u> <ul style="list-style-type: none"> <li>• 20 m</li> <li>• 50 m</li> <li>• 100 m</li> <li>• 200 m</li> <li>• 500 m</li> <li>• 1 000 m</li> </ul> <u>In spool box</u> <ul style="list-style-type: none"> <li>• 50 m</li> <li>• 100 m</li> </ul>	<b>6XV1830-0EH10</b>  <b>6XV1830-0EN20</b> <b>6XV1830-0EN50</b> <b>6XV1830-0ET10</b> <b>6XV1830-0ET20</b> <b>6XV1830-0ET50</b> <b>6XV1830-0EU10</b>  <b>6XV1830-1EN50</b> <b>6XV1830-1ET10</b>	<b>PROFIBUS Torsion Cable</b> 2-core, shielded Sold by the meter; max. length 1 000 m, minimum order 20 m  <b>PROFIBUS Hybrid Standard Cable GP</b> PROFIBUS hybrid cable suitable as trailing cable and resistant to welding spatter, with 2 power conductors (1.5 mm <sup>2</sup> ) for supply of data and power to ET 200pro  <b>PROFIBUS Hybrid Robust Cable</b> Rugged PROFIBUS hybrid cable suitable as trailing cable and resistant to welding spatter, with 2 power conductors (1.5 mm <sup>2</sup> ) for supply of data and power to ET 200pro	<b>6XV1830-0PH10</b>  <b>6XV1860-2R</b>  <b>6XV1860-2S</b>
<b>PROFIBUS FC Standard Cable IS GP</b> Standard type with special design for quick assembly, 2-core, shielded, for intrinsically safe distributed I/O systems Sold by the meter; max. length 1 000 m, minimum order 20 m	<b>6XV1831-2A</b>	<b>SIENOPYR PROFIBUS shipboard cable</b> Copper cable for ships and offshore units Sold by the meter; max. length 1 000 m, minimum order 20 m	<b>6XV1830-0MH10</b>
<b>PROFIBUS FC Robust Cable</b> 2-core, shielded Sold by the meter; max. length 1 000 m, minimum order 20 m	<b>6XV1830-0JH10</b>	<b>Additional components</b> <b>PROFIBUS FastConnect Stripping Tool</b> Preadjusted stripping tool for fast stripping of PROFIBUS FastConnect bus cables	<b>6GK1905-6AA00</b>
<b>PROFIBUS FC Food Cable</b> 2-core, shielded Sold by the meter; max. length 1 000 m, minimum order 20 m	<b>6XV1830-0GH10</b>	<b>PROFIBUS FastConnect Blade Cassettes</b> Spare blade cassettes for PROFIBUS FastConnect stripping tool, 5 units	<b>6GK1905-6AB00</b>
<b>PROFIBUS FC Ground Cable</b> 2-core, shielded Sold by the meter; max. length 1 000 m, minimum order 20 m	<b>6XV1830-3FH10</b>	<b>PROFIBUS FastConnect bus connector RS485 with 90° cable outlet</b> With insulation displacement terminals, max. transfer rate 12 Mbit/s <ul style="list-style-type: none"> <li>• Without PG interface</li> <li>• With PG interface</li> </ul>	<b>6ES7972-0BA52-0XA0</b> <b>6ES7972-0BB52-0XA0</b>
<b>PROFIBUS FC Flexible Cable</b> 2-core, shielded Sold by the meter; max. length 1 000 m, minimum order 20 m	<b>6XV1831-2K</b>	<b>PROFIBUS FastConnect bus connector RS485 Plug 180</b> With 180° cable outlet, insulation displacement	<b>6GK1500-0FC10</b>
<b>PROFIBUS FC Trailing Cable</b> 2-core, shielded Sold by the meter; max. length 1 000 m, minimum order 20 m <ul style="list-style-type: none"> <li>• Sheath color: Petrol</li> <li>• Sheath color: Violet</li> </ul>	<b>6XV1830-3EH10</b> <b>6XV1831-2L</b>	<b>Accessories</b> <b>Lightning protection modules for reliable transmission between buildings with overvoltage protection<sup>1)</sup></b> Basic protection <ul style="list-style-type: none"> <li>• Basic section</li> <li>• Protection module Type B</li> <li>• Protective housing</li> <li>• Terminal element</li> </ul> Low-voltage protection <ul style="list-style-type: none"> <li>• Basic section</li> <li>• Protection module</li> <li>• Terminal element</li> </ul>	<b>919506</b> <b>919510</b> <b>906055</b> <b>919508</b>  <b>919506</b> <b>919570</b> <b>919508</b>
<b>PROFIBUS Festoon Cable GP</b> 2-core, shielded Sold by the meter; max. length 1 000 m, minimum order 20 m	<b>6XV1830-3GH10</b>	<b>SIMATIC NET Manual Collection</b> Electronic manuals for communication systems, communication protocols, and communication products; on DVD; German/English	<b>6GK1975-1AA00-3AA0</b>
<b>PROFIBUS FC FRNC Cable GP</b> 2-core, shielded, nonflammable, with copolymer outer sheath FRNC Sold by the meter; max. length 1 000 m, minimum order 20 m	<b>6XV1830-0LH10</b>		

<sup>1)</sup> Order from:  
 DEHN & Söhne  
 Hans-Dehn-Str.1  
 92318 Neumarkt/Opf, Germany

## PROFIBUS

### Electrical networks (RS 485)

#### PROFIBUS bus cables

#### More information

##### Installation instructions

The bus cables are supplied by the meter. If a bus segment must be assembled using two sections (e.g. > 1 000 m segment length), bushings can be used for this purpose (low-impedance connection between cores with clamps, connect shields over a wide area).

##### FastConnect

The FastConnect stripping tool can be used to strip the outer sheath and shield of the new FastConnect bus cables to the right length in one step.

In this way, the bus connectors (except 6ES7972-0BA30-0XA0) can be connected easily and quickly to the bus cable.

##### Migration in discrete automation

For many years, PROFIBUS has been the established fieldbus for machines and plants and with the wider use of Ethernet in IT and PROFINET in industry, production systems today would be unimaginable without either of these systems.

For migration from PROFIBUS to PROFINET or Industrial Ethernet in discrete automation, Siemens offers a solution in which the existing two-wire cabling for Ethernet communication can be used.

For further information on this, please refer to Section 2 and the Internet at: [www.siemens.com/vd](http://www.siemens.com/vd)

##### Cable routing:

During storage, transport and cable laying, keep both ends sealed with a shrink-on cap.

Comply with the permissible bending radii and tensile load!

An underground cable must be used if cables are laid outside buildings e.g. directly in the ground, in sand or in concrete building blocks or when routed through protective pipes made of steel or plastic above or below ground.

Comply with overvoltage protection guidelines for underground laying.

##### Note:

You can order components supplementary to the SIMATIC NET cabling range from your local contact.

Technical advice on this subject is available from:

J. Hertlein  
 I IA SC CI PRM 4  
 Phone: 0911/750 44 65  
 E-mail: [juergen.hertlein@siemens.com](mailto:juergen.hertlein@siemens.com)

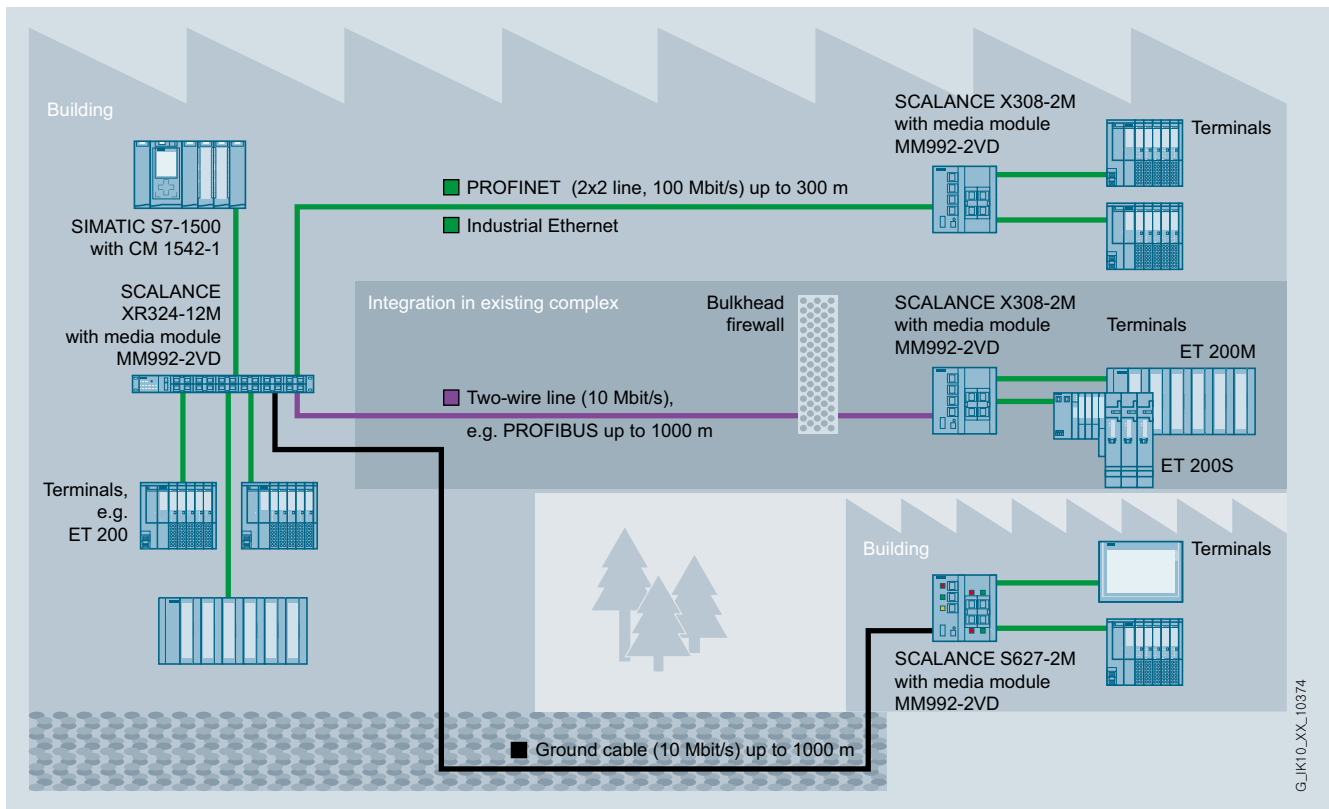

### Overview

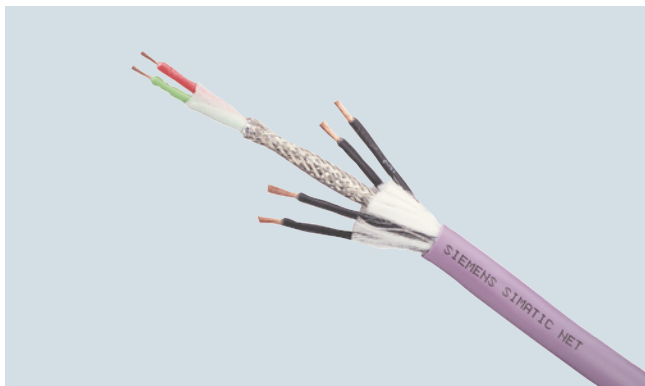

In the ECOFAST system, all devices with bus capability are connected to PROFIBUS DP using the bus cables.

The bus cable is implemented as a hybrid cable and contains:

- PROFIBUS DP in copper RS 485;
- Four additional copper cores for carrying 24 V DC:
  - 24 V DC, not switched (for electronics and inputs)
  - 24 V DC, switched (for outputs, disconnectable e.g. for EMERGENCY OFF)

The ECOFAST hybrid cables are sold by the meter or in fixed lengths preassembled with ECOFAST connector (Han Brid) and socket.

### Benefits

- Savings in wiring, installation, commissioning and operation as result of standardized connection system (copper or fiber-optic) with high degree of protection (IP65)
- With ECOFAST, the turnaround times for offers, planning and engineering of machines and plants can be reduced
- ECOFAST permits fast and problem-free startup of automation and drive systems
- Minimization of sources of error by means of standardized interfaces and plug connectors.
- With ECOFAST plants remain highly available: No interruption of power and fieldbus when replacing equipment.

### Technical specifications

Article No.	6XV1830-7AH10	6XV1860-2P
Product-type designation	PROFIBUS ECOFAST Hybrid Cable	PROFIBUS ECOFAST Hybrid Cable GP
Product description	ECOFAST hybrid cable (data and power cores), sold by the meter, in bulk	ECOFAST hybrid cable (data and power cores), sold by the meter, in bulk
Acceptability for application	Hybrid cable for connection of ECOFAST stations	Hybrid cable for connection of ECOFAST stations, UL approval
Cable designation	02Y (ST) C 1 x 2 x 0.65/2.56 - 150 LI LIH-Z 11Y 4 x 1 x 1.5 VI FRNC	02Y (ST)C 1x2x0.65/2.56 - 150 LI LIY-Z Y 4x1x1.5 VI
<b>Electrical data</b>		
Damping ratio per length		
• at 9.6 kHz maximum	0.004 dB/m	0.004 dB/m
• at 38.4 kHz maximum	0.004 dB/m	0.004 dB/m
• at 4 MHz maximum	0.025 dB/m	0.025 dB/m
• at 16 MHz maximum	0.049 dB/m	0.049 dB/m
Impedance		
• Nominal value	150 Ω	150 Ω
• at 9.6 kHz	270 Ω	270 Ω
• at 38.4 kHz	185 Ω	185 Ω
• for frequency range 3 MHz ... 20 MHz	150 Ω	150 Ω
Relative symmetrical tolerance		
• of the surge impedance at 9.6 kHz	10 %	10 %
• of the surge impedance at 38.4 kHz	10 %	10 %
• of the surge impedance at 3 MHz ... 20 MHz	10 %	10 %
Loop resistance per length maximum	138 Ω/km	138 Ω/km
Shield resistance per length maximum	15 Ω/km	15 Ω/km
Capacity per length at 1 kHz	30 pF/m	30 pF/m
Inductance per length	-	-
Operating voltage RMS value	100 V	600 V
Conductor cross section of the power wires	1.5 mm <sup>2</sup>	1.5 mm <sup>2</sup>
Continuous current of the power wires	12 A	12 A

# PROFIBUS

## Electrical networks (RS485)

### ECOFAST bus cables

#### Technical specifications (continued)

Article No.	6XV1830-7AH10	6XV1860-2P
Product-type designation	PROFIBUS ECOFAST Hybrid Cable	PROFIBUS ECOFAST Hybrid Cable GP
<b>Mechanical data</b>		
Design of shield	Overlapped aluminum-clad foil, sheathed in a braided screen of tin-plated copper wires	Overlapped aluminum-clad foil, sheathed in a braided screen of tin-plated copper wires
Number of electrical wires	6	6
Design of the electrical connection FastConnect	No	No
Outer diameter		
• of the wire insulation	2.56 mm	2.56 mm
• of the cable sheath	11 mm	11 mm
Symmetrical tolerance of outer diameter of cable sheath	0.3 mm	0.3 mm
Material		
• of the wire insulation	PE	PE
• of the cable sheath	PUR	PVC
Color		
• of the insulation of data wires	red / green	red / green
• of the power wire insulation	Black	Black
• of the cable sheath	Violet	Violet
Bending radius		
• with multiple bends minimum permissible	82.5 mm	110 mm
Number of bending cycles	5 000 000	1 000 000
• Note	For use in cable carriers, for 5 million bending cycles with a bending radius of 82.5 mm (7.5x D) and an acceleration of 2.5 m/s <sup>2</sup>	For use in cable carriers, for 1 million bending cycles with a bending radius of 166 mm (15x D) and an acceleration of 4.0 m/s <sup>2</sup>
Traction stress maximum	300 N	300 N
Weight per length	150 kg/km	154 kg/km
<b>Permitted ambient conditions</b>		
Ambient temperature		
• during operating	-40 ... +60 °C	-30 ... +80 °C
• during storage	-40 ... +60 °C	-30 ... +80 °C
• during transport	-40 ... +60 °C	-30 ... +80 °C
• during installation	-40 ... +60 °C	-30 ... +80 °C
Burning behaviour		
Chemical resistance		
• to mineral oil	Conditional resistance	Conditional resistance
• to grease	Conditional resistance	Conditional resistance
Radiological resistance to UV radiation	resistant	resistant
<b>Product properties, functions, components general</b>		
Product feature		
• halogen-free	Yes	Yes
• silicon-free	Yes	Yes
<b>Standards, specifications, approvals</b>		
UL/ETL listing with 300 V rating	No	No
UL/ETL style with 600 V rating	No	Yes: CM / CL3 / SunRes / OilRes
Verification of suitability		
• RoHS conformity	Yes	Yes

**Technical specifications (continued)**

Article No.	6GK1905-0CA00	6GK1905-0CB00	6GK1905-0CC00	6GK1905-0CD00
Product-type designation	PB ECOFAST Hybrid Plug 180	PB ECOFAST Hybrid Plug 180	PB ECOFAST Hybrid Plug angled	PB ECOFAST Hybrid Plug angled
Product description	ECOFAST Hanbrid connector with pin insert	ECOFAST Hanbrid connector with socket insert	ECOFAST Hanbrid connector with pin insert, angled	ECOFAST Hanbrid connector with socket insert, angled
Acceptability for application	For connection to ECOFAST hybrid cables, transmission of data and power	For connection to ECOFAST hybrid cables, transmission of data and power	For connection to ECOFAST hybrid cables, transmission of data and power	For connection to ECOFAST hybrid cables, transmission of data and power
<b>Transmission rate</b>				
Transfer rate with PROFIBUS	9.6 kbit/s ... 12 Mbit/s	9.6 kbit/s ... 12 Mbit/s	9.6 kbit/s ... 12 Mbit/s	9.6 kbit/s ... 12 Mbit/s
<b>Interfaces</b>				
Number of electrical connections				
• for PROFIBUS cables	1	1	1	1
• for network components and terminal equipment	1	1	1	1
Design of electrical connection				
• for PROFIBUS cables	Integrated crimp contacts for 6-core ECOFAST hybrid cables	Integrated crimp contacts for 6-core ECOFAST hybrid cables	Integrated crimp contacts for 6-core ECOFAST hybrid cables	Integrated crimp contacts for 6-core ECOFAST hybrid cables
• for network components and terminal equipment	Hanbrid connector with male insert	Hanbrid connector with female insert	Hanbrid connector with male insert	Hanbrid connector with female insert
<b>Mechanical data</b>				
Material of the enclosure	plastic	plastic	plastic	plastic
<b>Design, dimensions and weight</b>				
Type of cable outlet	180 degree cable outlet	180 degree cable outlet	90 degree cable outlet	90 degree cable outlet
Width	27 mm	27 mm	27 mm	27 mm
Height	27 mm	27 mm	27 mm	27 mm
Depth	71 mm	71 mm	71 mm	71 mm
Net weight	40 g	40 g	40 g	40 g
<b>Permitted ambient conditions</b>				
Ambient temperature				
• during operating	-20 ... +70 °C	-20 ... +70 °C	-20 ... +70 °C	-20 ... +70 °C
• during storage	-40 ... +80 °C	-40 ... +80 °C	-40 ... +80 °C	-40 ... +80 °C
• during transport	-40 ... +80 °C	-40 ... +80 °C	-40 ... +80 °C	-40 ... +80 °C
Protection class IP	IP65/67	IP65/67	IP65/67	IP65/67
Chemical resistance to water	resistant	resistant	resistant	resistant
<b>Product properties, functions, components general</b>				
Product feature silicon-free	Yes	Yes	Yes	Yes
Product component strain relief	Yes	Yes	Yes	Yes
<b>Standards, specifications, approvals</b>				
Verification of suitability RoHS conformity	Yes	Yes	Yes	Yes

# PROFIBUS

## Electrical networks (RS485)

### ECOFAST bus cables

#### Technical specifications (continued)

Article No.	6GK1905-0DA10
Product-type designation	PB ECOFAST Terminating Plug
Product description	ECOFAST bus terminating plug connector with pin insert and integral terminating resistors
Acceptability for application	As terminating plug-in connector for PROFIBUS DP
<b>Transmission rate</b>	
Transfer rate with PROFIBUS	9.6 kbit/s ... 12 Mbit/s
<b>Interfaces</b>	
Number of electrical connections	
• for PROFIBUS cables	-
• for network components and terminal equipment	1
Design of electrical connection	
• for PROFIBUS cables	-
• for network components and terminal equipment	Hanbrid connector with female insert
Number of optical interfaces for optical waveguide	-
Design of optical connections for network components or terminal devices	-
<b>Mechanical data</b>	
Design of terminating resistor	Integrated resistor combination
Material of the enclosure	plastic

Article No.	6GK1905-0DA10
Product-type designation	PB ECOFAST Terminating Plug
<b>Design, dimensions and weight</b>	
Type of cable outlet	180 degree cable outlet
Width	27 mm
Height	27 mm
Depth	71 mm
Net weight	40 g
<b>Permitted ambient conditions</b>	
Ambient temperature	
• during operating	-20 ... +70 °C
• during storage	-40 ... +80 °C
• during transport	-40 ... +80 °C
Relative humidity at 25 °C without condensation during operating maximum	-
Protection class IP	IP65/67
Chemical resistance to water	resistant
<b>Product properties, functions, components general</b>	
Product feature silicon-free	Yes
Product component strain relief	Yes
<b>Standards, specifications, approvals</b>	
Verification of suitability RoHS conformity	Yes



Ordering data	Article No.	Article No.
<b>PROFIBUS ECOFAST Hybrid Cable - Cu</b> Trailing cable (PUR sheath), with two shielded Cu wires for PROFIBUS DP plus four Cu wires of 1.5 mm <sup>2</sup> Sold by the meter; max. length 1 000 m; minimum order 20 m Pre-assembled with ECOFAST male and female connectors, fixed length <ul style="list-style-type: none"> <li>• 0.5 m</li> <li>• 1.0 m</li> <li>• 1.5 m</li> <li>• 3 m</li> <li>• 5 m</li> <li>• 10 m</li> <li>• 15 m</li> <li>• 20 m</li> </ul> Pre-assembled with two ECOFAST connectors, variable length	<b>6XV1830-7AH10</b>  <b>6XV1830-7BH05</b> <b>6XV1830-7BH10</b> <b>6XV1830-7BH15</b> <b>6XV1830-7BH30</b> <b>6XV1830-7BH50</b> <b>6XV1830-7BN10</b> <b>6XV1830-7BN15</b> <b>6XV1830-7BN20</b>	<b>Additional components</b> <b>PROFIBUS Cu bus connector</b> with 2 x Cu shielded and 4 x Cu 1.5 mm <sup>2</sup> ; type of contact: POF, Han D for 24 V; tool: crimping tool, polishing set; 5 units; with assembly instructions <ul style="list-style-type: none"> <li>• with pin insert</li> <li>• with socket insert</li> </ul> <b>PROFIBUS ECOFAST Hybrid Plug angled;</b> with 2 x Cu shielded and 4 x Cu 1.5 mm <sup>2</sup> ; 5 units; with installation instructions <ul style="list-style-type: none"> <li>• Male pins</li> <li>• Female pins;</li> </ul> <b>ECOFAST Terminating Plug</b> Bus termination plug-in connector for PROFIBUS DP; with 2 x Cu and 4 x Cu 1.5 mm <sup>2</sup> ; male pins, integrated termination resistors <ul style="list-style-type: none"> <li>• Pack of 1</li> <li>• Pack of 5</li> </ul> <b>Data T piece</b> For 2 x 24 V auxiliary voltage (switched and non-switched) and PROFIBUS DP <ul style="list-style-type: none"> <li>• for Cu RS485</li> <li>• for fiber-optic cable</li> </ul> <b>Addressing plug</b> For setting the PROFIBUS DP addresses
		<b>6GK1905-0CA00</b> <b>6GK1905-0CB00</b>  <b>6GK1905-0CC00</b> <b>6GK1905-0CD00</b>  <b>6GK1905-0DA10</b> <b>6GK1905-0DA00</b>  <b>3RK1911-2AG00</b> <b>3RK1911-2AH00</b>  <b>6ES7194-1KB00-0XA0</b>
<b>PROFIBUS ECOFAST Hybrid Cable GP</b> Trailing cable with 4 x Cu and 2 x Cu, shielded, with UL approval Sold by the meter; max. quantity 1 000 m; minimum order 20 m; Pre-assembled with ECOFAST male and female connectors <ul style="list-style-type: none"> <li>• 0.5 m</li> <li>• 1 m</li> <li>• 1.5 m</li> <li>• 3 m</li> <li>• 5 m</li> <li>• 10 m</li> <li>• 15 m</li> <li>• 20 m</li> </ul>	<b>6XV1860-2P</b>  <b>6XV1860-3PH05</b> <b>6XV1860-3PH10</b> <b>6XV1860-3PH15</b> <b>6XV1860-3PH30</b> <b>6XV1860-3PH50</b> <b>6XV1860-3PN10</b> <b>6XV1860-3PN15</b> <b>6XV1860-3PN20</b>	

**More information**

You can order components supplementary to the SIMATIC NET cabling range from your local contact.

Technical advice on this subject is available from:

J. Hertlein  
 I IA SC CI PRM 4  
 Phone: +49 (911) 750-4465  
 E-mail: [juergen.hertlein@siemens.com](mailto:juergen.hertlein@siemens.com)

## PROFIBUS

### Electrical networks (RS485)

#### Hybrid fieldbus connections

##### Overview



Hybrid fieldbus connection with two HanBrid sockets



Control cabinet bushing with two M12 sockets

Hybrid fieldbus connections with HanBrid sockets designed as cabinet bushings transmit data and energy from the control cabinet (IP20) to the field (IP65). They are the interface for jointly routing PROFIBUS DP and the auxiliary voltages into the hybrid fieldbus cable.

On the cabinet bushings with two M12 sockets for the PROFIBUS M12 connecting cables, the 24 V supply of the motor starters is implemented via separate 7/8" connecting cables.

#### **Passive and active hybrid fieldbus connections**

The hybrid fieldbus connections are available in two versions which differ in their functionality. These are:

- The passive version
- The active version with signal refresher function to considerably increase the maximum PROFIBUS cable length

#### Connection methods

The field side is connected using HanBrid or M12 plug-in connectors.

In the case of HanBrid, the following versions are available:

- Socket/socket for infeeding into the field
- Pin/socket for looping in the field

The M12 version is generally configured with socket/socket.

Following connections are available at the rear (cabinet side) in the case of the passive glands:

- Direct connection
- Fast Connect connection

The active gland with refresher function has 9-pole Sub-D sockets for the rear connection.

#### Auxiliary power infeed

The HanBrid plug-in design offers the possibility of infeeding or looping through not only the Profibus signal but also 2 separate auxiliary voltages of 24 V DC (switched/unswitched) into the field. The terminal block with spring-type terminals at the rear (cabinet side) of the hybrid fieldbus connection provides a variety of interconnecting operations for these auxiliary voltages.

#### **Passive hybrid fieldbus connections**

- Gland from the control cabinet (IP20) into the field (IP65)
- HanBrid plug-in design socket/socket or pin/socket
- Direct connection or Fast-Connect connection for PROFIBUS at the rear
- Terminal block with spring-type terminals (0.25 ... 2.5 mm<sup>2</sup>) for infeeding or looping through the auxiliary voltages

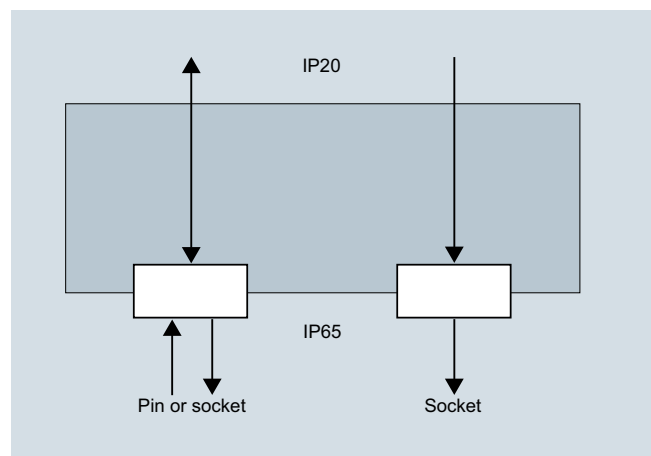

Hybrid fieldbus connection as passive cabinet bushing

**Overview** (continued)

**Active hybrid fieldbus connections with refresher function**

- Gland from the control cabinet (IP20) into the field (IP65)
- 3 independent, electrically separated Profibus segments
- Signal refresher function from and to all segments
- Automatic continuous baud rate detection
- Status/diagnostics displays with LEDs
- Cascading depth of a maximum 9 hybrid fieldbus connections
- HanBrid plug-in design socket/socket and pin/socket
- M12 plug-in design socket/socket
- 9-pole Sub D socket connection for PROFIBUS at the rear
- Terminal block with spring-type terminals (0.25 ... 2.5 mm<sup>2</sup>) for infeeding or looping through the auxiliary voltages

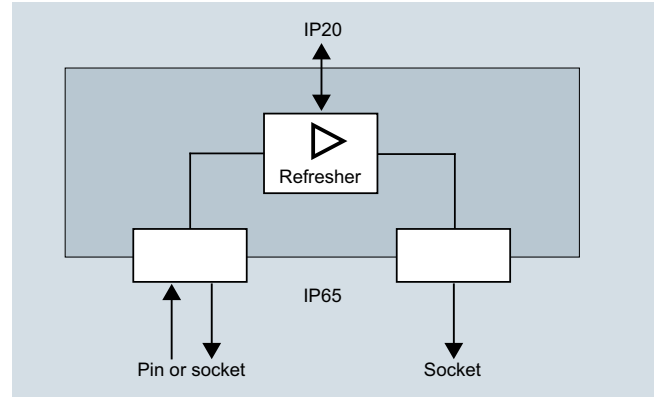

Hybrid fieldbus connection as active control cabinet bushing with refresher function

3

**Selection and ordering data**



Hybrid fieldbus connection on the field side:  
With socket/socket (HanBrid)



With pin/socket (HanBrid)



Control cabinet bushing on the field side:  
With socket/socket (M12)

Link type / function	Connection IP65	Connection IP20 (PROFIBUS)	Article No.
----------------------	-----------------	----------------------------	-------------

**Hybrid fieldbus connections**

**Passive**

• Cu/Cu, for feeding into the field	Socket/socket (2 x HanBrid)	Direct connection	<b>3RK1911-1AA22</b> <b>3RK1911-1AA32</b> <b>3RK1911-1AF22</b>
• Cu/Cu, for looping through in the field	Pin/socket (2 x HanBrid)	Direct connection	
• Cu/Cu, for feeding into the field	Socket/socket (2 x HanBrid)	PROFIBUS Fast Connect bus connector	
• Cu/Cu, for looping through in the field	Pin/socket (2 x HanBrid)	PROFIBUS Fast Connect bus connector	<b>3RK1911-1AF32</b>

**Active (refresher)**

• Cu/Cu, for feeding into the field	Socket/socket (2 x HanBrid)	9-pole Sub-D socket	<b>3RK1911-1AJ22</b> <b>3RK1911-1AJ32</b> <b>3RK1911-1AK22</b>
• Cu/Cu, for looping through in the field	Pin/socket (2 x HanBrid)	9-pole Sub-D socket	
• Cu/Cu, for feeding into the field	Socket/socket (2 x M12)	9-pole Sub-D socket	

Version	Article No.
---------	-------------

**Accessories**



6ES7194-1JB10-0XA0

**Sealing caps for HanBrid**

Protective cover for bus and power supply connections (pack of 10)

**6ES7194-1JB10-0XA0**

## PROFIBUS

### Electrical networks (RS485)

#### Energy cables

##### Overview

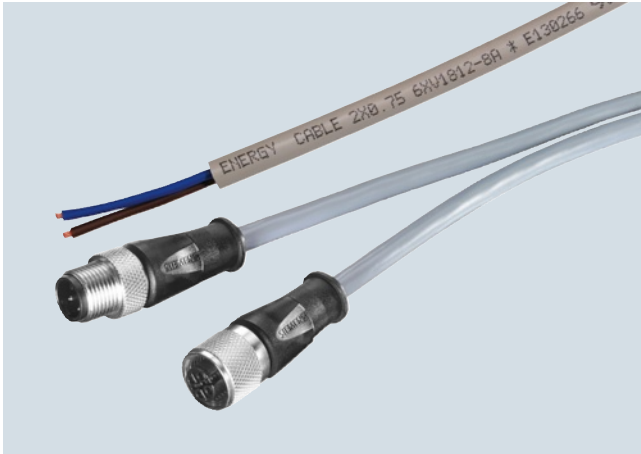

- Different versions (5-core, 2-core) for different fields of application
- Pre-assembled M12 plug-in cables for energy transfer
- Rugged cable design for installation in industrial applications
- UL approvals
- Easy length measurement thanks to printed meter markings

##### Benefits

**get** Designed for Industry

- Flexible application possibilities thanks to rugged cable design
- Silicon-free, therefore particularly suitable for use in the automotive industry (e.g. on paint shop conveyors)

##### Application

Different cable types are needed to supply power to Industrial Ethernet/PROFINET or PROFIBUS. The listed power cables should always be used. They are used for devices with IP65/67 degree of protection to connect the signaling contact or 24-V supply of the SCALANCE X and SCALANCE W components (power cable 2x0.75) and for the power supply (power cable 5x1.5 for ET 200).

In addition, preassembled power connecting cables (4 x 0.75) are available in different lengths for the power supply of the ET 200 (M12 Power Connecting Cable).

##### UL approvals

As a result of appropriate UL styles, the cables can be used worldwide.

##### Design

Rugged 2-core, 4-core or 5-core cable with circular cross-section for connection of signaling contact and power supply to IP65/67 components in industrial areas.

##### Cable types

The following cables with industrial capability are available for connection of the power supply and signaling contact:

- Power cable 2 x 0.75; power cable for connection of signaling contact and 24 V supply voltage to SCALANCE X and SCALANCE W components
- Power cable 5 x 1.5; power cable for connection of 24 V power supply of ET 200 using 7/8" plug connectors
- M12 Power Connecting Cable M12-180/M12-180; 4-core M12 power connecting cables (A-coded) with straight cable outlet for 24 V power supply of the ET 200 (pre-assembled)

**Technical specifications**

Article No.	6XV1812-8A	6XV1830-8AH10
Product-type designation	Energy Cable 2 x 0,75	Energy Cable 5 x 1,5
Product description	Energy cable (2-core), sold by the meter, in bulk	Energy cable (5-core), sold by the meter, in bulk
Acceptability for application	Connection of signaling contact and 24 V power supply to SCALANCE X and SCALANCE W	Power supply of ET 200 modules with 7/8" power port
Cable designation	L-YY-2x1x0.75 GR	L-Y11Y-Z 5x1x1.5 GR
<b>Electrical data</b>		
Operating voltage RMS value	600 V	600 V
Conductor cross section of the power wires	0.75 mm <sup>2</sup>	1.5 mm <sup>2</sup>
Continuous current of the power wires	6 A	16 A
<b>Mechanical data</b>		
Number of electrical wires	2	5
Design of the electrical connection FastConnect	-	No
Outer diameter		
• of the inner conductor	1.3 mm	1.55 mm
• of the wire insulation	2.5 mm	2.73 mm
• of the cable sheath	7.4 mm	10.5 mm
Symmetrical tolerance of outer diameter of cable sheath	0.3 mm	0.3 mm
Material		
• of the wire insulation	PVC	PVC
• of the cable sheath	PVC	PUR
Color		
• of the power wire insulation	Brown/blue	4x black, 1x green / yellow
• of the cable sheath	gray	gray
Bending radius		
• with single bend minimum permissible	19 mm	27 mm
• with multiple bends minimum permissible	45 mm	63 mm
• with continuous bending	-	75 mm
Number of bending cycles	-	5 000 000
• Note	-	For use in cable carriers, for 5 million bending cycles with a bending radius of 75 mm, an acceleration of 4 m/s <sup>2</sup> and a speed of 180 m/min
Traction stress maximum	100 N	500 N
Weight per length	70 kg/km	149 kg/km
<b>Permitted ambient conditions</b>		
Ambient temperature		
• during operating	-20 ... +80 °C	-40 ... +80 °C
• during storage	-20 ... +80 °C	-40 ... +80 °C
• during transport	-20 ... +80 °C	-40 ... +80 °C
• during installation	-20 ... +80 °C	-40 ... +80 °C
Burning behaviour	flame resistant according to IEC 60332-1-2	flame resistant according to IEC 60332-1-2
Chemical resistance		
• to mineral oil	Conditional resistance	Resistant
• to grease	Conditional resistance	Resistant
• to water	Conditional resistance	Conditional resistance
Radiological resistance to UV radiation	Resistant	Resistant
<b>Product properties, functions, components general</b>		
Product feature		
• halogen-free	No	No
• silicon-free	Yes	Yes
<b>Standards, specifications, approvals</b>		
UL/ETL listing with 300 V rating	Yes: CL3	No
UL/ETL style with 600 V rating	Yes	Yes
Verification of suitability		
• CE mark	Yes	Yes
• RoHS conformity	Yes	Yes

# PROFIBUS

## Electrical networks (RS485)

### Energy cables

#### Technical specifications (continued)

Article No.	6XV1801-5DH10	Article No.	6XV1801-5DH10
Product-type designation	POWER CONNECTING CABLE M12-180/M12-180	Product-type designation	POWER CONNECTING CABLE M12-180/M12-180
Product description	Flexible connecting cable (4-core), preferred length, preassembled with a 4-pin M12 plug and a 4-pin M12 socket (A-coded)	<b>Permitted ambient conditions</b>	
Acceptability for application	Cable for connecting the 24 V power supply to ET 200eco PN to IP 65/67 degree of protection	Ambient temperature	
Cable designation	LI9YH-Y 4x0.75	• during operating	-25 ... +80 °C
Cable length	1 m	• during storage	-25 ... +80 °C
<b>Electrical data</b>		• during transport	-25 ... +80 °C
Operating voltage RMS value	300 V	• during installation	-5 ... +80 °C
Conductor cross section of the power wires	0.75 mm <sup>2</sup>	• Comment	With moving applications, the permissible operating temperature range is -5 to +80 degrees Celsius
Continuous current of the power wires	-	Protection class IP	IP65/67
<b>Mechanical data</b>		Burning behaviour	Flame-retardant in accordance with UL 758 (CSA FT 1)
Number of electrical wires	4	Chemical resistance	
Outer diameter		• to mineral oil	Conditional resistance
• of the inner conductor	1.1 mm	• to grease	Conditional resistance
• of the wire insulation	1.7 mm	• to water	Conditional resistance
• of the cable sheath	5.7 mm	Radiological resistance to UV radiation	Not resistant
Symmetrical tolerance of outer diameter of cable sheath	0.2 mm	<b>Product properties, functions, components general</b>	
Material		Product feature	
• of the wire insulation	PP	• halogen-free	No
• of the cable sheath	PVC	• silicon-free	Yes
Color		<b>Standards, specifications, approvals</b>	
• of the power wire insulation	Brown / white / blue / black gray	Verification of suitability	
• of the cable sheath		• UL-registration	Yes
Bending radius		• RoHS conformity	Yes
• with single bend minimum permissible	57 mm		
• with multiple bends minimum permissible	57 mm		
Traction stress maximum	15 N		
Weight per length	54 kg/km		

Article No.	6GK1905-0FA00	6GK1905-0FB00	6GK1905-0FC00
Product-type designation	7/8-inch connector	7/8-inch connector	7/8-inch Power T-Tap PRO
Product description	7/8" connector with pin insert, 5-pin	7/8" connector with female contact insert, 5-pin	Energy T-piece with two 7/8" female contact inserts and one 7/8" pin insert, each 5-pin
Acceptability for application	For field assembly with ET200	For field assembly with ET200	For power connection and distribution to ET200pro modules
<b>Interfaces</b>			
Number of electrical connections for network components and terminal equipment	1	1	3
Design of electrical connection for network components and terminal equipment	7/8 inch plug (male insert)	7/8 inch plug (female insert)	7/8 inch plug (2 x female insert, 1 x male insert)
<b>Mechanical data</b>			
Material of the enclosure	metal	metal	metal
<b>Design, dimensions and weight</b>			
Type of cable outlet	180 degree cable outlet	180 degree cable outlet	-
Width	27 mm	27 mm	58.5 mm
Height	27 mm	27 mm	73.5 mm
Depth	83 mm	83 mm	26.5 mm
Net weight	50 g	50 g	112 g

**Technical specifications** (continued)

Article No.	6GK1905-0FA00	6GK1905-0FB00	6GK1905-0FC00
Product-type designation	7/8-inch connector	7/8-inch connector	7/8-inch Power T-Tap PRO
<b>Permitted ambient conditions</b>			
Ambient temperature			
• during operating	-40 ... +70 °C	-40 ... +70 °C	-40 ... +70 °C
• during storage	-40 ... +80 °C	-40 ... +80 °C	-40 ... +80 °C
• during transport	-40 ... +80 °C	-40 ... +80 °C	-40 ... +80 °C
Relative humidity at 25 °C without condensation during operating maximum	-	-	-
Protection class IP	IP65/67	IP65/67	IP65/67
Chemical resistance to water	resistant	resistant	resistant
<b>Product properties, functions, components general</b>			
Product feature silicon-free	Yes	Yes	Yes
Product component strain relief	Yes	Yes	Yes
<b>Standards, specifications, approvals</b>			
Verification of suitability RoHS conformity	Yes	Yes	Yes
Article No.	6GK1908-0DC10-6AA3	6GK1907-0DC10-6AA3	6GK1907-0DB10-6AA3
Product-type designation	Signalling Contact M12 Cable Connector	Power M12 Cable Connector PRO	Power M12 Plug PRO
Product description	M12 connecting socket for signal contact, 5-pin, B-coded	M12 Power connecting socket, 4-pin, A-coded	M12 Power connector, 4-pin, A-coded
Acceptability for application	For connection to SCALANCE X208PRO for signaling contact	For connection to SCALANCE W-700 / X208PRO for 24 V DC voltage supply	For connection to PS791-1PRO power supply for 24 V DC voltage supply
<b>Interfaces</b>			
Number of electrical connections for network components and terminal equipment	1	1	1
Design of electrical connection for network components and terminal equipment	M12 connector (B-coded, 5-pin)	M12 connector (female insert, A-coded, 4-pin)	M12 connector (male insert, A-coded, 4-pin)
<b>Mechanical data</b>			
Material of the enclosure	plastic	plastic	plastic
<b>Design, dimensions and weight</b>			
Type of cable outlet	180 degree cable outlet	180 degree cable outlet	180 degree cable outlet
Width	14 mm	19 mm	19 mm
Height	14 mm	19 mm	19 mm
Depth	59 mm	73 mm	73 mm
Net weight	37 g	40 g	40 g
<b>Permitted ambient conditions</b>			
Ambient temperature			
• during operating	-40 ... +70 °C	-40 ... +70 °C	-40 ... +70 °C
• during storage	-40 ... +80 °C	-40 ... +80 °C	-40 ... +80 °C
• during transport	-40 ... +80 °C	-40 ... +80 °C	-40 ... +80 °C
Protection class IP	IP65/67	IP65/67	IP65/67
Chemical resistance to water	resistant	resistant	resistant
<b>Product properties, functions, components general</b>			
Product feature silicon-free	Yes	Yes	Yes
Product component strain relief	Yes	Yes	Yes
<b>Standards, specifications, approvals</b>			
Verification of suitability RoHS conformity	Yes	Yes	Yes

**PROFIBUS**

## Electrical networks (RS485)

## Energy cables

Ordering data	Article No.
<b>Power cable 2 x 0.75</b> Power cable with trailing capability with 2 copper cores (0.75 mm <sup>2</sup> ) for connecting to M12 plug-in connector; <u>sold by the meter</u> ; max. 1 000 m, minimum order quantity 20 m	<b>6XV1812-8A</b>
<b>Power cable 5 x 1.5</b> Power cable with trailing capability with 5 copper cores (1.5 mm <sup>2</sup> ) for connecting to 7/8" plug-in connector; <u>sold by the meter</u> ; max. 1 000 m; minimum order quantity 20 m	<b>6XV1830-8AH10</b>
<b>M12 Power Connecting Cable M12-180/M12-180</b> Flexible 4-core power connecting cable, assembled with A-coded 5-pin M12 connector and A-coded, 5-pin M12 socket to supply the ET 200 with 24 V DC; length: <ul style="list-style-type: none"> <li>• 0.3 m</li> <li>• 0.5 m</li> <li>• 1.0 m</li> <li>• 1.5 m</li> <li>• 2.0 m</li> <li>• 3.0 m</li> <li>• 5.0 m</li> <li>• 10 m</li> <li>• 15 m</li> </ul>	<b>6XV1801-5DE30</b> <b>6XV1801-5DE50</b> <b>6XV1801-5DH10</b> <b>6XV1801-5DH15</b> <b>6XV1801-5DH20</b> <b>6XV1801-5DH30</b> <b>6XV1801-5DH50</b> <b>6XV1801-5DN10</b> <b>6XV1801-5DN15</b>
<i>Additional components</i>	
<b>7/8" plug-in connector</b> Plug with axial cable outlet for field assembly for ET 200, 5-core, plastic enclosure, 1 pack = 5 items <ul style="list-style-type: none"> <li>• Male pins</li> <li>• Socket insert</li> </ul>	<b>6GK1905-0FA00</b> <b>6GK1905-0FB00</b>
<b>7/8" Power T-Tap PRO</b> Power T-piece for ET 200 with two 7/8" socket inserts and one 7/8" pin insert 1 pack = 5 items	<b>6GK1905-0FC00</b>
<b>Signaling Contact M12 Cable Connector PRO</b> Socket for connection of SCALANCE X208PRO for signaling contact; 5-pole, B-coded, with assembly instructions; 3 items	<b>6GK1908-0DC10-6AA3</b>
<b>Power M12 Cable Connector PRO</b> Socket for connection of SCALANCE W-700 for 24 V DC supply voltage; 4-pole, A-coded, with assembly instructions, 3 items	<b>6GK1907-0DC10-6AA3</b>
<b>Power M12 Plug PRO</b> Plug for connection to PS791-1PRO power supply for 24 V DC supply voltage; 4-pole, A-coded, with assembly instructions, 3 items	<b>6GK1907-0DB10-6AA3</b>
<b>SIMATIC NET Manual Collection</b> Electronic manuals for communication systems, communication protocols, and communication products; on DVD, German/English	<b>6GK1975-1AA00-3AA0</b>

**More information****Cable routing:**

During storage, transport and cable laying, keep both ends sealed with a shrink-on cap.

Comply with the permissible bending radii and tensile load!

Note:

You can order components supplementary to the SIMATIC NET cabling range from your local contact.

Technical advice on this subject is available from:

J. Hertlein  
 I IA SC CI PRM 4  
 Phone: +49 (911) 750-4465  
 E-mail: [juergen.hertlein@siemens.com](mailto:juergen.hertlein@siemens.com)



### Overview



- Used for connecting PROFIBUS nodes to the PROFIBUS bus cable
- Easy installation
- FastConnect plugs ensure extremely short assembly times due to their insulation-displacement technology
- Integrated terminating resistors (not in the case of 6ES7972-0BA30-0XA0)
- Connectors with Sub-D socket permit PG connection without the additional installation of network nodes

### Application

The RS485 bus connectors for PROFIBUS are used for connecting a PROFIBUS node or a PROFIBUS network component to the bus cable for PROFIBUS.

### Design

Several different versions of the bus connector are available, each optimized for the devices to be connected:

- Bus connector with axial cable outlet (180°), e.g. for PCs and SIMATIC HMI OPs, for transmission rates up to 12 Mbit/s with integrated bus terminating resistor.
- Bus connector with vertical cable outlet (90°);

This connector permits a vertical cable outlet (with or without PG interface) for transmission rates of up to 12 Mbit/s with integral bus terminating resistor. At a transmission rate of 3, 6 or 12 Mbit/s, the SIMATIC S5/S7 plug-in cable is required for the connection between bus connector with PG-interface and programming device.

- Bus connector with 30° cable outlet (low-cost version) without PG interface for transmission rates of up to 1.5 Mbit/s and without integrated bus terminating resistor.
- PROFIBUS FastConnect bus connector RS485 (90° or 180° cable outlet) with transmission rates up to 12 Mbit/s for fast and easy assembly using insulation displacement connection technology (for rigid and flexible wires).

### Function

The bus connector is plugged directly into the PROFIBUS interface (9-pin Sub-D socket) of the PROFIBUS station or a PROFIBUS network component.

The incoming and outgoing PROFIBUS cable is connected in the plug using 4 terminals.

By means of an easily accessible switch which is clearly visible from the outside, the line terminator integrated in the bus connector can be connected (not in the case of 6ES7972-0BA30-0XA0). In this process, incoming and outgoing bus cables in the connector are separated (separation function).

This must be done at both ends of a PROFIBUS segment.

# PROFIBUS

## Electrical networks (RS485)

### RS485 bus connector

#### Technical specifications

Article No.	6ES7972-0BA12-0XA0	6ES7972-0BB12-0XA0	6ES7972-0BA42-0XA0	6ES7972-0BB42-0XA0	6ES7972-0BA30-0XA0
<b>Product-type designation</b>	<b>PROFIBUS bus connector RS 485 without PG interface, 90°</b>	<b>PROFIBUS bus connector RS 485 with PG interface, 90°</b>	<b>PROFIBUS bus connector RS 485 without PG interface, 35°</b>	<b>PROFIBUS bus connector RS 485 with PG interface, 35°</b>	<b>PROFIBUS FastConnect bus connector RS485 with PG interface, 30°</b>
Acceptability for application	For connecting PROFIBUS nodes to the PROFIBUS bus cable	For connecting PROFIBUS nodes to the PROFIBUS bus cable	For connecting PROFIBUS nodes to the PROFIBUS bus cable	For connecting PROFIBUS nodes to the PROFIBUS bus cable	For connecting PROFIBUS nodes to the PROFIBUS bus cable
<b>Transmission rate</b>					
Transfer rate with PROFIBUS	9.6 kbit/s ... 12 Mbit/s	9.6 kbit/s ... 12 Mbit/s	9.6 kbit/s ... 12 Mbit/s	9.6 kbit/s ... 12 Mbit/s	9.6 kbit/s ... 1.5 Mbit/s
<b>Interfaces</b>					
Number of electrical connections					
• for PROFIBUS cables	2	2	2	2	2
• for network components and terminal equipment	1	1	1	1	1
Design of electrical connection					
• for PROFIBUS cables	Screw	Screw	Screw	Screw	Integrated insulation displacement contacts for 2-wire PB FC installation cables
• for network components and terminal equipment	9-pin sub-D socket	9-pin sub-D socket	9-pin sub-D socket	9-pin sub-D socket	9-pin sub-D socket
• FastConnect		No	No	No	Yes
<b>Mechanical data</b>					
Design of terminating resistor	Integrated resistor combination, can be connected via slide switch	Integrated resistor combination, can be connected via slide switch	Integrated resistor combination, can be connected via slide switch	Integrated resistor combination, can be connected via slide switch	No integrated terminating resistor
Material of the enclosure	plastic	plastic	plastic	plastic	plastic
<b>Design, dimensions and weight</b>					
Type of cable outlet	90 degree cable outlet	90 degree cable outlet			
Width	15.8 mm	15.8 mm	15.8 mm	15.8 mm	15 mm
Height	64 mm	64 mm	54 mm	54 mm	57.6 mm
Depth	35.6 mm	35.6 mm	39.5 mm	39.5 mm	39.5 mm
Net weight	10 g	10 g	60 g	67 g	46 g
<b>Permitted ambient conditions</b>					
Ambient temperature					
• during operating	0 ... +60 °C	0 ... +60 °C	0 ... +60 °C	0 ... +60 °C	0 ... +60 °C
• during storage	-40 ... +70 °C	-40 ... +70 °C	-40 ... +70 °C	-40 ... +70 °C	-40 ... +70 °C
• during transport	-40 ... +70 °C	-40 ... +70 °C	-40 ... +70 °C	-40 ... +70 °C	-40 ... +70 °C
Relative humidity at 25 °C without condensation during operating maximum		95 %	95 %	95 %	95 %
Protection class IP	IP20	IP20	IP20	IP20	IP20
<b>Product properties, functions, components general</b>					
Product feature silicon-free	Yes	Yes	Yes	Yes	Yes
Product component					
• PG connection socket	No	Yes	No	Yes	No
• strain relief	Yes	Yes	Yes	Yes	Yes
<b>Standards, specifications, approvals</b>					
Verification of suitability					
• RoHS conformity	Yes	Yes	Yes	Yes	Yes
• UL-registration	Yes	Yes	Yes	Yes	Yes

### Technical specifications (continued)

Article No.	6ES7972-0BA52-0XA0	6ES7972-0BB52-0XA0	6ES7972-0BA60-0XA0	6ES7972-0BB60-0XA0
<b>Product-type designation</b>	<b>PROFIBUS FastConnect bus connector RS485 without PG interface, 90°</b>	<b>PROFIBUS FastConnect bus connector RS485 with PG interface, 90°</b>	<b>PROFIBUS FastConnect bus connector RS485 without PG interface, 35°</b>	<b>PROFIBUS FastConnect bus connector RS485 with PG interface, 35°</b>
Acceptability for application	For connecting PROFIBUS nodes to the PROFIBUS bus cable	For connecting PROFIBUS nodes to the PROFIBUS bus cable	For connecting PROFIBUS nodes to the PROFIBUS bus cable	For connecting PROFIBUS nodes to the PROFIBUS bus cable
<b>Transmission rate</b>				
Transfer rate with PROFIBUS	9.6 kbit/s ... 12 Mbit/s	9.6 kbit/s ... 12 Mbit/s	9.6 kbit/s ... 12 Mbit/s	9.6 kbit/s ... 12 Mbit/s
<b>Interfaces</b>				
Number of electrical connections				
• for PROFIBUS cables	2	2	2	2
• for network components and terminal equipment	1	1	1	1
Design of electrical connection				
• for PROFIBUS cables	Integrated insulation displacement contacts for 2-wire PB FC installation cables	Integrated insulation displacement contacts for 2-wire PB FC installation cables	Integrated insulation displacement contacts for 2-wire PB FC installation cables	Integrated insulation displacement contacts for 2-wire PB FC installation cables
• for network components and terminal equipment	9-pin sub-D socket	9-pin sub-D socket	9-pin sub-D socket	9-pin sub-D socket
• FastConnect	Yes	Yes	Yes	Yes
<b>Mechanical data</b>				
	Integrated resistor combination, can be connected via slide switch	Integrated resistor combination, can be connected via slide switch	Integrated resistor combination, can be connected via slide switch	Integrated resistor combination, can be connected via slide switch
Material of the enclosure	plastic	plastic	plastic	plastic
<b>Design, dimensions and weight</b>				
Type of cable outlet	90 degree cable outlet	90 degree cable outlet	35 degree cable outlet	35 degree cable outlet
Width	15.8 mm	15.8 mm	15.8 mm	15.8 mm
Height	59 mm	59 mm	54 mm	54 mm
Depth	35.6 mm	35.6 mm	39.5 mm	39.5 mm
Net weight	10 g	10 g	29 g	34 g
<b>Permitted ambient conditions</b>				
Ambient temperature				
• during operating	0 ... +60 °C	0 ... +60 °C	0 ... +60 °C	0 ... +60 °C
• during storage	-40 ... +70 °C	-40 ... +70 °C	-40 ... +70 °C	-40 ... +70 °C
• during transport	-40 ... +70 °C	-40 ... +70 °C	-40 ... +70 °C	-40 ... +70 °C
Relative humidity at 25 °C without condensation during operating maximum	95 %	95 %	95 %	95 %
Protection class IP	IP20	IP20	IP20	IP20
<b>Product properties, functions, components general</b>				
Product feature silicon-free	Yes	Yes	Yes	Yes
Product component				
• PG connection socket	No	Yes	No	Yes
• strain relief	Yes	Yes	Yes	Yes
<b>Standards, specifications, approvals</b>				
Verification of suitability				
• RoHS conformity	Yes	Yes	Yes	Yes
• UL-registration	Yes	Yes	Yes	Yes

**PROFIBUS**

## Electrical networks (RS485)

## RS485 bus connector

**Technical specifications** (continued)

Article No.	6ES7972-0BA70-0XA0	6ES7972-0BB70-0XA0	6GK1500-0EA02	6GK1500-0FC10
<b>Product-type designation</b>	<b>PROFIBUS FastConnect bus connector RS485 without PG interface, 90°</b>	<b>PROFIBUS FastConnect bus connector RS485 with PG interface, 90°</b>	<b>PROFIBUS bus connector RS 485</b>	<b>PROFIBUS FC bus connector RS 485</b>
Acceptability for application	For connecting PROFIBUS nodes to the PROFIBUS bus cable	For connecting PROFIBUS nodes to the PROFIBUS bus cable	For connecting PROFIBUS nodes to the PROFIBUS bus cable	For connecting PROFIBUS nodes to the PROFIBUS bus cable
<b>Transmission rate</b>				
Transfer rate with PROFIBUS	9.6 kbit/s ... 12 Mbit/s	9.6 kbit/s ... 12 Mbit/s	9.6 kbit/s ... 12 Mbit/s	9.6 kbit/s ... 12 Mbit/s
<b>Interfaces</b>				
Number of electrical connections				
• for PROFIBUS cables	2	2	2	2
• for network components and terminal equipment	1	1	1	1
Design of electrical connection				
• for PROFIBUS cables	Integrated insulation displacement contacts for 2-wire PB FC installation cables	Integrated insulation displacement contacts for 2-wire PB FC installation cables	Terminal blocks	Integrated insulation displacement contacts for 2-core PB FC installation cables
• for network components and terminal equipment	9-pin Sub-D plug	9-pin Sub-D plug	9-pin Sub-D plug	9-pin Sub-D plug
• FastConnect	Yes	Yes	No	Yes
<b>Mechanical data</b>				
Design of terminating resistor	Integrated resistor combination that can be selected with slide switch. Disconnect function: When the resistor is connected, the outgoing bus is isolated.	Integrated resistor combination that can be selected with slide switch.	Integrated resistor combination that can be selected with slide switch. Disconnect function: When the resistor is connected, the outgoing bus is isolated.	Integrated resistor combination that can be selected with slide switch. Disconnect function: When the resistor is connected, the outgoing bus is isolated.
Material of the enclosure	plastic	plastic	metal	plastic
<b>Design, dimensions and weight</b>				
Type of cable outlet	90 degree cable outlet	90 degree cable outlet	180 degree cable outlet	180 degree cable outlet
Width	15.8 mm	15.8 mm	15 mm	16 mm
Height	72 mm	72 mm	57 mm	62 mm
Depth	36.4 mm	36.4 mm	39 mm	34,5 mm
Net weight	34 g	10 g	100 g	40 g
<b>Permitted ambient conditions</b>				
Ambient temperature				
• during operating	0 ... 60 °C	0 ... 60 °C	0 ... 60 °C	0 ... 60 °C
• during storage	-40 ... +70 °C	-40 ... +70 °C	-25 ... +80 °C	-25 ... +80 °C
• during transport	-40 ... +70 °C	-40 ... +70 °C	-25 ... +80 °C	-25 ... +80 °C
Relative humidity at 25 °C without condensation during operating maximum	75 %	75 %	75 %	75 %
Protection class IP	IP20	IP20	IP20	IP20
<b>Product properties, functions, components general</b>				
Product feature silicon-free	Yes	Yes	Yes	Yes
Product component				
• PG connection socket	No	Yes	No	No
• strain relief	Yes	Yes	Yes	Yes
<b>Standards, specifications, approvals</b>				
Verification of suitability				
• RoHS conformity	Yes	Yes	Yes	Yes
• UL-registration	Yes	Yes	No	Yes

Ordering data	Article No.	Article No.	
<b>RS485 bus connector with axial cable outlet (180°)</b> For industrial PC, SIMATIC HMI OP, OLM; max. transmission rate 12 Mbit/s	<b>6GK1500-0EA02</b>	<i>PROFIBUS bus connector RS485 with FastConnect technology</i>  <b>PROFIBUS FastConnect bus connector RS485 with 90° cable outlet</b> with insulation displacement, max. transmission rate 12 Mbps Without PG interface <ul style="list-style-type: none"> <li>• 1 unit</li> <li>• 100 units</li> </ul> With PG interface <ul style="list-style-type: none"> <li>• 1 unit</li> <li>• 100 units</li> </ul> without PG interface, grounding via control cabinet cover <ul style="list-style-type: none"> <li>• 1 unit</li> </ul> with PG interface, grounding via control cabinet cover <ul style="list-style-type: none"> <li>• 1 unit</li> </ul> <b>PROFIBUS FastConnect RS485 bus connector with angled cable outlet (35°)</b> with insulation displacement, max. transmission rate 12 Mbps <ul style="list-style-type: none"> <li>• Without PG interface</li> <li>• With PG interface</li> </ul> <b>PROFIBUS FastConnect bus connector RS485 Plug 180</b> with insulation displacement terminals, with 180° cable outlet, for industrial PC, SIMATIC HMI OP, OLM; max. transmission rate 12 Mbit/s	
<b>SIPLUS DP PB RS485 connector with axial cable outlet (180°)</b> for medial stress; Based-on 6GK1 500-0EA02	<b>6AG1500-0EA02-2AA0</b>		
<b>RS485 bus connector with cable outlet (90°)</b> With screw-terminals, max. transmission rate 12 Mbit/s <ul style="list-style-type: none"> <li>• Without PG interface</li> <li>• With PG interface</li> </ul>	<b>6ES7972-0BA12-0XA0</b> <b>6ES7972-0BB12-0XA0</b>		
<b>SIPLUS DP PB RS485 connector with 90° cable outlet</b> for extended temperature range -25 ... + 60 °C <ul style="list-style-type: none"> <li>• without PG interface Based on 6ES7 972-0BA12-0XA0</li> <li>• with PG interface Based on 6ES7 972-0BB12-0XA0</li> </ul>	<b>6AG1972-0BA12-2XA0</b> <b>6AG1972-0BB12-2XA0</b>		
<b>RS485 bus connector with angled cable outlet (35°)</b> With screw-terminals, max. transmission rate 12 Mbit/s <ul style="list-style-type: none"> <li>• Without PG interface</li> <li>• With PG interface</li> </ul>	<b>6ES7972-0BA42-0XA0</b> <b>6ES7972-0BB42-0XA0</b>		
<b>SIPLUS DP PB RS485 connector with inclined cable outlet (35°)</b> for extended temperature range -25 ... + 60 °C <ul style="list-style-type: none"> <li>• without PG interface Based on 6ES7 942-0BA42-0XA0</li> <li>• with PG interface Based on 6ES7 942-0BB42-0XA0</li> </ul>	<b>6AG1972-0BA42-7XA0</b> <b>6AG1972-0BB42-7XA0</b>		
<b>RS485 bus connector with cable outlet (30°)</b> With screw-terminals, low-cost variant, max. transmission rate 1.5 Mbit/s	<b>6ES7972-0BA30-0XA0</b>		
			<b>6ES7972-0BA52-0XA0</b> <b>6ES7972-0BA52-0XB0</b>
			<b>6ES7972-0BB52-0XA0</b> <b>6ES7972-0BB52-0XB0</b>
			<b>6ES7972-0BA70-0XA0</b> <b>6ES7972-0BB70-0XA0</b>
		<b>6ES7972-0BA60-0XA0</b> <b>6ES7972-0BB60-0XA0</b>	
		<b>6GK1500-0FC10</b>	
		<b>SIMATIC S5/S7 plug-in cable for PROFIBUS</b> Preassembled with two 9-pin sub-D connectors; max. transmission rate 12 Mbit/s; 3 m	
		<b>SIMATIC NET Manual Collection</b> Electronic manuals for communication systems, communication protocols, and communication products; on DVD; German/English	
		<b>6ES7901-4BD00-0XA0</b>	
		<b>6GK1975-1AA00-3AA0</b>	

## PROFIBUS

### Electrical networks (RS485)

#### 830-1T connecting cable

##### Overview



- Prefabricated cable for fast and cost-effective connection of PROFIBUS nodes to OLM and OBT
- Flexible PROFIBUS connecting cable

##### Benefits

**get** Designed for Industry

- Trouble-free connection of end stations through preassembled connecting leads
- Reliable data transmission to the end station in EMC-exposed environment through direct cable shielding and termination.

##### Design

The 830-1T connecting cable consists of a twisted-pair cable (wires made of stranded copper) with a woven shield.

It has a 9-pin Sub-D plug at both ends.

Both cable ends are terminated by a resistor combination (cannot be switched off).

##### Function

The PROFIBUS 830-1T connecting cable is used for connecting the electrical PROFIBUS interface to the PROFIBUS nodes (OLM, OBT and data terminals) for data transmission rates of up to 12 Mbit/s.

##### Technical specifications

Article No.	6XV1830-1CH15	6XV1830-1CH30
Product-type designation	connecting cable 830-1T	connecting cable 830-1T
Acceptability for application	For connecting PROFIBUS nodes to OLM or OBT	For connecting PROFIBUS nodes to OLM or OBT
Cable length	1.5 m	3 m
Mechanical data		
Net weight	-	-

##### Ordering data

##### Article No.

##### 830-1T PROFIBUS connecting cable

for terminal connection, preassembled, with two Sub-D plugs, 9-pin terminated at both ends

- 1.5 m long
- 3 m long

**6XV1830-1CH15**  
**6XV1830-1CH30**

## Overview



- Prefabricated cable for connection of PROFIBUS nodes (e.g. HMI) to PLCs
- Flexible PROFIBUS connection cable for up to 12 Mbit/s

## Benefits

get **Designed for Industry**

- Trouble-free connection of end stations through preassembled connecting leads
- Direct connection of a PG through the PG interface without interrupting the connection between the stations.

## Design

The 830-2 connecting cable comprises a standard PROFIBUS bus cable. It is preassembled with two 9-pin connectors (6GK1 500-0EA02 and 6ES7 972-0BB11-0XA0). One plug of the preassembled connecting cable is equipped with a PG interface.

## Function

The 830-2 connecting cable is used to connect PROFIBUS nodes (e.g. HMI) to automation devices for transmission rates up to 12 Mbit/s.

## Technical specifications

Article No.	6XV1830-2AH30	6XV1830-2AH50	6XV1830-2AN10
<b>Product-type designation</b>	<b>PROFIBUS connecting cable 830-2</b>	<b>PROFIBUS connecting cable 830-2</b>	<b>PROFIBUS connecting cable 830-2</b>
<b>Acceptability for application</b>	Cable for connecting PROFIBUS stations (e.g. HMI) to automation devices	Cable for connecting PROFIBUS stations (e.g. HMI) to automation devices	Cable for connecting PROFIBUS stations (e.g. HMI) to automation devices
<b>Cable length</b>	3 m	5 m	10 m
<b>Mechanical data</b>			
Net weight	-	-	-

## Ordering data

### Article No.

### 830-2 PROFIBUS connecting cable

Preassembled, with two 9-pin connectors

- 3 m long
- 5 m long
- 10 m long

6XV1830-2AH30  
 6XV1830-2AH50  
 6XV1830-2AN10

## PROFIBUS

### Electrical networks (RS485)

#### PROFIBUS M12 and 7/8" connecting cable/connector

##### Overview



Flexible connecting cables and FastConnect (FC) plug-in connectors that can be assembled in the field for transmission of data (up to 12 Mbit/s) or for power supply between PROFIBUS nodes with IP65 degree of protection

##### **PROFIBUS M12 plug-in cable**

- Preassembled plug-in cable (PROFIBUS FC Trailing Cable) for connecting PROFIBUS nodes (e.g. SIMATIC ET 200) to IP65 degree of protection
- For transmission rates up to 12 Mbit/s

##### **7/8" connecting cable**

- Preassembled plug-in cable for supplying power to PROFIBUS nodes (e.g. SIMATIC ET 200) to IP65 degree of protection

##### **PROFIBUS FC M12 Plug PRO (B-coded) and 7/8" plug-in connector**

- For establishing direct connections between devices on PROFIBUS installation and power cables with M12 or 7/8" connections
- Excellent EMC shielding and deflection (metal housing)
- Easy assembly due to integrated FastConnect technology (FC M12 Plug)
- Viewable contact area prevents errors

##### Benefits

get **Designed for Industry**

- Time-saving and fault-free connection of terminal stations by means of prefabricated connection cables
- Easy assembly on site for application-specific M12 and 7/8" plug-in cables by means of FC M12 and 7/8" plug-in connectors that can be assembled in the field

##### Design

###### **M12 plug-in cable**

- Comprises the PROFIBUS Trailing Cable
- Pre-assembled with two 5-pole M12 male/female connectors; B-coded

###### **7/8" plug-in cable**

- Comprises the Energy Cable 5 x 1.5 mm<sup>2</sup>
- Pre-assembled with two 5-pole 7/8" male/female connectors



**Technical specifications**

Article No.	6XV1830-3DH10	Article No.	6XV1830-3DH10
Product-type designation	PROFIBUS M12 connecting cable	Product-type designation	PROFIBUS M12 connecting cable
Product description	Flexible connecting cable (2-core), preferred length, preassembled with two 5-pin M12 plugs/sockets (B-coded)	Color	red / green Petrol
Acceptability for application	Cable for connecting PROFIBUS stations (e.g. SIMATIC ET 200) to IP 65 degree of protection	Bending radius	40 mm
Cable designation	02YY (ST) C11Y 1x2x0.65/2.56-150 LI KF 40 FR petrol	<ul style="list-style-type: none"> <li>with single bend minimum permissible</li> <li>with multiple bends minimum permissible</li> <li>with continuous bending</li> </ul>	- 120 mm
Cable length	1 m	Number of bending cycles	3 000 000
<b>Electrical data</b>		<ul style="list-style-type: none"> <li>Note</li> </ul>	For use in cable carriers, for 3 million bending cycles with a bending radius of 120 mm (15x D) and an acceleration of 4 m/s <sup>2</sup>
Damping ratio per length		Number of torsion cycles with torsion by ± 180° on 1 m cable length	-
<ul style="list-style-type: none"> <li>at 9.6 kHz maximum</li> <li>at 38.4 kHz maximum</li> <li>at 4 MHz maximum</li> <li>at 16 MHz maximum</li> </ul>	0.003 dB/m 0.004 dB/m 0.025 dB/m 0.049 dB/m	Traction stress maximum	100 N
Impedance		Weight per length	77 kg/km
<ul style="list-style-type: none"> <li>Nominal value</li> <li>at 9.6 kHz</li> <li>at 38.4 kHz</li> <li>for frequency range 3 MHz ... 20 MHz</li> </ul>	150 Ω 270 Ω 185 Ω 150 Ω	<b>Permitted ambient conditions</b>	
Relative symmetrical tolerance		Ambient temperature	
<ul style="list-style-type: none"> <li>of the surge impedance at 9.6 kHz</li> <li>of the surge impedance at 38.4 kHz</li> <li>of the surge impedance at 3 MHz ... 20 MHz</li> </ul>	10 % 10 % 10 %	<ul style="list-style-type: none"> <li>during operating</li> <li>during storage</li> <li>during transport</li> <li>during installation</li> </ul>	-40 ... +60 °C -40 ... +60 °C -40 ... +60 °C -40 ... +60 °C
Loop resistance per length maximum	133 Ω/km	Ambient condition for (standard) operation mode	Limited segment length (see manual for PROFIBUS networks)
Shield resistance per length maximum	14 Ω/km	Protection class IP	IP65/67
Capacity per length at 1 kHz	28 pF/m	Burning behaviour	flame resistant according to IEC 60332-1-2
Operating voltage RMS value	100 V	Chemical resistance	
<b>Mechanical data</b>		<ul style="list-style-type: none"> <li>to mineral oil</li> <li>to grease</li> <li>to water</li> </ul>	oil resistant according to IEC 60811-2-1 (7x24h/90°C) Resistant Conditional resistance
Number of electrical wires	2	Radiological resistance to UV radiation	Resistant
Design of shield	Overlapped aluminum-clad foil, sheathed in a braided screen of tin-plated copper wires	<b>Product properties, functions, components general</b>	
Design of the electrical connection FastConnect	Yes	Product feature	
Outer diameter		<ul style="list-style-type: none"> <li>halogen-free</li> <li>silicon-free</li> </ul>	No Yes
<ul style="list-style-type: none"> <li>of the inner conductor</li> <li>of the wire insulation</li> <li>of the inner sheath of the cable</li> <li>of the cable sheath</li> </ul>	0.67 mm 2.56 mm 5.4 mm 8 mm	Cable length	
Symmetrical tolerance of outer diameter of cable sheath	0.4 mm	<ul style="list-style-type: none"> <li>at max. 1.5 Mbit/s</li> <li>at max. 12 Mbit/s</li> </ul>	- -
Outer diameter of the cable sheath Note	-	<b>Standards, specifications, approvals</b>	
Material		UL/ETL listing with 300 V rating	Yes: CMX
<ul style="list-style-type: none"> <li>of the wire insulation</li> <li>of the inner sheath of the cable</li> <li>of the cable sheath</li> <li>- Note</li> </ul>	PE PVC PUR -	UL/ETL style with 600 V rating	No
		Verification of suitability	
		<ul style="list-style-type: none"> <li>CE mark</li> <li>UL-registration</li> <li>- RoHS conformity</li> </ul>	- - Yes
		Marine classification association	
		<ul style="list-style-type: none"> <li>Germanische Lloyd (GL)</li> <li>Lloyds Register of Shipping (LRS)</li> </ul>	No No

# PROFIBUS

## Electrical networks (RS485)

### PROFIBUS M12 and 7/8" connecting cable/connector

#### Technical specifications (continued)

Article No.	6XV1822-5BH10
Product-type designation	7/8 connecting cable
Product description	Connecting cable (5-core), preferred length, preassembled with two 5-pin 7/8" plugs/sockets
Acceptability for application	Power supply of ET 200 modules with 7/8 inch power port to IP 65 degree of protection
Cable designation	L-Y11Y-Z 5x1x1.5 GR
Cable length	1 m
<b>Electrical data</b>	
Operating voltage RMS value	600 V
Conductor cross section of the power wires	1.5 mm <sup>2</sup>
Continuous current of the power wires	16 A
<b>Mechanical data</b>	
Number of electrical wires	5
Design of shield	-
Design of the electrical connection FastConnect	-
Outer diameter	
• of the inner conductor	1.55 mm
• of the wire insulation	2.73 mm
• of the cable sheath	10.5 mm
Symmetrical tolerance of outer diameter of cable sheath	0.3 mm
Outer diameter of the cable sheath Note	-
Material	
• of the wire insulation	PVC
• of the cable sheath	PUR
- Note	-
Color	
• of the power wire insulation	Black
• of the cable sheath	gray
Bending radius	
• with single bend minimum permissible	27 mm
• with multiple bends minimum permissible	63 mm
• with continuous bending	75 mm
Number of bending cycles	5 000 000
• Note	For use in cable carriers, for 5 million bending cycles with a bending radius of 75 mm, an acceleration of 4 m/s <sup>2</sup> and a speed of 180 m/min
Number of torsion cycles with torsion by ± 180° on 1 m cable length	-
Traction stress maximum	500 N
Weight per length	149 kg/km

Article No.	6XV1822-5BH10
Product-type designation	7/8 connecting cable
<b>Permitted ambient conditions</b>	
Ambient temperature	
• during operating	-40 ... +80 °C
• during storage	-40 ... +80 °C
• during transport	-40 ... +80 °C
• during installation	-40 ... +80 °C
• Comment	-
Ambient condition for (standard) operation mode	-
Protection class IP	IP65/67
Burning behaviour	Flame-retardant in accordance with IEC 60332-1
Chemical resistance	
• to mineral oil	Resistant
• to grease	Resistant
• to water	-
Radiological resistance to UV radiation	Resistant
<b>Product properties, functions, components general</b>	
Product feature	
• halogen-free	No
• silicon-free	Yes
<b>Standards, specifications, approvals</b>	
UL/ETL listing with 300 V rating	No
UL/ETL style with 600 V rating	Yes
Verification of suitability	
• CE mark	-
• UL-registration	-
• RoHS conformity	Yes

**Technical specifications (continued)**

Article No.	6GK1905-0EA10	6GK1905-0EB10	6GK1905-0EA00	6GK1905-0EB00
Product-type designation	PB FC M12 Plug PRO	PB FC M12 Cable Connector PRO	PB M12 connector	PB M12 connector
Product description	M12 connector with male contact insert, 5-pin, B-coded	M12 connector with female contact insert, 5-pin, B-coded	M12 connector with male contact insert, 5-pin, B-coded	M12 connector with female contact insert, 5-pin, B-coded
Acceptability for application	For connecting electrical PB FC bus cables to ET200 PRO, suitable for fast assembly with the FastConnect system	For connecting electrical PB FC bus cables to ET200 PRO, suitable for fast assembly with the FastConnect system	For connecting electrical PB bus cables to ET200	For connecting electrical PB bus cables to ET200
<b>Transmission rate</b>				
Transfer rate with PROFIBUS	9.6 kbit/s ... 12 Mbit/s	9.6 kbit/s ... 12 Mbit/s	9.6 kbit/s ... 12 Mbit/s	9.6 kbit/s ... 12 Mbit/s
<b>Interfaces</b>				
Number of electrical connections				
• for PROFIBUS cables	1	1	1	1
• for network components and terminal equipment	1	1	1	1
Design of electrical connection				
• for PROFIBUS cables	Integrated insulation displacement contacts for 2-core PB FC installation cables	Integrated insulation displacement contacts for 2-core PB FC installation cables	Integrated screw-type contacts for 2-core PB installation cables	Integrated screw-type contacts for 2-core PB installation cables
• for network components and terminal equipment	M12 connector (male insert, 4-pin, B-coded)	M12 connector (female insert, 5-pin, B-coded)	M12 connector (male insert, 4-pin, B-coded)	M12 connector (female insert, 5-pin, B-coded)
• FastConnect	Yes	Yes	No	No
<b>Mechanical data</b>				
Design of terminating resistor	-	-	-	-
Material of the enclosure	metal	metal	metal	metal
<b>Design, dimensions and weight</b>				
Type of cable outlet	180 degree cable outlet	180 degree cable outlet	180 degree cable outlet	180 degree cable outlet
Width	19 mm	19 mm	19 mm	19 mm
Height	19 mm	19 mm	19 mm	19 mm
Depth	73 mm	73 mm	73 mm	73 mm
Net weight	40 g	40 g	40 g	40 g
<b>Permitted ambient conditions</b>				
Ambient temperature				
• during operating	-40 ... +85 °C	-40 ... +85 °C	-40 ... +70 °C	-40 ... +70 °C
• during storage	-40 ... +85 °C	-40 ... +85 °C	-40 ... +80 °C	-40 ... +80 °C
• during transport	-40 ... +85 °C	-40 ... +85 °C	-40 ... +80 °C	-40 ... +80 °C
Relative humidity at 25 °C without condensation during operating maximum	-	-	-	-
Protection class IP	IP65/67	IP65/67	IP65/67	IP65/67
Chemical resistance to water	resistant	resistant	resistant	resistant
<b>Product properties, functions, components general</b>				
Product feature silicon-free	Yes	Yes	Yes	Yes
Product component				
• PG connection socket	-	-	-	-
Product component strain relief	Yes	Yes	Yes	Yes
<b>Standards, specifications, approvals</b>				
Verification of suitability				
• RoHS conformity	Yes	Yes	Yes	Yes
• UL-registration	Yes	Yes	No	No

## PROFIBUS

### Electrical networks (RS485)

#### PROFIBUS M12 and 7/8" connecting cable/connector

##### Technical specifications (continued)

Article No.	6GK1905-0FA00	6GK1905-0FB00
<b>Product-type designation</b>	<b>7/8-inch connector</b>	<b>7/8-inch connector</b>
Product description	7/8" connector with pin insert, 5-pin	7/8" connector with female contact insert, 5-pin
Acceptability for application	For field assembly with ET200	For field assembly with ET200
<b>Transmission rate</b>		
Transfer rate with PROFIBUS	-	-
<b>Interfaces</b>		
Number of electrical connections for network components and terminal equipment	1	1
Design of electrical connection for network components and terminal equipment	7/8 inch plug (male insert)	7/8 inch plug (female insert)
<b>Mechanical data</b>		
Material of the enclosure	metal	metal
<b>Design, dimensions and weight</b>		
Type of cable outlet	180 degree cable outlet	180 degree cable outlet
Width	27 mm	27 mm
Height	27 mm	27 mm
Depth	83 mm	83 mm
Net weight	50 g	50 g
<b>Permitted ambient conditions</b>		
Ambient temperature		
• during operating	-40 ... +70 °C	-40 ... +70 °C
• during storage	-40 ... +80 °C	-40 ... +80 °C
• during transport	-40 ... +80 °C	-40 ... +80 °C
Relative humidity at 25 °C without condensation during operating maximum	-	-
Protection class IP	IP65/67	IP65/67
Chemical resistance to water	resistant	resistant
<b>Product properties, functions, components general</b>		
Product feature silicon-free	Yes	Yes
Product component strain relief	Yes	Yes
<b>Standards, specifications, approvals</b>		
Verification of suitability RoHS conformity	Yes	Yes

Ordering data	Article No.		Article No.
<b>PROFIBUS M12 plug-in cable</b> Pre-assembled with two 5-pole M12 male/female connectors up to 100 m max.; length: <ul style="list-style-type: none"> <li>• 0.3 m</li> <li>• 0.5 m</li> <li>• 1.0 m</li> <li>• 1.5 m</li> <li>• 2.0 m</li> <li>• 3.0 m</li> <li>• 5.0 m</li> <li>• 10 m</li> <li>• 15 m</li> </ul> Further special lengths with 90° or 180° cable outlet	6XV1830-3DE30 6XV1830-3DE50 6XV1830-3DH10 6XV1830-3DH15 6XV1830-3DH20 6XV1830-3DH30 6XV1830-3DH50 6XV1830-3DN10 6XV1830-3DN15  See <a href="http://support.automation.siemens.com/WWW/view/en/26999294">http://support.automation.siemens.com/WWW/view/en/26999294</a>	<i>Plug-in connector for assembly in the field</i>	
<b>7/8" plug-in cable</b> For power supply; pre-assembled with two 5-pole 7/8" male/female connectors up to 50 m max.; length: <ul style="list-style-type: none"> <li>• 0.3 m</li> <li>• 0.5 m</li> <li>• 1.0 m</li> <li>• 1.5 m</li> <li>• 2.0 m</li> <li>• 3.0 m</li> <li>• 5.0 m</li> <li>• 10 m</li> <li>• 15 m</li> </ul> Additional special lengths with 90° or 180° cable outlet	6XV1822-5BE30 6XV1822-5BE50 6XV1822-5BH10 6XV1822-5BH15 6XV1822-5BH20 6XV1822-5BH30 6XV1822-5BH50 6XV1822-5BN10 6XV1822-5BN15  See <a href="http://support.automation.siemens.com/WWW/view/en/26999294">http://support.automation.siemens.com/WWW/view/en/26999294</a>	<b>PROFIBUS M12 connectors</b> 5-pole, B-coded, metal casing, 1 pack = 5 items <ul style="list-style-type: none"> <li>• Male pins</li> <li>• Socket insert</li> </ul>	6GK1905-0EA00 6GK1905-0EB00
		<b>PROFIBUS FC M12 Plug PRO</b> M12 plug-in connector (B-coded) that can be assembled in the field, 5-pin, metal enclosure, FastConnect technology, pin insert; <ul style="list-style-type: none"> <li>• 1 pack = 5 items</li> </ul>	6GK1905-0EA10
		<b>PROFIBUS FC M12 Cable Connector PRO</b> M12 plug-in connector (B-coded) that can be assembled in the field, 5-pin, metal enclosure, FastConnect technology, socket insert; <ul style="list-style-type: none"> <li>• 1 pack = 5 items</li> </ul>	6GK1905-0EB10
		<b>7/8" plug-in connector</b> 5-pole, plastic casing, 1 pack = 5 items <ul style="list-style-type: none"> <li>• Male pins</li> <li>• Socket insert</li> </ul>	6GK1905-0FA00 6GK1905-0FB00
		<i>Power cables</i>	
		<b>Energy Cable (5 x 1.5 mm<sup>2</sup>)</b> Power cable with trailing capability with 5 copper cores (1.5 mm <sup>2</sup> ) for connecting to 7/8" plug-in connector; <u>sold by the meter;</u> max. 1 000 m; minimum order quantity 20 m	6XV1830-8AH10
		<b>7/8" Power T-Tap PRO</b> Power T-piece for ET 200 with two 7/8" socket inserts and one 7/8" pin insert 1 pack = 5 items	6GK1905-0FC00

**PROFIBUS**

Electrical networks (RS485)

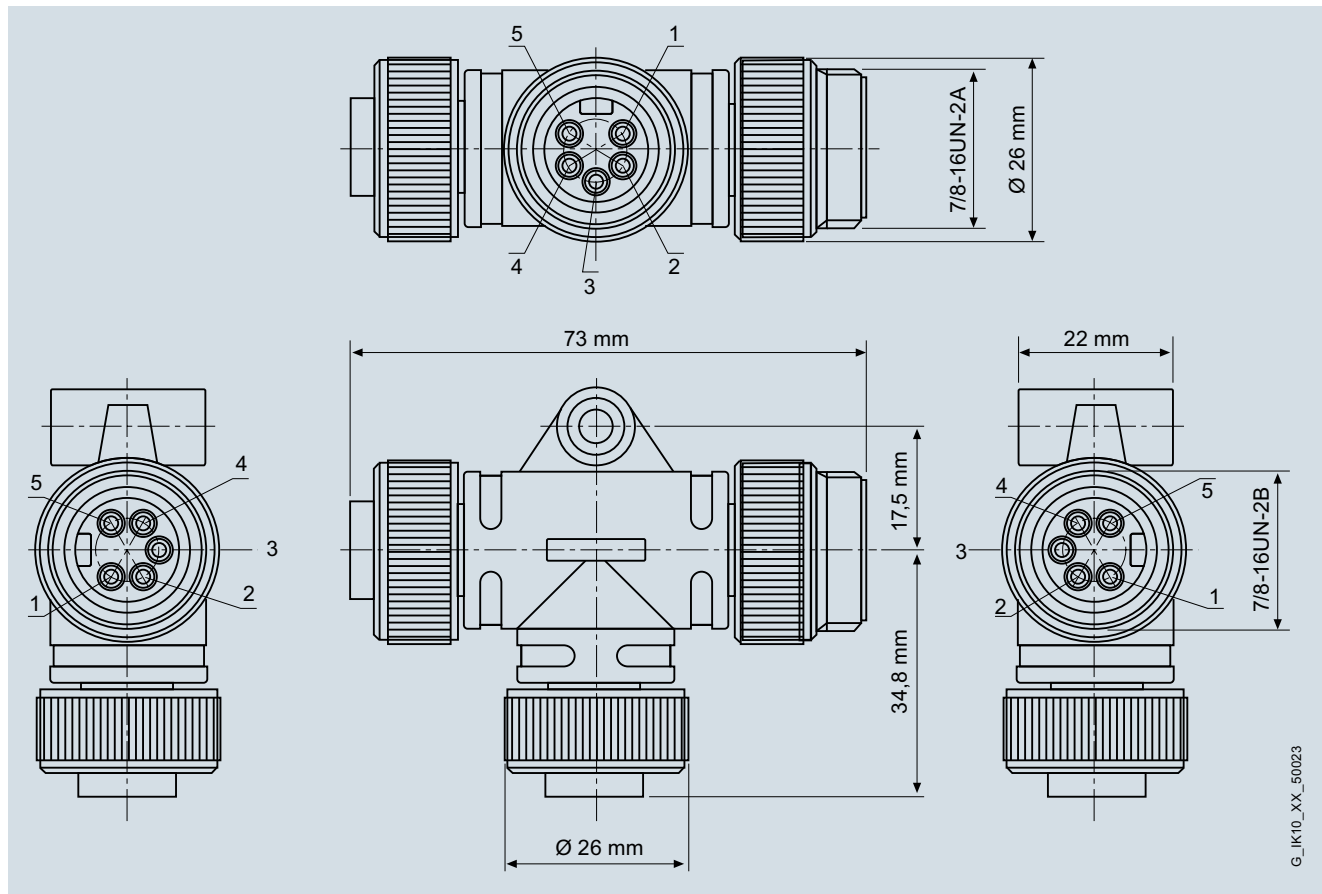
**PROFIBUS M12 and 7/8" connecting cable/connector****Dimensional drawings**

7/8" Power T-Tap PRO

**More information****Special lengths with 90° or 180° cable outlet**

You can find more information on the Internet at:

<http://support.automation.siemens.com/WW/view/en/26999294>

G\_IK10\_XX\_50023

### Overview



- For connecting PROFIBUS nodes with an RS485 interface to a segment
- Versions with transmission rates from 9.6 kbit/s to 12 Mbit/s
- Clear and easy mounting (can be snapped onto DIN rail)
- Clear location of faulty bus termination when bus terminal 12M is used
- PG connection with special bus terminal and PG connecting cable possible without additional installation of network nodes for bus terminal RS485.

### Benefits

**get** Designed for Industry

- Easy and clearly comprehensible connection of PROFIBUS stations thanks to preassembled, integrated connecting cable
- Simple cabinet pre-wiring by connecting the PROFIBUS connecting cable with integrated interfaces

### Application

The PROFIBUS bus terminals enable a bus station to be connected to a PROFIBUS network.

- Pre-wired device connection for PROFIBUS node
- Easy connection of stations to PROFIBUS networks through insertion of the radial line with Sub-D plug
- Implementation of multipoint connections by directly interconnecting several bus terminals (up to 32 stations per segment) with the 12M bus terminal.

### Design

Different versions are available:

- Up to 1.5 Mbit/s  
Bus terminal RS485
- Up to 12 Mbit/s  
Bus terminal 12M

Applicable to all versions:

- IP20 enclosure.
- Wall mounting or mounting on deep standard DIN rail possible.
- External 6-pin terminal block for connection of incoming and outgoing bus cable and equipotential bonding conductors.
- Integrated connecting cable with Sub-D plug for connection of nodes.
- Combination of terminating resistors can be connected by means of rotary switch.

The following additionally applies to the bus terminal 12M:

- Ranges for transmission rates can be adjusted by means of rotary switches.
- Supply to the bus terminal 12M by the connected PROFIBUS node (5 V DC/90 mA) via 9-pin Sub-D socket.
- For maximum segment lengths, see Technical Specifications.
- Incoming and outgoing bus cables are disconnected when inserting the terminating resistors.

## PROFIBUS

### Electrical networks (RS485)

#### Bus terminals

##### Function

- Connection of stations by means of integrated connecting cable with Sub-D plug.
- Easy connection of the bus cable by means of terminal block
- No interruption of bus if an end user station is missing
- Bus termination is possible by means of an integrated combination of terminating resistors.

The following additionally applies to the bus terminal 12M:

- Clear location of faulty termination within a segment (incoming and outgoing bus cables are separated when inserting the resistor combination)
- If the bus terminal 12M is used in a segment with RS485 bus terminals, the configuration rules of the RS485 bus terminal apply (see Manual for PROFIBUS Networks).

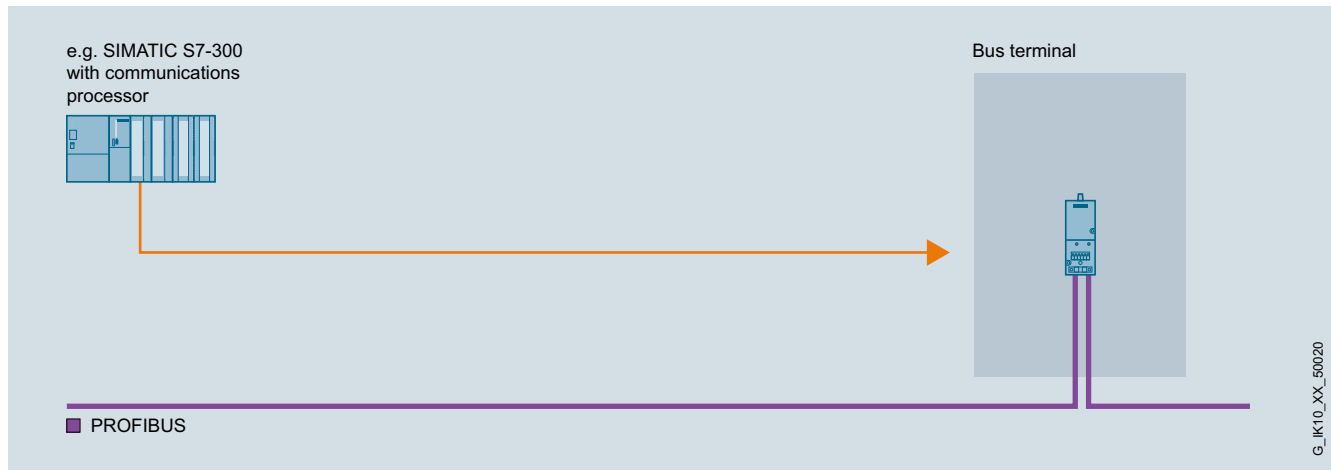

System connection with PROFIBUS bus terminals, e.g. for SIMATIC S7



### Technical specifications

Article No.	6GK1500-0AA10	6GK1500-0AB00	6GK1500-0DA00
Product-type designation	PROFIBUS bus terminal 12M	Bus terminal RS 485 (3m)	Bus terminal RS 485 (1.5 m)
<b>Electrical data</b>			
Transfer rate with PROFIBUS			
• minimum	9.6 kbit/s	9.6 kbit/s	9.6 kbit/s
• maximum	12 Mbit/s	1.5 Mbit/s	1.5 Mbit/s
<b>Interfaces</b>			
Number of electrical connections for PROFIBUS cables	2	2	2
<b>Mechanical data</b>			
Material of the enclosure	plastic	plastic	plastic
Design, dimensions and weight			
Width	50 mm	50 mm	50 mm
Height	138 mm	138 mm	138 mm
Depth	53 mm	53 mm	53 mm
Net weight	360 g	360 g	360 g
Mounting type 35 mm DIN rail mounting	Yes	Yes	Yes
<b>Standards, specifications, approvals</b>			
Verification of suitability UL-registration	Yes	-	-

### Ordering data

Ordering data	Article No.	Ordering data	Article No.
<b>Bus terminal RS485 for PROFIBUS</b>	<b>6GK1500-0AB00</b>	<b>PROFIBUS bus terminal 12M</b>	<b>6GK1500-0AA10</b>
Transmission rate 9.6 Kbit/s to 1 500 Kbit/s with plug-in cable 3.0 m long		Bus terminal for connection of PROFIBUS stations up to 12 Mbit/s with plug-in cable 1.5 m long	
<b>Bus terminal RS485 for PROFIBUS</b>	<b>6GK1500-0DA00</b>	<b>SIMATIC NET Manual Collection</b>	<b>6GK1975-1AA00-3AA0</b>
With installed programmer port and plug-in cable 1.5 m long		Electronic manuals for communication systems, communication protocols, and communication products; on DVD; German/English	

# PROFIBUS

## Electrical networks (RS485)

### Active RS 485 terminating element

#### Overview



- Terminates bus segments at data transmission rates of 9.6 kbit/s to 12 Mbit/s
- Power supply independent of bus stations.

#### Designed for Industry

- Terminal-independent bus termination through onboard power supply

#### Application

The active RS 485 terminating resistance is used to terminate bus segments. Power supply is independent of the stations. The terminating resistor is supplied with power separately from the other I/O components, either permanently or with a voltage applied ahead of the I/Os. By terminating the bus system the stations (e.g. ET 200S) can be coupled and decoupled selectively without malfunctions.

#### Design

- 1 terminal block for the segment connection
- Terminal block for power supply (24 V DC external)

#### Function

The active RS 485 terminating element terminates the PROFIBUS and therefore ensures a defined level of the RS 485 signal and suppression of reflections on the line. Since it is operated independently of the field devices, they can be decoupled from the bus without reactions.

#### Technical specifications

6ES7972-0DA00-0AA0	
<b>Supply voltage</b>	
24 V DC	Yes
permissible range, lower limit (DC)	20.4 V
permissible range, upper limit (DC)	28.8 V
<b>Input current</b>	
Current consumption, typ.	30 mA
<b>Interfaces</b>	
Bus cables	Screw terminal block
PROFIBUS DP	
• Transmission rate, max.	12 Mbit/s; 9.6 kbit/s to 12 Mbit/s
<b>Degree and class of protection</b>	
IP20	Yes
<b>Ambient conditions</b>	
Operating temperature	
• Min.	0 °C
• max.	60 °C
Storage/transport temperature	
• Min.	-40 °C
• max.	70 °C
Relative humidity	
• max. relative humidity	95 %; at +25 °C
<b>Connection method</b>	
Power supply	Screw terminal block
<b>Dimensions</b>	
Width	60 mm
Height	70 mm
Depth	43 mm
<b>Weights</b>	
Weight, approx.	95 g

#### Ordering data

#### Article No.

#### Active RS 485 terminating element for PROFIBUS

**6ES7972-0DA00-0AA0**

to complete bus segments for transmission rates of 9.6 kbit/s to 12 Mbit/s

#### More information

##### Brochures

Information material for downloading can be found in the Internet:

<http://www.siemens.com/simatic/printmaterial>

#### Overview



- Automatic detection of transmission rates
- Transmission rates from 9.6 kbit/s to 12 Mbit/s are possible, incl. 45.45 kbit/s
- 24 V DC voltage display
- Indication of bus activity segment 1 and 2
- The separation of segment 1 and segment 2 by means of switches is possible
- Separation of the right segment with an inserted terminating resistor
- Decoupling of segment 1 and segment 2 in the case of static interference

#### Designed for Industry

- For increasing the expansion
- Electric isolation of segments
- Commissioning support
  - Switches for separation of segments
  - Bus activity display
  - Segment separation in the case of an incorrectly inserted terminating resistor

In this context, please also note the diagnostics repeater that provides extensive diagnostics functions for physical line diagnostics in addition to the normal repeater functionality. This is described in "Distributed I/O / diagnostics / diagnostics repeater for PROFIBUS DP".

#### Application

The RS 485 IP20 repeater connects two PROFIBUS or MPI bus segments using the RS 485 system with up to 32 stations. Data transmission rates of 9.6 kbit/s to 12 Mbit/s are then possible.

#### Design

- Housing to degree of protection IP20.
- 2 terminal blocks for connecting the segment
- Terminal block for supply voltage (24 V DC external).
- PG/OP interface.

#### Function

##### Mode of operation

- Increasing the number of stations (max. 127) and the expansion
- Regenerating the signals in amplitude and time
- Electrical isolation of the connected bus systems

Data transmission rate	Max. segment length
9.6 kbit/s	1 000 m
19.2 kbit/s	1 000 m
45.45 kbit/s	1 000 m
93.75 kbit/s	1 000 m
187.5 kbit/s	1 000 m
500 kbit/s	400 m
1 500 kbit/s	200 m
3 000 kbit/s	100 m
6 000 kbit/s	100 m
12 000 kbit/s	100 m

**PROFIBUS****Electrical networks (RS485)****Repeater RS 485 for PROFIBUS****Technical specifications**

<b>6ES7972-0AA02-0XA0</b>	
<b>Supply voltage</b>	
24 V DC	Yes
permissible range, lower limit (DC)	20.4 V
permissible range, upper limit (DC)	28.8 V
<b>Input current</b>	
Current consumption, max.	100 mA; 100 mA without loads at PG/OP socket; 130 mA load at PG/OP socket (5 V/90 mA); 200 mA load at PG/OP socket (24 V/100 mA)
<b>Interfaces</b>	
Bus cables	2 terminal blocks
PROFIBUS DP	
• Transmission rate, max.	12 Mbit/s; 9.6 kbit/s to 12 Mbit/s
<b>Degree and class of protection</b>	
IP20	Yes
<b>Ambient conditions</b>	
Operating temperature	
• Min.	0 °C
• max.	60 °C
Storage/transport temperature	
• Min.	-40 °C
• max.	70 °C
Relative humidity	
• max. relative humidity	95 %; at 25 °C
<b>Connection method</b>	
Power supply	Terminal block
<b>Dimensions</b>	
Width	45 mm
Height	128 mm
Depth	67 mm
<b>Weights</b>	
Weight, approx.	350 g

**Ordering data****Article No.**

**RS 485 repeater for PROFIBUS**  
Transfer rate up to max. 12 Mbit/s,  
24 V DC, enclosure IP20

**6ES7972-0AA02-0XA0**

**More information****Brochures**

Information material for downloading can be found in the Internet:

<http://www.siemens.com/simatic/printmaterial>

## Overview



- RS 485 repeater with online line diagnostics for PROFIBUS DP
- DP standard PROFIBUS slave (DP-V1)
- Automatic determination of fault types and locations
- Data transmission rate 9.6 kbit/s to 12 Mbit/s
- Connection through FastConnect using the insulation displacement method

## Application

The diagnostics repeater for PROFIBUS DP connects PROFIBUS DP segments with RS 485 technology. It also physically monitors the copper bus lines in online mode.

If an error occurs, it sends a diagnostic message to the DP master with detailed information on the type and location of the error.

The diagnostics repeater is a standard slave. It can be operated on any DP master that supports the standard RD\_REC and WR\_REC services. To record the topology, you will need either STEP 7 or COM PROFIBUS.

## Design

- Enclosure with degree of protection IP20
- Assembly on S7-300 DIN rails or standard DIN rails
- LEDs to display 24 V DC, bus activity and line errors per segment
- Terminal block for external 24 V DC supply voltage
- 9-pin Sub-D socket for PG connection
- Connections for 3 bus segments with FastConnect insulation displacement connection
- The diagnostics repeater is integrated into the bus system as a PROFIBUS DP standard slave. It enables the following:
  - monitoring of 2 PROFIBUS DP segments
  - max. 31 stations per segment (max. 62 stations per diagnostics repeater)
  - max. segment length 100 m (independent of the baud rate)
  - configuration of up to 9 diagnostics repeaters in a row
- Use only approved bus connectors on the diagnostics-capable segments (see Ordering Information/Accessories)
- Observe the configuration guidelines for 12 MBaud networks

## Function

### Mode of operation

#### Repeater functionality

The diagnostics repeater is integrated into the bus system as a RS 485 repeater, but it has its own PROFIBUS DP address:

- Expansion of extension in the bus system
- Regeneration of the signals in edge steepness, amplitude and time (re-timing)
- Isolates connected segments
- Configuration in STEP 7, COM PROFIBUS or also using a GSD file.

As of FW Version V2.0.0, the following additional functions will be supported:

- I&M functions according to PROFIBUS Guideline Order No. 3.502 in version V1.1, dated May 2003
- Time synchronization via S7 mechanisms
- DP cycle time measurement and statistics

## PROFIBUS

### Electrical networks (RS485)

#### Diagnostics repeater for PROFIBUS DP

##### Function (continued)

###### Diagnostic functionality

Initiated by STEP 7, COM PROFIBUS or the user program (SIMATIC S7-400 / S7-300), the diagnostics repeater identifies the topology of the connected segments and saves this information in the internal diagnostic memory.

If an error occurs, the repeater automatically transmits a standard diagnostic message to the bus master with the following information:

- Affected segment
- Error location (e.g. between station X and Y)
- Distance from stations X and Y as well as from the repeater in meters to the error location
- Type of error

The following errors are diagnosed:

- Break in signal lines A or B
- Short circuit of signal lines A or B on the shield
- Absent terminating resistors
- Unacceptable cascading depth (between any two nodes, no more than 9 repeaters be connected in series)
- Too many stations in a segment
- Station too far from the diagnostics repeater
- Faulty messages

**Sporadic** errors are also detected.

The error messages are displayed graphically in STEP 7 and COM PROFIBUS. They are completely integrated in the SIMATIC system diagnostics (e.g. overview diagnostics, "Report system error" function).

The display in STEP7 also includes a help text with troubleshooting measures. The help text is written in a way that does not require specific PROFIBUS expertise, so that the error can be quickly localized and removed.

###### Network topology and statistics display

You can view the topology graphically in Step 7 as of V5.2. The stations and the line lengths are shown in the topology display.

You can also view the bus system quality in the form of statistical information.

###### Print function

STEP 7 V53.3, SP 3 includes an improved print function. It allows you to preview on the screen and optimize the printout. For instance, you can hide certain details and print out an overview of the topology on DIN A4 or DIN A3 paper.

###### Configuring

The diagnostics repeater is configured as follows:

- STEP 7 V5.1 or higher, incl. Service Pack 2
- COM PROFIBUS V5.1, incl. Service Pack 2
- External tools: Use GSD file

The topology can be determined using external masters with the help of the COM PROFIBUS. The topology cannot be identified using an external configuration tool. However, if the topology is determined once using the COM PROFIBUS, error location information will also be displayed in the external configuration tool.

##### Technical specifications

6ES7972-0AB01-0XA0	
<b>Supply voltage</b>	
24 V DC	Yes
permissible range, lower limit (DC)	20.4 V
permissible range, upper limit (DC)	28.8 V
<b>Interfaces</b>	
Bus cables	FastConnect insulation displacement, 10 clamping cycles possible
PROFIBUS DP	
• Transmission rate, max.	12 Mbit/s; 9.6 kbit/s to 12 Mbit/s
<b>Degree and class of protection</b>	
IP20	Yes
<b>Ambient conditions</b>	
Operating temperature	
• Min.	0 °C
• max.	60 °C
Storage/transport temperature	
• Min.	-40 °C
• max.	70 °C
Relative humidity	
• max. relative humidity	95 %; at 25 °C
<b>Connection method</b>	
Power supply	Terminal block
<b>Dimensions</b>	
Width	80 mm
Height	125 mm
Depth	67.5 mm
<b>Weights</b>	
Weight, approx.	300 g

Ordering data	Article No.		Article No.
<b>RS 485 Diagnostic Repeater</b> For connection of 1 or 2 segments to PROFIBUS DP; with online diagnostics functions for monitoring the bus cables	<b>6ES7972-0AB01-0XA0</b>		
<b>Accessories</b> <b>RS 485 bus connector with 90° cable outlet</b> With screw terminals Max. transfer rate 12 Mbit/s <ul style="list-style-type: none"> <li>• Without PG interface</li> <li>• With PG interface</li> </ul>	<b>6ES7972-0BA12-0XA0</b> <b>6ES7972-0BB12-0XA0</b>	<b>Accessories (continued)</b> <b>PROFIBUS FastConnect RS 485 bus connector with angular cable outlet (35°)</b> With insulation displacement terminals, max. transfer rate 12 Mbit/s <ul style="list-style-type: none"> <li>• Without PG interface</li> <li>• With PG interface</li> </ul>	<b>6ES7972-0BA60-0XA0</b> <b>6ES7972-0BB60-0XA0</b>
<b>PROFIBUS FastConnect bus connector RS 485 with 90° cable outlet</b> With insulation displacement terminals Max. data transfer rate 12 Mbit/s Without PG interface <ul style="list-style-type: none"> <li>• 1 unit</li> <li>• 100 units</li> </ul> With PG interface <ul style="list-style-type: none"> <li>• 1 unit</li> <li>• 100 units</li> </ul> without PG interface, grounding via control cabinet cover <ul style="list-style-type: none"> <li>• 1 unit</li> </ul> with PG interface, grounding via control cabinet cover <ul style="list-style-type: none"> <li>• 1 unit</li> </ul>	<b>6ES7972-0BA52-0XA0</b> <b>6ES7972-0BA52-0XB0</b>  <b>6ES7972-0BB52-0XA0</b> <b>6ES7972-0BB52-0XB0</b>  <b>6ES7972-0BA70-0XA0</b>  <b>6ES7972-0BB70-0XA0</b>	<b>PROFIBUS FastConnect Stripping Tool</b> Preadjusted stripping tool for fast stripping of PROFIBUS FastConnect bus cables	<b>6GK1905-6AA00</b>
<b>RS 485 bus connector with angled cable outlet (35°)</b> With screw terminals, max. transfer rate 12 Mbit/s <ul style="list-style-type: none"> <li>• Without PG interface</li> <li>• With PG interface</li> </ul>	<b>6ES7972-0BA42-0XA0</b> <b>6ES7972-0BB42-0XA0</b>	<b>PROFIBUS FC Standard Cable</b> Standard type with special design for quick mounting, 2-core, shielded, sold by the meter, max. delivery unit 1 000 m, minimum order quantity 20 m	<b>6XV1830-0EH10</b>
		<b>S7 Manual Collection</b> Electronic manuals on DVD, multilingual: S7-200, TD 200, S7-300, M7-300, C7, S7-400, M7-400, STEP 7, Engineering Tools, Runtime Software, SIMATIC DP (Distributed I/O), SIMATIC HMI (Human Machine Interface), SIMATIC NET (Industrial Communication)	<b>6ES7998-8XC01-8YE0</b>
		<b>S7 Manual Collection update service for 1 year</b> Scope of delivery: Current DVD "S7 Manual Collection" and the three subsequent updates	<b>6ES7998-8XC01-8YE2</b>
		<b>Connecting cable for PROFIBUS</b> 12 Mbit/s, for PG connection to PROFIBUS DP, preassembled with 2 x 9-pin sub D connector, 3.0 m	<b>6ES7901-4BD00-0XA0</b>

## More information

### Brochures

Information material for downloading can be found in the Internet:

<http://www.siemens.com/simatic/printmaterial>

## PROFIBUS

### Electrical networks (PROFIBUS PA)

#### Introduction

#### Overview

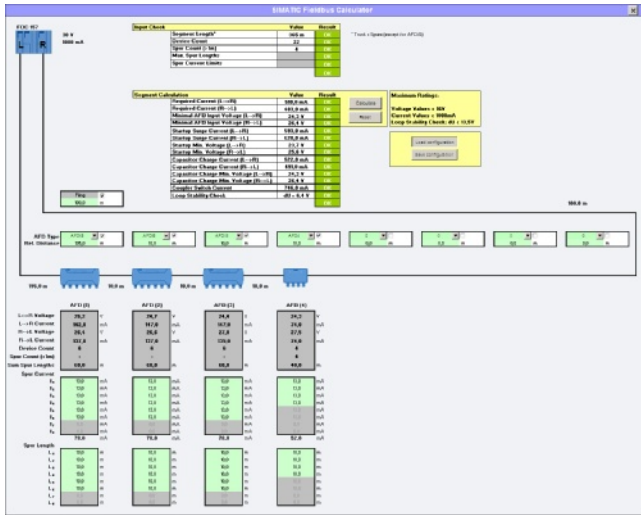

SIMATIC Fieldbus Calculator

Direct interfacing of the devices in the field, especially in the hazardous area, together with the information content of the communication, are of significant importance in the process industry. PROFIBUS PA, which permits both digital data transmission and the power supply on a two-wire line with the intrinsically-safe MBP transmission technology (Manchester Coded; Bus Powered) is tailored to these requirements. It is optimally suitable for direct integration of solenoid valves, sensors, and pneumatic actuators positioned in operating environments up to Ex zone 1/21 or 0/20 into the process control system.

The typical response time of a transmitter of approx. 10 ms indicates that short cycle times can be achieved with the PROFIBUS PA even in the case of a segment configuration with up to 31 devices. Practically all typical applications of the process industry can be implemented, both in small and large plants. Bidirectional communication and high information content allow enhanced diagnostics for fast and exact fault detection and elimination. The standardized communications services guarantee interoperability and replaceability between multi-vendor field devices and remote configuration of the field devices during operation.

#### Safety communication with the PROFIsafe profile

The PROFIsafe profile allows seamless integration of safety communication into the PROFIBUS PA. You need not configure a separate safety bus for your safety-related applications. The PROFIBUS PA with the PROFIsafe profile is incorporated in "Safety Integrated for Process Automation". This comprehensive range of products and services from Siemens for failsafe, fault-tolerant applications in the process industry offers you attractive and cost-effective alternatives to separate safety systems.

#### Redundant architectures

You can define the degree of redundancy separately for the controller, fieldbus and I/O levels of your plant depending on the automation task and the derived safety requirements, and match them to the field instrumentation (Flexible Modular Redundancy, FMR). You can find an overview of the redundant architectures of PROFIBUS PA under "Design".

#### Network transition PROFIBUS PA to PROFIBUS DP

The PA link is preferred as the gateway from PROFIBUS PA to PROFIBUS DP. When using the PA link, the transmission rate on the PROFIBUS DP is independent of the lower-level PROFIBUS PA segments. The configuration of the PA link depends on the fieldbus architecture. The types of coupler described in the section "PA routers" can be used for the configuration. With a small volume of data (small quantity structure) and low time requirements, the DP/PA coupler can also be operated in stand-alone mode as a gateway.

#### Benefits

Advantages provided by distributed field automation with application of the PROFIBUS PA profile included low hardware overhead, cost-effective engineering, increased operational safety and problem-free maintenance. These advantages are underlined by the following features:

- Modularity and uniformity from the sensor up to the control level permit new plant concepts
- Implementation of intrinsically-safe applications through use of the fieldbus in hazardous areas
- Redundant PROFIBUS PA architectures (ring and line topologies with coupler redundancy) support Flexible Modular Redundancy (FMR) from the automation system (controller) down to a PA field device
- Safety-related and fault-tolerant applications with low device and cabling requirements
- Reduced configuration costs through simple, central engineering of the field devices (PROFIBUS PA and HART with SIMATIC PDM, also cross-vendor)
- Simple installation using two wire cable for common power supply and data transmission
- Reduced commissioning costs through simplified loop check
- Low servicing costs thanks to simple wiring and comprehensive diagnostics facilities



### Design

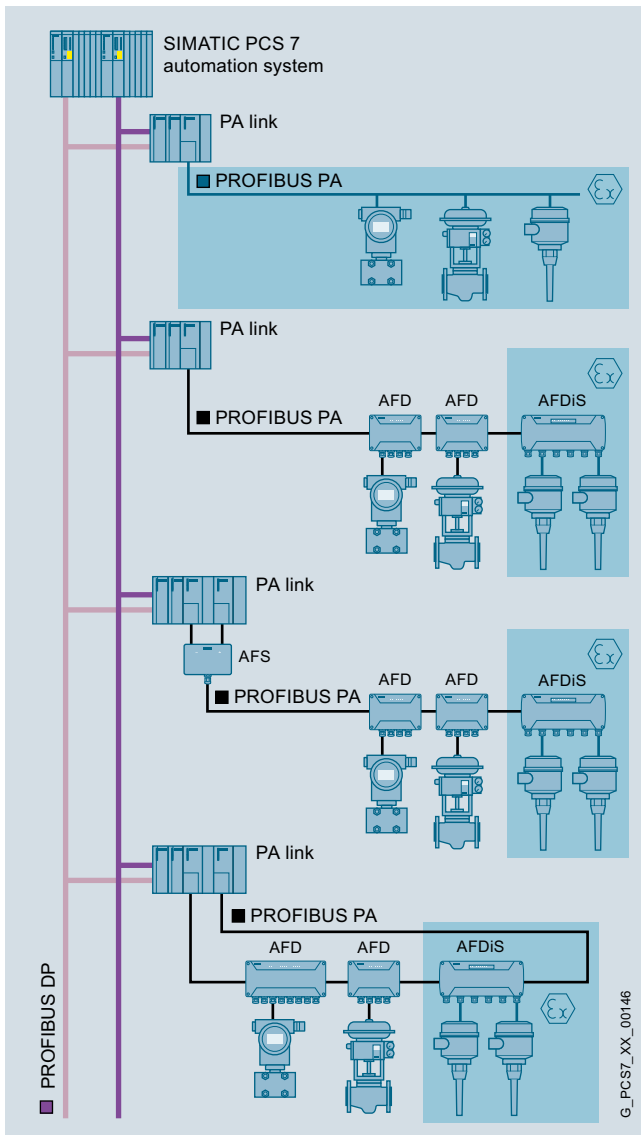

Basic PROFIBUS PA design versions when using the PA link as the PA router

Basic PROFIBUS PA design versions are shown at this point. The PA link is used as the PA router in these configuration examples.

However, the PA router can only be implemented per DP/PA coupler. The PROFIBUS DP connection is then directly on the coupler instead of per interface module.

The number of PROFIBUS PA devices is limited according to the specifications in section "Technical data".

### Line architecture with single coupler

Max. 5 PROFIBUS PA lines (line segments) can be operated via single couplers (max. 3 for mixed configurations with ring or coupler redundancy) on a PA link as PA router, equipped with up to 5 DP/PA couplers.

In the line architecture with individual couplers, each line segment is connected to one DP/PA coupler of the PA router. The PA router can be connected to a single or redundant PROFIBUS DP.

The FDC 157-0 the first choice as the DP/PA coupler. When using this coupler, the PA devices can be integrated into the line segment via active field distributors AFD4 and AFD8 (approval for Ex zone 2/22) and AFDiS (approval for Ex zone 1/21). The PA devices are connected to these field distributors via short-circuit-proof spur lines.

Up to 8 field distributors of type AFD4/AFD8, 5 field distributors of type AFDiS, or 5 field distributors of both AFDiS and AFD4/AFD8 types combined can be optionally operated in a line segment. The last field distributor at the end of the line leading away from the DP/PA coupler automatically activates its bus terminating resistor.

Intrinsically-safe PA devices in hazardous areas in accordance with Ex zone 1/21 or 0/20 are primarily integrated into a bus segment by means of active field distributors AFDiS. For PA devices in Ex zone 1/21, the connection via a line segment on the PA router with DP/PA coupler Ex [i] is a possible alternative. The devices are integrated separately into the line segment via SplitConnect Taps (via spur line or directly via SplitConnect M12 outlet). A SplitConnect terminator is required for the bus termination of the segment.

By grouping individual devices in different line segments, Flexible Modular Redundancy is possible at device level.

### Line architecture with redundant coupler

The PA link operable as a PA router on a single or redundant PROFIBUS DP can only be equipped with one redundant DP/PA coupler pair (up to 3 single couplers can also be optionally configured). The redundant DP/PA coupler pair can be used either for a line architecture with Active Field Splitter (AFS) or for a ring architecture.

With a line architecture, the AFS is connected to the redundant DP/PA coupler pair (2 x FDC 157-0) in the PA router. It connects the line segment connected to it to the active of the two redundant DP/PA couplers. A DP/PA coupler can be replaced without interrupting the ongoing operation.

The PA devices are integrated in the line segment as for a line architecture with single couplers via active field distributors AFD4, AFD8 or AFDiS. The limits with respect to the number of field distributors are also identical (up to 8 AFD4/AFD8, up to 5 AFDiS or up to 5 AFDiS and AFD4/AFD8 in any combination).

# PROFIBUS

## Electrical networks (PROFIBUS PA)

### Introduction

#### Design (continued)

##### Ring architecture with coupler and media redundancy

With the redundant DP/PA coupler pair (2 x FDC 157-0) of a PA router, a ring segment with automatic bus termination can also be implemented instead of a line segment with AFS. Apart from the ring segment, only line segments with individual couplers can be configured on this PA router. The PA router can be connected to a single or a redundant PROFIBUS DP.

Integration of the PA field devices into the ring segment is carried out via active field distributors AFD4, AFD8 or AFDiS, the number of which is limited as with the line architectures (up to 8 AFD4/AFD8, up to 5 AFDiS or up to 5 AFDiS and AFD4/AFD8 in any combination). These field distributors have electrically decoupled, short-circuit-proof spur line connections for connecting the PA devices.

At the device level, flexible modular redundancy is possible by grouping individual devices on different field distributors.

Special advantages of the ring architecture:

- High availability
- Transparent redundancy management of the intelligent DP/PA couplers FDC 157-0 for the host system
- Active bus terminators for automatic bus termination in the DP/PA couplers FDC 157-0 and the active field distributors AFD4, AFD8 and AFDiS enable:
  - Automatic, smooth isolation of faulty subsegments in the event of a short-circuit or open-circuit
  - Modification of the ring configuration or instrumentation during operation, including the addition or removal of ring segments
- Safety-related and fault-tolerant applications with low device and cabling requirements

##### Cable lengths of bus segments and spur lines

The PROFIBUS PA is based on electrical transmission components. A shielded two-wire cable is used for digital data transmission and for the power supply of the field devices.

With line, tree and ring topologies, bus segments up to approx. 1.9 km can be configured. If AFD4/AFD8 active field distributors are used, the length of the spur lines for connecting devices and the quality of the cable used must also be considered when calculating the total length of the bus segment. Spur lines on the AFDiS are not relevant to the total length of the bus segment.

For bus segments with active field distributors, the spur lines can have the following maximum lengths:

- Up to 120 m in accordance with IEC 61158-2
- Up to 60 m in accordance with IEC 60079-27 (FISCO)

With AFD4/AFD8 active field distributors, these maximum values may be reduced depending on the number of spur lines of the bus segment (for details, see section "Technical specification"). With the active field distributor AFDiS, this reduction is canceled by the integrated repeater function.

The **SIMATIC Fieldbus Calculator** provides help in calculating and designing fieldbus segments:

<http://support.automation.siemens.com/WW/view/en/53842953>

Intrinsically-safe PA devices in hazardous areas are preferably integrated into a bus segment by means of active field distributors AFDiS. For PA devices in Ex zone 1/21, the connection via a line segment on the PA router with DP/PA coupler Ex [i] is a possible alternative. In such a configuration the max. possible length per spur line is reduced to 30 m and per bus segment to 1 km.

Bus segments are terminated either automatically (with architectures with active field distributors AFD4, AFD8, AFDiS) or with the passive terminating element for PROFIBUS PA (SplitConnect terminator).

#### Technical specifications

##### PROFIBUS PA

Data transmission	MBP
Transmission rate	31.25 Kbps
Cable	2-wire shielded
Type of protection	EEx(ia/ib)
Topology	Line, tree, ring
Active field distributors per segment/coupler	
• AFD4/AFD8	8
• AFDiS or combinations of AFDiS and AFD4/AFD8	5
PA devices per segment/coupler	31
PA devices per PA link	64
Max. current for all PA field devices of a segment (for PA gateways with FDC 157-0 coupler)	1 A
Cable length per segment, dependent on transmission rate	1 900 m: standard 1 900 m: EEx(ib) 1 000 m: EEx(ia)

##### Bus segments with AFD4/AFD8

Max. spur line length related to the total number of spur lines

Number of spur lines (1 device per spur line)	
• 1 to 12 spur lines	120 m
• 13 to 14 spur lines	90 m
• 15 to 18 spur lines	60 m
• 19 to 24 spur lines	30 m
• 25 to 31 spur lines	1 m

##### Bus segments with AFDiS

Max. spur line length independent of total number of spur lines

Number of spur lines (1 device per spur line)	
• 1 to 31 spur lines	
- Not intrinsically-safe	120 m
- Intrinsically-safe acc. to FISCO	60 m

## Overview



- Used for constructing fieldbus segments as per IEC 61158-2 (e.g. PROFIBUS PA) with field device interface points
- Easy assembly of the bus cable thanks to the FastConnect system (FastConnect stripping tool, FC process cable compliant with IEC 61158-2)
- The terminal devices can be connected using the FC Process Cable in accordance with IEC 61158-2 or the SplitConnect M12 Outlet/M12 Jack
- Combination of terminating resistors can be integrated (SplitConnect terminator)

## Benefits

get **Designed for Industry**

- Easy connection of terminals due to use of the FastConnect system
- Wide variety of applications thanks to modular SplitConnect system
- Reduction in number of types and parts thanks to uniform connection system for PROFIBUS PA

3

## Application

- The SplitConnect Tap enables the design of fieldbus segments according to IEC 61158-2 (e.g. PROFIBUS PA) with terminal device connection points.
- The SplitConnect Coupler can be used to construct a PROFIBUS PA hub by connecting SplitConnect Taps in series.
- By replacing the contacting screw with the SplitConnect terminator, the SplitConnect tap can be used as a bus terminating element.

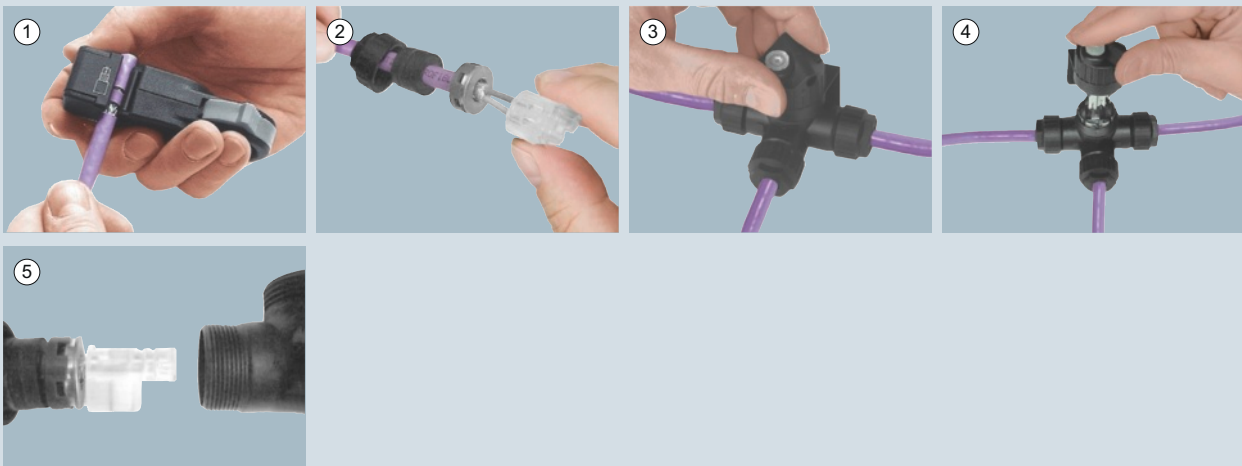

G\_IK10\_XX\_50011

## PROFIBUS

### Electrical networks (PROFIBUS PA)

#### SplitConnect

##### Design



##### Function

- The SplitConnect tap enables configuration of fieldbus segments according to IEC 61158-2 (e.g. PROFIBUS PA) and connection of terminals
- Easy pre-assembly of the SplitConnect taps through the FastConnect connection system (FastConnect stripping tool, FC Process Cable)
- Connection of the terminals directly through FC Process Cable or SplitConnect M12 outlet

- Rugged plastic casing made of PBT (polybutylene terephthalate) in IP67 design
- UV-resistant, making it possible to use outdoors
- Complete shielding by means of integrated metal enclosure
- Easier cable connection through the use of FC process cable
- Contacting and connection of the FC process cable by means of ID contacts using contacting screw
- Additional grounding of the SplitConnect tap possible by using a contacting screw
- DIN rail mounting or wall mounting possible

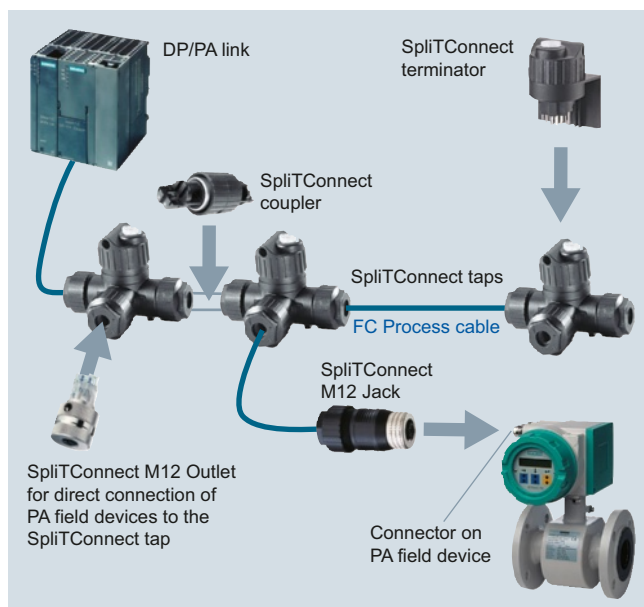

**Technical specifications**

Article No.	6GK1905-0AA00	6GK1905-0AB10	6GK1905-0AC00
Product-type designation	Split Connect Tap	Split Connect M12 Outlet	Split Connect Coupler
<b>Interfaces</b>			
Number of electrical connections	3	-	-
• for PROFIBUS cables	-	-	-
• for network components and terminal equipment	-	-	-
Design of the electrical connection	integrated insulation displacement contacts	-	-
• for PROFIBUS cables	-	-	-
• FastConnect	-	-	-
<b>Mechanical data</b>			
Cable gland version	-	-	-
Material of the enclosure	PBT (polybutyleneterephthalate)	-	-
<b>Design, dimensions and weight</b>			
Width	84 mm	-	-
Height	54 mm	-	-
Depth	49 mm	-	-
Net weight	170 g	-	-
Mounting type	Yes	-	-
35 mm DIN rail mounting	-	-	-
Mounting type wall mounting	Yes	-	-
<b>Permitted ambient conditions</b>			
Ambient temperature			
• during operating	-40 ... +85 °C	-40 ... +85 °C	-40 ... +85 °C
• during storage	-40 ... +85 °C	-40 ... +85 °C	-40 ... +85 °C
• during transport	-40 ... +85 °C	-40 ... +85 °C	-40 ... +85 °C
Protection class IP	IP67	IP67	IP67
<b>Product properties, functions, components general</b>			
Verification of suitability	Yes	-	-
UL-registration	-	-	-

Article No.	6GK1905-0AD00	6GK1905-0AE00	6GK1905-0AF00
Product-type designation	Split Connect Terminator (Ex)	Split Connect Terminator (non-Ex)	Split Connect M12 Jack
<b>Interfaces</b>			
Number of electrical connections	-	-	1
• for PROFIBUS cables	-	-	-
• for network components and terminal equipment	-	-	-
Design of the electrical connection	-	-	integrated insulation displacement contacts
• for PROFIBUS cables	-	-	-
• FastConnect	-	-	-
<b>Mechanical data</b>			
Material of the enclosure	-	-	-
<b>Design, dimensions and weight</b>			
Width	-	-	-
Height	-	-	-
Depth	-	-	-
Net weight	-	-	-
Mounting type	-	-	-
35 mm DIN rail mounting	-	-	-
Mounting type wall mounting	-	-	-
<b>Permitted ambient conditions</b>			
Ambient temperature			
• during operating	-40 ... +85 °C	-40 ... +85 °C	-40 ... +85 °C
• during storage	-40 ... +85 °C	-40 ... +85 °C	-40 ... +85 °C
• during transport	-40 ... +85 °C	-40 ... +85 °C	-40 ... +85 °C
Protection class IP	IP67	IP67	IP67
<b>Product properties, functions, components general</b>			
Verification of suitability	-	-	-
UL-registration	-	-	-

**PROFIBUS****Electrical networks (PROFIBUS PA)****SplitConnect****Ordering data****Article No.****Article No.****SplitConnect Tap**

For assembling PROFIBUS PA segments and connecting PA field devices, insulation displacement method, IP67

Type of delivery:  
1 package = 10 items

**6GK1905-0AA00****SplitConnect terminator (Ex version)**

For terminating PROFIBUS PA segments, can be used in hazardous areas

Type of delivery:  
1 package = 5 items

**6GK1905-0AD00****SplitConnect M12 outlet**

Element for direct connection of PROFIBUS PA field devices to the SplitConnect tap through M12 connection

Type of delivery:  
1 package = 5 items

**6GK1905-0AB10****SplitConnect terminator (non-Ex version)**

For terminating PROFIBUS PA segments, cannot be used in hazardous area

Type of delivery:  
1 package = 5 items

**6GK1905-0AE00****SplitConnect coupler**

Coupling element for connecting SplitConnect taps in series to configure star points

Type of delivery:  
1 package = 10 items

**6GK1905-0AC00****SplitConnect M12 jack**

Connector element for direct connection of PROFIBUS PA field devices to the PROFIBUS PA segment through M12 connection

Type of delivery:  
1 package = 5 items

**6GK1905-0AF00**

### Overview

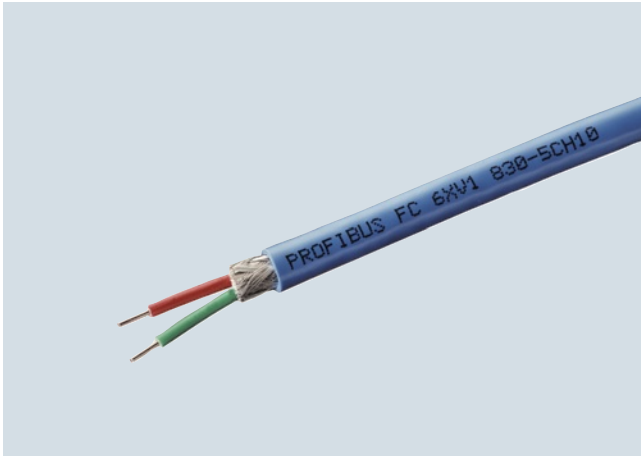

- Bus cable for fieldbus systems according to IEC 61158-2, e.g. PROFIBUS PA
- High interference immunity thanks to double shielding
- Different variants for different applications (hazardous areas, non-hazardous areas)
- Easy length measurement thanks to printed meter markings

### Benefits

get **Designed for Industry**

- Length can easily be determined due to meter length markings printed on the cable
- Complete range of cables for hazardous and non-hazardous areas
- Reduction of types and parts thanks to a uniform connection system for PROFIBUS PA

### Application

For the construction of fieldbus networks according to IEC 61158-2 (for example PROFIBUS PA), different color-coded cable types are available for the different types of applications (hazardous, non-hazardous areas).

### UL approvals

Different cable variants are offered with appropriate UL approvals for laying in cable bundles and cable racks according to the specifications of NEC (National Electrical Code) Article 800/725.

### Design

- Shielded, twisted-pair cable with circular cross-section
- System-wide grounding concept can be implemented using the external shield of the bus cable and the grounding terminals of the SplitConnect system.
- Printed meter marks.

### Cable types

- FC Process Cable:  
Special bus cable compliant with IEC 61158-2 for use in hazardous (Ex) and non-hazardous (non-Ex) areas.
- Bus segments with RS485 and IEC 61158-2 transmission procedures are linked by means of the segment coupler/link.

# PROFIBUS

## Electrical networks (PROFIBUS PA)

### Bus cables

#### Technical specifications

Article No.	6XV1830-5FH10	6XV1830-5EH10
Product-type designation	PROFIBUS FC Process Cable GP	PROFIBUS FC Process Cable GP
Product description	Bus cable (2-core), sold by the meter, in bulk	Bus cable (2-core), sold by the meter, in bulk
Acceptability for application	For use in fieldbus systems according to IEC 61158-2 (e.g. PROFIBUS PA), suitable for non-Ex applications	For use in fieldbus systems according to IEC 61158-2 (e.g. PROFIBUS PA), suitable for Ex applications
Cable designation	02YSY (ST) CY 1x2x1.0/2.55-100 SW OE FR	02YSY (ST) CY 1x2x1.0/2.55-100 BL OE FR
Cable length	-	-
<b>Electrical data</b>		
Damping ratio per length at 38.4 kHz maximum	3 dB/km	3 dB/km
Impedance		
• Nominal value	100 Ω	100 Ω
• at 31.25 kHz	100 Ω	100 Ω
Relative symmetrical tolerance of surge impedance at 31.25 kHz	20 %	20 %
Loop resistance per length maximum	44 Ω/km	44 Ω/km
Shield resistance per length maximum	6.5 Ω/km	6.5 Ω/km
Capacity per length at 1 kHz	92 pF/m	92 pF/m
Inductance per length	0.65 μH/m	0.65 μH/m
Operating voltage RMS value	100 V	100 V
<b>Mechanical data</b>		
Number of electrical wires	2	2
Design of shield	Overlapped aluminum-clad foil, sheathed in a braided screen of tin-plated copper wires	Overlapped aluminum-clad foil, sheathed in a braided screen of tin-plated copper wires
Design of the electrical connection FastConnect	Yes	Yes
Outer diameter		
• of the inner conductor	1.05 mm	1.05 mm
• of the wire insulation	2.55 mm	2.55 mm
• of the inner sheath of the cable	5.4 mm	5.4 mm
• of the cable sheath	8 mm	8 mm
Symmetrical tolerance of outer diameter of cable sheath	0.4 mm	0.4 mm
Outer diameter of the cable sheath	-	-
Note		
Material		
• of the wire insulation	PE	PE
• of the inner sheath of the cable	PVC	PVC
• of the cable sheath	PVC	PVC
- Note	-	-
Color		
• of the insulation of data wires	red / green	red / green
• of the cable sheath	Black	Blue
Bending radius		
• with single bend minimum permissible	40 mm	40 mm
• with multiple bends minimum permissible	80 mm	80 mm
• with continuous bending	-	-
Number of bending cycles	-	-
• Note	-	-
Number of torsion cycles with torsion by ± 180° on 1 m cable length	-	-
Traction stress maximum	150 N	150 N
Weight per length	103 kg/km	103 kg/km



### Technical specifications (continued)

Article No.	6XV1830-5FH10	6XV1830-5EH10
<b>Product-type designation</b>	<b>PROFIBUS FC Process Cable GP</b>	<b>PROFIBUS FC Process Cable GP</b>
<b>Permitted ambient conditions</b>		
Ambient temperature		
• during operating	-40 ... +80 °C	-40 ... +80 °C
• during storage	-40 ... +80 °C	-40 ... +80 °C
• during transport	-40 ... +80 °C	-40 ... +80 °C
• during installation	-20 ... +80 °C	-20 ... +80 °C
Ambient condition for (standard) operation mode	Transfer rate of cable: 31.25 Kbit/s	Transfer rate of cable: 31.25 Kbit/s
Protection class IP	-	-
Burning behaviour	flame resistant according to IEC 60332-3-24 (Category C)	flame resistant according to IEC 60332-3-24 (Category C)
Chemical resistance		
• to mineral oil	Conditional resistance	Conditional resistance
• to grease	Conditional resistance	Conditional resistance
• to water	Conditional resistance	Conditional resistance
Radiological resistance to UV radiation	Resistant	Resistant
<b>Product properties, functions, components general</b>		
Product feature		
• halogen-free	No	No
• silicon-free	Yes	Yes
<b>Standards, specifications, approvals</b>		
UL/ETL listing with 300 V rating	Yes: c(UL)us, CMG / CL3 / Sun Res	Yes: c(UL)us, CMG / CL3 / Sun Res
UL/ETL style with 600 V rating		
Verification of suitability		
• CE mark	Yes	Yes
• UL-registration	-	-
• RoHS conformity	Yes	Yes

### Ordering data

	Article No.
<b>PROFIBUS FC Process Cable</b>	
2-core, shielded	
• Blue for Ex applications	<b>6XV1830-5EH10</b>
• Black for non-Ex applications	<b>6XV1830-5FH10</b>
Sold by the meter: Max. quantity 1 000 m; minimum order 20 m	
<b>PROFIBUS FastConnect Stripping Tool</b>	<b>6GK1905-6AA00</b>
Stripping tool for fast stripping of the PROFIBUS FastConnect bus cable	
<b>PROFIBUS FastConnect Blade Cassettes</b>	<b>6GK1905-6AB00</b>
Spare blade cassettes for PROFIBUS FastConnect stripping tool, 5 units	
<b>SIMATIC NET Manual Collection</b>	<b>6GK1975-1AA00-3AA0</b>
Electronic manuals for communication systems, communication protocols, and communication products; on DVD; German/English	

### More information

#### Installation instruction

##### FastConnect

The FastConnect stripping tool can be used to strip the outer sheath and shield of the FC Process Cable to the required lengths for PROFIBUS PA.

Thus the use of the FastConnect stripping tool and SplitConnect tap permits the easy connection of field devices to, for example, the PROFIBUS PA bus system.

##### Cable routing

During storage, transport and cable laying, keep both ends sealed with a shrink-on cap.

Comply with the permissible bending radii and tensile load!

##### Note:

You can order components supplementary to the SIMATIC NET cabling range from your local contact.

Technical advice on this subject is available from:

J. Hertlein  
 I IA SC CI PRM 4  
 Phone: +49 (911) 750-4465  
 E-mail: [juergen.hertlein@siemens.com](mailto:juergen.hertlein@siemens.com)

## PROFIBUS

### Electrical networks (PROFIBUS PA)

#### Active field distributors

#### Overview

#### Active field distributor (AFD)

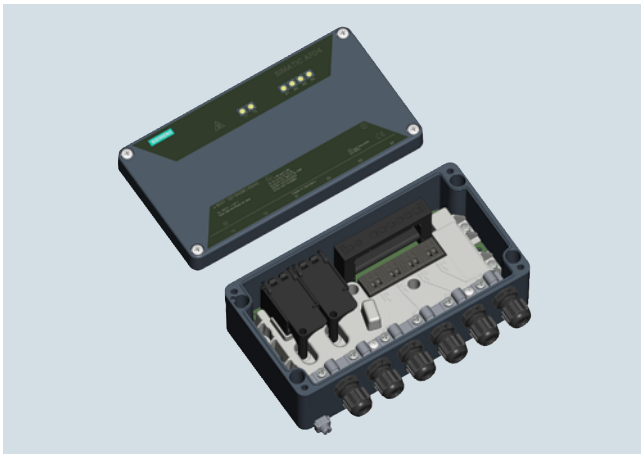

Active field distributor AFD4

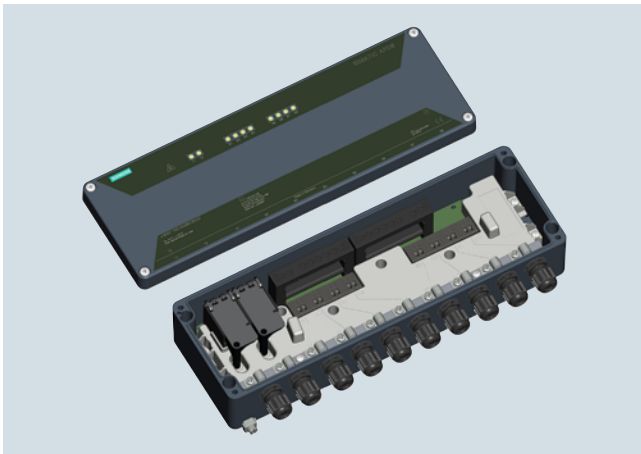

Active field distributor AFD8

Active field distributors (AFD) can be operated in environments in accordance with Ex zone 2/22. They are offered in two versions which differ as follows:

- AFD4 with 4 spur line connections for 1 field device each
- AFD8 with 8 spur line connections for 1 field device each

An AFD4 can therefore connect up to 4 field devices, and an AFD8 can connect up to 8 field devices, via short-circuit proof spur line connections to a fieldbus segment (line/ring) with automatic bus termination. This applies to both PA (PROFIBUS PA) as well as FF (FOUNDATION Fieldbus H1) field devices.

The fieldbus segment can be connected to a single or redundant PROFIBUS DP via a PA or FF router and can thus be seamlessly integrated into the SIMATIC PCS 7 process control system.

Up to 8 active field distributors AFD4/AFD8 with a total of up to 31 connected field devices can be operated per fieldbus segment. The number of field devices is also limited by the current consumption of the field devices. A maximum of 60 mA per spur line and a maximum of 1 A per segment is available for the field devices.

An AFD in a ring segment can be replaced during operation without failure of the segment.

For compliance with IP66 protection, it is necessary to protect unused spur line connections by plugs.

### Overview (continued)

#### Active field distributor AFDiS

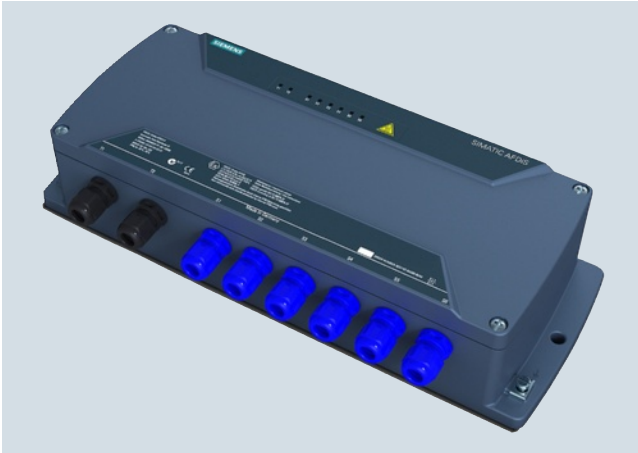

Active field distributor AFDiS

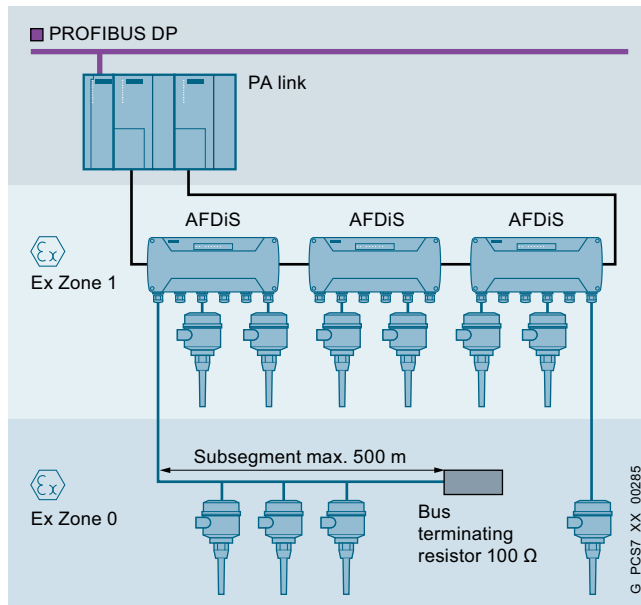

The active field distributor AFDiS (Active Field Distributor intrinsically Safe) can be operated in environments in accordance with Ex zone 1/21 and 2/22. It can integrate up to 6 intrinsically-safe PA or FF field devices into a fieldbus segment (line/ring) via its intrinsically-safe, short-circuit-proof spur line connections. Instead of the spur line, it is also possible to use a subsegment for 3 to 4 devices with a max. length of 500 m at connection S1 of the AFDiS. The spur lines with type of protection Ex [ia] as well as the subsegment can be routed into Zone 0/20.

Up to 5 field distributors AFDiS with a total of up to 31 field devices can be operated in a fieldbus segment. The limitation to 5 field distributors is also mandatory for mixed operation of AFD and AFDiS.

The number of field devices per segment additionally depends on the current consumption of the devices. A current of 1 A is available for all field devices of the segment.

With the integrated repeater function, the AFDiS has the following advantages compared to the AFD:

- Spur line lengths are independent of the total number of spur lines in the bus segment
- Spur line lengths need not be taken into account when determining the total length of the bus segment

Under the following conditions, an AFDiS in a ring segment can be replaced during operation without failure of the segment: Installation in Zone 2/22 or in a non-hazardous area.

For compliance with IP66 protection, it is necessary to protect unused spur line connections by plugs.

#### Active field splitter AFS

The active field splitter (AFS) connects a PA or FF line segment with a redundant coupler pair of a PA or FF router. The AFS interconnects the line segment with the respective active coupler.

The PA or FF line segment can be connected to the AFS via one or two (center feed) identical Y-connectors out of a total of 4. For the center feed, the line segment is connected via the two Y-connectors (bus termination switch on both FDC 157 couplers set to "OFF").

For compliance with IP66 protection, it is necessary to protect unused connections by plugs.

# PROFIBUS

## Electrical networks (PROFIBUS PA)

### Active field distributors

#### Technical specifications

Active field distributor (AFD)		Active field distributor (AFD)	
<b>General data</b>		<b>Connections, interfaces</b>	
Connection of field devices	<ul style="list-style-type: none"> <li>Standard-compliant field devices for PROFIBUS PA or FOUNDATION Fieldbus H1</li> <li>Max. 4 per AFD4</li> <li>Max. 8 per AFD8</li> <li>Max. 31 per fieldbus segment</li> <li>Operating environment up to Zone 2 oder 22; Class I Zone 2/ Division 2</li> <li>The max. current consumption of all fieldbus components of the fieldbus segment is 1 A</li> </ul>	<u>Main line</u>	
Degree of protection	IP66	Number of connections	2
<b>Voltages, currents, potentials</b>		Interfaces	PROFIBUS PA and FOUNDATION Fieldbus H1
Power supply	Via bus, no auxiliary power necessary	Automatic bus terminator	Yes
Rated supply voltage, permissible range	16 ... 32 V DC	<u>Spur cables</u>	
Reverse polarity protection (together with FDC 157)	Yes	Number of connections	
Oversvoltage protection	No	• AFD4	4
Current consumption		• AFD8	8
• Current consumption at idle	AFD4: 24 mA AFD8: 34 mA	Short-circuit-proof	Yes
• Current consumption with connected field devices	AFD4: 24 mA + total current of all field devices AFD8: 34 mA + total current of all field devices 30 mA	Intrinsically-safe acc. to FISCO	No
• Additional current consumption of the AFD at end of line (an open main line connection)		Current $I_{max}$ (DC) on spur lines 1 to 4 (AFD4) or 1 to 8 (AFD8)	60 mA
• Current consumption at max. power output per spur line	AFD4: 264 mA AFD8: 514 mA	Short-circuit current (test current)	6 mA
Power loss	AFD4: Min. 384 mW; max. 3.2 W AFD8: Min. 544 mW; max. 4.1 W	Debounce logic	Yes
Grounding	Direct, via grounding rail	No-load voltage	< 30 V
Electrical isolation between main line and spur lines	No	Current output to field devices	
		• AFD4	Max. 240 mA
		• AFD8	Max. 480 mA
		Status, interrupts, diagnostics	
		Status indicator	Yes
		Diagnostics function	Yes
		Diagnostics LED	Yes
		Interrupts	No
		Climatic conditions	
		Permissible operating temperature	-40 ... +70 °C
		Permissible storage/transport temperature	-40 ... +85 °C
		Relative humidity during operation	Max. 95 %
		Approvals for potentially explosive atmospheres	
		• Gas	Zone 2
		• Dust	Zone 22
		Dimensions and weight	
		Dimensions (W x H x D) in mm (without fittings)	
		• AFD4	220 x 120 x 83
		• AFD8	360 x 120 x 83
		Weight	
		• AFD4	2 000 g
		• AFD8	3 000 g

### Technical specifications (continued)

Active field distributor AFDiS		Active field distributor AFDiS	
<b>General data</b>		<b>Status, interrupts, diagnostics</b>	
Connection of field devices	<ul style="list-style-type: none"> <li>Standard-compliant field devices for PROFIBUS PA or FOUNDATION Fieldbus H1</li> <li>Max. 6 per AFDiS</li> <li>Max. 31 per fieldbus segment</li> <li>Operating environment up to Zone 1 oder 21; Class I Zone 1</li> <li>The max. current consumption of all fieldbus components of the fieldbus segment is 1 A</li> </ul>	Status indicator	Yes
Degree of protection	IP66	Diagnostics function	Yes
<b>Voltages, currents, potentials</b>		Diagnostics LED	Yes
Power supply	Via bus, no auxiliary power necessary	Interrupts	No
Rated supply voltage, permissible range	16 ... 32 V DC	<b>Climatic conditions</b>	
Reverse polarity protection (together with FDC 157)	Yes; up to 1 A	Permissible operating temperature	-40 ... +70 °C
Overvoltage protection	No	Permissible storage/transport temperature	-40 ... +85 °C
Current consumption		Relative humidity during operation	Max. 95 %
• At 28 V input voltage	≤ 64 mA + (0.838 x aggregate current of all field devices)	Approvals for potentially explosive atmospheres	
• At 24 V input voltage	≤ 67 mA + (1.008 x aggregate current of all field devices)	• Gas	Zone 1 and Zone 2
• At 20 V input voltage	≤ 74 mA + (1.246 x aggregate current of all field devices)	• Dust	Zone 21 and Zone 22
Power loss	Min. 1.4 W; max. 5.9 W	<b>Dimensions and weight</b>	
Grounding	Direct, via connecting bar	Dimensions (W x H x D) in mm	380 x 85 x 170
Electrical isolation between main line and spur lines	Yes	Weight	4 500 g
Test voltage	2550 V DC, 2 s		
Connections, interfaces			
<u>Main line</u>			
Number of connections	2		
Interfaces	PROFIBUS PA and FOUNDATION Fieldbus H1		
Automatic bus terminator	Yes		
<u>Spur cables</u>			
Number of connections	6		
Short-circuit-proof	Yes		
Intrinsically-safe acc. to FISCO	Yes		
Current $I_{max}$			
• on spur line S1	60 mA		
• on spur line S2 to S6	40 mA		
• in total for all field devices	180 mA		
Short-circuit current (test current)	5 mA		
Debounce logic	Yes		
No-load voltage	Max. 15.3 V		
Current output to field devices	Max. 260 mA		

# PROFIBUS

## Electrical networks (PROFIBUS PA)

### Active field distributors

#### Technical specifications (continued)

Active field splitter AFS	
<b>General data</b>	
Connection of field devices	<ul style="list-style-type: none"> <li>• 1 fieldbus segment with max. 31 field devices</li> <li>• Operating environment up to Zone 2 oder 22; Class I Zone 2/ Division 2</li> <li>• The max. current consumption of all fieldbus components of the fieldbus segment is 1 A</li> </ul>
Degree of protection	IP66
<b>Voltages, currents, potentials</b>	
Power supply	Via bus, no auxiliary power necessary
Rated supply voltage, permissible range	16 ... 32 V DC
Reverse polarity protection (together with FDC 157)	Yes
Overvoltage protection	No
Current consumption at idle	54 mA
Power loss	Min. 864 mW; max. 2.13 W
Output current for supplying all field devices of the fieldbus segment (for dimensioning the device configuration)	1 A
Grounding	Direct, via connecting bar
<b>Connections, interfaces</b>	
<u>Main lines to the FDC 157 couplers</u>	
Number of connections	2
Automatic bus terminator	No
Maximum permissible continuous main line current	1 A
<u>Y-connectors for fieldbus line segment</u>	
Number of connections	1 or 2 (with center feed)
Interfaces	PROFIBUS PA and FOUNDATION Fieldbus H1
Short-circuit proof (together with FDC 157)	Yes
Intrinsically-safe acc. to FISCO	No
Current $I_{max}$ on Y (limited by FDC 157)	1 A
Debounce logic	No
Continuous output voltage	Max. 32 V
Current output to field devices	Max. 1 A
<b>Status, interrupts, diagnostics</b>	
Status indicator	Yes
Diagnostics function	Yes
Diagnostics LED	Yes
Interrupts	No
<b>Climatic conditions</b>	
Permissible operating temperature	-40 ... +70 °C
Permissible storage/transport temperature	-40 ... +85 °C
Relative humidity during operation	Max. 95 %
Approvals for potentially explosive atmospheres	
• Gas	Zone 2
• Dust	Zone 22
<b>Dimensions and weight</b>	
Dimensions (W x H x D) in mm (without fittings)	220 x 120 x 83
Weight	2 000 g

#### Ordering data

#### Article No.

##### Active field distributor (AFD)

For integration of standard-compliant PA or FF field devices

- AFD4 with 4 short-circuit-proof spur line connections for 1 field device each
- AFD8 with 8 short-circuit-proof spur line connections for 1 field device each

**6ES7157-0AG81-0XA0**

**6ES7157-0AG82-0XA0**

##### Active Field Distributor AFDiS (Active Field Distributor intrinsically safe)

with 6 short-circuit-proof spur line connections for the integration of standard-compliant intrinsically-safe PA or FF field devices

**6ES7157-0AG83-0XA0**

##### Active field splitter (AFS)

for the interconnection of a bus line segment with the active coupler of a PA or FF router with redundant coupler pair

**6ES7157-0AG80-0XA0**

##### Accessories

##### Sealing plugs

for unused connections on AFS, AFD and AFDiS (10 units)

**6ES7157-0AG80-1XA1**

## Overview

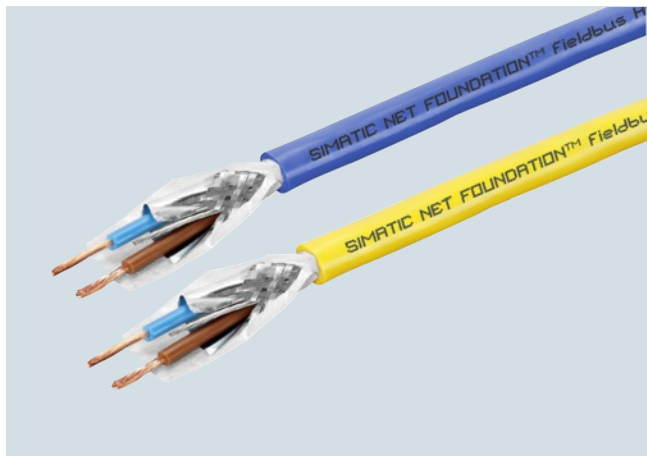

- Bus cable for fieldbus systems according to IEC 61158-2, e.g. FOUNDATION Fieldbus
- High noise immunity due to double shielding
- Different variants for different applications (hazardous, non-hazardous)

## Benefits



- Easy length measurement with printed meter markers
- Reduction in number of types and parts thanks to uniform connection system for FOUNDATION Fieldbus
- Cable design with shield wire for easy shield contact at the end device

## Application

For setting up fieldbus networks according to IEC 61158-2 (e.g. FOUNDATION Fieldbus), different color-coded cable types are available to suit different types of applications (hazardous, non-hazardous areas).

### UL approvals

Cable variants are available with appropriate UL approvals for laying in cable bundles and cable racks according to the specifications of NEC (National Electrical Code) Article 800/725.

## Design

- Shielded, twisted-pair cable with circular cross-section
- Integrated grounding concept can be achieved with the outer shield of the bus cable
- Printed meter marks.

### Cable types

- FOUNDATION Fieldbus cable:  
Special bus cable compliant with IEC 61158-2 for use in hazardous and non-hazardous areas.
- Bus segments with RS485 and IEC 61158-2 transmission procedures are linked by the segment SIMATIC FF Link.

**PROFIBUS****Electrical networks (FOUNDATION Fieldbus)****Bus cables****Technical specifications**

Article No.	6XV1830-5HH10	6XV1830-5GH10
Product-type designation	Foundation Fieldbus Cable	Foundation Fieldbus Cable
Product description	Bus cable (2-core), sold by the meter, in bulk	Bus cable (2-core), sold by the meter, in bulk
Acceptability for application	For use in fieldbus systems according to IEC 61158-2 (e.g. Foundation Fieldbus), suitable for non-Ex applications	For use in fieldbus systems according to IEC 61158-2 (e.g. Foundation Fieldbus), suitable for Ex applications
Cable designation	2X(ST)CY 1X2X1.1/2.85-100 LI GE FR OE	2X(ST)CY 1X2X1.1/2.85-100 LI GE FR OE
Cable length	-	-
<b>Electrical data</b>		
Damping ratio per length		
• at 9.6 kHz maximum	-	-
• at 38.4 kHz maximum	0.003 dB/m	0.003 dB/m
• at 4 MHz maximum	-	-
• at 16 MHz maximum	-	-
Impedance		
• Nominal value	100 Ω	100 Ω
• at 9.6 kHz	-	-
• at 38.4 kHz	100 Ω	100 Ω
• for frequency range 3 MHz ... 20 MHz	-	-
Relative symmetrical tolerance		
• of the surge impedance at 9.6 kHz	-	-
• of the surge impedance at 38.4 kHz	20 %	20 %
• of the surge impedance at 3 MHz ... 20 MHz	-	-
Loop resistance per length maximum	46 Ω/km	46 Ω/km
Shield resistance per length maximum	10 Ω/km	10 Ω/km
Capacity per length at 1 kHz	65 pF/m	65 pF/m
Operating voltage RMS value	300 V	300 V
<b>Mechanical data</b>		
Number of electrical wires	2	2
Design of shield	Overlapped aluminum-clad foil, sheathed in a braided shield of tin-plated copper wires with shield wire	Overlapped aluminum-clad foil, sheathed in a braided shield of tin-plated copper wires with shield wire
Design of the electrical connection FastConnect	No	No
Outer diameter		
• of the inner conductor	1.17 mm	1.17 mm
• of the wire insulation	2.85 mm	2.85 mm
• of the inner sheath of the cable	6.4 mm	6.4 mm
• of the cable sheath	8.5 mm	8.5 mm
Symmetrical tolerance of outer diameter of cable sheath	0.3 mm	0.3 mm
Outer diameter of the cable sheath Note	-	-
Material		
• of the wire insulation	PE	PE
• of the inner sheath of the cable	-	-
• of the cable sheath	PVC	PVC
- Note	-	-
Color		
• of the insulation of data wires	blue / brown	blue / brown
• of the cable sheath	Yellow	Blue
Bending radius		
• with single bend	34 mm	34 mm
• with multiple bends	68 mm	68 mm
• with continuous bending	-	-
Number of bending cycles	-	-
• Note	-	-
Number of torsion cycles with torsion by ± 180° on 1 m cable length	-	-
Traction stress maximum	100 N	100 N
Weight per length	98 kg/km	98 kg/km



### Technical specifications (continued)

Article No.	6XV1830-5HH10	6XV1830-5GH10
Product-type designation	Foundation Fieldbus Cable	Foundation Fieldbus Cable
<b>Permitted ambient conditions</b>		
Ambient temperature		
• during operating	-40 ... +105 °C	-40 ... +105 °C
• during storage	-40 ... +105 °C	-40 ... +105 °C
• during transport	-40 ... +105 °C	-40 ... +105 °C
• during installation	-40 ... +105 °C	-40 ... +105 °C
Ambient condition for (standard) operation mode	Transfer rate of cable: 31.25 Kbit/s	Transfer rate of cable: 31.25 Kbit/s
Protection class IP	-	-
Burning behaviour	flame resistant according to IEC 60332-1-2	flame resistant according to IEC 60332-1-2
Chemical resistance		
• to mineral oil	Conditional resistance	Conditional resistance
• to grease	Conditional resistance	Conditional resistance
• to water	Conditional resistance	Conditional resistance
Radiological resistance to UV radiation	Resistant	Resistant
<b>Product properties, functions, components general</b>		
Product feature		
• halogen-free	No	No
• silicon-free	Yes	Yes
Cable length		
• at max. 12 Mbit/s	-	-
• at max. 1.5 Mbit/s	-	-
<b>Standards, specifications, approvals</b>		
UL/ETL listing with 300 V rating	Yes: c(UL)us, CMG / PLTC / Sun Res	Yes: c(UL)us, CMG / PLTC / Sun Res
UL/ETL style with 600 V rating	No	No
Verification of suitability		
• CE mark	-	-
• UL-registration	-	-
• RoHS conformity	Yes	Yes
Marine classification association		
• Germanische Lloyd (GL)	No	No
• Lloyds Register of Shipping (LRS)	No	No

### Ordering data

#### FOUNDATION Fieldbus Cable

- 2-core, shielded
- Blue for Ex applications
- Orange for non-hazardous applications

Sold by the meter:  
Max. quantity 1 000 m,  
minimum order 20 m

### Article No.

**6XV1830-5GH10**  
**6XV1830-5HH10**

### More information

#### Cable routing

During storage, transport and cable laying, keep both ends sealed with a shrink-on cap.

Comply with the permissible bending radii and tensile load!

#### Note:

You can order components supplementary to the SIMATIC NET cabling range from your local contact.

Technical advice on this subject is available from:

J. Hertlein  
I IA SC CI PRM 4  
Phone: +49 (911) 750-4465  
E-mail: [juergen.hertlein@siemens.com](mailto:juergen.hertlein@siemens.com)

## PROFIBUS

### Optical networks with OLM

#### Overview of FC-FOCs

##### Overview

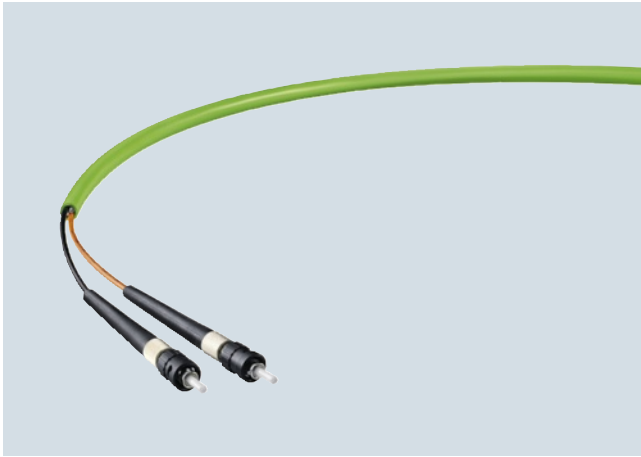

- Simple on-site assembly of glass FOC in the field
- Optical signal transmission
- No radiation emission from the cable
- Unaffected by external noise fields
- No grounding problems
- Electrical isolation
- Low weight
- Simple laying of cables

##### Design

Fiber-optic cables with glass core (62.5/200/230) are offered for the FastConnect fiber-optic cable system:

- FC glass fiber-optic cable; duplex cable for indoor and outdoor fiber-optic networks

The fiber structure corresponds to that of the PCF. This allows simple assembly on site.

Sheath material	Application
PVC	Standard use in indoor and outdoor areas of industrial applications
PUR	Highly mobile applications (tow chains) for high mechanical or chemical stress in harsh industrial environments
PE	Routing of cables in moist areas indoors and outdoors, and for direct burying in earth
FRNC	Standard applications with high fire protection requirements

##### Approvals

UL listing (safety standard) for network lines is especially necessary for the American and Canadian markets. The requirements for the appropriate approvals depend on where the cable is routed within the building. This applies to all cables which have to be routed from a machine to a remote control cabinet and are positioned on cable racks secured in the building. These cables are identified by the suffix "GP" (general purpose) in the product name and have the corresponding UL approvals.

### Application

The fiber-optic cable (FOC) is used for the transmission of signals in very extensive plants and where there are significant potential differences within a plant. The light beam is guided by total reflection at the transition from core to cladding which has a lower refractive index than the core.

The FastConnect fiber-optic (FC FO) system enables fast on-site assembly of glass fiber-optic cables with the right lengths to suit the respective application.

### Assembly with FastConnect for glass fiber-optic cables

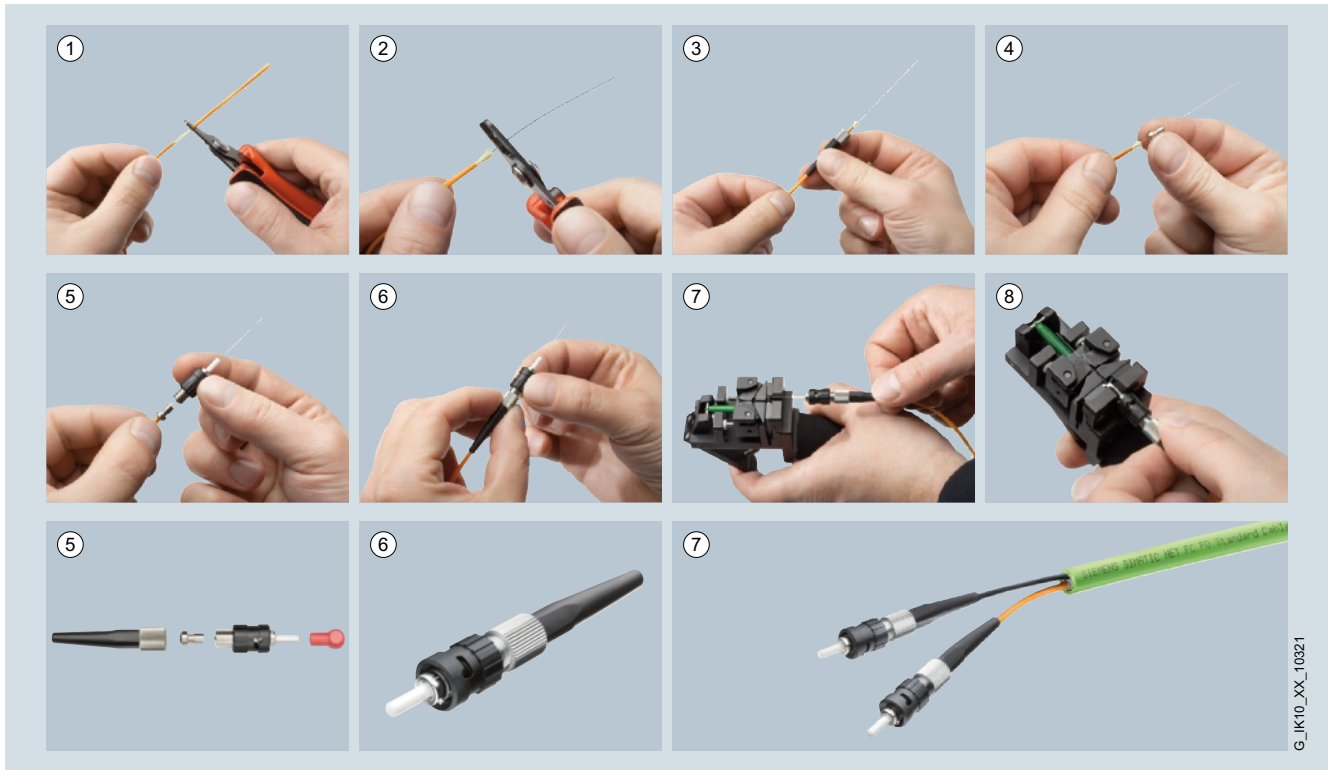

Steps for assembly of Industrial Ethernet fiber-optic cables with Industrial Ethernet FastConnect

## PROFIBUS

### Optical networks with OLM

#### FC glass fiber-optic cables

##### Overview



- FastConnect standard fiber-optic cable for use in optical Industrial Ethernet and PROFIBUS networks
- For all users who want to install and assemble the glass fiber-optic cables themselves over longer distances on site for office or industrial applications.
- Simple FastConnect SC/BFOC connector assembly on site
- Rugged construction for industrial applications both indoors and outdoors
- High interference immunity, as they are not sensitive to electromagnetic interference
- Extensive range of approvals (UL approvals)

##### Benefits



- Avoidance of excessive cable lengths in the control cabinet, as the fiber-optic cables can be assembled to the right length on site
- Easy installation of cables in buildings, as cables can be pulled in without connectors attached
- Simple extension of installed glass fiber-optic cables via SC and BFOC couplers
- Devices with different connection method (SC or BFOC) can easily be connected to one another using self-assembled adapter cables
- Electrical isolation of Industrial Ethernet/PROFINET/PROFIBUS devices
- Unaffected by electromagnetic interference
- Tap-proof: no radiation from cable

##### Application

SIMATIC NET FastConnect glass fiber-optic cables are used to construct optical indoor and outdoor Industrial Ethernet/PROFINET and PROFIBUS networks. Devices with integral optical interface (SC or BFOC connection technology) are, for example, optical link modules (OLM) and SCALANCE X Industrial Ethernet switches.

FastConnect glass fiber-optic cables are to be assembled on site using FastConnect SC or FastConnect BFOC connectors. A corresponding assembly kit (FC FO Termination Kit) is available for this purpose. The Termination Kit permits the stripping and the "cleaving" of the fiber in the assembled connector, as is familiar from PCF fiber-optic cables. To extend existing lines, a BFOC or SC coupler may be used depending on the connection technology.

##### Design

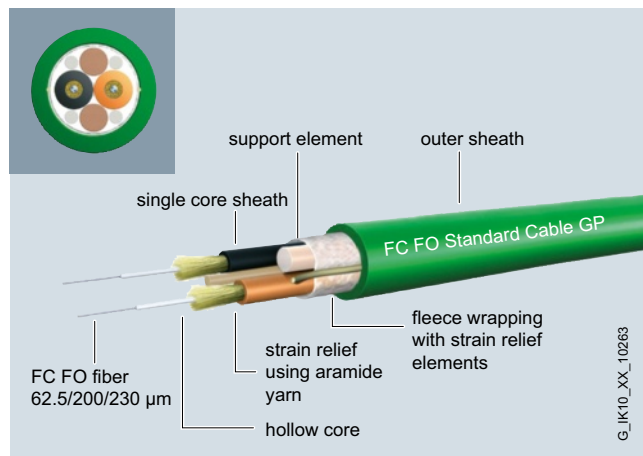

**FC FO Standard Cable GP (General Purpose);** rugged round cable with green outer sheath, Kevlar strain relief elements, and 62.5/200/230 FC FO fibers for indoor/outdoor applications

**FC FO Trailing Cable;** rugged round cable with green outer sheath, Kevlar strain relief elements and 62.5/200/230 FC FO fibers for use in tow chains and moving applications

Maximum cable length between two devices:

- 3 000 m for 100 Mbit/s Ethernet or for PROFIBUS
- 350 m for 1 000 Mbit/s Ethernet (1000Base-SX)
- 550 m for 1 000 Mbit/s Ethernet (1000Base-LX)

The maximum cable lengths can be assembled from partial lengths using FastConnect couplings (SC or BFOC; maximum two couplings, approx. 2.5 dB attenuation per coupling). It is also possible to combine existing installed, conventional 62.5/125 μm multimode glass fiber-optic cable sections with the FastConnect fiber-optic cables.

G\_JK10\_XX\_10263

**Technical specifications**

Article No.	6XV1847-2A	6XV1847-2C
Product-type designation	FC FO standard cable GP	FC FO trailing cable
Product description	Glass fiber-optic cable for assembly in the field, sold by the meter, unassembled	Flexible glass fiber-optic cable for assembly in the field, sold by the meter, unassembled
Acceptability for application	Cable for fixed routing in cable ducts and conduits, UL approval	Cable for high mechanical loading for use in trailing cables indoors and outdoors
Version of the assembled FO cable	Can be fitted with four BFOC or SC connectors	Can be fitted with four BFOC or SC connectors
Cable designation	AT-V(ZN)YY 2GK 62.5/200/230	AT-V(ZN)Y(ZN)11Y 2GK 62.5/200/230
Cable length	-	-
<b>Optical data</b>		
Damping ratio per length		
• at 850 nm maximum	3.2 dB/km	3.2 dB/km
• at 1300 nm maximum	0.9 dB/km	0.9 dB/km
• at 1550 nm maximum	-	-
Bandwidth length product		
• at 850 nm	200 GHz·m	200 GHz·m
• at 1300 nm	500 GHz·m	500 GHz·m
<b>Mechanical data</b>		
Number of fibers per FOC core	1	1
Number of FOC cores per FOC cable	2	2
Version of the FO conductor fiber	Multi-mode gradient fiber 62.5/200/230 μm	Multi-mode gradient fiber 62.5/200/230 μm
Design of the FOC core	Fixed core	Fixed core
Design of the fiber-optic cable	Segmentable cable	Segmentable cable
Outer diameter		
• of optical fibers	62.5 μm	62.5 μm
• of the optical fiber sheath	230 μm	230 μm
• of the FOC core sheath	2.2 mm	2.2 mm
• of the cable	7.2 mm	8.8 mm
Symmetrical deviation		
• of the outer diameter of the FOC core sheath	0.1 mm	0.1 mm
• of the outer diameter of the line	0.5 mm	0.5 mm
Width of the cable sheath	-	-
Symmetrical tolerance of width of cable sheath	-	-
Thickness of the cable sheath	-	-
Symmetrical tolerance of thickness of cable sheath	-	-
Material		
• of the fiber-optic cable core	Quartz glass	Quartz glass
• of the optical fiber sheath	ETFE	ETFE
• of the FOC core sheath	PVC	PVC
• of the fiber-optic cable sheath	PVC	PUR
• of the strain relief	Aramide fibers	Aramide fibers (double-ply)
Color		
• of the FOC core sheath	Orange/black	Orange/black
• of the cable sheath	green	green
Bending radius		
• with single bend minimum permissible	70 mm	88 mm
• with multiple bends minimum permissible	105 mm	88 mm
• with continuous bending	-	88 mm
Number of bending cycles	-	5 000 000
Number of torsion cycles in the case of torsion by ± 360° on 1 m cable length	-	-
Traction stress maximum	100 N	800 N
Short-term shear force per length	500 N/cm	500 N/cm
Continuous lateral force per length	300 N/cm	300 N/cm
Weight per length	49 kg/km	65 kg/km

**PROFIBUS**

## Optical networks with OLM

## FC glass fiber-optic cables

**Technical specifications** (continued)

Article No.	6XV1847-2A	6XV1847-2C
Product-type designation	FC FO standard cable GP	FC FO trailing cable
<b>Permitted ambient conditions</b>		
Ambient temperature		
• during operating	-40 ... +85 °C	-25 ... +75 °C
• during storage	-40 ... +85 °C	-30 ... +75 °C
• during transport	-40 ... +85 °C	-30 ... +75 °C
• during installation	-5 ... +50 °C	-5 ... +50 °C
Ambient condition for (standard) operation mode	-	-
Protection class IP	-	-
Burning behaviour	flame resistant according to IEC 60332-1-2 and IEC 60332-3-22 (Cat. A)	flame resistant according to IEC 60332-1-2
Chemical resistance		
• to mineral oil	Conditional resistance	resistant
• to grease	Conditional resistance	resistant
• to water	Conditional resistance	Conditional resistance
Radiological resistance to UV radiation	resistant	resistant
<b>Product properties, functions, components general</b>		
Product feature		
• halogen-free	No	No
• silicon-free	Yes	Yes
Product component Rodent protection	No	No
Cable length for glass FOC		
• for 100BaseFX for Industrial Ethernet maximum	3 000 m	3 000 m
• for 1000BaseSX for Industrial Ethernet maximum	350 m	350 m
• for 1000BaseLX for Industrial Ethernet maximum	550 m	550 m
• for PROFIBUS maximum	3 000 m	3 000 m
<b>Standards, specifications, approvals</b>		
Verification of suitability	UL approval: OFN (NEC Article 770, UL 1651) / CSA approval: OFN 90 Cel, FT1, FT4 (CSA Standard C22.2 No 232-M1988)	-
• RoHS conformity	Yes	Yes
Marine classification association		
• Bureau Veritas (BV)	-	-
• Germanische Lloyd (GL)	-	-
• Lloyds Register of Shipping (LRS)	-	-

**Technical specifications** (continued)

Article No.	6GK1900-1LB00-0AC0	6GK1900-1GB00-0AC0	6GK1900-1LP00-0AB0	6GK1900-1GP00-0AB0
Product-type designation	IE SC RJ PCF Plug PRO (Push Pull)	FC FO BFOC Plug	FC FO SC Coupler	FC FO BFOC Coupler
Product description	SC plug for FastConnect assembly	BFOC plug for FastConnect assembly	FC coupler for FastConnect assembly	BFOC coupler for FastConnect assembly
Acceptability for application	For connecting glass fiber-optic cables, suitable for fast assembly with the FastConnect FO system	For connecting glass fiber-optic cables, suitable for fast assembly with the FastConnect FO system	-	-
<b>Transmission rate</b>				
Transfer rate				
• 1 for Industrial Ethernet	10 Mbit/s	10 Mbit/s	10 Mbit/s	10 Mbit/s
• 2 for Industrial Ethernet	100 Mbit/s	100 Mbit/s	100 Mbit/s	100 Mbit/s
• 3 for Industrial Ethernet	1 000 Mbit/s	1 000 Mbit/s	1 000 Mbit/s	1 000 Mbit/s
• with PROFIBUS	9.6 kbit/s ... 12 Mbit/s	9.6 kbit/s ... 12 Mbit/s	9.6 kbit/s ... 12 Mbit/s	9.6 kbit/s ... 12 Mbit/s
<b>Interfaces</b>				
Number of optical interfaces for optical waveguide	1	1	1	1
Design of optical connections for network components or terminal devices	SC connector	BFOC connector	SC duplex coupling	BFOC coupling
Design of the electrical connection FastConnect	Yes	Yes	Yes	Yes
<b>Mechanical data</b>				
Material of the enclosure	Metal and plastic	Metal and plastic	Metal and plastic	Metal and plastic
<b>Design, dimensions and weight</b>				
Type of cable outlet	180 degree cable outlet	180 degree cable outlet	180 degree cable outlet	180 degree cable outlet
Width	8 mm	10 mm	9 mm	11 mm
Height	8 mm	10 mm	35 mm	11 mm
Depth	49 mm	22 mm	28 mm	29.5 mm
Net weight	11 g	9 g	18 g	9 g
<b>Permitted ambient conditions</b>				
Ambient temperature				
• during operating	-40 ... +85 °C	-40 ... +85 °C	-40 ... +85 °C	-40 ... +85 °C
• during storage	-40 ... +85 °C	-40 ... +85 °C	-40 ... +85 °C	-40 ... +85 °C
• during transport	-40 ... +85 °C	-40 ... +85 °C	-40 ... +85 °C	-40 ... +85 °C
Relative humidity at 25 °C without condensation during operating maximum	95 %	95 %	95 %	95 %
Protection class IP	IP20	IP20	IP20	IP20
Chemical resistance to water	-	-	-	-
<b>Product properties, functions, components general</b>				
Product feature silicon-free	Yes	Yes	Yes	Yes
Product component strain relief	Yes	Yes	Yes	Yes
<b>Standards, specifications, approvals</b>				
Verification of suitability RoHS conformity	Yes	Yes	Yes	Yes

**PROFIBUS**

## Optical networks with OLM

## FC glass fiber-optic cables

Ordering data	Article No.
<b>FC FO standard cable GP</b> 62.5/200/230 FC FO standard cable for fixed routing indoors with PVC sheath; sold by the meter max. length 1 000 m; minimum order 20 m	<b>6XV1847-2A</b>
<b>FC FO trailing cable</b> FC FO trailing cable for use in tow chains and moving applications; sold by the meter	<b>6XV1847-2C</b>
<b>FC FO termination kit</b> Assembly case for local assembly of FC SC and FC BFOC connectors to FC FO standard cable, comprising a stripping tool, Kevlar cutters, fiber breaking tool and microscope	<b>6GK1900-1GL00-0AA0</b>
<b>FC SC plug</b> Screw connector for on-site assembly on FC fiber-optic cable; (1 pack = 10 duplex plugs + cleaning cloths)	<b>6GK1900-1LB00-0AC0</b>
<b>FC BFOC plug</b> Screw connector for on-site assembly on FC fiber-optic cable; (1 pack = 20 units + cleaning cloths)	<b>6GK1900-1GB00-0AC0</b>
<b>FC SC coupler</b> FC SC duplex coupling; (1 pack = 5 units)	<b>6GK1900-1LP00-0AB0</b>
<b>FC BFOC coupler</b> FC BFOC coupling; (1 pack = 10 units)	<b>6GK1900-1GP00-0AB0</b>
<b>SIMATIC NET Manual Collection</b> Electronic manuals for communication systems, communication protocols, and communication products; on DVD; German/English	<b>6GK1975-1AA00-3AA0</b>

**More information**

You can order components supplementary to the SIMATIC NET cabling range from your local contact.

Technical advice on this subject is available from:

J. Hertlein  
 I IA SC CI PRM 4  
 Phone: +49 (911) 750-4465  
 E-mail: [juergen.hertlein@siemens.com](mailto:juergen.hertlein@siemens.com)



### Overview



- Compact, rugged assembly case for FastConnect glass fiber-optic cables
- Simple fitting of SC and BFOC connectors to FastConnect glass fiber-optic cables
- The quality of the assembly can be checked using the enclosed microscope

### Benefits



- Simple installation of the unassembled cable
- Flexible connector assembly possible on site (SC/BFOC connectors)
- Prevention of faults by simply checking the assembled connectors using a microscope
- Simple repair of FC glass fiber-optic cables in the field

### Application

SIMATIC NET FC glass fiber-optic cables are used to construct optical indoor and outdoor Industrial Ethernet/PROFINET and PROFIBUS networks. They are easy to assemble on-site using the termination kit with SC or BFOC connectors. The maximum cable length between two Industrial Ethernet/PROFINET or PROFIBUS devices is 3000 m in the case of 100 Mbit/s Ethernet or PROFIBUS.

### Design

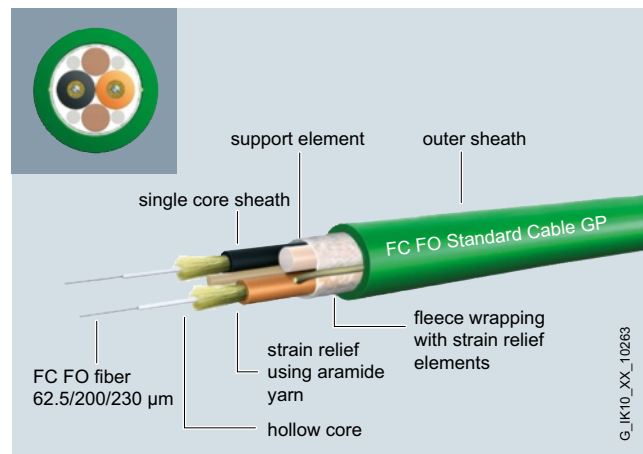

Cable construction FC glass optical fiber

The kit is available in an assembly case for on-site installation of FC SC and FC BFOC connectors on FC glass fiber-optic cables.

It consists of a stripping tool, buffer stripping tool, Kevlar scissors, fiber breaking tool and microscope.

### Ordering data

### Article No.

#### FC FO termination kit

Assembly case for local assembly of FC SC and FC BFOC connectors to FC FO standard cable, comprising a stripping tool, Kevlar cutters, fiber breaking tool and microscope

**6GK1900-1GL00-0AA0**

### More information

You can order components supplementary to the SIMATIC NET cabling range from your local contact.

Technical advice on this subject is available from:

J. Hertlein  
 I IA SC CI PRM 4  
 Phone: +49 (911) 750-4465  
 E-mail: [juergen.hertlein@siemens.com](mailto:juergen.hertlein@siemens.com)

## PROFIBUS

### Optical networks with OLM

#### Glass fiber-optic cable

##### Overview

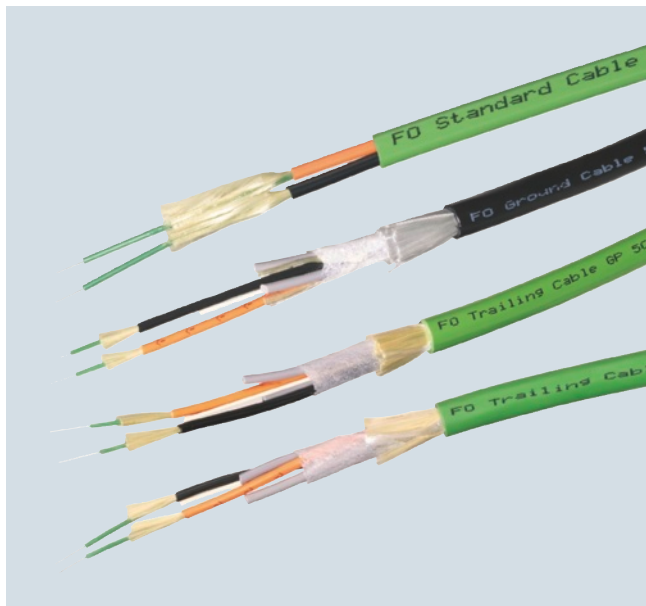

- Used for the optical Industrial Ethernet and PROFIBUS networks
- Rugged design for industrial applications indoors and outdoors
- Halogen-free design for installation inside buildings
- Trailing cable for the special application of forced motion control
- High immunity to noise thanks to insensitivity to electro-magnetic fields
- Available preassembled
- Extensive approvals (UL)

##### Benefits

**get** Designed for Industry

- Easy to lay with
  - preassembled cables
  - no grounding problems
  - very light fiber optic cable.
- Tap-proof, no radiation from the cable
- Silicon-free, therefore suitable for use in the automotive industry (e.g. in paintshops)
- Avoidance of overvoltage and equipotential bonding problems

##### Application

###### *Marine duplex fiber-optic cable SIENOPYR*

Halogen-free, non-crush, flame-retardant, marine-approved fiber-optic cable for permanent installation on ships and on off-shore platforms indoors and on open deck. Sold by the meter.

###### *Fiber-optic indoor cable*

Halogen-free fiber-optic cable, non-crush, flame-retardant, for installation inside buildings (e.g. in production halls and in building automation). Supplied in fixed lengths, pre-assembled with 4 BFOC connectors.

###### *Standard FOC/FRNC cable*

Fiber-optic cables for the following application areas indoors and outdoors

- For routing above ground
- For installation inside buildings.

Sold by the meter and in fixed lengths, pre-assembled with 4 BFOC connectors.

###### *Fiber-optic trailing cable*

Fiber-optic cables for the special application of forced motion control, such as in continuously moving machine parts (in trailing cables) indoors and outdoors. Two cable variants are available for this application:

- FO Trailing Cable; Cable for high mechanical stress, PUR outer sheath, no UL approval
- FO Trailing Cable GP (general purpose); Cable for low mechanical stress, PVC outer sheath, with UL approval

Sold by the meter and in fixed lengths, pre-assembled with 4 BFOC connectors.

###### *Fiber-optic outdoor cable*

Waterproof cable (lengthwise and sideways) for use outdoors with non-metallic protection against rodents for laying into the ground.

Sold by the meter and in fixed lengths, pre-assembled with 4 BFOC connectors.

###### Note:

Special tools and specially trained personnel are required for pre-assembling glass fiber-optic cables

**Application** (continued)

*Application Examples*

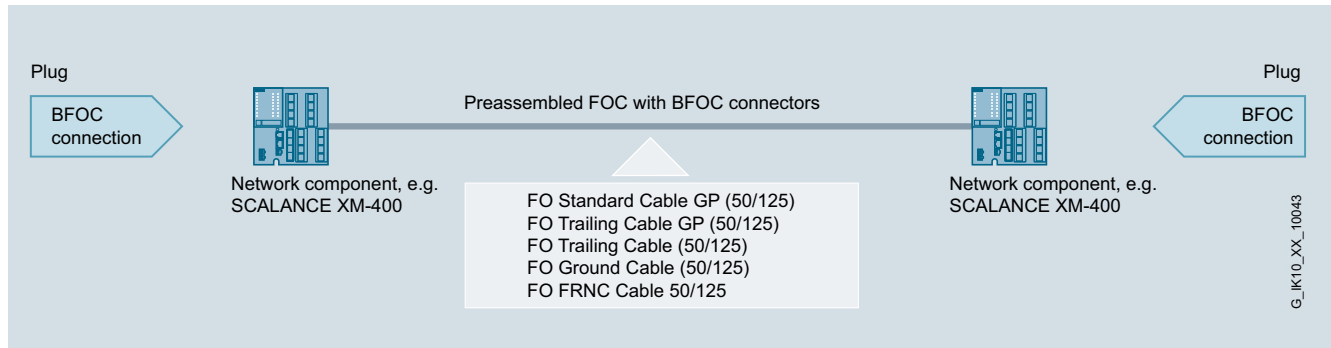

Use of pre-assembled fiber-optic cables with BFOC connectors (12 Mbit/s)

**Design**

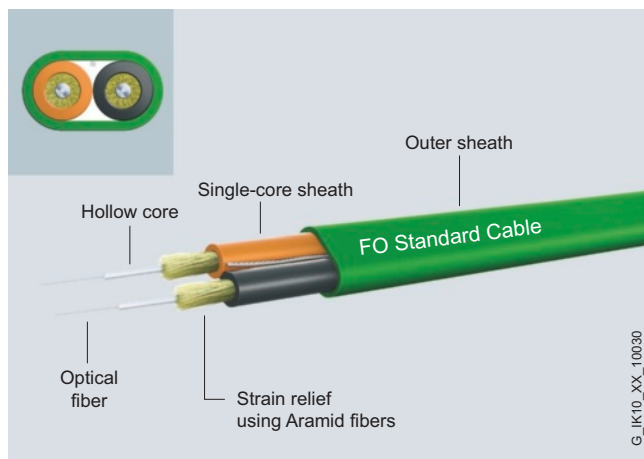

In order to span very long distances, the use of singlemode cables with a 9 μm fiber is recommended.

Cable types	50/125 μm	62.5/125 μm	9/125 μm
FO standard cable GP (50/125/1 400)	●	—	—
FO FRNC cable (50/125/1 400)	●	—	—
FO trailing cable (50/125/1 400)	●	—	—
FO trailing cable GP (50/125/1 400)	●	—	—
FO ground cable (50/125/1 400)	●	—	—
FO robust cable GP (50/125/900)	●	—	—
Fiber-optic standard cable (62.5/125/900)	—	●	—
INDOOR fiber-optic cable (62.5/125/900)	—	●	—
Flexible fiber-optic trailing cable (62.5/125/1400)	—	●	—
SIENOPYR marine duplex fiber-optic cable (62.5/125/900)	—	●	—
FO robust cable GP (4E9/125/900)	—	—	●

**PROFIBUS**

## Optical networks with OLM

## Glass fiber-optic cable

**Technical specifications**

Article No.	6XV1873-2A	6XV1873-2B	6XV1873-2G
Product-type designation	FO Standard Cable GP	FO FRNC Cable GP	FO Ground Cable
Product description	Glass fiber-optic cable, sold by the meter, unassembled	Glass fiber-optic cable, sold by the meter, unassembled	Glass fiber-optic cable, sold by the meter, unassembled
Acceptability for application	Cable for indoor and outdoor use, UL approval	Halogen-free cable for indoor and outdoor use, for fixed installation, UL approval	Cable with longitudinal and lateral water tightness with non-metallic protection against rodents for outdoor use and for direct laying in soil
Version of the assembled FO cable	Can be fitted with four BFOC or SC connectors	Can be fitted with four BFOC or SC connectors	Can be fitted with four BFOC or SC connectors
Cable designation	AT-W(ZN)YY 2x1 G 50/125	AT-W(ZN)HH 2G 50/125 UV	AT-WQ(ZN)Y(ZN)B2Y 2G 50/125
Cable length	-	-	-
<b>Optical data</b>			
Damping ratio per length			
• at 850 nm maximum	2.7 dB/km	2.7 dB/km	2.7 dB/km
• at 1300 nm maximum	0.7 dB/km	0.7 dB/km	0.7 dB/km
• at 1550 nm maximum	-	-	-
Bandwidth length product			
• at 850 nm	600 GHz·m	600 GHz·m	600 GHz·m
• at 1300 nm	1 200 GHz·m	1 200 GHz·m	1 200 GHz·m
<b>Mechanical data</b>			
Number of fibers per FOC core	1	1	1
Number of FOC cores per FOC cable	2	2	2
Version of the FO conductor fiber	Multi-mode gradient fiber 50/125 µm, OM 2	Multi-mode gradient fiber 50/125 µm, OM 2	Multi-mode gradient fiber 50/125 µm, OM 2
Design of the FOC core	Hollow core, filled, diameter 1 400 µm	Hollow core, filled, diameter 1 400 µm	Hollow core, filled, diameter 1 400 µm
Design of the fiber-optic cable	Segmentable	Segmentable	Segmentable
Outer diameter			
• of optical fibers	50 µm	50 µm	50 µm
• of the optical fiber sheath	125 µm	125 µm	125 µm
• of the FOC core sheath	2.9 mm	2.9 mm	2.9 mm
• of the cable	-	9.2 mm	10.5 mm
Symmetrical deviation			
• of the outer diameter of the FOC core sheath	0.1 mm	0.1 mm	0.1 mm
• of the outer diameter of the line	-	0.3 mm	0.5 mm
Width of the cable sheath	7.4 mm	-	-
Thickness of the cable sheath	4.5 mm	-	-
Material			
• of the fiber-optic cable core	Quartz glass	Quartz glass	Quartz glass
• of the optical fiber sheath	Quartz glass	Quartz glass	Quartz glass
• of the FOC core sheath	PVC	FRNC	PVC
• of the fiber-optic cable sheath	PVC	FRNC	PE
• of the strain relief	Aramide fibers	Aramide fibers	Aramide fibers
Color			
• of the FOC core sheath	Orange/black	Orange/black	Orange/black
• of the cable sheath	green	green	Black
Bending radius			
• with single bend minimum permissible	45 mm	90 mm	105 mm
• with multiple bends minimum permissible	65 mm	135 mm	155 mm
• with continuous bending	-	-	-
Number of bending cycles	-	-	-
Number of torsion cycles in the case of torsion by ± 360° on 1 m cable length	-	-	-
Traction stress maximum	500 N	500 N	800 N
Short-term shear force per length	600 N/cm	500 N/cm	500 N/cm
Continuous lateral force per length	400 N/cm	-	300 N/cm
Weight per length	40 kg/km	85 kg/km	90 kg/km

**Technical specifications** (continued)

Article No.	6XV1873-2A	6XV1873-2B	6XV1873-2G
Product-type designation	FO Standard Cable GP	FO FRNC Cable GP	FO Ground Cable
<b>Permitted ambient conditions</b>			
Ambient temperature			
• during operating	-25 ... +80 °C	-40 ... +85 °C	-40 ... +85 °C
• during storage	-25 ... +80 °C	-40 ... +85 °C	-40 ... +85 °C
• during transport	-25 ... +80 °C	-40 ... +85 °C	-40 ... +85 °C
• during installation	-5 ... +50 °C	-5 ... +50 °C	-5 ... +50 °C
Ambient condition for (standard) operation mode	-	-	-
Protection class IP	-	-	-
Burning behaviour	flame resistant according to IEC 60332-1-2 and IEC 60332-3-22 (Cat. A)	flame resistant according to IEC 60332-1-2 and IEC 60332-3-22 (Cat. A)	flammable
Chemical resistance			
• to mineral oil	Conditional resistance	Conditional resistance	resistant
• to grease	Conditional resistance	Conditional resistance	resistant
• to water	Conditional resistance	Conditional resistance	resistant
Radiological resistance to UV radiation	resistant	resistant	resistant
<b>Product properties, functions, components general</b>			
Product feature			
• halogen-free	No	Yes	No
• silicon-free	Yes	Yes	Yes
Product component Rodent protection	No	No	Yes
Cable length for glass FOC			
• for 100BaseFX for Industrial Ethernet maximum	5 000 m	5 000 m	5 000 m
• for 1000BaseSX for Industrial Ethernet maximum	750 m	750 m	750 m
• for 1000BaseLX for Industrial Ethernet maximum	2 000 m	2 000 m	2 000 m
• for PROFIBUS maximum	3 000 m	3 000 m	3 000 m
<b>Standards, specifications, approvals</b>			
Verification of suitability	UL approval: OFN (NEC Article 770, UL 1651) / CSA approval: OFN 90 Cel, FT1, FT4 (CSA standard C22.2 No 232-M1988)	UL approval: OFN (NEC Article 770, UL 1651) / CSA approval: OFN (CSA standard C22.2 No 232-M1988)	-
• RoHS conformity	Yes	Yes	Yes
Marine classification association			
• Bureau Veritas (BV)	-	-	-
• Germanische Lloyd (GL)	-	-	-
• Lloyds Register of Shipping (LRS)	-	-	-

**PROFIBUS****Optical networks with OLM****Glass fiber-optic cable****Technical specifications (continued)**

<b>Article No.</b>	<b>6XV1873-2C</b>	<b>6XV1873-2D</b>
<b>Product-type designation</b>	<b>FO Trailing Cable</b>	<b>FO Trailing Cable GP</b>
Product description	Glass fiber-optic cable, sold by the meter, unassembled	Glass fiber-optic cable, sold by the meter, unassembled
Acceptability for application	Flexible cable for use in trailing cables with high mechanical stress, without UL approval	Flexible cable for use in trailing cables with high mechanical stress, UL approval
Version of the assembled FO cable	Can be fitted with four BFOC or SC connectors	Can be fitted with four BFOC or SC connectors
Cable designation	AT-W(ZN)Y(ZN)11Y 2G 50/125	AT-W(ZN)Y(ZN)Y 2G 50/125
Cable length	-	-
<b>Optical data</b>		
Damping ratio per length		
• at 850 nm maximum	2.7 dB/km	2.7 dB/km
• at 1300 nm maximum	0.7 dB/km	0.7 dB/km
• at 1550 nm maximum	-	-
Bandwidth length product		
• at 850 nm	600 GHz·m	600 GHz·m
• at 1300 nm	1 200 GHz·m	1 200 GHz·m
<b>Mechanical data</b>		
Number of fibers per FOC core	1	1
Number of FOC cores per FOC cable	2	2
Version of the FO conductor fiber	Multi-mode gradient fiber 50/125 µm, OM 2	Multi-mode gradient fiber 50/125 µm, OM 2
Design of the FOC core	Hollow core, filled, diameter 1 400 µm	Hollow core, filled, diameter 1 400 µm
Design of the fiber-optic cable	Segmentable	Segmentable
Outer diameter		
• of optical fibers	50 µm	50 µm
• of the optical fiber sheath	125 µm	125 µm
• of the FOC core sheath	2.9 mm	2.9 mm
• of the cable	10.5 mm	10.5 mm
Symmetrical deviation		
• of the outer diameter of the FOC core sheath	0.1 mm	0.1 mm
• of the outer diameter of the line	0.5 mm	0.5 mm
Material		
• of the fiber-optic cable core	Quartz glass	Quartz glass
• of the optical fiber sheath	Quartz glass	Quartz glass
• of the FOC core sheath	PVC	PVC
• of the fiber-optic cable sheath	PUR	PVC
• of the strain relief	Aramide fibers	Aramide fibers
Color		
• of the FOC core sheath	Orange/black	Orange/black
• of the cable sheath	green	green
Bending radius		
• with single bend minimum permissible	150 mm	150 mm
• with multiple bends minimum permissible	200 mm	200 mm
• with continuous bending	-	-
Number of bending cycles	5 000 000	3 500 000
Number of torsion cycles in the case of torsion by ± 360° on 1 m cable length	-	-
Traction stress maximum	800 N	800 N
Short-term shear force per length	700 N/cm	700 N/cm
Continuous lateral force per length	400 N/cm	400 N/cm
Weight per length	90 kg/km	90 kg/km

**Technical specifications** (continued)

Article No.	6XV1873-2C	6XV1873-2D
Product-type designation	FO Trailing Cable	FO Trailing Cable GP
<b>Permitted ambient conditions</b>		
Ambient temperature		
• during operating	-40 ... +80 °C	-25 ... +80 °C
• during storage	-40 ... +80 °C	-25 ... +80 °C
• during transport	-40 ... +80 °C	-25 ... +80 °C
• during installation	-5 ... +50 °C	-5 ... +50 °C
Ambient condition for (standard) operation mode	-	-
Protection class IP	-	-
Burning behaviour	flammable	flame resistant according to IEC 60332-1-2 and IEC 60332-3-22 (Cat. A)
Chemical resistance		
• to mineral oil	resistant	Conditional resistance
• to grease	resistant	Conditional resistance
• to water	Conditional resistance	Conditional resistance
Radiological resistance to UV radiation	resistant	resistant
<b>Product properties, functions, components general</b>		
Product feature		
• halogen-free	No	No
• silicon-free	Yes	Yes
Product component Rodent protection	No	No
Cable length for glass FOC		
• for 100BaseFX for Industrial Ethernet maximum	5 000 m	5 000 m
• for 1000BaseSX for Industrial Ethernet maximum	750 m	750 m
• for 1000BaseLX for Industrial Ethernet maximum	2 000 m	2 000 m
• for PROFIBUS maximum	3 000 m	3 000 m
<b>Standards, specifications, approvals</b>		
Verification of suitability	-	UL approval: OFN (NEC Article 770, UL 1651) / CSA approval: OFN 90 °C, FT1, FT4 (CSA standard C22.2 No. 232-M1988)
• RoHS conformity	Yes	Yes
Marine classification association		
• Bureau Veritas (BV)	-	-
• Germanische Lloyd (GL)	-	-
• Lloyds Register of Shipping (LRS)	-	-

**PROFIBUS**

## Optical networks with OLM

## Glass fiber-optic cable

**Technical specifications** (continued)

Article No.	6XV1820-5AH10	6XV1820-7AH10
Product-type designation	Fiber optic standard cable	INDOOR fiber optic indoor cable
Product description	Flexible glass fiber-optic cable, sold by the meter, unassembled	Glass fiber-optic cable, sold by the meter, unassembled
Acceptability for application	Cable for indoor and outdoor use	Crush-resistant, halogen-free and flame-retardant cable for indoor use
Version of the assembled FO cable	can be fitted with four BFOC connectors	can be fitted with four BFOC connectors
Cable designation	AT-V(ZN)YY 2X1 G 62.5/125	I-V(ZN)HH 2x1 G 62.5/125
Cable length	-	-
<b>Optical data</b>		
Damping ratio per length		
• at 850 nm maximum	3.1 dB/km	3.1 dB/km
• at 1300 nm maximum	0.8 dB/km	0.8 dB/km
• at 1550 nm maximum	-	-
Bandwidth length product		
• at 850 nm	200 GHz·m	200 GHz·m
• at 1300 nm	600 GHz·m	600 GHz·m
<b>Mechanical data</b>		
Number of fibers per FOC core	1	1
Number of FOC cores per FOC cable	2	2
Version of the FO conductor fiber	Multimode graded-index fiber 62.5/125 µm, OM 2	Multimode graded-index fiber 62.5/125 µm, OM 2
Design of the FOC core	Compact core, diameter 900 µm	Solid core, diameter 900 µm
Design of the fiber-optic cable	Segmentable outer conductor	Segmentable inner conductor
Outer diameter		
• of optical fibers	62.5 µm	62.5 µm
• of the optical fiber sheath	125 µm	125 µm
• of the FOC core sheath	3.5 mm	2.9 mm
• of the cable	-	-
Symmetrical deviation		
• of the outer diameter of the FOC core sheath	-	0.1 mm
• of the outer diameter of the line	-	-
Width of the cable sheath	9.8 mm	6.8 mm
Thickness of the cable sheath	6.3 mm	3.9 mm
Material		
• of the fiber-optic cable core	Quartz glass	Quartz glass
• of the optical fiber sheath	Quartz glass	Quartz glass
• of the FOC core sheath	PVC	FRNC
• of the fiber-optic cable sheath	PVC	FRNC
• of the strain relief	Aramide fibers and glass roving	Aramide fibers
Color		
• of the FOC core sheath	Gray	Gray
• of the cable sheath	Black	Orange
Bending radius		
• with single bend minimum permissible	80 mm	30 mm
• with multiple bends minimum permissible	80 mm	50 mm
• with continuous bending	-	-
Number of bending cycles	-	-
Number of torsion cycles in the case of torsion by ± 360° on 1 m cable length	-	-
Traction stress maximum	1 500 N	200 N
Short-term shear force per length	-	300 N/cm
Continuous lateral force per length	200 N/cm	100 N/cm
Weight per length	70 kg/km	30 kg/km



**Technical specifications** (continued)

Article No.	6XV1820-5AH10	6XV1820-7AH10
Product-type designation	Fiber optic standard cable	INDOOR fiber optic indoor cable
<b>Permitted ambient conditions</b>		
Ambient temperature		
• during operating	-40 ... +85 °C	-20 ... +60 °C
• during storage	-40 ... +85 °C	-25 ... +70 °C
• during transport	-40 ... +85 °C	-25 ... +70 °C
• during installation	-5 ... +50 °C	-5 ... +50 °C
Ambient condition for (standard) operation mode	-	-
Protection class IP	-	-
Burning behaviour	flame resistant according to IEC 60332-1-2 and IEC 60332-3-22 (Cat. A)	flame resistant according to IEC 60332-1-2 and IEC 60332-3-22 (Cat. A)
Chemical resistance		
• to mineral oil	not resistant	not resistant
• to grease	not resistant	not resistant
• to water	Conditional resistance	Conditional resistance
Radiological resistance to UV radiation	resistant	not resistant
<b>Product properties, functions, components general</b>		
Product feature		
• halogen-free	No	Yes
• silicon-free	Yes	Yes
Product component Rodent protection	No	No
Cable length for glass FOC		
• for 100BaseFX for Industrial Ethernet maximum	4 000 m	4 000 m
• for 1000BaseSX for Industrial Ethernet maximum	350 m	350 m
• for 1000BaseLX for Industrial Ethernet maximum	550 m	550 m
• for PROFIBUS maximum	3 000 m	3 000 m
<b>Standards, specifications, approvals</b>		
Verification of suitability	-	-
• RoHS conformity	Yes	Yes
Marine classification association		
• Bureau Veritas (BV)	-	-
• Germanische Lloyd (GL)	-	-
• Lloyds Register of Shipping (LRS)	-	-

**PROFIBUS**

## Optical networks with OLM

## Glass fiber-optic cable

**Technical specifications** (continued)

Article No.	6XV1820-6AH10	6XV1830-0NH10
Product-type designation	Flexible fiber optic trailing cable	SIENOPYR marine duplex fiber-optic cable
Product description	Flexible glass fiber-optic cable, sold by the meter, unassembled	Glass fiber-optic cable SIENOPYR marine cable, sold by the meter, unassembled
Acceptability for application	Flexible cable for indoor and outdoor use in trailing cables	For fixed installation on ships and offshore units, in all rooms and exposed decks, marine approval assigned
Version of the assembled FO cable	can be fitted with four BFOC connectors	can be fitted with four BFOC connectors
Cable designation	AT-W11Y(ZN)11Y 2 G 62.5/125	MI-VHH 2G 62.5/125 3.1B200 + 0.8F600 + 2x1Cu 300V
Cable length	-	-
<b>Optical data</b>		
Damping ratio per length		
• at 850 nm maximum	3.1 dB/km	3.1 dB/km
• at 1300 nm maximum	0.8 dB/km	0.8 dB/km
• at 1550 nm maximum	-	-
Bandwidth length product		
• at 850 nm	200 GHz·m	200 GHz·m
• at 1300 nm	600 GHz·m	600 GHz·m
<b>Mechanical data</b>		
Number of fibers per FOC core	1	1
Number of FOC cores per FOC cable	2	2
Version of the FO conductor fiber	Multi-mode gradient fiber 62.5/125 µm, OM 2	Multi-mode gradient fiber 62.5/125 µm, OM 2
Design of the FOC core	Hollow core, filled, diameter 1 400 µm	Solid core
Design of the fiber-optic cable	Segmentable outer conductor	Segmentable outer conductor
Outer diameter		
• of optical fibers	62.5 µm	62.5 µm
• of the optical fiber sheath	125 µm	125 µm
• of the FOC core sheath	3.5 mm	2.9 mm
• of the cable	12.9 mm	13.3 mm
Symmetrical deviation		
• of the outer diameter of the FOC core sheath	-	-
• of the outer diameter of the line	-	0.5 mm
Material		
• of the fiber-optic cable core	Quartz glass	Mineral glass
• of the optical fiber sheath	Quartz glass	-
• of the FOC core sheath	PUR	Polyolefine
• of the fiber-optic cable sheath	PUR	SHF1 mixture
• of the strain relief	Aramide fibers, plus central element made of glassreinforced plastic	Aramide fibers
Color		
• of the FOC core sheath	Black	-
• of the cable sheath	Black	Black
Bending radius		
• with single bend minimum permissible	150 mm	133 mm
• with multiple bends minimum permissible	150 mm	266 mm
• with continuous bending	-	-
Number of bending cycles	100 000	-
Number of torsion cycles in the case of torsion by ± 360° on 1 m cable length	-	-
Traction stress maximum	1 000 N	250 N
Short-term shear force per length	-	-
Continuous lateral force per length	-	-
Weight per length	130 kg/km	220 kg/km

**Technical specifications** (continued)

Article No.	6XV1820-6AH10	6XV1830-0NH10
Product-type designation	Flexible fiber optic trailing cable	SIENOPYR marine duplex fiber-optic cable
<b>Permitted ambient conditions</b>		
Ambient temperature		
• during operating	-30 ... +60 °C	-40 ... +80 °C
• during storage	-30 ... +70 °C	-40 ... +80 °C
• during transport	-30 ... +70 °C	-40 ... +80 °C
• during installation	-30 ... +60 °C	-10 ... +50 °C
Ambient condition for (standard) operation mode	-	At ambient temperatures below -10 degrees Celsius, the cable must not be subjected to any movements other than the normal vibration levels encountered on board ship
Protection class IP	-	-
Burning behaviour	flammable	flame resistant according to IEC 60332-3 (Cat. A)
Chemical resistance		
• to mineral oil	resistant	-
• to grease	resistant	-
• to water	Conditional resistance	Conditional resistance
Radiological resistance to UV radiation	resistant	resistant
<b>Product properties, functions, components general</b>		
Product feature		
• halogen-free	Yes	Yes
• silicon-free	Yes	Yes
Product component Rodent protection	No	No
Cable length for glass FOC		
• for 100BaseFX for Industrial Ethernet maximum	4 000 m	4 000 m
• for 1000BaseSX for Industrial Ethernet maximum	350 m	350 m
• for 1000BaseLX for Industrial Ethernet maximum	550 m	550 m
• for PROFIBUS maximum	3 000 m	3 000 m
<b>Standards, specifications, approvals</b>		
Verification of suitability	-	-
• RoHS conformity	Yes	Yes
Marine classification association		
• Bureau Veritas (BV)	-	Yes
• Germanische Lloyd (GL)	-	Yes
• Lloyds Register of Shipping (LRS)	-	Yes

**PROFIBUS****Optical networks with OLM****Glass fiber-optic cable****Technical specifications (continued)**

<b>Article No.</b>	<b>6XV1873-2R</b>	<b>6XV1843-2R</b>
<b>Product-type designation</b>	<b>MM FO Robust Cable GP</b>	<b>SM FO robust cable GP</b>
Product description	Glass fiber-optic cable, sold by the meter, unassembled	Glass fiber-optic cable, sold by the meter, unassembled
Acceptability for application	Cable with longitudinal and lateral water tightness with non-metallic protection against rodents for outdoor and indoor use and for direct laying in soil	Cable with longitudinal and lateral water tightness with non-metallic protection against rodents for outdoor and indoor use and for direct laying in soil
Version of the assembled FO cable	Can be fitted with two BFOC, SC and LC duplex plugs	Can be fitted with two BFOC, SC and LC duplex plugs
Cable designation	AT-V(ZN)H(ZN)BH 2G50/125	AT-V(ZN)H(ZN)BH 4E9/125
Cable length	-	-
<b>Optical data</b>		
Damping ratio per length		
• at 850 nm maximum	2.7 dB/km	-
• at 1300 nm maximum	1 dB/km	0.5 dB/km
• at 1550 nm maximum	-	0.5 dB/km
Bandwidth length product		
• at 850 nm	600 GHz·m	-
• at 1300 nm	1 200 GHz·m	-
<b>Mechanical data</b>		
Number of fibers per FOC core	1	1
Number of FOC cores per FOC cable	2	4
Version of the FO conductor fiber	Multi-mode gradient fiber 50/125/245 µm, OM2	Single mode fiber 4E9/125/900, OS1 and OS2
Design of the FOC core	Solid core, diameter 900 µm	Solid core, diameter 900 µm
Design of the fiber-optic cable	Segmentable	Segmentable
Outer diameter		
• of optical fibers	50 µm	9 µm
• of the optical fiber sheath	125 µm	125 µm
• of the FOC core sheath	2.2 mm	2.2 mm
• of the cable	7.5 mm	9 mm
Symmetrical deviation		
• of the outer diameter of the FOC core sheath	-	-
• of the outer diameter of the line	-	-
Material		
• of the fiber-optic cable core	Quartz glass	Quartz glass
• of the optical fiber sheath	Quartz glass	Quartz glass
• of the FOC core sheath	PE flame retardant	PE flame retardant
• of the fiber-optic cable sheath	PE flame retardant	PE flame retardant
• of the strain relief	Aramide fibers and glass roving	Aramide fibers, plus central support element and glass roving
Color		
• of the FOC core sheath	Orange / black, with directional arrow	Orange / black, with directional arrow (numbering of the core pairs with 1 and 2)
• of the cable sheath	Black	Black
Bending radius		
• with single bend minimum permissible	25 mm	90 mm
• with multiple bends minimum permissible	40 mm	135 mm
• with continuous bending	-	-
Number of bending cycles	-	-
Number of torsion cycles in the case of torsion by ± 360° on 1 m cable length	-	-
Traction stress maximum	1 000 N	1 000 N
Short-term shear force per length	600 N/cm	600 N/cm
Continuous lateral force per length	200 N/cm	200 N/cm
Weight per length	67 kg/km	87 kg/km

**Technical specifications** (continued)

Article No.	6XV1873-2R	6XV1843-2R
Product-type designation	MM FO Robust Cable GP	SM FO robust cable GP
<b>Permitted ambient conditions</b>		
Ambient temperature		
• during operating	-40 ... +70 °C	-40 ... +70 °C
• during storage	-40 ... +70 °C	-40 ... +70 °C
• during transport	-40 ... +70 °C	-40 ... +70 °C
• during installation	-20 ... +60 °C	-20 ... +60 °C
Ambient condition for (standard) operation mode	-	-
Protection class IP	-	-
Burning behaviour	flame resistant according to IEC 60332-3-24	flame resistant according to IEC 60332-3-24
Chemical resistance		
• to mineral oil	Conditional resistance	Conditional resistance
• to grease	Conditional resistance	Conditional resistance
• to water	resistant	resistant
Radiological resistance to UV radiation	resistant	resistant
<b>Product properties, functions, components general</b>		
Product feature		
• halogen-free	Yes	Yes
• silicon-free	Yes	Yes
Product component Rodent protection	Yes	Yes
Cable length for glass FOC		
• for 100BaseFX for Industrial Ethernet maximum	5 000 m	26 000 m
• for 1000BaseSX for Industrial Ethernet maximum	750 m	-
• for 1000BaseLX for Industrial Ethernet maximum	2 000 m	5 000 m
• for PROFIBUS maximum	3 000 m	15 000 m
<b>Standards, specifications, approvals</b>		
Verification of suitability	-	-
• RoHS conformity	Yes	Yes
Marine classification association		
• Bureau Veritas (BV)	-	-
• Germanische Lloyd (GL)	-	-
• Lloyds Register of Shipping (LRS)	-	-

**PROFIBUS**

## Optical networks with OLM

## Glass fiber-optic cable

**Technical specifications** (continued)

Article No.	6GK1901-0DA20-0AA0
Product-type designation	BFOC Connector Set
Product description	BFOC connector set
Acceptability for application	For connection of fiber-optic cables
<b>Transmission rate</b>	
Transfer rate	
• 1 for Industrial Ethernet	10 Mbit/s
• 2 for Industrial Ethernet	100 Mbit/s
• 3 for Industrial Ethernet	1 000 Mbit/s
• with PROFIBUS	9.6 kbit/s ... 12 Mbit/s
<b>Interfaces</b>	
Number of optical interfaces for optical waveguide	1
Design of optical connections for network components or terminal devices	BFOC connector
Design of the electrical connection FastConnect	No
<b>Mechanical data</b>	
Material of the enclosure	Metal and plastic
<b>Design, dimensions and weight</b>	
Type of cable outlet	180 degree cable outlet
Width	10 mm
Height	10 mm
Depth	10 mm
Net weight	8 g

Article No.	6GK1901-0DA20-0AA0
Product-type designation	BFOC Connector Set
<b>Permitted ambient conditions</b>	
Ambient temperature	
• during operating	-
• during storage	-
• during transport	-
Relative humidity at 25 °C without condensation during operating maximum	-
Protection class IP	IP20
Chemical resistance to water	-
<b>Product properties, functions, components general</b>	
Product feature silicon-free	Yes
Product component strain relief	Yes
<b>Standards, specifications, approvals</b>	
Verification of suitability RoHS conformity	Yes



**PROFIBUS**

## Optical networks with OLM

## Glass fiber-optic cable

**Ordering data****Article No.****FLEXIBLE FIBER OPTIC CABLE trailing cable**  
(62.5/125/1 400), segmentable <sup>2)</sup>

Multimode cable,  
sold by the meter;  
max. delivery unit 2 000 m  
minimum order 20 m

Preferred lengths;  
pre-assembled with  
4 BFOC connectors

- 1 m
- 2 m
- 3 m
- 5 m
- 10 m
- 15 m
- 20 m
- 30 m
- 50 m
- 75 m
- 100 m

**6XV1820-6AH10**

**6XV1820-6BH10**  
**6XV1820-6BH20**  
**6XV1820-6BH30**  
**6XV1820-6BH50**  
**6XV1820-6BN10**  
**6XV1820-6BN15**  
**6XV1820-6BN20**  
**6XV1820-6BN30**  
**6XV1820-6BN50**  
**6XV1820-6BN75**  
**6XV1820-6BT10**

**SIENOPYR marine duplex fiber-optic cable**  
(62.5/125/900)

Fiber-optic cable for routing on  
ships and offshore platforms  
Multimode cable,  
sold by the meter;  
max. delivery unit 1 000 m  
minimum order 20 m

**6XV1830-0NH10****FO Robust Cable GP**  
4E9/125/900 <sup>2)</sup>

Single-mode cable,  
sold by the meter;  
max. length 2 000 m;  
minimum order 20 m;

**6XV1843-2R****Article No.***Accessories***Multimode FO BFOC connector set**

for FO standard cable  
(50/125/1 400), FO ground cable  
(50/125/1 400), flexible FO trailing  
cable, INDOOR FO cable  
(62.5/125/900), 20 units

**6GK1901-0DA20-0AA0****Multimode FO LC duplex plug**

LC duplex plug (10 units) for  
INDOOR FO cable (62.5/125/900),  
FO robust cable GP (50/125/900),  
FO standard cable (62.5/125/900)

**6GK1901-0RB10-2AB0****Singlemode FO LC duplex plug**

LC duplex plug (10 units) for FO  
robust cable GP (4E9/125/900)

**6GK1901-0SB10-2AB0****PROFIBUS network manual <sup>3)</sup>**

see  
<http://www.siemens.com/automation/csi/net>

**SIMATIC NET Manual Collection**

Electronic manuals for  
communication systems,  
communication protocols, and  
communication products;  
on DVD;  
German/English

**6GK1975-1AA00-3AA0**

- <sup>1)</sup> Special fiber-optic cables, lengths and accessories available on request
- <sup>2)</sup> Special tools and specially trained personnel are required for pre-assembling glass fiber-optic cables
- <sup>3)</sup> Further manuals can be found for the respective products at <http://www.siemens.com/automation/csi/net>

**More information**

You can order components and demonstration materials supplementary to the SIMATIC NET cabling range from your local contact.

Technical advice on this subject is available from:

J. Hertlein  
I IA SC CI PRM 4  
Phone: +49 (911) 750-4465  
E-mail: [juergen.hertlein@siemens.com](mailto:juergen.hertlein@siemens.com)



### Overview

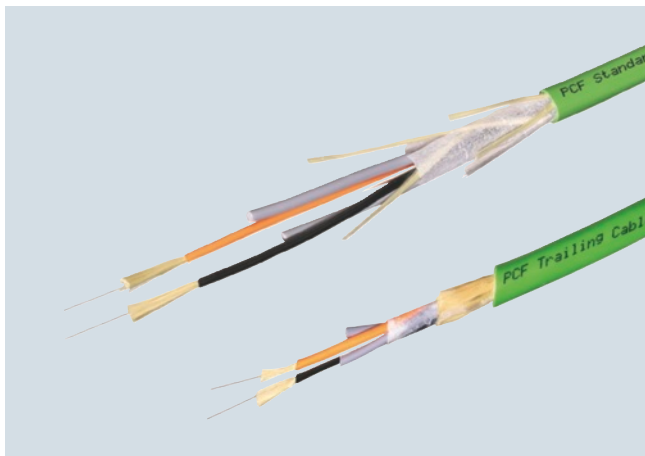

- Electrical isolation of PROFIBUS devices and PROFIBUS segments
- Protection of the transmission path against electromagnetic interference
- Up to 80 m cable length with plastic fiber-optic cables and up to 400 m with PCF fiber-optic cables
- Rugged fiber-optic standard cables, designed for industrial applications
- Extensive approvals (UL)

### Benefits



- Plastic and PCF fiber-optic cables can be pre-assembled on site
- Time savings when commissioning thanks to pre-assembled cables
- Protection of the transmission route against electromagnetic interference
- Tap-proof, as the cable does not emit radiation
- Avoidance of overvoltage and equipotential bonding problems

### Application

SIMATIC NET plastic and PCF fiber-optic cables are used together with OLM/P for establishing optical PROFIBUS networks or for optical linking of segments using RS 485 technology in indoor and outdoor applications.

Plastic fiber-optic cables and segmented PCF fiber-optic cables can be assembled on-site with 2 x 2 BFOC connectors. The maximum cable length between two OLM/P is 80 m.

Longer cable lengths up to 400 m can be achieved using PCF fiber-optic cables. These cables are also available preassembled with 4 BFOC connectors.

### Design

Different types of plastic and PCF fiber-optic cables are offered:

#### Plastic fiber-optic cables

- **Plastic FOC, standard cable;** rugged round cable with violet PVC outer sheath and Kevlar tension components as well as two plastic fibers with a rugged polyamide inner sheath. For indoor applications; cable lengths up to 80 m.

#### PCF fiber optic cables

- **PCF fiber-optic cable, standard cables:** Rugged round cables with violet/green PVC outer sheath and Kevlar strain relief elements for applications indoor/outdoors; cable lengths up to 400 m; the following cable versions are available:
  - PCF fiber optic standard cable; with violet PVC outer sheath for indoor applications. The cable is not suitable for assembly in the field; (only available pre-assembled with an insertion tool)
  - PCF Standard Cable GP (general purpose); with green PVC outer sheath for indoor and outdoor applications. The cable is suitable for assembly in the field.
- **PCF fiber optic trailing cable;** rugged round cable with green outer sheath and Kevlar tension elements for trailing cable applications; cable lengths of up to 400 m. The cables are suitable for assembly in the field. The following cable versions are available:
  - PCF Trailing Cable; cable for high mechanical stress, PUR outer sheath, no UL approval
  - PCF Trailing Cable GP (general purpose); cable for low mechanical stress, PVC outer sheath, with UL approval

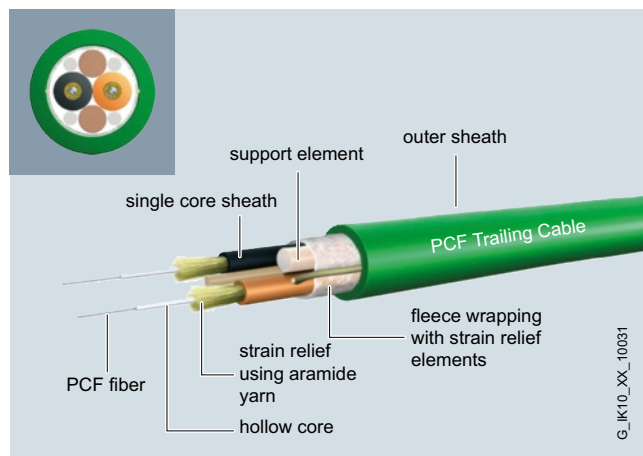

**PROFIBUS**

## Optical networks with OLM

## Plastic and PCF fiber-optic cable

**Technical specifications**

Article No.	6XV1821-0AH10	6XV1821-1BN75
Product-type designation	PROFIBUS Plastic Fiber Optic standard cable	PROFIBUS PCF Fiber Optic standard cable
Product description	Fiber-optic cable with polyoptical fiber, sold by the meter, unassembled	PCF fiber-optic cable with plastic cladding, preferred length, preassembled
Acceptability for application	Cable for indoor applications	Cable for indoor applications
Version of the assembled FO cable	Fitted with four BFOC connectors	Fitted with four BFOC connectors
Cable designation	I-V4Y(ZN)Y 2P 980/1000	I-V(ZN)Y 2K 200/230
Cable length	-	75 m
<b>Optical data</b>		
Damping ratio per length at 650 nm maximum	0.16 dB/m	0.01 dB/m
Bandwidth length product at 650 nm	1 GHz·m	17 GHz·m
<b>Mechanical data</b>		
Number of fibers per FOC core	1	1
Number of FOC cores per FOC cable	2	2
Version of the FO conductor fiber	Step index fiber 980/1 000 µm	Step index fiber 200/230 µm
Design of the FOC core	-	-
Design of the fiber-optic cable	-	-
Outer diameter		
• of optical fibers	980 µm	200 µm
• of the optical fiber sheath	1 000 µm	230 µm
• of the FOC core sheath	2.2 mm	2.2 mm
• of the cable	7.8 mm	4.7 mm
Symmetrical deviation		
• of the outer diameter of the FOC core sheath	0.1 mm	0.1 mm
• of the outer diameter of the line	0.3 mm	-
Material		
• of the fiber-optic cable core	Polymethylmethacrylate (PMMA)	Quartz glass
• of the optical fiber sheath	Fluoridated special polymer	Fluoridated special polymer
• of the FOC core sheath	PA	PVC
• of the fiber-optic cable sheath	PVC	PVC
• of the strain relief	Kevlar fibers	Kevlar fibers
Color		
• of the FOC core sheath	Orange/black	Orange/black
• of the cable sheath	Violet	Violet
Bending radius		
• with single bend minimum permissible	100 mm	47 mm
• with multiple bends minimum permissible	150 mm	70 mm
• with continuous bending	-	-
Number of bending cycles	-	-
Number of torsion cycles in the case of torsion by ± 360° on 1 m cable length	-	-
Traction stress maximum	100 N	200 N
Short-term shear force per length	100 N/cm	100 N/cm
Continuous lateral force per length	-	-
Weight per length	65 kg/km	22 kg/km

**Technical specifications** (continued)

Article No.	6XV1821-0AH10	6XV1821-1BN75
Product-type designation	PROFIBUS Plastic Fiber Optic standard cable	PROFIBUS PCF Fiber Optic standard cable
<b>Permitted ambient conditions</b>		
Ambient temperature		
• during operating	-30 ... +70 °C	-30 ... +70 °C
• during storage	-30 ... +70 °C	-30 ... +70 °C
• during transport	-30 ... +70 °C	-30 ... +70 °C
• during installation	-5 ... 50 °C	-5 ... +50 °C
Ambient condition for (standard) operation mode	-	-
Protection class IP	-	IP20
Burning behaviour	flame resistant according to IEC 60332-1-2	flame resistant according to IEC 60332-1-2
Chemical resistance		
• to mineral oil	Conditional resistance	Conditional resistance
• to grease	Conditional resistance	Conditional resistance
• to water	-	-
Radiological resistance to UV radiation	Not resistant	Not resistant
<b>Product properties, functions, components general</b>		
Product feature		
• halogen-free	No	No
• silicon-free	Yes	Yes
Product component Rodent protection	No	No
Cable length for POF FOC		
• for Industrial Ethernet maximum	-	-
• for PROFIBUS maximum	80 m	-
<b>Standards, specifications, approvals</b>		
Verification of suitability	UL approval: OFN (NEC Article 770, UL 1651) / CSA approval: OFN (CSA standard C22.2 No232-M1988)	-
• RoHS conformity	Yes	Yes

**PROFIBUS****Optical networks with OLM****Plastic and PCF fiber-optic cable****Technical specifications (continued)**

<b>Article No.</b>	<b>6XV1861-2A</b>	<b>6XV1861-2C</b>	<b>6XV1861-2D</b>
<b>Product-type designation</b>	<b>PCF Standard Cable GP</b>	<b>PCF Trailing Cable</b>	<b>PCF Trailing Cable GP</b>
Product description	PCF fiber-optic cable with plastic cladding, sold by the meter, unassembled	PCF fiber-optic cable with plastic cladding, sold by the meter, unassembled	PCF fiber-optic cable with plastic cladding, sold by the meter, unassembled
Acceptability for application	Cable for fixed installation for indoor and outdoor use, UL approval	Cable for use with high mechanical stress and moving applications (e.g. trailing cables), without UL approval	Cable for use with high mechanical stress and moving applications (e.g. trailing cables), UL approval
Version of the assembled FO cable	Can be fitted with SC RJ, SC RJ Plug PRO, BFOC and Simplex connectors	Can be fitted with SC RJ, SC RJ Plug PRO, BFOC and Simplex connectors	Can be fitted with SC RJ, SC RJ Plug PRO, BFOC and Simplex connectors
Cable designation	AT-V(ZN)YY 2K 200/230	AT-V(ZN)Y(ZN)11Y 2K 200/230	AT-V(ZN)Y(ZN)Y 2K 200/230
Cable length	-	-	-
<b>Optical data</b>			
Damping ratio per length at 660 nm maximum	10 dB/km	10 dB/km	10 dB/km
Bandwidth length product at 650 nm	17 GHz·m	17 GHz·m	17 GHz·m
<b>Mechanical data</b>			
Number of fibers per FOC core	1	1	1
Number of FOC cores per FOC cable	2	2	2
Version of the FO conductor fiber	Step index fiber 200/230 µm	Step index fiber 200/230 µm	Step index fiber 200/230 µm
Design of the FOC core	-	-	-
Design of the fiber-optic cable	-	-	-
Outer diameter			
• of optical fibers	200 µm	200 µm	200 µm
• of the optical fiber sheath	230 µm	230 µm	230 µm
• of the FOC core sheath	2.2 mm	2.2 mm	2.2 mm
• of the cable	7.2 mm	8.8 mm	8.8 mm
Symmetrical deviation			
• of the outer diameter of the FOC core sheath	0.1 mm	0.1 mm	0.1 mm
• of the outer diameter of the line	0.5 mm	0.5 mm	0.5 mm
Material			
• of the fiber-optic cable core	Quartz glass	Quartz glass	Quartz glass
• of the optical fiber sheath	Special polymer	Special polymer	Special polymer
• of the FOC core sheath	PVC	PVC	PVC
• of the fiber-optic cable sheath	PVC	PUR	PVC
• of the strain relief	Aramide fibers	Aramide fibers	Aramide fibers
Color			
• of the FOC core sheath	Orange/black	Orange/black	Orange/black
• of the cable sheath	green	green	green
Bending radius			
• with single bend minimum permissible	70 mm	130 mm	130 mm
• with multiple bends minimum permissible	105 mm	175 mm	175 mm
• with continuous bending	-	-	-
Number of bending cycles	-	5 000 000	5 000 000
Number of torsion cycles in the case of torsion by ± 360° on 1 m cable length	-	-	-
Traction stress maximum	100 N	800 N	800 N
Short-term shear force per length	500 N/cm	500 N/cm	500 N/cm
Continuous lateral force per length	300 N/cm	300 N/cm	300 N/cm
Weight per length	45 kg/km	85 kg/km	85 kg/km

**Technical specifications** (continued)

Article No.	6XV1861-2A	6XV1861-2C	6XV1861-2D
Product-type designation	PCF Standard Cable GP	PCF Trailing Cable	PCF Trailing Cable GP
<b>Permitted ambient conditions</b>			
Ambient temperature			
• during operating	-40 ... +90 °C	-25 ... +75 °C	-25 ... +75 °C
• during storage	-40 ... +90 °C	-30 ... +75 °C	-30 ... +75 °C
• during transport	-40 ... +90 °C	-30 ... +75 °C	-30 ... +75 °C
• during installation	-5 ... +50 °C	-5 ... +50 °C	-5 ... +50 °C
Ambient condition for (standard) operation mode	-	-	-
Protection class IP	-	-	-
Burning behaviour	flame resistant according to IEC 60332-1-2 and IEC 60332-3-22 (Cat. A)	flame-retardant	flame resistant according to IEC 60332-1-2 and IEC 60332-3-22 (Cat. A)
Chemical resistance			
• to mineral oil	Conditional resistance	resistant	Conditional resistance
• to grease	Conditional resistance	resistant	Conditional resistance
• to water	Conditional resistance	Conditional resistance	Conditional resistance
Radiological resistance to UV radiation	resistant	resistant	resistant
<b>Product properties, functions, components general</b>			
Product feature			
• halogen-free	No	No	No
• silicon-free	Yes	Yes	Yes
Product component Rodent protection	No	No	No
Cable length for PCF FOC			
• for Industrial Ethernet maximum	100 m	100 m	100 m
• for PROFIBUS maximum	400 m	400 m	400 m
<b>Standards, specifications, approvals</b>			
Verification of suitability	UL approval: OFN (NEC Article 770, UL 1651) / CSA approval: OFN 90 Cel, FT1, FT4 (CSA standard C22.2 No232-M1988)	-	UL approval: OFN (NEC Article 770, UL 1651) / CSA approval: OFN 90 Cel, FT1, FT4 (CSA standard C22.2 No232-M1988)
• RoHS conformity	Yes	Yes	Yes

**PROFIBUS**

## Optical networks with OLM

## Plastic and PCF fiber-optic cable

**Technical specifications (continued)**

<b>Article No.</b>	<b>6GK 905-1PA00</b>
<b>Product-type designation</b>	<b>PB BFOC Plug POF</b>
Product description	BFOC connector
Acceptability for application	For assembling PB plastic fiber-optic cables for OLM/P..
<b>Transmission rate</b>	
Transfer rate	
• 1 for Industrial Ethernet	-
• 2 for Industrial Ethernet	-
• 3 for Industrial Ethernet	-
• with PROFIBUS	9.6 kbit/s ... 12 Mbit/s
<b>Interfaces</b>	
Number of optical interfaces for optical waveguide	1
Design of optical connections for network components or terminal devices	BFOC connector
Design of the electrical connection FastConnect	No
<b>Mechanical data</b>	
Material of the enclosure	metal
<b>Design, dimensions and weight</b>	
Type of cable outlet	180 degree cable outlet
Width	10 mm
Height	10 mm
Depth	10 mm
Net weight	10 g
<b>Permitted ambient conditions</b>	
Protection class IP	IP20
Chemical resistance to water	-
<b>Product properties, functions, components general</b>	
Product feature silicon-free	Yes
Product component strain relief	Yes
<b>Standards, specifications, approvals</b>	
Verification of suitability RoHS conformity	Yes

**Ordering data****Article No.****PROFIBUS Plastic Fiber Optic, standard cable**

Rugged round cable with 2 plastic fiber-optic cores, PVC outer sheath and PA inner sheath, for indoor use

- Without connector
- Sold by the meter
  - 50 m ring
  - 100 m ring

Preferred lengths pre-assembled with 2 x 2 BFOC plugs, lash length 20 cm each, for connecting OLM/P..

- 1 m
- 2 m
- 5 m
- 10 m
- 15 m
- 20 m
- 25 m
- 30 m
- 50 m
- 65 m
- 80 m

**6XV1821-0AH10**  
**6XV1821-0AN50**  
**6XV1821-0AT10**

**6XV1821-0BH10**  
**6XV1821-0BH20**  
**6XV1821-0BH50**  
**6XV1821-0BN10**  
**6XV1821-0BN15**  
**6XV1821-0BN20**  
**6XV1821-0BN25**  
**6XV1821-0BN30**  
**6XV1821-0BN50**  
**6XV1821-0BN65**  
**6XV1821-0BN80**

**PROFIBUS Plastic Fiber Optic, stripping tool set**

Tools for removing the outer sheath or core sheath of PROFIBUS Plastic Fiber Optic cables

**6GK1905-6PA10**

**PROFIBUS Plastic Fiber Optic, BFOC connector set**

20 BFOC plugs for assembly of PROFIBUS Plastic Fiber Optic cables for OLM/P..

**6GK1905-1PA00**

**PROFIBUS Plastic Fiber Optic, BFOC crimping tool**

For assembly of BFOC plug on PROFIBUS Plastic Fiber Optic cables

**6GK1905-6PB00**

**PROFIBUS Plastic Fiber Optic, BFOC polishing set**

Polishing set for grinding and polishing the BFOC plug face for PROFIBUS Plastic Fiber Optic cables with OLM/P..

**6GK1905-6PS00**

Ordering data	Article No.	Article No.	
<b>PROFIBUS PCF Fiber Optic standard cable</b> PCF fiber-optic cable with 2 cores, PVC outer sheath, for bridging large distances up to 400 m, Preferred lengths pre-assembled with 2 x 2 BFOC plugs, lash length 20 cm each, with insertion tool mounted on one end for connecting OLM/P.. <ul style="list-style-type: none"> <li>• 75 m</li> <li>• 100 m</li> <li>• 150 m</li> <li>• 200 m</li> <li>• 250 m</li> <li>• 300 m</li> <li>• 400 m</li> </ul>	<b>6XV1821-1BN75</b> <b>6XV1821-1BT10</b> <b>6XV1821-1BT15</b> <b>6XV1821-1BT20</b> <b>6XV1821-1BT25</b> <b>6XV1821-1BT30</b> <b>6XV1821-1BT40</b>	<b>PROFIBUS PCF Trailing Cable 200/230</b> Trailing cable, segmentable, <u>sold by the meter</u> ; max. length 2 000 m; minimum order 20 m; Preferred lengths pre-assembled with 4 BFOC connectors <ul style="list-style-type: none"> <li>• 75 m</li> <li>• 100 m</li> <li>• 150 m</li> <li>• 200 m</li> <li>• 250 m</li> <li>• 300 m</li> <li>• 400 m</li> </ul>	<b>6XV1861-2C</b>  <b>6XV1861-3CN75</b> <b>6XV1861-3CT10</b> <b>6XV1861-3CT15</b> <b>6XV1861-3CT20</b> <b>6XV1861-3CT25</b> <b>6XV1861-3CT30</b> <b>6XV1861-3CT40</b>
<b>PROFIBUS PCF Standard Cable GP 200/230</b> Standard cable, segmentable, <u>sold by the meter</u> ; max. length 2 000 m; minimum order 20 m; Preferred lengths pre-assembled with 4 BFOC connectors <ul style="list-style-type: none"> <li>• 75 m</li> <li>• 100 m</li> <li>• 150 m</li> <li>• 200 m</li> <li>• 250 m</li> <li>• 300 m</li> <li>• 400 m</li> </ul>	<b>6XV1861-2A</b>  <b>6XV1861-3AN75</b> <b>6XV1861-3AT10</b> <b>6XV1861-3AT15</b> <b>6XV1861-3AT20</b> <b>6XV1861-3AT25</b> <b>6XV1861-3AT30</b> <b>6XV1861-3AT40</b>	<b>PROFIBUS PCF Trailing Cable GP 200/230</b> Trailing cable, segmentable, <u>sold by the meter</u> ; max. length 2 000 m; minimum order 20 m; Preferred lengths pre-assembled with 4 BFOC connectors <ul style="list-style-type: none"> <li>• 75 m</li> <li>• 100 m</li> <li>• 150 m</li> <li>• 200 m</li> <li>• 250 m</li> <li>• 300 m</li> <li>• 400 m</li> </ul>	<b>6XV1861-2D</b>  <b>6XV1861-3DN75</b> <b>6XV1861-3DT10</b> <b>6XV1861-3DT15</b> <b>6XV1861-3DT20</b> <b>6XV1861-3DT25</b> <b>6XV1861-3DT30</b> <b>6XV1861-3DT40</b>
		<b>SIMATIC NET Manual Collection</b> Electronic manuals for communication systems, communication protocols, and communication products; on DVD; German/English	<b>6GK1975-1AA00-3AA0</b>

### More information

You can order components and demonstration materials supplementary to the SIMATIC NET cabling range from your local contact.

Technical advice on this subject is available from:

J. Hertlein  
 I IA SC CI PRM 4  
 Phone: +49 (911) 750-4465  
 E-mail: [juergen.hertlein@siemens.com](mailto:juergen.hertlein@siemens.com)

## PROFIBUS

### Optical networks with OLM

#### PCF-FOC termination kit

##### Overview



- Compact, rugged assembly case for PCF fiber-optic cables
- Special versions for easy assembly of HP Simplex and BFOC plugs on PCF fiber-optic cables
- The quality of the assembly can be checked using the enclosed microscope

##### Benefits



- Easy installation of the unassembled cables in industrial plants
- Flexible assembly of connectors on PCF fiber-optic cables on site (HP Simplex, BFOC connectors)
- Mistakes are avoided with easy visual inspection of the assembled connector on site using a microscope
- PCF fiber-optic cables are easily repaired on site by installing a new PCF cable

##### Application

SIMATIC NET PCF fiber-optic conductors are used to construct optical indoor and outdoor PROFIBUS DP networks. They are easy to assemble on site with 2 x 2 Simplex connectors or 2 x 2 BFOC connectors. The maximum cable length between two DP devices is 300 m and between two OLMs 400 m.

PROFIBUS DP devices with integrated optical interface (Simplex connection technology) include, for example, OBT, CP 342-5 FO, CP 5613 FO, IM 153-2 FO, IM 467 FO.

##### Design

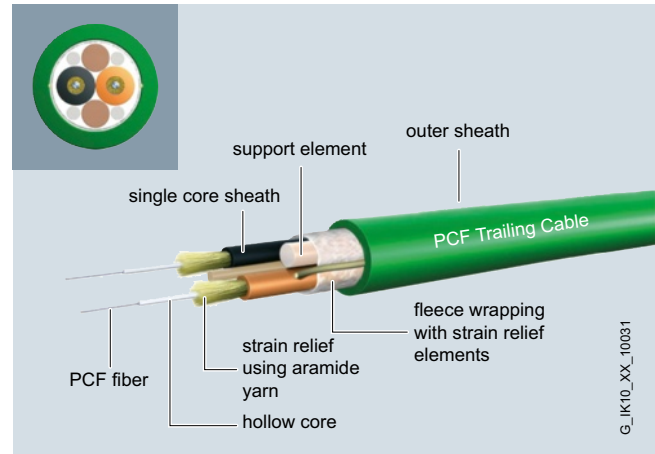

Two versions of the assembly case are available for PCF fiber-optic cables:

- Assembly case for HP Simplex connectors; for on-site pre-assembly of HP Simplex connectors; comprising a stripping tool, buffer stripping tool, Kevlar cutters, fiber breaking tool, crimping tool and microscope
- Assembly case for BFOC connectors; for on-site pre-assembly of BFOC connectors; comprising a stripping tool, buffer stripping tool, Kevlar cutters, fiber breaking tool and microscope

G\_IK10\_XX\_10031



**Technical specifications**

Article No.	6GK1900-0KB00-0AC0	6GK1900-0HB00-0AC0
Product-type designation	PB Simplex Plug PCF	PB BFOC Plug PCF
Product description	Simplex crimp connector for PCF fiber-optic cables with plastic cladding	BFOC screw connector for PCF fiber-optic cables with plastic cladding
Acceptability for application	For connection of PCF fiber-optic cables	For connection of PCF fiber-optic cables
<b>Transmission rate</b>		
Transfer rate		
• 1 for Industrial Ethernet	-	-
• 2 for Industrial Ethernet	-	-
• 3 for Industrial Ethernet	-	-
• with PROFIBUS	9.6 kbit/s ... 12 Mbit/s	9.6 kbit/s ... 12 Mbit/s
<b>Interfaces</b>		
Number of optical interfaces for optical waveguide	1	1
Design of optical connections for network components or terminal devices	Simplex connector	BFOC connector
Design of the electrical connection FastConnect	No	No
<b>Mechanical data</b>		
Material of the enclosure	plastic	Metal and plastic
<b>Design, dimensions and weight</b>		
Type of cable outlet	180 degree cable outlet	180 degree cable outlet
Width	9.4 mm	10 mm
Height	6.1 mm	10 mm
Depth	29.9 mm	10 mm
Net weight	20 g	8 g
<b>Permitted ambient conditions</b>		
Protection class IP	IP20	IP20
Chemical resistance to water	-	-
<b>Product properties, functions, components general</b>		
Product feature silicon-free	Yes	Yes
Product component strain relief	Yes	Yes
<b>Standards, specifications, approvals</b>		
Verification of suitability RoHS conformity	Yes	Yes

**PROFIBUS**

## Optical networks with OLM

## PCF-FOC termination kit

**Ordering data****Article No.****Termination Kit****for Simplex connectors**

Assembly case for local assembly of PCF Simplex connectors; comprising a stripping tool, buffer stripping tool, Kevlar cutters, fiber breaking tool, crimping tool and microscope

**6GK1900-0KL00-0AA0****Termination Kit****for BFOC connectors**

Assembly case for local assembly of BFOC connectors; comprising a stripping tool, buffer stripping tool, Kevlar cutters, fiber breaking tool, and microscope

**6GK1900-0HL00-0AA0****Connector****Simplex connector**

with cleaning materials; 50 crimp connectors for assembly on PCF fiber-optic cables on site

**6GK1900-0KB00-0AC0****BFOC connector**

with cleaning materials; 20 screw connectors for assembly on PCF fiber-optic cables on site

**6GK1900-0HB00-0AC0****More information**

You can order components supplementary to the SIMATIC NET cabling range from your local contact.

Technical advice on this subject is available from:

J. Hertlein

I IA SC CI PRM 4

Phone: +49 (911) 750-4465

E-mail: [juergen.hertlein@siemens.com](mailto:juergen.hertlein@siemens.com)

### Overview



- Construction of optical PROFIBUS networks (line, star, ring) with glass, PCF and plastic fiber optic cables
- High availability can be achieved using a redundant power supply and redundant cable routing
- Function monitoring by means of signaling contact
- All PROFIBUS data transmission rates from 9.6 Kbit/s to 12 Mbit/s inclusive 45.45 Kbit/s for PROFIBUS PA
- Monitoring of the fiber optic cable routes on LEDs for channel monitoring or using a voltmeter across measurement terminals

### Benefits

get **Designed for Industry**

- High availability of the network thanks to redundant optical ring
- Fast fault localization due to signaling of the fiber-optic line quality to LEDs and signaling contact (e.g. import of the level value of the fiber-optic line quality via an analog module into a programmable logic controller)
- Large range due to use of glass fiber optic cables in lengths of up to 15 km
- OLM/G12-EEC for outdoor use down to -25 °C

### Application

With the PROFIBUS OLM (Optical Link Modules), optical PROFIBUS networks can be established in linear, star and redundant ring topologies.

The data transfer rate of a fiber optic line is independent of the distance and can be up to 12 Mbit/s.

Possible applications for OLMs include:

- System buses based on PROFIBUS
- Networking between buildings using glass fiber optic cable
- Mixed networks with electrical and optical segments
- Networks covering a wide area (road tunnels, traffic control systems)
- Networks with high availability requirements (redundant ring networks)

### Design

The OLMs have a compact metal housing. It is suitable for mounting on a standard rail or for wall mounting with a mounting plate.

The 24 V power supply is fed in through a terminal block and can be redundantly connected.

The signaling contact allows a digital signal to be transferred to PLCs or HMI systems for evaluation.

OLMs can be combined with each other and individual stations or complete electrical segments can be integrated into the optical PROFIBUS network through an electrical interface. With the PROFIBUS OLM P22 and OLM G22, two electric PROFIBUS segments can be connected separated from each other.

OLMs are available with one or two fiber optic interfaces with BFOC connectors for different types of fiber optic cables:

- Plastic fiber-optic cables (980/1 000  $\mu\text{m}$ ) can be used for single lengths of up to 80 m. They can also be assembled with BFOC cable connectors on site.
- PCF fiber-optic cables (200/230  $\mu\text{m}$ ) can be used for single lengths of up to 400 m. They are offered preassembled with four BFOC plugs and an insertion tool.
- Glass fiber multimode fiber-optic cables (62.5/125  $\mu\text{m}$ ) such as the SIMATIC NET Fiber Optic cables can be used for long distances of up to 3000 m. They must be ordered preassembled with 4 BFOC plugs or as a FastConnect FO system for assembly on site.
- Singlemode fiber-optic cables (10/125  $\mu\text{m}$  or 9/125  $\mu\text{m}$  fibers) can be used for extremely long distances up to 15 km.

### Function

- Automatic detection of all PROFIBUS data transmission rates 9.6 Kbit/s to 12 Mbit/s inclusive 45.45 Kbit/s (PROFIBUS PA)
- Construction of the following network topologies: Line, star, redundant ring
- High availability due to media redundancy. The distance between two OLMs in the redundant ring is only limited by the optical range of the modules
- RS485 interface with segment capability (Sub-D female connector)
- Unrestricted multimaster operation: Expanded segmentation functions for localization of faults to fiber optic and RS485 segments
- Fast localization of faults:
  - Indication of module status through floating signaling contact
  - Checking the fiber optic cable route quality on LEDs
  - Checking the fiber optic cable route quality Measurement output for optical receiver for logging and plausibility checking of the fiber optic path attenuation with a voltmeter
- High cascading depth: Line and redundant ring up to 124 OLM (only limited by monitoring times)

# PROFIBUS

## Optical networks with OLM

### OLM Optical Link Module

#### Integration

3

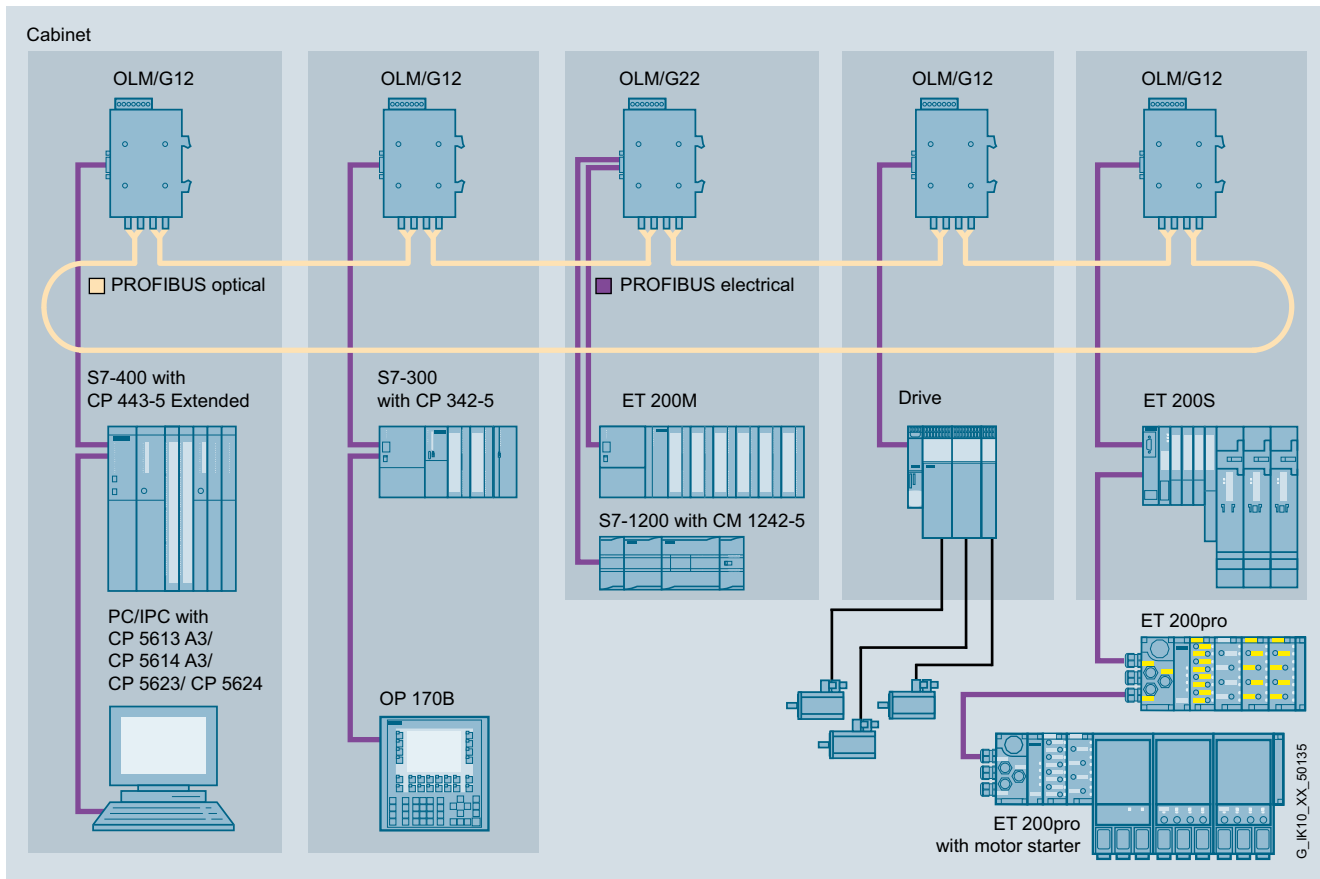

Example of a system configuration with OLM for PROFIBUS in a ring structure

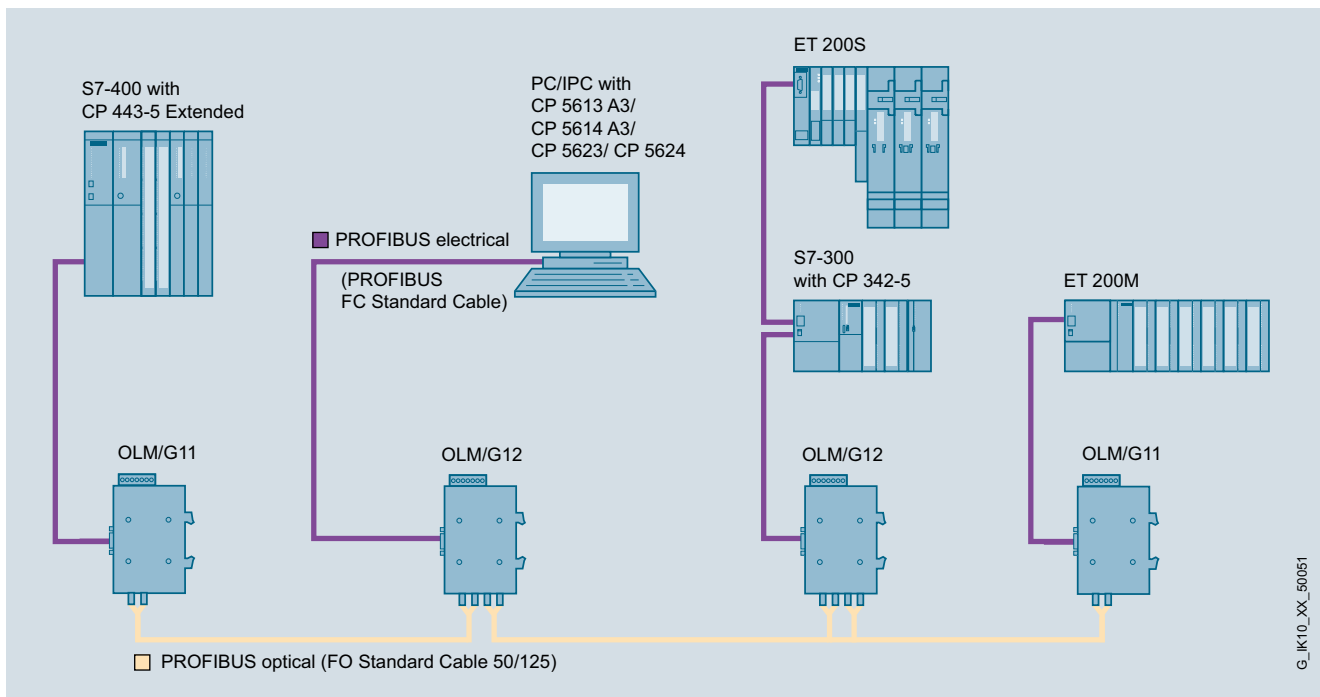

Optical line topology with PROFIBUS OLM G11/G12

**Integration** (continued)

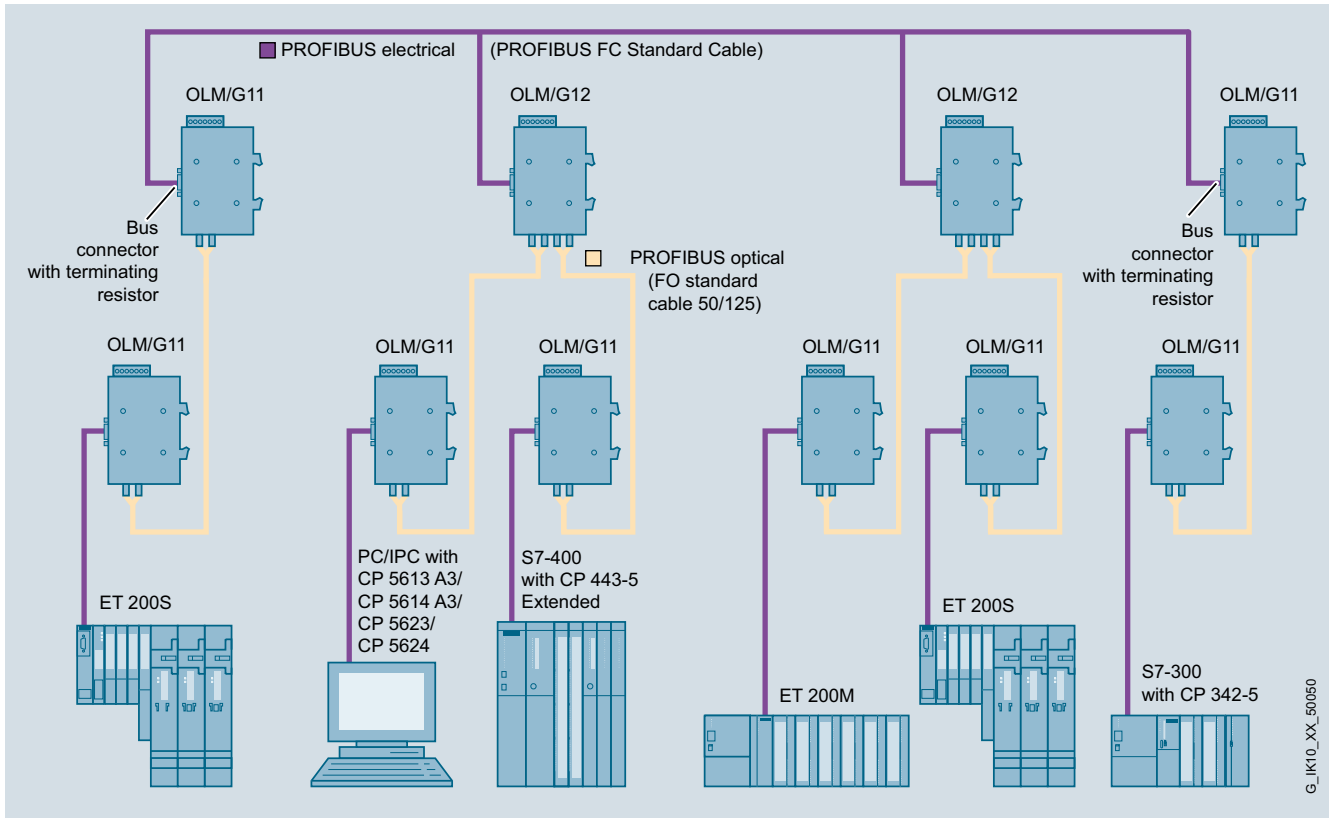

Optical star topology with PROFIBUS OLM G11/G12

**PROFIBUS**

## Optical networks with OLM

## OLM Optical Link Module

**Technical specifications**

Article No.	6GK1503-2CA00	6GK1503-3CA00	6GK1503-4CA00
Product-type designation	PROFIBUS OLM P11	PROFIBUS OLM P12	PROFIBUS OLM P22
<b>Transmission rate</b>			
Transfer rate			
• with PROFIBUS	9.6 kbit/s ... 12 Mbit/s	9.6 kbit/s ... 12 Mbit/s	9.6 kbit/s ... 12 Mbit/s
• With PROFIBUS PA	45.45 kbit/s	45.45 kbit/s	45.45 kbit/s
<b>Interfaces</b>			
Number of electrical/optical connections for network components or terminal equipment maximum	2	3	4
Number of electrical connections			
• for network components and terminal equipment	1	1	2
• for measuring instrument	1	1	1
• for signaling contact	1	1	1
• for power supply	1	1	1
• for redundant power supply	1	1	1
Design of electrical connection			
• for network components and terminal equipment	9-pin Sub-D socket	9-pin Sub-D socket	9-pin Sub-D socket
• for measuring device	2-pole terminal block	2-pole terminal block	2-pole terminal block
• for power supply and signaling contact	5-pole terminal block	5-pole terminal block	5-pole terminal block
Number of optical interfaces for optical waveguide	1	2	2
Design of the optical interface for optical waveguide	BFOC port	BFOC port	BFOC port
<b>Optical data</b>			
Damping ratio of FOC transmission link			
• for glass FOC with 10/125 µm or 9/125 µm at 0.5 dB/km maximum	-	-	-
• for glass FOC with 50/125 µm at 3 dB/km maximum	-	-	-
• for glass FOC with 62.5/125 µm			
- at 1 dB/km maximum	-	-	-
- at 3.5 dB/km maximum	-	-	-
• for PCF FOC with 200/230 µm at 10 dB/km	-	-	-
• for POF FOC with 980/1 000 µm at 230 dB/km	13 dB	13 dB	13 dB
Signal delay time in bit time	6.5 bit	6.5 bit	6.5 bit
Injectable optical power relating to 1 mW			
• for glass FOC with 10/125 µm or 9/125 µm at 0.5 dB/km	-	-	-
• for glass FOC with 50/125 µm at 3 dB/km	-	-	-
• for glass FOC with 62.5/125 µm			
- at 1 dB/km	-	-	-
- at 3.5 dB/km	-	-	-
• of FOC transmission link			
- for PCF FOC with 200/230 µm at 10 dB/km	-17 dB	-17 dB	-17 dB
- for POF FOC with 980/1 000 µm at 230 dB/km	-5 dB	-5 dB	-5 dB

**Technical specifications** (continued)

Article No.	6GK1503-2CA00	6GK1503-3CA00	6GK1503-4CA00
Product-type designation	PROFIBUS OLM P11	PROFIBUS OLM P12	PROFIBUS OLM P22
Optical sensitivity relating to 1 mW			
• for glass FOC with 10/125 µm or 9/125 µm at 0.5 dB/km	-	-	-
• for glass FOC with 50/125 µm at 3 dB/km	-	-	-
• for glass FOC with 62.5/125 µm			
- at 1 dB/km	-	-	-
- at 3.5 dB/km	-	-	-
• of FOC transmission link			
- for PCF FOC with 200/230 µm at 10 dB/km	-25 dB	-	-
- for POF FOC with 980/1 000 µm at 230 dB/km	-25 dB	-	-
Wavelength			
• for glass FOC with 10/125 µm or 9/125 µm compatible with interface at 0.5 dB/km	-	-	-
• for glass FOC with 50/125 µm compatible with interface at 3 dB/km	-	-	-
• for glass FOC with 62.5/125 µm compatible with interface			
- at 1 dB/km	-	-	-
- at 3.5 dB/km	-	-	-
• of FOC transmission link			
- for PCF FOC with 200/230 µm at 10 dB/km	660 nm	660 nm	660 nm
- for POF FOC with 980/1 000 µm at 230 dB/km	660 nm	660 nm	660 nm
Cable length			
• for glass FOC with 10/125 µm or 9/125 µm at 0.5 dB/km maximum	-	-	-
• for glass FOC with 50/125 µm at 3 dB/km maximum	-	-	-
• for glass FOC with 62.5/125 µm at 1 dB/km maximum	-	-	-
• for glass FOC with 62.5/125 µm at 3.5 dB/km maximum	-	-	-
• for PCF FOC with 200/230 µm at 10 dB/km maximum	400 m	400 m	400 m
• for POF FOC with 980/1 000 µm at 230 dB/km maximum	80 m	80 m	80 m
<b>Signal-Inputs/outputs</b>			
Operating voltage of signaling contacts at DC rated value	24 V	24 V	24 V
Operating current of signaling contacts at DC maximum	0.1 A	0.1 A	0.1 A
<b>Supply voltage, current consumption, power loss</b>			
Type of supply voltage	DC	DC	DC
Supply voltage for DC			
• rated value	24 V	24 V	24 V
• minimum	18.8 V	18.8 V	18.8 V
• maximum	28.8 V	28.8 V	28.8 V
Product component fusing at power supply input	Yes	Yes	Yes
Type of fusing at input for supply voltage	-	-	-
Consumed current At 24 V with DC maximum	0.2 A	0.2 A	0.2 A
Active power loss at 24 V for DC	-	-	-

**PROFIBUS**

## Optical networks with OLM

## OLM Optical Link Module

**Technical specifications** (continued)

Article No.	6GK1503-2CA00	6GK1503-3CA00	6GK1503-4CA00
Product-type designation	PROFIBUS OLM P11	PROFIBUS OLM P12	PROFIBUS OLM P22
<b>Permitted ambient conditions</b>			
Ambient temperature			
• during operating	0 ... 60 °C	0 ... 60 °C	0 ... 60 °C
• during storage	-40 ... +70 °C	-40 ... +70 °C	-40 ... +70 °C
• during transport	-40 ... +70 °C	-40 ... +70 °C	-40 ... +70 °C
Relative humidity at 25 °C without condensation during operating maximum	95 %	95 %	95 %
Protection class IP	IP40	IP40	IP40
<b>Design, dimensions and weight</b>			
Design	compact	compact	compact
Width	39.5 mm	39.5 mm	39.5 mm
Height	112 mm	112 mm	112 mm
Depth	74.5 mm	74.5 mm	74.5 mm
Net weight	340 g	340 g	340 g
Mounting type			
• 35 mm DIN rail mounting	Yes	Yes	Yes
• wall mounting	Yes	Yes	Yes
<b>Product properties, functions, components general</b>			
Product function Ring redundancy	Yes	Yes	Yes
<b>Standards, specifications, approvals</b>			
Standard			
• for EMC from FM	FM3611: Class 1, Divison 2, Group A, B, C, D / T4, Class 1, Zone 2, Group IIC, T4	FM3611: Class 1, Divison 2, Group A, B, C, D / T4, Class 1, Zone 2, Group IIC, T4	FM3611: Class 1, Divison 2, Group A, B, C, D / T4, Class 1, Zone 2, Group IIC, T4
• for hazardous zone	EN 60079-0: 2006, EN60079-15: 2005, EN60079-28: 2007, II 3 (2) G Ex nA [opis] IIC T4 KEMA 09 ATEX 0173X	EN 60079-0: 2006, EN60079-15: 2005, EN60079-28: 2007, II 3 (2) G Ex nA [opis] IIC T4 KEMA 09 ATEX 0173X	EN 60079-0: 2006, EN60079-15: 2005, EN60079-28: 2007, II 3 (2) G Ex nA [opis] IIC T4 KEMA 09 ATEX 0173X
• for safety of CSA and UL	UL 60950-1, CSA C22.2 Nr. 60950-1	UL 60950-1, CSA C22.2 Nr. 60950-1	UL 60950-1, CSA C22.2 Nr. 60950-1
• for hazardous area of CSA and UL	UL 1604 and UL 2279-15 (Hazardous Location), CSA C22.2 No. 213-M1987, Class 1 / Division 2 / Group A, B, C, D / T4, Class 1 / Zone 2 / Group IIC / T4	UL 1604 and UL 2279-15 (Hazardous Location), CSA C22.2 No. 213-M1987, Class 1 / Division 2 / Group A, B, C, D / T4, Class 1 / Zone 2 / Group IIC / T4	UL 1604 and UL 2279-15 (Hazardous Location), CSA C22.2 No. 213-M1987, Class 1 / Division 2 / Group A, B, C, D / T4, Class 1 / Zone 2 / Group IIC / T4
• for emitted interference	EN 61000-6-4 (Class A)	EN 61000-6-4 (Class A)	EN 61000-6-4 (Class A)
• for interference immunity	EN 61000-6-2	EN 61000-6-2	EN 61000-6-2
Verification of suitability	EN 61000-6-2, EN 61000-6-4	EN 61000-6-2, EN 61000-6-4	EN 61000-6-2, EN 61000-6-4
• CE mark	Yes	Yes	Yes
• C-Tick	Yes	Yes	Yes
Marine classification association			
• American Bureau of Shipping Europe Ltd. (ABS)	Yes	Yes	Yes
• Bureau Veritas (BV)	Yes	Yes	Yes
• Det Norske Veritas (DNV)	Yes	Yes	Yes
• Germanische Lloyd (GL)	Yes	Yes	Yes
• Lloyds Register of Shipping (LRS)	Yes	Yes	Yes
• Nippon Kaiji Kyokai (NK)	Yes	Yes	Yes



**Technical specifications** (continued)

Article No.	6GK1503-2CB00	6GK1503-3CB00	6GK1503-4CB00
Product-type designation	PROFIBUS OLM G11	PROFIBUS OLM G12	PROFIBUS OLM G22
<b>Transmission rate</b>			
Transfer rate			
• with PROFIBUS	9.6 kbit/s ... 12 Mbit/s	9.6 kbit/s ... 12 Mbit/s	9.6 kbit/s ... 12 Mbit/s
• With PROFIBUS PA	45.45 kbit/s	45.45 kbit/s	45.45 kbit/s
<b>Interfaces</b>			
Number of electrical/optical connections for network components or terminal equipment maximum	2	3	4
Number of electrical connections			
• for network components and terminal equipment	1	1	2
• for measuring instrument	1	1	1
• for signaling contact	1	1	1
• for power supply	1	1	1
• for redundant power supply	1	1	1
Design of electrical connection			
• for network components and terminal equipment	9-pin Sub-D socket	9-pin Sub-D socket	9-pin Sub-D socket
• for measuring device	2-pole terminal block	2-pole terminal block	2-pole terminal block
• for power supply and signaling contact	5-pole terminal block	5-pole terminal block	5-pole terminal block
Number of optical interfaces for optical waveguide	1	2	2
Design of the optical interface for optical waveguide	BFOC port	BFOC port	BFOC port
<b>Optical data</b>			
Damping ratio of FOC transmission link			
• for glass FOC with 10/125 µm or 9/125 µm at 0.5 dB/km maximum	-	-	-
• for glass FOC with 50/125 µm at 3 dB/km maximum	10 dB	10 dB	10 dB
• for glass FOC with 62.5/125 µm			
- at 1 dB/km maximum	-	-	-
- at 3.5 dB/km maximum	12 dB	12 dB	12 dB
• for PCF FOC with 200/230 µm at 10 dB/km	-	-	-
• for POF FOC with 980/1 000 µm at 230 dB/km	-	-	-
Signal delay time in bit time	6.5 bit	6.5 bit	6.5 bit
Injectable optical power relating to 1 mW			
• for glass FOC with 10/125 µm or 9/125 µm at 0.5 dB/km	-	-	-
• for glass FOC with 50/125 µm at 3 dB/km	-16 dB	-16 dB	-16 dB
• for glass FOC with 62.5/125 µm			
- at 1 dB/km	-	-	-
- at 3.5 dB/km	-13 dB	-13 dB	-13 dB
• of FOC transmission link			
- for PCF FOC with 200/230 µm at 10 dB/km	-	-	-
- for POF FOC with 980/1 000 µm at 230 dB/km	-	-	-

**PROFIBUS**

## Optical networks with OLM

## OLM Optical Link Module

**Technical specifications** (continued)

Article No.	6GK1503-2CB00	6GK1503-3CB00	6GK1503-4CB00
Product-type designation	PROFIBUS OLM G11	PROFIBUS OLM G12	PROFIBUS OLM G22
Optical sensitivity relating to 1 mW			
• for glass FOC with 10/125 µm or 9/125 µm at 0.5 dB/km	-	-	-
• for glass FOC with 50/125 µm at 3 dB/km	-28 dB	-28 dB	-28 dB
• for glass FOC with 62.5/125 µm			
- at 1 dB/km	-	-	-
- at 3.5 dB/km	-28 dB	-28 dB	-28 dB
• of FOC transmission link			
- for PCF FOC with 200/230 µm at 10 dB/km	-	-	-
- for POF FOC with 980/1 000 µm at 230 dB/km	-	-	-
Wavelength			
• for glass FOC with 10/125 µm or 9/125 µm compatible with interface at 0.5 dB/km	-	-	-
• for glass FOC with 50/125 µm compatible with interface at 3 dB/km	860 nm	860 nm	860 nm
• for glass FOC with 62.5/125 µm compatible with interface			
- at 1 dB/km	-	-	-
- at 3.5 dB/km	860 nm	860 nm	860 nm
• of FOC transmission link			
- for PCF FOC with 200/230 µm at 10 dB/km	-	-	-
- for POF FOC with 980/1 000 µm at 230 dB/km	-	-	-
Cable length			
• for glass FOC with 10/125 µm or 9/125 µm at 0.5 dB/km maximum	-	-	-
• for glass FOC with 50/125 µm at 3 dB/km maximum	3 km	3 km	3 km
• for glass FOC with 62.5/125 µm at 1 dB/km maximum	-	-	-
• for glass FOC with 62.5/125 µm at 3.5 dB/km maximum	3 km	3 km	3 km
• for PCF FOC with 200/230 µm at 10 dB/km maximum	-	-	-
• for POF FOC with 980/1 000 µm at 230 dB/km maximum	-	-	-
<b>Signal-Inputs/outputs</b>			
Operating voltage of signaling contacts at DC rated value	24 V	24 V	24 V
Operating current of signaling contacts at DC maximum	0.1 A	0.1 A	0.1 A
<b>Supply voltage, current consumption, power loss</b>			
Type of supply voltage	DC	DC	DC
Supply voltage for DC			
• rated value	24 V	24 V	24 V
• minimum	18.8 V	18.8 V	18.8 V
• maximum	28.8 V	28.8 V	28.8 V
Product component fusing at power supply input	Yes	Yes	Yes
Type of fusing at input for supply voltage	-	-	-
Consumed current At 24 V with DC maximum	0.2 A	0.2 A	0.2 A
Active power loss at 24 V for DC	-	-	-

**Technical specifications (continued)**

Article No.	6GK1503-2CB00	6GK1503-3CB00	6GK1503-4CB00
Product-type designation	PROFIBUS OLM G11	PROFIBUS OLM G12	PROFIBUS OLM G22
<b>Permitted ambient conditions</b>			
Ambient temperature			
• during operating	0 ... 60 °C	0 ... 60 °C	0 ... 60 °C
• during storage	-40 ... +70 °C	-40 ... +70 °C	-40 ... +70 °C
• during transport	-40 ... +70 °C	-40 ... +70 °C	-40 ... +70 °C
Relative humidity at 25 °C without condensation during operating maximum	95 %	95 %	95 %
Protection class IP	IP40	IP40	IP40
<b>Design, dimensions and weight</b>			
Design	compact	compact	compact
Width	39.5 mm	39.5 mm	39.5 mm
Height	112 mm	112 mm	112 mm
Depth	74.5 mm	74.5 mm	74.5 mm
Net weight	340 g	340 g	340 g
Mounting type			
• 35 mm DIN rail mounting	Yes	Yes	Yes
• wall mounting	Yes	Yes	Yes
<b>Product properties, functions, components general</b>			
Product function Ring redundancy	Yes	Yes	Yes
<b>Standards, specifications, approvals</b>			
Standard			
• for EMC from FM	FM3611: Class 1, Divison 2, Group A, B, C, D / T4, Class 1, Zone 2, Group IIC, T4	FM3611: Class 1, Divison 2, Group A, B, C, D / T4, Class 1, Zone 2, Group IIC, T4	FM3611: Class 1, Divison 2, Group A, B, C, D / T4, Class 1, Zone 2, Group IIC, T4
• for hazardous zone	EN 60079-0: 2006, EN60079-15: 2005, EN60079-28: 2007, II 3 (2) G Ex nA [opis] IIC T4 KEMA 09 ATEX 0173X	EN 60079-0: 2006, EN60079-15: 2005, EN60079-28: 2007, II 3 (2) G Ex nA [opis] IIC T4 KEMA 09 ATEX 0173X	EN 60079-0: 2006, EN60079-15: 2005, EN60079-28: 2007, II 3 (2) G Ex nA [opis] IIC T4 KEMA 09 ATEX 0173X
• for safety of CSA and UL	UL 60950-1, CSA C22.2 Nr. 60950-1	UL 60950-1, CSA C22.2 Nr. 60950-1	UL 60950-1, CSA C22.2 Nr. 60950-1
• for hazardous area of CSA and UL	UL 1604 and UL 2279-15 (Hazardous Location), CSA C22.2 No. 213-M1987, Class 1 / Division 2 / Group A, B, C, D / T4, Class 1 / Zone 2 / Group IIC / T4	UL 1604 and UL 2279-15 (Hazardous Location), CSA C22.2 No. 213-M1987, Class 1 / Division 2 / Group A, B, C, D / T4, Class 1 / Zone 2 / Group IIC / T4	UL 1604 and UL 2279-15 (Hazardous Location), CSA C22.2 No. 213-M1987, Class 1 / Division 2 / Group A, B, C, D / T4, Class 1 / Zone 2 / Group IIC / T4
• for emitted interference	EN 61000-6-4 (Class A)	EN 61000-6-4 (Class A)	EN 61000-6-4 (Class A)
• for interference immunity	EN 61000-6-2	EN 61000-6-2	EN 61000-6-2
Verification of suitability	EN 61000-6-2, EN 61000-6-4	EN 61000-6-2, EN 61000-6-4	EN 61000-6-2, EN 61000-6-4
• CE mark	Yes	Yes	Yes
• C-Tick	Yes	Yes	Yes
Marine classification association			
• American Bureau of Shipping Europe Ltd. (ABS)	Yes	Yes	Yes
• Bureau Veritas (BV)	Yes	Yes	Yes
• Det Norske Veritas (DNV)	Yes	Yes	Yes
• Germanische Lloyd (GL)	Yes	Yes	Yes
• Lloyds Register of Shipping (LRS)	Yes	Yes	Yes
• Nippon Kaiji Kyokai (NK)	Yes	Yes	Yes

**PROFIBUS**

## Optical networks with OLM

## OLM Optical Link Module

**Technical specifications** (continued)

Article No.	6GK1503-2CC00	6GK1503-3CC00	6GK1503-3CD00
Product-type designation	PROFIBUS OLM G11-1300	PROFIBUS OLM G12-1300	PROFIBUS OLM G12 EEC
<b>Transmission rate</b>			
Transfer rate			
• with PROFIBUS	9.6 kbit/s ... 12 Mbit/s	9.6 kbit/s ... 12 Mbit/s	9.6 kbit/s ... 12 Mbit/s
• With PROFIBUS PA	45.45 kbit/s	45.45 kbit/s	45.45 kbit/s
<b>Interfaces</b>			
Number of electrical/optical connections for network components or terminal equipment maximum	2	3	3
Number of electrical connections			
• for network components and terminal equipment	1	1	1
• for measuring instrument	1	1	1
• for signaling contact	1	1	1
• for power supply	1	1	1
• for redundant power supply	1	1	1
Design of electrical connection			
• for network components and terminal equipment	9-pin Sub-D socket	9-pin Sub-D socket	9-pin Sub-D socket
• for measuring device	2-pole terminal block	2-pole terminal block	2-pole terminal block
• for power supply and signaling contact	5-pole terminal block	5-pole terminal block	5-pole terminal block
Number of optical interfaces for optical waveguide	1	2	2
Design of the optical interface for optical waveguide	BFOC port	BFOC port	BFOC port
<b>Optical data</b>			
Damping ratio of FOC transmission link			
• for glass FOC with 10/125 µm or 9/125 µm at 0.5 dB/km maximum	8 dB	8 dB	-
• for glass FOC with 50/125 µm at 3 dB/km maximum	-	-	10 dB
• for glass FOC with 62.5/125 µm			
- at 1 dB/km maximum	-	-	-
- at 3.5 dB/km maximum	-	-	12 dB
• for PCF FOC with 200/230 µm at 10 dB/km	-	-	-
• for POF FOC with 980/1 000 µm at 230 dB/km	-	-	-
Signal delay time in bit time	6.5 bit	6.5 bit	6.5 bit
Injectable optical power relating to 1 mW			
• for glass FOC with 10/125 µm or 9/125 µm at 0.5 dB/km	-19 dB	-19 dB	-
• for glass FOC with 50/125 µm at 3 dB/km	-	-	-16 dB
• for glass FOC with 62.5/125 µm			
- at 1 dB/km	-	-	-
- at 3.5 dB/km	-	-	-13 dB
• of FOC transmission link			
- for PCF FOC with 200/230 µm at 10 dB/km	-	-	-
- for POF FOC with 980/1 000 µm at 230 dB/km	-	-	-

**Technical specifications** (continued)

Article No.	6GK1503-2CC00	6GK1503-3CC00	6GK1503-3CD00
Product-type designation	PROFIBUS OLM G11-1300	PROFIBUS OLM G12-1300	PROFIBUS OLM G12 EEC
Optical sensitivity relating to 1 mW			
• for glass FOC with 10/125 µm or 9/125 µm at 0.5 dB/km	-29 dB	-29 dB	-
• for glass FOC with 50/125 µm at 3 dB/km	-	-	-28 dB
• for glass FOC with 62.5/125 µm			
- at 1 dB/km	-	-	-
- at 3.5 dB/km	-	-	-28 dB
• of FOC transmission link			
- for PCF FOC with 200/230 µm at 10 dB/km	-	-	-
- for POF FOC with 980/1 000 µm at 230 dB/km	-	-	-
Wavelength			
• for glass FOC with 10/125 µm or 9/125 µm compatible with interface at 0.5 dB/km	1 310 nm	1 310 nm	-
• for glass FOC with 50/125 µm compatible with interface at 3 dB/km	-	-	860 nm
• for glass FOC with 62.5/125 µm compatible with interface			
- at 1 dB/km	-	-	-
- at 3.5 dB/km	-	-	860 nm
• of FOC transmission link			
- for PCF FOC with 200/230 µm at 10 dB/km	-	-	-
- for POF FOC with 980/1 000 µm at 230 dB/km	-	-	-
Cable length			
• for glass FOC with 10/125 µm or 9/125 µm at 0.5 dB/km maximum	15 km	15 km	-
• for glass FOC with 50/125 µm at 3 dB/km maximum	-	-	3 km
• for glass FOC with 62.5/125 µm at 1 dB/km maximum	-	-	-
• for glass FOC with 62.5/125 µm at 3.5 dB/km maximum	-	-	3 km
• for PCF FOC with 200/230 µm at 10 dB/km maximum	-	-	-
• for POF FOC with 980/1 000 µm at 230 dB/km maximum	-	-	-
<b>Signal-Inputs/outputs</b>			
Operating voltage of signaling contacts at DC rated value	24 V	24 V	24 V
Operating current of signaling contacts at DC maximum	0.1 A	0.1 A	0.1 A
<b>Supply voltage, current consumption, power loss</b>			
Type of supply voltage	DC	DC	DC
Supply voltage for DC			
• rated value	24 V	24 V	24 V
• minimum	18.8 V	18.8 V	18.8 V
• maximum	28.8 V	28.8 V	28.8 V
Product component fusing at power supply input	Yes	Yes	Yes
Type of fusing at input for supply voltage	-	-	-
Consumed current At 24 V with DC maximum	0.2 A	0.2 A	0.2 A
Active power loss at 24 V for DC	-	-	-

**PROFIBUS**

## Optical networks with OLM

## OLM Optical Link Module

**Technical specifications** (continued)

Article No.	6GK1503-2CC00	6GK1503-3CC00	6GK1503-3CD00
Product-type designation	PROFIBUS OLM G11-1300	PROFIBUS OLM G12-1300	PROFIBUS OLM G12 EEC
<b>Permitted ambient conditions</b>			
Ambient temperature			
• during operating	0 ... 60 °C	0 ... 60 °C	-25 ... +60 °C
• during storage	-40 ... +70 °C	-40 ... +70 °C	-40 ... +70 °C
• during transport	-40 ... +70 °C	-40 ... +70 °C	-40 ... +70 °C
Relative humidity at 25 °C without condensation during operating maximum	95 %	95 %	95 %
Protection class IP	IP40	IP40	IP40
<b>Design, dimensions and weight</b>			
Design	compact	compact	compact
Width	39.5 mm	39.5 mm	39.5 mm
Height	112 mm	112 mm	112 mm
Depth	74.5 mm	74.5 mm	74.5 mm
Net weight	340 g	340 g	340 g
Mounting type			
• 35 mm DIN rail mounting	Yes	Yes	Yes
• wall mounting	Yes	Yes	Yes
<b>Product properties, functions, components general</b>			
Product function Ring redundancy	Yes	Yes	Yes
<b>Standards, specifications, approvals</b>			
Standard			
• for EMC from FM	FM3611: Class 1, Division 2, Group A, B, C, D / T4, Class 1, Zone 2, Group IIC, T4	FM3611: Class 1, Division 2, Group A, B, C, D / T4, Class 1, Zone 2, Group IIC, T4	FM3611: Class 1, Division 2, Group A, B, C, D / T4, Class 1, Zone 2, Group IIC, T4
• for hazardous zone	EN 60079-0: 2006, EN60079-15: 2005, II 3 G Ex nA II T4 KEMA 07 ATEX 0003X	EN 60079-0: 2006, EN60079-15: 2005, II 3 G Ex nA II T4 KEMA 07 ATEX 0003X	EN 60079-0: 2006, EN60079-15: 2005, EN60079-28: 2007, II 3 (2) G Ex nA [opis] IIC T4 KEMA 09 ATEX 0173X
• for safety of CSA and UL	UL 60950-1, CSA C22.2 Nr. 60950-1	UL 60950-1, CSA C22.2 Nr. 60950-1	UL 60950-1, CSA C22.2 Nr. 60950-1
• for hazardous area of CSA and UL	UL 1604 and UL 2279-15 (Hazardous Location), CSA C22.2 No. 213-M1987, Class 1 / Division 2 / Group A, B, C, D / T4, Class 1 / Zone 2 / Group IIC / T4	UL 1604 and UL 2279-15 (Hazardous Location), CSA C22.2 No. 213-M1987, Class 1 / Division 2 / Group A, B, C, D / T4, Class 1 / Zone 2 / Group IIC / T4	UL 1604 and UL 2279-15 (Hazardous Location), CSA C22.2 No. 213-M1987, Class 1 / Division 2 / Group A, B, C, D / T4, Class 1 / Zone 2 / Group IIC / T4
• for emitted interference	EN 61000-6-4 (Class A)	EN 61000-6-4 (Class A)	EN 61000-6-4 (Class A)
• for interference immunity	EN 61000-6-2	EN 61000-6-2	EN 61000-6-2
Verification of suitability	EN 61000-6-2, EN 61000-6-4	EN 61000-6-2, EN 61000-6-4	EN 61000-6-2, EN 61000-6-4
• CE mark	Yes	Yes	Yes
• C-Tick	Yes	Yes	Yes
Marine classification association			
• American Bureau of Shipping Europe Ltd. (ABS)	Yes	Yes	Yes
• Bureau Veritas (BV)	Yes	Yes	Yes
• Det Norske Veritas (DNV)	Yes	Yes	Yes
• Germanische Lloyd (GL)	Yes	Yes	Yes
• Lloyds Register of Shipping (LRS)	Yes	Yes	Yes
• Nippon Kaiji Kyokai (NK)	Yes	Yes	Yes

Ordering data	Article No.	Article No.
<b>PROFIBUS OLM/P11</b> Optical link module with 1 x RS 485 and 1 x plastic fiber-optic interface (2 BFOC sockets), with signaling contact and measuring output incl. 2 BFOC plugs for plastic fiber-optic cables	<b>6GK1503-2CA00</b>	<b>PROFIBUS OLM/G11-1300</b> Optical link module with 1 x RS 485 and 1 x glass fiber-optic interface (2 BFOC sockets), 1 300 nm wavelength for large distances up to 15 km, with signaling contact and measuring output
<b>PROFIBUS OLM/P12</b> Optical link module with 1 x RS 485 and 2 x plastic fiber-optic interface (4 BFOC sockets), with signaling contact and measuring output incl. 4 BFOC plugs for plastic fiber-optic cables	<b>6GK1503-3CA00</b>	<b>PROFIBUS OLM/G12-1300</b> Optical link module with 1 x RS 485 and 2 x glass fiber-optic interface (4 BFOC sockets), 1 300 nm wavelength for large distances up to 15 km, with signaling contact and measuring output
<b>PROFIBUS OLM/P22</b> Optical link module with 2 x RS 485 and 2 x plastic fiber-optic interface (4 BFOC sockets), with signaling contact and measuring output incl. 4 BFOC plugs for plastic fiber-optic cables	<b>6GK1503-4CA00</b>	<b>PROFIBUS OLM/G12 EEC</b> Optical link module with 1 x RS 485 and 2 x glass fiber-optic interface (4 BFOC sockets), for standard distances up to 3 000 m, for extended temperature range -25 °C to +60 °C, with signaling contact and measuring output
<b>PROFIBUS OLM/G11</b> Optical link module with 1 x RS 485 and 1 x glass fiber-optic interface (2 BFOC sockets), for standard distances, with signaling contact and measuring output	<b>6GK1503-2CB00</b>	<b>PROFIBUS OLM mounting plate</b> For wall mounting of PROFIBUS OLM V4
<b>PROFIBUS OLM/G12</b> Optical link module with 1 x RS 485 and 2 x glass fiber-optic interface (4 BFOC sockets), for standard distances up to 3 000 m, with signaling contact and measuring output	<b>6GK1503-3CB00</b>	<b>SITOP compact 24 V/ 0.6 A</b> 1-phase power supply with wide-range input 85 – 264 V AC/110 – 300 V DC, stabilized output voltage 24 V, rated output current value 0.6 A, slim design
<b>PROFIBUS OLM/G22</b> Optical link module with 2 x RS 485 and 2 x glass fiber-optic interface (4 BFOC sockets), for standard distances up to 3 000 m, with signaling contact and measuring output	<b>6GK1503-4CB00</b>	<b>6GK1503-2CC00</b>
		<b>6GK1503-3CC00</b>
		<b>6GK1503-3CD00</b>
		<b>6GK1503-8AA00</b>
		<b>6EP1331-5BA00</b>

## PROFIBUS

### Optical networks with OBT and integrated interface

#### Plastic and PCF fiber-optic cable

##### Overview



- Electrical isolation of DP devices
- Protection of the transmission path against electromagnetic interference
- Up to 50 m cable length with plastic fiber-optic cables and up to 300 m with PCF fiber-optic cables
- Rugged fiber-optic standard cables, designed for industrial applications
- Hybrid cable for the shared transmission of data and power supply
- Extensive approvals (UL)

##### Benefits



- Plastic and PCF fiber-optic cables can be pre-assembled on site
- Easy connector assembly on site
- Time savings on start-up thanks to pre-assembled cables
- Protection of the transmission path against electromagnetic interference
- Tap-proof, because the cable does not radiate
- A cable for the shared transmission of data and power

##### Application

SIMATIC NET plastic and PCF fiber-optic conductors are used to construct optical indoor PROFIBUS DP networks.

Plastic fiber-optic cables and segmented PCF fiber-optic cables can be assembled easily on site with 2 x 2 simplex plugs. The maximum cable length between two DP devices is 50 m.

Longer cable lengths up to 300 m can be achieved using PCF fiber-optic cables. These cables are also available preassembled with 4 simplex plugs.

Devices with integrated optical interface (Simplex connection technology) include, for example, OBT, CP 342-5 FO, CP 5613 FO, IM 153-2 FO, IM 467 FO.

##### Design

Different types of plastic and PCF fiber-optic cables are offered:

- **Plastic FOC, duplex core;**  
Two flat cores with PVC inner sheath and without outer sheath for indoor applications with low mechanical stress such as laboratory setups or inside cabinets. Cable lengths up to 50 m.
- **Plastic FOC, standard cable;**  
Rugged round cable with violet PVC outer sheath and Kevlar tension components as well as two plastic fibers with a rugged polyamide inner sheath. For indoor applications with cable lengths up to 50 m.
- **PCF fiber-optic cable, standard cables:**
  - PCF Fiber Optic standard cable;  
rugged round cable with violet PVC outer sheath and Kevlar tension components for indoor applications with cable lengths of up to 300 m.  
The cable is not suitable for assembly in the field (only available pre-assembled with an insertion tool)
  - PCF Standard Cable GP (general purpose);  
rugged round cable with green PVC outer sheath and Kevlar tension elements for indoor and outdoor applications with cable lengths of up to 300 m;  
the cable is suitable for assembly in the field.
- **PCF fiber-optic trailing cable;**  
Rugged round cable with green outer sheath and Kevlar tension elements for trailing cable applications with cable lengths of up to 300 m. The cable is suitable for assembly in the field.  
Two cable variants are available for this application:
  - PCF Trailing Cable;  
cable for high mechanical stress, PUR outer sheath, no UL approval
  - PCF Trailing Cable GP (general purpose);  
cable for low mechanical stress, PVC outer sheath, with UL approval



## Technical specifications

Article No.	6XV1821-2AN50	6XV1821-0AH10	6XV1821-1CN50
Product-type designation	PROFIBUS Plastic Fiber Optic Duplex Core	PROFIBUS Plastic Fiber Optic standard cable	PROFIBUS PCF Fiber Optic standard cable
Product description	Fiber-optic cable with polyoptical fiber (flat dual cores), 50m ring, unassembled	Fiber-optic cable with polyoptical fiber, sold by the meter, unassembled	PCF fiber-optic cable with plastic cladding, preferred length, preassembled
Acceptability for application	Indoor applications with low mechanical stress (e.g. laboratory setups or within cabinets), cable lengths up to 50 m	Cable for indoor applications	Cable for indoor applications
Version of the assembled FO cable	Can be fitted with four Simplex connectors	Can be fitted with four Simplex connectors	Can be fitted with four Simplex connectors
Cable designation	V-2Y 2x1 P 980/1 000	I-V4Y(ZN)Y 2P 980/1 000	I-V(ZN)Y 2K 200/230
Cable length	50 m	-	50 m
<b>Optical data</b>			
Damping ratio per length at 650 nm maximum	0.01 dB/m	0.16 dB/m	0.01 dB/m
Bandwidth length product at 650 nm	1 GHz·m	1 GHz·m	17 GHz·m
<b>Mechanical data</b>			
Number of fibers per FOC core	1	1	1
Number of FOC cores per FOC cable	2	2	2
Version of the FO conductor fiber	Step index fiber 980/1 000 µm	Step index fiber 980/1 000 µm	Step index fiber 200/230 µm
Design of the FOC core	-	-	-
Design of the fiber-optic cable	-	-	-
Outer diameter			
• of optical fibers	980 µm	980 µm	200 µm
• of the optical fiber sheath	1 000 µm	1 000 µm	230 µm
• of the FOC core sheath	2.2 mm	2.2 mm	2.2 mm
• of the cable	-	7.8 mm	4.7 mm
Symmetrical deviation			
• of the outer diameter of the FOC core sheath	0.1 mm	0.1 mm	0.1 mm
• of the outer diameter of the line	-	0.3 mm	-
Width of the cable sheath	-	-	-
Symmetrical tolerance of width of cable sheath	-	-	-
Thickness of the cable sheath	-	-	-
Symmetrical tolerance of thickness of cable sheath	-	-	-
Material			
• of the fiber-optic cable core	Polymethylmethacrylate (PMMA)	Polymethylmethacrylate (PMMA)	Quartz glass
• of the optical fiber sheath	Fluoridated special polymer	Fluoridated special polymer	Fluoridated special polymer
• of the FOC core sheath	PE	PA	PVC
• of the fiber-optic cable sheath	-	PVC	PVC
• of the strain relief	-	Kevlar fibers	Kevlar fibers
Color			
• of the FOC core sheath	Gray	Orange/black	Orange/black
• of the cable sheath	-	Violet	Violet

**PROFIBUS**

## Optical networks with OBT and integrated interface

## Plastic and PCF fiber-optic cable

**Technical specifications** (continued)

Article No.	6XV1821-2AN50	6XV1821-0AH10	6XV1821-1CN50
Product-type designation	PROFIBUS Plastic Fiber Optic Duplex Core	PROFIBUS Plastic Fiber Optic standard cable	PROFIBUS PCF Fiber Optic standard cable
Bending radius			
• with single bend minimum permissible	25 mm	100 mm	47 mm
• with multiple bends minimum permissible	25 mm	150 mm	70 mm
• with continuous bending	-	-	-
Number of bending cycles	-	-	-
Number of torsion cycles in the case of torsion by $\pm 360^\circ$ on 1 m cable length	-	-	-
Traction stress maximum	10 N	100 N	200 N
Short-term shear force per length	30 N/cm	100 N/cm	100 N/cm
Continuous lateral force per length	400 N/m	-	-
Weight per length	7.6 kg/km	65 kg/km	22 kg/km
<b>Permitted ambient conditions</b>			
Ambient temperature			
• during operating	-55 ... +85 °C	-30 ... +70 °C	-30 ... +70 °C
• during storage	-55 ... +85 °C	-30 ... +70 °C	-30 ... +70 °C
• during transport	-55 ... +85 °C	-30 ... +70 °C	-30 ... +70 °C
• during installation	-5 ... +50 °C	-5 ... 50 °C	-5 ... +50 °C
Ambient condition for (standard) operation mode	-	-	-
Protection class IP	-	-	IP20
Burning behaviour	flame-retardant in accordance with flame test VW-1 acc. to UL 1581	flame resistant according to IEC 60332-1-2	flame resistant according to IEC 60332-1-2
Chemical resistance			
• to mineral oil	Conditional resistance	Conditional resistance	Conditional resistance
• to grease	Conditional resistance	Conditional resistance	Conditional resistance
• to water	-	-	-
Radiological resistance to UV radiation	Not resistant	Not resistant	Not resistant
<b>Product properties, functions, components general</b>			
Product feature			
• halogen-free	Yes	No	No
• silicon-free	Yes	Yes	Yes
Product component Rodent protection	No	No	No
Cable length for POF FOC			
• for Industrial Ethernet maximum	-	-	-
• for PROFIBUS maximum	80 m	80 m	-
<b>Standards, specifications, approvals</b>			
Verification of suitability	-	UL approval: OFN (NEC Article 770, UL 1651) / CSA approval: OFN (CSA standard C22.2 No232-M1988)	-
• RoHS conformity	Yes	Yes	Yes

## Technical specifications (continued)

Article No.	6XV1861-2A	6XV1861-2C	6XV1861-2D
Product-type designation	PCF Standard Cable GP	PCF Trailing Cable	PCF Trailing Cable GP
Product description	PCF fiber-optic cable with plastic cladding, sold by the meter, unassembled	PCF fiber-optic cable with plastic cladding, sold by the meter, unassembled	PCF fiber-optic cable with plastic cladding, sold by the meter, unassembled
Acceptability for application	Cable for fixed installation for indoor and outdoor use, UL approval	Cable for use with high mechanical stress and moving applications (e.g. trailing cables), without UL approval	Cable for use with high mechanical stress and moving applications (e.g. trailing cables), UL approval
Version of the assembled FO cable	Can be fitted with SC RJ, SC RJ Plug PRO, BFOC and Simplex connectors	Can be fitted with SC RJ, SC RJ Plug PRO, BFOC and Simplex connectors	Can be fitted with SC RJ, SC RJ Plug PRO, BFOC and Simplex connectors
Cable designation	AT-V(ZN)YY 2K 200/230	AT-V(ZN)Y(ZN)11Y 2K 200/230	AT-V(ZN)Y(ZN)Y 2K 200/230
Cable length	-	-	-
<b>Optical data</b>			
Damping ratio per length at 660 nm maximum	10 dB/km	10 dB/km	10 dB/km
Bandwidth length product at 650 nm	17 GHz·m	17 GHz·m	17 GHz·m
<b>Mechanical data</b>			
Number of fibers per FOC core	1	1	1
Number of FOC cores per FOC cable	2	2	2
Version of the FO conductor fiber	Step index fiber 200/230 µm	Step index fiber 200/230 µm	Step index fiber 200/230 µm
Design of the FOC core	-	-	-
Design of the fiber-optic cable	-	-	-
Outer diameter			
• of optical fibers	200 µm	200 µm	200 µm
• of the optical fiber sheath	230 µm	230 µm	230 µm
• of the FOC core sheath	2.2 mm	2.2 mm	2.2 mm
• of the cable	7.2 mm	8.8 mm	8.8 mm
Symmetrical deviation			
• of the outer diameter of the FOC core sheath	0.1 mm	0.1 mm	0.1 mm
• of the outer diameter of the line	0.5 mm	0.5 mm	0.5 mm
Width of the cable sheath	-	-	-
Symmetrical tolerance of width of cable sheath	-	-	-
Thickness of the cable sheath	-	-	-
Symmetrical tolerance of thickness of cable sheath	-	-	-
Material			
• of the fiber-optic cable core	Quartz glass	Quartz glass	Quartz glass
• of the optical fiber sheath	Special polymer	Special polymer	Special polymer
• of the FOC core sheath	PVC	PVC	PVC
• of the fiber-optic cable sheath	PVC	PUR	PVC
• of the strain relief	Aramide fibers	Aramide fibers	Aramide fibers
Color			
• of the FOC core sheath	Orange/black	Orange/black	Orange/black
• of the cable sheath	green	green	green
Bending radius			
• with single bend minimum permissible	70 mm	130 mm	130 mm
• with multiple bends minimum permissible	105 mm	175 mm	175 mm
• with continuous bending	-	-	-
Number of bending cycles	-	5 000 000	5 000 000
Number of torsion cycles in the case of torsion by ± 360° on 1 m cable length	-	-	-
Traction stress maximum	100 N	800 N	800 N
Short-term shear force per length	500 N/cm	500 N/cm	500 N/cm
Continuous lateral force per length	300 N/cm	300 N/cm	300 N/cm
Weight per length	45 kg/km	85 kg/km	85 kg/km

# PROFIBUS

## Optical networks with OBT and integrated interface

### Plastic and PCF fiber-optic cable

#### Technical specifications (continued)

Article No.	6XV1861-2A	6XV1861-2C	6XV1861-2D
Product-type designation	PCF Standard Cable GP	PCF Trailing Cable	PCF Trailing Cable GP
<b>Permitted ambient conditions</b>			
Ambient temperature			
• during operating	-40 ... +90 °C	-25 ... +75 °C	-25 ... +75 °C
• during storage	-40 ... +90 °C	-30 ... +75 °C	-30 ... +75 °C
• during transport	-40 ... +90 °C	-30 ... +75 °C	-30 ... +75 °C
• during installation	-5 ... +50 °C	-5 ... +50 °C	-5 ... +50 °C
Ambient condition for (standard) operation mode	-	-	-
Protection class IP	-	-	-
Burning behaviour	flame resistant according to IEC 60332-1-2 and IEC 60332-3-22 (Cat. A)	flame-retardant	flame resistant according to IEC 60332-1-2 and IEC 60332-3-22 (Cat. A)
Chemical resistance			
• to mineral oil	Conditional resistance	resistant	Conditional resistance
• to grease	Conditional resistance	resistant	Conditional resistance
• to water	Conditional resistance	Conditional resistance	Conditional resistance
Radiological resistance to UV radiation	resistant	resistant	resistant
<b>Product properties, functions, components general</b>			
Product feature			
• halogen-free	No	No	No
• silicon-free	Yes	Yes	Yes
Product component Rodent protection	No	No	No
Cable length for PCF FOC			
• for Industrial Ethernet maximum	100 m	100 m	100 m
• for PROFIBUS maximum	400 m	400 m	400 m
<b>Standards, specifications, approvals</b>			
Verification of suitability	UL approval: OFN (NEC Article 770, UL 1651) / CSA approval: OFN 90 Cel, FT1, FT4 (CSA standard C22.2 No232-M1988)	-	UL approval: OFN (NEC Article 770, UL 1651) / CSA approval: OFN 90 Cel, FT1, FT4 (CSA standard C22.2 No232-M1988)
• RoHS conformity	Yes	Yes	Yes

#### Ordering data

Ordering data	Article No.	Ordering data	Article No.
<b>PROFIBUS Plastic Fiber Optic standard cable</b> Rugged round cable with 2 plastic fiber-optic cores, PVC outer sheath and PA inner sheath, for indoor use; without connector <ul style="list-style-type: none"> <li>Sold by the meter</li> <li>50 m ring</li> <li>100 m ring</li> </ul>	<b>6XV1821-0AH10</b> <b>6XV1821-0AN50</b> <b>6XV1821-0AT10</b>	<b>PROFIBUS Plastic Fiber Optic stripping tool set</b> Tools for removing the outer sheath or core sheath of Plastic Fiber Optic cables	<b>6GK1905-6PA10</b>
<b>PROFIBUS Plastic Fiber Optic duplex core</b> Plastic fiber-optic cable with 2 cores, PVC outer sheath, for use in environments with low mechanical stress; without connector <ul style="list-style-type: none"> <li>50 m ring</li> </ul>	<b>6XV1821-2AN50</b>	<b>PROFIBUS PCF Fiber Optic standard cable</b> PCF fiber-optic cable with 2 cores, PVC outer sheath, for covering larger distances up to 300 m, for connecting devices to the optical PROFIBUS DP  <u>Preferred lengths</u> Precut/preassembled with 2 × 2 Simplex connectors, arm length 30 cm each, with aid for pulling in at one end <ul style="list-style-type: none"> <li>50 m</li> <li>75 m</li> <li>100 m</li> <li>150 m</li> <li>200 m</li> <li>250 m</li> <li>300 m</li> </ul>	<b>6XV1821-1CN50</b> <b>6XV1821-1CN75</b> <b>6XV1821-1CT10</b> <b>6XV1821-1CT15</b> <b>6XV1821-1CT20</b> <b>6XV1821-1CT25</b> <b>6XV1821-1CT30</b>
<b>PROFIBUS Plastic Fiber Optic simplex plug/polishing set</b> 100 simplex connectors and 5 polishing sets for assembling PROFIBUS plastic fiber optic cables for the optical PROFIBUS DP	<b>6GK1901-0FB00-0AA0</b>		

Ordering data	Article No.		Article No.
<b>PROFIBUS PCF Standard Cable GP 200/230</b> Standard cable, segmentable, sold by the meter; max. quantity 2 000 m; minimum order 20 m;  Preferred lengths; pre-assembled with 4 Simplex connectors <ul style="list-style-type: none"> <li>• 50 m</li> <li>• 75 m</li> <li>• 100 m</li> <li>• 150 m</li> <li>• 200 m</li> <li>• 250 m</li> <li>• 300 m</li> </ul>	<b>6XV1861-2A</b>  <b>6XV1861-7AN50</b> <b>6XV1861-7AN75</b> <b>6XV1861-7AT10</b> <b>6XV1861-7AT15</b> <b>6XV1861-7AT20</b> <b>6XV1861-7AT25</b> <b>6XV1861-7AT30</b>	<b>Plug-in adapter</b>  For assembling the plastic Simplex connector in combination with IM 467 FO, CP 342-5 FO, IM 151 FO and IM 153-2 FO, 50 units  <b>Termination Kit for Simplex Plug</b> Assembly case for local assembly of PCF Simplex connectors; comprising a stripping tool, buffer stripping tool, Kevlar cutters, fiber breaking tool, crimping tool and microscope  <b>Termination Kit for BFOC Plug</b> Assembly case for local assembly of BFOC connectors; comprising a stripping tool, buffer stripping tool, Kevlar cutters, fiber breaking tool, and microscope  <b>Simplex Plug</b> Crimp connector with cleaning materials; 50 connectors for assembly on PCF fiber-optic cables on site  <b>BFOC Plug</b> Screw connector with cleaning materials; 20 connectors for assembly on PCF fiber-optic cables on site  <b>SIMATIC NET Manual Collection</b>  Electronic manuals for communication systems, communication protocols, and communication products; on DVD; German/English	<b>6ES7195-1BE00-0XA0</b>  <b>6GK1900-0KL00-0AA0</b>  <b>6GK1900-0HL00-0AA0</b>  <b>6GK1900-0KB00-0AC0</b>  <b>6GK1900-0HB00-0AC0</b>  <b>6GK1975-1AA00-3AA0</b>
<b>PROFIBUS PCF Trailing Cable 200/230</b> Trailing cable, segmentable, sold by the meter; max. quantity 2 000 m; minimum order 20 m;  Preferred lengths; pre-assembled with 4 Simplex connectors <ul style="list-style-type: none"> <li>• 50 m</li> <li>• 75 m</li> <li>• 100 m</li> <li>• 150 m</li> <li>• 200 m</li> <li>• 250 m</li> <li>• 300 m</li> </ul>	<b>6XV1861-2C</b>  <b>6XV1861-7CN50</b> <b>6XV1861-7CN75</b> <b>6XV1861-7CT10</b> <b>6XV1861-7CT15</b> <b>6XV1861-7CT20</b> <b>6XV1861-7CT25</b> <b>6XV1861-7CT30</b>		
<b>PROFIBUS PCF Trailing Cable GP 200/230</b> Trailing cable, segmentable, sold by the meter; max. length 2 000 m; minimum order quantity 20 m;  Preferred lengths; pre-assembled with 4 Simplex connectors <ul style="list-style-type: none"> <li>• 50 m</li> <li>• 75 m</li> <li>• 100 m</li> <li>• 150 m</li> <li>• 200 m</li> <li>• 250 m</li> <li>• 300 m</li> </ul>	<b>6XV1861-2D</b>  <b>6XV1861-7DN50</b> <b>6XV1861-7DN75</b> <b>6XV1861-7DT10</b> <b>6XV1861-7DT15</b> <b>6XV1861-7DT20</b> <b>6XV1861-7DT25</b> <b>6XV1861-7DT30</b>		

### More information

You can order components supplementary to the SIMATIC NET cabling range from your local contact.

Technical advice on this subject is available from:

J. Hertlein  
 I IA SC CI PRM 4  
 Phone: +49 (911) 750-4465  
 E-mail: [juergen.hertlein@siemens.com](mailto:juergen.hertlein@siemens.com)

## PROFIBUS

### Optical networks with OBT and integrated interface

#### PCF-FOC termination kit

##### Overview



- Compact, rugged assembly case for PCF fiber-optic cables
- Special versions for easy assembly of HP Simplex and BFOC plugs on PCF fiber-optic cables
- The quality of the assembly can be checked using the enclosed microscope

##### Benefits

**get** Designed for Industry

- Easy installation of the unassembled cables in industrial plants
- Flexible assembly of connectors on PCF fiber-optic cables on site (HP Simplex, BFOC connectors)
- Mistakes are avoided with easy visual inspection of the assembled connector on site using a microscope
- PCF fiber-optic cables are easily repaired on site by installing a new PCF cable

##### Application

SIMATIC NET PCF fiber-optic conductors are used to construct optical indoor and outdoor PROFIBUS DP networks. They are easy to assemble on site with 2 x 2 Simplex connectors or 2 x 2 BFOC connectors. The maximum cable length between two DP devices is 300 m and between two OLMs 400 m.

PROFIBUS DP devices with integrated optical interface (Simplex connection technology) include, for example, OBT, CP 342-5 FO, CP 5613 FO, IM 153-2 FO, IM 467 FO.

##### Design

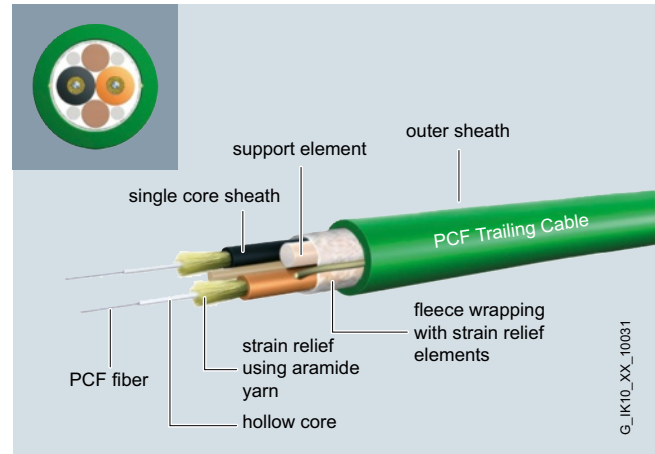

Two versions of the assembly case are available for PCF fiber-optic cables:

- Assembly case for HP Simplex connectors; for on-site pre-assembly of HP Simplex connectors; comprising a stripping tool, buffer stripping tool, Kevlar cutters, fiber breaking tool, crimping tool and microscope
- Assembly case for BFOC connectors; for on-site pre-assembly of BFOC connectors; comprising a stripping tool, buffer stripping tool, Kevlar cutters, fiber breaking tool and microscope

G\_IK10\_XX\_10031

### Technical specifications

Article No.	6GK1900-0KB00-0AC0	6GK1900-0HB00-0AC0
Product-type designation	PB Simplex Plug PCF	PB BFOC Plug PCF
Product description	Simplex crimp connector for PCF fiber-optic cables with plastic cladding	BFOC screw connector for PCF fiber-optic cables with plastic cladding
Acceptability for application	For connection of PCF fiber-optic cables	For connection of PCF fiber-optic cables
<b>Transmission rate</b>		
Transfer rate		
• 1 for Industrial Ethernet	-	-
• 2 for Industrial Ethernet	-	-
• 3 for Industrial Ethernet	-	-
• with PROFIBUS	9.6 kbit/s ... 12 Mbit/s	9.6 kbit/s ... 12 Mbit/s
<b>Interfaces</b>		
Number of optical interfaces for optical waveguide	1	1
Design of optical connections for network components or terminal devices	Simplex connector	BFOC connector
Design of the electrical connection FastConnect	No	No
<b>Mechanical data</b>		
Material of the enclosure	plastic	Metal and plastic
<b>Design, dimensions and weight</b>		
Type of cable outlet	180 degree cable outlet	180 degree cable outlet
Width	9.4 mm	10 mm
Height	6.1 mm	10 mm
Depth	29.9 mm	10 mm
Net weight	20 g	8 g
<b>Permitted ambient conditions</b>		
Protection class IP	IP20	IP20
Chemical resistance to water	-	-
<b>Product properties, functions, components general</b>		
Product feature silicon-free	Yes	Yes
Product component strain relief	Yes	Yes
<b>Standards, specifications, approvals</b>		
Verification of suitability RoHS conformity	Yes	Yes

**PROFIBUS**

## Optical networks with OBT and integrated interface

## PCF-FOC termination kit

**Ordering data****Article No.****Termination Kit for Simplex connectors**

Assembly case for local assembly of PCF Simplex connectors; comprising a stripping tool, buffer stripping tool, Kevlar cutters, fiber breaking tool, crimping tool and microscope

**6GK1900-0KL00-0AA0****Termination Kit for BFOC connectors**

Assembly case for local assembly of BFOC connectors; comprising a stripping tool, buffer stripping tool, Kevlar cutters, fiber breaking tool, and microscope

**6GK1900-0HL00-0AA0****Connector****Simplex connector**

with cleaning materials; 50 crimp connectors for assembly on PCF fiber-optic cables on site

**6GK1900-0KB00-0AC0****BFOC connector**

with cleaning materials; 20 screw connectors for assembly on PCF fiber-optic cables on site

**6GK1900-0HB00-0AC0****More information**

You can order components supplementary to the SIMATIC NET cabling range from your local contact.

Technical advice on this subject is available from:

J. Hertlein  
 I IA SC CI PRM 4  
 Phone: +49 (911) 750-4465  
 E-mail: [juergen.hertlein@siemens.com](mailto:juergen.hertlein@siemens.com)



## Overview



- For connecting a PROFIBUS station without an integrated fiber-optic cable interface or an RS 485 segment to an optical line
- Quick and easy installation of the plastic fiber-optic cable without the need for special tools

## Benefits



- Option of connecting existing devices or an RS 485 segment with electrical interface to the optical PROFIBUS
- "Socket outlet" for connecting mobile devices (e.g. programming devices) without interruption of the bus
- Time saved through simple and fast connector mounting without special tools

## Application

The OBT (Optical Bus Terminal) is used to connect a PROFIBUS station without integral optical interface or a PROFIBUS DP RS485 segment to an optical line. Existing DP devices are then provided with the advantages of optical data transmission.

The PROFIBUS station is connected to the RS 485 interface of the OBT via a cable terminated at both ends, e.g. connecting cable 830-1T. The OBT is integrated into the optical line using two optical interfaces.

The following optical transmission media can be connected to the OBT:

- Plastic fiber-optic cables can be used up to an individual segment length of 50 m. They can be configured very easily on site with 2 x 2 Simplex connectors.
- PCF<sup>1)</sup> fiber-optic cables can be used for an individual segment length up to 300 m. These cables are preassembled. The OBT supports all PROFIBUS data transmission rates up to 12 Mbit/s.

<sup>1)</sup> Also known as HCS<sup>®</sup> fiber-optic cable:  
HCS<sup>®</sup> is a registered trademark of Lucent Technologies.

## Design

The OBT has a compact plastic housing. It is suitable for mounting on a DIN rail or for wall mounting with a mounting plate with the aid of two holes drilled right through.

The OBT has the following connections:

- 9-pin sub-D socket for connecting the PROFIBUS DP node such as programming device (PG), PC, operator panel (OP), S7-300 or nodes without integral optics, e.g. ET 200S or PROFIBUS DP components from other suppliers or a PROFIBUS DP-RS 485 segment.
- Two optical interfaces for the connection of plastic and PCF fiber-optic cables with Simplex connectors (connection to CP 342-5 FO, CP 5613 FO, IM 153-2 FO, IM 467 FO or to ET 200 with integrated optics)
- 24 V DC infeed for power supply

## Function

- Connection of a station with RS 485 interface via connecting cable 830-1T or PROFIBUS cable with bus connectors (terminated at both ends) or an RS 485 segment
- Provision of an electrical connection point on the optical line (e.g. PG connection for startup and diagnostics).
- Support for all PROFIBUS data rates from 9.6 kbit/s to 12 Mbit/s including 45.45 kbit/s for PROFIBUS PA
- Regeneration of the signals in amplitude and time
- Cascade depth when using user-defined bus parameters up to 126 stations
- Galvanic isolation of the station via fiber optic cable
- Simple diagnostics via LED display for operating voltage as well as for receipt of data CH1, CH2 and CH3.

# PROFIBUS

## Optical networks with OBT and integrated interface

### Optical bus terminal OBT

#### Integration

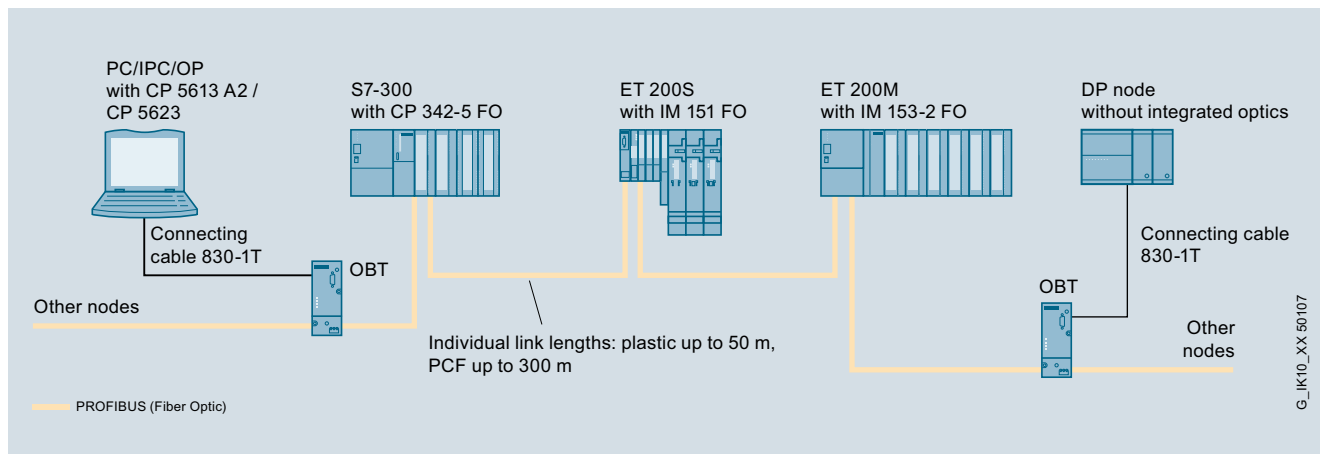

System configuration of optical PROFIBUS DP with PROFIBUS OBT

#### Technical specifications

Article No.	6GK1500-3AA10	Article No.	6GK1500-3AA10
<b>Product-type designation</b>	<b>PROFIBUS OBT</b>	<b>Product-type designation</b>	<b>PROFIBUS OBT</b>
<b>Transmission rate</b>		Optical sensitivity relating to 1 mW of FOC transmission link	
Transfer rate		• for PCF FOC with 200/230 $\mu\text{m}$ at 10 dB/km	-22 dB
• with PROFIBUS	9.6 kbit/s ... 12 Mbit/s	• for POF FOC with 980/1 000 $\mu\text{m}$ at 230 dB/km	-20 dB
• With PROFIBUS PA	45.45 kbit/s	Wavelength of FOC transmission link	
<b>Interfaces</b>		• for PCF FOC with 200/230 $\mu\text{m}$ at 10 dB/km	660 nm
Number of electrical/optical connections for network components or terminal equipment maximum	3	• for POF FOC with 980/1 000 $\mu\text{m}$ at 230 dB/km	660 nm
Number of electrical connections		Cable length	
• for network components and terminal equipment	1	• for PCF FOC with 200/230 $\mu\text{m}$ at 10 dB/km maximum	300 m
• for power supply	1	• for POF FOC with 980/1 000 $\mu\text{m}$ at 230 dB/km maximum	50 m
Design of electrical connection		<b>Supply voltage, current consumption, power loss</b>	
• for network components and terminal equipment	9-pin Sub-D socket	Type of supply voltage	DC
• for power supply	3-pole terminal block	Supply voltage for DC	
Number of optical interfaces for optical waveguide	2	• rated value	24 V
Design of the optical interface for optical waveguide	Duplex port	• minimum	19.2 V
<b>Optical data</b>		• maximum	28.8 V
Damping ratio of FOC transmission link		Product component fusing at power supply input	-
• for PCF FOC with 200/230 $\mu\text{m}$ at 10 dB/km	3 dB	Type of fusing at input for supply voltage	-
• for POF FOC with 980/1 000 $\mu\text{m}$ at 230 dB/km	13 dB	Consumed current At 24 V with DC maximum	-
Signal delay time in bit time	6.5 bit	Active power loss at 24 V for DC	-
Injectable optical power relating to 1 mW of FOC transmission link		<b>Permitted ambient conditions</b>	
• for PCF FOC with 200/230 $\mu\text{m}$ at 10 dB/km	-16 dB	Ambient temperature	
• for POF FOC with 980/1 000 $\mu\text{m}$ at 230 dB/km	-5.9 dB	• during operating	0 ... 60 °C
		• during storage	-40 ... +70 °C
		• during transport	-40 ... +70 °C
		Relative humidity at 25 °C without condensation during operating maximum	95 %
		Protection class IP	IP30

## Technical specifications (continued)

Article No.	<b>6GK1500-3AA10</b>
Product-type designation	<b>PROFIBUS OBT</b>
<b>Design, dimensions and weight</b>	
Design	compact
Width	50.5 mm
Height	138 mm
Depth	78 mm
Net weight	400 g
Mounting type	
• 35 mm DIN rail mounting	Yes
• wall mounting	Yes
<b>Standards, specifications, approvals</b>	
Standard	
• for EMC from FM	FM3611: Class 1, Division 2, Group A, B, C, D / T4, Class 1, Zone 2, Group IIC, T4
• for hazardous zone	EN 60079-0: 2006, EN60079-15: 2005, II 3 G Ex nA II T4 KEMA 07 ATEX 0145X
• for safety of CSA and UL	UL 60950-1, CSA C22.2 Nr. 60950-1
• for hazardous area of CSA and UL	-
• for emitted interference	EN 61000-6-4 (Class A)
• for interference immunity	EN 61000-6-2
Verification of suitability	EN 61000-6-2, EN 61000-6-4
• CE mark	Yes
• C-Tick	Yes
Marine classification association	
• American Bureau of Shipping Europe Ltd. (ABS)	No
• Bureau Veritas (BV)	No
• Det Norske Veritas (DNV)	No
• Germanische Lloyd (GL)	No
• Lloyds Register of Shipping (LRS)	No
• Nippon Kaiji Kyokai (NK)	No

## Ordering data

## Article No.

**PROFIBUS OBT****6GK1500-3AA10**

Optical bus terminal for connecting a PROFIBUS node or an RS485 segment without an integrated optical interface to the optical PROFIBUS; without a Simplex connector

**PROFIBUS plug-in cable 830-1T**

For connecting a data terminal, completely pre-assembled with two sub-D connectors, 9-pin

- 1.5 m
- 3 m

**6XV1830-1CH15**  
**6XV1830-1CH30**

**SITOP compact 24 V/ 0.6 A**

1-phase power supply with wide-range input 85 – 264 V AC/110 – 300 V DC, stabilized output voltage 24 V, rated output current value 0.6 A, slim design

**6EP1331-5BA00**

# PROFIBUS

## System interfaces for SIMATIC S7

### Introduction

### Overview

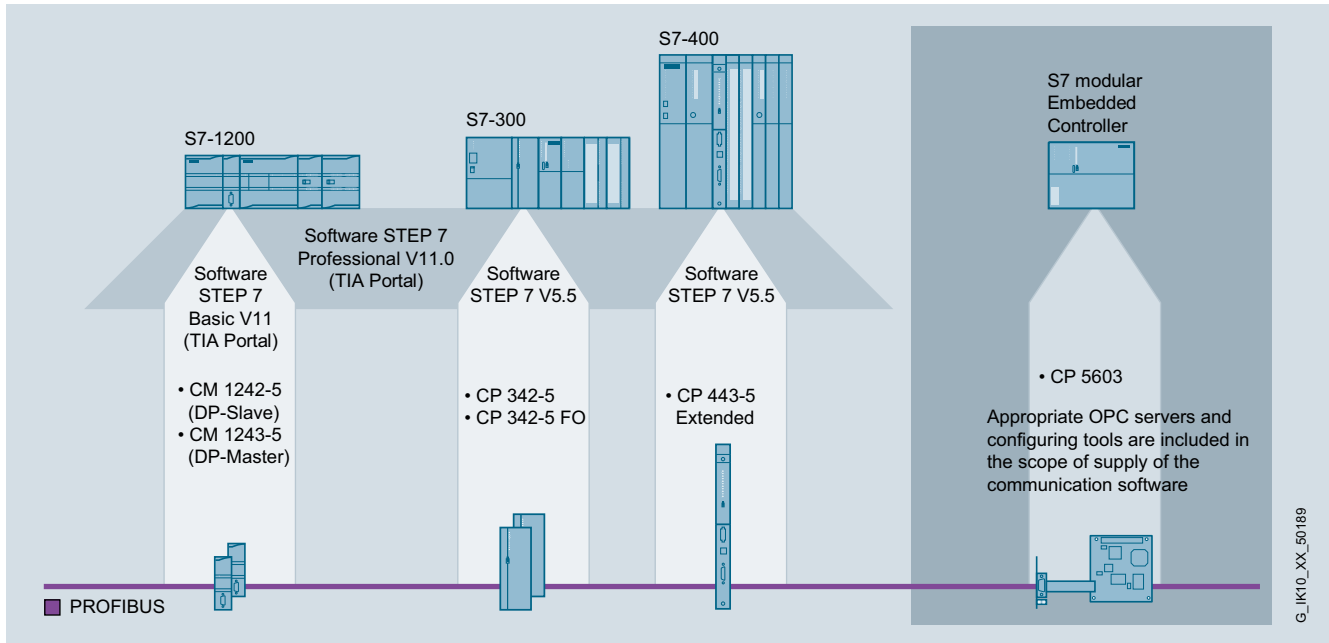

PROFIBUS communication for SIMATIC S7

The communication modules for SIMATIC open up further application cases through additional functions using CPs, such as Fiber Optic, as far as the terminal device. They also support versatile expansion of the SIMATIC with further communication interfaces for PROFIBUS as required, taking the load off the CPU.

#### **Standard functions – PROFIBUS connection for any CPU**

- CM 1242-5 and CM 1243-5 for SIMATIC S7-1200 for connection to PROFIBUS as DP slave or DP master
- CM 1542-5 for SIMATIC S7-1500 for connection to PROFIBUS as DP slave or DP master
- CP 342-5 for SIMATIC S7-300 for connection to PROFIBUS as DP master or DP slave
- CM 443-5 Extended for connection to PROFIBUS as DP master or DP slave
- Designed for use in harsh industrial environments
- Shipbuilding certification for use on ships and offshore units
- High-speed data transfer due to transfer rates of up to 12 Mbit/s

#### **CPs with special functions**

- CP 342-5 FO with integral optical interface for connecting the SIMATIC S7-300 to the optical PROFIBUS DP
- CP 1542-5 as entry-level module for connecting the S7-1500 to PROFIBUS with limited number of PROFIBUS DP slaves

### Overview (continued)

Hardware	PROFIBUS DP			Open communication	S7 communication	PG/OP communication		Usage		Time		
	DP master cl.1	DP master cl.2	DP slave			Send/Receive	S7 routing	F system	H system	Sender	Receiver	Transfer
SIMATIC S7-1200	S7-1200 CPUs	No PB SS integrated !										
	CM 1243-5	• <sup>1)</sup>				•	•	•				
	CM 1242-5			•								
SIMATIC S7-1500	CPU 1511-1 PN	No PB SS integrated !										
	CPU 1513-1 PN	No PB SS integrated !										
	CPU 1516-3 PN/DP	•	•			•	•	•	• <sup>3)</sup>		•	•
	CM 1542-5	•	•	•		•	•	•	•		•	•
	CP 1542-5	• <sup>2)</sup>	•	•			•	•	•		•	•
SIMATIC S7-300	S7-300 CPUs	•	•	•		○	•		• <sup>3)</sup>		•	•
	CP 343-5	•	•	•	•	•	•	•				
	CP 343-5 FO	•	•	•	•	•	•	•				
SIMATIC S7-400	S7-400 CPUs	•	•	•		•	•	•	• <sup>3)</sup>	• <sup>3)</sup>	•	•
	CP 443-5 Extended	•	•		•	•	•	•	•	•		•
SIMATIC S7mEC	CP 5603	•	•	•	•	•	•					

1) 16 DP slaves maximum  
 2) 32 DP slaves maximum  
 3) special F- or H-CPU

• applies  
 ○ with restrictions

G\_IK10\_XX\_50199

Overview of functions for SIMATIC CPs/CMs and CPUs

## PROFIBUS

### Communication for SIMATIC S7-1200

#### CM 1242-5

#### Overview



DP-M	DP-S	FMS	PG/OP	S7
	●			

The CM 1242-5 communication module is used to connect a SIMATIC S7-1200 to PROFIBUS as a DP slave and has the following characteristics:

- PROFIBUS DPV1 slave in accordance with IEC 61158
- Module replacement without PG supported
- Power is supplied via the backplane bus so that no extra cabling is required
- Support of all standard baud rates from 9.6 Kbit/s to 12 Mbit/s
- Compact industry-standard enclosure in S7-1200 design for mounting on a standard mounting rail
- Fast commissioning thanks to easy configuration using STEP 7 without additional programming overhead

The CM 1242-5 is intended for use in factory automation. Low-cost PROFIBUS-based automation solutions can be created on the basis of the S7-1200 for optimal production.

#### Benefits



PROFIBUS-based systems can be operated effectively for lower operating and maintenance costs:

- Low costs since an automation solution requires no fixed wiring and less hardware
- Fast response to faults thanks to comprehensive diagnostics options
- Optimized plant and inventory management

The CM 1242-5 also offers further benefits especially for the requirements of micro-automation solutions:

- Uncomplicated connection of the S7-1200 to PROFIBUS without extra power supply
- Low-cost implementation of automation solutions based on PROFIBUS
- Fast commissioning, as no programming overhead is required

#### Application

The CM 1242-5 is designed for use in factory automation.

With the CM 1242-5, low-cost, distributed automation solutions can be implemented on the basis of the S7-1200, or in simple cases even complete plant automation systems. It can be used in all sectors of discrete automation. These include, for example:

- Automotive
- Pharmaceuticals
- Semiconductors
- Food processing industry

### Design



The CM 1242-5 offers all the benefits of the S7-1200 design.

- Rugged, compact plastic enclosure
- Easily accessible connection and diagnostics elements, protected by front flaps
- Removable connecting terminals
- Simple mounting on the mounting rail of the S7-1200
- 9-pin sub-D socket for the bus interface to PROFIBUS

The CM 1242-5 is plugged into the left-hand system bus interface of the S7-1200. Power is supplied via the system bus of the S7-1200 so that no extra cabling is required. The rugged RS485 interface is located on the underside of the module, protected by the lower front flap.

3

### Function

The CM 1242-5 provides the communication services for integrating an S7-1200 into an automation solution as a PROFIBUS DP slave.

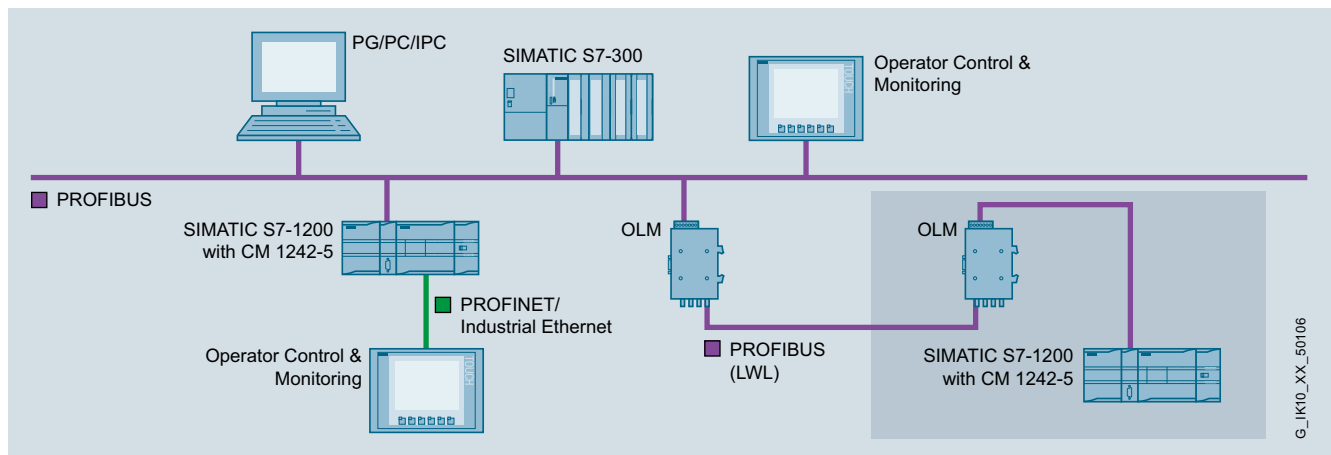

#### PROFIBUS DP slave

The CM 1242-5 works as a DPV1 slave in accordance with IEC 61158, handles data traffic completely autonomously, and thus relieves the CPU of communication tasks.

The data areas of the distributed I/Os are transferred consistently between CP and CPU.

#### Diagnosis

Extensive diagnostic options are available via STEP 7, including

- Operating state of the CM
- General diagnostics functions
- Connection diagnostics
- Message buffer

STEP 7 Basic V11 or higher is required for configuring the full functional scope of the CP 1242-5.

**PROFIBUS****Communication for SIMATIC S7-1200****CM 1242-5****Technical specifications**

Article No.	6GK7242-5DX30-0XE0	Article No.	6GK7242-5DX30-0XE0
Product-type designation	CM 1242-5	Product-type designation	CM 1242-5
<b>Transmission rate</b>		<b>Performance data</b>	
Transmission rate at interface 1 in accordance with PROFIBUS	9.6 kbit/s ... 12 Mbit/s	<u>Performance data open communication</u>	
<b>Interfaces</b>		Number of possible connections for open communication by means of SEND/RECEIVE blocks maximum	-
Number of electrical connections		Data volume as user data per connection for open communication by means of SEND/RECEIVE blocks maximum	-
• at interface 1 in accordance with PROFIBUS	1	<u>Performance data PROFIBUS DP</u>	
• for power supply	0	Service as DP master DPV1	-
Design of electrical connection		Number of DP slaves on DP master usable	-
• at interface 1 in accordance with PROFIBUS	9-pin Sub-D socket (RS485)	Amount of data	
• for power supply	-	• of the address area of the inputs as DP master overall	-
<b>Supply voltage, current consumption, power loss</b>		• of the address area of the outputs as DP master overall	-
Type of supply voltage	DC	• of the address area of the inputs per DP slave	-
Supply voltage		• of the address area of the outputs per DP slave	-
• 1 from backplane bus	5 V	• of the address area of the diagnostic data per DP slave	-
• external	-	Service as DP slave	
Relative positive tolerance at 24 V with DC	-	• DPV0	Yes
Relative negative tolerance at 24 V with DC	-	• DPV1	Yes
Consumed current		Amount of data	
• from backplane bus at 5 V for DC Typical	0.15 A	• of the address area of the inputs as DP slave overall	240 byte
• from external supply voltage at 24 V with DC		• of the address area of the outputs as DP slave overall	240 byte
- typical	-	<u>Performance data S7 communication</u>	
- maximum	-	Number of possible connections for S7 communication	
Resistive loss	0.75 W	• maximum	-
<b>Permitted ambient conditions</b>		• with PG connections maximum	-
Ambient temperature		• with PG/OP connections maximum	-
• for vertical installation during operating phase	0 ... 45 °C	• note	-
• for horizontal installation during operating phase	0 ... 55 °C	<u>Performance data multi-protocol mode</u>	
• during storage	-40 ... +70 °C	Number of active connections with multi-protocol mode	
• during transport	-40 ... +70 °C	• without DP maximum	-
• Comment	-	• with DP maximum	-
Relative humidity at 25 °C without condensation during operating maximum	95 %	<b>Product functions management, configuration</b>	
Protection class IP	IP20	Configuration software required	STEP 7 Basic/Professional V11 (TIA Portal) or higher
<b>Design, dimensions and weight</b>			
Module format	Compact module S7-1200 single width		
Width	30 mm		
Height	100 mm		
Depth	75 mm		
Net weight	0.115 kg		
<b>Product properties, functions, components general</b>			
Number of modules per CPU maximum	3		
Number of modules note	-		



Ordering data	Article No.
<b>CM 1242-5 communication module</b> Communication module for electrical connection of SIMATIC S7-1200 to PROFIBUS as a DPV1 slave	<b>6GK7242-5DX30-0XE0</b>
<i>Accessories</i>	
<b>PROFIBUS FastConnect connection plug RS485</b> With 90° cable outlet; insulation displacement technology, max. transmission rate 12 Mbit/s <ul style="list-style-type: none"> <li>• Without PG interface</li> <li>• With PG interface</li> </ul>	<b>6ES7972-0BA52-0XA0</b> <b>6ES7972-0BB52-0XA0</b>
<b>PROFIBUS FC Standard Cable</b> 2-core bus cable, shielded, special design for fast mounting, delivery unit: max. 1 000 m, minimum order 20 m, sold by the meter	<b>6XV1830-0EH10</b>
<b>PROFIBUS FastConnect Stripping Tool</b> Stripping tool for fast stripping of the PROFIBUS FastConnect bus cable	<b>6GK1905-6AA00</b>
<b>PROFIBUS bus terminal 12M</b> Bus terminal for connection of PROFIBUS nodes at up to 12 Mbit/s with connecting cable	<b>6GK1500-0AA10</b>

Note:

For software ordering data, see page 3/178

## PROFIBUS

### Communication for SIMATIC S7-1200

#### CM 1243-5

#### Overview



DP-M	DP-S	FMS	PG/OP	S7
●			●	●

The CM 1243-5 communication module is used to connect a SIMATIC S7-1200 to PROFIBUS as a DP master and has the following characteristics:

- PROFIBUS DPV1 master in accordance with IEC 61158
- Support of up to 16 PROFIBUS DP slaves
- Communication with other S7 controllers based on S7 communication
- Allows the connection of programming devices and operator panels with a PROFIBUS interface to the S7-1200
- Module replacement without PG supported
- Support of all standard baud rates from 9.6 Kbit/s to 12 Mbit/s
- Compact industry-standard enclosure in S7-1200 design for mounting on a standard mounting rail
- Fast commissioning thanks to easy configuration using STEP 7 without additional programming overhead

The CM 1243-5 is intended for use in factory automation. Low-cost PROFIBUS-based automation solutions can be created on the basis of the S7-1200 for optimal production.

#### Benefits



PROFIBUS-based systems can be operated effectively for lower operating and maintenance costs:

- Low costs since an automation solution requires no fixed wiring and less hardware
- Fast response to faults thanks to excellent diagnostics options
- Optimized plant and inventory management

The CM 1243-5 also offers further benefits especially for the requirements of micro-automation solutions:

- Uncomplicated connection of the S7-1200 to PROFIBUS
- Low-cost implementation of automation solutions based on PROFIBUS
- Fast commissioning, as no programming overhead is required

Use of PROFIBUS-based micro-automation solutions enables optimal operation of the plant and problem-free production.

#### Application

The CM 1243-5 is designed for use in factory automation, particularly for mechanical engineering

With the CM 1243-5, low-cost, distributed automation solutions can be implemented on the basis of the S7-1200, or in simple cases even complete plant automation systems. It can be used in all sectors of discrete automation. These include, for example:

- Automotive
- Pharmaceuticals
- Semiconductors
- Food processing industry

In mechanical engineering, the S7-1200 can be used with the CM 1243-5 as a central control unit, with sensors, actuators or the HMI devices connected direct via PROFIBUS.

- Pick-and-place machines
- Metalworking machines
- Packaging machinery
- Printing machines
- Textile machines
- Filling machines

### Design



The CM 1243-5 offers all the benefits of the S7-1200 design.

- Rugged, compact plastic enclosure
- Easily accessible connection and diagnostics elements, protected by front flaps
- Removable connecting terminals
- Simple mounting on the mounting rail of the S7-1200
- 9-pin sub-D socket for the bus interface to PROFIBUS
- 3-pin plug-in terminal strip for connection of the 24 V DC external supply voltage

The CM 1243-5 is plugged into the left-hand system bus interface of the S7-1200. The power is supplied via a 3-pin terminal strip on top of the module. The rugged RS485 interface is located on the underside of the module, protected by the lower front flap.

3

### Function

The CM 1243-5 provides access to different communication services on the basis of PROFIBUS:

- PROFIBUS DP (according to IEC 61158, master)
- PG/OP communication
- S7 communication

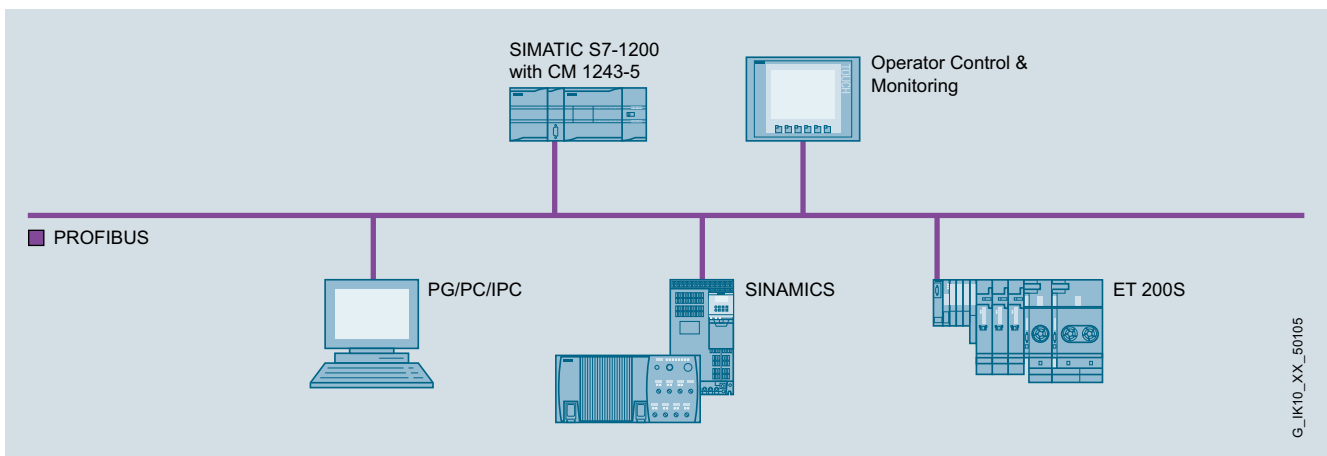

#### PROFIBUS DP master

The CM 1243-5 works as a DP-V1 master in accordance with IEC 61158, handles data traffic completely autonomously, and thus relieves the CPU of communication tasks.

The data areas of the distributed I/Os are transferred consistently between CP and CPU. As a DP master, it allows the connection of up to 16 PROFIBUS-compliant DP slaves

#### PG/OP communication

The S7-1200 to which the CM 1243-5 is connected can be programmed with the help of PG/OP communication.

#### S7 communication

Communication with the following other systems can be implemented with the mechanisms familiar from the S7 world (Put/Get) on the basis of S7 communication:

- To other SIMATIC S7 programmable controllers
- To HMI devices
- To PCs, laptops, field PGs with PROFIBUS cards

#### Diagnosis

Extensive diagnostic options are available via STEP 7, including

- Operating state of the CM
- General diagnostics and statistics functions
- Connection diagnostics
- Message buffer

STEP 7 Basic V11 or higher is required for configuring the full functional scope of the CP 1243-5.

**PROFIBUS**

## Communication for SIMATIC S7-1200

CM 1243-5

**Technical specifications**

Article No.	6GK7243-5DX30-0XE0
Product-type designation	CM 1243-5
<b>Transmission rate</b>	
Transmission rate at interface 1 in accordance with PROFIBUS	9.6 kbit/s ... 12 Mbit/s
<b>Interfaces</b>	
Number of electrical connections	
• at interface 1 in accordance with PROFIBUS	1
• for power supply	1
Design of electrical connection	
• at interface 1 in accordance with PROFIBUS	9-pin Sub-D socket (RS485)
• for power supply	3-pin terminal strip
<b>Supply voltage, current consumption, power loss</b>	
Type of supply voltage	DC
Supply voltage	
• 1 from backplane bus	-
• external	24 V
Relative positive tolerance at 24 V with DC	20 %
Relative negative tolerance at 24 V with DC	20 %
Consumed current	
• from backplane bus at 5 V for DC Typical	-
• from external supply voltage at 24 V with DC	
- typical	0.1 A
- maximum	-
Resistive loss	2.4 W
<b>Permitted ambient conditions</b>	
Ambient temperature	
• for vertical installation during operating phase	0 ... 45 °C
• for horizontal installation during operating phase	0 ... 55 °C
• during storage	-40 ... +70 °C
• during transport	-40 ... +70 °C
• Comment	-
Relative humidity at 25 °C without condensation during operating maximum	95 %
Protection class IP	IP20
<b>Design, dimensions and weight</b>	
Module format	Compact module S7-1200 single width
Width	30 mm
Height	100 mm
Depth	75 mm
Net weight	0.134 kg

Article No.	6GK7243-5DX30-0XE0
Product-type designation	CM 1243-5
<b>Product properties, functions, components general</b>	
Number of modules	
• per CPU maximum	1
• note	-
<b>Performance data</b>	
<u>Performance data open communication</u>	
Number of possible connections for open communication by means of SEND/RECEIVE blocks maximum	-
Data volume as user data per connection for open communication by means of SEND/RECEIVE blocks maximum	-
<u>Performance data PROFIBUS DP</u>	
Service as DP master DPV1	Yes
Number of DP slaves on DP master usable	16
Amount of data	
• of the address area of the inputs as DP master overall	512 byte
• of the address area of the outputs as DP master overall	512 byte
• of the address area of the inputs per DP slave	244 byte
• of the address area of the outputs per DP slave	244 byte
• of the address area of the diagnostic data per DP slave	240 byte
Service as DP slave	
• DPV0	No
• DPV1	No
Amount of data	
• of the address area of the inputs as DP slave overall	-
• of the address area of the outputs as DP slave overall	-
<u>Performance data S7 communication</u>	
Number of possible connections for S7 communication	
• maximum	8
• with PG connections maximum	1
• with PG/OP connections maximum	3
• note	max. 4 connections to other S7 stations
<u>Performance data multi-protocol mode</u>	
Number of active connections with multi-protocol mode	
• without DP maximum	8
• with DP maximum	8
<b>Product functions management, configuration</b>	
Configuration software required	STEP 7 Basic/Professional V11 or higher

3

Ordering data	Article No.
<b>CM 1243-5 communication module</b> Communication module for electrical connection of SIMATIC S7-1200 to PROFIBUS as a DPV1 master	<b>6GK7243-5DX30-0XE0</b>
<b>Accessories</b>	
<b>PROFIBUS FastConnect connection plug RS485</b> With 90° cable outlet; insulation displacement technology, max. transmission rate 12 Mbit/s <ul style="list-style-type: none"> <li>• Without PG interface</li> <li>• With PG interface</li> </ul>	<b>6ES7972-0BA52-0XA0</b> <b>6ES7972-0BB52-0XA0</b>
<b>PROFIBUS FC Standard Cable</b> 2-core bus cable, shielded, special design for fast mounting, delivery unit: max. 1 000 m, minimum order 20 m, sold by the meter	<b>6XV1830-0EH10</b>
<b>PROFIBUS FastConnect Stripping Tool</b> Stripping tool for fast stripping of the PROFIBUS FastConnect bus cable	<b>6GK1905-6AA00</b>
<b>PROFIBUS bus terminal 12M</b> Bus terminal for connection of PROFIBUS nodes at up to 12 Mbit/s with connecting cable	<b>6GK1500-0AA10</b>

Note:

For software ordering data, see page 3/178

## PROFIBUS

### Communication for SIMATIC S7-1500

#### CM 1542-5

#### Overview



DP-M	DP-S	FMS	PG/OP	S7	
●	●		●	●	●

The CM 1542-5 communication module expands the SIMATIC S7-1500 controller with an additional PROFIBUS connection for communication with lower-level PROFIBUS devices in bandwidths from 9.6 kbps to 12 Mbps. The module also allows the implementation of separate PROFIBUS lines; in other words, the control of multiple field devices via several PROFIBUS segments. The CM 1542-5 assumes all communication tasks, thus reducing the CPU workload.

The CM 1542-5 is suitable for S7 communication as well as for conventional PROFIBUS communication. This makes it possible to establish communication between the S7-1500 controller and other devices, for example those from the SIMATIC S7-300/400 range.

- PROFIBUS DP master or DP slave with electrical interface for connecting the SIMATIC S7-1500 to PROFIBUS at up to 12 Mbit/s (including 45.45 Kbit/s)
- Communication services:
  - PROFIBUS DP
  - PG/OP communication
  - S7 communication
- Time synchronization
- Simple programming and configuration over PROFIBUS
- Cross-network PG communication using S7 routing
- Module replacement without a PG
- Data record routing (PROFIBUS DP)
- Adding or modifying distributed I/O during operation

#### Benefits

get **Designed for Industry**

- Particularly suitable for closed-loop control tasks thanks to SYNC/FREEZE and constant bus cycle
- Sub-process-oriented design of an automation solution through the use of several CMs
- Universal application of the CM due to the parallel use of different communications services on one CM

#### Application

The CM 1542-5 is the communications processor of the SIMATIC S7-1500 for the PROFIBUS bus system. It relieves the CPU of communication tasks and supports additional connections.

Communications options of the S7-1500 using communication modules:

- As master for PROFIBUS DP according to IEC 61158/EN 50170
- Communication with programming devices and HMI devices
- Communication with other SIMATIC S7 systems
- Communication with SIMATIC S5 programmable controllers

The number of CMs that can be operated depends on the CPU type and on the communication services used.

#### Design

The CM 1542-5 communication module features all the advantages of the SIMATIC S7-1500 design:

- Compact design:
  - 9-pin D-sub socket for connection to PROFIBUS DP
  - The module is supplied with power via the integrated backplane bus
  - Three LEDs to indicate the operational and communication status
- Simple installation:
  - The CM 1542-5 is mounted on the rail of the S7-1500 and connected to the other modules of the S7-1500 by means of bus connectors. The slot rules of the S7-1500 system apply.
- User-friendly wiring:
  - the D-sub socket is easily accessible and simple to use.
- The CM 1542-5 can be operated without a fan. A backup battery is not required.
- The module can be replaced without the need for a programming device.

### Function

The CM 1542-5 supports the following communication services:

- PROFIBUS DP Master Class 1
  - PROFIBUS DP (according to IEC 61158/61784)
  - SYNC/FREEZE: The outputs and/or inputs can be synchronized from the user program with the DPSYNC\_FR system function.
- PROFIBUS DP slave (not when DP master)
- PG/OP communication
- S7 communication
- Time synchronization via PROFIBUS

#### Master for PROFIBUS DP

The CM 1542-5 operates as DP-V1 master. It handles data transfer independently and allows slaves to be connected, such as the CM 1242-5 as a DP slave, DP slaves of the ET 200 distributed I/O system, etc. This means that the CM 1542-5 is able to connect the S7-1500 station to PROFIBUS DP and is the ideal expansion to the integrated DP master interfaces of the S7-1500 CPUs (CPU 1516 and larger) for establishing additional PROFIBUS DP lines.

The CM 1542-5 is a DP-V1 master; in other words, it also supports the acyclic standard services, including alarm handling. The CM 1542-5 also supports the functions SYNC and FREEZE, constant bus cycle time and data record routing.

During normal operation, it is also possible to activate or deactivate DP slaves. Among other things, this allows the step-by-step commissioning of subprocesses.

A diagnostic repeater allows the line to be diagnosed during operation, enabling line faults to be detected at an early stage. The CM 1542-5 supports operation with a diagnostic repeater (including activation of topology identification on the diagnostic repeater).

The distributed I/O is handled like the central I/O from the user's point of view. This means that there are no differences between the CM 1542-5 and the integrated DP master interface of the S7-1500 CPU in terms of configuration and parameter assignment. Regardless of the scale of the system, the CM 1542-5 has extremely short response times.

#### PG/OP communication

PG/OP communication allows all S7 stations connected to the network to be remotely programmed.

- S7 routing: With the aid of routing it is possible to use programming device communication across different networks.

#### S7 communication

S7 communication is used for the coupling

- between SIMATIC S7 automation systems
- and programming devices (PG/OP communication)
- to PCs, e.g. CP 5711 with SOFTNET-PB S7, CP 5623 etc.
- and HMI devices (OPs)

#### Time synchronization

Time synchronization is used to set the time of day throughout the plant.

The CM 1542-5 is capable of forwarding the time of day of the S7-1500 CPU to PROFIBUS. Conversely, the CM of the S7-1500 CPU can make an existing time on PROFIBUS available.

The CM 1542-5 supports:

- Time status value, daylight-saving time changeover, synchronization status

#### Data record routing

The CM 1542-5 supports the data record routing function. With this option, the CP can be used as a router for data records that need to be sent to field devices (DP slaves). Data records from devices that are not connected directly to PROFIBUS and therefore have no direct access to the DP slaves are forwarded to the DP slaves by the CM.

#### Diagnostics

Extensive diagnostic options are available with STEP 7 Professional V13 (TIA Portal), including:

- Operating status of the CM
- General diagnostics and statistics functions
- Connection diagnostics
- Bus statistics
- Alarm buffer
- Support of operation with diagnostic repeater

## PROFIBUS

### Communication for SIMATIC S7-1500

#### CM 1542-5

#### Design (continued)

##### Configuration

STEP 7 Professional V12 (TIA Portal) or higher is required for configuring the full range of functions of the CM 1542-5. The configuration data of the CM is always saved on the CPU and retained even after a PLC failure. It is therefore possible to replace a module without having to reload the configuration data from a programming device. The CPU transfers the configuration data to the CM during startup.

Configuration and programming of all SIMATIC S7 controllers connected to the network is possible over the network.

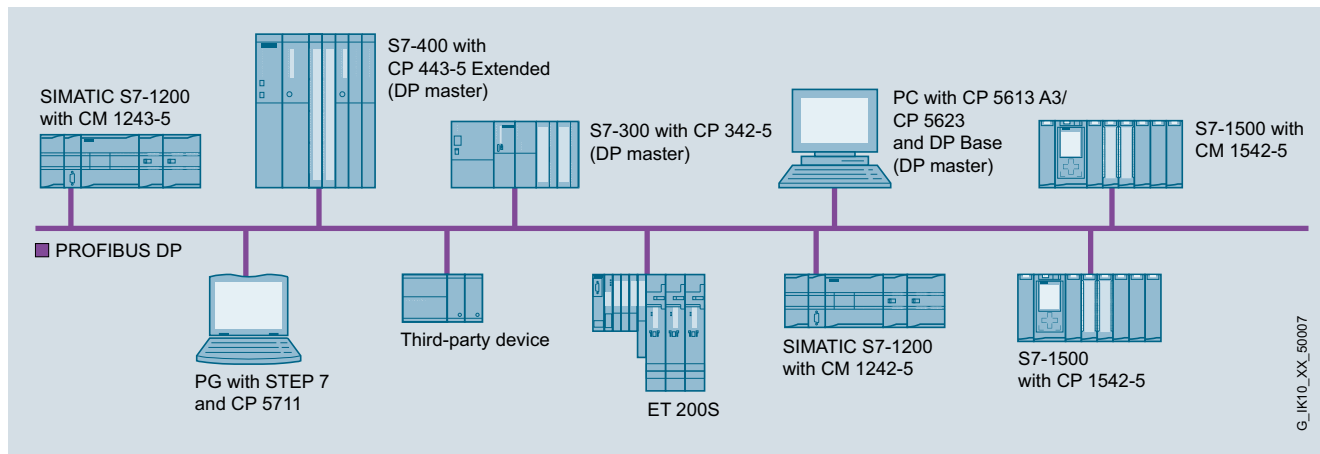

G\_IK10\_XX\_50007



**Technical specifications**

Article No.	6GK7542-5DX00-0XE0
Product-type designation	CM 1542-5
<b>Transmission rate</b>	
Transmission rate at interface 1 • in accordance with PROFIBUS	9.6 kbit/s ... 12 Mbit/s
<b>Interfaces</b>	
Number of electrical connections at interface 1 • in accordance with PROFIBUS	1
Design of electrical connection at interface 1 • in accordance with PROFIBUS	9-pin Sub-D socket (RS485)
<b>Supply voltage, current consumption, power loss</b>	
Type of supply voltage	DC
Supply voltage 1 • from backplane bus	15 V
Relative symmetrical tolerance at 15 V with DC	3 %
Current consumption from backplane bus at 15 V with DC typical	0.2 A
Resistive loss	3 W
<b>Permitted ambient conditions</b>	
Ambient temperature • for vertical installation during operating phase	0 ... 40 °C
• for horizontal installation during operating phase	0 ... 60 °C
• during storage	-40 ... +70 °C
• during transport	-40 ... +70 °C
• Comment	-
Relative humidity at 25 °C without condensation during operating maximum	95 %
Protection class IP	IP20
<b>Design, dimensions and weight</b>	
Module format	Compact module S7-1500 single width
Width	35 mm
Height	142 mm
Depth	129 mm
Net weight	0.4 kg
Mounting type S7-1500 rail mounting	Yes

Article No.	6GK7542-5DX00-0XE0
Product-type designation	CM 1542-5
<b>Product properties, functions, components general</b>	
Number of modules • per CPU maximum • note	8 depending on CPU type
<b>Performance data</b>	
<u>Performance data PROFIBUS DP</u>	
Service as DP master DPV1	Yes
Number of DP slaves on DP master usable	125
Amount of data • of the address area of the inputs as DP master overall	8 192 byte
• of the address area of the outputs as DP master overall	8 192 byte
• of the address area of the inputs per DP slave	244 byte
• of the address area of the outputs per DP slave	244 byte
• of the address area of the diagnostic data per DP slave	-
Service as DP slave • DPV0 • DPV1	Yes Yes
Amount of data • of the address area of the inputs as DP slave overall	240 byte
• of the address area of the outputs as DP slave overall	240 byte
<u>Performance data S7 communication</u>	
Number of possible connections for S7 communication • maximum	40
• with PG connections maximum	-
• with PG/OP connections maximum	-
• note	depending on the system upper limit
<u>Performance data multi-protocol mode</u>	
Number of active connections with multi-protocol mode	40
<b>Product functions management, configuration</b>	
Configuration software required	STEP 7 Professional V12 (TIA Portal) or higher
<b>Product functions Diagnosis</b>	
Product function Web-based diagnostics • note	Yes Yes, via S7-1500 CPU
<b>Product functions Time</b>	
Product function pass on time synchronization	Yes

**PROFIBUS**

## Communication for SIMATIC S7-1500

CM 1542-5

**Ordering data****Article No.****CM 1542-5 communication module**

Communication module for electrical connection of SIMATIC S7-1500 to PROFIBUS as a DP master or DP slave

**6GK7542-5DX00-0XE0****Accessories****PROFIBUS FastConnect connector RS485**

With 90° cable outlet; insulation displacement technology, max. transmission rate 12 Mbps

- Without PG interface
- with PG interface

**6ES7972-0BA52-0XA0**  
**6ES7972-0BB52-0XA0**

**PROFIBUS FC Standard Cable**

2-core bus cable, shielded, special design for fast mounting, delivery unit: max. 1 000 m, minimum order 20 m, sold by the meter

**6XV1830-0EH10****PROFIBUS FastConnect Stripping Tool**

Stripping tool for fast stripping of the PROFIBUS FastConnect bus cable

**6GK1905-6AA00****PROFIBUS bus terminal 12M**

Bus terminal for connection of PROFIBUS nodes up to 12 Mbps with plug-in cable

**6GK1500-0AA10****More information**

You can find more information on SIMATIC S7-1500 at [www.siemens.com/simatic-S7-1500](http://www.siemens.com/simatic-S7-1500)

3

Note:

For software ordering data, see page 3/178

### Overview



DP-M	DP-S	FMS	PG/OP	S7/S5	
●	●		●		

The CP 1542-5 communications processor expands the SIMATIC S7-1500 controller with an additional PROFIBUS connection for communication with lower-level PROFIBUS devices in bandwidths from 9.6 kbps to 12 Mbit/s. The processor also allows the implementation of separate PROFIBUS lines; in other words, the control of multiple field devices via several PROFIBUS segments. The CP 1542-5 handles all communication tasks, thus reducing the CPU load.

- PROFIBUS DP master or DP slave with electrical interface for connecting the SIMATIC S7-1500 to PROFIBUS at up to 12 Mbit/s (including 45.45 Kbit/s)

Communication services:

- PROFIBUS DP
- PG/OP communication
- Time synchronization
- Simple programming and configuration over PROFIBUS
- Cross-network PG communication using S7 routing
- Module replacement without a PG

### Benefits

get **Designed for Industry**

- Particularly suitable for closed-loop control tasks thanks to SYNC/FREEZE and constant bus cycle
- Sub-process-oriented design of an automation solution through the use of several CPs
- Universal application of the CP due to the parallel use of different communication services on one CP

PROFIBUS DP configuration for SIMATIC S5/S7 and PG/PC

### Application

The CP 1542-5 is the communications processor of the SIMATIC S7-1500 for the PROFIBUS bus system. It relieves the CPU from communications tasks.

Communications options of the S7-1500 using communication modules:

- As master for PROFIBUS DP according to IEC 61158/EN 50170 (max. 32 DP slaves)
- Communication with programming devices and HMI devices

The number of CPs that can be operated depends on the CPU type and on the communication services used.

### Design

The communications processor CP 1542-5 features all the advantages of the SIMATIC S7-1500 design:

- Compact design:
  - 9-pin D-sub socket for connection to PROFIBUS DP
  - The module is supplied with power via the integrated backplane bus
  - Three LEDs to indicate the operational and communication status
- Simple installation:
  - The CP 1542-5 is mounted on the rail of the S7-1500 and connected to the other modules of the S7-1500 by means of the bus connectors. The slot rules of the S7-1500 system apply.
- User-friendly wiring:
  - the D-sub socket is easily accessible and simple to use.
- The CP 1542-5 can be operated without a fan. A backup battery is not required.
- The module can be replaced without the need for a programming device.

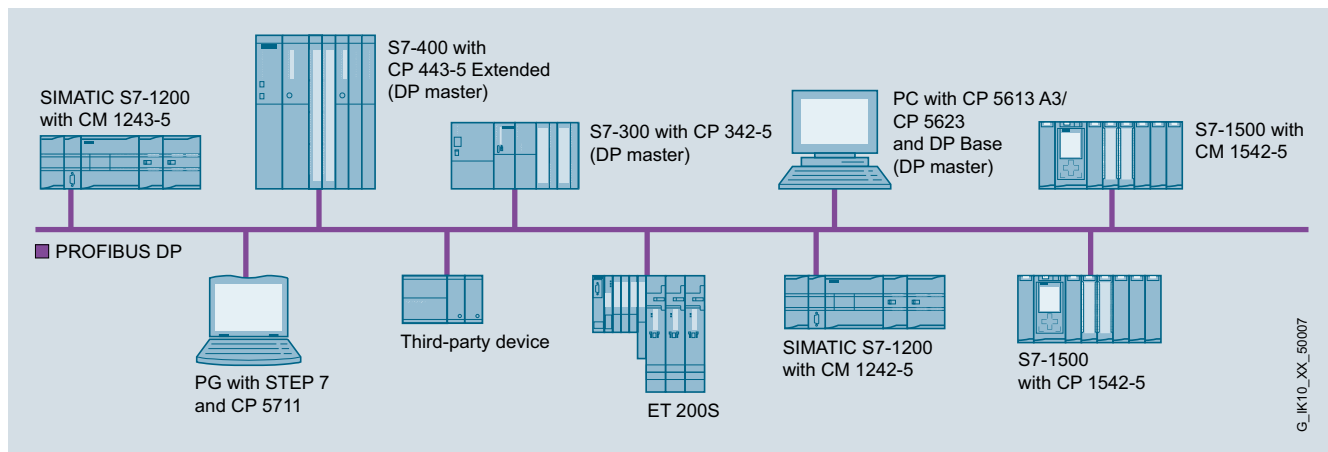

## PROFIBUS

### Communication for SIMATIC S7-1500

#### CP 1542-5

#### Function

The CP 1542-5 supports the following communications services:

- PROFIBUS DP Master Class 1
  - PROFIBUS DP (according to IEC 61158/61784)
  - SYNC/FREEZE: The outputs or inputs can be synchronized from the user program with the DPSYNC\_FR system function.
- PROFIBUS DP slave (not when DP master)
- PG/OP communication
- Time synchronization via PROFIBUS

#### Master for PROFIBUS DP

The CP 1542-5 operates as DP-V1 master. It handles data transfer independently and allows up to 32 slaves to be connected, such as the CM 1242-5 as a DP slave, DP slaves of the ET 200 distributed I/O system, etc. This means that the CP 1542-5 is able to connect the S7-1500 station to PROFIBUS DP and is the ideal expansion to the integrated DP master interfaces of the S7-1500 CPUs (CPU 1516 and larger) for establishing additional PROFIBUS DP lines.

The CP 1542-5 is a DP-V1 master; in other words, it also supports the acyclic standard services, including alarm handling. The CP 1542-5 also supports the functions SYNC, FREEZE, and constant bus cycle time.

During normal operation, it is also possible to activate or deactivate DP slaves. Among other things, this allows the step-by-step commissioning of subprocesses.

A diagnostic repeater allows the line to be diagnosed during operation, enabling line faults to be detected at an early stage. The CP 1542-5 supports operation with a diagnostic repeater (including activation of topology identification on the diagnostic repeater).

There are no differences between the CP 1542-5 and the integral DP master interface of the S7-1500 CPU with regard to configuration and programming. The distributed I/O is therefore handled like the central I/O just as for the CPU. Regardless of the scale of the system, the CP 1542-5 has extremely short response times.

#### PG/OP communication

PG/OP communication allows all S7 stations connected to the network to be remotely programmed.

- S7 routing: With the aid of routing it is possible to use programming device communication across different networks.

#### S7 communication

S7 communication is used for coupling to the following devices:

- Programming devices (PG/OP communication)
- HMI devices (OP)

#### Time synchronization

Time synchronization is used to set the time of day throughout the plant.

The CP 1542-5 is capable of forwarding the time of day of the S7-1500 CPU to PROFIBUS. Conversely, the CP of the S7-1500 CPU can make an existing time of day available on PROFIBUS.

The CP 1542-5 supports:

- Time status value, daylight-saving time changeover, synchronization status

#### Diagnostics

Extensive diagnostics options are available with STEP 7 Professional of the TIA Portal V12 SP1 or higher, including:

- Status of the CP
- General diagnostics and statistics functions
- Connection diagnostics
- Bus statistics
- Alarm buffer
- Support of operation with diagnostic repeater

#### Configuration

STEP 7 Professional of the TIA Portal V12 SP1 or higher is required for configuring the full range of functions of the CP 1542-5. The configuring data of the CP are always saved on the CPU and are retained even after a PLC failure. A module can therefore be replaced without having to reload the configuration data from a programming device. The CPU transfers the configuration data to the CP during start-up.

Configuration and programming of all SIMATIC S7 controllers connected to the network is possible over the network.

**Technical specifications**

Article No.	6GK7542-5FX00-0XE0	Article No.	6GK7542-5FX00-0XE0
Product-type designation	CP 1542-5	Product-type designation	CP 1542-5
<b>Transmission rate</b>		<b>Product properties, functions, components general</b>	
Transmission rate at interface 1 • in accordance with PROFIBUS	9.6 kbit/s ... 12 Mbit/s	Number of modules • per CPU maximum • note	8 depending on CPU type
<b>Interfaces</b>		<b>Performance data</b>	
Number of electrical connections at interface 1 • in accordance with PROFIBUS	1	Performance data <u>PROFIBUS DP</u>	
Design of electrical connection at interface 1 • in accordance with PROFIBUS	9-pin Sub-D socket (RS485)	Service as DP master DPV1	Yes
<b>Supply voltage, current consumption, power loss</b>		Number of DP slaves on DP master usable	32
Type of supply voltage	DC	Amount of data	
Supply voltage 1 • from backplane bus	15 V	• of the address area of the inputs as DP master overall	2 048 byte
Relative symmetrical tolerance at 15 V with DC	3 %	• of the address area of the outputs as DP master overall	2 048 byte
Current consumption from backplane bus at 15 V with DC typical	0.1 A	• of the address area of the inputs per DP slave	244 byte
Resistive loss	1.5 W	• of the address area of the outputs per DP slave	244 byte
<b>Permitted ambient conditions</b>		• of the address area of the diagnostic data per DP slave	-
Ambient temperature		Service as DP slave	
• for vertical installation during operating phase	0 ... 40 °C	• DPV0	Yes
• for horizontal installation during operating phase	0 ... 60 °C	• DPV1	Yes
• during storage	-40 ... +70 °C	Amount of data	
• during transport	-40 ... +70 °C	• of the address area of the inputs as DP slave overall	240 byte
• Comment	-	• of the address area of the outputs as DP slave overall	240 byte
Relative humidity at 25 °C without condensation during operating maximum	95 %	Performance data <u>S7 communication</u>	
Protection class IP	IP20	Number of possible connections for S7 communication	
<b>Design, dimensions and weight</b>		• maximum	16
Module format	Compact module S7-1500 single width	• with PG connections maximum	-
Width	35 mm	• with PG/OP connections maximum	-
Height	142 mm	• note	depending on the system upper limit
Depth	129 mm	<b>Product functions management, configuration</b>	
Net weight	0.27 kg	Configuration software required	STEP 7 Professional V12 SP1 (TIA Portal) or higher
Mounting type S7-1500 rail mounting	Yes	<b>Product functions Diagnosis</b>	
		Product function	Yes
		• note	yes, via S7-1500 CPU
		<b>Product functions Time</b>	
		Product function pass on time synchronization	Yes

**PROFIBUS**

## Communication for SIMATIC S7-1500

## CP 1542-5

**Ordering data****Article No.****CP 1542-5 communications processor**

Communication module for electrical connection of SIMATIC S7-1500 to PROFIBUS as DP master or DP slave; PG/OP communication, time synchronization, diagnostics

**6GK7542-5FX00-0XE0****Accessories****PROFIBUS FastConnect connection plug RS485**

With 90° cable outlet; insulation displacement technology, max. transmission rate 12 Mbit/s

- without programming device interface
- with programming device interface

**6ES7972-0BA52-0XA0****6ES7972-0BB52-0XA0****PROFIBUS FC Standard Cable**

2-core bus cable, shielded, special design for fast mounting, delivery unit: max. 1 000 m, minimum order 20 m, sold by the meter

**6XV1830-0EH10****PROFIBUS FastConnect Stripping Tool**

Stripping tool for fast stripping of the PROFIBUS FastConnect bus cable

**6GK1905-6AA00****PROFIBUS bus terminal 12M**

Bus terminal for connection of PROFIBUS stations for up to 12 Mbit/s with plug-in cable

**6GK1500-0AA10**Note:

For software ordering data, see page 3/178

**More information**

You will find more information on SIMATIC S7-1500 at [www.siemens.com/simatic-S7-1500](http://www.siemens.com/simatic-S7-1500)

### Overview



DP-M	DP-S	FMS	PG/OP	S7/S5	
●	●		●	●	

- PROFIBUS DP master or slave with electrical interface for connecting the SIMATIC S7-300 to PROFIBUS at up to 12 Mbit/s (including 45.45 Kbit/s)
- Communication services:
  - PROFIBUS DP
  - PG/OP communication (OP multiplexing)
  - S7 communication (client, server)
  - Open communication (SEND/RECEIVE)
- Easy configuration and programming over PROFIBUS
- Cross-network programming device communication through S7 routing
- Modules can be replaced without the need for a PG

### Benefits



- Expansion of the process I/O to SIMATIC S7-300 with several PROFIBUS DP interfaces
- Flexible use of the process I/O by means of dynamic activation of DP slaves
- Sub-process-oriented design of an automation solution through the use of several CPs
- Optimization of applications and a host of possible uses thanks to active transmission of data with S7 communication
- Extensive operator control and monitoring thanks to multiplex function with OP communication
- Suitable for closed-loop control tasks due to SYNC/FREEZE

### Application

The CP 342-5 is the communications processor of the SIMATIC S7-300 for the PROFIBUS DP bus system.

The CP 342-5 relieves the CPU from communication tasks.

Communication possibilities of the S7-300 using communication modules:

- As DP master or slave for PROFIBUS DP V0 according to IEC 61158/EN 50170
- Communication with programming devices and HMI devices
- Communication with other SIMATIC S7 systems
- Communication with SIMATIC S5 programmable controllers

The number of CPs that can be used is dependent on the performance range of the CPU and on the communications services used.

### Design

The CP 342-5 offers all the advantages of SIMATIC S7-300 system design:

- Compact design; single standard width of the SM modules of the SIMATIC S7-300
- 9-pin Sub-D socket for connection to PROFIBUS
- 4-pin terminal block for connecting the external supply voltage of 24 V DC
- Simple assembly; The CP 342-5 is mounted on the S7-300 DIN rail and connected to adjacent modules by means of the bus connectors. Slots 4 to 11 in subracks 0 to 3 (coupled through the IM 360/361) can be used for the CP 342-5
- In combination with IM 360/361, the CP 342-5 can also be used in an expansion rack (ER)
- User-friendly wiring; Sub-D socket and the terminal block are easily accessible.
- The CP 342-5 can be operated without a fan; a back-up battery or a memory module is not required

## PROFIBUS

### Communication for SIMATIC S7-300

#### CP 342-5

#### Function

The CP 342-5 provides access to different communication services of the PROFIBUS bus system:

- PROFIBUS DP (according to IEC 61158/61784, master or slave)
- PG/OP communication
- S7 communication (client, server)
- Open communication (SEND/RECEIVE)

#### PROFIBUS DP master

The CP 342-5 operates as a DP-V0 Master according to IEC 61158/EN 61784 Volume 2 and processes the data transfer completely independently. It supports the services of the Master Classes 1 and 2.

The data areas of the distributed I/Os are transferred consistently between CP and CPU. This applies to the use of the CP as DP Master and as DP Slave. As DP Master, it permits connections to:

- SIMATIC S7-300, such as CP 342-5 as DP slave
- DP slaves of the distributed I/O system ET 200 (integrate as DP-V0 slave)
- PCs, e.g. with CP 5512, CP 5621, CP 5614 A3 and SOFTNET-PB DP

The CP 342-5 also offers the SYNC/FREEZE and shared input/output functions, as well as the activation/deactivation of DP slaves.

#### PROFIBUS DP slave

The CP 342-5 as a DP-V0 slave permits the SIMATIC S7-300 to exchange data with other PROFIBUS DP masters, which allows a hybrid setup between SIMATIC S5/S7, PCs, ET 200 and other field devices to PROFIBUS DP. Function calls are required for the DP communication. These (DP-SEND/DP-RECV) must be integrated in the STEP 7 user program.

#### PG/OP communication

PG/OP communication allows all S7 stations connected to the network to be remotely programmed.

- S7 routing  
With the aid of S7 routing it is possible to use programming device communication across networks.  
Via the CP 342-5 as many as 16 TD/OPs can be merged into one S7-300 station. This requires only one connection resource in the S7-CPU (multiplex channel). The multiplex channel supports the acyclic HMI services.

#### S7 communication

S7 communication is used for the coupling:

- between SIMATIC S7 automation systems
- to HMI devices (OPs).
- to PCs, e.g. CP 5711 with SOFTNET-PB S7, CP 5623 etc.

Communication with PG and OP takes place without further configuration. In addition, the central controller can also be programmed and configured on a distributed basis via the CP 342-5.

The client functionality is provided by means of loadable communication blocks.

#### Open communication (SEND/RECEIVE)

Based on Layer 2 (FDL) of PROFIBUS, the CP 342-5 offers a simple, optimized interface for process or field communication.

This interface offers integrated, high-performance communication between SIMATIC S5, SIMATIC S7, SIMATIC 505 and PC. SEND/RECEIVE provides not only the SDA service (PLC/PLC connections) but also the SDN service (broadcast, multicast).

The communication partners are the automation systems:

- SIMATIC S7  
with CP 342-5, CP 343-5, CP 443-5 Extended and Basic
- SIMATIC S5  
with S5-95U with PROFIBUS interface, S5-115U/H, S5-135U, S5-155U/H with CP 5431 FMS/DP
- SIMATIC 505  
with CP 5434-FMS
- PCs  
with CP 5512, CP 5611 A2, CP 5621, CP 5613 A3, CP 5613 FO, CP 5614 A3, CP 5623, CP 5624
- Systems of other makes that are equipped with an FDL interface.

To use SEND/RECEIVE, function calls are required (PLC-SEND/PLC-RECEIVE), which must be linked into the STEP 7 user program.

#### Diagnostics

Extensive diagnostic options are available via STEP 7, including:

- Status of the CP
- General diagnostics and statistics functions
- Connection diagnostics
- Bus statistics
- Message buffer

STEP 7 V5.5 SP2 or higher, or STEP 7 Professional V11 or higher, is required for configuring the full functional scope of the CP 342-5. In Version V5 or higher of STEP 7, the configuration data of the CP can also optionally be stored on the CPU and is retained even if there is a power failure. A module can therefore be replaced without having to reload the configuration data from a programming device. The CPU transfers the configuration data to the CP during start-up. Attention should therefore be paid to the memory capacity of the S7-CPU.

Configuration and programming of all SIMATIC S7 controllers connected to the network is possible over the network.

The function blocks for PROFIBUS DP are included in the standard library of STEP 7. The function blocks for using the open communication (SEND/RECEIVE) and S7 communication (S7 client) can be found in the SIMATIC NET library following installation of STEP 7.



**Technical specifications**

Article No.	6GK7342-5DA03-0XE0
Product-type designation	CP 342-5
<b>Transmission rate</b>	
Transmission rate at interface 1 in accordance with PROFIBUS	9.6 kbit/s ... 12 Mbit/s
<b>Interfaces</b>	
Number of electrical connections	
• at interface 1 in accordance with PROFIBUS	1
• for power supply	1
Design of electrical connection	
• at interface 1 in accordance with PROFIBUS	9-pin Sub-D socket (RS485)
• for power supply	4-pin terminal strip
<b>Supply voltage, current consumption, power loss</b>	
Type of supply voltage	DC
Supply voltage	
• 1 from backplane bus	5 V
• external	24 V
Relative positive tolerance at 24 V with DC	20 %
Relative negative tolerance at 24 V with DC	15 %
Consumed current	
• from backplane bus at 5 V for DC Typical	0.15 A
• from external supply voltage at 24 V with DC	
- typical	0.25 A
- maximum	-
Resistive loss	6.75 W
<b>Permitted ambient conditions</b>	
Ambient temperature	
• during operating	0 ... 60 °C
• during storage	-40 ... +70 °C
• during transport	-40 ... +70 °C
• Comment	-
Relative humidity at 25 °C without condensation during operating maximum	95 %
Protection class IP	IP20
<b>Design, dimensions and weight</b>	
Module format	Compact module S7-300 single width
Width	40 mm
Height	125 mm
Depth	120 mm
Net weight	0.3 kg

Article No.	6GK7342-5DA03-0XE0
Product-type designation	CP 342-5
<b>Product properties, functions, components general</b>	
Number of modules	
• per CPU maximum	4
• note	-
<b>Performance data</b>	
<u>Performance data open communication</u>	
Number of possible connections for open communication by means of SEND/RECEIVE blocks maximum	16
Data volume as user data per connection for open communication by means of SEND/RECEIVE blocks maximum	240 byte
<u>Performance data PROFIBUS DP</u>	
Service as DP master DPV0	Yes
Number of DP slaves on DP master usable	124
Amount of data	
• of the address area of the inputs as DP master overall	2 160 byte
• of the address area of the outputs as DP master overall	2 160 byte
• of the address area of the inputs per DP slave	244 byte
• of the address area of the outputs per DP slave	244 byte
• of the address area of the diagnostic data per DP slave	240 byte
Service as DP slave	
• DPV0	Yes
• DPV1	-
Amount of data	
• of the address area of the inputs as DP slave overall	240 byte
• of the address area of the outputs as DP slave overall	240 byte
<u>Performance data S7 communication</u>	
Number of possible connections for S7 communication	
• maximum	16
• with PG connections maximum	-
• with PG/OP connections maximum	-
• note	-
<u>Performance data multi-protocol mode</u>	
Number of active connections with multi-protocol mode	
• without DP maximum	32
• with DP maximum	28
<b>Product functions management, configuration</b>	
Configuration software required	STEP 7 V5.1 SP2 or higher/ STEP 7 Professional V12 (TIA Portal) or higher

**PROFIBUS**

## Communication for SIMATIC S7-300

## CP 342-5

Ordering data	Article No.
<b>CP 342-5 communications processor</b> Communications processor for electrical connection of SIMATIC S7-300 to PROFIBUS at up to 12 Mbit/s, with electronic manual on CD-ROM	<b>6GK7342-5DA03-0XE0</b>
<b>Accessories</b> <b>PROFIBUS FastConnect connection plug RS485</b> With 90° cable outlet; insulation displacement technology, max. transmission rate 12 Mbit/s <ul style="list-style-type: none"> <li>• Without PG interface</li> <li>• With PG interface</li> </ul>	<b>6ES7972-0BA52-0XA0</b> <b>6ES7972-0BB52-0XA0</b>
<b>PROFIBUS bus connector IP20</b> With connection to PPI, MPI, PROFIBUS <ul style="list-style-type: none"> <li>• Without PG interface</li> <li>• With PG interface</li> </ul>	<b>6ES7972-0BA12-0XA0</b> <b>6ES7972-0BB12-0XA0</b>
<b>PROFIBUS FC Standard Cable</b> 2-core bus cable, shielded, special design for fast mounting, delivery unit: max. 1 000 m, minimum order 20 m, sold by the meter	<b>6XV1830-0EH10</b>
<b>PROFIBUS bus terminal 12M</b> Bus terminal for connection of PROFIBUS nodes at up to 12 Mbit/s with connecting cable	<b>6GK1500-0AA10</b>
<b>SIMATIC S7-300 DM 370</b> Dummy module; used for module replacement	<b>6ES7370-0AA01-0AA0</b>

Note:

For software ordering data, see page 3/178

### Overview



DP-M	DP-S	FMS	PG/OP	S7/S5	
●	●		●	●	

- PROFIBUS DP master or slave with optical interface for connecting the SIMATIC S7-300 to PROFIBUS at up to 12 Mbit/s (including 45.45 Kbit/s)
- Direct connection to the optical PROFIBUS network over the integrated fiber-optic interface for plastic and PCF fiber-optic cables
- Communication services:
  - PROFIBUS DP
  - PG/OP communication (OP multiplexing)
  - S7 communication (client, server)
  - Open communication (SEND/RECEIVE)
- Easy configuration and programming over PROFIBUS
- Cross-network programming device communication through S7 routing
- Modules can be replaced without the need for a PG

### Benefits



- The fiber-optic technology is used when
  - the environment is subject to strong EMC interference,
  - strong potential differences exist and
  - high transmission rates are required.
- The CP 342-5 FO is connected directly to the optical PROFIBUS and is therefore specially suited to harsh industrial environments
- Expansion of the process I/O at SIMATIC S7-300 by several PROFIBUS DP interfaces
- Optimization of applications and many application options through sending of data with S7 communication
- Comprehensive control and monitoring through multiplex function with OP communication
- Suitable for closed loop control tasks due to SYNC and FREEZE.

### Application

The CP 342-5 FO is the communications processor of the SIMATIC S7-300 for the PROFIBUS DP optical bus system.

The CP 342-5 FO has a fiber optic interface that facilitates interference-immune connections even in environments with severe levels of radio interference.

It relieves the CPU of communications tasks.

Communication of the SIMATIC S7-300 with:

- the distributed I/O system ET 200 with integral optical interface
- SIMATIC S7-400 with IM 467 FO and CP 342-5 FO
- PC with CP 5613 FO
- Remaining PROFIBUS nodes via the optical bus terminal (OBT)

The number of CPs that can be used is dependent on the performance range of the CPU and on the communications services used.

### Design

The CP 342-5 FO offers all the advantages of SIMATIC S7-300 system design:

- Compact design; single standard width of the SM modules of the SIMATIC S7-300
- Integrated fiber-optic cable interface; 2 female duplex connectors for direct connection to the optical PROFIBUS over 2 x 2 male simplex connectors and 2 plug-in adapters
- 4-pin terminal block for connecting the external supply voltage of 24 V DC
- Easy installation; the CP 342-5 FO is snap-mounted on the S7-300 DIN rail and connected to adjacent modules through the bus connectors. There are no slot rules.
- In combination with IM 360/361, the CP 342-5 FO can also be used in an expansion rack (ER).
- User-friendly wiring; female FOC connector and the terminal block are easily accessible.
- The CP 342-5 FO can be operated without a fan; a back-up battery or a memory module are not required.

## PROFIBUS

### Communication for SIMATIC S7-300

#### CP 342-5 FO

#### Function

The CP 342-5 FO provides access to different communication services of the PROFIBUS bus system:

- PROFIBUS DP (according to IEC 61 158/61784, master or slave)
- PG/OP communication
- S7 communication
- Open communication (SEND/RECEIVE)

#### **PROFIBUS DP master**

The CP 342-5 FO operates as a DP-V0 Master according to IEC 61 158/EN 50 170 Volume 2 and processes the data transfer completely independently. It supports the services of the Master Classes 1 and 2.

The data areas of the distributed I/Os are transferred consistently between CP and CPU. This applies to the use of the CP as DP Master and as DP Slave. As DP Master, it permits connections to:

- The distributed IO system ET 200 with integral optical interface (incorporate as DP-V0 Slave)
- SIMATIC S7-300 with CP 342-5 FO as slave
- The remaining DP-V0 slaves via the optical bus terminal (OBT).

The CP 342-5 FO also offers the SYNC, FREEZE and shared input/output functions, as well as the activation/deactivation of slaves.

#### **PROFIBUS DP slave**

The CP 342-5 FO as a DP-V0 Slave allows the SIMATIC S7-300 to exchange data with the SIMATIC S7-400 and with other PROFIBUS DP masters via the OBT, which allows a hybrid setup between SIMATIC S5/S7, PCs, ET 200 and other field devices to PROFIBUS DP. Function calls are required for DP communication, both as master and as slave. These (DP-SEND/DP-RECV) are shipped with STEP 7 and must be integrated in the user program.

#### **PG/OP communication**

PG/OP communication allows all S7 stations connected to the network to be remotely programmed.

- S7 routing:  
With the aid of S7 routing it is possible to use programming device communication across networks.  
Via the CP 342-5 FO as many as 16 TD/OPs can be merged into one S7-300 station. This requires only one connection resource in the S7-CPU (multiplex channel). The multiplex channel supports the acyclic HMI services.

#### **S7 communication**

S7 communication is used for the coupling

- between SIMATIC S7 automation systems
- to HMI devices (OPs).
- to PCs, e.g. CP 5711 with SOFTNET-PB S7, CP 5623 etc.

Communication with PG and OP takes place without further configuration. In addition, the central controller can also be programmed and configured on a distributed basis via the CP 342-5 FO.

The client functionality is provided by means of loadable communication blocks.

#### **Open communication (SEND/RECEIVE)**

Based on Layer 2 (FDL) of PROFIBUS (IEC 61158/EN 50170), the CP 342-5 FO offers a simple, optimized interface for process or field communication. This interface offers integrated, high-performance communication between SIMATIC S5, SIMATIC S7, SIMATIC 505 and PC.

SEND/RECEIVE provides not only the SDA service (PLC/PLC connections) but also the SDN service (broadcast, multicast).

The communication partners are the automation systems:

- SIMATIC S7  
with CP 342-5, CP 343-5, CP 443-5 Extended and Basic
- SIMATIC S5  
with S5-95U with PROFIBUS interface, S5-115U/H, S5-135U, S5-155U/H with CP 5431 FMS/DP
- SIMATIC 505  
with CP 5434-FMS
- PCs  
CP 5512, CP 5611 A2, CP 5621, CP 5613 A3, CP 5613 FO, CP 5614 A3, CP 5623, CP 5624
- Systems of other makes that are equipped with an FDL interface.

To use SEND/RECEIVE, function calls are required (PLC-SEND/PLC-RECEIVE), which must be linked into the STEP 7 user program.

#### **Diagnostics**

Extensive diagnostic options are available via STEP 7, including:

- Status of the CP
- General diagnostics and statistics functions
- Connection diagnostics
- Bus statistics
- Message buffer

STEP 7 V5.1 SP2 or higher, or STEP 7 Professional V12 (TIA Portal) or higher, is required for configuring the full functional scope of the CP 342-5 FO. In Version V5 or higher of STEP 7, the configuration data of the CP can also optionally be stored on the CPU and is retained even if there is a power failure. A module can therefore be replaced without having to reload the configuration data from a programming device. The CPU transfers the configuration data to the CP during start-up. Attention should therefore be paid to the memory capacity of the S7-CPU.

Configuration and programming of all SIMATIC S7 controllers connected to the network is possible over the network.

The function blocks for PROFIBUS DP are included in the standard library of STEP 7. The function blocks for using the open communication (SEND/RECEIVE) and the S7 communication (S7 client) can be found in the SIMATIC NET library following installation of STEP 7.

### Function (continued)

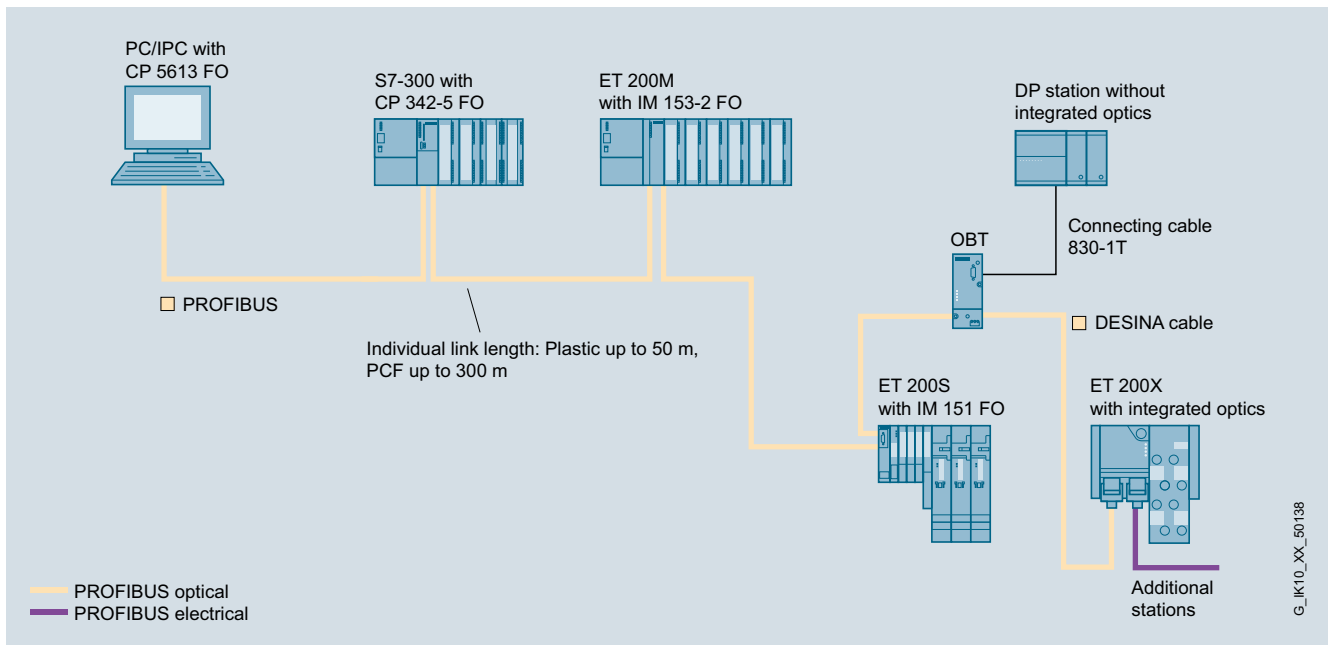

System configuration of optical PROFIBUS DP with CP 342-5 FO

### Technical specifications

Article No.	6GK7342-5DF00-0XE0	Article No.	6GK7342-5DF00-0XE0
<b>Product-type designation</b>	CP 342-5 FO	<b>Product-type designation</b>	CP 342-5 FO
<b>Transmission rate</b>		<b>Permitted ambient conditions</b>	
Transmission rate at interface 1 in accordance with PROFIBUS	9.6 kbit/s ... 12 Mbit/s	Ambient temperature	
<b>Interfaces</b>		• during operating	0 ... 60 °C
Number of optical connections at interface 1 in accordance with PROFIBUS	2	• during storage	-40 ... +70 °C
Number of electrical connections for power supply	1	• during transport	-40 ... +70 °C
Design of optical connection at interface 1 in accordance with PROFIBUS	Duplex socket	• Comment	-
Design of the electrical connection for power supply	4-pin terminal strip	Relative humidity at 25 °C without condensation during operating maximum	95 %
<b>Supply voltage, current consumption, power loss</b>		Protection class IP	IP20
Type of supply voltage	DC	<b>Design, dimensions and weight</b>	
Supply voltage		Module format	Compact module
• 1 from backplane bus	5 V	Width	40 mm
• external	24 V	Height	125 mm
Relative positive tolerance at 24 V with DC	20 %	Depth	120 mm
Relative negative tolerance at 24 V with DC	15 %	Net weight	0.3 kg
Consumed current		<b>Product properties, functions, components general</b>	
• from backplane bus at 5 V for DC Typical	0.15 A	Number of modules	
• from external supply voltage at 24 V with DC		• per CPU maximum	4
- typical	0.25 A	• note	-
- maximum	-	Cable length	
Resistive loss	6 W	• with PCF cable maximum	300 m
		• with POF cable maximum	50 m

# PROFIBUS

## Communication for SIMATIC S7-300

### CP 342-5 FO

#### Technical specifications (continued)

Article No.	6GK7342-5DF00-0XE0	Article No.	6GK7342-5DF00-0XE0
Product-type designation	CP 342-5 FO	Product-type designation	CP 342-5 FO
<b>Performance data</b>		<b>Performance data</b>	
<u>Performance data open communication</u>		<u>Performance data S7 communication</u>	
Number of possible connections for open communication by means of SEND/RECEIVE blocks maximum	16	Number of possible connections for S7 communication	
Data volume as user data per connection for open communication by means of SEND/RECEIVE blocks maximum	240 byte	• maximum	16
<u>Performance data PROFIBUS DP</u>		• with PG connections maximum	-
Service as DP master DPV0	Yes	• with PG/OP connections maximum	-
Number of DP slaves on DP master usable	124	• note	-
Amount of data		<u>Performance data multi-protocol mode</u>	
• of the address area of the inputs as DP master overall	2 160 byte	Number of active connections with multi-protocol mode	
• of the address area of the outputs as DP master overall	2 160 byte	• without DP maximum	32
• of the address area of the inputs per DP slave	244 byte	• with DP maximum	28
• of the address area of the outputs per DP slave	244 byte	<b>Product functions management, configuration</b>	
• of the address area of the diagnostic data per DP slave	240 byte	Configuration software required	STEP 7 V5.1 SP2 or higher / STEP 7 Professional V12 (TIA Portal) or higher
Service as DP slave			
• DPV0	Yes		
• DPV1	-		
Amount of data			
• of the address area of the inputs as DP slave overall	240 byte		
• of the address area of the outputs as DP slave overall	240 byte		

#### Ordering data

#### Article No.

<b>CP 342-5 FO communications processor</b>	<b>6GK7342-5DF00-0XE0</b>
Communication processor for optical connection of SIMATIC S7-300 to PROFIBUS to 12 Mbit/s with electronic manual on CD-ROM	
<b>Accessories</b>	
<b>PROFIBUS Plastic Fiber Optic, Simplex Connector/Polishing Set</b>	<b>6GK1901-0FB00-0AA0</b>
100 simplex connectors and 5 polishing sets for assembling PROFIBUS plastic fiber optic cables for the optical PROFIBUS DP	
<b>PROFIBUS Plastic Fiber Optic, stripping tool set</b>	<b>6GK1905-6PA10</b>
Tools for removing the outer sheath or core sheath of Plastic Fiber Optic cables	
<b>Plug-in adapter</b>	<b>6ES7195-1BE00-0XA0</b>
For assembling the plastic Simplex connector in combination with CP 342-5 FO, IM 467 FO, IM 153-2 FO and IM 151 FO	
50 units	

#### Note:

For software ordering data, see page 3/178

### Overview



DP-M	DP-S	FMS	PG/OP	S7/S5	
●			●	●	●

- PROFIBUS DP master with electrical interface for connecting the SIMATIC S7-400 to PROFIBUS at up to 12 Mbit/s (including 45.45 Kbit/s)
- For setting up additional PROFIBUS DP lines
- Communication services:
  - PROFIBUS DP
  - PG/OP communication
  - S7 communication
  - Open communication (SEND/RECEIVE)
- Time synchronization
- Easy programming and configuration over PROFIBUS
- Cross-network programming device communication through S7 routing
- Can be easily integrated into the SIMATIC S7-400 system
- Module replacement without PG
- SIMATIC H system operation for redundant S7 communication or DP master communication
- Data record routing (PROFIBUS DP)
- Adding or modifying distributed I/O during operation

### Benefits



- Increased plant availability thanks to redundant connection of the process I/O (e.g. ET 200M) in the SIMATIC S7-400 H system
- Particularly suitable for closed-loop control tasks thanks to SYNC/FREEZE and equidistant bus cycle
- Sub-process-oriented design of an automation solution through the use of several CPs
- Universal application of the CP due to the parallel use of different communication services on one CP
- Lower costs due to flexible and reaction-free commissioning by means of CiR (Configuration in RUN)

### Application

The CP 443-5 Extended is the communications processor of the SIMATIC S7-400 for the PROFIBUS bus system.

It relieves the CPU of communication tasks and supports additional connections.

Communication possibilities of the S7-400 using communication modules:

- As master for PROFIBUS DP according to IEC 61158/EN 50170
- Communication with programming devices and HMI devices
- Communication with other SIMATIC S7 systems
- Communication with SIMATIC S5 programmable controllers

The number of CPs that can be used is dependent on the performance range of the CPU and on the communications services used.

### Design

The CP 443-5 Extended communications processor features all the advantages of the SIMATIC S7-400 design:

- Compact construction; 9-pin Sub-D socket for connection to PROFIBUS DP
- Single-width module
- Easy installation; the CP 443-5 is mounted on the S7-400 rack and connected to the other modules of the S7-400 by means of the backplane bus.
- User-friendly wiring; the Sub-D socket is easily accessible and simple to operate.
- The CP 443-5 Extended can be operated without a fan. A backup battery or memory module is not required
- A maximum of 14 CPs can be operated.

If the CP 443-5 Extended is used as a DP Master, at least four and as many as 10 additional PROFIBUS DP lines can be set up in the central rack. The number of possible PROFIBUS DP lines depends on the SIMATIC S7-400 CPU that is used.

When using S7-communication, no slot allocation rules apply. The number of operable S7 connections depends on the S7-400 CPU.

When using SEND/RECEIVE, the number of operable DP modules also depends on the S7-400 CPU.

## PROFIBUS

### Communication for SIMATIC S7-400

#### CP 443-5 Extended

##### Function

The CP 443-5 Extended provides access to different communication services of the PROFIBUS bus system:

- PROFIBUS DP (according to IEC 61158/61784)
- PG/OP communication
- S7 communication (S7 controllers)
- Open communication (SEND/RECEIVE)
- Time synchronization

##### Master for PROFIBUS DP

The CP 443-5 Extended operates as DP-V1 master. It processes data transfer autonomously and allows slaves to be connected, such as CP 342-5 as DP slave, DP slaves of the ET 200 distributed I/O system, etc. This means that the CP 443-5 Extended is able to connect the S7-400 station to PROFIBUS DP and is the ideal expansion to the integral DP master interfaces of the S7-400 CPUs for establishing additional PROFIBUS DP lines.

The CP 443-5 Extended can also be used in the SIMATIC S7 H system as a redundant DP master.

The CP 443-5 Extended is a DP-V1 master, i.e. it also supports the acyclic standard services incl. interrupt handling.

The CP 443-5 Extended also supports the SYNC and FREEZE functions, constant bus cycle time, direct slave-to-slave traffic, data set routing and changes to the configuration of the assigned distributed I/O during normal operation.

During normal operation, it is also possible to activate or deactivate DP slaves. This supports the step-by-step start-up of subprocesses, for example.

A diagnostic repeater allows the line to be diagnosed during operation, enabling line faults to be detected at an early stage. The CP 443-5 Extended supports operation with diagnostic repeater (including activation of topology identification in the diagnostic repeater).

The distributed I/Os are handled like central I/Os from the user's point of view. This means that there are no differences between the CP 443-5 Extended and the integral DP master interface of the S7-400 CPU with regard to configuration and parameterization. Depending on the scale of the system, the CP 443-5 Extended has extremely short response times.

##### PG/OP communication

PG/OP communication allows all S7 stations connected to the network to be remotely programmed.

- S7 routing  
With the aid of routing it is possible to use programming device communication across networks.

##### S7 communication

S7 communication is used for the coupling

- between SIMATIC S7 programmable controllers
- to programming devices (PG/OP communication)
- to PCs, e.g. CP 5711 with SOFTNET-PB S7, CP 5623 etc.
- to HMI devices (OPs).

For redundant S7 communication, the CP 443-5 Extended can also be used in SIMATIC H systems.

##### Open communication (SEND/RECEIVE)

SIMATIC S7-400 is integrated into existing systems by means of open communication.

Based on Layer 2 (FDL) of PROFIBUS, the CP 443-5 Extended offers a simple, optimized interface for process or field communication. This interface offers uniform, high-performance communication between SIMATIC S5, SIMATIC S7 and the PC. It provides the services SDA (PLC/PLC connections) and SDN (Broadcast, Multicast).

The communication partners are the programmable controllers

- SIMATIC S7  
with CP 342-5, CP 343-5, CP 443-5 Extended and Basic
- SIMATIC S5  
with S5-95U with PROFIBUS interface, S5-115U/H, S5-135U, S5-155U/H with CP 5431 FMS/DP
- SIMATIC 505  
with CP 5434-FMS
- PCs  
with CP 5512, CP 5611 A2, CP 5621, CP 5613 A3, CP 5613 FO, CP 5614 A3, CP 5623, CP 5624
- Non-Siemens systems that are equipped with an FDL interface.

To use SEND/RECEIVE, function calls are required (PLC-SEND/PLC-RECEIVE), which must be linked into the STEP 7 user program.



### Function (continued)

#### Time synchronization

Time synchronization is used to set the time of day throughout the plant.

The CP 443-5 Extended is capable of forwarding the time of day of the S7-400 CPU to PROFIBUS. Conversely, the CP of the S7-400 CPU can make an existing time of day available on PROFIBUS

The CP 443-5 Extended supports

- The time-stamping of distributed process signals in combination with IM 153
- Time status value, daylight-saving time changeover, synchronization status

#### Data set routing

The CP 443-5 Extended supports the data set routing function. With this option, the CP can be used as a router for data sets that have to be sent to field devices (DP slaves). SIMATIC PDM (Process Device Manager) is a tool that creates data sets of this type for parameterizing and diagnosing field devices.

#### Application:

It is possible, for example, to use SIMATIC PDM (on the PC) to set parameters and perform diagnostics for a PA field device over Industrial Ethernet, S7-400 (CP 443-1, CP 443-5 Extended) and DP/PA Coupler/Link.

#### Diagnostics data

Extensive diagnostic options are available via STEP 7, including:

- Status of the CP
- General diagnostics and statistics functions
- Connection diagnostics
- Bus statistics
- Message buffer
- Support of operation with diagnostic repeater

#### CiR – Configuration in RUN

With CiR, it is possible to add or modify distributed I/O devices during normal operation.

- Adding PROFIBUS DP/PA slaves
- Adding/removing modules (e.g. I/O modules) in a modular DP slave (e.g. ET 200M and DP/PA Link)

#### Configuration

STEP 7 V5.1 SP2 or higher, or STEP 7 Professional V12 (TIA Portal) or higher, is required for configuring the full functional scope of the CP 443-5 Extended.

DP configuration/programming is performed for the CP 443-5 Extended in the same manner as for DP configuration/programming of the integrated DP interfaces of the SIMATIC S7-400 CPUs with STEP 7.

The configuring data of the CPs are always saved on the CPU and are retained even after a PLC failure. A module can therefore be replaced without having to reload the configuration data from a programming device. The CPU transfers the configuration data to the CP during start-up.

Configuration and programming of all SIMATIC S7 controllers connected to the network is possible over the network.

The function blocks for using the open communication (SEND/RECEIVE) can be found in the SIMATIC NET library following installation of STEP 7.

# PROFIBUS

## Communication for SIMATIC S7-400

### CP 443-5 Extended

#### Technical specifications

Article No.	6GK7443-5DX05-0XE0
Product-type designation	CP 443-5 Extended
<b>Transmission rate</b>	
Transmission rate at interface 1 in accordance with PROFIBUS	9.6 kbit/s ... 12 Mbit/s
<b>Interfaces</b>	
Number of electrical connections at interface 1 in accordance with PROFIBUS	1
Design of electrical connection at interface 1 in accordance with PROFIBUS	9-pin Sub-D socket (RS485)
<b>Supply voltage, current consumption, power loss</b>	
Type of supply voltage	DC
Supply voltage 1 from backplane bus	5 V
Relative symmetrical tolerance at 5 V with DC	5 %
Consumed current from backplane bus at 5 V for DC Typical	0.6 A
Resistive loss	5.5 W
<b>Permitted ambient conditions</b>	
Ambient temperature	
• during operating	0 ... 60 °C
• during storage	-40 ... +70 °C
• during transport	-40 ... +70 °C
• Comment	-
Relative humidity at 25 °C without condensation during operating maximum	95 %
Protection class IP	IP20
<b>Design, dimensions and weight</b>	
Module format	Compact module S7-400 single width
Width	25 mm
Height	290 mm
Depth	210 mm
Net weight	0.65 kg
<b>Product properties, functions, components general</b>	
Number of modules	14
• per CPU maximum	
• note	The number of CPs that can be operated as DP masters depends on the number of CP 443-1 Advanced processors operating in the S7-400 station as PROFINET IO controllers. Up to 10 CPs can be operated in total: up to 4 as PROFINET IO controllers (CP 443-1 Advanced); up to 10 as DP masters (CP 443-5 Extended)

Article No.	6GK7443-5DX05-0XE0
Product-type designation	CP 443-5 Extended
<b>Performance data</b>	
<u>Performance data open communication</u>	
Number of possible connections for open communication by means of SEND/RECEIVE blocks maximum	32
Data volume as user data per connection for open communication by means of SEND/RECEIVE blocks maximum	240 byte
<u>Performance data PROFIBUS DP</u>	
Service as DP master DPV1	Yes
Number of DP slaves on DP master usable	125
Amount of data	
• of the address area of the inputs as DP master overall	4 096 byte
• of the address area of the outputs as DP master overall	4 096 byte
• of the address area of the inputs per DP slave	244 byte
• of the address area of the outputs per DP slave	244 byte
<u>Performance data S7 communication</u>	
Number of possible connections for S7 communication	
• maximum	48
• with PG connections maximum	-
• with PG/OP connections maximum	-
• note	-
<u>Performance data multi-protocol mode</u>	
Number of active connections with multi-protocol mode	
• without DP maximum	59
• with DP maximum	54
<b>Product functions management, configuration</b>	
Configuration software required	STEP 7 V5.4 SP4 or higher / STEP 7 Professional V12 (TIA Portal) or higher

Ordering data	Article No.
<b>Communications processor CP 443-5 Extended</b> for connection of the SIMATIC S7-400 to PROFIBUS Extended version for PROFIBUS DP; with electronic manual on CD-ROM	<b>6GK7443-5DX05-0XE0</b>
<i>Accessories</i>	
<b>PROFIBUS FastConnect connection plug RS485</b> With 90° cable outlet; insulation displacement technology, max. transmission rate 12 Mbit/s • Without PG interface	<b>6ES7972-0BA52-0XA0</b>
<b>PROFIBUS bus connector IP20</b> With connection to PPI, MPI, PROFIBUS • Without PG interface • With PG interface	<b>6ES7972-0BA12-0XA0</b> <b>6ES7972-0BB12-0XA0</b>
<b>PROFIBUS FC Standard Cable</b> 2-core bus cable, shielded, special design for fast mounting, delivery unit: max. 1 000 m, minimum order 20 m, sold by the meter	<b>6XV1830-0EH10</b>
<b>PROFIBUS bus terminal 12M</b> Bus terminal for connection of PROFIBUS nodes at up to 12 Mbit/s with connecting cable	<b>6GK1500-0AA10</b>

Note:

For software ordering data, see page 3/178

# PROFIBUS

## Communication for SIMATIC S7

### Software

#### Ordering data

#### Article No.

#### Article No.

##### Software

#### STEP 7 Professional Engineering Software (TIA Portal)

*Target system:*  
SIMATIC S7-1200, S7-1500, S7-300, S7-400, WinAC

*Requirement:*  
Windows 7 Professional (64 bit),  
Windows 7 Enterprise (64 bit),  
Windows 7 Ultimate SP1 (64 bit),  
Windows 8.1 (64 bit),  
Windows 8.1 Professional (64 bit),  
Windows 8.1 Enterprise (64 bit),  
Windows Server 2008 R2 StdE  
(full installation),  
Windows Server 2012 StdE  
(full installation)

*Form of delivery:*  
German, English, Chinese, Italian,  
French, Spanish

*For CM 1242-5, CM 1243-5,  
CM 1542-5, CP 1542-5, CP 342-5,  
CP 342-5 FO, CP 443-5 Extended*

- STEP 7 Professional V13, Floating License
- STEP 7 Professional V13, Trial License
- Upgrade STEP 7 Professional V12 to STEP 7 Professional V13, Floating License
- Upgrade STEP 7 Professional 2006/2010 to STEP 7 Professional 2010/V13, Floating License
- PowerPack & upgrade from STEP 7 V5.4/V5.5 to STEP 7 Professional 2010/V13, Floating License
- PowerPack STEP 7 Basic V13 to STEP 7 Professional V13, Floating License

6ES7822-1AA03-0YA5

6ES7822-1AA03-0YA7

6ES7822-1AA03-0YE5

6ES7822-1AA03-0XE5

6ES7822-1AA03-0XC5

6ES7822-1AA03-0YC5

#### STEP 7 Professional engineering software V13; software download incl. license key<sup>1)</sup>

E-mail address required for the delivery

- STEP 7 Professional V13, Floating License
- Upgrade STEP 7 Professional V12 to STEP 7 Professional V13, Floating License
- Upgrade STEP 7 Professional 2006/2010 to STEP 7 Professional 2010/V13, Floating License
- PowerPack & upgrade from STEP 7 V5.4/V5.5 to STEP 7 Professional 2010/V13, Floating License
- PowerPack STEP 7 Basic V13 to STEP 7 Professional V13, Floating License

6ES7822-1AE03-0YA5

6ES7822-1AE03-0YE5

6ES7822-1AE03-0XE5

6ES7822-1AE03-0XC5

6ES7822-1AA03-0YC5

#### STEP 7 Basic Engineering Software V13 (TIA Portal)

*Target system:*  
SIMATIC S7-1200, S7-1500, S7-300, S7-400, WinAC

*Requirement:*  
Windows 7 Professional (64 bit),  
Windows 7 Enterprise (64 bit),  
Windows 7 Ultimate SP1 (64 bit),  
Windows 8.1 (64 bit),  
Windows 8.1 Professional (64 bit),  
Windows 8.1 Enterprise (64 bit),  
Windows Server 2008 R2 StdE  
(full installation),  
Windows Server 2012 StdE  
(full installation)

*Form of delivery:*  
German, English, Chinese, Italian,  
French, Spanish

*For CM 1242-5, CM 1243-5*

- STEP 7 Basic V13, Floating License
- STEP 7 Basic V13, Trial License
- Upgrade STEP 7 Basic V12 to STEP 7 Professional V13, Floating License

6ES7822-0AA03-0YA5

6ES7822-0AA03-0YA7

6ES7822-0AA03-0YE5

#### Software Update Service

For a period of 12 months and for a fixed price, the customer is automatically provided with all upgrades and service packs for each installed software package. The contract is automatically extended by a further year unless canceled at least 12 weeks prior to expiration. Requires the current software version.

- STEP 7 Basic V1x, Software Update Service Standard, 1 year
- STEP 7 Basic V1x, Software Update Service Compact, 1 year

6ES7822-0AA00-0YL0

6ES7822-0AA00-0YM0

#### STEP 7 Version 5.5

*Target system:*  
SIMATIC S7-300/400, SIMATIC C7, SIMATIC WinAC

*Requirements:*  
Windows XP Prof.,  
Windows 7 Professional/Ultimate

*Type of delivery:*  
German, English, French, Spanish, Italian;  
including license key on USB stick, with electronic documentation

*For CP 342-5, CP 342-5 FO, CP 443-5 Extended*

- Floating License on DVD
- Rental License for 50 hours
- Software Update Service on DVD (requires current software version)
- Floating license upgrade 3.x/4.x/5.x to V5.4; on DVD
- Trial license STEP 7 V5.4; on DVD, operational for 14 days

6ES7810-4CC10-0YA5

6ES7810-4CC10-0YA6

6ES7810-4BC01-0YX2

6ES7810-4CC10-0YE5

6ES7810-4CC10-0YA7

<sup>1)</sup> For up-to-date information and download availability, see: <http://www.siemens.com/tia-online-software-delivery>

### Overview

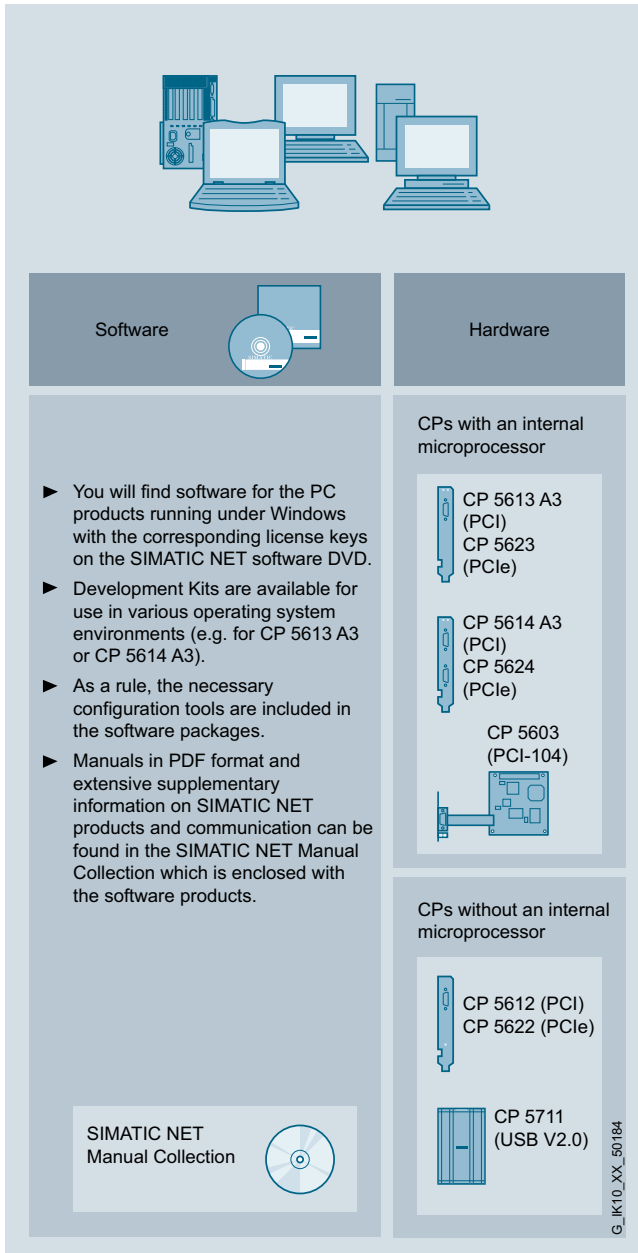

System connection for PG/PC

#### **PC card with an internal microprocessor**

Recommended solution for:

- PC-based control systems (Soft Control, PLC, Numeric Control, Robot Control)
- Process control systems
- Operator control and monitoring systems (HMI)
- PROFIBUS DP slave connection (CP 5614 A3, CP 5624)
- PROFIBUS plants with large quantity framework (more than 8 stations)
- Multi-protocol operation
- Use of several CPs in one system

#### **PC card without an internal microprocessor**

Recommended solution for:

- Configuring tools (e.g. STEP 7)
- PROFIBUS DP diagnostics station (e.g. as DP master Class 2)
- PROFIBUS DP slave connection
- PROFIBUS systems with up to 8 stations
- Mono protocol mode

## PROFIBUS

### Communication for PC-based systems

#### Performance data

##### Overview

The following communications processors are available for connecting to the programming device or PC:

- CPs with an internal microprocessor:  
CP 5613 A3 (PCI), CP 5614 A3 (PCI), CP 5623 (PCle), CP 5624 (PCle), CP 5603 (PCI-104)
- CPs without an internal microprocessor:  
CP 5612 (PCI), CP 5622 (PCle), CP 5711 (USB)

##### Performance of PROFIBUS CPs

The maximum performance specifies how much digital input/output data can be read or written in 1 ms from the PROFIBUS application over the respective PROFIBUS CP (regardless of the physical characteristics of the bus).

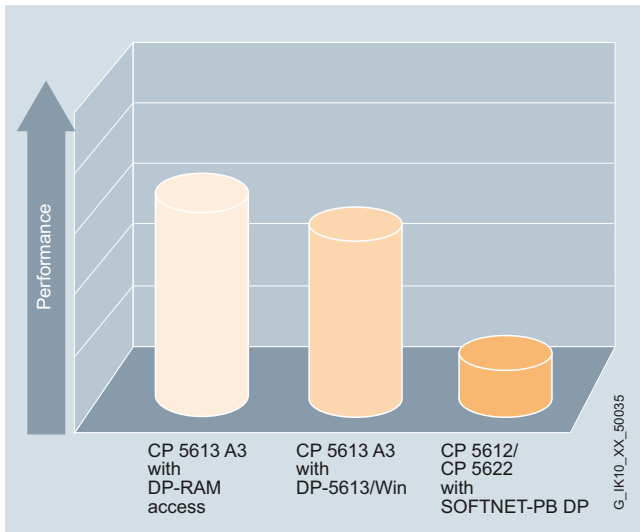

Performance under almost identical CPU loading

##### CPU loading and access time

If event access (using interrupts) and polling access are compared, it can be shown that the CPU loading can be significantly reduced with the CP 5613 A3 using the event/filter mechanism – for the same data throughput.

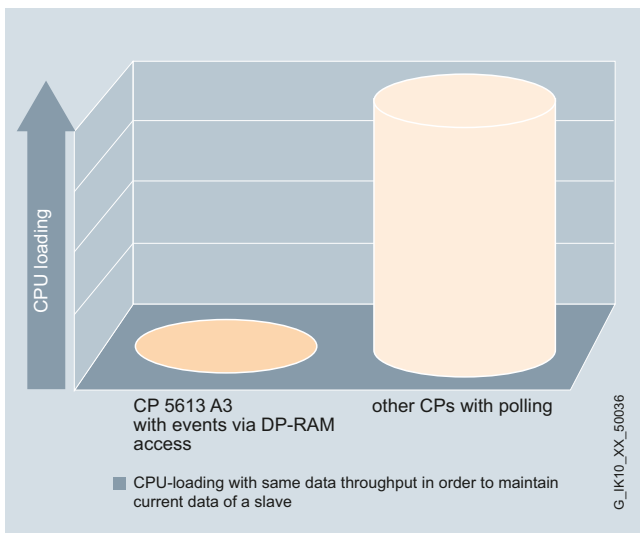

Comparison of loading on the CPU with event access and with polling access

##### Performance data of PROFIBUS CPs

		CP 5613 A3	CP 5614 A3	CP 5612/ CP 5622
Number of connectable DP slaves	max	124	124	64
Number of FDL tasks waiting	max	80	80	50
Number of PG/OP and S7 connections	max	50 <sup>1)</sup>	50 <sup>1)</sup>	8

Note:

<sup>1)</sup> With credit = 1; PDU size ≤ 480 bytes

##### Configuration for SIMATIC NET version V12 or higher:

STEP 7 V12 or higher is used for PC configuration. The STEP 7 software is included in the scope of delivery of the SIMATIC NET software products. A STEP 7 license is not required for PC configuration.

##### Configuration for SIMATIC NET versions up to V8.2:

The PC can be configured either in STEP 7 or in NCM PC Version V5.1+SP2 and higher. Both tools offer the same 'look & feel' and create the same database. This enables integrated configuration of the open communication and S7 communication functions. Data only has to be entered once and data consistency is assured.

- A configuration wizard integrated into NCM PC also supports user-driven configuration of the PC station.
- With NCM PC and STEP 7 from Version V5.1+SP2 upwards, a PC similar to a SIMATIC S7 station can be configured and loaded over a network. This applies both to the local station on which NCM PC or STEP 7 is installed and to the remote station that is addressed over the network.

Note:

NCM PC does not contain a conversion function for LDBs that were created using COM1 S7. Reconfiguration is necessary.

##### More information

You can find more information on the Internet at:

<http://support.automation.siemens.com/WW/view/en/15227599>

**Overview**

Communication hardware	Communication software	Operating system environment of the communication software								SIMATIC Industrial PC/ Field PG								Embedded Systems				
		Windows 7 Professional / Ultimate SP1	Windows 8.1 Pro / Enterprise	Windows Server 2008 R2 SP1	Windows Server 2012 R2	Windows Server 2008 + SP1/2	Windows XP Pro + SP3	Windows Server 2003 R2 / SP2	other operating systems	Field PG M4	SIMATIC IPC227D + IPC 277D	SIMATIC IPC427D + IPC 477D	SIMATIC IPC547E	SIMATIC IPC627D	SIMATIC IPC647D	SIMATIC HMI IPC677D	SIMATIC IPC687D	SIMATIC IPC847D	Windows Embedded Standard 2009	Windows Embedded Standard 7 + SP1	SIMATIC IPC427D + 477D + IPC 227D/277D	SIMATIC S7 modular Embedded Controller
<b>CPs and software for PROFIBUS</b>																						
CP 5603 (PCI-104)	CP with DP-Base	●	●	●	●	●	●	●			●								●	●	●	
	HARDNET-PB DP DK 1)	○	○	○	○	○	○	○	○		○								○	○	○	○ <sup>5)</sup>
	HARDNET-PB DP	●	●	●	●	●	●	●			●								●	●	●	
	HARDNET-PB S7	●	●	●	●	●	●	●			●								●	●	●	
CP 5613 A2, CP 5614 A2 (PCI 32 Bit)	CP with DP-Base	●	●	●	●	●	●	●			●	●	●	●	●	●						
	HARDNET-PB DP DK 1)	○	○	○	○	○	○	○	○		○	○	○	○	○	○			○	○		
	HARDNET-PB DP	●	●	●	●	●	●	●			●	●	●	●	●	●						
	HARDNET-PB S7	●	●	●	●	●	●	●			●	●	●	●	●	●						
CP 5613 A3, CP 5614 A3 (PCI 32 Bit)	CP with DP-Base	●	●	●	●	●	●	●			●	●	●	●	●	●						
	HARDNET-PB DP DK 1)	○	○	○	○	○	○	○	○		○	○	○	○	○	○			○	○		
	HARDNET-PB DP	●	●	●	●	●	●	●			●	●	●	●	●	●						
	HARDNET-PB S7	●	●	●	●	●	●	●			●	●	●	●	●	●						
CP 5623, CP 5624 (PCIe x1)	CP with DP-Base	●	●	●	●	●	●	●			●	○ <sup>4)</sup>		○ <sup>4)</sup>	●	● <sup>4)</sup>				●		
	HARDNET-PB DP DK 1)	○	○	○	○	○	○	○	○		○	○		○ <sup>4)</sup>	○	○			○	○		
	HARDNET-PB DP	●	●	●	●	●	●	●			●	○ <sup>4)</sup>		○ <sup>4)</sup>	●	● <sup>4)</sup>				●		
	HARDNET-PB S7	●	●	●	●	●	●	●			●	○ <sup>4)</sup>		○ <sup>4)</sup>	●	● <sup>4)</sup>				●		
CP 5612 (PCI 32 Bit)	SOFTNET-PB DP	●	●	●	●	●	●	●			●	●	●	●	●	●						
	SOFTNET-PB DP Slave	●	●	●	●	●	●	●			●	●	●	●	●	●						
	SOFTNET-PB S7	●	●	●	●	●	●	●			●	●	●	●	●	●						
	S7 OPC Redundancy for PROFIBUS			●							●		●		●							
CP 5622 (PCIe x1)	SOFTNET-PB DP	●	●	●	●	●	●	●		●	●	○ <sup>4)</sup>		○ <sup>4)</sup>	●	● <sup>4)</sup>				●		
	SOFTNET-PB DP Slave	●	●	●	●	●	●	●		●	●	○ <sup>4)</sup>		○ <sup>4)</sup>	●	● <sup>4)</sup>				●		
	SOFTNET-PB S7	●	●	●	●	●	●	●		●	●	○ <sup>4)</sup>		○ <sup>4)</sup>	●	● <sup>4)</sup>				●		
	S7 OPC Redundancy for PROFIBUS			●							●		●		●							
CP 5711 (USB V2.0)	SOFTNET-PB DP	●	●	●	●	●	●	●		●	●	●	●	●	●	●			●	●	●	●
	SOFTNET-PB DP Slave	●	●	●	●	●	●	●		●	●	●	●	●	●	●			●	●	●	●
	SOFTNET-PB S7	●	●	●	●	●	●	●		●	●	●	●	●	●	●			●	●	●	●
	S7 OPC Redundancy for PROFIBUS			●						●		●		●		●						●
SIMATIC PG/PC	SOFTNET-PB DP	●	●	●	●	●	●	●		●		○ <sup>2)</sup>		○ <sup>2)</sup>	○ <sup>2)</sup>	○ <sup>2)</sup>	○ <sup>2)</sup>		●	●	○ <sup>2)</sup>	
	SOFTNET-PB DP Slave	●	●	●	●	●	●	●		●		○ <sup>2)</sup>		○ <sup>2)</sup>	○ <sup>2)</sup>	○ <sup>2)</sup>	○ <sup>2)</sup>		●	●	○ <sup>2)</sup>	
	SOFTNET-PB S7	●	●	●	●	●	●	●		●		○ <sup>2)</sup>		○ <sup>2)</sup>	○ <sup>2)</sup>	○ <sup>2)</sup>	○ <sup>2)</sup>		●	●	○ <sup>2)</sup>	
	S7 OPC Redundancy for PROFIBUS			●										○ <sup>2)</sup>				○ <sup>2)</sup>				

1) In order to use these CPs in other operating system environments, it is required to port HARDNET DP Development Kits (DK-5613) into the respective operating system. You can request the HARDNET DP DK in the Internet under [www.siemens.com/simatic-net/dk5613](http://www.siemens.com/simatic-net/dk5613).  
 2) integrated PROFIBUS interface is optional  
 3) depending on available memory and processor performance there could be restrictions  
 4) Observe restrictions for some PC versions: Number of slots and tolerable maximum heat loss/ power consumption per slot and in total  
 5) EM-PCI 104 expansion module is required

Notes  
 - Please always note the supplementary conditions for the specified SIMATIC NET products that you can view on the Internet pages shown below.  
 - for further details on XP embedded, see <http://support.automation.siemens.com/WWW/view/en/21661049>  
 - further details on system requirements and operating environments can be found in the Readme file of the communication products on the SIMATIC NET PC Software DVD  
 - Updates and supplements to the catalog entries, as well as the above tables can be viewed at <http://www.siemens.com/simatic-net/ik-info>

● suitable  
 ○ not suitable  
 ○ suitable under certain conditions

G\_IK10\_XX\_50025

Connection options of PROFIBUS CPs to PG/PC

Note:  
 The operating systems listed refer exclusively to the communication products specified!

For the actual operating system that is available and has been released, please refer to the description of the corresponding IPC.



## PROFIBUS

### Communication for PC-based systems

CP 5603

#### Overview

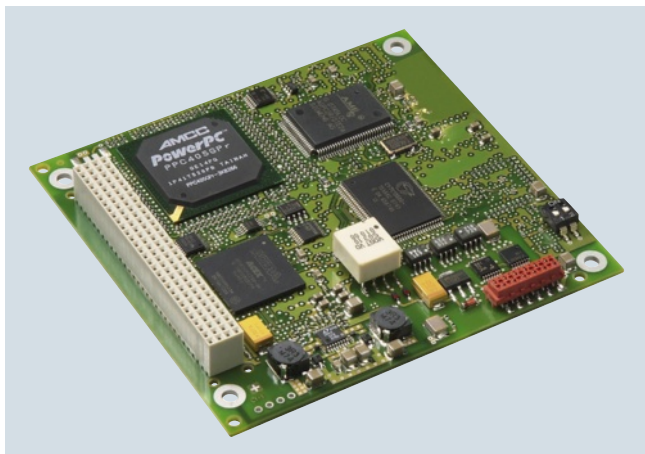

DP-M	DP-S	FMS	OPC	PG/OP	S7/S5
●	●	●	●	●	●

- PCI-104 interface card with own microprocessor for connecting embedded systems with PCI-104 interface to PROFIBUS at up to 12 Mbit/s
- Function compatible with CP 5613 A2
- Communication services:
  - PROFIBUS DP master Class 1 and 2 or DP slave according to IEC 61158/61784
  - PG/OP communication with STEP 5 and STEP 7
  - S7 communication with HARDNET-PB S7 software package
  - Open communication (SEND/RECEIVE) based on the FDL interface
  - PROFIBUS FMS according to IEC 61158/61784 with FMS-5613 software package
- Extensive diagnostics options for installation, commissioning and operation of the module
- Event and filter mechanism for reducing the load on the host CPU
- Multiprotocol operation and parallel operation of up to three CPs
- The appropriate OPC server and configuration tools are included in the scope of delivery of the respective communication software
- Development kit with driver sources for integration into "non-Windows" environments

#### Note:

FMS-5613 supports up to two CP 5603/CP 5613 A2/5614 A2/CP 5623/CP 5624 processors

#### Benefits

get Designed for Industry

- Fast process data exchange; access to process data by means of direct access to the dual port RAM of the hardware
- High computing performance in the PG/PC; reduces workload of host CPU by preprocessing the communication on the hardware
- Use of different operating system environments; driver as source code for porting to different operating system environments
- Use also in motion control applications; real-time capable data exchange through constant bus cycle time

#### Application



The CP 5603 allows the connection of embedded systems with a PC/104 Plus interface to PROFIBUS.

The CP 5603 also provides high-performance support to control tasks on the embedded system (PC-based Control, Numeric Control, Robot Control).



### Function

#### PROFIBUS DP

##### Access to process data with DP-Base

The CP 5603 is operated as PROFIBUS DP master module that keeps the process image (input/output and diagnostics data) in the dual port RAM (memory area on the CP). The hardware of the CP 5603 independently executes the high-performance exchange of data with the PROFIBUS slaves. The user accesses the dual-port RAM directly.

The process data of the slaves is always consistent, i.e. the user receives the data of a slave from one and the same DP cycle.

Parallel operation of the HARDNET-PB DP and DP-Base software is not possible.

##### Event filter mechanism

The user receives up-to-date data over two access mechanisms:

- Cyclic polling of the DP slaves (higher loading for host CPU)
- Notification through a new type of event/filter mode on changing the input data of a slave (minimal loading for host CPU)

Both alternatives can be combined. This allows users to optimize use of the PC for their applications.

The event/filter mechanism can be used additionally for

- Notification by means of an interrupt of the diagnostic messages from slaves
- During operation with constant bus cycle time, signaling by means of interrupt:
  - Start DP cycle
  - End of cyclic data exchange with DP slaves

##### FastLogic

FastLogic means that the CP 5603 can react autonomously to as many as 4 plant statuses. This results in a short response time and independence from the host application, e.g. fast shutdown of devices.

##### DP programming interface

The DP programming interface (DP-Base) of the CP 5603 has the following functionality:

- DP master class 1 including acyclic DP expansions
- DP master class 2 including acyclic DP expansions
- DP slave

The process data is accessed directly through the dual-port RAM. The DP RAM interface not only offers fast access as DP master/slave but also a basis for porting to other operating system environments (e.g. VXWorks, QNX, RMOS, RTX).

Administrative function calls (initialization and management services), as well as diagnostic functions) are provided through a library (DP\_BASE.DLL or DPS\_BASE.DLL).

##### HARDNET-PB DP Development Kit

The HARDNET-PB DP Development Kit provides access to the functions DP master Class 1 including acyclic DP expansions

The HARDNET-PB DP Development Kit software enables the CP 5603 communications processor to be integrated into any operating system environments. The kit contains the necessary source code, including the descriptions in PDF format, and can be downloaded free of charge from the Internet.

##### Access to process data with HARDNET-PB DP

HARDNET-PB DP is available to permit compatibility with older applications that were created with the DP-Lib interface.

Parallel operation of the DP-Base and HARDNET-PB DP software is not possible.

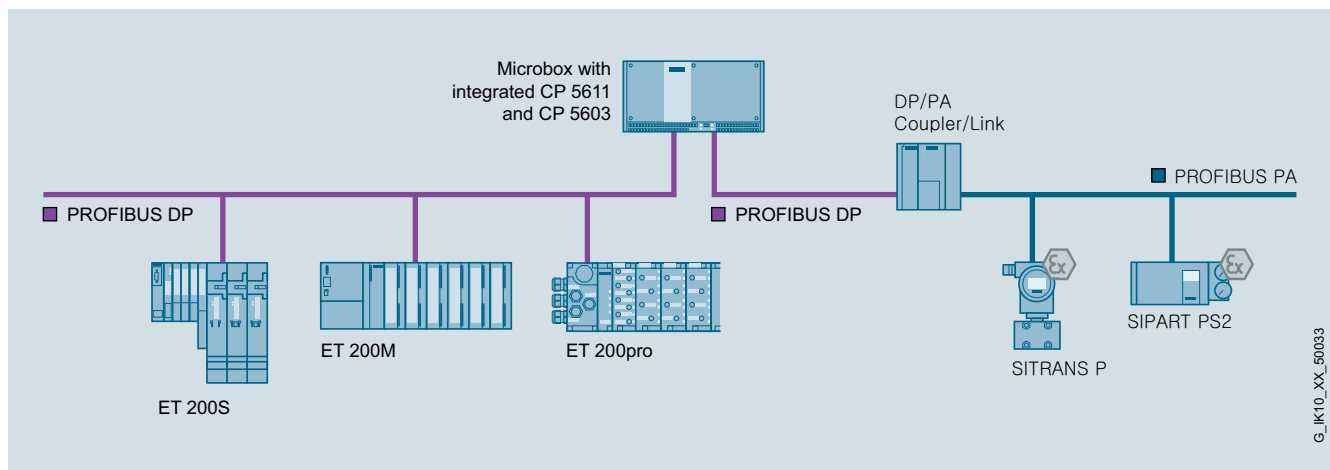

PROFIBUS DP connection with embedded PC SIMATIC Microbox

## PROFIBUS

### Communication for PC-based systems

#### CP 5603

#### Function (continued)

##### Software for PG/OP communication

This software supports programming of the SIMATIC S5/S7 controllers (with the exception of SIMATIC S5-95U) over PROFIBUS in combination with STEP 5/STEP 7. The PG/OP communication for the CP 5603 is already available following installation of the CP 5603 (DP-Base). No additional software packages are required.

##### Open communication (SEND/RECEIVE based on the FDL interface)

SEND/RECEIVE (FDL interface) is already available following installation of the CP 5603 (DP-Base) and provides services for data transfer, diagnostics and management. No additional software packages are required.

##### Software for S7 communication (HARDNET-PB S7)

SIMATIC S7 system components communicate with each other using S7 communication functions. The S7 programming interface provides programming device/PC user programs with access to SIMATIC S7 system components. This provides easy, flexible access to the data of the SIMATIC S7 controller.

The following services are available with S7 communication:

##### Administrative services

- Connection management
- Mini database
- Trace

##### Data transfer services

- Read/write variables
- BSEND/BRECEIVE (up to 64 KB per task)

##### Software for PROFIBUS FMS (FMS-5613)

With the FMS programming interface, PGs/PCs can exchange different manufacturer data with FMS-capable controllers (e.g. S5 and S7) and field devices. Open communication is assured by using the FMS interface.

The FMS interface offers the following services:

- Administrative services
- CRL management services
- FMS connection management services
- Object directory management services for clients and server
- Variable services for clients and servers (Read, Write, Information Report)
- Server functionality
- VFD services (Virtual Field Device) for clients and servers
- Bus access information services (live list)
- Trace and mini database

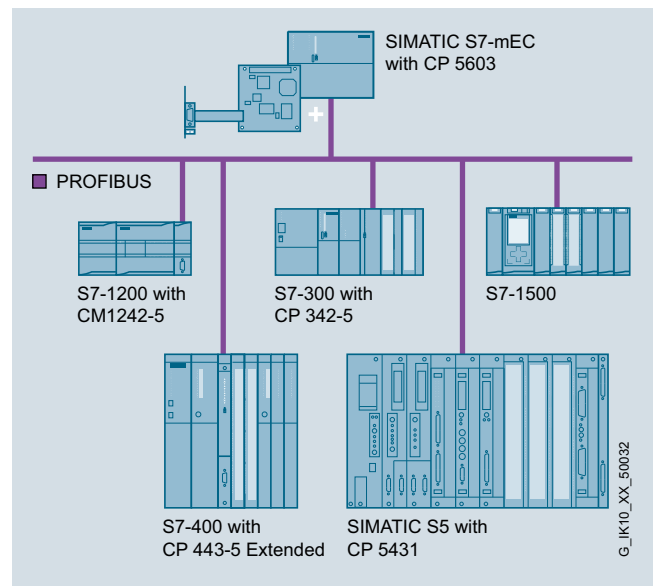

Connecting the SIMATIC to the S7 modular embedded controller via PROFIBUS

### Function (continued)

#### User interfaces

##### OPC interface

The OPC server included in the respective software package can be used as the standard programming interface for the PROFIBUS DP, open communication, S7 communication and PROFIBUS FMS in order to connect automation technology applications to OPC-compatible Windows applications (Office, HMI systems, etc.)

##### Programming interface through C library

The programming interfaces for existing applications are implemented as Dynamic Link Libraries (DLL). The released compilers can be found in the readme file of the SIMATIC NET CD products at <http://www.siemens.com/automation/csi/net>.

For Borland programming interfaces (e.g. DELPHI), partner solutions from SoftwareOption are offered.

For solutions for other operating systems, see HARDNET-PB DP Development Kit.

#### Configuration

- The S7 communication, open communication and DP-V0/DP-V1/DP-V2 protocols are configured in STEP 7 or NCM PC.
- A configuration tool is included in the scope of delivery of the PROFIBUS software packages.

#### Diagnostics

Comprehensive diagnostic tools are available (for installation, start-up and operation) for the module itself and for the PROFIBUS DP network. These tools can be used for quick and easy start-up of a PROFIBUS network with a CP 5603.

### Technical specifications

Article No.	6GK1560-3AA00
Product-type designation	CP 5603
<b>Transmission rate</b>	
Transmission rate at interface 1 in accordance with PROFIBUS	9.6 kbit/s ... 12 Mbit/s
<b>Interfaces</b>	
Number of electrical connections at interface 1 in accordance with PROFIBUS	1
Design of electrical connection	
• at interface 1 in accordance with PROFIBUS	9-pin Sub-D socket (RS 485)
• of the backplane bus	PCI-104 (32Bit)
<b>Supply voltage, current consumption, power loss</b>	
Type of supply voltage	DC
Supply voltage 1 from backplane bus	5 V
Relative symmetrical tolerance at 5 V with DC	5 %
Consumed current 1 from backplane bus with DC maximum	0.66 A
Resistive loss	3.3 W
<b>Permitted ambient conditions</b>	
Ambient temperature	
• during operating	0 ... 70 °C
• during storage	-40 ... +70 °C
• during transport	-40 ... +70 °C
Relative humidity at 25 °C without condensation during operating maximum	85 %
Protection class IP	IP00
<b>Design, dimensions and weight</b>	
Module format	PCI-104
Width	90 mm
Height	21 mm
Depth	96 mm
Net weight	80 g
Mounting type	Screw mounting

Article No.	6GK1560-3AA00
Product-type designation	CP 5603
<b>Product properties, functions, components general</b>	
Number of plug-in cards in the same design can be plugged in per PC station	3
Number of modules note	FMS-5613 supports up to two CP 5603 / CP 5613 A2 / CP 5614 A2 / CP 5623 / CP 5624 processors
<b>Performance data</b>	
<u>Performance data open communication</u>	
Software for open communication by means of SEND/RECEIVE required	FDL driver included in scope of delivery of the CP
Number of possible connections for open communication by means of SEND/RECEIVE maximum	80
<u>Performance data PROFIBUS DP</u>	
Software for DP master function required	No
Service as DP master	
• DPV0	Yes
• DPV1	Yes
• DPV2	Yes
Number of DP slaves on DP master usable	124
Amount of data	
• of the address area of the inputs as DP master overall	30 256 byte
• of the address area of the outputs as DP master overall	30 256 byte
• of the address area of the inputs per DP slave	244 byte
• of the address area of the outputs per DP slave	244 byte
• of the address area of the diagnostic data per DP slave	244 byte

# PROFIBUS

## Communication for PC-based systems

### CP 5603

#### Technical specifications (continued)

Article No.	6GK1560-3AA00
<b>Product-type designation</b>	<b>CP 5603</b>
Software for DP slave function required	No
Service as DP slave	
• DPV0	Yes
• DPV1	Yes
Amount of data	
• of the address area of the inputs as DP slave overall	244 byte
• of the address area of the outputs as DP slave overall	244 byte
<b>Performance data</b>	
<b>FMS functions</b>	
Software for FMS communication required	Yes, FMS-5613
Number of possible connections for FMS connection maximum	40
<b>Performance data</b>	
<b>S7 communication</b>	
Software for S7 communication required	Yes, HARDNET-PB S7 (S7-5613)
Number of possible connections for S7/PG communication maximum	50
<b>Performance data</b>	
<b>multi-protocol mode</b>	
Number of active connections with multiprotocol mode	50
Number of configurable connections per PC station	207
<b>Product functions management, configuration</b>	
Configuration software required	included in scope of delivery
<b>Product functions Diagnosis</b>	
Product function Port diagnostics	Yes
<b>Standards, specifications, approvals</b>	
Standard	
• for EMC	2004/108/EC
• for safety of CSA and UL	CAN/CSA C22.2 & UL 60950-1, UL 508
• for emitted interference	EN 61000-6-3, EN 61000-6-4
• for interference immunity	EN 61000-6-1, EN 61000-6-2
Verification of suitability	
• CE mark	Yes
• C-Tick	Yes
<b>Accessories</b>	
Accessories	optional: Expansion rack for SIMATIC Microbox and slide-in plate for SIMATIC S7 modular embedded controller

#### Ordering data

#### Article No.

<b>CP 5603 communications processor</b>	<b>6GK1560-3AA00</b>
PCI-104 card for connection to PROFIBUS incl. DP-Base software with NCM PC; DP-RAM interface for DP master or DP slave, incl. PG and FDL protocols; single license for one installation, runtime software, software and electronic manual on CD-ROM, Class A, for operating system support see SIMATIC NET software German/English	
<b>CP 5603 Microbox Package</b>	<b>6GK1560-3AU00</b>
for use of CP 5603 in Microbox 420/427B/427C; consisting of CP 5603 module and Microbox expansion frame	
<b>CP 5603 expansion rack</b>	<b>6GK1560-3AA00-0AU0</b>
for use in Microbox 420/427B/427C with mounting material	
<b>CP 5603 mEC Package</b>	<b>6GK1560-3AE00</b>
for use of CP 5603 in SIMATIC S7-MEC; consisting of CP 5603 and withdrawable unit for CP 5603 for installation in the EM PCI-104 expansion module of the SIMATIC S7-MEC	
<b>CP 5603 insert plate</b>	<b>6GK1560-3AA00-0AE0</b>
Metal plate with RS485 cutout for inserting for the S7 modular embedded controller	
<b>Accessories</b>	
<b>PROFIBUS FastConnect bus connector RS485 Plug 180</b>	<b>6GK1500-0FC10</b>
with 180° cable outlet, insulation displacement	
<b>PROFIBUS FC Standard Cable GP</b>	<b>6XV1830-0EH10</b>
Standard type with special design for quick assembly, 2-core, shielded Sold in meter; max. length 1 000 m minimum order 20 m	
<b>PROFIBUS FastConnect Stripping Tool</b>	<b>6GK1905-6AA00</b>
Preset stripping tool for fast stripping of PROFIBUS FastConnect bus cables	
<b>PROFIBUS bus terminal 12M</b>	<b>6GK1500-0AA10</b>
Bus terminal for connection of PROFIBUS stations up to 12 Mbit/s with plug-in cable 1.5 m long	

#### Note:

For software ordering data, see page 3/227

#### More information

You can find the HARDNET-PB DP Development Kit on the Internet at:

<http://www.siemens.com/simatic-net/dk5613>

### Overview

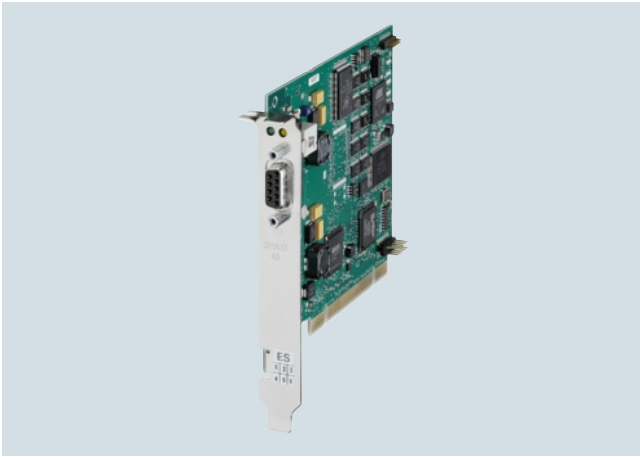

DP-M	DP-S	FMS	OPC	PG/OP	S7/S5
●	●		●	●	●

- PCI card (universal keyed 5 V/3.3 V) with own microprocessor for connection of PCs and SIMATIC PG/PC to PROFIBUS at up to 12 Mbit/s
- Communication services:
  - PROFIBUS DP master according to IEC 61158/61784 on a PCI card
  - PG/OP communication with STEP 7
  - S7 communication with HARDNET-PB S7 software package
  - Open communication (SEND/RECEIVE) based on the FDL interface
- Comprehensive diagnostics possibilities for installation, commissioning and operation of the module
- High performance over direct dual-port RAM access
- Event and filter mechanisms to reduce the loading on the host CPU
- Multiprotocol operation and parallel operation of up to four CPs
- Implementation in Motion Control applications is possible because a constant bus cycle time is supported
- The appropriate OPC servers and configuration tools are included in the scope of supply of the respective communications software.

### Benefits

get **Designed for Industry**

- Fast process data exchange; access to process data by means of direct access to the dual port RAM of the hardware
- High computing performance in the PG/PC; reduces workload of host CPU by preprocessing the communication on the hardware
- Use of different operating system environments; driver as source code for porting to different operating system environments
- Use also in motion control applications; real-time capable data exchange through constant bus cycle time

### Application



The CP 5613 A3 supports the connection of a SIMATIC PG/PC and PCs with PCI slot to PROFIBUS.

The CP 5613 A3 provides high-performance support for control tasks on the PC (PC based Control, Numeric Control, Robot Control).

### Design

- Short PCI card
- Operation possible in 3.3V and 5V PCI slots (universal keyed)
- 33 MHz or 66 MHz PCI clock
- Operation possible as 32-bit card in a 64-bit PCI X-slot
- 9-pin sub-D socket for connection to PROFIBUS
- Diagnostics LEDs
- Parallel operation of up to four CPs

The module is installed by means of PCI standard mechanisms (Plug&Play).

If the CP 5613 A3 is used as DP master or in a PG/OP on a PROFIBUS DP, the connection is made:

- **to the electrical PROFIBUS** via
  - Bus connector and PROFIBUS bus cable or
  - bus terminal (e.g. bus terminal 12M) and PROFIBUS bus cable
- **to the optical PROFIBUS with OLM** via
  - bus cable with two bus connectors or
  - PROFIBUS plug-in cable 830-1T
- **to the optical PROFIBUS with OBT and integrated interface** via
  - bus cable with two bus connectors or
  - PROFIBUS plug-in cable 830-1T

## PROFIBUS

### Communication for PC-based systems

#### CP 5613 A3

#### Function

##### PROFIBUS DP

###### Access to process data with DP-Base

The CP 5613 A3 is operated as a PROFIBUS DP master module that stores the process image (input/output and diagnostic data) in the dual-port RAM (memory area on the CP). High-performance data transfer to and from the PROFIBUS slaves is performed autonomously by the hardware of the CP 5613 A3. The user accesses the dual-port RAM directly.

The process data of the slaves are always consistent, i.e. the user receives the data of a slave from one and the same DP cycle.

Parallel operation of the HARDNET-PB DP and DP-Base software is not possible.

###### Event filter mechanism

The user receives up-to-date data over two access mechanisms:

- Cyclic polling of the DP slaves (higher loading for host CPU)
- Notification through event/filter mode on changing the input data of a slave (minimal loading for host CPU)

Both alternatives can be combined. This allows users to optimize use of the PC for their applications.

The event/filter mechanism can be used additionally for

- Notification by means of an interrupt of the diagnostic alarms from slaves
- During operation with constant bus cycle time, signaling by means of interrupt:
  - Start DP cycle
  - End of cyclic data communication with DP slaves

###### FastLogic

FastLogic means that the CP 5613 A3 can react autonomously to 4 plant statuses. This results in a short response time and independence from the host application, e.g. fast shutdown of devices.

###### DP programming interface

The DP programming interface (DP-Base) of the CP 5613 A3 features the following functions:

- DP master class 1 including acyclic DP expansions
- DP master class 2 including acyclic DP expansions

The process data is accessed directly through the dual-port RAM. The DP RAM interface not only offers fast access as DP master but also a basis for porting to other operating system environments (e.g. VXWorks, QNX, RMOS, RTX).

Administrative function calls (initialization and management services) are offered in a library (DP\_BASE.DLL).

###### HARDNET-PB DP Development Kit

The HARDNET-PB DP Development Kit provides access to the functions DP master Class 1 including acyclic DP expansions.

The HARDNET-PB DP Development Kit is used to integrate the CP 5613 A3 and CP 5614 A3 communications processors into any operating system environment. The kit contains the necessary source code, including the descriptions in PDF format, and can be downloaded free of charge from the Internet.

###### Access to process data with HARDNET-PB DP

HARDNET-PB DP is available to permit compatibility with older applications that were created with the DP-Lib interface.

Parallel operation of the DP-Base and HARDNET-PB DP software is not possible.

###### Software for PG/OP communication

This software supports programming of the SIMATIC S7 controllers over PROFIBUS in combination with STEP 7. PG/OP communication is already available after the CP 5613 A3 (DP-Base) has been installed. No additional software packages are required.

###### Open communication (SEND/RECEIVE) based on the FDL interface

SEND/RECEIVE (FDL interface) is already available following installation of the CP 5613 A3 (DP-Base) and provides services for data transfer, diagnostics and management. No additional software packages are required.

###### Software for S7 communication (HARDNET-PB S7)

SIMATIC S7 system components communicate with each other using S7 communication functions. The S7 programming interface provides programming device/PC user programs with access to SIMATIC S7 system components. This provides easy, flexible access to the data of the SIMATIC S7 controller.

The following services are available with S7 communication:

###### Administrative services

- Connection management
- Mini database
- Trace

###### Data transfer services

- Read/write variables
- BSEND/BRECEIVE (up to 64 KB per task)

###### User interfaces

- **OPC interface**

The OPC server included in the respective software package can be used as standard programming interface for the PROFIBUS DP, open communication and S7 communication protocols for linking automation technology applications with OPC-capable Windows applications (Office, HMI systems, etc.).

###### Configuration

- The S7 communication, open communication, DP protocol (DP-V0/DP-V1/DP-V2) protocols are configured in STEP 7 or NCM PC.
- A configuration tool is included in the scope of delivery of the PROFIBUS software packages.

###### Diagnostics

Comprehensive diagnostic tools are available (for installation, start-up and operation) for the module itself and for the PROFIBUS DP network. These tools can be used for quick and easy start-up of a PROFIBUS network with a CP 5613 A3.

### Technical specifications

Article No.	6GK1561-3AA02	Article No.	6GK1561-3AA02
Product-type designation	CP 5613 A3	Product-type designation	CP 5613 A3
<b>Transmission rate</b>		<b>Performance data</b> <u>PROFIBUS DP</u>	
Transmission rate at interface 1 in accordance with PROFIBUS	9.6 kbit/s ... 12 Mbit/s	Software for DP master function required	No
<b>Interfaces</b>		Service as DP master	
Number of electrical connections at interface 1 in accordance with PROFIBUS	1	• DPV0	Yes
Design of electrical connection		• DPV1	Yes
• at interface 1 in accordance with PROFIBUS	9-pin Sub-D socket (RS 485)	• DPV2	Yes
• of the backplane bus		Number of DP slaves on DP master usable	124
<b>Supply voltage, current consumption, power loss</b>		Amount of data	
Type of supply voltage	DC	• of the address area of the inputs as DP master overall	30 256 byte
Supply voltage		• of the address area of the outputs as DP master overall	30 256 byte
• 1 from backplane bus	3.3 V	• of the address area of the inputs per DP slave	244 byte
• 2 from the backplane bus	12 V	• of the address area of the outputs per DP slave	244 byte
Relative symmetrical tolerance		• of the address area of the diagnostic data per DP slave	244 byte
• at 3.3 V with DC	9 %	Software for DP slave function required	No
• at 12 V with DC	8 %	Service as DP slave	
Consumed current		• DPV0	Yes
• 1 from backplane bus with DC maximum	0.15 A	• DPV1	Yes
• 2 from backplane bus with DC maximum	0.25 A	Amount of data	
Resistive loss	3.5 W	• of the address area of the inputs as DP slave overall	244 byte
<b>Permitted ambient conditions</b>		• of the address area of the outputs as DP slave overall	244 byte
Ambient temperature		<u>Performance data</u> <u>S7 communication</u>	
• during operating	5 ... 55 °C	Software for S7 communication required	Yes, HARDNET-PB S7 (S7-5613)
• during storage	-20 ... +60 °C	Number of possible connections for S7/PG communication maximum	50
• during transport	-20 ... +60 °C	<u>Performance data</u> <u>multi-protocol mode</u>	
Relative humidity at 25 °C without condensation during operating maximum	85 %	Number of active connections with multiprotocol mode	50
Protection class IP	IP00	Number of configurable connections per PC station	207
<b>Design, dimensions and weight</b>		<b>Product functions management, configuration</b>	included in scope of delivery
Module format	PCI	Configuration software required	
Width	0.018 m	<b>Product functions Diagnosis</b>	
Height	0.107 m	Product function Port diagnostics	Yes
Depth	0.125 m	<b>Standards, specifications, approvals</b>	
Net weight	0.098 kg	Standard	
<b>Product properties, functions, components general</b>		• for EMC	89/336/EEC
Number of plug-in cards in the same design can be plugged in per PC station	4	• for safety of CSA and UL	CAN/CSA C22.2 & UL 60950-1, UL 1950
Number of modules note	-	• for emitted interference	EN 61000-6-3
<b>Performance data</b>		• for interference immunity	EN 61000-6-2
<u>Performance data</u> <u>open communication</u>		Verification of suitability	
Software for open communication by means of SEND/RECEIVE required	FDL driver included in scope of delivery of the CP	• CE mark	Yes
Number of possible connections for open communication by means of SEND/RECEIVE maximum	80	• C-Tick	Yes

**PROFIBUS**

## Communication for PC-based systems

**CP 5613 A3****Ordering data****Article No.****CP 5613 A3  
communications processor****6GK1561-3AA02**

PCI card (32-bit; 3.3 V/5 V) for connection to PROFIBUS incl. DP-Base software; DP-RAM interface for DP master, incl. PG and FDL protocols; single license for one installation, runtime software, software and electronic manual on CD-ROM, Class A, for operating system support see SIMATIC NET software V12  
English/German

**Accessories****PROFIBUS FastConnect  
bus connector RS 485 Plug 180****6GK1500-0FC10**

with 180° cable outlet,  
insulation displacement

**PROFIBUS FC Standard Cable GP****6XV1830-0EH10**

Standard type with special design for quick assembly, 2-core, shielded  
Sold in meters

Delivery unit max. 1 000 m  
Minimum order 20 m

**PROFIBUS bus terminal 12M****6GK1500-0AA10**

Bus terminal for connection of PROFIBUS stations up to 12 Mbit/s with plug-in cable 1.5 m long

**PROFIBUS FastConnect  
Stripping Tool****6GK1905-6AA00**

Preset stripping tool for fast stripping of PROFIBUS FastConnect bus cables

**More information**

You can find the HARDNET-PB DP Development Kit on the Internet at:

<http://www.siemens.com/simatic-net/dk5613>

The CP 5613 A3 module can also be used under the LINUX and UNIX operating systems. Information on the available LINUX distributors and UNIX operating systems can be found at:

<http://www.siemens.com/simatic-net/ik-info>

**Note:**

For software ordering data, see page 3/227



### Overview

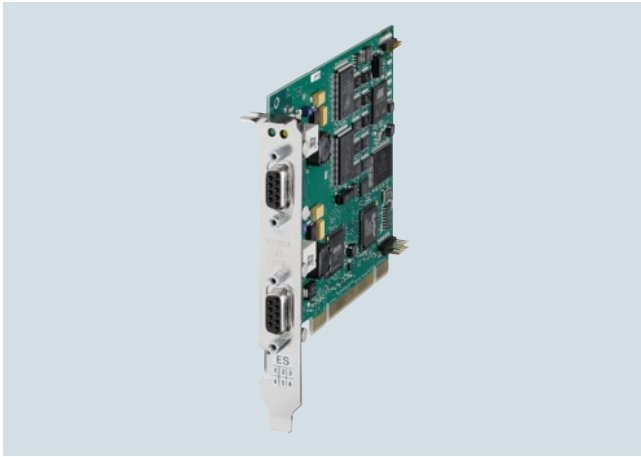

DP-M	DP-S	FMS	OPC	PG/OP	S7/S5
●	●		●	●	●

- PCI card (universal keyed 5 V/3.3 V) with own microprocessor for connection of PCs and SIMATIC PG/PC to PROFIBUS at up to 12 Mbit/s
- Communication services:
  - PROFIBUS DP master and slave interface according to IEC 61158/61784 on one PCI card
  - PG/OP communication with STEP 5 and STEP 7
  - S7 communication with HARDNET-PB S7 software package
  - Open communication (SEND/RECEIVE) based on the FDL interface
- Comprehensive diagnostics possibilities for installation, commissioning and operation of the module
- High performance over direct dual-port RAM access
- Event and filter mechanisms to reduce the loading on the host CPU
- Multiprotocol operation and parallel operation of up to four CPs
- Implementation of Motion Control applications is possible because a constant bus cycle time is supported
- The appropriate OPC servers and configuration tools are included in the scope of supply of the respective communications software.

### Benefits

get **Designed for Industry**

- Fast access to process data by means of direct access to the dual port RAM of the hardware
- High computing performance in the PG/PC; reduces workload of host CPU by preprocessing the communication on the hardware
- Use of different operating system environments; driver as source code for porting to different operating system environments
- Reduced number of slots; through parallel operation as DP master and DP slave
- Can also be used in typical motion control applications
- Real-time capable data exchange in constant bus cycle time mode

### Application



The CP 5614 A3 supports the connection of a SIMATIC PG/PC and PCs with PCI slot to PROFIBUS. It can be either a DP master or a DP slave.

Two different PROFIBUS networks can then be connected in a hierarchic structure on a PC with a PROFIBUS card and data can be transferred between the two.

The CP 5614 A3 provides high-performance support for control tasks on the PC (PC based Control, Numeric Control, Robot Control).

### Design

- Short PCI card
- Operation possible in 3.3 V and 5 V PCI slots (universal keyed)
- 33 MHz or 66 MHz PCI clock
- Operation possible as 32-bit card in a 64-bit PCI X-slot
- 2 x 9-pin sub-D socket for connection to PROFIBUS
- Diagnostics LEDs
- Parallel operation of up to four CPs

The module is installed by means of PCI standard mechanisms (Plug&Play).

If the CP 5614 A3 is used as DP master, DP slave, or in a PG/OP on a PROFIBUS DP, the connection is made:

- **to the electrical PROFIBUS** via
  - Bus connector and PROFIBUS bus cable or
  - bus terminal (e.g. bus terminal 12M) and PROFIBUS bus cable
- **to the optical PROFIBUS with OLM** via
  - bus cable with two bus connectors or
  - PROFIBUS plug-in cable 830-1T
- **to the optical PROFIBUS with OBT and integrated interface** via
  - bus cable with two bus connectors or
  - PROFIBUS plug-in cable 830-1T

## PROFIBUS

### Communication for PC-based systems

#### CP 5614 A3

#### Function

##### PROFIBUS DP

###### Access to process data

The CP 5614 A3 is operated as a PROFIBUS DP master and DP slave module that stores the process image (input/output and diagnostic data) in the dual-port RAM. High-performance data transfer to and from the PROFIBUS slaves is performed autonomously by the hardware of the CP 5614 A3. The user accesses the dual-port RAM directly.

The process data of the slaves is always consistent, i.e. the user receives the data of a slave from one and the same DP cycle.

Parallel operation of the HARDNET-PB DP software (DP master) and DP-Base software (DP master, DP slave) is not possible.

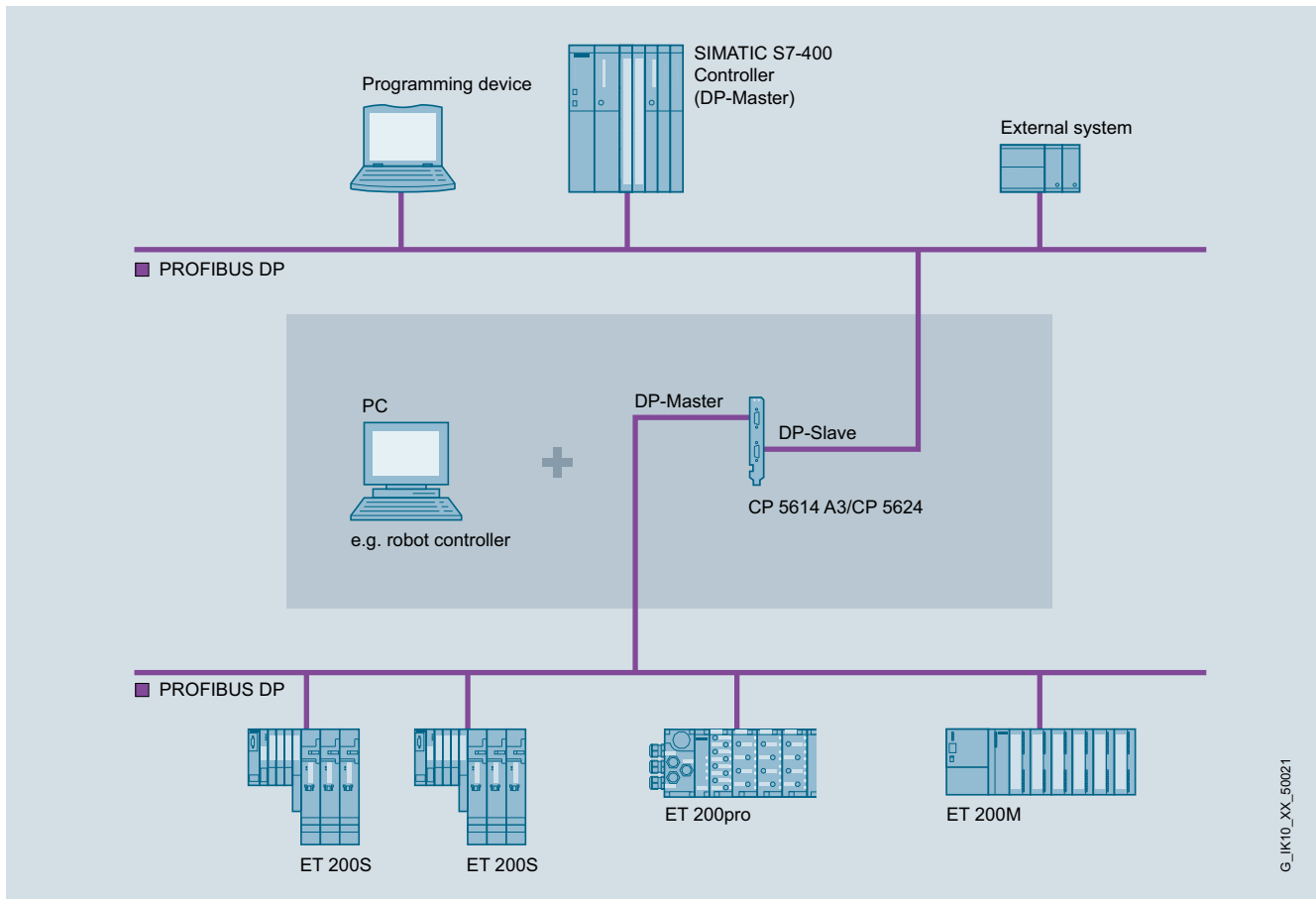

Example configuration of CP 5614 A3 as DP master and DP slave

##### Event filter mechanism

The user receives up-to-date data over two access mechanisms:

- Cyclic polling of the DP slaves (high loading for host CPU)
- Notification through event/filter mode on changing the input data of a slave (minimal loading for host CPU)

Both alternatives can be combined. This allows users to optimize use of the PC for their applications.

The event/filter mechanism can be used additionally for

- Notification by means of an interrupt of the diagnostic alarms from slaves
- During operation with constant bus cycle time, signaling by means of interrupt:
  - Start DP cycle
  - End cyclic data communication with DP slaves

##### FastLogic

FastLogic means that the CP 5614 A3 can react autonomously to 4 plant statuses. This results in a short response time and independence from the host application, e.g. fast shutdown of devices.

##### DP programming interface

The DP master programming interfaces of the CP 5613 A3 and CP 5614 A3 are identical.

The DP programming interface of the CP 5614 A3 features the following functions:

- DP slave
- DP master Class 1 including acyclic DP expansions
- DP master Class 2 including acyclic DP expansions

The process data is accessed directly through the dual-port RAM. The DP RAM interface not only offers fast access as DP master/slave but also a basis for porting to other operating system environments (e.g. VXWorks, QNX, RMOS, RTX).

### Function (continued)

Administrative function calls (initialization and management services as well as diagnostic functions) are provided through a DP master and DP slave library (DP\_BASE.DLL and DPS\_BASE.DLL).

A transfer mechanism (PC application) can be activated in the software as a linking component for data transfer between the master and slave interface.

Defined I/O data can be transferred in this manner between the master interface and the slave interface.

The two connected PROFIBUS networks can be operated with different PROFIBUS bus parameters because they are independent of each other.

### **HARDNET-PB DP Development Kit**

The HARDNET-PB DP Development Kit provides access to the functions DP master Class 1 and DP slave (incl. acyclic DP expansions)

The HARDNET-PB DP Development Kit is used to integrate the CP 5613 A3 and CP 5614 A3 communications processors into any operating system environment. The kit contains the necessary source code, including the descriptions in PDF format, and can be downloaded free of charge from the Internet.

### **Access to process data with HARDNET-PB DP**

HARDNET-PB DP is available to permit compatibility with older applications that were created with the DP-Lib interface.

Parallel operation of the DP-Base and HARDNET-PB DP software is not possible.

### **Software for PG/OP communication**

This software supports programming of the SIMATIC S7 controllers over PROFIBUS in combination with STEP 7. PG/OP communication is already available after the CP 5614 A3 (DP-Base) has been installed. No additional software packages are required.

### **Open communication (SEND/RECEIVE) based on the FDL interface**

SEND/RECEIVE (FDL interface) is already available following installation of the CP 5614 A3 (DP-Base) and provides services for data transfer, diagnostics and management. No additional software packages are required.

### **Software for S7 communication (HARDNET-PB S7)**

SIMATIC S7 system components communicate with each other using S7 communication functions. The S7 programming interface provides programming device/PC user programs with access to SIMATIC S7 system components. This provides easy, flexible access to the data of the SIMATIC S7 controller.

The following services are available with S7 communication:

#### **Administrative services**

- Connection management
- Mini database
- Trace

#### **Data transfer services**

- Read/write variables
- BSEND/BRECEIVE (up to 64 KB per task)

#### **User interfaces**

- **OPC interface**

The OPC server included in the respective software package can be used as the standard programming interface for the PROFIBUS DP (DP master and DP slave), open communication, S7 communication and PROFIBUS FMS protocols for linking automation technology applications to OPC-capable Windows applications (Office, HMI systems, etc.).

#### **Configuration**

- The S7 communication, open communication, DP protocol (DP-V0/DP-V1/DP-V2) protocols are configured in STEP 7 or NCM PC.
- A configuration tool is included in the scope of delivery of the PROFIBUS software packages.

#### **Diagnostics**

Comprehensive diagnostic tools are available (for installation, start-up and operation) for the module itself and for the PROFIBUS DP network. These tools can be used for quick and easy start-up of a PROFIBUS DP network with a CP 5614 A3.

# PROFIBUS

## Communication for PC-based systems

### CP 5614 A3

#### Function (continued)

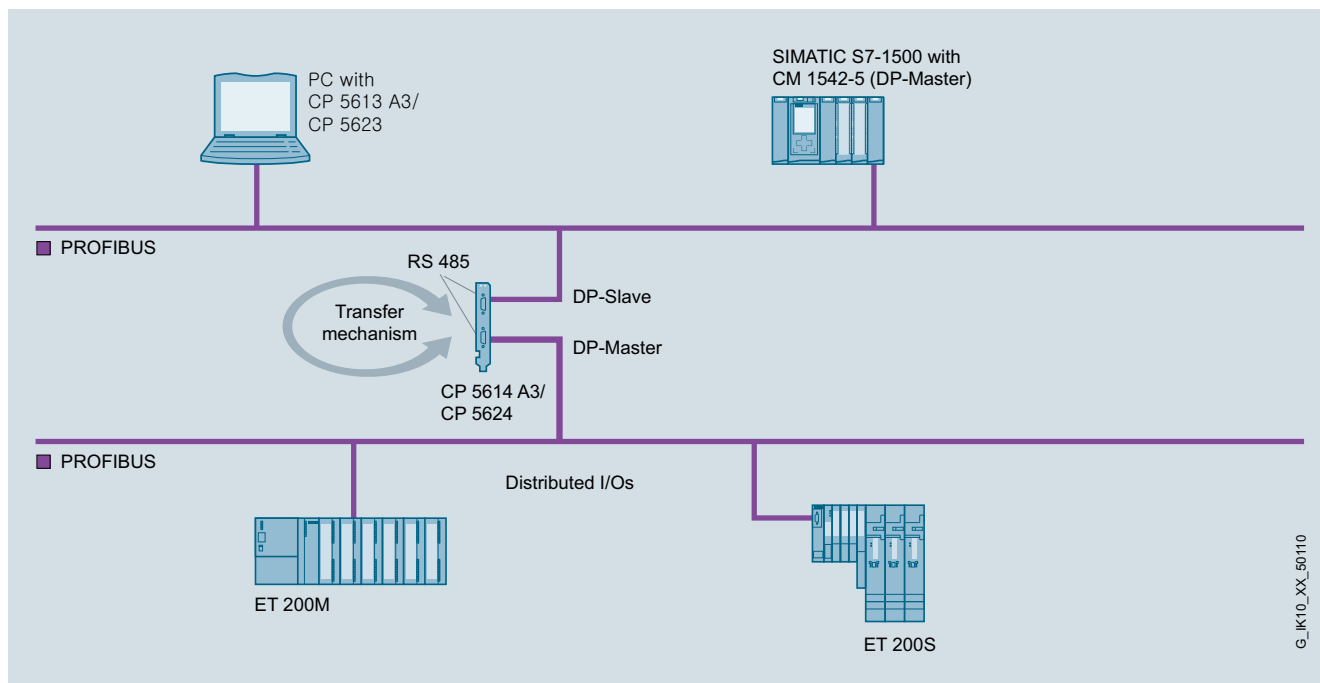

Configuration example for CP 5614 A3

#### Technical specifications

Article No.	6GK1561-4AA02
<b>Product-type designation</b>	CP 5614 A3
<b>Transmission rate</b>	
Transmission rate	
• at interface 1 in accordance with PROFIBUS	9.6 kbit/s ... 12 Mbit/s
• at interface 2 in accordance with PROFIBUS	9.6 kbit/s ... 12 Mbit/s
<b>Interfaces</b>	
Number of electrical connections	
• at interface 1 in accordance with PROFIBUS	1
• at interface 2 in accordance with PROFIBUS	1
Design of electrical connection	
• at interface 1 in accordance with PROFIBUS	9-pin Sub-D socket (RS 485)
• at interface 2 in accordance with PROFIBUS	9-pin Sub-D socket (RS 485)
• of the backplane bus	
<b>Supply voltage, current consumption, power loss</b>	
Type of supply voltage	DC
Supply voltage	
• 1 from backplane bus	3.3 V
• 2 from the backplane bus	12 V
Relative symmetrical tolerance	
• at 3.3 V with DC	9 %
• at 12 V with DC	8 %
Consumed current	
• 1 from backplane bus with DC maximum	0.15 A
• 2 from backplane bus with DC maximum	0.3 A
Resistive loss	4 W

Article No.	6GK1561-4AA02
<b>Product-type designation</b>	CP 5614 A3
<b>Permitted ambient conditions</b>	
Ambient temperature	
• during operating	5 ... 55 °C
• during storage	-20 ... +60 °C
• during transport	-20 ... +60 °C
Relative humidity at 25 °C without condensation during operating maximum	85 %
Protection class IP	IP00
<b>Design, dimensions and weight</b>	
Module format	PCI
Width	18 mm
Height	107 mm
Depth	125 mm
Net weight	0.118 kg
<b>Product properties, functions, components general</b>	
Number of plug-in cards in the same design can be plugged in per PC station	4
Number of modules note	-
<b>Performance data</b>	
<u>Performance data open communication</u>	
Software for open communication by means of SEND/RECEIVE required	FDL driver included in scope of delivery of the CP
Number of possible connections for open communication by means of SEND/RECEIVE maximum	80

G\_IK10\_XX\_50110

### Technical specifications (continued)

Article No.	6GK1561-4AA02
Product-type designation	CP 5614 A3
<u>Performance data</u> <u>PROFIBUS DP</u>	
Software for DP master function required	No
Service as DP master	
• DPV0	Yes
• DPV1	Yes
• DPV2	Yes
Number of DP slaves on DP master usable	124
Amount of data	
• of the address area of the inputs as DP master overall	30 256 byte
• of the address area of the outputs as DP master overall	30 256 byte
• of the address area of the inputs per DP slave	244 byte
• of the address area of the outputs per DP slave	244 byte
• of the address area of the diagnostic data per DP slave	244 byte
Software for DP slave function required	No
Service as DP slave	
• DPV0	Yes
• DPV1	Yes
Amount of data	
• of the address area of the inputs as DP slave overall	244 byte
• of the address area of the outputs as DP slave overall	244 byte
<u>Performance data</u> <u>S7 communication</u>	
Software for S7 communication required	Yes, HARDNET-PB S7 (S7-5613)
Number of possible connections for S7/PG communication maximum	50
<u>Performance data</u> <u>multi-protocol mode</u>	
Number of active connections with multiprotocol mode	50
Number of configurable connections per PC station	207
<b>Product functions management, configuration</b>	
Configuration software required	included in scope of delivery
<b>Product functions Diagnosis</b>	
Product function Port diagnostics	Yes
<b>Standards, specifications, approvals</b>	
Standard	
• for EMC	89/336/EEC
• for safety of CSA and UL	CAN/CSA C22.2 & UL 60950-1, UL 1950
• for emitted interference	EN 61000-6-3
• for interference immunity	EN 61000-6-2
Verification of suitability	
• CE mark	Yes
• C-Tick	Yes

### Ordering data

### Article No.

<b>CP 5614 A3 communications processor</b>	<b>6GK1561-4AA02</b>
PCI card (32-bit; 3.3 V/5 V) master and slave connection to PROFIBUS incl. DP-Base software; DP-RAM interface for DP master, incl. PG and FDL protocols; single license for one installation, runtime software, software and electronic manual on CD-ROM, Class A, for operating system support see SIMATIC NET software V12; German/English	
<i>Accessories</i>	
<b>PROFIBUS FastConnect bus connector RS 485 Plug 180</b>	<b>6GK1500-0FC10</b>
with 180° cable outlet, insulation displacement	
<b>PROFIBUS FC Standard Cable GP</b>	<b>6XV1830-0EH10</b>
Standard type with special design for fast mounting, 2-core, shielded Sold by the meter max. delivery unit 1 000 m minimum order quantity 20 m	
<b>PROFIBUS FastConnect Stripping Tool</b>	<b>6GK1905-6AA00</b>
Preset stripping tool for fast stripping of PROFIBUS FastConnect bus cables	
<b>PROFIBUS bus terminal 12M</b>	<b>6GK1500-0AA10</b>
Bus terminal for connection of PROFIBUS stations up to 12 Mbit/s with plug-in cable 1.5 m long	

### Note:

For software ordering data, see page 3/227

### More information

You can find the HARDNET-PB DP Development Kit on the Internet at:

<http://www.siemens.com/simatic-net/dk5613>

The CP 5614 A3 module can also be used under the LINUX and UNIX operating systems. Information on the available LINUX distributors and UNIX operating systems can be found at:

<http://www.siemens.com/simatic-net/ik-info>

## PROFIBUS

### Communication for PC-based systems

CP 5623

#### Overview



DP-M	DP-S	FMS	OPC	PG/OP	S7/S5
●	●	●	●	●	●

- PCI Express card (PCIe x1) with own microprocessor for connecting PCs and SIMATIC PG/PC to PROFIBUS at up to 12 Mbit/s
- Communication services:
  - PROFIBUS DP master Class 1 and 2 or DP slave according to IEC 61158/61784 on a PCI card
  - PG/OP communication with STEP 5 and STEP 7
  - S7 communication with HARDNET-PB S7 software package
  - Open communication (SEND/RECEIVE) based on the FDL interface
  - PROFIBUS FMS according to IEC 61158/61784 with FMS-5613 software package
- Extensive diagnostics options for installation, commissioning and operation of the module
- Event and filter mechanism for reducing the load on the host CPU
- Multiprotocol operation and parallel operation of up to four CPs
- The appropriate OPC servers and configuration tools are included in the scope of supply of the respective communication software

#### Benefits

get **Designed for Industry**

- Fast access to process data by means of direct access to the dual port RAM of the hardware
- High computing performance in the PG/PC; reduces workload of host CPU by preprocessing the communication on the hardware
- Use of different operating system environments; driver as source code for porting to different operating system environments
- Preventive maintenance measures; deriving of measures by evaluating system runtime and ambient temperature
- Use also in motion control applications; real-time capable data exchange through constant bus cycle time

#### Application



The CP 5623 supports the connection of SIMATIC PG/PC and PCs with PCI Express slot to PROFIBUS.

The CP 5623 provides high-performance support for control tasks on the PC (PC based Control, Numeric Control, Robot Control).

#### Design

- Short PCI Express card
- Can also be operated in PCI Express x4, x8 or x16 slots
- 9-pin sub-D socket for connection to PROFIBUS
- Diagnostic LEDs
- Parallel operation of up to four CPs<sup>1)</sup>

The module is installed by means of PCI standard mechanisms (Plug&Play).

If the CP 5623 is used as DP master or in a PG/OP on a PROFIBUS DP, the connection is made:

- **to the electrical PROFIBUS** via
  - bus connector and PROFIBUS bus cable or
  - bus terminal (e.g. bus terminal 12M) and PROFIBUS bus cable
- **to the optical PROFIBUS with OLM** via
  - bus cable with two bus connectors or
  - PROFIBUS plug-in cable 830-1T
- **to the optical PROFIBUS with OBT and integrated interface** via
  - bus cable with two bus connectors or
  - PROFIBUS plug-in cable 830-1T

<sup>1)</sup> FMS-5613 supports up to two CP 5603/CP 5613 A2/5614 A2/CP 5623/CP 5624 processors

### Function

#### PROFIBUS DP

##### Access to process data with DP-Base

The CP 5623 is operated as PROFIBUS DP master module that keeps the process image (input/output and diagnostics data) in the dual port RAM (memory area on the CP). The hardware of the CP 5623 independently executes the high-performance exchange of data with the PROFIBUS slaves. The user accesses the dual-port RAM directly.

The process data of the slaves is always consistent, i.e. the user receives the data of a slave from one and the same DP cycle.

Parallel operation of the HARDNET-PB DP and DP-Base software is not possible.

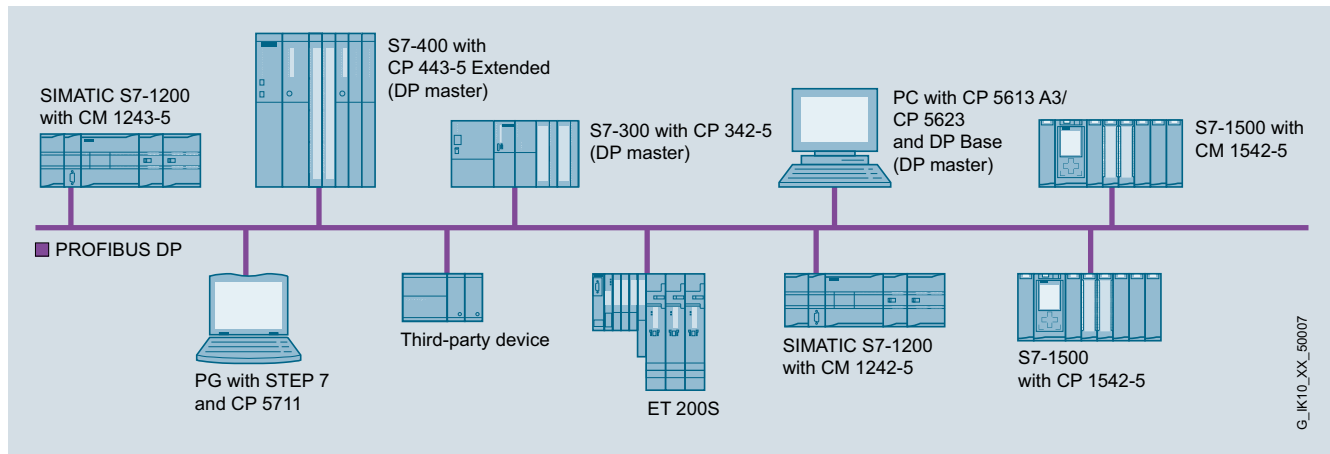

Example configuration of PROFIBUS DP for SIMATIC S5/S7 and PG/PC

##### Event filter mechanism

The user receives up-to-date data over two access mechanisms:

- Cyclic polling of the DP slaves (higher loading for host CPU)
- Notification by means of event/filter mode when changing the input data of a slave (minimal loading for host CPU)

Both alternatives can be combined. This allows users to optimize use of the PC for their applications.

The event/filter mechanism can be used additionally for

- Notification by means of an interrupt of the diagnostic messages from slaves
- During operation with constant bus cycle time, signaling by means of interrupt:
  - Start DP cycle
  - End of cyclic data exchange with DP slaves

##### FastLogic

FastLogic means that the CP 5623 can react autonomously to as many as four plant statuses. This results in a short response time and independence from the host application, e.g. fast shutdown of devices.

##### DP programming interface

The DP programming interface (DP-Base) of the CP 5623 has the following functionality:

- DP master class 1 including acyclic DP expansions
- DP master class 2 including acyclic DP expansions
- DP slave

The process data is accessed directly through the dual-port RAM. The DP RAM interface not only offers fast access as DP master/slave but also a basis for porting to other operating system environments (e.g. VXWorks, QNX, RMOS, RTX).

Administrative function calls (initialization and management services, as well as diagnostic functions) are provided through a library (DP\_BASE.DLL or DPS\_BASE.DLL).

##### HARDNET-PB DP Development Kit

The HARDNET-PB DP Development Kit provides access to the functions DP master Class 1 including acyclic DP expansions

The HARDNET-PB DP Development Kit software enables the CP 5623 communications processor to be integrated into any operating system environments. The kit contains the necessary source code, including the descriptions in PDF format, and can be downloaded free of charge from the Internet.

## PROFIBUS

### Communication for PC-based systems

CP 5623

**Function** (continued)

#### **Access to process data with HARDNET-PB DP**

HARDNET-PB DP is available to permit compatibility with older applications that were created with the DP-Lib interface.

Parallel operation of the DP-Base and HARDNET-PB DP software is not possible.

#### **Software for PG/OP communication**

This software supports programming of the SIMATIC S5/S7 controllers (with the exception of SIMATIC S5-95U) over PROFIBUS in combination with STEP 5/STEP 7. The PG/OP communication for the CP 5623 is already available following installation of the CP 5623 (DP-Base). No additional software packages are required.

#### **Open communication (SEND/RECEIVE based on the FDL interface)**

SEND/RECEIVE (FDL interface) is already available following installation of the CP 5623 (DP-Base) and provides services for data transfer, diagnostics and management. No additional software packages are required.

#### **Software for S7 communication (HARDNET-PB S7)**

SIMATIC S7 system components communicate with each other using S7 communication functions. The S7 programming interface provides programming device/PC user programs with access to SIMATIC S7 system components. This provides easy, flexible access to the data of the SIMATIC S7 controller.

The following services are available with S7 communication:

##### **Administrative services**

- Connection management
- Mini database
- Trace

##### **Data transfer services**

- Read/write variables
- BSEND/BRECEIVE (up to 64 KB per task)

#### **Software for PROFIBUS FMS (FMS-5613)**

With the FMS programming interface, PGs/PCs can exchange different manufacturer data with FMS-capable controllers (e.g. S5 and S7) and field devices. Open communication is assured by using the FMS interface.

The FMS interface offers the following services:

- Administrative services
- CRL management services
- FMS connection management services
- Object directory management services for clients and server
- Variable services for clients and servers (Read, Write, Information Report)
- Server functionality
- VFD services (Virtual Field Device) for clients and servers
- Bus access information services (live list)
- Trace and mini database

#### **User interfaces**

- **OPC interface**

The OPC server included in the respective software package can be used as the standard programming interface for the PROFIBUS DP, open communication, S7 communication and PROFIBUS FMS in order to connect automation technology applications to OPC-compatible Windows applications (Office, HMI systems, etc.)

- **Programming interface through C library**

The programming interfaces for existing applications are implemented as Dynamic Link Libraries (DLL). The released compilers can be found in the readme file of the SIMATIC NET CD products at <http://www.siemens.com/automation/csi/net>.

For Borland programming interfaces (e.g. DELPHI), partner solutions from SoftwareOption are offered.

For solutions for other operating systems, see HARDNET-PB DP Development Kit.

#### **Configuration**

- The S7 communication, open communication and DP-V0/DP-V1/DP-V2 protocols are configured in STEP 7 or NCM/PC.
- A configuration tool is included in the scope of delivery of the PROFIBUS software packages.

#### **Diagnostics**

Comprehensive diagnostic tools are available (for installation, start-up and operation) for the module itself and for the PROFIBUS DP network. These tools can be used for quick and easy start-up of a PROFIBUS network with a CP 5623.



### Technical specifications

Article No.	6GK1562-3AA00	Article No.	6GK1562-3AA00
Product-type designation	CP 5623	Product-type designation	CP 5623
<b>Transmission rate</b>		<b>Performance data PROFIBUS DP</b>	
Transmission rate at interface 1 in accordance with PROFIBUS	9.6 kbit/s ... 12 Mbit/s	Software for DP master function required	No
<b>Interfaces</b>		Service as DP master	
Number of electrical connections at interface 1 in accordance with PROFIBUS	1	• DPV0	Yes
Design of electrical connection		• DPV1	Yes
• at interface 1 in accordance with PROFIBUS	9-pin Sub-D socket (RS 485)	• DPV2	Yes
• of the backplane bus	PCI Express x1	Number of DP slaves on DP master usable	124
<b>Supply voltage, current consumption, power loss</b>		Amount of data	
Type of supply voltage	DC	• of the address area of the inputs as DP master overall	30 256 byte
Supply voltage		• of the address area of the outputs as DP master overall	30 256 byte
• 1 from backplane bus	3.3 V	• of the address area of the inputs per DP slave	244 byte
• 2 from the backplane bus	12 V	• of the address area of the outputs per DP slave	244 byte
Relative symmetrical tolerance		• of the address area of the diagnostic data per DP slave	244 byte
• at 3.3 V with DC	9 %	Software for DP slave function required	No
• at 12 V with DC	8 %	Service as DP slave	
Consumed current		• DPV0	Yes
• 1 from backplane bus with DC maximum	0.72 A	• DPV1	Yes
• 2 from backplane bus with DC maximum	0.25 A	Amount of data	
Resistive loss	5.4 W	• of the address area of the inputs as DP slave overall	244 byte
<b>Permitted ambient conditions</b>		• of the address area of the outputs as DP slave overall	244 byte
Ambient temperature		<b>Performance data FMS functions</b>	
• during operating	5 ... 60 °C	Software for FMS communication required	Yes, FMS-5613
• during storage	-20 ... +60 °C	Number of possible connections for FMS connection maximum	40
• during transport	-20 ... +60 °C	<b>Performance data S7 communication</b>	
Relative humidity at 25 °C without condensation during operating maximum	85 %	Software for S7 communication required	Yes, HARDNET-PB S7 (S7-5613)
Protection class IP	IP00	Number of possible connections for S7/PG communication maximum	50
<b>Design, dimensions and weight</b>		<b>Performance data multi-protocol mode</b>	
Module format	PCI Express x1 (half length)	Number of active connections with multiprotocol mode	50
Width	21.6 mm	Number of configurable connections per PC station	207
Height	126.3 mm	<b>Product functions management, configuration</b>	
Depth	180.5 mm	Configuration software required	included in scope of delivery
Net weight	102 g	<b>Product functions Diagnosis</b>	
<b>Product properties, functions, components general</b>		Product function Port diagnostics	Yes
Number of plug-in cards in the same design can be plugged in per PC station	4	<b>Standards, specifications, approvals</b>	
Number of modules note	FMS-5613 supports up to two CP 5603 / CP 5613 A2 / CP 5614 A2 / CP 5623 / CP 5624 processors	Standard	
<b>Performance data</b>		• for EMC	2004/108/EC
<b>Performance data open communication</b>		• for safety of CSA and UL	CAN/CSA C22.2 & UL 60950-1
Software for open communication by means of SEND/RECEIVE required	FDL driver included in scope of delivery of the CP	• for emitted interference	EN 61000-6-3, EN 61000-6-4
Number of possible connections for open communication by means of SEND/RECEIVE maximum	80	• for interference immunity	EN 61000-6-1, EN 61000-6-2
		Verification of suitability	
		• CE mark	Yes
		• C-Tick	Yes

**PROFIBUS**

## Communication for PC-based systems

## CP 5623

**Ordering data****Article No.****CP 5623****communications processor**

PCI Express x1 card (32 bit) for connection to PROFIBUS incl. DP-Base software with NCM PC; DP-RAM interface for DP master or DP slave, incl. PG and FDL protocols; single license for one installation, runtime software, software and electronic manual on CD-ROM, Class A, for operating system support see SIMATIC NET software German/English

**6GK1562-3AA00****Software-Upgrade**

für CP 5603, CP 5613 A2 und CP 5623 auf Edition 2008 oder V8.1

**6GK1561-3AA01-3AE0***Accessories***PROFIBUS FastConnect bus connector RS485 Plug 180**

with 180° cable outlet, insulation displacement

**6GK1500-0FC10****PROFIBUS FC Standard Cable GP**

Standard type with special design for quick assembly, 2-core, shielded

Sold in meters  
max. length 1 000 m  
minimum order 20 m

**6XV1830-0EH10****PROFIBUS FastConnect Stripping Tool**

Preset stripping tool for fast stripping of PROFIBUS FastConnect bus cables

**6GK1905-6AA00****PROFIBUS bus terminal 12M**

Bus terminal for connection of PROFIBUS stations up to 12 Mbit/s with plug-in cable 1.5 m long

**6GK1500-0AA10**Note:

For software ordering data, see page 3/227

**More information**

You can find the HARDNET-PB DP Development Kit on the Internet at:

<http://www.siemens.com/simatic-net/dk5613>

The CP 5623 module can also be used under LINUX and UNIX operating systems. Information on the available LINUX distributors and UNIX operating systems can be found at:

[www.siemens.com/simatic-net/ik-info](http://www.siemens.com/simatic-net/ik-info)

### Overview



DP-M	DP-S	FMS	OPC	PG/OP	S7/S5
●	●	●	●	●	●

- PCI Express card (PCIe x1) with own microprocessor for connecting PCs and SIMATIC PG/PC to PROFIBUS at up to 12 Mbit/s
- Two 9-pin sub-D sockets for parallel operation as DP master and DP slave
- Communication services:
  - PROFIBUS DP master and slave interface according to IEC 61158/61784 on one PCI card
  - PG/OP communication with STEP 5 and STEP 7
  - S7 communication with HARDNET-PB S7 software package
  - Open communication (SEND/RECEIVE) based on the FDL interface
  - PROFIBUS FMS according to IEC 61158/61784 with FMS-5613 software package
- Extensive diagnostics options for installation, commissioning and operation of the module
- Event and filter mechanism for reducing the load on the host CPU
- Multiprotocol operation and parallel operation of up to four CPs
- The appropriate OPC servers and configuration tools are included in the scope of supply of the respective communication software

### Benefits

get **Designed for Industry**

- Fast access to process data by means of direct access to the dual port RAM of the hardware
- High computing performance in the PG/PC; reduces workload of host CPU by preprocessing the communication on the hardware
- Use of different operating system environments; driver as source code for porting to different operating system environments
- Saving of slots through parallel operation as DP master and DP slave
- Preventive maintenance measures; deriving of measures by evaluating system runtime and ambient temperature
- Use also in motion control applications; real-time capable data exchange through constant bus cycle time204

### Application



The CP 5624 supports the connection of SIMATIC PG/PC and PCs with PCI Express slot to PROFIBUS. It can be both DP master and DP slave.

This enables two different PROFIBUS networks to be connected in a hierarchical structure to a PC and to exchange data using one PROFIBUS card.

The CP 5624 provides high-performance support for control tasks on the PC (PC based Control, Numeric Control, Robot Control).

### Design

- Short PCI Express card
- Can also be operated in PCI Express x4, x8 or x16 slots
- 2 x 9-pin sub-D socket for connection to PROFIBUS
- Diagnostic LEDs
- Parallel operation of as many as four CPs<sup>1)</sup>

The module is installed by means of PCI standard mechanisms (Plug&Play).

If the CP 5624 is used as DP master, DP slave, or in a PG/OP on a PROFIBUS DP, the connection is made:

- **to the electrical PROFIBUS** via
  - bus connector and PROFIBUS bus cable or
  - bus terminal (e.g. bus terminal 12M) and PROFIBUS bus cable
- **to the optical PROFIBUS with OLM** via
  - bus cable with two bus connectors or
  - PROFIBUS plug-in cable 830-1T
- **to the optical PROFIBUS with OBT and integrated interface** via
  - bus cable with two bus connectors or
  - PROFIBUS plug-in cable 830-1T

<sup>1)</sup> FMS-5613 supports up to two CP 5603/CP 5613 A2/5614 A2/CP 5623/CP 5624 processors

## PROFIBUS

### Communication for PC-based systems

#### CP 5624

#### Function

##### PROFIBUS DP

##### Access to process data

The CP 5624 is operated as PROFIBUS DP master and DP slave module, which keeps the process image (input/output and diagnostic data) in the dual port RAM. The hardware of the CP 5624 independently executes the high-performance exchange of data with the PROFIBUS slaves. The user accesses the dual-port RAM directly.

The process data of the slaves is always consistent, i.e. the user receives the data of a slave from one and the same DP cycle.

Parallel operation of the HARDNET-PB DP software (DP master) and DP-Base software (DP master, DP slave) is not possible.

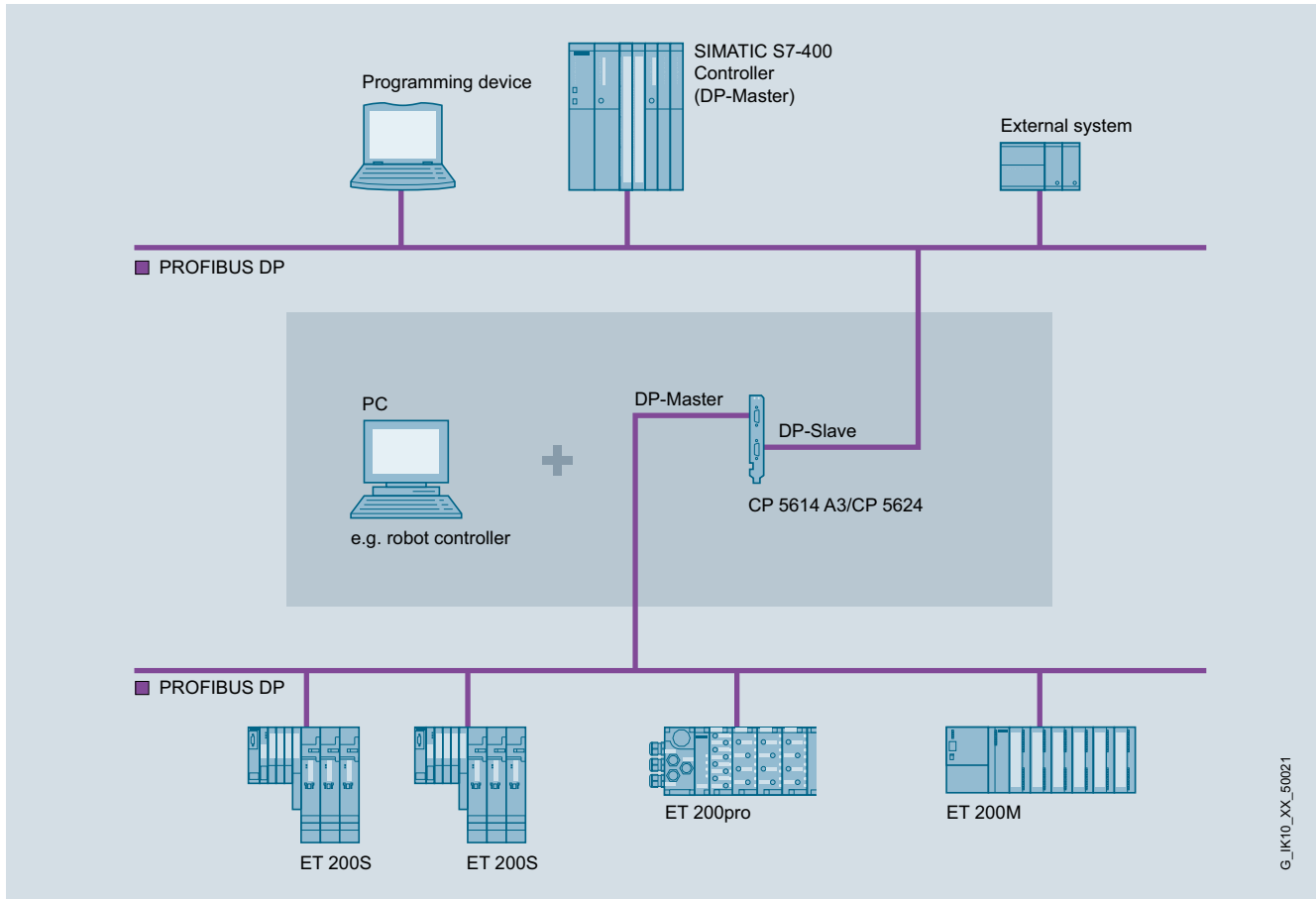

Example configuration of CP 5624 as DP master and DP slave

##### Event filter mechanism

The user receives up-to-date data over two access mechanisms:

- Cyclic polling of the DP slaves (high loading for host CPU)
- Notification through a new type of event/filter mode on changing the input data of a slave (minimal loading for host CPU)

Both alternatives can be combined. This allows users to optimize use of the PC for their applications.

The event/filter mechanism can be used additionally for

- Notification by means of an interrupt of the diagnostic messages from slaves
- During operation with constant bus cycle time, signaling by means of interrupt:
  - Start DP cycle
  - End cyclic data communication with DP slaves

##### FastLogic

FastLogic means that the CP 5624 can react autonomously to as many as four plant statuses. This results in a short response time and independence from the host application, e.g. fast shutdown of devices.

##### DP programming interface

The DP programming interface of the CP 5624 has the following functionality:

- DP slave
- DP master Class 1 including acyclic DP expansions
- DP master Class 2 including acyclic DP expansions

The process data is accessed directly through the dual-port RAM. The DP RAM interface not only offers fast access as DP master/slave but also a basis for porting to other operating system environments (e.g. VXWorks, QNX, RMOS, RTX).

### Function (continued)

Administrative function calls (initialization and management services as well as diagnostic functions) are provided through a DP master and DP slave library (DP\_BASE.DLL and DPS\_BASE.DLL).

A transfer mechanism (PC application) can be activated in the software as a linking component for data transfer between the master and slave interface.

Defined I/O data can be transferred in this manner between the master interface and the slave interface.

The two connected PROFIBUS networks can be operated with different PROFIBUS bus parameters because they are independent of each other.

### **HARDNET-PB DP Development Kit**

The HARDNET-PB DP Development Kit provides access to the functions DP master Class 1 and DP slave (incl. acyclic DP expansions)

The HARDNET-PB DP Development Kit software enables the CP 5624 communications processor to be integrated into any operating system environments. The kit contains the necessary source code, including the descriptions in PDF format, and can be downloaded free of charge via the Internet.

### **Access to process data with HARDNET-PB DP**

HARDNET-PB DP is available to permit compatibility with older applications that were created with the DP-Lib interface.

Parallel operation of the DP-Base and HARDNET-PB DP software is not possible.

### **Software for PG/OP communication**

This software supports programming of the SIMATIC S5/S7 controllers (with the exception of SIMATIC S5-95U) over PROFIBUS in combination with STEP 5/STEP 7. The PG/OP communication for the CP 5624 is already available following installation of the CP 5624 (DP-Base). No additional software packages are required.

### **Open communication (SEND/RECEIVE based on the FDL interface)**

SEND/RECEIVE (FDL interface) is already available following installation of the CP 5624 (DP-Base) and provides services for data transfer, diagnostics and management. No additional software packages are required.

### **Software for S7 communication (HARDNET-PB S7)**

SIMATIC S7 system components communicate with each other using S7 communication functions. The S7 programming interface provides programming device/PC user programs with access to SIMATIC S7 system components. This provides easy, flexible access to the data of the SIMATIC S7 controller.

The following services are available with S7 communication:

#### **Administrative services**

- Connection management
- Mini database
- Trace

#### **Data transfer services**

- Read/write variables
- BSEND/BRECEIVE (up to 64 KB per task)

### **Software for PROFIBUS FMS (FMS-5613)**

With the FMS programming interface, PGs/PCs can exchange different manufacturer data with FMS-capable controllers (e.g. S5 and S7) and field devices. Open communication is assured by using the FMS interface.

The FMS interface offers the following services:

- Administrative services
- CRL management services
- FMS connection management services
- Object directory management services for clients and server
- Variable services for clients and servers (Read, Write, Information Report)
- Server functionality
- VFD services (Virtual Field Device) for clients and servers
- Bus access information services (live list)
- Trace and mini database

### **User interfaces**

- **OPC interface**

The OPC server included in the respective software package can be used as the standard programming interface for the PROFIBUS DP (DP master and DP slave), open communication, S7 communication and PROFIBUS FMS in order to connect automation technology applications to OPC-compatible Windows applications (Office, HMI systems, etc.).

- **Programming interface through C library**

The programming interfaces for existing applications are implemented as Dynamic Link Libraries (DLL). The released compilers can be found in the readme file of the SIMATIC NET CD products at <http://www.siemens.com/automation/csi/net>.

For Borland programming interfaces (e.g. DELPHI), partner solutions from SoftwareOption are offered.

For solutions for other operating systems, see HARDNET-PB DP Development Kit.

### **Configuration**

- The S7 communication, open communication and DP-V0/DP-V1/DP-V2 protocols are configured in STEP 7 or NCM PC.
- A configuration tool is included in the scope of delivery of the PROFIBUS software packages.

### **Diagnostics**

Comprehensive diagnostic tools are available (for installation, start-up and operation) for the module itself and for the PROFIBUS DP network. These tools can be used for quick and easy start-up of a PROFIBUS DP network with a CP 5624.

# PROFIBUS

## Communication for PC-based systems

### CP 5624

#### Function (continued)

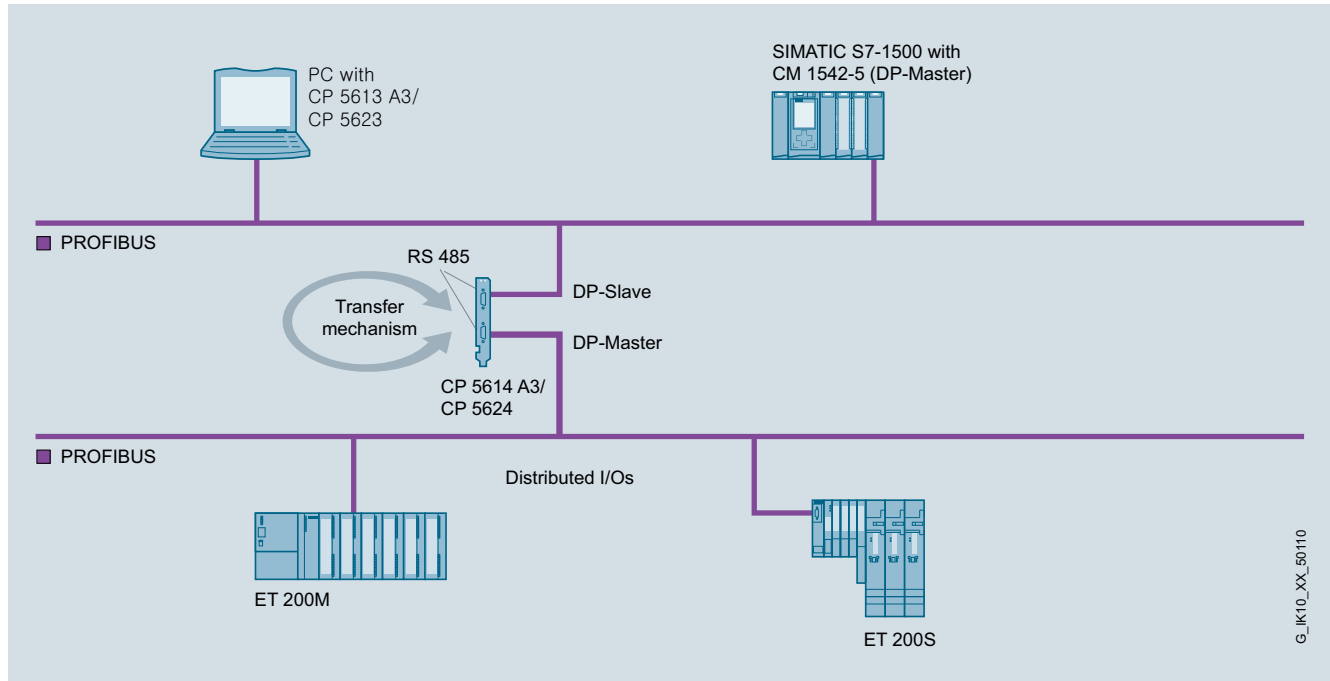

Configuration example for CP 5624

#### Technical specifications

Article No.	6GK1562-4AA00
<b>Product-type designation</b>	CP 5624
<b>Transmission rate</b>	
Transmission rate	
• at interface 1 in accordance with PROFIBUS	9.6 kbit/s ... 12 Mbit/s
• at interface 2 in accordance with PROFIBUS	9.6 kbit/s ... 12 Mbit/s
<b>Interfaces</b>	
Number of electrical connections	
• at interface 1 in accordance with PROFIBUS	1
• at interface 2 in accordance with PROFIBUS	1
Design of electrical connection	
• at interface 1 in accordance with PROFIBUS	9-pin Sub-D socket (RS 485)
• at interface 2 in accordance with PROFIBUS	9-pin Sub-D socket (RS 485)
• of the backplane bus	PCI Express x1
<b>Supply voltage, current consumption, power loss</b>	
Type of supply voltage	DC
Supply voltage	
• 1 from backplane bus	3.3 V
• 2 from the backplane bus	12 V
Relative symmetrical tolerance	
• at 3.3 V with DC	9 %
• at 12 V with DC	8 %
Consumed current	
• 1 from backplane bus with DC maximum	0.75 A
• 2 from backplane bus with DC maximum	0.3 A
Resistive loss	6.1 W

Article No.	6GK1562-4AA00
<b>Product-type designation</b>	CP 5624
<b>Permitted ambient conditions</b>	
Ambient temperature	
• during operating	5 ... 60 °C
• during storage	-20 ... +60 °C
• during transport	-20 ... +60 °C
Relative humidity at 25 °C without condensation during operating maximum	85 %
Protection class IP	IP00
<b>Design, dimensions and weight</b>	
Module format	PCI Express x1 (half length)
Width	21.6 mm
Height	126.3 mm
Depth	180.5 mm
Net weight	117 g
<b>Product properties, functions, components general</b>	
Number of plug-in cards in the same design can be plugged in per PC station	4
Number of modules note	FMS-5613 supports up to two CP 5603 / CP 5613 A2 / CP 5614 A2 / CP 5623 / CP 5624 processors
<b>Performance data</b>	
<u>Performance data open communication</u>	
Software for open communication by means of SEND/RECEIVE required	FDL driver included in scope of delivery of the CP
Number of possible connections for open communication by means of SEND/RECEIVE maximum	80

G\_IK10\_XX\_50110

### Technical specifications (continued)

Article No.	6GK1562-4AA00
Product-type designation	CP 5624
<u>Performance data</u> <u>PROFIBUS DP</u>	
Software for DP master function required	No
Service as DP master	
• DPV0	Yes
• DPV1	Yes
• DPV2	Yes
Number of DP slaves on DP master usable	124
Amount of data	
• of the address area of the inputs as DP master overall	30 256 byte
• of the address area of the outputs as DP master overall	30 256 byte
• of the address area of the inputs per DP slave	244 byte
• of the address area of the outputs per DP slave	244 byte
• of the address area of the diagnostic data per DP slave	244 byte
Software for DP slave function required	No
Service as DP slave	
• DPV0	Yes
• DPV1	Yes
Amount of data	
• of the address area of the inputs as DP slave overall	244 byte
• of the address area of the outputs as DP slave overall	244 byte
<u>Performance data</u> <u>FMS functions</u>	
Software for FMS communication required	Yes, FMS-5613
Number of possible connections for FMS connection maximum	40
<u>Performance data</u> <u>S7 communication</u>	
Software for S7 communication required	Yes, HARDNET-PB S7 (S7-5613)
Number of possible connections for S7/PG communication maximum	50
<u>Performance data</u> <u>multi-protocol mode</u>	
Number of active connections with multiprotocol mode	50
Number of configurable connections per PC station	207
<b>Product functions management, configuration</b>	
Configuration software required	included in scope of delivery
<b>Product functions Diagnosis</b>	
Product function Port diagnostics	Yes
<b>Standards, specifications, approvals</b>	
Standard	
• for EMC	2004/108/EC
• for safety of CSA and UL	CAN/CSA C22.2 & UL 60950-1
• for emitted interference	EN 61000-6-3, EN 61000-6-4
• for interference immunity	EN 61000-6-1, EN 61000-6-2
Verification of suitability	
• CE mark	Yes
• C-Tick	Yes

### Ordering data

### Article No.

**CP 5624 communications processor**

PCI Express x1 card (32 bit) for master and slave connection to PROFIBUS incl. DP-Base software with NCM PC; DP-RAM interface for DP master, incl. PG and FDL protocols; single license for one installation, runtime software, software and electronic manual on CD-ROM, Class A, for operating system support see SIMATIC NET software; German/English

**6GK1562-4AA00**

#### Accessories

#### PROFIBUS FastConnect bus connector RS485 Plug 180

With 180° cable outlet, insulation displacement

**6GK1500-0FC10**

#### PROFIBUS FC Standard Cable GP

Standard type with special design for quick assembly, 2-core, shielded, sold in meters; max. length 1 000 m, minimum order 20 m

**6XV1830-0EH10**

#### PROFIBUS FastConnect Stripping Tool

Preset stripping tool for fast stripping of PROFIBUS FastConnect bus cables

**6GK1905-6AA00**

#### PROFIBUS bus terminal 12M

Bus terminal for connection of PROFIBUS stations up to 12 Mbit/s with plug-in cable 1.5 m long

**6GK1500-0AA10**

#### Note:

For software ordering data, see page 3/227

### More information

You can find the HARDNET-PB DP Development Kit on the Internet at:

<http://www.siemens.com/simatic-net/dk5613>

## PROFIBUS

### Communication for PC-based systems

#### CP 5612

#### Overview

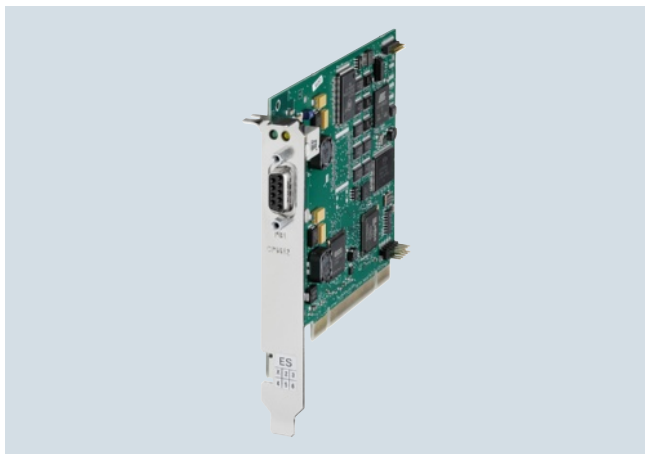

DP-M	DP-S	FMS	OPC	PG/OP	S7/S5
●	●		●	●	●

- PCI card (universal-keyed 5 V/3.3 V) for connecting PCs and SIMATIC PG/PC to PROFIBUS at up to 12 Mbit/s and to the MPI interface of SIMATIC S7
- Communication services:
  - PROFIBUS DP Master Class 1 incl. acyclic DP expansions with SOFTNET-PB DP software package
  - PROFIBUS DP Master Class 2 incl. acyclic DP expansions with SOFTNET-PB DP software package
  - PROFIBUS DP slave with SOFTNET-PB DP Slave software package
  - PG/OP communication with STEP 7
  - S7 communication with SOFTNET-PB S7 software package
  - Open communication (SEND/RECEIVE on basis of the FDL interface) with SOFTNET-PB DP or SOFTNET-PB S7 software package
- Can be used with:
  - STEP 7, STEP 7-Micro/Win, SIMATIC PDM (for PG/OP communication)
  - SOFTNET-PB S7 (for S7 communication)
  - SOFTNET-PB DP, SOFTNET-PB DP slave (for DP)
- The appropriate OPC servers and configuration tools are included in the scope of supply of the respective communications software.

#### Benefits

get **Designed for Industry**

- Connection for portable PCs (e.g. for diagnostics and commissioning)
- Easy installation and startup
- Optimally coordinated with SOFTNET
- OPC as standard interface
- Uniform procedure and configuration functionality with NCM PC and STEP 7
- Flexible use possible in PG/PC through PCI 3.3/5 V, 33/66 MHz and compatibility with 64-bit PCI X slot

#### Application



The CP 5612 permits the connection of programming devices (PGs) and PCs to PROFIBUS and to the multipoint interface (MPI) of the SIMATIC S7:

- for PGs/PCs with PCI slot

#### Design

- Short PCI card
- Operation possible in 3.3 V and 5 V PCI slots (universal keyed)
- 33 MHz or 66 MHz PCI clock
- Operation possible as 32-bit card in a 64-bit PCI X slot
- 9-pin sub-D socket for connection to PROFIBUS

#### Function

The CP 5612 is operated under various software packages and offers the user the opportunity of performing functions of the programming devices and PCs by means of PROFIBUS and the multipoint interface (MPI).

Only one CP can be used per PG or PC. Similarly only one protocol (PROFIBUS DP, S7 communication or FDL) can be used per CP.

The following software packages support the CP 5612:

- STEP 7 from V5.5 SP3;  
Drivers for the CP 5612 are included with STEP 7.
- SOFTNET-S7 V8.2 SP1 and higher;  
This package allows the S7 programming interface to be used.
- SOFTNET-DP V8.2 SP1 and higher;  
This enables the CP 5612 to be used as PROFIBUS DP master Class 1 or Class 2.
- SOFTNET-DP Slave V8.2 SP1 and higher;  
For use of the CP 5612 as PROFIBUS DP slave
- NCM PC;  
Drivers for the CP 5612 are included in the scope of supply (SIMATIC NET CD V8.2 SP1 and higher).
- WinCC/WinCC Flexible;  
Drivers for the CP 5612 are included in the scope of supply (SIMATIC NET CD V8.2 SP1 and higher).



**Technical specifications**

Article No.	6GK1561-2AA00	6GK1561-2AM00
Product-type designation	CP 5612	CP 5612 MPI
<b>Transmission rate</b>		
Transmission rate at interface 1 in accordance with PROFIBUS	9.6 kbit/s ... 12 Mbit/s	9.6 kbit/s ... 12 Mbit/s
<b>Interfaces</b>		
Number of electrical connections at interface 1 in accordance with PROFIBUS	1	1
Design of electrical connection <ul style="list-style-type: none"> <li>• at interface 1 in accordance with PROFIBUS</li> <li>• of the backplane bus</li> </ul>	9-pin Sub-D socket (RS 485)	9-pin Sub-D socket (RS 485)
<b>Supply voltage, current consumption, power loss</b>		
Type of supply voltage	DC	DC
Supply voltage <ul style="list-style-type: none"> <li>• 1 from backplane bus</li> <li>• 2 from the backplane bus</li> </ul>	3.3 V 12 V	3.3 V 12 V
Relative symmetrical tolerance <ul style="list-style-type: none"> <li>• at 3.3 V with DC</li> <li>• at 12 V with DC</li> </ul>	9 % 8 %	9 % 8 %
Consumed current <ul style="list-style-type: none"> <li>• 1 from backplane bus with DC maximum</li> <li>• 2 from backplane bus with DC maximum</li> </ul>	0.15 A 0.25 A	0.15 A 0.25 A
Resistive loss	3.5 W	3.5 W
<b>Permitted ambient conditions</b>		
Ambient temperature <ul style="list-style-type: none"> <li>• during operating</li> <li>• during storage</li> <li>• during transport</li> </ul>	5 ... 55 °C -20 ... +60 °C -20 ... +60 °C	5 ... 55 °C -20 ... +60 °C -20 ... +60 °C
Relative humidity at 25 °C without condensation during operating maximum	95 %	95 %
Protection class IP	IP00	IP00
<b>Design, dimensions and weight</b>		
Module format	PCI	PCI
Width	18 mm	18 mm
Height	107 mm	107 mm
Depth	125 mm	125 mm
Net weight	98 g	298 g
<b>Product properties, functions, components general</b>		
Number of plug-in cards in the same design can be plugged in per PC station	1	1
Number of modules note	-	-

**PROFIBUS**

## Communication for PC-based systems

**CP 5612****Technical specifications** (continued)

Article No.	6GK1561-2AA00	6GK1561-2AM00
Product-type designation	CP 5612	CP 5612 MPI
<b>Performance data</b>		
<u>Performance data open communication</u>		
Software for open communication by means of SEND/RECEIVE required	Yes, SOFTNET-PB DP / SOFTNET-PB DP Slave / SOFTNET-PB S7	Yes, SOFTNET-PB DP / SOFTNET-PB DP Slave / SOFTNET-PB S7
Number of possible connections for open communication by means of SEND/RECEIVE maximum	50	50
<u>Performance data PROFIBUS DP</u>		
Software for DP master function required	Yes, SOFTNET-PB DP	Yes, SOFTNET-PB DP
Service as DP master		
• DPV0	Yes	Yes
• DPV1	Yes	Yes
• DPV2	No	No
Number of DP slaves on DP master usable	64	64
<u>Amount of data</u>		
• of the address area of the inputs as DP master overall	14 640 byte	14 640 byte
• of the address area of the outputs as DP master overall	14 640 byte	14 640 byte
• of the address area of the inputs per DP slave	244 byte	244 byte
• of the address area of the outputs per DP slave	244 byte	244 byte
• of the address area of the diagnostic data per DP slave	244 byte	244 byte
Software for DP slave function required	Yes, SOFTNET-PB DP slave	Yes, SOFTNET-PB DP slave
Service as DP slave		
• DPV0	Yes	Yes
• DPV1	No	No
<u>Amount of data</u>		
• of the address area of the inputs as DP slave overall	122 byte	122 byte
• of the address area of the outputs as DP slave overall	122 byte	122 byte
<u>Performance data S7 communication</u>		
Software for S7 communication required	Yes, SOFTNET-PB S7	Yes, SOFTNET-PB S7
Number of possible connections for S7/PG communication maximum	8	8
<u>Performance data multi-protocol mode</u>		
Number of configurable connections per PC station	207	207
<b>Product functions management, configuration</b>		
Configuration software required	included in scope of delivery of required software product	included in scope of delivery of required software product

**Technical specifications** (continued)

Article No.	6GK1561-2AA00	6GK1561-2AM00
<b>Product-type designation</b>	CP 5612	CP 5612 MPI
<b>Standards, specifications, approvals</b>		
Standard	89/336/EEC	89/336/EEC
• for EMC	CAN/CSA C22.2 & UL 60950-1, UL 1950	CAN/CSA C22.2 & UL 60950-1, UL 1950
• for safety of CSA and UL	EN 61000-6-3	EN 61000-6-3
• for emitted interference	EN 61000-6-2	EN 61000-6-2
• for interference immunity		
Verification of suitability		
• CE mark	Yes	Yes
• C-Tick	Yes	Yes
<b>Accessories</b>		
Accessories	optional: MPI cable	included in scope of supply: MPI cable

**Ordering data**
**Article No.**

<b>CP 5612 communications processor</b>	
• PCI card (32-bit) for connection of a programming device or PC to PROFIBUS	<b>6GK1561-2AA00</b>
• PCI card (32-bit) CP 5612 and MPI cable, 5 m	<b>6GK1561-2AM00</b>
<b>Accessories</b>	
<b>PROFIBUS FastConnect bus connector RS485 Plug 180</b>	<b>6GK1500-0FC10</b>
With 180° cable outlet, insulation displacement	
<b>PROFIBUS FC Standard Cable GP</b>	<b>6XV1830-0EH10</b>
Standard type with special design for quick assembly, 2-core, shielded, sold in meters; max. length 1 000 m, minimum order 20 m	
<b>PROFIBUS FastConnect Stripping Tool</b>	<b>6GK1905-6AA00</b>
Preset stripping tool for fast stripping of PROFIBUS FastConnect bus cables	
<b>PROFIBUS bus terminal 12M</b>	<b>6GK1500-0AA10</b>
Bus terminal for connection of PROFIBUS stations up to 12 Mbit/s with plug-in cable 1.5 m long	

Note:

For software ordering data, see page 3/227

## PROFIBUS

### Communication for PC-based systems

CP 5622

#### Overview

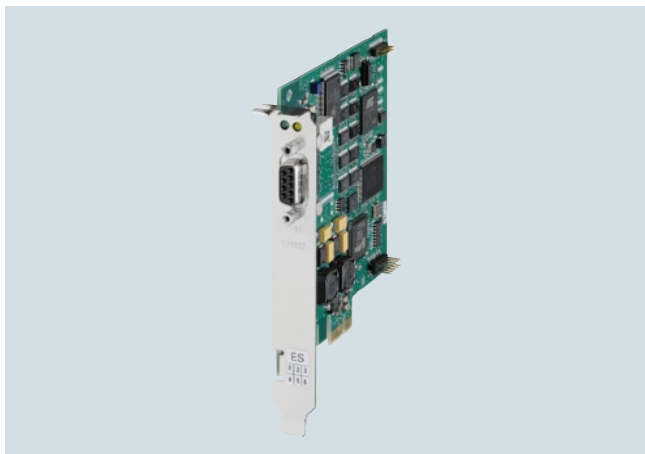

DP-M	DP-S	FMS	OPC	PG/OP	S7/S5
●	●		●	●	●

- PCI Express card (PCIe x1) for connection of PCs and SIMATIC PG/PC to PROFIBUS at up to 12 Mbit/s and to the MPI of the SIMATIC S7
- Communication services:
  - PROFIBUS DP Master Class 1 incl. acyclic DP expansions with SOFTNET-PB DP software package
  - PROFIBUS DP Master Class 2 incl. acyclic DP expansions with SOFTNET-PB DP software package
  - PROFIBUS DP slave with SOFTNET-PB DP Slave software package
  - PG/OP communication with STEP 7
  - S7 communication with SOFTNET-PB S7 software package
  - Open communication (SEND/RECEIVE on basis of the FDL interface) with SOFTNET-PB DP or SOFTNET-PB S7 software package
- Can be used with:
  - STEP 7, STEP 7-Micro/Win, SIMATIC PDM (for PG/OP communication)
  - SOFTNET-PB S7 (for S7 communication)
  - SOFTNET-PB DP, SOFTNET-PB DP slave (for DP)
- The appropriate OPC servers and configuration tools are included in the scope of supply of the respective communications software.

#### Benefits

get **Designed for Industry**

- Connection for portable PCs (e.g. for diagnostics and commissioning)
- Easy installation and startup
- Optimally coordinated with SOFTNET
- OPC as standard interface
- Uniform procedure and configuration functionality with NCM PC and STEP 7
- Can be used flexibly as PCIe x1 card in PC/IPC with PCI Express x1, x4, x8 or x16 slots

#### Application



The CP 5622 permits the connection of programming devices (PGs) and PCs to PROFIBUS and to the multipoint interface (MPI) of the SIMATIC S7:

- for PGs/PCs with PCI Express slot

#### Design

- Short PCI Express card
- 9-pin sub-D socket for connection to PROFIBUS
- Operation in the PCI Express x1, x4, x8 or x16 slots is possible

#### Function

The CP 5622 is operated under various software packages and offers the user the opportunity of performing functions of the programming devices and PCs by means of PROFIBUS and the multipoint interface (MPI).

Only one CP can be used per PG or PC. Similarly only one protocol (PROFIBUS DP, S7 communication or FDL) can be used per CP.

The following software packages support the CP 5622:

- STEP 7 from V5.5 SP3;  
Drivers for the CP 5622 are included with STEP 7.
- SOFTNET-S7 V8.2 SP1 and higher;  
This package allows the S7 programming interface to be used.
- SOFTNET-DP V8.2 SP1 and higher;  
This enables the CP 5622 to be used as PROFIBUS DP master Class 1 or Class 2.
- SOFTNET-DP Slave V8.2 SP1 and higher;  
For use of the CP 5622 as PROFIBUS DP slave
- NCM PC;  
Drivers for the CP 5622 are included in the scope of supply (SIMATIC NET CD V8.2 SP1 and higher).
- WinCC/WinCC Flexible;  
Drivers for the CP 5622 are included in the scope of supply (SIMATIC NET CD V8.2 SP1 and higher).

**Technical specifications**

Article No.	6GK1562-2AA00	6GK1562-2AM00
Product-type designation	CP 5622	CP 5622 MPI
<b>Transmission rate</b>		
Transmission rate at interface 1 in accordance with PROFIBUS	9.6 kbit/s ... 12 Mbit/s	9.6 kbit/s ... 12 Mbit/s
<b>Interfaces</b>		
Number of electrical connections at interface 1 in accordance with PROFIBUS	1	1
Design of electrical connection		
• at interface 1 in accordance with PROFIBUS	9-pin Sub-D socket (RS 485)	9-pin Sub-D socket (RS 485)
• of the backplane bus	PCI Express x1	PCI Express x1
<b>Supply voltage, current consumption, power loss</b>		
Type of supply voltage	DC	DC
Supply voltage		
• 1 from backplane bus	3.3 V	3.3 V
• 2 from the backplane bus	12 V	12 V
Relative symmetrical tolerance		
• at 3.3 V with DC	9 %	9 %
• at 12 V with DC	8 %	8 %
Consumed current		
• 1 from backplane bus with DC maximum	0.3 A	0.3 A
• 2 from backplane bus with DC maximum	0.25 A	0.25 A
Resistive loss	4 W	4 W
<b>Permitted ambient conditions</b>		
Ambient temperature		
• during operating	5 ... 55 °C	5 ... 55 °C
• during storage	-20 ... +60 °C	-20 ... +60 °C
• during transport	-20 ... +60 °C	-20 ... +60 °C
Relative humidity at 25 °C without condensation during operating maximum	85 %	85 %
Protection class IP	IP00	IP00
<b>Design, dimensions and weight</b>		
Module format	PCI Express x1	PCI Express x1
Width	18 mm	18 mm
Height	107 mm	107 mm
Depth	101 mm	101 mm
Net weight	87 g	287 g
<b>Product properties, functions, components general</b>		
Number of plug-in cards in the same design can be plugged in per PC station	1	1
Number of modules note	-	-

**PROFIBUS**

## Communication for PC-based systems

## CP 5622

**Technical specifications** (continued)

Article No.	6GK1562-2AA00	6GK1562-2AM00
Product-type designation	CP 5622	CP 5622 MPI
<b>Performance data</b>		
<u>Performance data open communication</u>		
Software for open communication by means of SEND/RECEIVE required	Yes, SOFTNET-PB DP / SOFTNET-PB DP Slave / SOFTNET-PB S7	Yes, SOFTNET-PB DP / SOFTNET-PB DP Slave / SOFTNET-PB S7
Number of possible connections for open communication by means of SEND/RECEIVE maximum	50	50
<u>Performance data PROFIBUS DP</u>		
Software for DP master function required	Yes, SOFTNET-PB DP	Yes, SOFTNET-PB DP
Service as DP master		
• DPV0	Yes	Yes
• DPV1	Yes	Yes
• DPV2	No	No
Number of DP slaves on DP master usable	64	64
<u>Amount of data</u>		
• of the address area of the inputs as DP master overall	14 640 byte	14 640 byte
• of the address area of the outputs as DP master overall	14 640 byte	14 640 byte
• of the address area of the inputs per DP slave	244 byte	244 byte
• of the address area of the outputs per DP slave	244 byte	244 byte
• of the address area of the diagnostic data per DP slave	244 byte	244 byte
Software for DP slave function required	Yes, SOFTNET-PB DP slave	Yes, SOFTNET-PB DP slave
Service as DP slave		
• DPV0	Yes	Yes
• DPV1	No	No
<u>Amount of data</u>		
• of the address area of the inputs as DP slave overall	122 byte	122 byte
• of the address area of the outputs as DP slave overall	122 byte	122 byte
<u>Performance data S7 communication</u>		
Software for S7 communication required	Yes, SOFTNET-PB S7	Yes, SOFTNET-PB S7
Number of possible connections for S7/PG communication maximum	8	8
<u>Performance data multi-protocol mode</u>		
Number of configurable connections per PC station	207	207
<b>Product functions management, configuration</b>		
Configuration software required	included in scope of delivery of required software product	included in scope of delivery of required software product

**Technical specifications** (continued)

Article No.	6GK1562-2AA00	6GK1562-2AM00
<b>Product-type designation</b>	CP 5622	CP 5622 MPI
<b>Standards, specifications, approvals</b>		
Standard	2004/108/EC	2004/108/EC
• for EMC	CAN/CSA C22.2 & UL 60950-1, UL 508	CAN/CSA C22.2 & UL 60950-1, UL 508
• for safety of CSA and UL	EN 61000-6-3, EN 61000-6-4	EN 61000-6-3, EN 61000-6-4
• for emitted interference	EN 61000-6-1, EN 61000-6-2	EN 61000-6-1, EN 61000-6-2
• for interference immunity		
Verification of suitability		
• CE mark	Yes	Yes
• C-Tick	Yes	Yes
<b>Accessories</b>		
Accessories	optional: MPI cable	included in scope of supply: MPI cable

**Ordering data**
**Article No.**

<b>CP 5622 communications processor</b>	
• PCI Express x1 card (32-bit) for connection of a PG or PC to PROFIBUS	<b>6GK1562-2AA00</b>
• PCI Express x1 card (32-bit) CP 5622 and MPI cable, 5 m	<b>6GK1562-2AM00</b>
<b>Accessories</b>	
<b>PROFIBUS FastConnect bus connector RS485 Plug 180</b>	<b>6GK1500-0FC10</b>
With 180° cable outlet, insulation displacement	
<b>PROFIBUS FC Standard Cable GP</b>	<b>6XV1830-0EH10</b>
Standard type with special design for quick assembly, 2-core, shielded, sold in meters; max. length 1 000 m, minimum order 20 m	
<b>PROFIBUS FastConnect Stripping Tool</b>	<b>6GK1905-6AA00</b>
Preset stripping tool for fast stripping of PROFIBUS FastConnect bus cables	
<b>PROFIBUS bus terminal 12M</b>	<b>6GK1500-0AA10</b>
Bus terminal for connection of PROFIBUS stations up to 12 Mbit/s with plug-in cable 1.5 m long	

Note:

For software ordering data, see page 3/227

# PROFIBUS

## Communication for PC-based systems

### CP 5711

#### Overview



DP-M	DP-S	FMS	OPC	PG/OP	S7/S5
●	●		●	●	●

- USB adapter for the connection of PCs and SIMATIC PG/PC to PROFIBUS DP or MPI via USB 2.0
- Operation in extended temperature range of -20 °C to +60 °C
- Active PROFIBUS termination to supply the PROFIBUS network as end station of a segment
- Robust USB connection due to mechanical locking of the USB connector to the CP 5711 enclosure
- Communication services:
  - PROFIBUS DP master Class 1 and 2 according to IEC 61158/61784 with SOFTNET-PB DP software package
  - PROFIBUS DP slave with SOFTNET-PB DP Slave software package
  - PG/OP communication with STEP 5 or STEP 7 software package
  - S7 communication with SOFTNET-PB S7 software package
  - Open communication (SEND/RECEIVE on basis of the FDL interface) with SOFTNET-PB DP or SOFTNET-PB S7 software package
- PROFIBUS connection with up to 12 Mbit/s
- Can be used with:
  - STEP 7, STEP 7 Micro/WIN, WinCC/WinCC flexible, NCM PC, SIMATIC PDM (for PG/OP communication)
  - SOFTNET-PB S7 (for S7 communication)
  - SOFTNET-PB DP, SOFTNET-PB DP slave (for DP)
- The appropriate OPC servers and configuration tools are included in the scope of supply of the respective communication software

#### Benefits



- Portability and flexibility  
Connection for portable PCs, e.g. for diagnostics and commissioning
- Low-cost PROFIBUS controller and device solutions for embedded PCs (without PCI or PC104 bus)
- Fault-free connection to the PROFIBUS for diagnosis at all times due to permanent installation on Profibus and connection via USB in the event of maintenance and diagnosis
- Easy installation and commissioning due to plug & play technology

#### Application



The CP 5711 enables the connection of SIMATIC PG/PC and PCs with USB interface to PROFIBUS and to the multi-point interface (MPI) of SIMATIC S7.

#### Design

- USB V2.0 connection
- Adapter with 9-pin sub-D socket for connection to PROFIBUS



### Function

The CP 5711 is a USB V2.0 adapter that can be used on either a USB V2.0 port (bandwidth 480 Mbit/s) or a USB V1.1 port (1.5 Mbit/s). It can be used with various software packages and offers users the ability to perform functions of the programming devices and PCs/OPs via PROFIBUS and the multi-point interface (MPI).

The CP 5711 is powered directly via the USB interface of the PC system. Regardless of whether the USB cable is plugged in or unplugged, the active power supply of the PROFIBUS network is drawn from the external 24 V DC power supply unit.

Optional for the use of the CP 5711 in control cabinets or in the vicinity of SIMATIC S7 controllers, a mounting adapter (DIN rail) is available to attach the CP to the 35 mm DIN rail.

Only one CP per PG/PC/OP can be operated. Likewise, only one protocol (PROFIBUS DP, S7 communication, or FDL) can be used per CP.

The following software packages support the CP 5711:

- STEP 7 from V5.4 SP5;  
drivers for the CP 5711 are included with STEP 7.
- SOFTNET-S7 from V7.1;  
the S7 programming interface can be used with this package.
- SOFTNET-DP from V7.1;  
with this, the CP 5711 can be used as PROFIBUS DP master Class 1 or 2.
- SOFTNET-DP slave from V7.1;  
for operating the CP 5711 as PROFIBUS DP slave
- STEP 7-Micro/WIN;  
drivers for the CP 5711 are included with STEP 7-Micro/WIN.
- WinCC/WinCC flexible;  
the CP 5711 can be used as a hardware basis for the configuration tool for SIMATIC Operator Panels, Touch Panels, and Text Displays.
- NCM PC;  
under Windows XP Professional
- SIMATIC PDM;  
drivers for the CP 5711 are included with SIMATIC PDM.

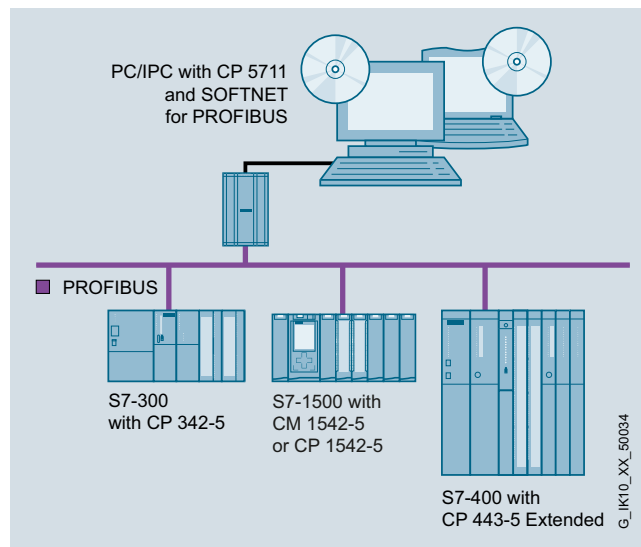

### Diagnostics

Numerous diagnostic tools are available for the CP 5711. For support, the module also includes comprehensive LED diagnostics. Operating and signal states can be recognized quickly via five LEDs.

### Configuration

- The S7 communication, open communication and DP protocols can be configured in STEP 7 or NCM PC.
- A configuration tool is included in the scope of delivery of the PROFIBUS SOFTNET software packages.

**PROFIBUS**

## Communication for PC-based systems

**CP 5711****Technical specifications**

<b>Order No.</b>	<b>6GK1571-1AA00</b>	<b>6GK1571-1AM00</b>
<b>Product-type designation</b>	<b>CP 5711</b>	<b>CP 5711 MPI</b>
<b>Transmission rate</b>		
Transmission rate at interface 1 in accordance with PROFIBUS	9.6 kbit/s ... 12 Mbit/s	9.6 kbit/s ... 12 Mbit/s
<b>Interfaces</b>		
Number of electrical connections at interface 1 in accordance with PROFIBUS	1	1
Number of interfaces according to USB	1	1
Number of electrical connections for power supply	1	1
Design of electrical connection		
• at interface 1 in accordance with PROFIBUS	9-pin Sub-D socket (RS 485)	9-pin Sub-D socket (RS 485)
• for power supply	2-pin terminal block	2-pin terminal block
• of the USB interface	Standard-B socket with mechanical interlock	Standard-B socket with mechanical interlock
Standard for interfaces USB 2.0	Yes	Yes
<b>Supply voltage, current consumption, power loss</b>		
Type of supply voltage	DC	DC
Type of power supply optional external supply	Yes	Yes
Supply voltage		
• from USB	5 V	5 V
• external	24 V	24 V
- minimum	18 V	18 V
- maximum	30 V	30 V
• note	Supplied directly from USB provided that supply from PC is adequate; alternative external supply is possible	Supplied directly from USB provided that supply from PC is adequate; alternative external supply is possible
Relative symmetrical tolerance		
• at 5 V with DC	5 %	5 %
• at 24 V with DC	5 %	5 %
Consumed current		
• from USB	0.5 A	0.5 A
• from external supply voltage at 24 V with DC maximum	0.3 A	0.3 A
Resistive loss	2.5 W	2.5 W
<b>Permitted ambient conditions</b>		
Ambient temperature		
• during operating	0 ... 60 °C	5 ... 60 °C
• during storage	-40 ... +60 °C	-20 ... +60 °C
• during transport	-40 ... +60 °C	-20 ... +60 °C
Relative humidity at 25 °C without condensation during operating maximum	85 %	85 %
Protection class IP	IP20	IP20
<b>Design, dimensions and weight</b>		
Module format	USB V2.0 adapter	USB V2.0 adapter
Width	85 mm	85 mm
Height	137 mm	137 mm
Depth	35 mm	35 mm
Net weight	300 g	500 g
Mounting type 35 mm DIN rail mounting	Yes	Yes
Mounting type	Mounting on DIN rail with optional mounting rail support	Mounting on DIN rail with optional mounting rail support

**Technical specifications** (continued)

Order No.	6GK1571-1AA00	6GK1571-1AM00
Product-type designation	CP 5711	CP 5711 MPI
<b>Product properties, functions, components general</b>		
Number of plug-in cards in the same design can be plugged in per PC station	1	1
Number of modules note	-	-
<b>Performance data</b>		
<u>Performance data open communication</u>		
Software for open communication by means of SEND/RECEIVE required	Yes, SOFTNET-PB DP / SOFTNET-PB DP Slave / SOFTNET-PB S7	Yes, SOFTNET-PB DP / SOFTNET-PB DP Slave / SOFTNET-PB S7
Number of possible connections for open communication by means of SEND/RECEIVE maximum	50	50
<u>Performance data PROFIBUS DP</u>		
Software for DP master function required	Yes, SOFTNET-PB DP	Yes, SOFTNET-PB DP
Service as DP master		
• DPV0	Yes	Yes
• DPV1	No	No
• DPV2	No	No
Number of DP slaves on DP master usable	64	64
Amount of data		
• of the address area of the inputs as DP master overall	15 616 byte	15 616 byte
• of the address area of the outputs as DP master overall	15 616 byte	15 616 byte
• of the address area of the inputs per DP slave	244 byte	244 byte
• of the address area of the outputs per DP slave	244 byte	244 byte
• of the address area of the diagnostic data per DP slave	244 byte	244 byte
Software for DP slave function required	Yes, SOFTNET-PB DP slave	Yes, SOFTNET-PB DP slave
Service as DP slave		
• DPV0	Yes	Yes
• DPV1	No	No
Amount of data		
• of the address area of the inputs as DP slave overall	122 byte	122 byte
• of the address area of the outputs as DP slave overall	122 byte	122 byte
<u>Performance data S7 communication</u>		
Software for S7 communication required	Yes, SOFTNET-PB S7	Yes, SOFTNET-PB S7
Number of possible connections for S7/PG communication maximum	8	8
<u>Performance data multi-protocol mode</u>		
Number of configurable connections per PC station	207	207
<b>Product functions management, configuration</b>		
Configuration software required	included in scope of delivery of required software product	included in scope of delivery of required software product

# PROFIBUS

## Communication for PC-based systems

### CP 5711

#### Technical specifications (continued)

<b>Order No.</b>	<b>6GK1571-1AA00</b>	<b>6GK1571-1AM00</b>
<b>Product-type designation</b>	<b>CP 5711</b>	<b>CP 5711 MPI</b>
<b>Product functions Diagnosis</b>		
Product function Port diagnostics	Yes	Yes
<b>Standards, specifications, approvals</b>		
Standard		
• for EMC	2004/108/EC	2004/108/EC
• for safety of CSA and UL	CAN/CSA C22.2 & UL 60950-1	CAN/CSA C22.2 & UL 60950-1
• for emitted interference	EN 61000-6-3, EN 61000-6-4	EN 61000-6-3, EN 61000-6-4
• for interference immunity	EN 61000-6-1, EN 61000-6-2	EN 61000-6-1, EN 61000-6-2
Verification of suitability		
• CE mark	Yes	Yes
• C-Tick	Yes	Yes
<b>Accessories</b>		
Accessories	optional: MPI cable, mounting rail support	included in scope of supply: MPI cable / optional: rail support

<b>Article No.</b>	<b>6GK1571-1AA00-0AD0</b>
<b>Product-type designation</b>	<b>Steckleitung USB für CP 5711</b>
<b>Product description</b>	
<b>Acceptability for application</b>	For connecting a CP 5711 to the USB interface of a PG/PC/IPC or notebook
<b>Cable length</b>	2 m
<b>Mechanical data</b>	
Net weight	0.1 kg

#### Ordering data

**CP 5711 communications processor**  
for connection of a programming device or notebook to PROFIBUS or MPI, under 32 bit in connection with PROFIBUS SOFTNET software or STEP 7;  
German/English

- USB V2.0 adapter
- USB V2.0 adapter CP 5711 and MPI cable, 5 m

**6GK1571-1AA00**  
**6GK1571-1AM00**

#### Accessories

##### PROFIBUS FastConnect bus connector RS485 Plug 180

With 180° cable outlet, insulation displacement

**6GK1500-0FC10**

##### PROFIBUS FC Standard Cable GP

Standard type with special design for quick assembly, 2-core, shielded, sold in meters;  
max. length 1 000 m, minimum order 20 m

**6XV1830-0EH10**

##### PROFIBUS FastConnect Stripping Tool

Preset stripping tool for fast stripping of PROFIBUS FastConnect bus cables

**6GK1905-6AA00**

##### PROFIBUS bus terminal 12M

Bus terminal for connection of PROFIBUS stations up to 12 Mbit/s with plug-in cable 1.5 m long

**6GK1500-0AA10**

##### Mounting rail support

Compartment for CP 5711 enclosure; fastened mechanically to 35 mm DIN rail

**6GK1571-1AA00-0AH0**

#### Note:

For software ordering data, see page 3/227

### Overview

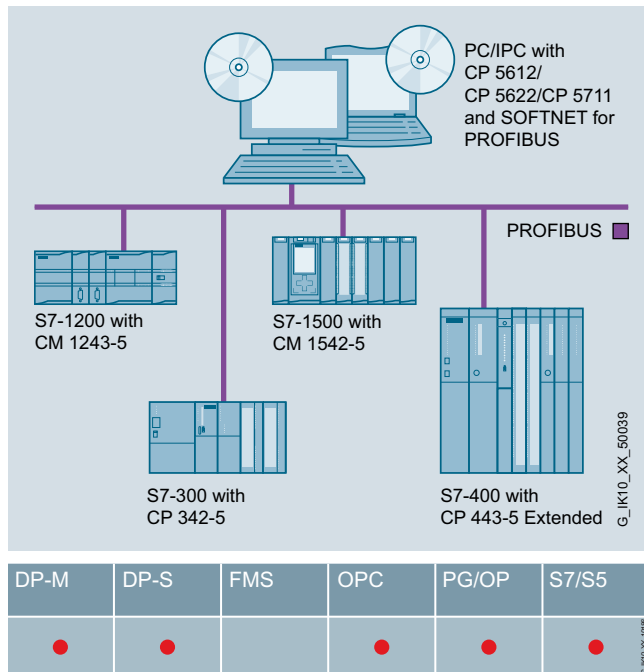

- Software for connecting PCs/programming devices and notebooks to programmable controllers
- Communication services:
  - PROFIBUS DP master Class 1 and 2 with acyclic expansions
  - PROFIBUS DP slave
  - PG/OP communication
  - S7 communication
  - Open communication (SEND/RECEIVE) based on the FDL interface
- The appropriate OPC servers and configuration tools are included in the scope of supply of the respective communications software

### Benefits

get **Designed for Industry**

- Maximum transparency due to integrated communication with SIMATIC via PROFIBUS and OPC as the standard interface
- Low-cost connection
  - as PROFIBUS DP master class 1 or master class 2 with SOFTNET-PB DP
  - as PROFIBUS DP slave with SOFTNET-PB DP slave
  - to S7 communication with SOFTNET-PB S7
- Simple and low-cost commissioning thanks to uniform procedure and configuration functionality with NCM PC and STEP 7

### Application



With SOFTNET for PROFIBUS, PCs can be connected to programmable controllers, such as SIMATIC S7, over PROFIBUS.

The following user interfaces are available:

- DP protocol
- PG/OP communication for SIMATIC S7
- S7 communication
- Open communication (SEND/RECEIVE) based on the FDL interface

SOFTNET is available for the following interfaces:

- CP 5612 (PCI, 32 bit)
- CP 5622 (PCIe x1)
- CP 5711 (USB V2.0)

The operating systems that are supported are listed in the ordering data for the SOFTNET software.

## PROFIBUS

### Communication for PC-based systems

#### SOFTNET for PROFIBUS

#### Function

##### Software for DP protocol (SOFTNET-PB DP)

- **DP Master Class 1**

SOFTNET-PB DP offers DP master class 1 functionality. The central controller exchanges information with the DP slaves (e.g. ET 200S) in a specified, constantly repeating message cycle. The OPC programming interface provides the PC programmer with function calls for data transfer. The DP interface also provides the SYNC and FREEZE functions as well as activation and deactivation of slaves.

The DP function expansions for masters of Class 1 make it possible to perform read and write functions (DS\_READ, DS\_WRITE) as well as acknowledgement of alarms (ALARM\_ACK) at the same time as processing cyclic data communication. Data that are to be transferred in acyclic mode (e.g. parameterization data) are only rarely changed in comparison to the cyclic measured values, and are transferred at lower priority in parallel with the cyclic high-speed user data transfer. Alarm acknowledgement by the master ensures reliable transfer of the alarms from DP slaves.

- **DP Master Class 2**

In addition to DP master Class 1 services, SOFTNET-PB DP also provides DP Master Class 2 services. Devices of this type are used (programming, configuration or control devices) during start-up, for configuring the DP system or for controlling the plant during normal operation (diagnostics). The DP programming interface provides the following services: Reading master diagnostics, slave diagnostics, inputs/outputs of a slave, configuration data and modifying slave addresses. These extended DP functions comprise non-isochronous access to the parameters and measured values of a slave (e.g. field devices of process automation and intelligent HMI devices). This type of slave must be supplied with extensive parameter data during start-up and during normal operation (DS\_READ, DS\_WRITE).

- **DP slave (SOFTNET-PB DP slave)**

A DP slave is an I/O station that reads in input data and transfers output data to the I/O. The volume of input and output information is determined by the user application and can be a maximum of 122 bytes each. For the slave interface, a simple example GSD file is provided that can be adapted by the user to the slave application. This GSD file can be configured using any configuration tool which complies with the PROFIBUS DP specification IEC 61158/EN 50170, e.g. STEP 7 or NCM PC.

##### Software for PG/OP communication

Special programming device packages are not required because the drivers are included in the STEP 7 scope of supply.

##### Software for S7 communication (SOFTNET-PB S7)

SIMATIC S7 system components communicate with each other using S7 communication functions. The S7 programming interface provides programming device/PC user programs with access to SIMATIC S7 system components. This provides easy, flexible access to the data of the SIMATIC S7 controller.

The following services are available with S7 communication:

##### Administrative services

- Connection management
- Mini database
- Trace

##### Data transfer services

- Read/write variables
- BSEND/BRECEIVE (up to 64 KB per task)

##### Software for open communication (SEND/RECEIVE based on the FDL interface)

This interface based on Layer 2 is used for communication between

- PG/PC and SIMATIC S5
- PG/PC and SIMATIC S7
- PG/PC and PG/PC

used

SEND/RECEIVE offers the following services:

- Management services
- Connection establishment services
- Data transfer services

This interface is included in SOFTNET-PB DP and SOFTNET-PB S7. No configuration is necessary.

##### User interfaces

- **OPC interface**

The OPC server included in the respective software package can be used as the standard programming interface for the PROFIBUS DP, open communication and S7 communication protocols for linking automation technology applications to OPC-capable Windows applications (Office, HMI systems, etc.).

##### Mode of operation

With SOFTNET, the complete protocol stack is processed in the PC.

This architecture means that in contrast to the CP 5613 or CP 5614 products, the performance of the SOFTNET packages is dependent on the configuration or loading of the PC used.

##### Configuration

- The S7 communication protocol, open communication protocol and DP protocol are configured in STEP 7/ NCM PC V5.1 + SP2 and higher.
- A configuration tool is included in the scope of delivery of the PROFIBUS software packages.

### Technical specifications

Performance data	CP 5612/CP 5622/CP 5711
<u>Mono protocol mode</u>	
Number of connectable DP slaves	max. 60
Number of FDL tasks waiting	max. 50
Number of PG/OP and S7 connections	max. 8
• DP master	DP-V0, DP-V1 with SOFTNET-PB DP
• DP slave	DP-V0, DP-V1 with SOFTNET-PB DP slave

### Ordering data

#### SOFTNET-PB S7

Software for S7 communication, incl. FDL protocol with OPC server and configuration tool, runtime software, software and electronic manual on DVD-ROM, license key on USB stick, Class A; for CP 5612 (Win 7 and higher), CP 5622 (Win 7 and higher), CP 5711

#### SOFTNET-PB S7 V12

for 32/64-bit:  
Windows 7 Professional/Ultimate;  
for 32/64-bit: Windows 8 Pro;  
for 64-bit: Windows 2008 Server R2;  
for 64-bit: Windows 2012 Server;  
German/English

- Single License for one installation

#### Software Update Service

For 1 year, with automatic extension;  
requirement:  
Current software version

#### Upgrade

- From Edition 2006 to SOFTNET-S7 Edition 2008 or V12
- From V6.0, V6.1, V6.2 or V6.3 to SOFTNET-S7 Edition 2008 or V12

#### SOFTNET-PB DP

Software for DP protocol (master Class 1 and 2), incl. FDL protocol with OPC server and configuration tool; runtime software, software and electronic manual on DVD-ROM, license key on USB stick; for CP 5612 (Win 7 and higher), CP 5622 (Win 7 and higher), CP 5711

#### SOFTNET-PB DP V12

for 32/64-bit:  
Windows 7 Professional/Ultimate;  
for 32/64-bit: Windows 8 Pro;  
for 64-bit: Windows 2008 Server R2;  
for 64-bit: Windows 2012 Server;  
German/English

- Single License for one installation

### Article No.

**6GK1704-5CW12-0AA0**

**6GK1704-5CW00-3AL0**

**6GK1704-5CW00-3AE0**

**6GK1704-5CW00-3AE1**

**6GK1704-5DW12-0AA0**

### Article No.

#### Software Update Service

For 1 year, with automatic extension;  
requirement:  
Current software version

#### Upgrade

- From Edition 2006 to SOFTNET-DP Edition 2008 or V12
- From V6.0, V6.1, V6.2 or V6.3 to SOFTNET-DP Edition 2008 or V12

#### SOFTNET-PB DP slave

Software for DP slave, with OPC server and configuration tool, single license for one installation, runtime software, software and electronic manual on DVD-ROM, license key on USB stick, Class A; for CP 5612 (Win 7 and higher), CP 5622 (Win 7 and higher), CP 5711

#### SOFTNET-PB DP slave V12

for 32/64-bit:  
Windows 7 Professional/Ultimate;  
for 32/64-bit: Windows 8 Pro;  
for 64-bit: Windows 2008 Server R2;  
for 64-bit: Windows 2012 Server;  
German/English

- Single License for one installation

#### Software Update Service

For 1 year, with automatic extension;  
requirement:  
Current software version

#### Upgrade

- From Edition 2006 to SOFTNET-DP Slave Edition 2008 or V12
- From V6.0, V6.1, V6.2 or V6.3 to SOFTNET-DP Slave Edition 2008 or V12

**6GK1704-5DW00-3AL0**

**6GK1704-5DW00-3AE0**

**6GK1704-5DW00-3AE1**

**6GK1704-5SW12-0AA0**

**6GK1704-5SW00-3AL0**

**6GK1704-5SW00-3AE0**

**6GK1704-5SW00-3AE1**

#### Note:

The Windows XP software version is still available for older CPs; see the Industry Mall: <http://www.siemens.com/industrymall>.

## PROFIBUS

### Communication for PC-based systems

#### OPC server for PROFIBUS

##### Overview

- Standardized, open multi-vendor interface
- Interfacing of OPC-capable Windows applications to DP, FMS, S7 communication and open communication (SEND/RECEIVE) based on the FDL interface
- OPC Scout with browser functionality as an OPC client and OX-Data-Control/.NET Data Control for simple OPC client creation
- The relevant OPC servers are supplied with each communication software package

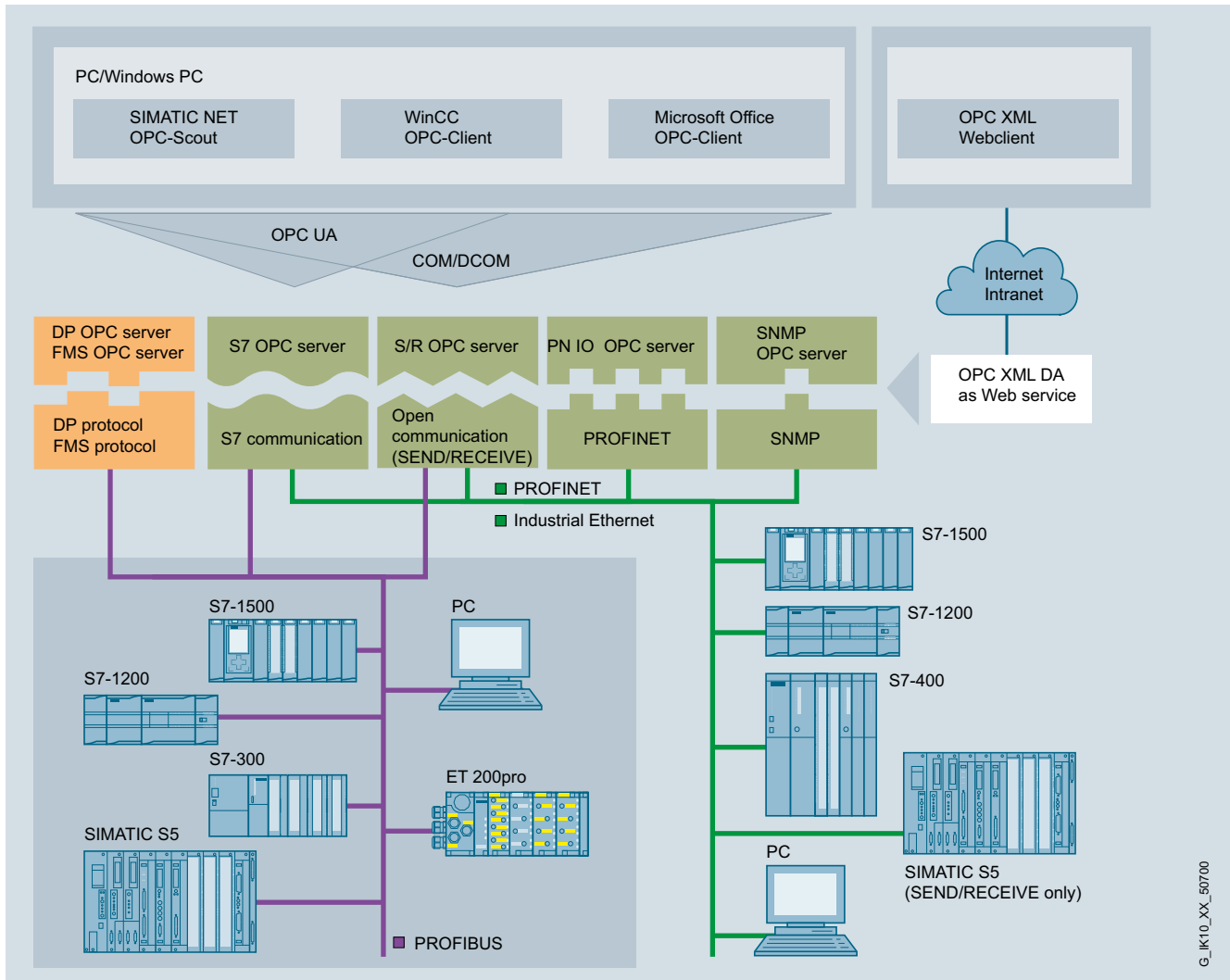

System integration with OPC server

##### Benefits

**get** Designed for Industry

- Different networks and protocols can be easily used thanks to the uniform interface
- Reduced training and familiarization costs
- Easy interfacing in the system environment and office applications over C++, Visual Basic and .NET interfaces
- Fast creation of applications
- Easy handling and cost-effective because the corresponding OPC server is included in the scope of supply of the respective communications software

G\_IK10\_XX\_50700



#### Application



OPC (Openness, Productivity & Collaboration) is a standardized, open, and vendor-independent interface that is widely used in automation.

A fundamental distinction is made between the classic OPC and its consistent further development OPC UA (Unified Architecture). Smooth migration to the new OPC UA standard is easily possible; this offers further value added such as security. The SIMATIC NET OPC servers offer the two interfaces OPC UA and classic OPC for PROFIBUS.

The following communications interfaces are available over OPC for PROFIBUS:

- DP communication for PROFIBUS DP
- DP-V0 Master Class 1 and Master Class 2  
DP-V1 Master Class 1 and Master Class 2  
PROFIdrive V3 interface for profile server
- FMS communication for PROFIBUS FMS
- S7 communication
- Open communication (SEND/RECEIVE) based on the FDL interface

The OPC server offers:

- Data Access interface 2.05
- Alarm&Event interface 1.1
- OPC XML DA interface 1.0
- Integration of automation products of different manufacturers
- The same, easy-to-use user interface for different components
- Can be accessed from every computer in the LAN
- High-performance data access over the Custom Interface (C++, NET)
- Easy to use with the "Automation Interface" (VB, NET) or the supplied OCX Data Control or .NET Data Control
- Grouping of variables (items); this way large quantities of data can be processed in a short time

#### Function

- Open standardization of the addressing using logical names for objects from an automation component or an automation system
- Supports STEP 7 symbols
- Efficient data transfer from a process component to an application for further processing
- One client application can use several servers simultaneously
- Simultaneous execution of more than one client is possible on one OPC server
- The communication protocols can be operated in parallel
- Interfaces
  - "Custom Interface" for high-performance C++/NET applications
  - "Automation Interface" for easily created Visual Basic applications (or similar)
  - OCX Data Control or .NET Data Control for simple connection to Windows applications that support COM/DCOM
  - XML DA interface;  
Data access to S7 CPUs is therefore possible over the Internet.

#### Configuration

- The communication parameters are configured using only the tools of the configuration software (configuration console, SIMATIC NCM PC or STEP 7 V5.1 + SP2 and higher)
- A configuration tool is included in the scope of delivery of the PROFIBUS software packages.

# PROFIBUS

## Communication for PC-based systems

### OPC server for PROFIBUS

#### Function (continued)

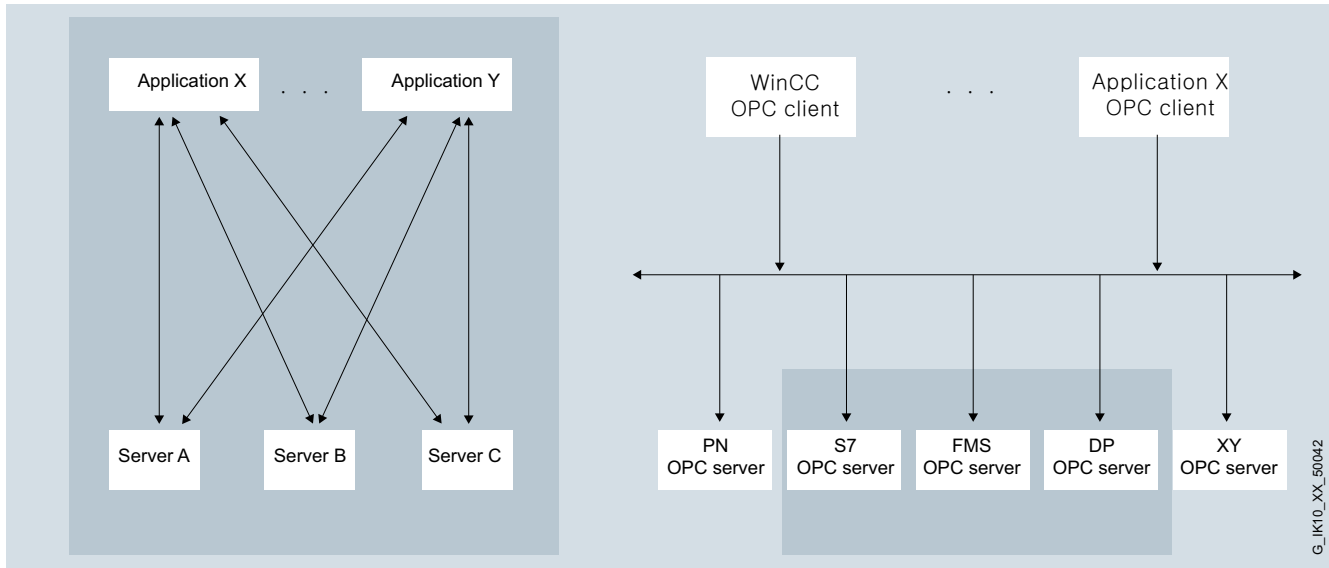

Comparison of conventional client/server architecture with an OPC architecture

#### Technical specifications

Programming	<ul style="list-style-type: none"> <li>• Synchronous and asynchronous reading and writing of variables</li> <li>• Monitoring of variables using the OPC server with a signal to the client when a change occurs</li> <li>• Use of quantity operations; so a large amount of data can be processed in a short time.</li> </ul>
Interfaces	<ul style="list-style-type: none"> <li>• Custom Interface (C++, NET); for high OPC performance</li> <li>• Automation Interface (VB, Excel, Access, Delphi, ...) for ease-of-use</li> <li>• Graphics with OCX or .NET Data Control; for configuring instead of programming</li> <li>• OPC XML-Interface for Data Access</li> </ul>
Protocols	<ul style="list-style-type: none"> <li>• S7 communication</li> <li>• Open communication (SEND/RECEIVE)</li> <li>• PROFIBUS DP</li> <li>• PROFIBUS FMS</li> </ul>

Product versions	include OPC servers for:
HARDNET-PB DP	PROFIBUS DP, XML-DA
HARDNET-PB S7	S7 communication, XML-DA
FMS-5613	FMS communication, XML-DA
SOFTNET-PB S7	S7 communication, XML-DA
SOFTNET-PB DP	PROFIBUS DP, XML-DA
SOFTNET-PB DP slave	PROFIBUS DP, Slave XML-DA
DP-Base software for HARDNET-PB CPs	Open communication (FDL) PROFIBUS DP Master, Access to DP-slave of the CP 5614 A3/CP 5624, XML-DA

G\_IK10\_XX\_50042

### Overview

OPC (**O**penness, **P**roductivity & **C**ollaboration) is a standardized, open, and vendor-independent interface that is widely used in automation. OPC UA (**U**nified **A**rchitecture) is the result of consistent further development of this standard, offering additional functions such as security or redundancy.

S7 OPC Redundancy is a software product compliant with the OPC UA standard that enables the redundant configuration of OPC UA servers to SIMATIC S7. The availability of automation data to operator control and monitoring systems is guaranteed thanks to the redundant use of OPC UA servers. This requires neither additional cabling for synchronizing the redundant OPC UA servers, nor additional programming overhead in the PC. The OPC UA servers are synchronized via high-performance Industrial Ethernet network access points at 10/100 and 1 000 Mbps. S7 OPC Redundancy represents an integrated customer solution for all SIMATIC NET S7 SOFTNET and HARDNET software products in the automation world.

### Benefits

- Enhanced plant availability thanks to redundant OPC UA servers that guarantee plant access for operator control and monitoring systems
- Secures investments thanks to the use of existing applications (OPC clients) and flexible application options, regardless of the SIMATIC S7 controller used
- Improved utilization of IT resources thanks to even distribution of the OPC clients among the redundant OPC servers
- Easy and low-cost commissioning thanks to uniform procedure and configuration functionality with NCM PC and STEP 7

### Application

The redundant OPC UA server software enables redundant configuration of SIMATIC NET OPC UA servers. Failure of one OPC UA server, as a result of power outage or system failure, for example, results in immediate use of the other OPC UA server, and continuation of the existing OPC UA client connection. This ensures increased availability of automation data to operator control and monitoring systems.

### Design

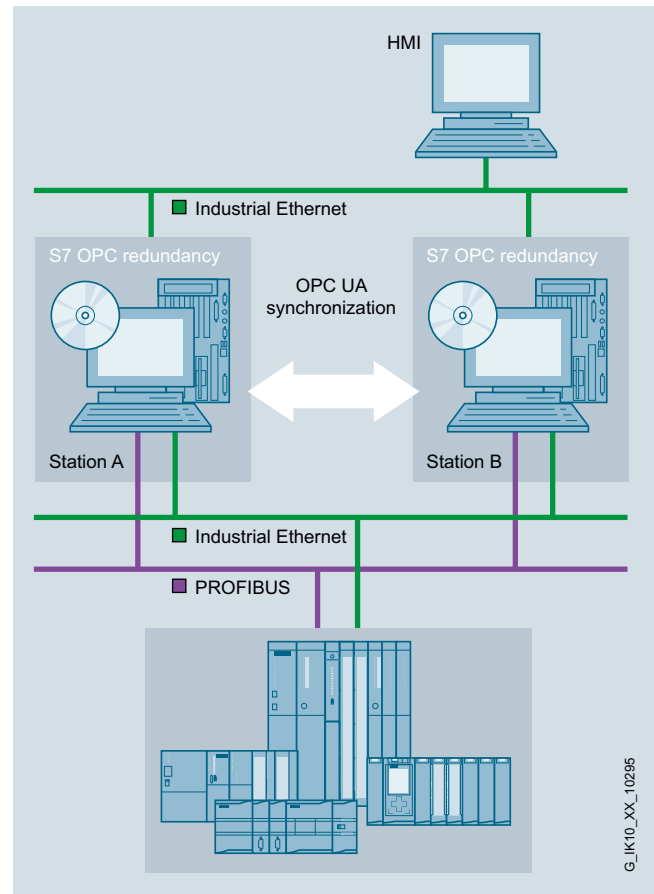

Redundant use of OPC servers

A redundant OPC UA server system comprises the following:

#### Server PC

with

- Operating system for Windows server
- SOFTNET-PB S7 or HARDNET-PB S7 software based on OPC UA server
- S7 OPC Redundancy software

The redundant operation of up to two OPC UA servers is possible.

#### Client PC (HMI)

- Software for OPC clients that supports OPC UA (incl. REDCONNECT functionalities in accordance with OPC UA specification)

The communication parameters are configured using STEP 7 or SIMATIC NET NCM PC. A configuration tool is included in the scope of delivery of the SIMATIC NET PC products.

## PROFIBUS

### Communication for PC-based systems

#### S7 OPC Redundancy for PROFIBUS

##### Function

S7 OPC Redundancy enables the setup of redundant OPC UA servers, thus ensuring plant access for the operator control and monitoring systems.

This means, for example, that the information synchronization between two SIMATIC NET S7 OPC servers via the S7 OPC Redundancy software package is guaranteed. This is handled transparently for the OPC Client application so that in the event of a fault, the redundant OPC server takes over the tasks from the failed OPC server system.

Data exchange between the OPC clients and the OPC servers takes place via the standardized OPC UA communication. Communication with the SIMATIC S7 controller takes place using the S7 protocol. This is ensured by the software products SIMATIC NET SOFTNET or HARDNET-S7 for PROFIBUS that are necessary as the basis for SIMATIC NET IE S7 OPC Redundancy.

The S7 OPC Redundancy software package supports:

- High availability;  
Failure of one OPC UA server results in immediate use of the other OPC UA server, and continuation of the existing OPC UA client connection. The basis for this is the OPC UA synchronization that ensures synchronization of the necessary client information.
- Load compensation;  
Even distribution of OPC clients among the available OPC servers

##### Configuration

A configuration tool is included in the scope of delivery of the corresponding packages.

##### Ordering data

##### Article No.

###### *S7 OPC Redundancy*

Software for redundant OPC servers, Runtime software, software and electronic manual on CD-ROM, license key on USB stick, Class A

###### **S7 OPC Redundancy V12 for PROFIBUS**

for 64-bit Windows 2008 server R2; English/German

- Single License for one installation

**6GK1706-5CW12-0AA0**

###### **Software Update Service**

For 1 year, with automatic extension; requirement: Current software version

**6GK1706-5CW00-3AL0**

Ordering data	Article No.	Article No.
<b>HARDNET-PB DP Development Kit</b> Software HARDNET-PB DP Development Kit for integration in other operating system environments  <i>For CP 5603, CP 5613 A2, CP 5614 A2, CP 5613 A3, CP 5614 A3, CP 5623, CP 5624</i>	see <a href="http://www.siemens.com/simatic-net/dk5613">http://www.siemens.com/simatic-net/dk5613</a>	
<b>Software upgrade</b> <i>For CO 5603, CO 5613 A, CO 5614 A, CO 5613 A3, CP 5614 A3, CP 5623, CP 5624 to Edition 2008 or V12</i>	<b>6GK1561-3AA01-3AE0</b>	
<b>HARDNET-PB DP</b> Software for DP, incl. PG and FDL protocol, OPC server and configuration tool; runtime software, software and electronic manual on DVD-ROM, license key on USB flash drive, Class A  <i>For CP 5603, CP 5613 A2, CP 5614 A2, CP 5613 A3, CP 5614 A3, CP 5623, CP 5624</i>		
<b>HARDNET-PB DP V12</b> for 32/64-bit: Windows 7 Professional/Ultimate for 32/64-bit: Windows 8 Pro for 64-bit: Windows 2008 Server R2 for 64-bit: Windows 2012 Server German/English • Single License for one installation	<b>6GK1713-5DB12-0AA0</b>	
<b>Software Update Service</b> for 1 year with automatic extension Requirement: current software version	<b>6GK1713-5DB00-3AL0</b>	
<b>Upgrade</b> • from Edition 2006 or 2007 to DP-5613 Edition 2008 or HARDNET-PB DP V12 • from V6.0, V6.1, V6.2 or V6.3 to DP-5613 Edition 2008 or HARDNET-PB DP V12	<b>6GK1713-5DB00-3AE0</b>  <b>6GK1713-5DB00-3AE1</b>	
		<b>HARDNET-PB S7</b> Software for S7 communication incl. PG and FDL protocol, OPC server and configuration tool; runtime software, software and electronic manual on DVD-ROM, license key on USB flash drive, Class A  <i>for CP 5603, CP 5613 A2, CP 5614 A2, CP 5613 A3, CP 5614 A3, CP 5623, CP 5624</i>
		<b>HARDNET-PB S7 V12</b> for 32/64-bit: Windows 7 Professional/Ultimate for 32/64-bit: Windows 8 Pro for 64-bit: Windows 2008 Server R2 for 64-bit: Windows 2012 Server German/English • Single License for one installation
		<b>6GK1713-5CB12-0AA0</b>
		<b>Software Update Service</b> for 1 year with automatic extension Requirement: current software version
		<b>6GK1713-5CB00-3AL0</b>
		<b>Upgrade</b> • from Edition 2006 or 2007 to S7-5613 Edition 2008 or HARDNET-PB S7 V12 • from V6.0, V6.1, V6.2 or V6.3 to S7-5613 Edition 2008 or HARDNET-PB S7 V12
		<b>6GK1713-5CB00-3AE0</b>  <b>6GK1713-5CB00-3AE1</b>
		<b>SOFTNET-PB S7</b> Software for S7 communication, including FDL protocol with OPC server and configuration tool, runtime software, software and electronic manual on DVD-ROM, license key on USB flash drive, Class A  <i>for CP 5612 (Win 7 or higher), CP 5622 (Win 7 or higher), CP 5711</i>
		<b>SOFTNET-PB S7 V12</b> for 32/64-bit: Windows 7 Professional/Ultimate for 32/64-bit: Windows 8 Pro for 64-bit: Windows 2008 Server R2 for 64-bit: Windows 2012 Server German/English • Single License for one installation
		<b>6GK1704-5CW12-0AA0</b>
		<b>Software Update Service</b> For 1 year with automatic extension; requirement: current software version
		<b>6GK1704-5CW00-3AL0</b>
		<b>Upgrade</b> • from Edition 2006 to SOFTNET-S7 Edition 2008 or V12 • from V6.0, V6.1, V6.2 or V6.3 to SOFTNET-S7 Edition 2008 or V12
		<b>6GK1704-5CW00-3AE0</b>  <b>6GK1704-5CW00-3AE1</b>

**PROFIBUS**

## Communication for PC-based systems

## Software

**Ordering data****Article No.****Article No.****SOFTNET-PB DP**

Software for DP protocol (Master Class 1 and 2), including FDL protocol with OPC server and configuration tool; runtime software, software and electronic manual on DVD-ROM, license key on USB flash drive

for CP 5612 (Win 7 or higher), CP 5622 (Win 7 or higher), CP 5711

**SOFTNET-PB DP V12**

for 32/64-bit:  
Windows 7 Professional/Ultimate  
for 32/64-bit: Windows 8 Pro  
for 64-bit: Windows 2008 Server R2  
for 64-bit: Windows 2012 Server  
German/English

- Single License for one installation

**Software Update Service**

for 1 year with automatic extension  
Requirement: current software version

**Upgrade**

- from Edition 2006 to SOFTNET-DP Edition 2008 or V12
- from V6.0, V6.1, V6.2 or V6.3 to SOFTNET-DP Edition 2008 or V12

**6GK1704-5DW12-0AA0****6GK1704-5DW00-3AL0****6GK1704-5DW00-3AE0****6GK1704-5DW00-3AE1****SOFTNET-PB DP slave**

Software for DP slave, with OPC server and configuration tool, Single License for one installation, runtime software, software and electronic manual on DVD-ROM, license key on USB flash drive, Class A

for CP 5612 (Win 7 or higher), CP 5622 (Win 7 or higher), CP 5711

**SOFTNET-PB DP slave V12**

for 32/64-bit:  
Windows 7 Professional/Ultimate  
for 32/64-bit: Windows 8 Pro  
for 64-bit: Windows 2008 Server R2  
for 64-bit: Windows 2012 Server  
German/English

- Single License for one installation

**Software Update Service**

for 1 year with automatic extension  
Requirement: current software version

**Upgrade**

- from Edition 2006 to SOFTNET-DP Slave Edition 2008 or V12
- from V6.0, V6.1, V6.2 or V6.3 to SOFTNET-DP Slave Edition 2008 or V12

**6GK1704-5SW12-0AA0****6GK1704-5SW00-3AL0****6GK1704-5SW00-3AE0****6GK1704-5SW00-3AE1**Note:

The Windows XP software version is still available for older CPs; see the Industry Mall: <http://www.siemens.com/industrymall>

### Overview

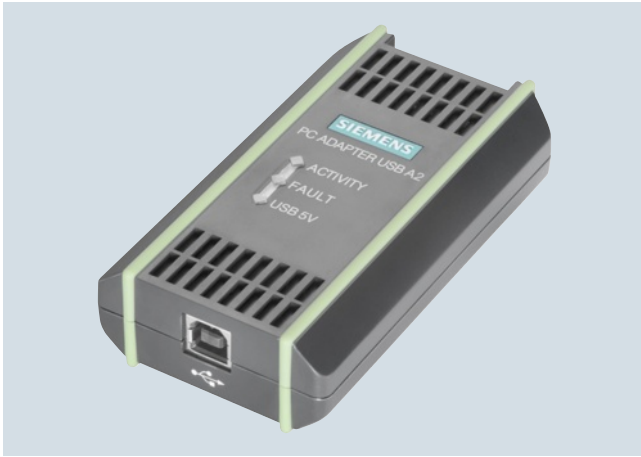

DP-M	DP-S	FMS	PG/OP	S7/S5	
			●		

USB adapter for the connection of PCs/Notebooks and SIMATIC PG/PC to the SIMATIC S7 automation system via USB interface.

- For connection to USB 1.1, 2.0 and 3.0 interfaces
- Power supply from the USB interface
- PROFIBUS connection with up to 12 Mbit/s
- Support for routing
- Automatic transmission rate and profile search
- Can be used as of Windows XP SP2
- As of Windows 7, can also be used with 64-bit system
- Scope of delivery:
  - PC adapter USB A2
  - CD with drivers for the PC adapter USB A2
  - USB cable
  - MPI cable 0.3 m

### Benefits

get **Designed for Industry**

- Portability and flexibility; Connection for portable PCs, e.g. for diagnostics and commissioning
- Easy installation and commissioning due to plug & play technology
- Power supply via the USB interface

### Application

The PC adapter USB A2 enables the connection of SIMATIC PG/PC and PCs with USB interface to PROFIBUS and to the multi-point interface (MPI) of SIMATIC S7.

It can be used with Windows XP SP2 and higher and supports all MPI and PROFIBUS baud rates.

### Design

- USB port
- Adapter with 9-pin sub-D socket for connection to PROFIBUS or MPI

### Function

The PC adapter USB A2 can be operated both on a USB V1.1 port and on a USB V2.0 or USB V3.0 port. It offers users the ability to perform both programming device and PC/OP functions via PROFIBUS and the multi-point interface (MPI). Only one USB A2 PC adapter can be operated per PG/PC/OP.

The USB A2 PC adapter is powered directly via the USB interface of the PC system.

The following software packages support the USB A2 PC adapter:

- STEP 7
- TIA Portal
- NCM PC
- SIMATIC PDM
- Drive ES

### Diagnostics

Three LEDs are available for diagnosing the USB A2 PC adapter. These LEDs allow quick detection of various operating states and signal states.

**PROFIBUS**

## Communication for PC-based systems

**PC adapter USB A2****Technical specifications**

Article No.	6GK1571-0BA00-0AA0
Product-type designation	PC adapter USB A2
<b>Transmission rate</b>	
Transmission rate at interface 1 in accordance with PROFIBUS	9.6 kbit/s ... 12 Mbit/s
<b>Interfaces</b>	
Number of electrical connections at interface 1 in accordance with PROFIBUS	1
Number of interfaces according to USB	1
Design of electrical connection	
• at interface 1 in accordance with PROFIBUS	9-pin Sub-D socket (RS 485)
• of the USB interface	Standard-B socket
<b>Supply voltage, current consumption, power loss</b>	
Type of supply voltage	DC
Type of power supply optional external supply	No
Supply voltage	
• from USB	5 V
• note	Supply direct from USB
Relative symmetrical tolerance at 5 V with DC	5 %
Consumed current from USB	0.2 A
Resistive loss	1 W

Article No.	6GK1571-0BA00-0AA0
Product-type designation	PC adapter USB A2
<b>Permitted ambient conditions</b>	
Ambient temperature	
• during operating	0 ... 60 °C
• during storage	-40 ... +70 °C
• during transport	-40 ... +70 °C
Relative humidity at 30 °C during the operating phase maximum	95 %
Protection class IP	IP20
<b>Design, dimensions and weight</b>	
Module format	USB V2.0 adapter
Width	58 mm
Height	26 mm
Depth	105 mm
Net weight	365 g
Mounting type 35 mm DIN rail mounting	No
<b>Product properties, functions, components general</b>	
Number of plug-in cards in the same design can be plugged in per PC station	1
Number of modules note	-
<b>Product functions Diagnosis</b>	
Product function Port diagnostics	Yes
<b>Standards, specifications, approvals</b>	
Standard	
• for EMC	2004/108/EC
• for safety of CSA and UL	cULus, UL 60950-1, CSA22.2
• for emitted interference	EN 61000-6-3, EN 61000-6-4
• for interference immunity	EN 61000-6-1, EN 61000-6-2
Verification of suitability	
• CE mark	Yes
• C-Tick	Yes
<b>Accessories</b>	
Accessories	-

**Ordering data****Article No.****PC adapter USB A2****6GK1571-0BA00-0AA0**

for connecting a PG/PC or Notebook to PROFIBUS or MPI; USB cable included in scope of delivery



### Overview

The SIMATIC Basic Panel, Comfort Panel and Mobile Panel offer HMI functionality for the control systems:

- SIMATIC S7
- Non-Siemens controllers:
  - Allen Bradley
  - Mitsubishi
  - Modicon
  - Omron

For more detailed information, refer to the WinCC (TIA Portal) user manual, the "Windows-based systems communication" manual, or the WinCC (TIA Portal) online help.

OPC communication and HTTP communication are offered for all Panels with an integrated Ethernet interface. Both OPC and HTTP communication can be used in parallel with the process links to SIMATIC S7 or non-Siemens PLCs.

#### Note:

Interface options for HMI devices: See the individual device descriptions.

#### OPC communication

OPC Data Access is an open standard for exchanging both local and remote variables between various applications via Industrial Ethernet.

#### HTTP communication for variable exchange between SIMATIC HMI systems

Communication based on HTTP message frames enables variables to be exchanged between SIMATIC HMI systems.

Communication standard	SIMATIC HMI			
Version	Comfort Panel	Mobile Panel 177 PN MP 177	Mobile Panel 277	WinCC Runtime Advanced
<i>OPC Data Access V2.05a + OPC UA Data Access V1.01 + OPC Data Access XML V1.00</i>				
OPC DA client (COM/DCOM)	–	–	–	•
OPC DA server (COM/DCOM)	–	–	–	•
OPC UA DA client	•	–	–	•
OPC UA DA server	•	–	–	–
<i>HTTP communication for variable exchange between SIMATIC HMI systems</i>				
HTTP client	•	•	•	•
HTTP server	•	•	•	•

- System interface possible
- System interface not possible

## PROFIBUS

### System interfaces for SIMATIC HMI

### System interfaces with WinCC (TIA Portal)

#### SIMATIC S7

#### Overview

The following types of interface are differentiated in respect of the link between the SIMATIC Panels and SIMATIC S7 controllers:

- **PROFINET interface:**  
Coupling of SIMATIC Panel to SIMATIC S7 controllers via Industrial Ethernet TCP/IP using the integrated PROFINET interface of the CPU or, alternatively, a PROFINET interface module.
- **MPI/PROFIBUS interface:**  
Coupling of SIMATIC Panel to SIMATIC S7 controllers via MPI/PROFIBUS using the integrated MPI/PROFIBUS interface of the CPU or the integrated PPI interface of the CPU in the case of S7-200 or, alternatively, a PROFIBUS interface module in the case of S7-1200, S7-1500, S7-300 and S7-400.
- **PPI interface:**  
Coupling of SIMATIC Panel to SIMATIC S7-200 via PPI network using the integrated PPI interface of the CPU

The maximum possible number of S7 connections of one CPU is determined by its performance capacity (see Catalog ST 70); from the point of view of SIMATIC Panel, the following restrictions apply:

- Basic Panel, Comfort Panel 4", Mobile Panel 177: max. 4 connections
- Comfort Panel 7" - 22": max. 8 connections
- Mobile Panel 277: max. 6 connections
- PC with WinCC Runtime Advanced: max. 8 connections

#### **PPI interface**

The PPI interface is a point-to-point connection between a SIMATIC Panel (PPI master) or alternatively a PG (PPI master) and an S7-200 (PPI slave).

#### **MPI/PROFIBUS interface or PROFINET interface**

The corresponding multipoint-enabled communication interfaces of SIMATIC Panels and SIMATIC S7 are used. The following are possible:

- Interface between one or more SIMATIC Panels (MPI master) and one or more S7-1200/S7-1500/S7-300/S7-400s or WinAC (MPI master) (possible network topology: MPI/PROFIBUS or Industrial Ethernet, TCP/IP)
- Interface between one or a number of SIMATIC Panels (MPI master) and one or a number of S7-200s (MPI slave)<sup>1)</sup> (possible network topology: PPI, MPI/PROFIBUS)

Unlike PPI connections, MPI connections are static connections that are set up during booting and then monitored.

The original format of a master/master link has been joined by a master/slave link, which has enabled integration of the S7-200 (except CPU 212).<sup>1)</sup>

In principle this type of information exchange between SIMATIC Panels and SIMATIC S7 is independent of the network used, PPI, MPI/PROFIBUS or Industrial Ethernet: SIMATIC Panels are S7 clients and SIMATIC S7 CPUs are S7 servers.

<sup>1)</sup> With regard to restricted baud transmission rates for S7-200, see Catalog ST 70.

**Overview** (continued)

Controller	SIMATIC HMI				
	Basic Panel	Comfort Panel	Mobile Panel 177 DP <sup>1)</sup> Mobile Panel 177 PN <sup>1)</sup>	Mobile Panel 277 <sup>1)</sup>	WinCC Runtime Advanced
<b>Target hardware (PROTOCOL)</b> (physics)					
<i>SIMATIC S7-200</i> <sup>2)</sup>					
over Ethernet (TCP/IP) (MPI protocol) an max. 4 x S7-200	• <sup>3)</sup>	•	• <sup>3)</sup>	•	•
over MPI or PROFIBUS network (MPI-Protokoll) an max. 4 x S7-200	• <sup>4)</sup>	• <sup>6)</sup>	• <sup>4) 6)</sup>	• <sup>6)</sup>	• <sup>5) 6)</sup>
over PPI network (MPI protocol) an max. 4 x S7-200	• <sup>4)</sup>	–	•	–	–
over PPI network (PPI protocol) an max. 1 x S7-200	–	• <sup>7)</sup>	• <sup>7)</sup>	• <sup>7)</sup>	• <sup>5) 7)</sup>

- System interface possible
- System interface not possible

<sup>1)</sup> Mobile Panel connection via special connecting cable and junction box (see Mobile Panel), see Manual for cable layout

<sup>2)</sup> Controllers can be combined as desired

<sup>3)</sup> Basic Panel PN and Mobile Panel 177 PN only

<sup>4)</sup> Not Basic Panel PN or Mobile Panel 177 PN

<sup>5)</sup> Connection via integrated MPI/PROFIBUS interface; in the case of a standard PC, a communications processor (CP) is to be used (e.g. CP 5611 A2)

<sup>6)</sup> Only on passive S7-200; OP 77B auch an aktive S7-200

<sup>7)</sup> Can be interfaced via PPI to max. 1 x S7-200 (PPI); network operation (parallel PG, etc.) is possible

**Note:**

Detailed information regarding cable layout can be found in the online help for WinCC.

## PROFIBUS

System interfaces for SIMATIC HMI

System interfaces with WinCC (TIA Portal)

### SIMATIC WinCC (TIA Portal) Runtime

#### Overview

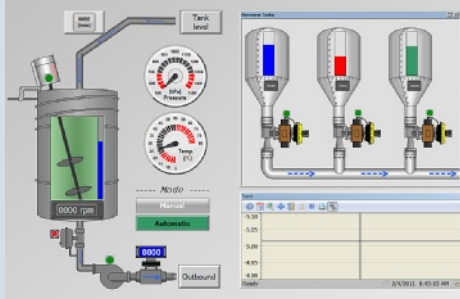

#### **SIMATIC WinCC Runtime Advanced visualization software**

- PC-based HMI solution for single-user systems directly at the machine
- Basic package for visualization, reporting and logging, user administration, can be expanded flexibly with VB scripts
- Basic package expandable by means of option packages
- Can be integrated into automation solutions based on TCP/IP networks
- Expanded service concepts with remote operation, diagnostics and administration over the intranet and Internet in combination with email communication

#### **SIMATIC WinCC Runtime Professional visualization software**

- PC-based operator control and monitoring system for visualization and operator control of processes, production flows, machines and plants in all sectors – from the simple single-user station through to distributed multi-user systems and cross-location solutions with web clients. WinCC Runtime Professional is the information hub for corporation-wide vertical integration.
- Industry-standard functions for signaling and acknowledging events, archiving of messages and measured values, logging of all process and configuration data, user administration, can be expanded flexibly with VB and C scripts
- Basic package expandable by means of option packages
- Also included are APIs for the Runtime to utilize the open programming interfaces

**Overview****Communication – SIMATIC WinCC Runtime Advanced**

WinCC Advanced is an open visualization system and offers the option of connecting the most diverse control systems.

Number of connectable controllers

WinCC Advanced permits the parallel coupling of up to 8 controllers.

Connection to third-party controllers

The following "Coupling overview" table lists third-party protocols and controllers which are directly supported by WinCC Advanced. Generally it is also possible to connect third-party controllers via OPC (OLE for Process Control).

Current notes and information about OPC servers from many different suppliers can be found at: <http://www.opcfoundation.org/>

WinCC Advanced supports the standards:

- OPC Data Access 2.05a
- OPC UA Data Access 1.01
- OPC XML Data Access 1.00 (client via DCOM/XML gateway)

**Coupling overview for WinCC Runtime Advanced**

Protocol	Description	PC interface
<i>SIMATIC S7</i>		
<b>MPI, PROFIBUS (S7 communication)</b>	Channel for communication via MPI, PROFIBUS with max. 8 x SIMATIC S7 controllers S7-1200 with CM 1243-5 (DP master), S7-1500 S7-300, S7-400, S7-200 (passive S7-200 only)	CP 5611 A2 CP 5612 CP 5621 CP 5622 CP 5711 CP 5613 A2 CP 5613 A3 CP 5623
<b>PPI (PPI protocol)</b>	Channel for communication via PPI with 1 x SIMATIC S7-200 (network operation, e.g. parallel PG possible)	CP 5611 A2 CP 5612 CP 5621 CP 5622 CP 5711 CP 5613 A2 CP 5613 A3 CP 5623
<b>Software interface (S7 communication)</b>	Channel for communication via software interface with WinAC	
<i>SINUMERIK <sup>1)</sup></i>		
<b>MPI (S7 communication)</b>	Channel for communication via MPI with SINUMERIK 840D sl	CP 5611 A2 CP 5612 CP 5621 CP 5622 CP 5711 CP 5613 A2 CP 5613 A3 CP 5623

<sup>1)</sup> "SINUMERIK Operate WinCC RT Advanced" license required; for further information, see NC 60 Catalog.

## PROFIBUS

### System interfaces for SIMATIC HMI

### System interfaces with WinCC (TIA Portal)

#### WinCC Runtime Communication

##### Overview (continued)

##### Communication – SIMATIC WinCC Runtime Professional

WinCC Professional is an open process visualization system and offers the option of connecting the most diverse control systems.

##### Released communication software

Only communication software with the listed (or higher) product versions should be used. Corresponding SIMATIC NET upgrades are available for the upgrading of older versions.

##### Number of connectable controllers

With CP 1613/CP 1623, a maximum of 64 S7 controllers can be connected via Industrial Ethernet; with CP 5612/CP 5622 a maximum of 8, and with CP 5613 A3 a maximum of 44 S7 controllers can be connected via PROFIBUS. With approx. 10 or more controllers, the use of Industrial Ethernet is recommended.

##### Client-server communication

Communication between the clients and the server is implemented using the TCP/IP protocol. The construction of a separate PC-LAN is recommended. For small projects with correspondingly small message frame advent, a SIMATIC NET Industrial Ethernet can be used for both process communication (WinCC/server ↔ PLC) and for PC-PC communication (WinCC/client ↔ WinCC/server)

##### Connection to third-party controllers

The following "Coupling overview" table lists third-party protocols and controllers which are directly supported by WinCC Professional. Generally it is also possible to connect third-party controllers via OPC (OLE for Process Control).

Current notes and information about OPC servers from many different suppliers can be found at: <http://www.opcfoundation.org/>

WinCC Professional supports the standards:

- OPC Data Access 2.05a
- OPC Data Access 3.00
- OPC UA Data Access 1.01
- OPC XML Data Access 1.00
- OPC HDA 1.20
- OPC A&E 1.10

##### Coupling overview for WinCC Runtime Professional

Protocol	Description	PC interface
<b>SIMATIC S7</b>		
<b>SIMATIC S7</b>	Protocol Suite with channel units for communication with SIMATIC S7 via <ul style="list-style-type: none"> <li>• Ethernet TCP/IP (S7 communication) to S7-1200, S7-1500, S7-300, S7-400</li> <li>• MPI, PROFIBUS (S7 communication) to S7-1200 with CM 1243-5 (DP master), S7-1500, S7-300, S7-400</li> <li>• Software interface (S7 communication) to Win AC</li> </ul>	CP 5612 CP 5622 CP 5711 CP 5613 A3 CP 5623

##### Communications examples

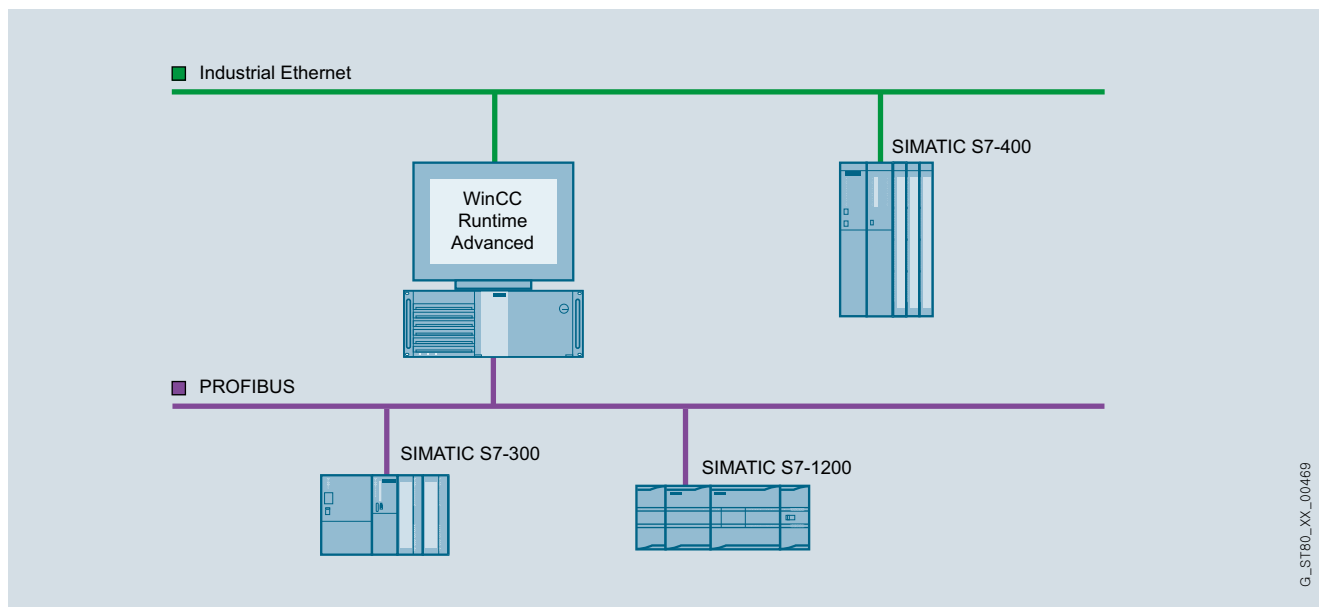

WinCC Runtime Advanced single-user system

G\_ST80\_XX\_00469

#### Overview (continued)

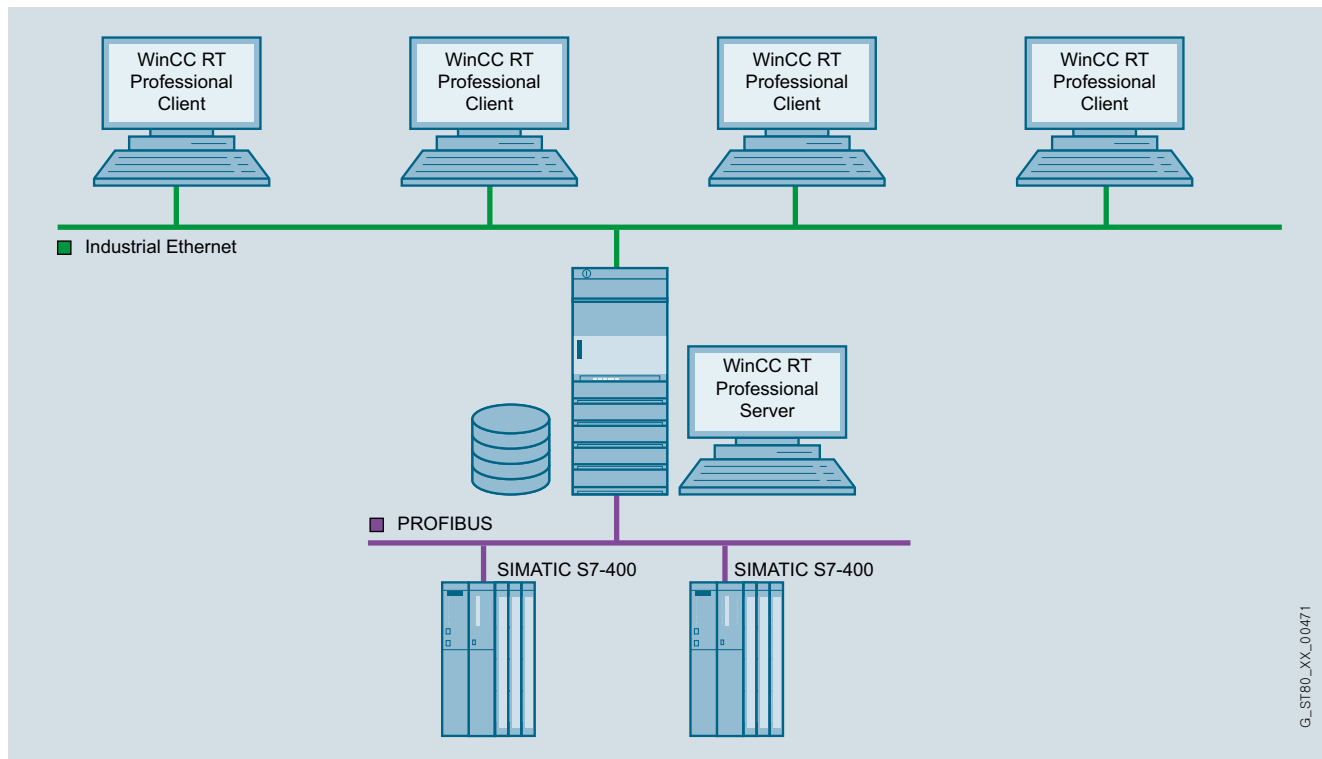

G\_STB0\_XX\_00471

WinCC Runtime Professional multi-user system with operable Server

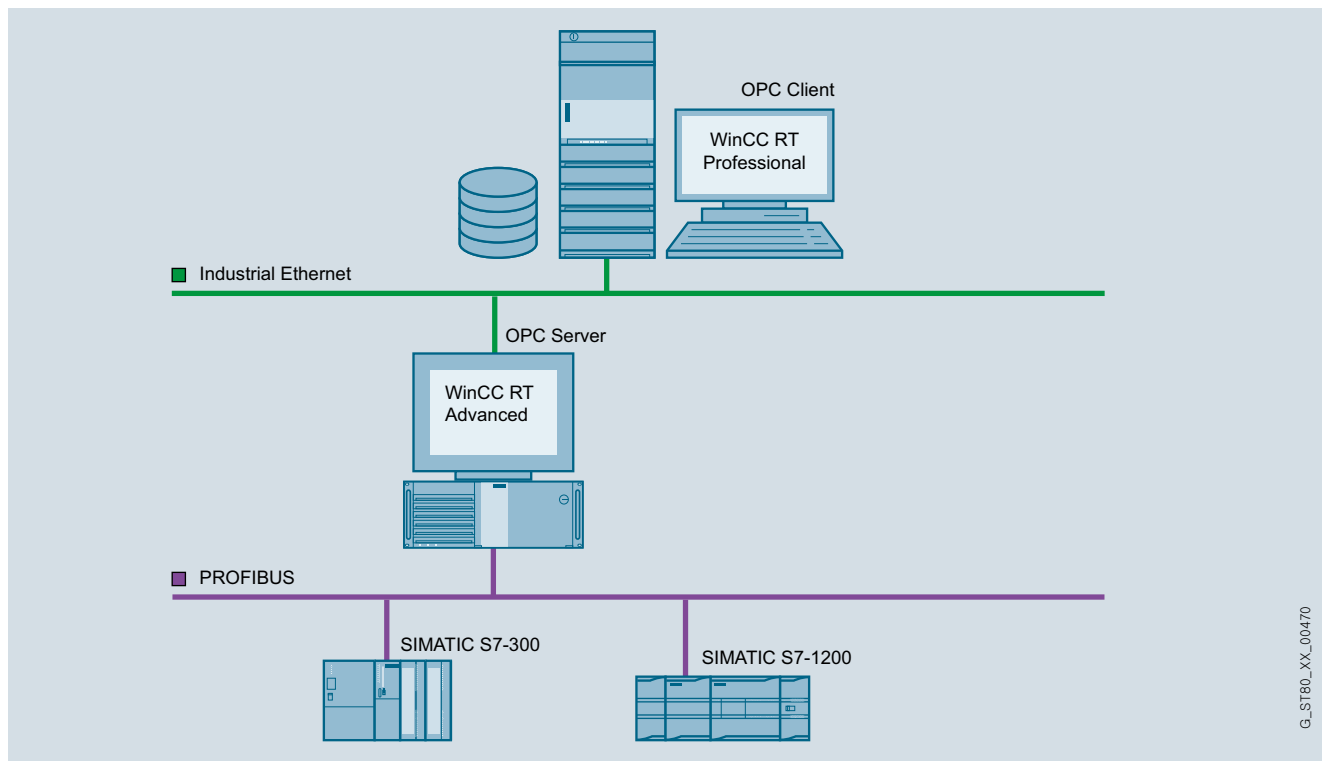

G\_STB0\_XX\_00470

OPC coupling

## PROFIBUS

### System interfaces for SIMATIC HMI System interfaces with WinCC flexible

#### SIMATIC WinCC flexible RT

#### Overview

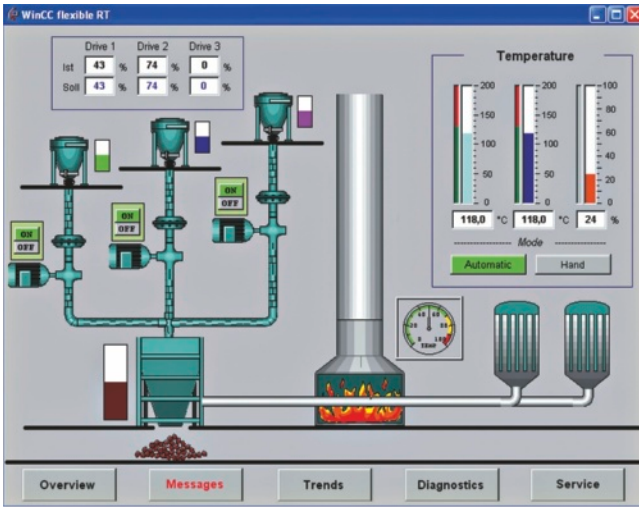

PC-based visualization software for single-user systems directly at the machine.

- Runs under Windows XP Professional and Windows 7 Professional, Ultimate, Enterprise
- Current version: SIMATIC WinCC flexible 2008 SP3 Runtime

SIMATIC WinCC flexible Runtime is configured with the SIMATIC WinCC flexible Advanced configuration software.

#### Benefits

- Optimum price/performance ratio thanks to individually scalable system functionality
- Functions for all visualization tasks: Operator functions, graphical and trend displays, signaling system, log system, archiving (option), recipe management (option), Audit Trail (option), process fault diagnostics (option)
- Flexible runtime functionality thanks to Visual Basic scripts
- Innovative service concepts with remote operation, diagnostics and administration via intranet and Internet as well as e-mail communication to increase availability (option)
- Support for simple distributed automation solutions based on TCP/IP networks at the machine level (option)

#### Application

SIMATIC WinCC flexible Runtime is the high-performance visualization software for simple visualization tasks at machine level. It can be used as a single-user solution for all automation applications in factory automation, process automation and building services automation.

SIMATIC WinCC flexible Runtime can be used in combination with the following operator panels:

- SIMATIC Panel PCs
  - PC IL 70/77
  - Microbox 420
  - Panel PC 477
  - Panel PC 577
  - Panel PC 670/677
  - Panel PC 870/877
- SIMOTION Panel PCs
  - P012, P015
  - PCR, PCR-Touch
- SINUMERIK Panel PCs
  - HT8; OP08T
  - OP010, OP012, OP015
  - TP012, TP015, OP015A
- Standard PCs with resolutions (W x H in pixels) of:
  - 4:3 format: 640 x 480, 800 x 600, 1 024 x 768, 1 280 x 1 024, 1 600 x 1 200
  - Widescreen format: 800 x 480, 1 280 x 800, 1 366 x 768, 1 440 x 900, 1 680 x 1 050, 1 920 x 1 080, 1 920 x 1 200, 1 980 x 1 080

#### Design

SIMATIC WinCC flexible Runtime is available as a software package with 128, 512, 2048 or 4096 PowerTags. The term PowerTags is used exclusively to identify process variables and range pointers that have a process link to the controller. Variables without process link, constant limit values of variables, and messages (up to 4000 bit-triggered messages) are also available for additional system performance.

The range of functions of WinCC flexible Runtime includes the centralized HMI components for visualizing and reporting, and it can be expanded to suit requirements and costs by using optional packages.

SIMATIC WinCC flexible Runtime is configured with the SIMATIC WinCC flexible Advanced configuration software.



## Function

### Visualization via Windows-compliant operator interface

made up of parameterizable screen objects and image blocks created on a project-specific basis:

- Numeric and alphanumeric input/output fields
- Static text and graphic display plus vector graphics
- Dynamizable graphics from HMI symbol library
- Bar graph, trend curve graph with scroll and zoom function as well as read line
- Signal-specific text and graphic lists
- Buttons and switches for operator-process communication
- Editing fields for process values (signals)
- Analog display, slider as example for further screen objects
- Project-specific image blocks created from system basic objects
- Graphic displays for various standard graphic formats, e.g. bitmaps, .jpg, .wmf

### Alarms and messages

- Discrete alarms and analog alarms as well as event-driven Alarm-S/Alarm-D message procedure with SIMATIC S7 and SIMOTION
- Freely-definable message classes for definition of acknowledgment response and display of message events

### Logging of alarms and process values <sup>1)</sup>

- Archiving in files (e.g. CSV or TXT file) and Microsoft SQL databases
- Online evaluation of process value archives and alarm logs
- Evaluation of process value archives and alarm logs using standard Microsoft tools such as Excel

### Recipes <sup>1)</sup>

- Generation of data records for machine or production data
- Display or entry of data records via a configurable screen object or via process images when distributed within the project
- Transmission of data records from or to the PLC
- Import/export for data records from/to CSV files

### Documentation of process data, alarm events and recipes

- Time- or event-driven report output
- User-definable layout

### Flexible expansion of system function

- thanks to Visual Basic Script

### Language support for multilingual projects

- Up to 16 online languages (incl. Asian and Cyrillic)
- Language-dependent texts and graphics
- Language selection during runtime

### User-oriented access protection according to requirements of regulated sectors

- Authentication with user ID and password
- User-group-specific rights
- Central system-wide user administration based on SIMATIC Logon <sup>1)</sup>
- Monitoring of changes by operators in runtime operation <sup>1)</sup>
- Recording of operator actions in an Audit Trail <sup>1)</sup>

### PLC link for a wide variety of PLCs on-board

- Simultaneous connection using several protocols: OPC Client or SIMATIC HMI HTTP protocol are additive, i.e. can be used in conjunction with other PLC links
- Communication via native drivers and standard OPC channel

### Open communication between HMI systems and with higher-level systems <sup>1)</sup>

- OPC server
- Sm@rtAccess for communication between HMI systems based on Ethernet networks, or via the intranet/Internet:
- Read and write access to variables; WinCC flexible Runtime or SIMATIC Panels make data (variables) available to other SIMATIC HMI systems or Office applications.
- A SIMATIC HMI system can be used to control or monitor another system remotely; entry level for client/server configurations for distributed operator stations or for solutions with headend or control room.

### Sm@rtService for remote control, diagnostics and administration via intranet and Internet <sup>1)</sup>

- Display and control of process images on remote PC or Panel
- Sending of e-mails on demand or event-driven
- System diagnostics visualized via device-specific HTML pages

<sup>1)</sup> Option for SIMATIC WinCC flexible Runtime; runtime licenses must be purchased separately. For further information, refer to "WinCC flexible options".

System requirements	WinCC flexible Runtime
<b>Operating system</b>	Windows XP Professional SP3 (32 bit) Windows XP Embedded <sup>1)</sup> Windows 7 Professional / Ultimate / Enterprise (32 bit and 64 bit)
<b>Processor</b> <sup>4)</sup>	
• Minimum	Windows XP: 300 MHz Windows 7: 1 GHz
• Recommended	Windows XP: ≥ Pentium III, 500 MHz Windows 7: ≥ 1 GHz
<b>Graphics</b>	
• Minimum	SVGA
• Resolution	640 x 480 to 1 600 x 1 200 or 800 x 480 to 1 980 x 1 080
<b>RAM</b> <sup>2)</sup>	
• Minimum	Windows XP: 128 MB Windows 7: 1 GB
• Recommended	Windows XP: ≥ 512 MB Windows 7: ≥ 1 GB
<b>Hard disk (free memory space)</b> <sup>3)</sup>	≥ 250 MB

<sup>1)</sup> Only for enabled platforms (e.g. Panel PC 477). You can get information from your Siemens contact.

<sup>2)</sup> RAM requirements are determined primarily by the size of the graphics used.

<sup>3)</sup> Without taking archives into account. In addition to the space needed by WinCC flexible, Windows also requires space on the hard disk; e.g., for the swap file. The following formula has proven itself in the past: The size of the swap file = 3 x the size of the RAM. For further information, refer to your Windows documentation

<sup>4)</sup> More powerful systems (Pentium 4 and higher) may be required in order to use options

**PROFIBUS****System interfaces for SIMATIC HMI  
System interfaces with WinCC flexible****SIMATIC WinCC flexible RT****Integration**

SIMATIC WinCC flexible Runtime supports linking to:

Protocol	PC interfaces
<b>SIMATIC S7 via PPI</b>	
S7-200	CP 5611 A2 <sup>2)</sup> CP 5612 CP 5621 <sup>1)</sup> CP 5622 CP 5613 A2 CP 5614 A2 CP 5623 CP 5624 CP 5711 PC/PPI adapter <sup>3)</sup>
<b>SIMATIC S7 via MPI</b>	
S7-200 (except CPU 212) <sup>4)</sup>	CP 5611 A2 <sup>2)</sup> CP 5612
S7-300	CP 5621 <sup>1)</sup> CP 5622
S7-400	CP 5613 A2 CP 5614 A2
WinAC Basis (V3.0 and higher)	CP 5623
WinAC RTX	CP 5624 CP 5711 PC adapter USB A2 <sup>6)</sup> Teleservice V6.1
<b>SIMATIC S7 via PROFIBUS DP <sup>5)</sup></b>	
S7-215 <sup>4)</sup>	CP 5611 A2 <sup>2)</sup> CP 5612
S7-300 CPUs with integr. PROFIBUS interface	CP 5621 <sup>1)</sup> CP 5622
S7-300 with CP 342-5	CP 5613 A2 CP 5614 A2
S7-400 CPUs with integr. PROFIBUS interface	CP 5623
S7-400 with CP 443-5 or IM 467	CP 5624 CP 5711
WinAC Basis (V3.0 and higher)	
WinAC RTX	
<b>SIMATIC S7 via integrated interface</b>	
WinAC Basis (V2.0 and higher)	Internal system interface
WinAC RTX	
<b>SIMOTION <sup>8)</sup></b>	
<b>SINUMERIK <sup>9)</sup></b>	

- <sup>1)</sup> WinCC flexible Runtime is passive (DP slave); the function block required for the link is included in the scope of delivery of WinCC flexible
- <sup>2)</sup> For Microbox 427 and Panel PC 477/577/677 via internal MPI/DP interface
- <sup>3)</sup> Only point-to-point to S7-200; no configuration download, operating systems: Windows XP; Article number: 6ES7901-3CB30-0AX0
- <sup>4)</sup> Constraint with regard to baud rate for S7-200; see Catalog ST 70
- <sup>5)</sup> WinCC flexible RT is active; communication with S7 functions
- <sup>6)</sup> Only point-to-point to S7-300/-400; no configuration download, operating systems: Windows 2000/XP and higher; article number: 6GK1571-0BA00-0AA0 (USB)
- <sup>7)</sup> For Microbox 427 and Panel PC 477/577/677/877 via internal Ethernet interface
- <sup>8)</sup> For further information, see Catalog PM 10
- <sup>9)</sup> "SINUMERIK HMI copy license OA" option required; for further information, see Catalog NC 60

**Application note**

In parallel with each and every PLC link, WinCC flexible Runtime supports the use of the OPC Client channel; this enables, for example, connection to an SNMP OPC Server for the purpose of visualizing the data stored there. The SNMP OPC Server provides a means of monitoring network components of any type (e.g. switches) which support the SNMP protocol. For further information, see Catalog IK PI.

Note:

For further information, see "HMI devices/System interfaces"

#### Integration (continued)

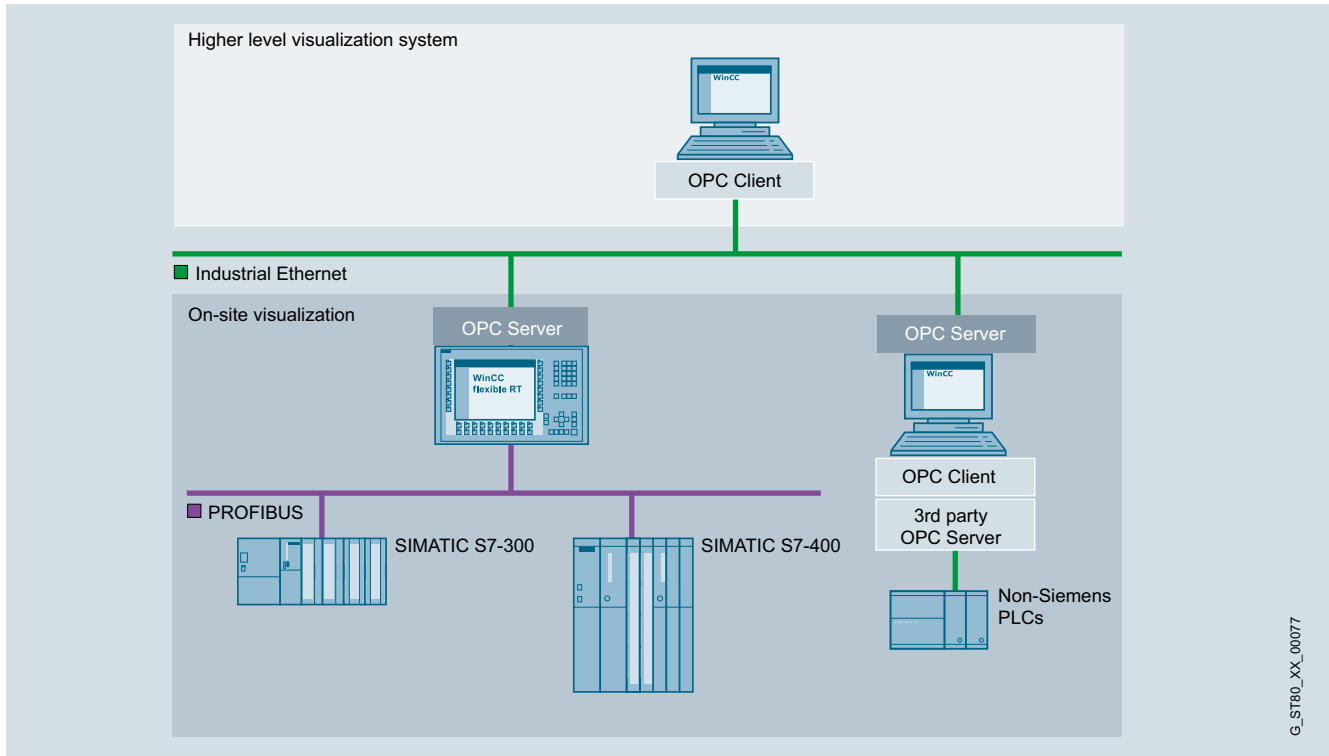

SIMATIC WinCC flexible Runtime application example

#### Technical specifications

Type	SIMATIC WinCC flexible Runtime
	The specifications are maximum values
<b>Displays</b>	500
• Fields per screen	400
• Variables per screen	400
• Static text	30 000
• Graphics objects	2 000
• Complex objects per display (e.g. bars)	40
• Trends	800
• Graphics lists <sup>1)</sup>	500
• Text lists <sup>1)</sup>	500
• Number of entries in symbol tables	3 500
<b>Variables</b>	4 096 <sup>3)</sup>
<b>Messages bit-triggered / analog</b>	4 000 / 500
• Message text (number of characters)	80
• Number of process values per message	8
• Size of message buffer	1 024
• Pending message events	500
<b>Archives <sup>4)</sup></b>	100
• Archivable data	Process data, messages
• Max. number of entries per archive (incl. all archive segments)	500 000
• Archive types	Short-term archive, sequence archive (max. 400 per archive)
• Data storage format	CSV (Comma Separated Variable), RDB (Runtime Data Base), interface to MS SQL database
<b>Recipes <sup>4)</sup></b>	1 000
• Elements per recipe	2 000 <sup>3)</sup>
• Data records per recipe	5 000 <sup>2)</sup>

Type	SIMATIC WinCC flexible Runtime
	The specifications are maximum values
<b>Password protection</b>	
• User rights	32
• Number of user groups	50
<b>Visual Basic scripts</b>	200
<b>Online languages, max.</b>	16
<b>Communication</b>	
SIMATIC S7 MPI interface/ PROFIBUS DP interface	
• Number of connectable stations, max.	Depending on the scope of the configuration (communication) from the point of view of WinCC flexible Runtime, as many as 8 connections are possible
SIMATIC S7 PPI interface	
• Number of connectable stations, max.	1 from viewpoint of WinCC flexible Runtime
SIMATIC S5 PROFIBUS DP interface	
• Number of connectable stations, max.	1 from viewpoint of WinCC flexible Runtime
Multi-protocol operation	Yes, OPC Client or SIMATIC HMI HTTP protocol are additive, i.e. can be used in conjunction with other PLC links

<sup>1)</sup> Together only 500 text and graphics lists

<sup>2)</sup> Dependent on memory medium used

<sup>3)</sup> Dependent on number of licensed PowerTags

<sup>4)</sup> Option for SIMATIC WinCC flexible Runtime. For further information, refer to "WinCC flexible options".

**PROFIBUS**System interfaces for SIMATIC HMI  
System interfaces with WinCC flexible

## SIMATIC WinCC flexible RT

**Ordering data****Article No.****Article No.****SIMATIC WinCC flexible 2008 Runtime**

for PC systems; incl. SW for PC systems options <sup>1)</sup> Single license, on CD-ROM incl. licensing, for:

- 128 PowerTags (RT 128)
- 512 PowerTags (RT 512)
- 2 048 PowerTags (RT 2048)
- 4 096 PowerTags (RT 4096)

**6AV6613-1BA51-3CA0**  
**6AV6613-1DA51-3CA0**  
**6AV6613-1FA51-3CA0**  
**6AV6613-1GA51-3CA0**

**Power Packs****SIMATIC WinCC flexible 2008 Runtime**

Single license, only license key for PowerTags, from

- 128 to 512 PowerTags
- 128 to 2 048 PowerTags
- 512 to 2 048 PowerTags
- 128 to 4 096 PowerTags
- 512 to 4 096 PowerTags
- 2 048 to 4 096 PowerTags

**6AV6613-4BD01-3AD0**  
**6AV6613-4BF01-3AD0**  
**6AV6613-4DF01-3AD0**  
**6AV6613-4BG01-3AD0**  
**6AV6613-4DG01-3AD0**  
**6AV6613-4FG01-3AD0**

**Updates****SIMATIC WinCC flexible 2008 Runtime Update 2008, 2008 SP1, 2008 SP2 -> 2008 SP3**

**6AV6613-1XA51-3CU8**

**Upgrades****SIMATIC WinCC flexible 2004/2005/2007 Runtime to SIMATIC WinCC flexible 2008 Runtime**

Upgrade to SIMATIC WinCC flexible Runtime 2008 PowerTags incl. Runtime Options for:

- WinCC flexible /Archives
- WinCC flexible /Recipes
- WinCC flexible /Audit
- WinCC flexible /Sm@rtAccess
- WinCC flexible /Sm@rtService
- WinCC flexible /OPC server
- WinCC flexible /ProAgent

**6AV6613-1XA51-3CE0**

Upgrade of the SIMATIC WinCC flexible Panel options:

- WinCC flexible /Audit for SIMATIC Panel
- WinCC flexible /Sm@rtAccess for SIMATIC Panel
- WinCC flexible /Sm@rtService for SIMATIC Panel
- WinCC flexible /OPC server for SIMATIC Multi Panel
- WinCC flexible /ProAgent for SIMATIC Multi Panel

**6AV6618-7XX01-3AF0**

**Documentation (must be ordered separately)****User Manual WinCC flexible Runtime**

- German
- English
- French
- Italian
- Spanish

**6AV6691-1BA01-3AA0**  
**6AV6691-1BA01-3AB0**  
**6AV6691-1BA01-3AC0**  
**6AV6691-1BA01-3AD0**  
**6AV6691-1BA01-3AE0**

**User Manual WinCC flexible Communication**

- German
- English
- French
- Italian
- Spanish

**6AV6691-1CA01-3AA0**  
**6AV6691-1CA01-3AB0**  
**6AV6691-1CA01-3AC0**  
**6AV6691-1CA01-3AD0**  
**6AV6691-1CA01-3AE0**

**SIMATIC Manual Collection**

**6ES7998-8XC01-8YE0**

Electronic documentation, on DVD  
5 languages (English, French, German, Italian and Spanish);  
contains: all currently available user manuals, device manuals and communication manuals for SIMATIC HMI

<sup>1)</sup> Runtime licenses for WinCC flexible Runtime options must be purchased separately for each target system.

**More information**

Additional information is available in the Internet under:

<http://www.siemens.com/wincc-flexible>

**Note:**

Do you need a specific modification or option for the products described here? You will find information about the Open Platform Program for the creation of user-specific functions and controls for WinCC flexible under "Customized Products".

## Overview

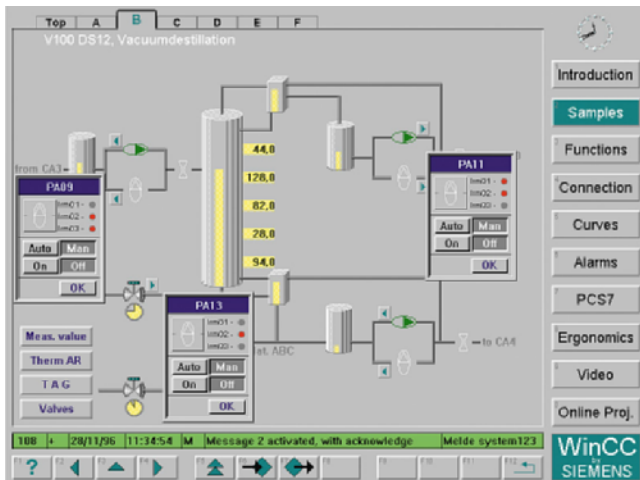

- PC-based operator control and monitoring system for visualizing and operating processes, production flows, machines and plants in all sectors – from the simple single-user station through to distributed multi-user systems with redundant servers and cross-location solutions with Web clients. WinCC is the information hub for corporation-wide vertical integration.
- The basic system configuration (WinCC basic software) includes industry-standard functions for signaling and acknowledging events, archiving of messages and measured values, logging of all process and configuration data, user administration and visualization.
- The WinCC basic software forms the core of a wide range of different applications. Based on the open programming interfaces, a wide range of WinCC options (from Siemens Industry Automation) and WinCC add-ons have been developed (by Siemens-internal and external partners).
- WinCC can be operated with every PC that meets the given HW requirements. The SIMATIC IPC product range is available in particular for the industrial use of WinCC systems. SIMATIC IPCs impress with their powerful PC technology, are designed for round-the-clock operation, and can be operated in both office areas and harsh industrial environments.

Current versions:

### **SIMATIC WinCC V7.3**

Ablauffähig unter:

- Windows 7 SP1 (32 / 64 bit) Professional, Enterprise, Ultimate
- Windows 8.1 (32 / 64 bit) Professional, Enterprise
- Windows 2008 Server SP2 (32 bit) Standard
- Windows 2008 Server R2 SP1 (64 bit) Standard
- Windows Server 2012 R2 (64 bit) Standard  
contains the Microsoft SQL Server 2008 R2 SP2 (32 bit)

### **SIMATIC WinCC V7.2**

Executable with:

- Windows 7 SP1 (32 / 64 bit) Professional, Enterprise, Ultimate
- Windows XP Professional SP3
- Windows Server 2003 SP2, Standard
- Windows Server 2008 SP2 (32 bit) Standard
- Windows Server 2008 R2 SP1 (64 bit) Standard  
contains the Microsoft SQL Server 2008 R2 SP1 (32 bit)

### **SIMATIC WinCC V7.0 SP3**

Executable with:

- Windows 7 SP1 (32 / 64 bit) Professional, Enterprise, Ultimate
- Windows XP Professional SP3
- Windows Server 2003 SP2 and Windows Server 2003 R2 SP2 Standard
- Windows Server 2008 SP2 (32 bit) Standard
- Windows Server 2008 R2 SP1 (64 bit) Standard  
contains the Microsoft SQL Server 2005 SP4
- Use in virtual environments – for additional information, see <http://support.automation.siemens.com/WWW/view/en/49370459>

## PROFIBUS

### System interfaces for SIMATIC HMI

### System interfaces with WinCC

#### SIMATIC WinCC

##### Benefits

- All-purpose
  - Solutions for all sectors
  - Multilingual for worldwide usage
  - Can be integrated into all automation solutions
- All HMI functions on board
  - User administration
  - Operator control and monitoring
  - Reporting, acknowledging, and archiving of events
  - Acquisition, compression and archiving of measured values (incl. long-term backup)
  - Logging and documenting of process and configuration data
- Can be configured simply and efficiently
  - Configuration wizards let the user focus on the essentials
  - In the picture by means of cross-reference lists and screen property displays
  - Configuration of multilingual applications
  - Configuring tool for configuring bulk data
- Universally scalable
  - Expandable from single station to client-server configurations
  - Increased availability by means of redundant servers
  - Process visualization via the web with the WinCC WebNavigator
- Open standards for simple integration
  - Powerful real-time database Microsoft SQL Server 2008 R2 SP1 (32 bit)
  - Open for application modules with ActiveX controls
  - Visual Basic for Applications for individual expansions
  - OPC for cross-vendor communication
- Process visualization with Plant Intelligence
  - Integrated high-performance Historian on the basis of the Microsoft SQL Server 2008 R2 SP1 (32 bit)
  - Integrated evaluation functions for the online analysis (statistical process control)
  - Production optimization with the help of diverse options
- Expandable using options and add-ons
  - Options for scalable configurations
  - Options for increasing the availability
  - Options for IT & business integration
  - Options for SCADA expansions
  - Options for validation in accordance with FDA 21 CFR Part 11
  - Options for the use of telecontrol protocols
- Part of Totally Integrated Automation
  - Direct access to the tag and message configuration of the SIMATIC control system
  - Integrated diagnostic functions for increasing productivity
  - Options for the use of telecontrol protocols

##### New in V7.2

- Expansion into Graphic Designer
  - Know-how protection by means of password protection for PDL images and image blocks
- Unicode support
  - WinCC SETUP in 5 languages / up to 9 installed languages
  - Individual language selection for engineering and runtime, regardless of the language settings in the operating system
- Simplified configuration of the Tag Management by means of the innovative WinCC Configuration Studio
  - Configuration options similar to those in Excel
  - Simplified tags / structure tag management
- New communication channels
  - Communication channel to new CPU (S7-1200 / S7-1500) (absolute address only, no CPU alarming support)
  - Introduction of the OPC UA server (DA, HDA)
- Expansion into archive system
  - New archive recording (day, week, year)
  - New archiving methods (difference)

and more ...

##### Application

SIMATIC WinCC is designed for visualization and operation of processes, manufacturing cycles, machines and plants. With its powerful process interface, especially to the SIMATIC family, and the secure data archiving, WinCC enables highly available solutions for the process control.

The sector-neutral basic system enables universal usage in all automation applications. Sector-specific solutions can, for example, be implemented using WinCC options (e.g. FDA options for the pharmaceutical industry) and sector-specific add-ons (e.g. for the water industry).

##### Design

SIMATIC WinCC is available as a complete package and as a runtime package with 128, 512, 2048, 8192, 65536, 102400, 153600, 262144 PowerTags <sup>1)</sup>. PowerTags are data points that are connected to controllers or other data sources over a WinCC channel. Up to 32 alarms can be obtained from one data point. Moreover, internal tags without coupling are available for additional system performance. In addition WinCC also contains 512 archive tags. Individual archive licenses can be obtained for greater quantity structures.

##### Licenses for a multi-user configuration

The system software with the required number of PowerTags and additionally the option WinCC/Server must be installed on the WinCC server. In the basic configuration, an RT128 or RT client license is sufficient for the WinCC clients. In order to perform configuration on clients, an RC128 license is required. Remote configuration is possible if WinCC clients without their own project (UniClient) on the server project are configured.

<sup>1)</sup> V6: 128, 256, 1024, 8192, 65536 PowerTags

## Function

The powerful configuration functions of SIMATIC WinCC contribute to a reduced engineering and training overhead and lead to a more flexible use of personnel and greater operational reliability. Whoever is familiar with Microsoft Windows can also operate the WinCC Explorer, the central switching point of WinCC.

In combination with other SIMATIC components, the system is also equipped with auxiliary functions such as process diagnostics and maintenance. All SIMATIC engineering tools work together in the configuration of the functions.

SIMATIC WinCC offers a complete basic functionality for process visualization and operation. To this end WinCC has a number of editors and interfaces that can be used to individually configure this functionality according to the respective application. Expansions of a WinCC station for control tasks are also possible with minimal engineering effort.

WinCC editors	Task or configurable runtime functionality
WinCC Explorer	Central project management for the quick access to all project data and central settings
WinCC Graphics Designer	Graphics system for user-defined visualization and operation via pixel-graphic objects
WinCC Alarm Logging	Signaling system for detecting and archiving events with display and control options according to DIN 19235; freely selectable message classes, message display and logging
WinCC Tag Logging	Process archiving for the acquisition, compression and storage of measured values, e.g., presentation in trend and table format as well as further processing
WinCC Report Designer	Reporting and logging system for time and event-controlled documentation of messages, operator inputs and current process data in the form of user reports or project documentation in an arbitrary layout
WinCC User Administrator	Tool for user-friendly administration of users and authorizations
WinCC Global Script	Processing functions with limitless functionality by means of the use of VBScript and ANSI-C

## Interfaces

	Task or configurable runtime functionality
Communication channels	For communication with subordinate controls (SIMATIC protocols, PROFIBUS DP, PROFIBUS FMS, DDE and OPC server included in the scope of delivery)
Standard interfaces	For the open integration of other Windows applications via WinCC, WinCC-OLE-DB, ActiveX, OLE, DDE, OPC, etc.)
Programming ports	For the individual access to data and functions of WinCC and for the integration in user programs with VBA, VB Script, C-API (ODK), C-Script (ANSI-C)

## Integration

### Integration in company-wide solutions (IT and business integration)

WinCC is strictly based on Microsoft technology, which provides the greatest possible compatibility and integration ability. ActiveX and .net <sup>1)</sup> controls support technology-specific and industry-specific expansions. Cross-manufacturer communication is also a simple exercise. The reason: WinCC can be used as an OPC client and server, and in addition to access to current process values, it also supports standards such as OPC HDA (Historical Data Access), OPC Alarm & Events, and OPC XML Data Access.

Just as important: Visual Basic for Applications (VBA) for user-specific expansions of the WinCC Graphics Designer and Visual Basic Scripting (VBS) as an easy-to-learn, open runtime language. If desired, professional application developers can also use ANSI-C. And access to the API programming interfaces is really simple with the Open Development Kit ODK.

WinCC integrates a powerful and scalable historian function based on Microsoft SQL Server 2005 into the basic system. As a result, users have every possibility: from high-performance archiving of current process data, to long-term archiving with high data compression, through to a central information hub in the form of a company-wide process historian. With the help of the Central Archive Server option, this can be set up within the framework of a WinCC solution. Versatile clients and tools for evaluation, the open interfaces, and special options (Connectivity Pack, Connectivity Station, IndustrialDataBridge) provide the basis for effective IT and business integration.

If external networks are accessed, suitable protective measures (incl. IT security measures, such as network segmentation) should be taken in order to ensure safe operation of the system.

You can find more information on the topic of Industrial Security on the Internet at:

<http://www.siemens.com/industrialsecurity>

<sup>1)</sup> Only supported in WinCC V7.0 or higher

### Integration in automation solutions

WinCC is an open process visualization system and provides the option to connect the most diverse control systems.

#### Approved communication software

Only communication software with the listed product versions (or higher) should be used. Corresponding SIMATIC NET upgrades are available for upgrading older versions.

#### Number of connectable controls

For the number of controls connectable via Industrial Ethernet CP 1613, the following applies to a message frame length of 512 bytes:

Type of connection	Number of nodes
SIMATIC S5 Ethernet Layer 4 + TCP/IP	Up to 60
SIMATIC S7 Protocol Suite	Up to 64
SIMATIC 505 Ethernet Layer 4 + TCP/IP	up to 60

Via PROFIBUS, a maximum of 8 controls can be connected with CP 5611, and a maximum of 44 controls with CP 5613. With approx. 10 or more controls, the usage of Industrial Ethernet is recommended.

## PROFIBUS

### System interfaces for SIMATIC HMI

### System interfaces with WinCC

#### SIMATIC WinCC

#### Integration (continued)

##### Mixed operation with different controls

With their multi-protocol stack, the CP 1613 and CP 5613 communication processors allow parallel operation of two protocols, such as for the mixed operation of different controls, via a bus cable. WinCC supports the operation of two similar interface boards only in connection with the channels SIMATIC S5 Ethernet Layer 4 (2 x CP 1613), SIMATIC S7 Protocol Suite (2 x CP 1613, 2 x CP 5613) as well as PROFIBUS DP (4 x CP 5613; each CP 5613 max. 122 slaves). In addition to communication over industrial Ethernet CP 1613 or PROFIBUS CP 5613, one CP 5611 can be used in each case for communication with SIMATIC S7 via MPI.

##### Client-server communication

Communication between the clients and the server is via TCP/IP protocol. Setting up a separate PC LAN is recommended. For small projects with a correspondingly low incidence of message frames, SIMATIC NET Industrial Ethernet communication can be used for both process communication (WinCC/Server ↔ PLC) and PC-PC communication (WinCC/client ↔ WinCC/server).

##### Channel DLL PROFIBUS DP

In accordance with the PROFIBUS standard, DP/slaves are always permanently assigned to a DP master; i.e. a second WinCC station (DP/master) cannot access the same controls (DP/slave). This means that redundant operation of two WinCC stations is not possible using the PROFIBUS DP connection.

##### Connection to controls from other manufacturers:

OPC (OLE for Process Control) is recommended for the connection of controls from other manufacturers.

Current notes and information about OPC servers from various suppliers can be found at: <http://www.opcfoundation.org>

WinCC supports the standards:

- OPC Data Access 2.05a
- OPC Data Access 3.00
- OPC XML Data Access 1.00 (Connectivity Pack/Connectivity Station)
- OPC HDA 1.20 (Connectivity Pack/Connectivity Station)
- OPC A&E 1.10 (Connectivity Pack/Connectivity Station)
- OPC UA Client Data Access
- OPC UA Server Data Access, HDA (Connectivity Pack / Connectivity Station)

#### Connection overview

Protocol	Description
<b>SIMATIC S7</b>	
SIMATIC S7 Protocol Suite	Channel DLL for S7 functions via MPI, PROFIBUS or Ethernet Layer 4 + TCP/IP
<b>SIMATIC S7-1200, S7-1500 (WinCC 7.2 or higher)</b>	
SIMATIC S7-1200, S7-1500 Channel <sup>1)</sup>	Channel DLL for S7-1200 and S7-1500 communication
<b>Cross-manufacturer</b>	
OPC Client <sup>2) 3)</sup> for DA, XML DA	Channel DLL for OPC communication, WinCC can acquire data from OPC server applications.
OPC Server for DA, XML DA, A&E, HDA	Server applications for OPC communication; WinCC provides process data to OPC clients
OPC UA server for DA, HDA	Server applications for OPC UA communication
PROFIBUS FMS	Channel DLL for PROFIBUS FMS
PROFIBUS DP	Channel DLL for PROFIBUS DP
SIMOTION	Channel DLL for SIMOTION

<sup>1)</sup> WinCC version V7.2 or higher supports communication with S7-1200 / S7-1500 CPU.  
Restrictions:  
No symbolic address, type safe structure support (absolute address only)  
No CPU alarming support

<sup>2)</sup> Application note:  
Parallel usage of the OPC client channel allows, for example, connection to an SNMP-OPC server for visualization of the data contained there. The SNMP OPC server enables monitoring of any network components (such as switches) that support the SNMP protocol. You can find more information under SIMATIC NET Communications Systems/SNMP OPC Server.

<sup>3)</sup> WinCC V7.0 SP3 and later supports OPC UA (United Architecture) Client for DA.



**Integration** (continued)**Communication components for PG/PC for SIMATIC (for WinCC V7.0)**

PROFIBUS	SIMATIC S5 PROFIBUS FDL	SIMATIC S7 Protocol Suite	PROFIBUS DP	PROFIBUS FMS	Article No.
<i>WinCC – channel DLL</i>					
<b>SIMATIC S5 PROFIBUS FDL</b> Channel DLL for S5-FDL	•				Included in the basic package
<b>SIMATIC S7 Protocol Suite</b> Channel DLL for S7 functions		•			Included in the basic package
<b>PROFIBUS DP</b> Channel DLL for PROFIBUS DP			•		Included in the basic package
<b>PROFIBUS FMS</b> Channel DLL for PROFIBUS FMS				•	Included in the basic package
<i>Communication components for extension of the OS/OP</i>					
<b>CP 5611 A2</b> PCI card (32-bit) for connecting a PG/PC to PROFIBUS or MPI (communication software included in WinCC basic package)		•			<b>6GK1561-1AA01</b>
<b>CP 5612</b> <sup>2)</sup> PCI card (32-bit) for connecting a PG/PC to PROFIBUS (communication software included in WinCC basic package)		•			<b>6GK1561-2AA00</b>
<b>CP 5621</b> PCI Express X1 card (32-bit) for connecting a PG/PC to PROFIBUS or MPI (communication software included in WinCC basic package)		•			<b>6GK1562-1AA00</b>
<b>CP 5622</b> <sup>2)</sup> PCI Express X1 card (32-bit) for connecting a PG/PC to PROFIBUS (communication software included in WinCC basic package)		•			<b>6GK1562-2AA00</b>
<b>CP 5711</b> USB Adapter for connecting a PG/PC to PROFIBUS or MPI (communications software included in the WinCC basic package)		•			<b>6GK1571-1AA00</b>
<b>CP 5613 A2</b> PCI card (32-bit) for connecting a PC to PROFIBUS (S7-5613, DP-5613 or FMS-5613 communication software required)	•	•	•	•	<b>6GK1561-3AA01</b>
<b>CP 5614 A2</b> PCI card (32-bit) for connecting a PC to PROFIBUS (communication software must be ordered separately)	•	•	•	•	<b>6GK1561-4AA01</b>
<b>CP 5623</b> PCI Express X1 card (32-bit) for connecting a PG/PC to PROFIBUS or MPI (S7-5613 communication software or DP-5613 or FMS-5613 required)	•	•	•	•	<b>6GK1562-3AA00</b>

• System interface possible

1) See ordering data for SIMATIC NET upgrade package

2) SIMATIC NET Version 8.2 SP1 and higher

**PROFIBUS**

## System interfaces for SIMATIC HMI

## System interfaces with WinCC

## SIMATIC WinCC

**Integration** (continued)

PROFIBUS	SIMATIC S5 PROFIBUS FDL	SIMATIC S7 Protocol Suite	PROFIBUS DP	PROFIBUS FMS	Article No.
<b>S7-5613</b> communication software for S7 functions + FDL • Version 8.1 <sup>1)</sup> for Windows 7 (32/64-bit) and Server 2008 R2 (64-bit) • Edition 2008 SP2 (V7.1) <sup>1)</sup> for Windows XP/2003 Server / (32-bit) 2008 Server	•	•			<b>6GK1713-5CB81-3AA0</b>  <b>6GK1713-5CB71-3AA0</b>
<b>DP-5613</b> communication software for DP master + FDL • Version 8.1 <sup>1)</sup> for Windows 7 (32/64-bit) and Server 2008 R2 (64-bit) • Edition 2008 SP2 (V7.1) <sup>1)</sup> for Windows XP/2003 Server / (32-bit) 2008 Server	•		•		<b>6GK1713-5DB81-3AA0</b>  <b>6GK1713-5DB71-3AA0</b>
<b>FMS-5613</b> communication software for PROFIBUS-FMS + FDL • Edition 2008 SP2 (V7.1) <sup>1)</sup> for Windows XP/2003 Server / (32-bit) 2008 Server	•			•	<b>6GK1713-5FB71-3AA0</b>

• System interface possible

<sup>1)</sup> See ordering data for SIMATIC NET upgrade package

<sup>2)</sup> SIMATIC NET Version 8.2 SP1 and higher

**Integration** (continued)

**Communication examples**

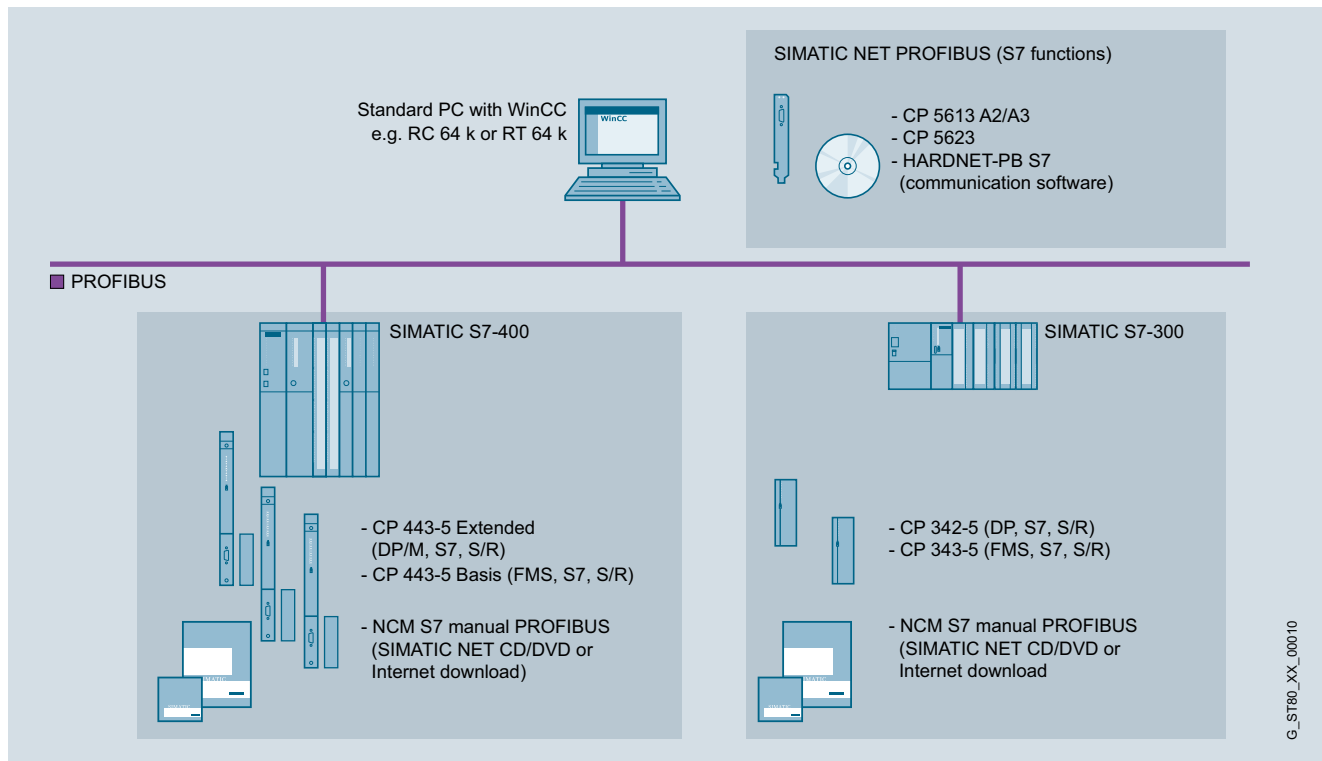

WinCC single-user system: PROFIBUS with S7 communication

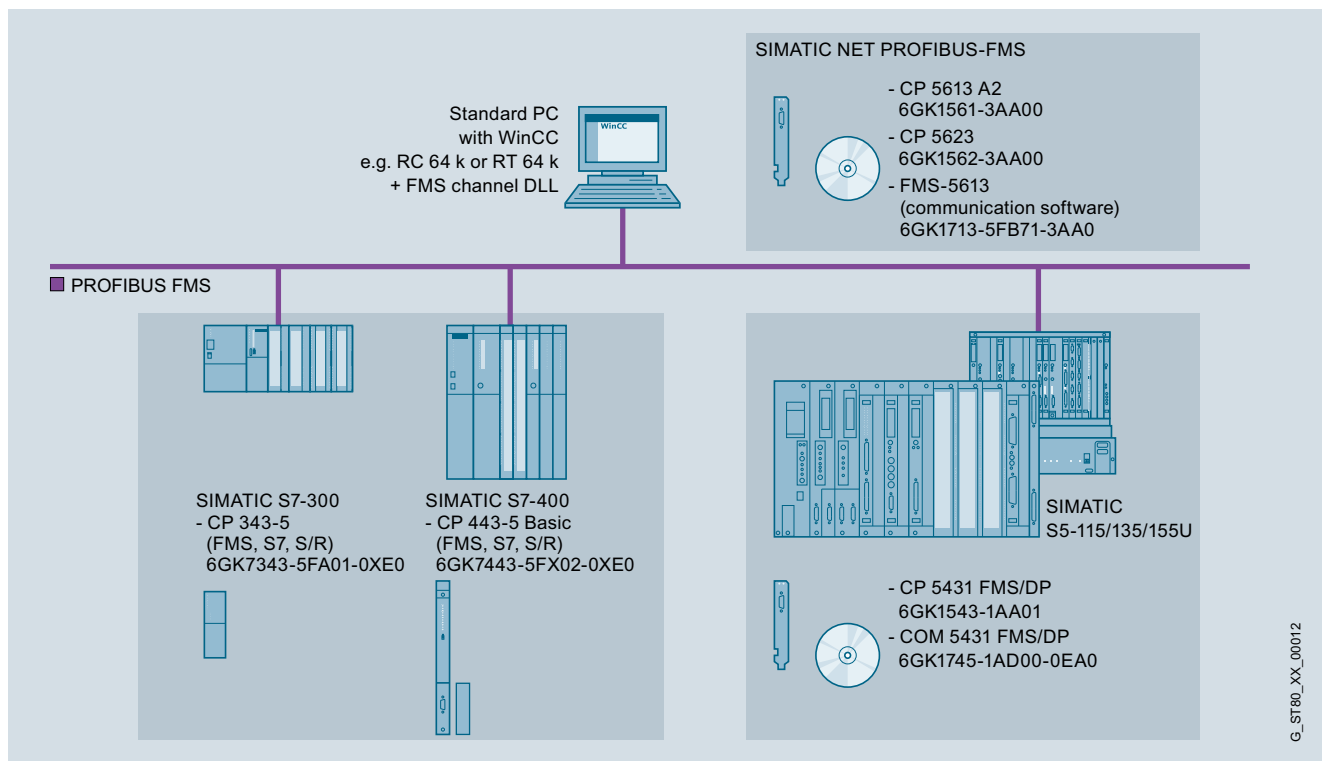

WinCC single-user system: PROFIBUS FMS

# PROFIBUS

## System interfaces for SIMATIC HMI System interfaces with WinCC

### SIMATIC WinCC

#### Integration (continued)

3

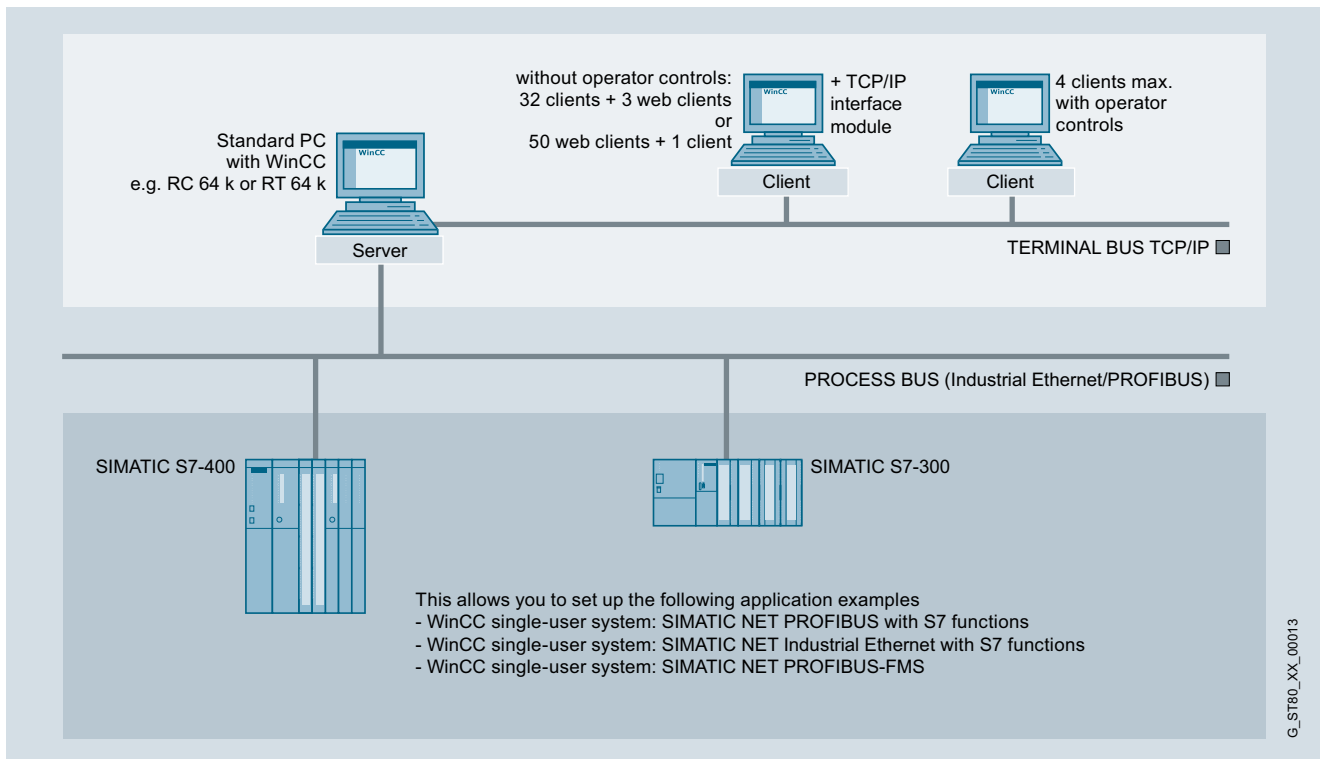

WinCC multi-user system with operable server

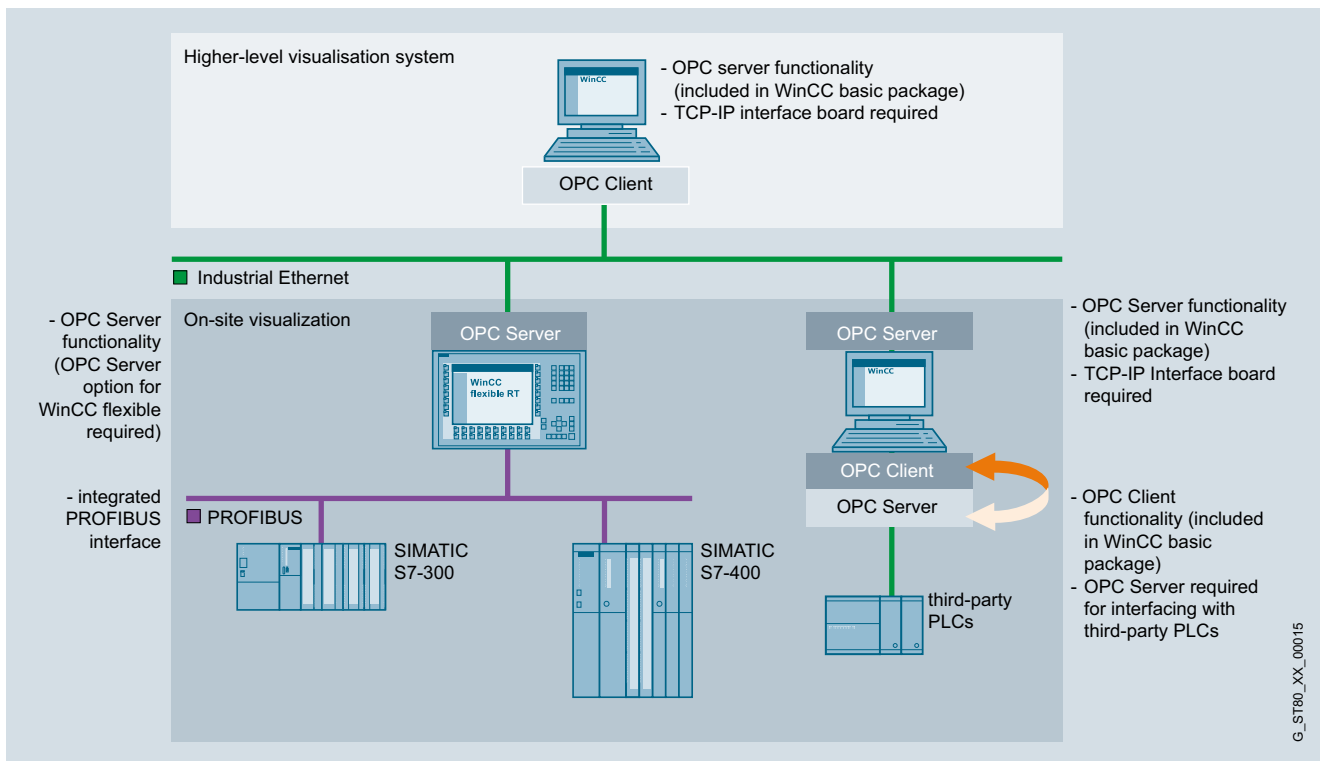

OPC link

#### Technical specifications

Type	SIMATIC WinCC V7.2 and V7.0 SP3	SIMATIC WinCC V6.2 SP3
<b>Operating system</b>	<ul style="list-style-type: none"> <li>Windows 7 (32 bit / 64 bit) Ultimate, Professional and Enterprise</li> <li>Windows XP Professional SP3</li> <li>Windows 2003 Server SP2 and Windows 2003 Server R2 SP2</li> <li>Windows Server 2008 SP2 (32 bit) Standard</li> <li>Windows Server 2008 R2 SP1 (64 bit) Standard</li> </ul>	<ul style="list-style-type: none"> <li>Windows XP Professional SP3,</li> <li>Windows 2000 Professional SP4,</li> <li>Windows Server 2003 SP2,</li> <li>Windows Server 2003 R2 SP2</li> </ul>
<b>PC hardware requirements</b>		
<b>Processor type</b> <sup>1)</sup>		
• Minimum	Single-user station/server: Pentium 4, 2.5 GHz <sup>2)</sup>  Central Archive Server (V7.0 SP3): Pentium 4, 2.5 GHz  Client: Pentium 3, 1 GHz <sup>2)</sup>  WebClient/DataMonitor Client: Pentium III, 600 MHz <sup>2)</sup>	Single-user station/server: Pentium III, 1 GHz  Central Archive Server: Pentium 4, 2 GHz  Client: Pentium III, 600 MHz
• Recommended	Single-user station/server: Pentium 4 or Dual Core, 3 GHz <sup>2)</sup>  Central Archive Server (V7.0 SP3): Pentium 4 or Dual Core, 3 GHz  Client: Pentium 4, 2 GHz <sup>2)</sup>  WebClient/DataMonitor Client: Pentium III, 1 GHz	Single-user station/server: Pentium 4, 2 GHz  Central Archive Server: Pentium 4, 2.5 GHz  Client: Pentium III, 1 GHz  WebClient/DataMonitor Client: Pentium III, 1 GHz
<b>RAM</b>		
• Minimum	Single-user station/server: 4 GB <sup>2)</sup> Central Archive Server: 4 GB Client: 1 GB <sup>2)</sup> WebClient/DataMonitor Client: 512 MB <sup>2)</sup>	Single-user station: 512 MB, server: 1 GB Central Archive Server: 1 GB Client: 512 MB WebClient/DataMonitor Client: 256 MB
• Recommended	Single-user station/server: 8 GB <sup>2)</sup>  Central Archive Server: ≥ 4 GB Client: 2 GB <sup>2)</sup> WebClient/DataMonitor Client: 1 GB <sup>2)</sup>	Single-user station: ≥ 1 GB, server: >1 GB  Central Archive Server: ≥ 2 GB Client: 512 MB WebClient/DataMonitor Client: 512 MB
<b>Graphics card</b>		
• Minimum	16 MB, 800 x 600 <sup>2)</sup>	16 MB, 800 x 600
• Recommended	32 MB, 1 280 x 1 024 <sup>2)</sup>	32 MB, 1 280 x 1 024
<b>Hard disk</b>		
• Minimum	Single-user station/server: 80 GB Client: 20 GB  Central Archive Server: 40 GB WebClient/DataMonitor Client: 5 GB	Single-user station/server: 20 GB Client: 5 GB  Central Archive Server: 40 GB WebClient/DataMonitor Client: 5 GB
• Recommended	Single-user station/server: 160 GB Client: 40 GB  Central Archive Server: 2 x 80 GB WebClient/DataMonitor Client: 10 GB	Single-user station/server: 80 GB Client: 20 GB  Central Archive Server: 2 x 80 GB WebClient/DataMonitor Client: 10 GB
• Hard disk (available memory for installation)		
- Minimum	Server: >1.5 GB Client: 1.5 GB	Server: 1.5 GB Client: 1 GB
- Recommended	Server: >10 GB Client: >1.5 GB	Server: >10 GB Client: >1.5 GB
<b>CD-ROM/DVD-ROM/disk drive/USB port</b>	for software installation	for software installation

<sup>1)</sup> An AMD system with comparable performance can also be used

<sup>2)</sup> Hardware requirements when using Microsoft XP Professional

# PROFIBUS

## System interfaces for SIMATIC HMI

### System interfaces with WinCC

#### SIMATIC WinCC

#### Technical specifications (continued)

Type	SIMATIC WinCC
<b>Functionality/quantity structure</b>	
Number of messages	150 000
• Message text (number of characters)	10 x 256
• Message archive	> 500 000 messages <sup>1)</sup>
• Process values per message	10
• Constant load of messages, max.	Central Archive Server: 100/sec Server/single-user station: 10/s
• Message burst, max.	Server/single-user station: 2 000/10 s every 5 min
Archives	
• Archive data points	Max. 120 000 per server <sup>2)</sup>
• Archive types	Short-term archive with and without long-term archiving
• Data storage format	Microsoft SQL Server 2005
• Measured values per second, max.	Server/single-user station: 5 000/s
User archive	
• Archives and views	500 each
• Product consisting of data record and column per user archive	320 000
• Fields per user archive	500
Graphics system	
• Number of screens	System-limited <sup>1)</sup>
• Number of objects per screen	System-limited <sup>1)</sup>
• Number of controllable fields per screen	System-limited <sup>1)</sup>
PowerTags	256 K <sup>3)</sup>
Trends	
• Trend views per image	25
• Trends per trend view	80
User administration	
• User groups	128
• Number of users	128
• Authorization groups	999
Configuration languages	
	5 European (Eng., Fr., Ger., It., Sp.) 4 Asian (simpl.+trad. Chi/Kor/Jpn) <sup>4)</sup>
Protocols	
• Message sequence reports (simultaneously)	1 per server/single-user station
• Message archive reports (simultaneously)	3
• User reports	System-limited <sup>1)</sup>
• Report lines per group	66
• Variables per report	300 <sup>5)</sup>
Multi-user system	
• Server	18
• Clients for server with operator station	4
• Clients for server without operator station	32 clients + 3 WebClients or 50 WebClients + 1 client

<sup>1)</sup> Dependent on the available storage space

<sup>2)</sup> Dependent on the number of licensed archive variables

<sup>3)</sup> Dependent on number of licensed PowerTags

<sup>4)</sup> Asian versions for Version 7 SP1 or higher

<sup>5)</sup> The number of variables per report is dependent on process communication performance

#### Ordering data

#### Article No.

##### SIMATIC WinCC system software V7.2

#### Runtime packages on DVD

Language/script versions:  
DE/EN/FR/IT/ES;  
with license for

- WinCC RT Client
- 128 PowerTags (RT 128)
- 512 PowerTags (RT 512)
- 2 048 PowerTags (RT 2048)
- 8 192 PowerTags (RT 8192)
- 65 536 PowerTags (RT 65536)
- 102 400 PowerTags (RT 102400)
- 153 600 PowerTags (RT 153600)
- 262 144 PowerTags (RT 262144)

**6AV6381-2CA07-2AX0**  
**6AV6381-2BC07-2AX0**  
**6AV6381-2BD07-2AX0**  
**6AV6381-2BE07-2AX0**  
**6AV6381-2BH07-2AX0**  
**6AV6381-2BF07-2AX0**  
**6AV6381-2BJ07-2AX0**  
**6AV6381-2BK07-2AX0**  
**6AV6381-2BL07-2AX0**

Including 512 archive tags each

#### Complete packages on DVD

Language versions:  
DE/EN/FR/IT/ES;  
with license for

- WinCC RC Client
- 128 PowerTags (RC 128)
- 512 PowerTags (RC 512)
- 2 048 PowerTags (RC 2048)
- 8 192 PowerTags (RC 8192)
- 65 536 PowerTags (RC 65536)
- 102 400 PowerTags (RC 102400)
- 153 600 PowerTags (RC 153600)
- 262 144 PowerTags (RC 262144)

**6AV6381-2CB07-2AX0**  
**6AV6381-2BM07-2AX0**  
**6AV6381-2BN07-2AX0**  
**6AV6381-2BP07-2AX0**  
**6AV6381-2BS07-2AX0**  
**6AV6381-2BQ07-2AX0**  
**6AV6381-2BT07-2AX0**  
**6AV6381-2BU07-2AX0**  
**6AV6381-2BV07-2AX0**

##### SIMATIC WinCC system software V7.2 ASIA

#### Runtime packages on DVD

Language/script versions:  
EN, CHS, CHT, KOR, JPN;  
with license for

- WinCC RT Client
- 128 PowerTags (RT 128)
- 512 PowerTags (RT 512)
- 2 048 PowerTags (RT 2048)
- 8 192 PowerTags (RT 8192)
- 65 536 PowerTags (RT 65536)
- 102 400 PowerTags (RT 102400)
- 153 600 PowerTags (RT 153600)
- 262 144 PowerTags (RT 262144)

**6AV6381-2CA07-2AV0**  
**6AV6381-2BC07-2AV0**  
**6AV6381-2BD07-2AV0**  
**6AV6381-2BE07-2AV0**  
**6AV6381-2BH07-2AV0**  
**6AV6381-2BF07-2AV0**  
**6AV6381-2BJ07-2AV0**  
**6AV6381-2BK07-2AV0**  
**6AV6381-2BL07-2AV0**

Including 512 archive tags each

#### Complete packages on DVD

Language versions:  
EN, CHS, CHT, KOR, JPN;  
with license for

- WinCC RC Client
- 128 PowerTags (RC 128)
- 512 PowerTags (RC 512)
- 2 048 PowerTags (RC 2048)
- 8 192 PowerTags (RC 8192)
- 65 536 PowerTags (RC 65536)
- 102 400 PowerTags (RC 102400)
- 153 600 PowerTags (RC 153600)
- 262 144 PowerTags (RC 262144)

**6AV6381-2CB07-2AV0**  
**6AV6381-2BM07-2AV0**  
**6AV6381-2BN07-2AV0**  
**6AV6381-2BP07-2AV0**  
**6AV6381-2BS07-2AV0**  
**6AV6381-2BQ07-2AV0**  
**6AV6381-2BT07-2AV0**  
**6AV6381-2BU07-2AV0**  
**6AV6381-2BV07-2AV0**

**Ordering data****Article No.****Article No.****SIMATIC WinCC V7.2 Powerpacks**

For upgrading from:

**Runtime packages**

- 128 to 512 PowerTags
- 512 to 2 048 PowerTags
- 2 048 to 8 192 PowerTags
- 8 192 to 65 536 PowerTags
- 65 536 to 102 400 PowerTags
- 102 400 to 153 600 PowerTags
- 153 600 to 262 144 PowerTags

**6AV6371-2BD07-2AX0**  
**6AV6371-2BG07-2AX0**  
**6AV6371-2BM07-2AX0**  
**6AV6371-2BN07-2AX0**  
**6AV6371-2BP07-2AX0**  
**6AV6371-2BQ07-2AX0**  
**6AV6371-2BR07-2AX0**

**Complete packages**

- 128 to 512 PowerTags
- 512 to 2 048 PowerTags
- 2 048 to 8 192 PowerTags
- 8 192 to 65 536 PowerTags
- 65 536 to 10 2400 PowerTags
- 102 400 to 153 600 PowerTags
- 153 600 to 262 144 PowerTags

**6AV6371-2BD17-2AX0**  
**6AV6371-2BG17-2AX0**  
**6AV6371-2BM17-2AX0**  
**6AV6371-2BN17-2AX0**  
**6AV6371-2BP17-2AX0**  
**6AV6371-2BQ17-2AX0**  
**6AV6371-2BR17-2AX0**

**SIMATIC WinCC V7.2 archives**

- 1 500 archives
- 5 000 archives
- 10 000 archives
- 30 000 archives
- 80 000 archives

**6AV6371-1DQ17-2AX0**  
**6AV6371-1DQ17-2BX0**  
**6AV6371-1DQ17-2CX0**  
**6AV6371-1DQ17-2EX0**  
**6AV6371-1DQ17-2GX0**

**SIMATIC WinCC V7.2 Archive Powerpacks**

For upgrading archiving from

- 1 500 to 5 000 archive tags
- 5 000 to 10 000 archive tags
- 10 000 to 30 000 archive tags
- 30 000 to 80 000 archive tags

**6AV6371-1DQ17-2AB0**  
**6AV6371-1DQ17-2BC0**  
**6AV6371-1DQ17-2CE0**  
**6AV6371-1DQ17-2EG0**

**SIMATIC WinCC Upgrade/Software Update Service****SIMATIC WinCC V7.2 upgrade <sup>1)</sup>**

For upgrading the RT version

- from V6.2 to V7.2
- from V7.0 to V7.2
- from V6.2 ASIA to V7.2 ASIA
- from V7.0 ASIA to V7.2 ASIA

**6AV6381-2AA07-2AX4**  
**6AV6381-2AA07-2AX3**  
**6AV6381-2AA07-2AV4**  
**6AV6381-2AA07-2AV3**

For upgrading the Client RT version

- from V6.2 to V7.2
- from V7.0 to V7.2
- from V6.2 ASIA to V7.2 ASIA
- from V7.0 ASIA to V7.2 ASIA

**6AV6381-2BC07-2AX4**  
**6AV6381-2BC07-2AX3**  
**6AV6381-2BC07-2AV4**  
**6AV6381-2BC07-2AV3**

For upgrading the RC version

- from V6.2 to V7.2
- from V7.0 to V7.2
- from V6.2 ASIA to V7.2 ASIA
- from V7.0 ASIA to V7.2 ASIA

**6AV6381-2AB07-2AX4**  
**6AV6381-2AB07-2AX3**  
**6AV6381-2AB07-2AV4**  
**6AV6381-2AB07-2AV3**

**SIMATIC WinCC Software Update Service (SUS) <sup>2) 3)</sup>****SIMATIC WinCC V7 Update**

Software Update Service for WinCC basic software and options:

- 1 license
- 3 licenses
- 10 licenses

**6AV6381-1AA00-0AX5**  
**6AV6381-1AA00-0BX5**  
**6AV6381-1AA00-0CX5**

<sup>1)</sup> According to licensing provisions, 1 upgrade package must be ordered for each WinCC station

<sup>2)</sup> The Software Update Service is valid for 1 year. The contract is automatically extended by 1 more year unless canceled 3 months prior to expiration. According to licensing provisions, 1 Software Update Service must be ordered for each WinCC station.

<sup>3)</sup> Requires the current software version

**SIMATIC WinCC system software V6.2 SP3****Runtime packages on CD-ROM**Language/script versions:  
DE/EN/FR/IT/ES;  
with license for

- 128 PowerTags (RT 128)
- 256 PowerTags (RT 256)
- 1 024 PowerTags (RT 1024)
- 8 192 PowerTags (RT 8192)
- 65 536 PowerTags (RT 65536)
- 102 400 PowerTags (RT 102400)
- 153 600 PowerTags (RT 153600)
- 262 144 PowerTags (RT 262144)

**6AV6381-1BC06-2AX0**  
**6AV6381-1BD06-2AX0**  
**6AV6381-1BE06-2AX0**  
**6AV6381-1BH06-2AX0**  
**6AV6381-1BF06-2AX0**  
**6AV6381-1BJ06-2AX0**  
**6AV6381-1BK06-2AX0**  
**6AV6381-1BL06-2AX0**

Including 512 archive tags each

**Complete packages on CD-ROM**Language versions:  
DE/EN/FR/IT/ES;  
with license for

- 128 PowerTags (RC 128)
- 256 PowerTags (RC 256)
- 1 024 PowerTags (RC 1024)
- 8 192 PowerTags (RC 8192)
- 65 536 PowerTags (RC 65536)
- 102 400 PowerTags (RC 102400)
- 153 600 PowerTags (RC 153600)
- 262 144 PowerTags (RC 262144)

**6AV6381-1BM06-2AX0**  
**6AV6381-1BN06-2AX0**  
**6AV6381-1BP06-2AX0**  
**6AV6381-1BS06-2AX0**  
**6AV6381-1BQ06-2AX0**  
**6AV6381-1BT06-2AX0**  
**6AV6381-1BU06-2AX0**  
**6AV6381-1BV06-2AX0**

Including 512 archive tags each

**SIMATIC WinCC system software V6.2 SP3 ASIA****Runtime packages on CD-ROM**Language versions:  
English/simplified and traditional  
Chinese/Korean/Taiwanese/  
Japanese;  
with license for

- 128 PowerTags (RT 128)
- 256 PowerTags (RT 256)
- 1 024 PowerTags (RT 1024)
- 8 192 PowerTags (RT 8192)
- 65 536 PowerTags (RT 65536)

**6AV6381-1BC06-2AV0**  
**6AV6381-1BD06-2AV0**  
**6AV6381-1BE06-2AV0**  
**6AV6381-1BH06-2AV0**  
**6AV6381-1BF06-2AV0**

Including 512 archive tags each

**Complete packages on CD-ROM**Language versions:  
English/simplified and traditional  
Chinese/Korean/Taiwanese,  
Japanese;  
with license for

- 128 PowerTags (RC 128)
- 256 PowerTags (RC 256)
- 1 024 PowerTags (RC 1024)
- 8 192 PowerTags (RC 8192)
- 65 536 PowerTags (RC 65536)

**6AV6381-1BM06-2AV0**  
**6AV6381-1BN06-2AV0**  
**6AV6381-1BP06-2AV0**  
**6AV6381-1BS06-2AV0**  
**6AV6381-1BQ06-2AV0**

Including 512 archive tags each

**PROFIBUS**

## System interfaces for SIMATIC HMI

## System interfaces with WinCC

## SIMATIC WinCC

**Ordering data****Article No.***SIMATIC WinCC V6.2 PowerPacks*

For upgrading from:

**Runtime packages**

- 128 to 256 PowerTags
- 128 to 1 024 PowerTags
- 128 to 8 192 PowerTags
- 128 to 65 536 PowerTags
- 256 to 1 024 PowerTags
- 256 to 8 192 PowerTags
- 256 to 65 536 PowerTags
- 1 024 to 8 192 PowerTags
- 1 024 to 65 536 PowerTags
- 8 192 to 65 536 PowerTags

**6AV6371-1BD06-2AX0**  
**6AV6371-1BE06-2AX0**  
**6AV6371-1BK06-2AX0**  
**6AV6371-1BF06-2AX0**  
**6AV6371-1BG06-2AX0**  
**6AV6371-1BL06-2AX0**  
**6AV6371-1BH06-2AX0**  
**6AV6371-1BM06-2AX0**  
**6AV6371-1BJ06-2AX0**  
**6AV6371-1BN06-2AX0**

**Complete packages**

- 128 to 256 PowerTags
- 128 to 1 024 PowerTags
- 128 to 8 192 PowerTags
- 128 to 65 536 PowerTags
- 256 to 1 024 PowerTags
- 256 to 8 192 PowerTags
- 256 to 65 536 PowerTags
- 1 024 to 8 192 PowerTags
- 1 024 to 65 536 PowerTags
- 8 192 to 65 536 PowerTags

**6AV6371-1BD16-2AX0**  
**6AV6371-1BE16-2AX0**  
**6AV6371-1BK16-2AX0**  
**6AV6371-1BF16-2AX0**  
**6AV6371-1BG16-2AX0**  
**6AV6371-1BL16-2AX0**  
**6AV6371-1BH16-2AX0**  
**6AV6371-1BM16-2AX0**  
**6AV6371-1BJ16-2AX0**  
**6AV6371-1BN16-2AX0**

**Article No.***SIMATIC WinCC V6.2 Archive*

- 1 500 archives
- 5 000 archives
- 10 000 archives
- 30 000 archives
- 80 000 archives
- 120 000 archives

**6AV6371-1DQ16-2AX0**  
**6AV6371-1DQ16-2BX0**  
**6AV6371-1DQ16-2CX0**  
**6AV6371-1DQ16-2EX0**  
**6AV6371-1DQ16-2GX0**  
**6AV6371-1DQ16-2JX0**

*SIMATIC WinCC V6.2 Archive Powerpacks*

For upgrading archiving from

- 1 500 to 5 000 archive tags
- 5 000 to 10 000 archive tags
- 10 000 to 30 000 archive tags
- 30 000 to 80 000 archive tags
- 80 000 to 120 000 archive tags

**6AV6371-1DQ16-2AB0**  
**6AV6371-1DQ16-2BC0**  
**6AV6371-1DQ16-2CE0**  
**6AV6371-1DQ16-2EG0**  
**6AV6371-1DQ16-2GJ0**

*SIMATIC WinCC V6.2 upgrade <sup>1)</sup>*

For upgrading the RT version

- from V5.x to V6.2 SP3
- from V6.x to V6.2 SP3
- from V5.x ASIA to V6.2 SP3 ASIA
- from V6.x ASIA to V6.2 SP3 ASIA

**6AV6381-1AA06-2AX4**  
**6AV6381-1AA06-2AX3**  
**6AV6381-1AA06-2AV4**  
**6AV6381-1AA06-2AV3**

For upgrading the RC version

- from V5.x to V6.2 SP3
- from V6.x to V6.2 SP3
- from V5.x ASIA to V6.2 SP3 ASIA
- from V6.x ASIA to V6.2 SP3 ASIA

**6AV6381-1AB06-2AX4**  
**6AV6381-1AB06-2AX3**  
**6AV6381-1AB06-2AV4**  
**6AV6381-1AB06-2AV3**

<sup>1)</sup> According to licensing provisions, 1 upgrade package must be ordered for each WinCC station.

**More information****WinCC language versions**

SIMATIC WinCC is also offered in simplified Chinese, traditional Chinese, Korean and Japanese especially for Asian markets. These WinCC versions are intended for machine manufacturers, plant constructors and exporters who supply the regions of China, Taiwan, Korea and Japan.

WinCC ASIA includes all familiar WinCC functions and offers in addition the configuration user interface in the respective national language and English. The online help is available in simplified Chinese, traditional Chinese, Korean, Japanese and English. A Chinese, Korean, Japanese or multilingual Windows operating system is required for operation.

WinCC ASIA is delivered on a separate DVD which contains all of the above mentioned language versions. The corresponding documentation can be obtained from the national subsidiaries in China, Korea, Taiwan and Japan.

The runtime licenses are language-neutral. The English handling program (Automation License Manager – ALM) is executable under the Chinese, Korean and Japanese Windows versions.

In order to use the Asian languages in WinCC, an Asia hardware dongle is required.

Additional information is available on the Internet at:

<http://www.siemens.com/wincc>

Separate configurators are available for PC hardware:

- SIMATIC IPC547C
- SIMATIC IPC647C
- SIMATIC IPC847C
- SIMATIC IPC427C, SIMATIC IPC427D
- SIMATIC IPC627C
- SIMATIC Box PC 827C
- SIMATIC IPC477C, SIMATIC IPC477D
- SIMATIC HMI IPC577C
- SIMATIC HMI IPC677C



## Overview



- Interconnecting two PROFIBUS DP networks
- The interchange of data between both DP networks takes place by internal copying in the coupler.

## Application

The PROFIBUS DP/DP coupler interconnects two PROFIBUS DP networks. Byte data (0 ... 244 byte) is transferred from the DP master of the first network to the DP master of another network and vice versa.

The principle corresponds to the hardware wiring of inputs and outputs used today. The coupler has two independent DP interfaces with which the two DP networks are connected.

The DP/DP coupler is a slave on each DP network. The interchange of data between both DP networks takes place by internal copying in the coupler.

## Design

The DP/DP transceiver is housed in a 40 mm casing of the S7-300 series. It can be mounted on a standard mounting rail (7.5 mm and 15 mm) as well as on a mounting rail for the S7 design.

The preferred arrangement is upright in a row, side by side, and without clearance.

The transceiver is connected to the PROFIBUS DP networks through an integral 9-pin sub-D connector.

## Function

The DP/DP coupler continuously copies the output data from one network to the input data of the other network (and vice versa).

### Functions

- Data exchange of up to 244 byte of input and output data of which up to 128 >byte can be consistent
- Up to 16 input/output ranges for exchanging data
- If one side fails, the outputs on the other side maintain the previous value
- Support of DPV1 with full diagnostics
- Adjustment of DP/DP coupler either via switch or STEP 7
- Different baud rate settings are possible
- Electrical isolation between the two DP networks
- Power is supplied to both sides

### Parameter assignment

The PROFIBUS DP addresses are set via two DIP switches on the top of the coupler.

The coupler is configured either with STEP 7 or with a configuring tool which integrates the DP/DP coupler with the help of a GSD file.

The data length is adjusted with the corresponding configuring tool.

## Technical specifications

DP/DP transceiver	
PROFIBUS transmission rate	max. 12 Mbit/s
Interfaces	
• PROFIBUS DP	9-pin Sub-D connector
Supply voltage	24 V DC
Current consumption typ.	150 mA
Mounting	Upright (DIP switches above)
Perm. environmental conditions	
• Operating temperature	
- horizontal mounting	0°C ... +60°C
- all other mounting positions	0°C ... +40°C
• Transport/storage temperature	-40 °C ... +70 °C
• Relative humidity	10 ... 95 % at +25 °C
Design	
• Dimensions (W x H x D) in mm	40 x 127 x 117
• Weight	approx. 250 g
Degree of protection	IP20

## Ordering data

### Article No.

DP/DP coupler

6ES7158-0AD01-0XA0

### Note:

The manual is available free on the Internet.

## More information

### Brochures

Information material for downloading can be found in the Internet:

<http://www.siemens.com/simatic/printmaterial>

## PROFIBUS

### Network transitions

#### PA routers

#### Overview



To create a smooth network transition between PROFIBUS DP and PROFIBUS PA, the SIMATIC product range offers two versions: the DP/PA coupler and the PA link.

The following criteria can be applied when choosing the network transition:

- DP/PA coupler:  
For small quantity frameworks (volumes of data) and low timing requirements; limiting of data transfer rate on the PROFIBUS DP to 45.45 kbit/s
- PA link:  
For large number of stations and high cycle time requirements; data transfer rate on the PROFIBUS DP up to 12 Mbit/s

#### Application

The two PA routers are based on two versions of the DP/PA coupler:

- Ex [i] DP/PA coupler (max. output current 110 mA) for implementation of PROFIBUS PA networks with a line or tree topology in environments up to Ex zone 1/21, not for redundant architectures (coupler redundancy, ring)
- FDC 157-0 DP/PA coupler (max. output current 1 000 mA) for implementation of PROFIBUS PA networks with a line, tree or ring topology in environments up to Ex zone 2/22; can be used for the redundant architectures "Ring" and "Coupler redundancy"

DP/PA couplers are also integral components of the PA link (see design). The PA link connects PROFIBUS DP and PROFIBUS PA together, and decouples the transmission rates. In contrast to the DP/PA coupler which limits the data transmission rate on the PROFIBUS DP to 45.45 kbit/s, the PA link does not influence the performance of the PROFIBUS DP.

The PA link functions as a slave on the PROFIBUS DP and as a master on the PROFIBUS PA. From the viewpoint of the host PROFIBUS DP master, the PA link is a modular slave whose modules are the devices connected on the PROFIBUS PA. Addressing of these devices is carried out indirectly via the PA link that itself only requires one node address. The host PROFIBUS master can scan devices connected to the PA link all at once.

If the router is a DP/PA coupler, the nodes on the PROFIBUS PA are directly addressed by the PROFIBUS DP master (controller). The DP/PA coupler is an electrical node, but is transparent for communication between the master and PA field devices; it therefore does not require setting of parameters or addresses (exception: FDC 157-0 DP/PA coupler used as PROFIBUS diagnostics slave).

#### **PROFIBUS diagnostics with FDC 157-0 DP/PA coupler, configured as PROFIBUS diagnostics slave**

FDC 157-0 DP/PA couplers configured as PROFIBUS diagnostics slaves supply extensive diagnostic and status information via PROFIBUS for swift localization and correction of faults:

- I&M (Identification & Maintenance) data
- Current and voltage values on the main cable
- Redundancy status
- Wire breakage
- Short-circuit
- Signal level

To this end, each of these DP/PA couplers FDC 157-0 requires its own PROFIBUS address. This applies independent of use in a PA Link or as a PA router.

The PA link and DP/PA coupler approved for an extended temperature range are available for use in environments up to Ex zone 2/22. Both are operated with 24 V DC. Assembly is on an S7-300 rail with horizontal or vertical alignment.

### Design

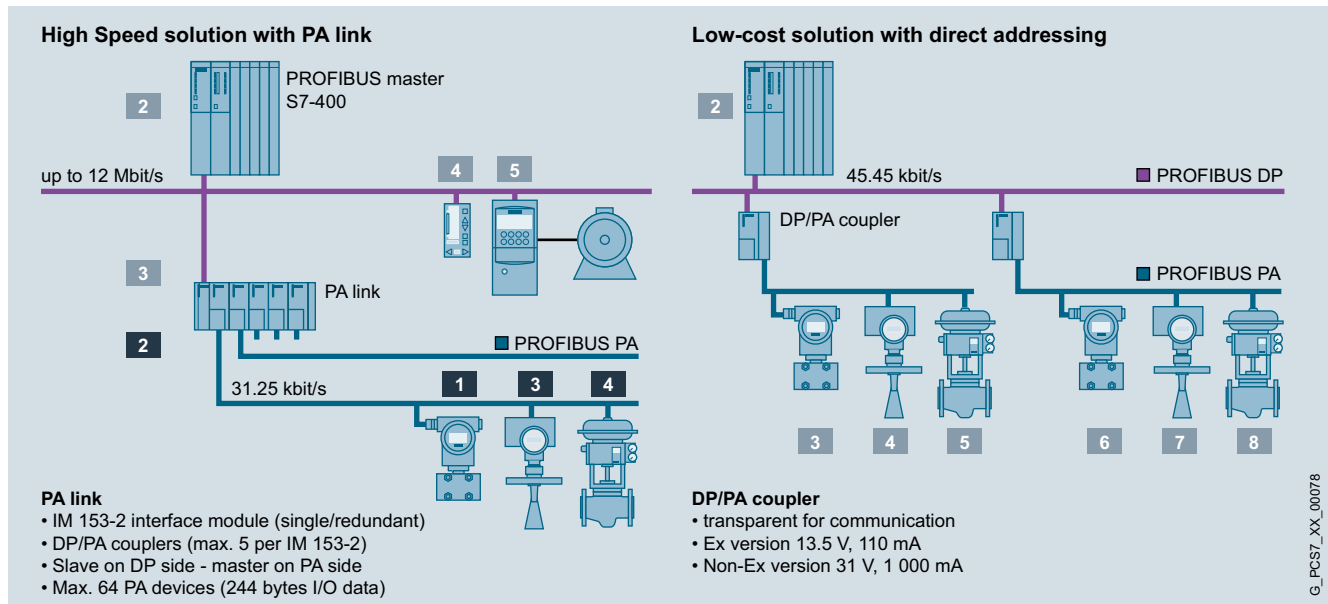

Configuration examples for PA link and DP/PA coupler

### PA link

The PA link is a modular combination in S7-300 design consisting of the IM 153-2 High Feature PROFIBUS DP interface module (with optional redundancy) and up to 5 DP/PA couplers (FDC 157-0 or Ex [i]).

All components of the PA link are interconnected through the S7 backplane bus. The use of active bus modules as backplane bus allows hot swapping of individual modules and redundancy of the IM 153-2 High Feature PROFIBUS DP interface modules and the FDC 157-0 DP/PA coupler. If redundancy and changes during operation are not required, passive bus connectors can be used instead of active bus modules.

The PS 307 or PS 305 load power supply can be used for the 24 V DC. With a redundant IM 153-2 High Feature interface module for PROFIBUS DP, it is also recommendable to have a redundant 24 V DC supply, e.g. with two PS 307/PS 305 load power supplies.

The PROFIBUS PA bus segments designed with the DP/PA couplers are physically separated as regards current infeed, but form one bus system in communication terms. A PROFIBUS PA ring segment or a PROFIBUS PA line segment with coupler redundancy can be operated on a PA link. Further PROFIBUS PA line segments can be operated on this PA link using individual couplers. The FDC 157-0 DP/PA couplers provided for the ring coupling or coupler redundancy must always be located at the right-hand end of a sequence of up to 5 couplers.

The following basic components are available for configuring the PA link:

- IM 153-2 High Feature interface module for extended temperature range
- DP/PA coupler (Ex [i] and FDC 157-0)
- Components for redundant design and for hot swapping
  - Mounting rail for hot swapping (as an alternative to the standard mounting rail)
  - BM PS/IM for 1 load power supply and 1 IM 153-2 High Feature module, for extended temperature range
  - IM/IM (IM 157) bus module for two IM 153-2 High Feature modules, for redundant and non-redundant design and for extended temperature range
  - BM FDC for 1 DP/PA coupler Ex [i] or FDC 157-0, for extended temperature range (up to 5 DP/PA couplers possible per PA link)
  - BM FDC/FDC for 2 DP/PA couplers FDC 157-0, for extended temperature range

Additive option:

- PS 307 for 120/230 V AC; 24 V DC load power supply, version in 2, 5 or 10 A, or
- PS 305 load power supply for 24/48/60/110 V DC; 24 V DC, 2 A

# PROFIBUS

## Network transistions

### PA routers

#### Technical specifications

##### DP/PA coupler

##### Bus connection

Connection for PROFIBUS PA

- DP/PA coupler Ex [i]

2 terminals of a 4-pole screw-type terminal, integrated terminating resistor

- DP/PA coupler FDC 157-0

4-pole screw-type terminal for connection and looping through, selectable terminating resistor

Connection for PROFIBUS DP

9-pin Sub-D plug, contact assignment as described in IEC 61158/EN 50170

##### Module-specific data

Degree of protection	IP20
Transmission rate on PROFIBUS DP	45.45 Kbps
Transmission rate on PROFIBUS PA	31.25 Kbps
Communication protocol	PROFIBUS DP

##### Voltages, currents, potentials

Supply voltage	24 V DC (20.4 V ... 28.8 V)
Reverse polarity protection	Yes
Overvoltage protection	Yes
Voltage at coupler output (PA)	
• DP/PA coupler Ex [i]	13 V ... 14 V DC
• DP/PA coupler FDC 157-0	31 ± 1 V DC
Voltage monitoring	15.5 V
Overvoltage monitoring	U > 35 V; latching cutoff
Voltage failure bridging	Min. 5 ms
Current at coupler output (PA) for supplying the PA field devices	
• DP/PA coupler Ex [i]	Max. 110 mA
• DP/PA coupler FDC 157-0	Max. 1 A
Galvanic isolation 24 V DC	
• PROFIBUS DP/PROFIBUS PA	Yes
• PROFIBUS DP/supply	Yes
• PROFIBUS PA/supply	Yes
• All electric circuits/functional grounding	Yes
Power consumption of modules (24 V DC)	
• DP/PA coupler Ex [i]	Max. 400 mA
• DP/PA coupler FDC 157-0	Max. 2.3 A
Power loss of the module	
• DP/PA coupler Ex [i]	Typ. 7 W
• DP/PA coupler FDC 157-0	Typ. 13.4 W

##### Status, interrupts, diagnostics

Diagnostics displays DP/PA coupler Ex [i] and DP/PA coupler FDC 157-0

- PROFIBUS DP bus monitoring
- PROFIBUS PA bus monitoring
- 24 V DC power supply monitoring

Yellow LED "DP"  
Yellow LED "PA"  
Green "ON" LED

Additive diagnostics displays of the DP/PA coupler FDC 157-0

- Group error
- Bus error
- Monitoring DP/PA coupler (active coupler in redundant configuration)

Red LED "SF"  
Red LED "BF"  
Yellow LED "ACT"

##### Climatic conditions

Permissible operating temperature DP/PA coupler Ex [i] and DP/PA coupler FDC 157-0

- Horizontal installation
- Vertical installation

-25 ... +60 °C  
-25 ... +40 °C

##### Dimensions and weight

Dimensions (W x H x D) in mm	80 x 125 x 130
Weight	
• DP/PA coupler Ex [i]	Approx. 550 g
• DP/PA coupler FDC 157-0	Approx. 515 g

**Technical specifications (continued)**
*IM 153-2 High Feature (for extended temperature range)*

<b>Function</b>	<p>Linking of PROFIBUS DP (9.6 Kbps to 12 Mbps, slave functionality) and PROFIBUS PA (master functionality) with support of the "Configuration in Run" function</p> <p>The DP/PA link function is only implemented by extending the IM 153-2 High Feature with one or more DP/PA couplers. Stand-alone operation of the IM 153-2 High Feature is not possible.</p> <p>1 Y coupler, up to 5 DP/PA couplers or up to 64 slaves can be connected</p> <p>Isolation from the higher-level DP master system</p>
<b>Bus connection</b>	
• Connection for PROFIBUS DP	9-pin Sub-D plug, contact assignment as described in IEC 61158/EN 50170, Vol. 2
<b>Connectable lower-level components</b>	
Number of couplers	
• DP/PA coupler	Max. 5
• Y coupler	1
Number of PA devices on PROFIBUS PA	Max. 64
<b>Module-specific data</b>	
Degree of protection	IP20
Transmission rate of the higher level DP master system	9.6; 19.2; 45.45; 93.75; 187.5; 500 Kbps; 1.5; 3; 6; 12 Mbps
Communication protocol	PROFIBUS DP
Frame length	
• I/O data	Max. 244 bytes
• Configuration frame	Max. 244 bytes
• Diagnostics frame	Max. 244 bytes
• Parameter assignment frame	Max. 244 bytes

<b>Voltages, currents, potentials</b>	
Supply voltage	24 V DC (20.4 V ... 28.8 V)
Reverse polarity protection	Yes
Voltage failure bridging	20 ms
Galvanic isolation	
• to the higher-level DP master system	Yes
• to the DP/PA coupler or Y coupler	No
Power consumption of modules (24 V DC)	
• In the PA link	Max. 200 mA (at 20.4 V)
• In the Y link	Max. 400 mA (at 20.4 V)
Power loss of the module	
• In the PA link	Max. 2.6 W (at 28.8 V)
• In the Y link	Max. 3.6 W (at 28.8 V)
Infeed, mechanical design	4-pin screw terminal, short-circuiting link between PE and M24; the short-circuiting link must be removed for floating operation (independent of this, the DP interface is always floating)
<b>Status, interrupts, diagnostics</b>	
Diagnostics displays	
• Group error	Red LED "SF"
• Bus error on higher level DP master system	Red LED "BF 1"
• Bus error on underlying bus system	Red LED "BF 2"
• Module is active in redundancy mode	Yellow LED "ACT"
• 24 V DC power supply monitoring	Green "ON" LED
<b>Climatic conditions</b>	
Permissible operating temperature	
• Horizontal installation	-25 ... +60 °C
• Vertical installation	-25 ... +40 °C
<b>Dimensions and weight</b>	
Dimensions (W x H x D) in mm	40 x 125 x 130
Weight	Approx. 360 g

# PROFIBUS

## Network transistions

### PA routers

#### Ordering data

##### DP/PA coupler

For transition from RS 485 to MBP

- DP/PA coupler Ex [i]  
Fieldbus coupler between PROFIBUS DP and PROFIBUS PA, EEx(ia) version, max. output current 110 mA; degree of protection IP20; for extended temperature range, permissible operating temperature -25 to +60 °C
- DP/PA coupler FDC 157-0  
Fieldbus coupler between PROFIBUS DP and PROFIBUS PA, with redundancy capability; integrated PROFIBUS diagnostics slave; max. output current 1 A; degree of protection IP20; for extended temperature range, permissible operating temperature -25 to +60 °C

#### Article No.

6ES7157-0AD82-0XA0

6ES7157-0AC83-0XA0

##### IM 153-2 High Feature

Interface module for PA Link and Y-Link; with redundancy capability; degree of protection IP20; for extended temperature range, permissible operating temperature -25 to +60 °C

6ES7153-2BA82-0XB0

##### Accessories

##### PS 307 Load Power Supply

Including connecting comb; 120/230 V AC; 24 V DC

- 2 A; 40 mm wide
- 5 A; 60 mm wide
- 5 A, extended temperature range; 80 mm wide
- 10 A, 80 mm wide

6ES7307-1BA01-0AA0

6ES7307-1EA01-0AA0

6ES7307-1EA80-0AA0

6ES7307-1KA02-0AA0

##### PS 305 Load Power Supply

24/48/60/110 V DC; 24 V DC

- 2 A, extended temperature range; 80 mm wide

6ES7305-1BA80-0AA0

##### Standard profile rails

(without hot swapping function)

- 482 mm wide (19 inches)
- 530 mm wide

6ES7390-1AE80-0AA0

6ES7390-1AF30-0AA0

#### Article No.

##### Components for hot swapping and for redundant design

##### Active bus modules for hot swapping

- BM PS/IM SIPLUS extreme  
for 1 load current supply and 1 IM 153-2 High Feature module; for "hot swapping" function, for extended temperature range, permissible operating temperature -25 to +70 °C
- BM IM/IM  
for 2 IM 153-2 High Feature modules, for redundant and non-redundant configuration, for "hot swapping" function, for extended temperature range, permissible operating temperature -25 to +60 °C
- BM FDC  
for 1 DP/PA coupler Ex [i] or FDC 157-0, for "hot swapping" function, for extended temperature range, permissible operating temperature -25 to +60 °C
- BM FDC/FDC  
for 2 DP/PA couplers FDC 157-0, for "hot swapping" function, for extended temperature range, permissible operating temperature -25 to +60 °C

6AG1195-7HA00-2XA0

6ES7195-7HD80-0XA0

6ES7195-7HF80-0XA0

6ES7195-7HG80-0XA0

##### Mounting rail for hot swapping

For max. 5 active bus modules

- 482 mm wide (19 inches)
- 530 mm wide
- 620 mm wide

6ES7195-1GA00-0XA0

6ES7195-1GF30-0XA0

6ES7195-1GG30-0XA0

##### Covers

4 backplane bus covers and 1 cover for active bus module

6ES7195-1JA00-0XA0

## Overview

The solid-state SIRIUS 3RW44 soft starters are suitable for the torque-controlled soft starting and ramp-down as well as braking of three-phase asynchronous motors.

Optionally, SIRIUS 3RW44 soft starters can be upgraded with a PROFIBUS DP or PROFINET module. Thanks to their communication capability and their programmable control inputs and relay outputs the SIRIUS 3RW44 soft starters can be very easily and quickly integrated in higher-level controllers.

In addition to soft starting and soft ramp-down, the 3RW44 soft starters provide numerous functions for higher-level requirements. They cover a performance range up to 710 kW (at 400 V) in the inline circuit and up to 1200 kW (at 400 V) in the inside-delta circuit.

The 3RW44 soft starters are characterized by a compact design for space-saving and clearly arranged control cabinet layouts. For optimized motor starting and stopping the innovative SIRIUS 3RW44 soft starters are an attractive alternative with considerable savings potential compared to applications with a frequency converter. The new torque control and adjustable current limiting enable the High-Feature soft starters to be used in nearly every conceivable task. They guarantee the reliable avoidance of sudden torque applications and current peaks during motor starting and stopping. This creates savings potential when calculating the size of the switchgear and when servicing the machinery installed. Be it for inline circuits or inside-delta circuits – the SIRIUS 3RW44 soft starter offers savings especially in terms of size and equipment costs.

The bypass contacts already integrated in the soft starter bypass the thyristors after a motor ramp-up is detected. This results in a further great reduction in the heat loss occurring during operation of the soft starter at rated value.

Combinations of various starting, operating and ramp-down possibilities ensure an optimum adaptation to the application-specific requirements. Operation and commissioning can be performed with the user-friendly keypad and a menu-prompted, multi-line graphic display with background lighting. The optimized motor ramp-up and ramp-down can be effected quickly, easily and reliably by means of just a few settings with a previously selected language. Four-key operation and plain-text displays for each menu option guarantee full clarity at every moment of the parameterization and operation.

### Applicable standards

- IEC 60947-4-2
- UL/CSA

### Functionality

Equipped with modern, ergonomic user prompting the 3RW44 soft starters can be commissioned quickly and easily using a keypad and a menu-prompted, multi-line graphic display with background lighting. The optimized motor ramp-up and ramp-down can be effected quickly, easily and reliably by means of just a few settings with a selectable language. Four-key operation and plain-text displays for each menu option guarantee full clarity at every moment of the parameterization and operation. During operation and when control voltage is applied, the display field continuously presents measured values and operating values as well as warnings and fault messages. An external display and operator module can be connected by means of a connection cable to the soft starter, thus enabling active indications and the like to be read directly from the control cabinet door.

The SIRIUS 3RW44 soft starters are equipped with optimum functionality. An integral bypass contact system reduces the power loss of the soft starter during operation.

This reliably prevents heating of the switchgear environment. The SIRIUS 3RW44 soft starters have internal device overload protection. This prevents thermal overloading of the power section's thyristors, e.g. due to unacceptably high closing operations.

Wiring outlay for installing an additional motor overload relay is no longer needed as the SIRIUS 3RW44 soft starters perform this function too. In addition they offer adjustable trip classes and a thermistor motor protection function. As an option the thyristors can also be protected by SITOR semiconductor fuses from short-circuiting so that the soft starter is still functional after a short circuit (type of coordination "2"). And even inrush current peaks are reliably avoided thanks to adjustable current limiting.

In addition a creep speed function is available for positioning and setting jobs. With this function the motor can be controlled in both directions of rotation with reduced torque and an adjustable low speed.

On the other hand the SIRIUS 3RW44 soft starters offer a new, combined DC braking function for the fast stopping of driving loads.

### Highlights

- Soft starting with breakaway pulse, torque control or voltage ramp, adjustable torque or current limiting as well as any combination of these, depending on load type
- Integrated bypass contact system to minimize power loss
- Various setting options for the starting parameters such as starting torque, starting voltage, ramp-up and ramp-down time, and much more in three separate parameter sets
- Start-up detection
- Inside-delta circuit for savings in terms of size and equipment costs
- Various ramp-down modes selectable: free ramp-down, torque-controlled pump stop, combined DC braking
- Solid-state motor overload and intrinsic device protection
- Thermistor motor protection
- Keypad with a menu-prompted, multi-line graphic display with background lighting
- Interface for communication with the PC for more accurate setting of the parameters as well as for control and monitoring
- Simple integration into the motor feeder
- Simple mounting and commissioning
- Display of operating states and fault messages
- Connection to PROFIBUS and PROFINET with optional PROFIBUS DP or PROFINET module
- External display and operator module
- Mains voltages from 200 to 690 V, 50 to 60 Hz
- Can be used up to 60 °C (derating from 40 °C)

## PROFIBUS Soft Starters

### 3RW44 soft starters for High-Feature applications

#### Selection and ordering data

Version		Article No.
 <p data-bbox="130 542 279 559">3RW4900-0KC00</p>	<p data-bbox="379 342 699 363"><b>PROFIBUS communication module</b></p> <p data-bbox="379 372 1085 474">For 3RW44 soft starter integration in the PROFIBUS network with DPV1 slave functionality. With firmware version E04 and higher (or date of manufacture 01.05.2009 and later) of the module, DPV1 operation of the soft starter on a Y-link is also possible (&lt; only DPV0 operation possible with E04).</p>	<p data-bbox="1161 342 1310 363"><b>3RW4900-0KC00</b></p>

#### More information

For more information, refer to Catalog IC 10, Chapter 6 "Switching Devices – Soft Starters and Solid-State Switching Devices", Industry Mall or Interactive Catalog CA 01.



**Overview**

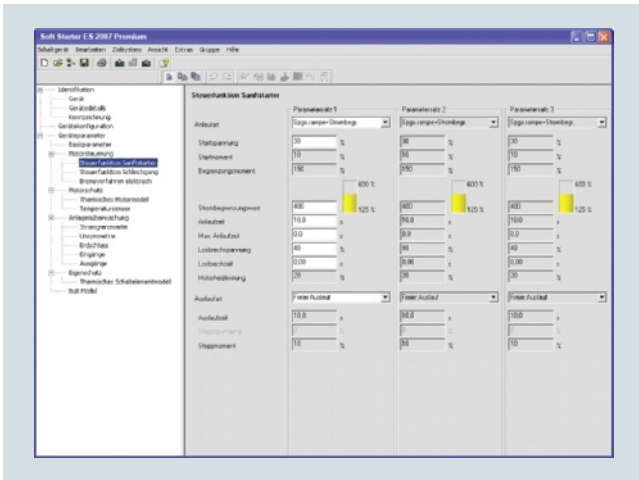

Easy and clearly arranged parameter setting of the 3RW44 soft starter with Soft Starter ES 2007

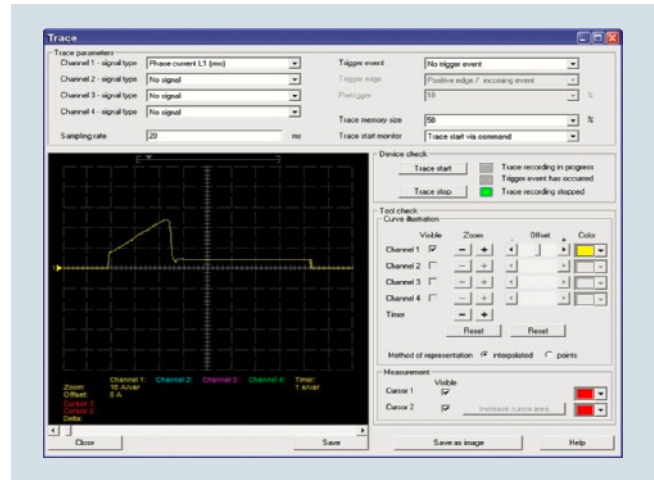

Graphic presentation of measured values with the trace function (oscilloscope function) of Soft Starter ES 2007 Standard and Premium

The Soft Starter ES software permits the quick and easy parameterization, monitoring and diagnostics of SIRIUS 3RW44 High-Feature soft starters for service purposes. The device parameters can be configured directly on the PC and transferred to the soft starter through a serial cable or an optional PROFIBUS/PROFINET interface.

**Efficient engineering with three program versions**

The Soft Starter ES software program is available in three versions which differ in their user-friendliness, scope of functions and price.

Soft Starter ES	Basic	Standard	Premium
Access through the local interface on the device	✓	✓	✓
Parameter assignment	✓	✓	✓
Operating	✓	✓	✓
Diagnostics	✓	✓	✓
Creation of typicals	--	✓ <sup>1)</sup>	✓
Parameter export	--	✓	✓
Comparison functions	--	✓	✓
Standard-compatible printout according to EN ISO 7200	--	✓	✓
Service data (slave pointer, statistics data)	--	✓	✓
Access through PROFIBUS/PROFINET	--	--	✓
Group functions	--	--	✓
Teleservice via MPI	--	--	✓
S7 routing	--	--	✓
STEP 7 Object Manager	--	--	✓

✓ Function available  
-- Function not available

<sup>1)</sup> Typicals with Service Pack 1 and higher.

**Additional functions**

- **Standard-compliant printouts**  
The software tool greatly simplifies machine documentation. It enables parameterization printouts according to EN ISO 7200. The elements to be printed are easy to select and group as required.
- **Easy creation of typicals**  
Typicals can be created for devices and applications with only minimum differences in their parameters. These typicals contain all the parameters which are needed for the parameterization. In addition it is possible to specify which of these parameters are fixed and which can be adapted, e.g. by the startup engineer.
- **Group function**  
For the user-friendly parameterization of numerous devices or applications of the same type, the programs of the SIRIUS ES software family offer a group function which enables the parameterization of several devices to be read out or written through PROFIBUS/PROFINET. In conjunction with typicals it is even possible to selectively adapt the same parameters in any number of parameterizations.
- **Teleservice via MPI**  
The Soft Starter ES Premium version supports the use of MPI Teleservice (comprising the Teleservice software and various Teleservice adapters) for remote diagnostics of the devices. This facilitates diagnostics and maintenance, and it shortens response times for service purposes.

# PROFIBUS

Soft starters  
Software

## Soft Starter ES

### Overview (continued)

#### Types of delivery and license

Soft Starter ES is available as follows:

- Floating license – the license for any one user at any one time
  - Authorizes any one user
  - Independent of the number of installations (unlike the single license which is allowed to be installed once only)
  - Only the actual use of the program has to be licensed
  - Trial license (free use of all program functions for 14 days for test and evaluation purposes, included on every product CD, available in the download file of the SIRIUS ES program in the Service&Support portal).

Following delivery versions are available in addition for Soft Starter ES 2007:

- Upgrade  
Switching from an old to a new version with expanded functions, e.g. upgrade from Soft Starter ES 2006 to Soft Starter ES 2007.
- Powerpack  
Special pack for switching within the same software version to a more powerful version with more functionality, e.g. Powerpack Soft Starter ES 2007 for switching from Standard to Premium.

- Software Update Service  
To keep you up to date at all times we offer a special service which supplies you automatically with all service packs and upgrades.
- License download  
User-friendly license key download from our Mall (for selected countries) as an easy and quick way for you to receive additional licenses for your software.  
For more information see [www.siemens.com/tia-online-software-delivery](http://www.siemens.com/tia-online-software-delivery).

#### Licensing procedure

To make licensing easier, the three versions of Soft Starter ES are available with the following license:

14 day trial license for Premium functions:  
For test and evaluation purposes, included on every product CD, available also in the download file of the SIRIUS Soft Starter ES 2007 program in the Service&Support portal.

#### System requirements

Soft Starter ES 2007 parameterization, start-up and diagnostics software for SIRIUS 3RW44 soft starters	Basic/Standard	Premium
	Product version $\geq$ *E04* <sup>1)</sup>	Product version $\geq$ *E06* <sup>2)</sup>
Operating system	Windows XP Professional (Service Pack 2 or 3), Windows 7 32/64-bit Professional/Ultimate/Enterprise (Service Pack 1)	
Processor	$\geq$ Pentium 800 MHz/ $\geq$ 1 GHz (Windows 7)	
RAM	$\geq$ 512 MB (Windows XP Professional)/ $\geq$ 1 GB (Windows 7 32-bit)/ $\geq$ 2 GB (Windows 7 64-bit)	
Free space on hard disk	$\geq$ 150 MB	
CD-ROM/DVD drive	Yes (only when installing from CD)	
Interface	Depends on PC cable: serial (COM) or USB	
PC cable/parameterization cable/connection cable	Yes	--
PROFIBUS/PROFINET communication module (optional)	--	Yes

<sup>1)</sup> SIRIUS 3RW44 with product version  $\geq$  \*E04\*. Installed in starters delivered after December 2005.

<sup>2)</sup> SIRIUS 3RW44 with product version  $\geq$  \*E06\*. Installed in starters delivered after May 2006.

#### Benefits

- Transparent setting of the device functions and their parameters – online and offline
- Effective diagnostics functions on the soft starter and display of the most important measured values
- Trace function (oscilloscope function) for recording measured values and events (in the Soft Starter ES Standard and Premium versions)
- Complete transparency thanks to printout, logbook and event memory
- High degree of user-friendliness – convenient user interface, with German, English and French as possible operating languages
- Time savings through shorter startup times
- Fast, low-cost licensing using a simple licensing procedure (available online too)

**Selection and ordering data**
**Soft Starter ES parameterization and service software for SIRIUS 3RW44 soft starters**

- Delivered without PC cable

Version	Article No.
<b>Soft Starter ES 2007 Basic</b>	
 <p><b>Floating license for one user</b>            Engineering software in limited-function version for diagnostics purposes, software and documentation on CD, 3 languages (German/English/French), communication through system interface</p> <ul style="list-style-type: none"> <li>• License key on USB stick, Class A, including CD</li> <li>• License key download, Class A, without CD</li> </ul>	<b>3ZS1313-4CC10-0YA5</b> <b>3ZS1313-4CE10-0YB5</b>
<b>Soft Starter ES 2007 Standard</b>	
<p><b>Floating license for one user</b>            Engineering software, software and documentation on CD, 3 languages (German/English/French), communication through system interface</p> <ul style="list-style-type: none"> <li>• License key on USB stick, Class A, including CD</li> <li>• License key download, Class A, without CD</li> </ul>	<b>3ZS1313-5CC10-0YA5</b> <b>3ZS1313-5CE10-0YB5</b>
<p><b>Upgrade for Soft Starter ES 2006</b>            Floating license for one user, engineering software, software and documentation on CD, license key on USB stick, Class A, 3 languages (German/English/French), communication through system interface</p>	<b>3ZS1313-5CC10-0YE5</b>
<p><b>Powerpack for Soft Starter ES 2007 Basic</b>            Floating license for one user, engineering software, license key on USB stick, Class A, 3 languages (German/English/French), communication through system interface</p>	<b>3ZS1313-5CC10-0YD5</b>
<p><b>Software Update Service</b>            For 1 year with automatic extension, assuming the current software version is in use, engineering software, software and documentation on CD, communication through system interface</p>	<b>3ZS1313-5CC10-0YL5</b>
<b>Soft Starter ES 2007 Premium</b>	
<p><b>Floating license for one user</b>            Engineering software, software and documentation on CD, 3 languages (German/English/French), communication through system interface or PROFIBUS/PROFINET, STEP7 Object Manager</p> <ul style="list-style-type: none"> <li>• License key on USB stick, Class A, including CD</li> <li>• License key download, Class A, without CD</li> </ul>	<b>3ZS1313-6CC10-0YA5</b> <b>3ZS1313-6CE10-0YB5</b>
<p><b>Upgrade for Soft Starter ES 2006</b>            Floating license for one user, engineering software, software and documentation on CD, license key on USB stick, Class A, 3 languages (German/English/French), communication through system interface or PROFIBUS/PROFINET, STEP7 Object Manager</p>	<b>3ZS1313-6CC10-0YE5</b>
<p><b>Powerpack for Soft Starter ES 2007 Standard</b>            Floating license for one user, engineering software, license key on USB stick, Class A, 3 languages (German/English/French), communication through system interface or PROFIBUS/PROFINET, STEP7 Object Manager</p>	<b>3ZS1313-6CC10-0YD5</b>
<p><b>Software Update Service</b>            For 1 year with automatic extension, assuming the current software version is in use, engineering software, software and documentation on CD, communication through system interface or PROFIBUS/PROFINET, STEP7 Object Manager</p>	<b>3ZS1313-6CC10-0YL5</b>

**Notes:**

Please order PC cable separately, see page 3/266.



For description of the software versions see page 3/263.

**PROFIBUS**

Soft starters

Software

**Soft Starter ES****Accessories**

	Version	Article No.
<i>Optional accessories</i>		
 <p data-bbox="130 542 295 563">3UF7940-0AA00-0</p>	<p data-bbox="375 378 534 400"><b>RS 232 PC cables</b></p> <p data-bbox="375 404 941 451">For connecting to the serial interface of a PC/PG, for communication with Soft Starter ES through the system interface</p>	<p data-bbox="1157 378 1316 400"><b>3UF7940-0AA00-0</b></p>
 <p data-bbox="130 542 295 563">3UF7941-0AA00-0</p>	<p data-bbox="375 485 518 506"><b>USB PC cables</b></p> <p data-bbox="375 510 941 557">For connecting to the USB interface of a PC/PG, for communication with Soft Starter ES through the system interface</p>	<p data-bbox="1157 485 1316 506"><b>3UF7941-0AA00-0</b></p>
 <p data-bbox="130 670 295 691">3UF7946-0AA00-0</p>	<p data-bbox="375 591 550 612"><b>USB/serial adapters</b></p> <p data-bbox="375 617 925 663">For connecting an RS 232 PC cable to the USB interface of a PC, use recommended in conjunction with Soft Starter ES</p>	<p data-bbox="1157 591 1316 612"><b>3UF7946-0AA00-0</b></p>
	<p data-bbox="375 697 933 719"><b>Optional PROFIBUS communication module for SIRIUS 3RW44</b></p>	<p data-bbox="1157 697 1300 719"><b>3RW4900-0KC00</b></p>
	<p data-bbox="375 804 933 825"><b>Optional PROFINET communication module for SIRIUS 3RW44</b></p>	<p data-bbox="1157 804 1300 825"><b>3RW4900-0NC00</b></p>

3

## Overview

The SIRIUS 3RW44 Soft Starter PCS 7 block library can be used for simple and easy integration of SIRIUS 3RW44 soft starters into the SIMATIC PCS 7 process control system. The SIRIUS 3RW44 Soft Starter PCS 7 block library contains the diagnostics and driver blocks corresponding with the SIMATIC PCS 7 diagnostics and driver concept as well as the elements (symbols and faceplates) required for operator control and process monitoring.

### **Integrated functionality for optimal process control for all process control systems**

In addition to the general sensor technology, the motor feeder data is increasingly being integrated into the process control system. By integrating the SIRIUS 3RW44 soft starters into the process control system it becomes possible to prevent errors in the motor feeder simply and reliably, or to detect these errors quickly and rectify them. Downtimes are reduced to a minimum or can be prevented before they happen.

For example, the output and display of the key measured values calculated by the 3RW44 is also a good aid for being able to assess and monitor the current system status.

### **Easy integration with the PCS 7 block library**

The PCS 7 block library can be used for simple and easy integration of SIRIUS 3RW44 soft starters into the SIMATIC PCS 7 process control system. The focus here is simple configuration. The function of the blocks is based on the PCS 7 standard libraries and is optimally harmonized with the functions of the SIRIUS 3RW44.

Users who have previously integrated conventional motor feeders via signal blocks and motor or valve blocks or, for example, already have experience with SIMOCODE blocks, are easily able to switch to SIRIUS 3RW44.

All blocks required for the automation systems are provided by the PCS 7 block library – as are the block symbols and faceplates for the operator station required for monitoring and control.

With the integration of the SIRIUS 3RW44 into SIMATIC PDM, the system-wide device parameterization and diagnostics of the SIRIUS 3RW44 soft starters are possible from a central point.

### **Motor block for the direct control of the drive**

The low-voltage motors started and protected by SIRIUS 3RW44 soft starters can be integrated into the process automation via the motor blocks. This means that they form the interface between the process control system and the motors controlled by the SIRIUS 3RW44.

To reduce the amount of configuring work required, functions for signal processing and technological functions are integrated into one motor block.

The important measured value – the current in the motor feeder – is recorded via the 3RW44 and monitored for motor protection. The motor current is accessible from the I&C system via the motor blocks.

The block symbols and faceplates for the motor blocks display the motor feeders on the operator station and provide all the required information for monitoring and control as well as detailed diagnostics.

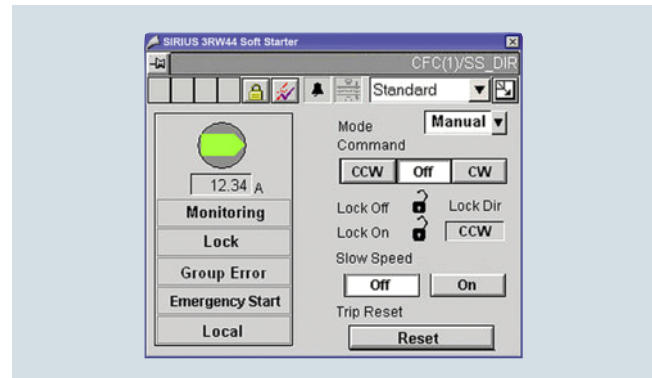

Faceplate of the motor block

### **Evaluation of additional motor feeder measurements**

All measured values calculated by the soft starter, such as current, voltage and output of the feeder, are displayed and output via the measured value blocks. A key advantage here is that where required, a wide range of information on important motor feeder measurements is available, e.g. for load monitoring.

The 3RW44 is not only able to detect measured values here, but also to react if these values are exceeded or undershot, for example, via custom settings – e.g. with a motor disconnection or with a warning.

The faceplate for the measured values is accessed from the motor block faceplate.

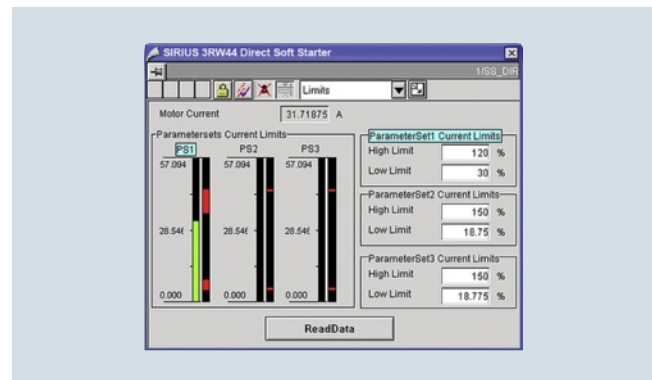

Faceplate for measured values

### **Evaluation of maintenance-related motor feeder data**

The 3RW44 has powerful functions to detect and monitor maintenance-related motor feeder data. For example, the operating and downtimes of the motor, operating cycles and overload tripping events are detected and stored directly on the device. If required, the information already on the device is available via the statistics block in the I&C system. The display is provided on a separate faceplate for the statistics block on the operator station.

### **Types of delivery and license**

The SIRIUS 3RW44 soft starter PCS 7 block library supplied on CD-ROM allows the user to run the required engineering software on the engineering station (single license) including the runtime software for executing the AS blocks in an automation system (single license). If the AS blocks are to be used in additional automation systems, the corresponding number of runtime licenses are required which are supplied without a data carrier.

**PROFIBUS**

Soft starters

Software

**SIRIUS 3RW44 Soft Starter block library for SIMATIC PCS 7****Benefits**

- Uniform and continuous integration into SIMATIC PCS 7
- Standardized blocks for simple integration and optimal operation
- Including Advanced Process Library (APL) in Version V8
- Greater process transparency due to greater information density in the process control system
- System-wide device parameterization and diagnostics with SIMATIC PDM

**Selection and ordering data**

Version	Article No.
<p><i>SIRIUS 3RW44 soft starter block library for SIMATIC PCS 7, Version V8 with Advanced Process Library (APL)</i></p>  <p><b>Engineering software V8</b> For one engineering station (single license) including runtime software for execution of the AS blocks in an automation system (single license), German/English Scope of supply: AS blocks and faceplates for integrating SIRIUS 3RW44 into the PCS 7 process control system with Advanced Process Library, for PCS 7 version V8.0 Type of delivery: Software and documentation on CD, one license for one engineering station, one license for one automation system</p>	<b>3ZS1633-1XX02-0YA0</b>
<p><b>Runtime license V8</b> for execution of the AS blocks in an automation system (single license) Required for using the AS blocks of the engineering software V8 on an additional automation system within a plant Type of delivery: One license for one automation system, without software and documentation</p>	<b>3ZS1633-2XX02-0YB0</b>
<p><b>Upgrade for SIRIUS 3RW44 PCS 7 block library, V6.0 or V7 to version SIRIUS 3RW44 V8</b> For one engineering station (single license) including runtime software for execution of the AS blocks in an automation system (single license), German/English Scope of supply: AS blocks and faceplates for integrating SIRIUS 3RW44 into the PCS 7 process control system with Advanced Process Library for PCS 7 version V8.0 Type of delivery: Software and documentation on CD, one license for one engineering station, one license for one automation system</p>	<b>3ZS1633-1XX02-0YE0</b>

3ZS1633-1XX02-0YA0

3

**Selection and ordering data** (continued)

	Version	Article No.
<b>SIRIUS 3RW44 soft starter block library for SIMATIC PCS 7 Version V7</b>		
 3ZS1633-1XX00-0YA0	<b>Engineering software V7</b> For one engineering station (single license) including runtime software for execution of the AS blocks in an automation system (single license), German/English Scope of supply: AS blocks and faceplates for integrating SIRIUS 3RW44 into the PCS 7 process control system, for PCS 7 version V6.1/V7.0/V7.1 <sup>1)</sup> Type of delivery: Software and documentation on CD, one license for one engineering station, one license for one automation system	<b>3ZS1633-1XX00-0YA0</b>
	<b>Runtime license V7</b> For execution of the AS blocks in an automation system (single license) Required for using the AS blocks of the engineering software V7 or the engineering software migration V7-V8 on an additional automation system within a plant Type of delivery: One license for one automation system, without software and documentation	<b>3ZS1633-2XX00-0YB0</b>
	<b>Engineering software migration V7-V8</b> For upgrading (migrating) an existing engineering software V6.1/V7.0/V7.1 of the SIRIUS 3RW44 soft starter block library for PCS 7 Conditions of use: Availability of the engineering software V7 (license) of the SIRIUS 3RW44 soft starter block library for PCS 7 for the PCS 7 version V6.1, V7.0 or V7.1 The engineering software migration V7-V8 can be installed directly onto a system with PCS 7 version V8.0; installation of the previous version is unnecessary. For one engineering station (single license) including runtime software for execution of the AS blocks in an automation system (single license), German/English Scope of supply: AS blocks and faceplates for integrating SIRIUS 3RW44 soft starters into the PCS 7 process control system, for PCS 7 version V8.0 Type of delivery: Software and documentation on CD, license for upgrading an existing license for one engineering station and a plant's assigned runtime licenses	<b>3ZS1633-1XX10-0YE0</b>

<sup>1)</sup> For earlier versions of the engineering software, SP1 can be downloaded from [www.siemens.com/sirius-engineering](http://www.siemens.com/sirius-engineering).

**More information**

For Programming and Operating Manual for PCS 7 Block Library for SIRIUS Soft Starter 3RW44 V6.1/V7.0 + SP2 see <http://support.automation.siemens.com/WW/view/en/41856585>.

For Getting Started for PCS 7 Block Library for SIRIUS 3RW44 Soft Starter V6.1/V7.0 + SP2 see <http://support.automation.siemens.com/WW/view/en/41856498>.

**Note:**

Programming Manual and GETTING STARTED are valid for engineering software V7 and engineering software migration V7-V8.

## PROFIBUS

### Motor starters for use in the field, high degree of protection

#### M200D motor starters for PROFIBUS

##### Overview

The intelligent, highly flexible M200D PROFIBUS/PROFINET motor starters have the broadest range of functions of all products in the SIRIUS motor starter family in the high degree of protection IP65 for PROFIBUS/PROFINET communication.

They start and protect motors and loads up to 5.5 kW. Direct-on-line and reversing starter variants are available in a mechanical version and also an electronic version (the latter with soft start function).

The particularly robust M200D PROFIBUS/PROFINET motor starters are characterized by numerous functions which can be flexibly parameterized. Their modular design comprises a motor starter module and a communication module.

The M200D PROFINET motor starters enable TIA-integrated parameterization through PROFINET from STEP 7 – in familiar, user-friendly manner with the same look-and-feel as PROFIBUS.

##### Functionality

- Basic functionality see Chapter 4 "AS-Interface" → "M200D Motor Starters" → "General Data" → "Overview"
- Electronic version also with soft start function
- Robust and widely used M12 connection method for the digital inputs and outputs and the PROFIBUS/PROFINET bus connection
- All four digital inputs and two digital outputs also exist in the cyclic process image. This provides complete transparency of the process on the control level
- Full TIA integration: All digital inputs and outputs exist in the cyclic process image and are visible through the bus, providing maximum flexibility and excellent adaptability to the application
- Flexible assignment of the digital inputs and outputs with all available assignable input actions
- Extensive diagnostics concept using LEDs and through the bus with the TIA-compatible mechanisms
- Expanded diagnostics using data records
- Complete plant monitoring using statistics data record and current value monitoring by means of data records
- Parameterization through PROFIBUS/PROFINET bus with the help of data records from the user program
- Control of the motor starter using a command data record from the user program
- Removable modular control unit – quicker device replacement and therefore lower costs when device outages occur – since existing wiring is on the control unit and only one device needs to be replaced
- Parameterization in STEP 7 HW Config using Motor Starter ES (ordering option for start-up software)
- Start-up and diagnostics with the help of Motor Starter ES (ordering option for start-up software)
- Trace function through Motor Starter ES for optimized start-up and tracking of process and device values



M200D motor starter modules for PROFIBUS/PROFINET (without communication module)



M200D communication modules for PROFIBUS

##### Mounting and installation

The M200D PROFIBUS/PROFINET motor starter is comprised of a communication module and a motor starter module. Only the motor starter module has to be replaced therefore when replacing devices. This saves time and money. The communication module remains as an active station on the bus and all other system components continue running. This prevents downtimes.

The integrated plug-in technology enables far lower wiring outlay: Connecting cables can be plugged directly onto the motor starter module. The PROFINET bus is connected cost-effectively using an M12 connection on the device. All versions have identical enclosure dimensions for easier system design and conversion.



**Overview** (continued)Parameterization and configuration

All motor protection functions, limit values and reactions can be defined by parameterization.

The user has several user-friendly options for the parameterization. In addition to parameterization directly from STEP 7, which also permits automatic re-parameterization in case of device replacement, it is possible to use the user-friendly Motor Starter ES start-up software. By connecting a programming device directly to PROFIBUS/PROFINET and the Motor Starter ES start-up software, the devices can also be conveniently programmed from a central point through the bus. Also, parameters can be changed during operation from the user program using the data record

mechanism so that the function of the motor starter is adapted to the process when required. With the help of a PC and the Motor Starter ES software it is also possible to perform the parameterization through the local point-to-point interface on-site.

Functions can be flexibly assigned to the digital inputs and outputs, adapting them to all possible conveyor applications. All digital inputs and outputs exist in the cyclic process image. All limit values for monitoring functions and their reactions are parameterizable and therefore adaptable to the application. Consistency with other products of the SIRIUS M200D motor starter range and with the frequency converter and ET 200pro peripherals system is assured.



SIRIUS M200D  
PROFIBUS



SIRIUS M200D  
PROFINET

**Device functions (firmware features)****Slave on the bus**

Fieldbus	✓ PROFIBUS to M12	✓ PROFINET to M12
Adjustable number of stations	✓ 1 ... 125	✓ 1 ... 128 with CPU 315, CPU 317 1 ... 1 256 with CPU 319

**Parameterization**

DIP switches	✓ For address setting and terminating resistor	--
Motor Starter ES	✓ Through bus, optical interface	
PROFIBUS/PROFINET data records	✓	
From STEP 7 / HW Config	✓	

**Diagnostics**

Acyclic through data records	✓
Diagnostic interrupt support	✓

**Process image**

Process image	✓ 2Byte PII/ 2Byte PIQ
---------------	------------------------

**Data channels**

Local optical interface (manual local)	✓
Through Motor Starter ES local interface	✓
Using Motor Starter ES through bus	✓

**Data records (acyclic)**

Parameterization	✓ Using DS 131 (DS = data record)	
Diagnostics	✓ Device-specific DS 92	
Measured values	✓ Measured values DS 94	
Statistics	✓ Statistical data DS 95	
Commands	✓ Using DS 93	
Slave pointer	✓ Slave pointer DS 96	
Logbook	✓ Using Motor Starter ES and data records: Device faults DS 72, tripping operations DS 73, events DS 75	
Device identification	✓ Using DS 100	
I&M data	✓ Using DS 231 ... 234	✓ Using data records 0xAFF0 ... 0xAFF3

**Inputs**

Number	✓ 4
• Of which in the process image	✓ 4
Input action	✓ Parameterizable: flexibly assignable action, see manual
Quick stop	✓ Parameterizable: latching, non-latching

✓ Function available

-- Function not available

## PROFIBUS

Motor starters for use in the field, high degree of protection

### M200D motor starters for PROFIBUS

#### Overview (continued)



SIRIUS M200D  
PROFIBUS



SIRIUS M200D  
PROFINET

#### Device functions (firmware features)

##### Outputs

Number	✓ 2
• Of which in the process image	✓ 2
Output action	✓ Parameterizable: flexibly assignable action, see manual

##### Brake output

180 V DC / 230/400 V AC / none

✓

##### Motor protection

Overload protection	✓ Electronic, wide range 1:10
Short-circuit protection	✓
Full motor protection	✓
Temperature sensor	✓ Parameterizable using Motor Starter ES, data record: PTC or Thermoclick or deactivated

##### Device function

Repair switch	✓
Lower current limit monitoring	✓ Parameterizable
Upper current limit monitoring	✓ Parameterizable
Zero current detection	✓ Parameterizable: tripping, warning
Blocking current	✓ Parameterizable
Unbalance	✓ Parameterizable
Load type	✓ Parameterizable: 1 and 3-phase
Tripping class	✓ Parameterizable using Motor Starter ES, data record: CLASS 5, 10, 15, 20
Protection against voltage failure	✓ Parameterizable: activated/deactivated

##### Support for PROFlenergy profile

Switching during dead times	--	✓
Measured motor current values	--	✓

##### Soft starter control function

Soft start function	✓
Bypass function	✓ Only solid-state version

✓ Function available

-- Function not available

#### Application

The M200D PROFIBUS/PROFINET motor starters are particularly suitable for fully TIA-integrated, highly automated conveyor applications which meet all needs with regard to the monitoring of devices and systems and preventative maintenance.

Adaptability of the motor starter functions and maximum flexibility of the device enable a broad range of applications without any limits. The PROFINET-specific expansions are the best assurance of a future-proof investment.

**Selection and ordering data**



M200D motor starter module  
M200D PROFIBUS  
(without communication module)

PROFIBUS/PROFINET  
motor starter

Version	Article No.
<i>M200D communication modules for PROFIBUS</i>	
<b>Communication modules for PROFIBUS</b> M12 termination 7/8"	3RK1305-0AS01-0AA0
<i>M200D PROFIBUS/PROFINET motor starter modules</i> <i>Electromechanical starters (with integrated contactor)</i>	3RK1395-6 ■ S41- ■ AD ■
<b>Setting range for rated operational current / A</b> • 0.15 ... 2 • 1.5 ... 12	K L
<b>Direct-on-line starters/reversing starters</b> • Direct-on-line starters • Reversing starters • Direct-on-line starters with manual local operation • Reversing starters with manual local operation	0 1 2 3
<b>Brake actuation</b> • Without brake actuation • Brake actuation (230/400 V AC) • Brake actuation (180 V DC)	0 3 5

Version	Article No.
<i>Electronic starters (with thyristors)</i>	3RK1395-6 ■ S71- ■ AD ■
<b>Setting range for rated operational current / A</b> • 0.15 ... 2 • 1.5 ... 12	K L
<b>Direct-on-line starters/reversing starters</b> • Direct-on-line starters • Reversing starters • Direct-on-line starters with manual local operation • Reversing starters with manual local operation	0 1 2 3
<b>Brake actuation</b> • Without brake actuation • Brake actuation (230/400 V AC) • Brake actuation (180 V DC)	0 3 5

## PROFIBUS

Motor starters for use in the field, high degree of protection

### M200D motor starters for PROFIBUS

M200D motor starters for PROFIBUS > Accessories



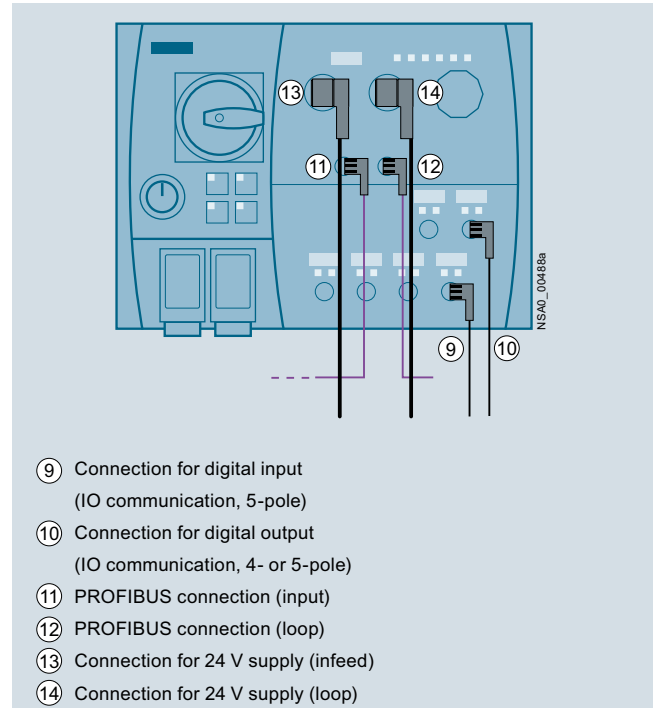

#### Overview

For accessories for all SIRIUS M200D motor starters (irrespective of the communication connection) see Chapter 4 "AS-Interface" ⇒ "SIRIUS M200D Motor Starters" ⇒ "Accessories"







Communication connection using PROFIBUS and digital inputs and outputs

#### Selection and ordering data

Version	Article No.
<b>Motor control with PROFIBUS</b>	
 <p><b>M12 plugs, angled</b> Screw fixing, 5-pole screw terminals, max. 0.75 mm<sup>2</sup>, B-coded, no terminating resistor</p> <ul style="list-style-type: none"> <li>⑪ 5 female contacts</li> </ul> <p>3RK1902-1DA00</p>	<p><b>3RK1902-1DA00</b></p> <p><b>3RK902-1BA00</b></p>
 <ul style="list-style-type: none"> <li>⑫ 5 male contacts</li> </ul> <p>3RK1902-1BA00</p>	
 <p><b>Control cables, assembled at one end</b> M12, screw fixing, angular, B coded, no terminating resistor</p> <ul style="list-style-type: none"> <li>⑪ 5 female contacts, 3 m</li> <li>⑫ 5 female contacts, 5 m</li> <li>⑬ 5 female contacts, 10 m</li> </ul> <p>3RK1902-1G.</p>	<p><b>3RK1902-1GB30</b></p> <p><b>3RK1902-1GB50</b></p> <p><b>3RK1902-1GC10</b></p>
 <p><b>⑪ ⑫ Control cables, assembled at both ends</b> M12, screw fixing, angular, pin/socket 5-pole, B-coded, no terminating resistor</p> <ul style="list-style-type: none"> <li>• 3.0 m</li> <li>• 5.0 m</li> <li>• 10.0 m</li> </ul> <p>3RK1902-1N.</p>	<p><b>3RK1902-1NB30</b></p> <p><b>3RK1902-1NB50</b></p> <p><b>3RK1902-1NC10</b></p>

## Selection and ordering data (continued)

Version	Article No.	
<b>Further accessories</b>		
<b>PROFIBUS trailing cables</b> Max. acceleration 4 m/s <sup>2</sup> , at least 3 000 000 bending cycles, bending radius at least 60 mm, 2-core, shielded, sold by the meter, minimum order quantity 20 m, maximum order quantity 1 000 m	6XV1830-3EH10	
<b>PROFIBUS FC Food bus cables</b> With PE outer sheath for operation in the food and beverage industry, 2-core, shielded, sold by the meter, minimum order quantity 20 m, maximum order quantity 1 000 m	6XV1830-0GH10	
<b>PROFIBUS FC Robust bus cables</b> With PUR outer sheath for operation in environments exposed to chemicals and mechanical loads, 2-core, shielded, sold by the meter, minimum order quantity 20 m, maximum order quantity 1 000 m	6XV1830-0JH10	
<b>Power cables</b> 5-core, 5 x 1.5 mm <sup>2</sup> , trailing, sold by the meter, minimum order quantity 20 m, maximum order quantity 1 000 m	6XV1830-8AH10	
<b>Connection for 24 V power supply of the M200D PROFIBUS/PROFINET</b>		
 3RK1902-3DA00	<b>Plugs</b> On M200D, 7/8" for screw fixing, angular, screw terminal, 1.5 mm <sup>2</sup> <ul style="list-style-type: none"> <li>Ⓜ 5 female contacts</li> </ul>	
 3RK1902-3BA00		<ul style="list-style-type: none"> <li>Ⓜ 5 male contacts</li> </ul>
 3RK1902-3G.	<b>Ⓜ Supply lines, assembled at one end</b> 7/8" for screw fixing, angular, 1.5 mm <sup>2</sup> <ul style="list-style-type: none"> <li>• 5 female contacts, 3 m</li> <li>• 5 female contacts, 5 m</li> <li>• 5 female contacts, 10 m</li> </ul>	3RK1902-3GB30 3RK1902-3GB50 3RK1902-3GC10
 3RK1902-3N.	<b>Ⓜ Ⓜ Supply lines, assembled at both ends</b> 7/8" for screw fixing, angular at both ends, 5-pole pin/socket, 1.5 mm <sup>2</sup> <ul style="list-style-type: none"> <li>• 3 m</li> <li>• 5 m</li> <li>• 10 m</li> </ul>	3RK1902-3NB30 3RK1902-3NB50 3RK1902-3NC10
 6ES7194-3JA00-0AA0	<b>7/8" sealing caps</b> 1 pack = 10 units	6ES7194-3JA00-0AA0

## PROFIBUS

Motor starters for use in the field, high degree of protection  
Software

### Motor Starter ES

#### Overview

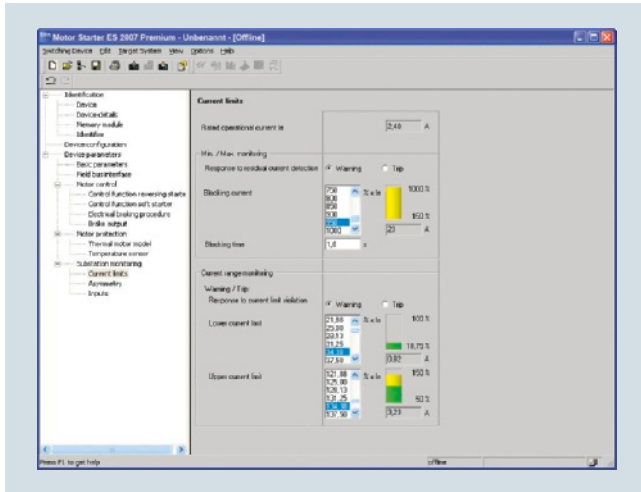

Motor Starter ES for parameterization, monitoring, diagnostics and testing of motor starters

Motor Starter ES is used for start-up, parameterization, diagnostics, documentation and the preventative maintenance of the motor starters in the SIMATIC ET 200S, ET 200pro, ECOFAST and M200D product families.

Interfacing is performed

- Through the local interface on the device
- With PROFIBUS DP V1 capable motor starters from any point in PROFIBUS or in PROFINET (applies to ET 200S DP V1/ ET 200pro/ECOFAST/M200D)
- with PROFINET-capable motor starters from any point in PROFINET or in PROFIBUS (applies to ET 200S DP V1, ET 200pro/M200D)

Using Motor Starter ES, the communication-capable motor starters are easily parameterized during start-up, monitored during normal operation and successfully diagnosed for service purposes. Preventative maintenance is supported by a function for reading out diverse statistical data (e. g. operating hours, operating cycles, cut-off currents, etc.). The user is supported during these procedures with comprehensive Help functions and plain text displays.

Motor Starter ES can either be used as a stand-alone program or it can be integrated into STEP 7 via an Object Manager.

#### Efficient engineering with three program versions

The Motor Starter ES software program is available in three versions which differ in their user-friendliness, scope of functions and price.

Motor Starter ES	Basic	Standard	Premium
ET 200S High-Feature PROFIBUS IM	✓	✓	✓
ET 200S High-Feature PROFINET IM	✓	✓	✓
ECOFAST AS-Interface High-Feature	✓	✓	--
ECOFAST PROFIBUS	✓	✓	✓
ET 200pro PROFIBUS IM	✓	✓	✓
ET 200pro PROFINET IM	✓	✓	✓
M200D AS-Interface Standard	✓	✓	(✓)
M200D PROFIBUS	✓	✓	✓
M200D PROFINET	✓	✓	✓

- ✓ Function available, (✓) available with restricted functionality
- Function not available

Motor Starter ES	Basic	Standard	Premium
Access through the local interface on the device	✓	✓	✓
Parameter assignment	✓	✓	✓
Operating	✓	✓	✓
Diagnostics	--	✓	✓
Creation of typicals	--	✓	✓
Comparison functions	--	✓	✓
Standard-compliant printout according to EN ISO 7200	--	✓	✓
Service data (slave pointer, statistics data)	--	✓	✓
Access via PROFIBUS	--	--	✓
Access via PROFINET	--	--	✓
S7 routing	--	--	✓
Teleservice via MPI	--	--	✓
STEP 7 Object Manager	--	--	✓
Trace function	--	✓	✓

- ✓ Function available
- Function not available

#### Additional functions

- Standard-compliant printouts  
The software tool greatly simplifies machine documentation. It enables parameterization printouts according to EN ISO 7200. The elements to be printed are easy to select and group as required.
- Easy creation of typicals  
Typicals can be created for devices and applications with only minimum differences in their parameters. These typicals contain all the parameters which are needed for the parameterization. In addition it is possible to specify which of these parameters are fixed and which can be adapted, e.g. by the startup engineer.
- Teleservice via MPI  
The Motor Starter ES Premium version supports the use of MPI Teleservice (comprising the Teleservice software and various Teleservice adapters) for remote diagnostics of the devices. This facilitates diagnostics and maintenance, and it shortens response times for service purposes.

**Overview** (continued)**Types of delivery and license**

Motor Starter ES is available as follows:

- Floating license – the license for any one user at any one time
  - Authorizes any one user
  - Independent of the number of installations (unlike the single license which is allowed to be installed once only)
  - Only the actual use of the program has to be licensed
  - Trial license (free use of all program functions for 14 days for test and evaluation purposes, included on every product CD, available in the download file of the SIRIUS ES program in the Service&Support portal)

Following delivery versions are also available for Motor Starter ES 2007:

- Upgrade  
Switching from an old to a new version with expanded functions, e.g. upgrade from Motor Starter ES 2006 to Motor Starter ES 2007.
- Powerpack  
Special pack for switching within the same software version to a more powerful version with more functionality, e.g. Powerpack Motor Starter ES 2007 for switching from Standard to Premium.
- Software Update Service  
To keep you up to date at all times we offer a special service which supplies you automatically with all service packs and upgrades.
- License download  
User-friendly license key download from our Mall (for selected countries) as an easy and quick way for you to receive additional licenses for your software.  
For more information see [www.siemens.com/tia-online-software-delivery](http://www.siemens.com/tia-online-software-delivery).

**System requirements**

<b>Parameterization, start-up and diagnostics software Motor Starter ES 2007</b>	For ECOFAST motor starters, SIMATIC ET 200S High-Feature starters, SIMATIC ET 200pro starters, and M200D (AS-I standard, PROFIBUS, PROFINET)
<b>Operating system</b>	Windows XP Professional (Service Pack 2 or 3) Windows 7 32/64-bit Professional/Ultimate/Enterprise (Service Pack 1)
<b>Processor</b>	≥ Pentium 800 MHz/≥ 1 GHz (Windows 7)
<b>RAM</b>	≥ 512 MB (Windows XP Professional)/≥ 1 GB (Windows 7 32-bit)/ ≥ 2 GB (Windows 7 64-bit)
<b>Monitor resolution</b>	≥ 1 024 x 768
<b>Free space on hard disk<sup>1)</sup></b>	≥ 400 MB
<b>CD-ROM/DVD drive</b>	Yes (only when installing from CD)
<b>Interface</b>	Depends on PC cable: serial (COM) or USB
<b>PC cable/parameterization cable/connection cable</b>	Yes
<b>PROFIBUS card/PROFIBUS processor</b>	Optional, for parameterization and diagnostics through PROFIBUS
<b>Ethernet interface/PROFINET card</b>	Optional, for parameterization and diagnostics through PROFINET

<sup>1)</sup> Additional free space recommended, e.g. for swap-out file.

**Benefits**

- Fast, error-free configuration and startup of motor starters even without extensive previous knowledge
- Transparent setting of the device functions and their parameters – online and offline
- Effective diagnostics functions on the soft starter and display of the most important measured values
- Trace function (oscilloscope function) for recording measured values and events (included in the Motor Starter ES Standard and Premium software versions for M200D PROFIBUS and PROFINET).

## PROFIBUS

Motor starters for use in the field, high degree of protection  
Software

### Motor Starter ES

#### Selection and ordering data

##### Parameterization, start-up and diagnostics software Motor Starter ES 2007

For ECOFAST motor starters, SIMATIC ET 200S  
High-Feature starters, SIMATIC ET 200pro starters,  
and M200D (AS-I standard, PROFIBUS, PROFINET)

Version	Article No.
<b>Motor Starter ES 2007 Basic</b>	
 <p><b>Floating license for one user</b> Engineering software in limited-function version for diagnostics purposes, software and documentation on CD, 3 languages (German/English/French), communication through system interface</p> <ul style="list-style-type: none"> <li>• License key on USB stick, Class A, including CD</li> <li>• License key download, Class A, without CD</li> </ul>	<p><b>3ZS1310-4CC10-0YA5</b> <b>3ZS1310-4CE10-0YB5</b></p>
<b>Motor Starter ES 2007 Standard</b>	
<p><b>Floating license for one user</b> Engineering software, software and documentation on CD, 3 languages (German/English/French), communication through system interface</p> <ul style="list-style-type: none"> <li>• License key on USB stick, Class A, including CD</li> <li>• License key download, Class A, without CD</li> </ul>	<p><b>3ZS1310-5CC10-0YA5</b> <b>3ZS1310-5CE10-0YB5</b></p>
<p><b>Upgrade for Motor Starter ES 2006</b> Floating license for one user, engineering software, software and documentation on CD, license key on USB stick, Class A, 3 languages (German/English/French), communication through system interface</p>	<b>3ZS1310-5CC10-0YE5</b>
<p><b>Powerpack for Motor Starter ES 2007 Basic</b> Floating license for one user, engineering software, license key on USB stick, Class A, 3 languages (German/English/French), communication through system interface</p>	<b>3ZS1310-5CC10-0YD5</b>
<p><b>Software Update Service</b> For 1 year with automatic extension, assuming the current software version is in use, engineering software, software and documentation on CD, communication through system interface</p>	<b>3ZS1310-5CC10-0YL5</b>
<b>Motor Starter ES 2007 Premium</b>	
<p><b>Floating license for one user</b> Engineering software, software and documentation on CD, 3 languages (German/English/French), communication through system interface or PROFIBUS/PROFINET, STEP7 Object Manager</p> <ul style="list-style-type: none"> <li>• License key on USB stick, Class A, including CD</li> <li>• License key download, Class A, without CD</li> </ul>	<p><b>3ZS1310-6CC10-0YA5</b> <b>3ZS1310-6CE10-0YB5</b></p>
<p><b>Upgrade for Motor Starter ES 2006</b> Floating license for one user, engineering software, software and documentation on CD, license key on USB stick, Class A, 3 languages (German/English/French), communication through system interface or PROFIBUS/PROFINET, STEP7 Object Manager</p>	<b>3ZS1310-6CC10-0YE5</b>
<p><b>Powerpack for Motor Starter ES 2007 Standard</b> Floating license for one user, engineering software, license key on USB stick, Class A, 3 languages (German/English/French), communication through system interface or PROFIBUS/PROFINET, STEP7 Object Manager</p>	<b>3ZS1310-6CC10-0YD5</b>
<p><b>Software Update Service</b> For 1 year with automatic extension, assuming the current software version is in use, engineering software, software and documentation on CD, communication through the system interface or PROFIBUS/PROFINET, STEP7 Object Manager</p>	<b>3ZS1310-6CC10-0YL5</b>

#### Notes:

Please order PC cable separately, see page 3/279.

For description of the software versions see page 3/276.



## Accessories

	Version	Article No.
<i>Optional accessories</i>		
 <p>3RK1903-0CH20</p>	<p><b>2DI LC COM control module</b> For ET 200S High-Feature starters, fail-safe starters A</p>	<p><b>3RK1903-0CH20</b></p>
	<p><b>LOGO! USB PC cables</b> For ET 200S High-Feature starter</p>	<p><b>6ED1057-1AA01-0BA0</b></p>
	<p><b>RS 232 interface cable</b> Serial data connection between ET 200pro MS/FC, M200D and laptop/PC/PG or MS</p>	<p><b>3RK1922-2BP00</b></p>
	<p><b>USB interface cable</b> Serial data connection between ET 200pro MS/FC, M200D and laptop/PC/PG or MS</p>	<p><b>6SL3555-0PA00-2AA0</b></p>
	<p><b>USB/serial adapters</b> for connecting an RS 232 PC cable to the USB interface of a PC, recommended for use in conjunction with ET 200S/ECOFAS/ET 200pro motor starters</p>	<p><b>3UF7946-0AA00-0</b></p>

## PROFIBUS

Motor starters for use in the field, high degree of protection  
Software

### SIRIUS motor starter block library for SIMATIC PCS 7

#### Overview

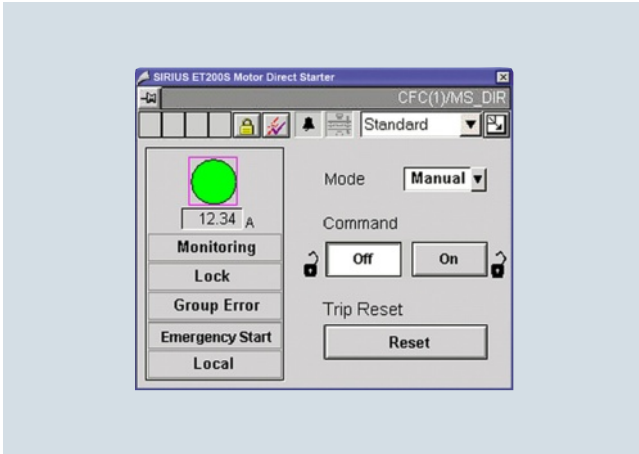

Faceplate of the motor block

With the SIRIUS motor starter PCS 7 block library, SIRIUS ET 200S and ET 200pro motor starters can be easily and simply integrated into the SIMATIC PCS 7 process control system. The SIRIUS motor starter PCS 7 block library contains the diagnostics and driver blocks corresponding to the SIMATIC PCS 7 diagnostics and driver concept as well as the elements (symbols and faceplates) required for operator control and process monitoring.

#### Easy integration with the PCS 7 block library

The PCS 7 block library can be used for simple and easy integration of SIRIUS ET 200S and ET 200pro motor starters into the SIMATIC PCS 7 process control system V7.0, V7.1 and V8.0. The focus here is simple configuration. The function of the blocks is based on the PCS 7 standard libraries and is optimally harmonized with the functions of the SIRIUS motor starters.

Users who have previously integrated conventional motor feeders into PCS 7 are easily able to switch to SIRIUS motor starters.

All blocks required for the automation systems are provided by the PCS 7 block library – as are the block symbols and faceplates for the operator station required for monitoring and control.

Regardless of whether, for example, the motor starter is controlled directly, or its current value is to be read out and status, warning and error signals are to be displayed, the right blocks are always available.

#### Connection to powerrate

The SIRIUS motor starters can be connected to powerrate. The block provides the possibility of integrating the motor starters into energy management.

The current values are supplied directly from the motor starter block, while the voltage and the power factor (p.f) must be entered manually.

#### Types of delivery and license

The SIRIUS motor starter PCS 7 block library supplied on CD-ROM allows the user to run the required engineering software on the engineering station (single license) including the runtime software for executing the AS blocks in an automation system (single license). If the AS blocks are to be used in additional automation systems, the corresponding number of runtime licenses are required which are supplied without a data carrier.

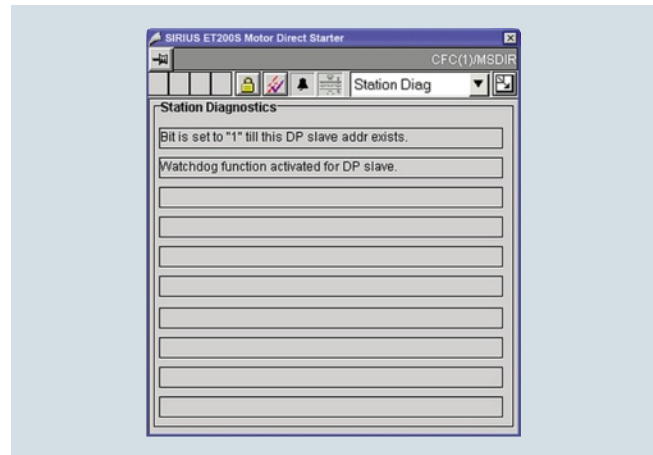

Faceplate for diagnostics

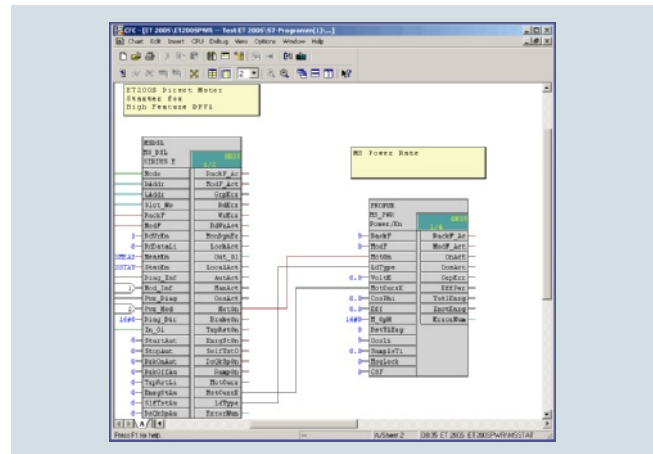

Faceplate for energy management with powerrate

#### Benefits

- Uniform and continuous integration into SIMATIC PCS 7
- Standardized blocks for simple integration and optimal operation
- Greater process transparency due to greater information density in the process control system

## Selection and ordering data

Version	Article No.
<i>SIRIUS motor starter block library for SIMATIC PCS 7</i>	
 <p>3ZS1630-1XX00-0YA0</p>	<p><b>Engineering software V7</b> For one engineering station (single license) including runtime software for execution of the AS blocks in an automation system (single license), German/English Scope of supply: AS blocks and faceplates for integrating SIRIUS motor starters into the PCS 7 process control system, for PCS 7 version V7.0 or V7.1 Type of delivery: Software and documentation on CD, one license for one engineering station, one license for one automation system</p>
	<p><b>Runtime license V7</b> For execution of the AS blocks in an automation system (single license) Required for using the AS blocks of the engineering software V7 or the engineering software migration V7-V8 on an additional automation system within a plant Type of delivery: One license for one automation system, without software and documentation</p>
	<p><b>Upgrade for SIRIUS motor starter block library for SIMATIC PCS 7 V6.1/V7.0 to V7.0/V7.1</b> For one engineering station (single license) including runtime software for execution of the AS blocks in an automation system (single license), German/English Scope of supply: AS blocks and faceplates for integrating SIRIUS motor starter into the PCS 7 process control system, for PCS 7 version V7.0 or V7.1 Type of delivery: Software and documentation on CD, one license for one engineering station, one license for one automation system</p>
	<p><b>Engineering software migration V7-V8</b> For upgrading (migrating) an existing engineering software V7 of the SIRIUS motor starter block library for PCS 7 Conditions of use: Availability of the engineering software V7 (license) of the SIRIUS motor starter block library for PCS 7 for the PCS 7 version V7.0 or V7.1 The engineering software migration V7-V8 can be installed directly onto a system with PCS 7 version V8.0; installation of the previous version is unnecessary. For one engineering station (single license) including runtime software for execution of the AS blocks in an automation system (single license), German/English Scope of supply: AS blocks and faceplates for integrating SIRIUS motor starter into the PCS 7 process control system, for PCS 7 version V8.0 Type of delivery: Software and documentation on CD, license for upgrading an existing license for one engineering station and a plant's assigned runtime licenses</p>

## More information

Programming and Operating Manual for SIRIUS Motor Starter  
PCS 7 Block Library V7.1 + SP2 see  
<http://support.automation.siemens.com/WW/view/en/41856573>.

Getting Started for SIRIUS Motor Starter PCS 7 Block Library  
V7.1 + SP2 see  
<http://support.automation.siemens.com/WW/view/en/41856486>.

Note:

Programming Manual and GETTING STARTED are valid for  
engineering software V7 and engineering software migration  
V7-V8.

# PROFIBUS

## SIMOCODE 3UF Motor Management and Control Devices

### SIMOCODE pro

#### General data

#### Overview

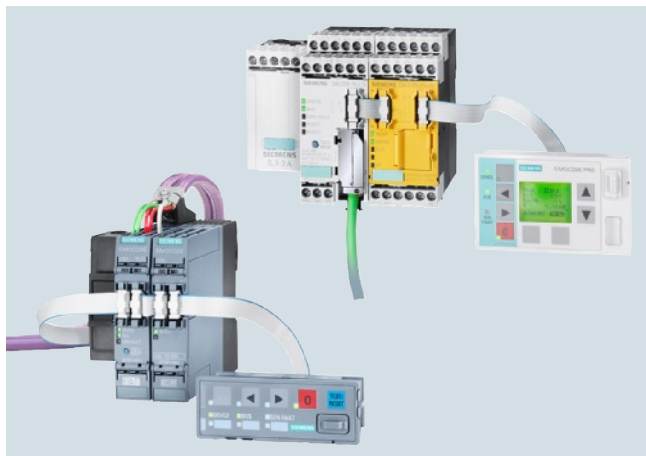

SIMOCODE pro S for efficient entry into motor management and SIMOCODE pro V for maximum functionality

SIMOCODE pro is a flexible, modular motor management system for motors with constant speeds in the low-voltage performance range. It optimizes the connection between I&C and motor feeder, increases plant availability and allows significant savings to be made for installation, commissioning, operation and maintenance of a system.

When SIMOCODE pro is installed in the low-voltage switchboard, it is the intelligent interface between the higher-level automation system and the motor feeder and includes the following:

- Multifunctional, electronic full motor protection, independent of the automation system
- Integrated control functions instead of hardware for the motor control
- Detailed operating, service and diagnostics data
- Open communication through PROFIBUS DP, PROFINET and OPC UA
- Safety relay function for the fail-safe disconnection of motors up to SIL 3 (IEC 61508, IEC 62061) or PL e with Category 4 (EN ISO 13849-1)
- SIMOCODE ES is the software package for SIMOCODE pro parameterization, start-up and diagnostics.

#### Device series

SIMOCODE pro is structured into several functionally tiered series:

- SIMOCODE pro C, as a compact system for direct-on-line starters and reversing starters or for controlling a motor starter protector
- SIMOCODE pro S, the smart system for direct-on-line, reversing, and wye-delta starters or for controlling a motor starter protector or soft starter. As it can be expanded with a multifunction module, it offers an extensive range of inputs and outputs, precise ground-fault detection via the 3UL23 residual current transformer and temperature measurement.
- SIMOCODE pro V, as a variable system with all control functions and with the possibility of expanding the inputs, outputs and functions of the system at will using expansion modules

Expansion options	SIMOCODE			
	pro C	pro S	pro V <sup>3)</sup>	
	PROFIBUS	PROFIBUS	PROFIBUS <sup>1)</sup>	PROFINET
Operator panels	✓	✓	✓	✓
Operator panels with display	--	--	✓	✓
Current measuring modules	✓	✓	✓	✓
Current/voltage measuring modules	--	--	✓	✓
Decoupling modules	--	--	✓	✓
Expansion modules:				
• Digital modules	--	--	2	2
• Fail-safe digital modules <sup>2)</sup>	--	--	1	1
• Analog modules	--	--	1	2
• Ground-fault modules	--	--	1	1
• Temperature modules	--	--	1	2
• Multifunction modules	--	1	--	--

✓ Available

-- Not available

<sup>1)</sup> When an operator panel with display and/or a decoupling module are used, more restrictions on the number of expansion modules connectable per basic unit must be observed, see page 3/286.

<sup>2)</sup> The fail-safe digital module can be used instead of one of the two digital modules.

<sup>3)</sup> Maximum of 5 expansion modules.

Per feeder each system always comprises one basic unit and one separate current measuring module. The two modules are connected together electrically through the system interface with a connection cable and can be mounted mechanically connected as a unit (one behind the other) or separately (side by side). The motor current to be monitored is decisive only for the choice of the current measuring module.

An operator panel for mounting in the control cabinet door is optionally connectable through a second system interface on the basic unit. Both the current measuring module and the operator panel are electrically supplied by the basic unit through the connection cable. More inputs, outputs and functions can be added to the SIMOCODE pro V and SIMOCODE pro S by means of optional expansion modules, thus supplementing the inputs and outputs already existing on the basic unit. With the DM-F Local and DM-F PROFIsafe fail-safe digital modules it is also possible to integrate the fail-safe disconnection of motors in the SIMOCODE pro V motor management system.

All modules are connected by connection cables. The connection cables are available in various lengths. The maximum distance between the modules (e.g. between the basic unit and the current measuring module) must not exceed 2.5 m. The total length of all the connection cables per system interface of the basic unit may be up to 3 m.

**Overview** (continued)

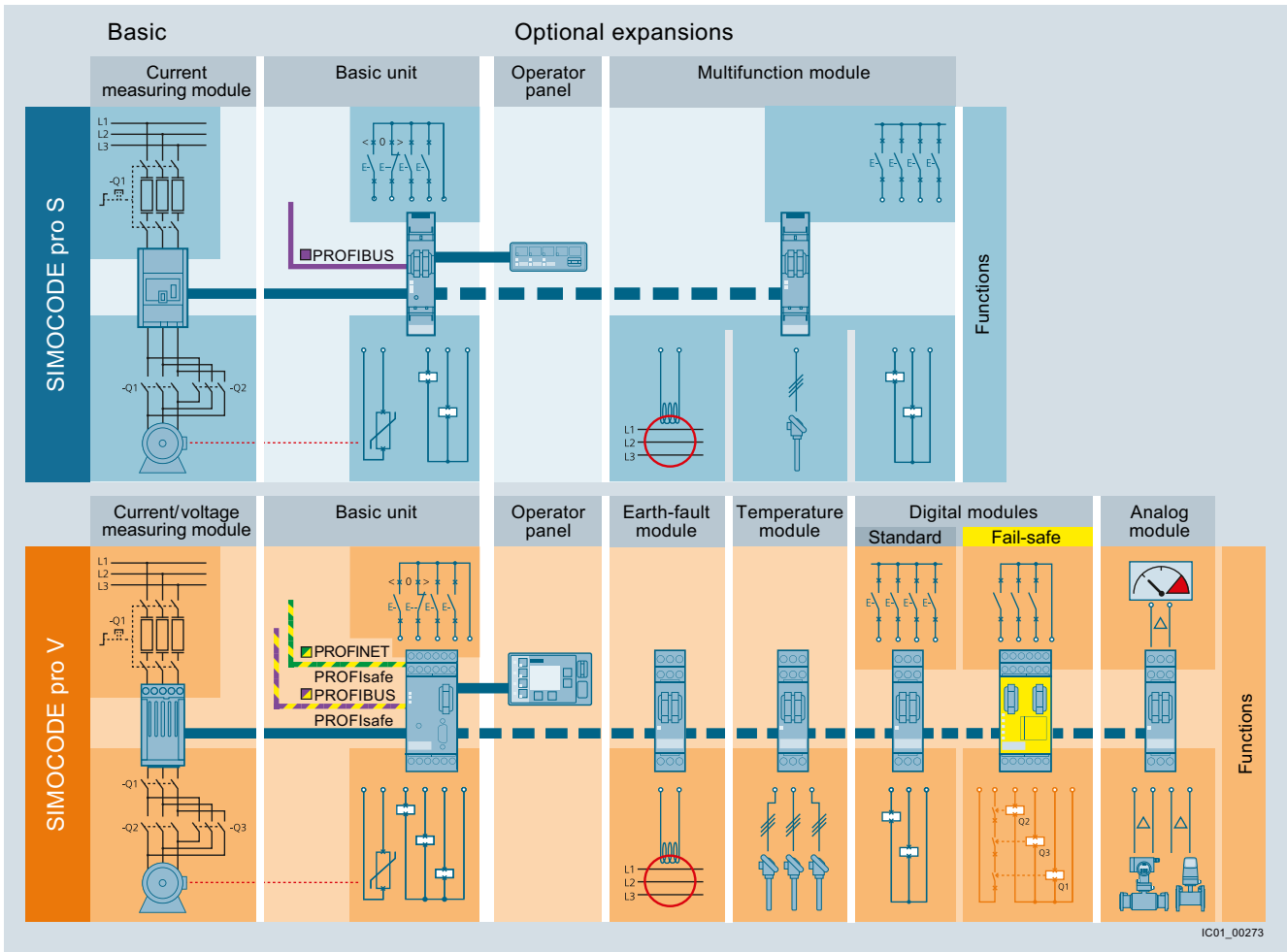

SIMOCODE pro V and SIMOCODE pro S: System structure

**Connection methods**

Selection tables for the SIMOCODE pro motor management system can be found on the following pages.

 Screw terminals

# PROFIBUS

## SIMOCODE 3UF Motor Management and Control Devices

### SIMOCODE pro

#### General data

#### Benefits

##### General customer benefits

- Integrating the whole motor feeder into the process control by means of PROFIBUS DP, PROFINET or OPC UA significantly reduces the wiring outlay between the motor feeder and PLC.
- Decentralization of the automated processes by means of configurable control and monitoring functions in the feeder saves resources in the automation system and ensures full functionality and protection of the feeder even if the I&C or bus system fails.
- The acquisition and monitoring of operating, service and diagnostics data in the feeder and process control system increases plant availability as well as maintenance and service-friendliness.
- The high degree of modularity allows users to perfectly implement their plant-specific requirements for each motor feeder.
- The SIMOCODE pro system offers functionally graded and space-saving solutions for each customer application.
- The replacement of the control circuit hardware with integrated control functions decreases the number of hardware components and wiring required and in this way limits stock keeping costs and potential wiring errors.
- The use of electronic full motor protection permits better utilization of the motors and ensures long-term stability of the tripping characteristic and reliable tripping even after years of service.

##### Multifunctional, electronic full motor protection for rated motor currents up to 820 A

SIMOCODE pro provides comprehensive protection of the motor feeder by means of a combination of delayable, multi-level protection and monitoring functions:

- Inverse-time delayed electronic overload protection (CLASS 5 to 40)
- Thermistor motor protection
- Phase failure/unbalance protection
- Stall protection
- Monitoring of adjustable limit values for the motor current
- Voltage and power monitoring
- Monitoring of the power factor (motor idling/load shedding)
- Ground-fault monitoring
- Temperature monitoring, e.g. over PT100/PT1 000
- Monitoring of operating hours, downtime and number of starts etc.

##### Recording of measuring curves

SIMOCODE pro can record measuring curves and therefore is able, for example, to present the progression of motor current during motor start-up.

##### Flexible motor control implemented with integrated control functions (instead of comprehensive hardware interlocks)

Many predefined motor control functions have already been integrated into SIMOCODE pro, including all necessary logic operations and interlocks:

- Overload relays
- Direct-on-line and reversing starters
- Wye/delta starters (also with direction reversal)
- Two speeds, motors with separate windings (pole-changing starters); also with direction reversal
- Two speeds, motors with separate Dahlander windings (also with direction reversal)
- Positioner actuation
- Solenoid valve actuation
- Control of a motor starter protector
- Soft starter actuation (also with direction reversal)

These control functions are predefined in SIMOCODE pro and can be freely assigned to the inputs and outputs of the device (including PROFIBUS/PROFINET).

These predefined control functions can also be flexibly adapted to each customized configuration of a motor feeder by means of freely configurable logic modules (truth tables, counters, timers, edge evaluation, etc.) and with the help of standard functions (power failure monitoring, emergency start, external faults, etc.), without additional auxiliary relays being necessary in the control circuit.

SIMOCODE pro makes a lot of additional hardware and wiring in the control circuit unnecessary which results in a high level of standardization of the motor feeder in terms of its design and circuit diagrams.

#### Benefits (continued)

##### **Detailed operating, service and diagnostics data**

SIMOCODE pro makes different operating, service and diagnostics data available and helps to detect potential faults in time and to prevent them by means of preventative measures. In the event of a malfunction, a fault can be diagnosed, localized and rectified very quickly – there are no or very short downtimes.

##### Operating data

- Motor switching state derived from the current flow in the main circuit
- All phase currents
- All phase voltages and phase-to-phase voltages
- Active power, apparent power and power factor
- Phase unbalance and phase sequence
- Ground-fault current
- Time to trip
- Motor temperature
- Remaining cooling time etc.

##### Service data

- Motor operating hours
- Motor stop times
- Number of motor starts
- Number of overload trips
- Interval for compulsory testing of the enabling circuits
- Energy consumed
- Internal comments stored in the device etc.

##### Diagnostics data

- Numerous detailed early warning and fault messages
- Internal device fault logging with time stamp
- Time stamping of freely selectable status, alarm or fault messages etc.

##### **Easy operation and diagnostics**

##### Operator panel

The operator panel is used to control the motor feeder and can replace all conventional pushbuttons and indicator lights to save space. It makes SIMOCODE pro or the feeder directly operable in the control cabinet. It features all the status LEDs available on the basic unit and externalizes the system interface for simple parameterization or diagnosis on a PC/PG.

##### Operator panel with display

As an alternative to the 3UF720 standard operator panel for SIMOCODE pro V, there is also an operator panel with display: the 3UF7 21 is thus able in addition to indicate measured values, operating and diagnostics data or status information of the motor feeder at the control cabinet. The pushbuttons of the operator panel can be used to control the motor. Also, when SIMOCODE pro V PROFINET is used it is possible to set parameters such as rated motor current, limit values, etc. directly via the operator panel with display.

##### **Communications**

SIMOCODE pro has either an integrated PROFIBUS DP interface (SUB-D or terminal connection) or a PROFINET interface (2 x RJ45).

Fail-safe disconnection through PROFIBUS or PROFINET with the PROFIsafe profile is also possible in conjunction with a fail-safe controller (F-CPU) and the DM-F PROFIsafe fail-safe digital module.

##### SIMOCODE pro for PROFIBUS

SIMOCODE pro for PROFIBUS supports for example:

- Cyclic services (DPV0) and acyclic services (DPV1)
- Extensive diagnostics and hardware interrupts
- Time stamp with high timing precision (SIMATIC S7) for SIMOCODE pro V
- DPV1 communication after the Y-Link

##### SIMOCODE pro for PROFINET

SIMOCODE pro for PROFINET supports for example:

- Line and ring bus topology thanks to an integrated switch
- Media redundancy via MRP protocol
- Operating, service and diagnostics data via standard web browser
- OPC UA server for open communication with visualization and control systems
- NTP-synchronized time
- Interval function and measured values for energy management via PROFenergy
- Module exchange without PC memory module through proximity detection
- Extensive diagnostics and maintenance alarms

##### Notes on safety

For connection of an internal system to an external system, suitable protective measures must be taken to ensure safe operation of the plant (including IT security, e. g. network segmentation).

More information see [www.siemens.com/industrialsecurity](http://www.siemens.com/industrialsecurity).

SIMOCODE pro motor management and control devices with communication function see page 3/288 onwards.

Accessories see page 3/293 onwards.

More information see Catalog IC 10, Chapter 14 "Parameterization, Configuration and Visualization with SIRIUS", Industry Mall or Interactive Catalog CA 01.

##### **Autonomous operation**

An essential feature of SIMOCODE pro is the autonomous execution of all protection and control functions, even when communication to the I&C system is interrupted. This means that even in the event of bus system or automation system failure, full functionality of the feeder is ensured or a specific behavior can be parameterized in case of such a fault, e.g. targeted shutdown of the feeder or execution of particular parameterized control mechanisms (such as reversal of the direction of rotation).

## PROFIBUS

### SIMOCODE 3UF Motor Management and Control Devices

#### SIMOCODE pro

#### General data

#### Application

SIMOCODE pro is often used for automated processes where plant downtimes are very expensive (e.g. steel or cement industry) and where it is important to prevent plant downtimes through detailed operating, service and diagnostics data or to localize the fault very quickly in the event of a fault.

SIMOCODE pro is modular and space-saving and suited especially for operation in motor control centers (MCCs) in the process industry and for power plant technology.

#### Applications

Protection and control of motors in hazardous areas for types of protection EEx e/d according to ATEX guideline 94/9/EC

- With heavy starting (paper, cement, metal and water industries)
- In high-availability plants (chemical, oil, raw material processing industries, power plants)

#### Safety technology for SIMOCODE pro

The safe disconnection of motors in the process industry is becoming increasingly important as the result of new and revised standards and requirements in the safety engineering field.

With the DM-F Local and DM-F PROFIsafe fail-safe expansion modules it is easy to integrate functions for fail-safe disconnection into the SIMOCODE pro V motor management system while retaining service-proven concepts. The strict separation of safety functions and operational functions proves particularly advantageous for planning, configuring and construction. Seamless integration in the motor management system leads to greater transparency for diagnostics and during operation of the system.

Suitable components for this purpose are the DM-F Local and DM-F PROFIsafe fail-safe expansion modules, depending on the requirements:

- The DM-F Local fail-safe digital module for when direct assignment between a fail-safe hardware shutdown signal and a motor feeder is required, or
- The DM-F PROFIsafe fail-safe digital module for when a fail-safe controller (F-CPU) creates the signal for the disconnection and transmits it in a fail-safe manner through PROFIBUS/PROFIsafe or PROFINET/PROFIsafe to the motor management system

#### More information

#### Configuration instructions when using an operator panel with display and/or a decoupling module with SIMOCODE pro V with PROFIBUS

If you want to use a decoupling module or an operator panel with display in the SIMOCODE pro V system with PROFIBUS, then the following configuration instructions concerning the type and number of connectable expansion modules must be observed.

The following tables show the maximum possible configuration of the expansion modules for the various combinations.

The DM-F Local and DM-F PROFIsafe fail-safe expansion modules behave in this connection like digital modules for standard applications.

#### Use of an operator panel with display

Digital module 1	Digital module 2	Analog modules	Temperature modules	Ground-fault modules
------------------	------------------	----------------	---------------------	----------------------

#### Only operator panel with display for SIMOCODE pro V (24 V DC or 110 ... 240 V AC/DC)

Max. 4 expansion modules can be used

#### Operator panel with display and current/voltage measurement with SIMOCODE pro V (110 ... 240 V AC/DC)

Max. 3 expansion modules can be used or:

--	--	✓	✓	--
----	----	---	---	----

✓ Available

-- Not available

#### Use of a decoupling module

(voltage measurement in insulated networks)

Digital module 1	Digital module 2	Analog modules	Temperature modules	Ground-fault modules
<b>SIMOCODE pro V (24 V DC)</b>				
✓ <sup>1)</sup>	✓ <sup>1)</sup>	✓	✓	✓
<b>SIMOCODE pro V (110 ... 240 V AC/DC)</b>				
✓	✓	--	✓	✓
✓ <sup>1)</sup>	✓ <sup>1)</sup>	✓	✓	--
✓	--	✓	✓	--
✓	--	✓	--	✓

✓ Available

-- Not available

<sup>1)</sup> No bistable relay outputs and no more than 5 of 7 relay outputs active simultaneously (> 3 s).

#### Use of a decoupling module

(voltage measurement in insulated networks) in combination with an operator panel with display

Digital module 1	Digital module 2	Analog modules	Temperature modules	Ground-fault modules
<b>SIMOCODE pro V (24 V DC)</b>				
✓	--	✓	✓	✓
✓	✓	--	✓	✓
<b>SIMOCODE pro V (110 ... 240 V AC/DC)</b>				
✓ <sup>2)</sup>	--	✓	✓	✓
✓	✓	--	--	--
✓ <sup>1)</sup>	✓ <sup>1)</sup>	✓ <sup>3)</sup>	--	--
✓	--	--	✓	✓

✓ Available

-- Not available

<sup>1)</sup> No bistable relay outputs and no more than 5 of 7 relay outputs active simultaneously (> 3 s).

<sup>2)</sup> No bistable relay outputs and no more than 3 of 5 relay outputs active simultaneously (> 3 s).

<sup>3)</sup> Analog module output is not used.



**More information** (continued)**Protective separation**

All circuits in SIMOCODE pro are safely isolated from each other in accordance with IEC 60947-1. That is, they are designed with double creepages and clearances. In the event of a fault, therefore, no parasitic voltages can be formed in neighboring circuits. The instructions of Test log No. 2668 must be complied with.

**Types of protection EEx e and EEx d**

The overload protection and the thermistor motor protection of the SIMOCODE pro system comply with the requirements for overload protection of explosion-proof motors to the type of protection:

- EEx d "flameproof enclosure" e.g. according to IEC 60079-1
- EEx e "increased safety" e.g. according to IEC 60079-7

When using SIMOCODE pro devices with a 24 V DC control voltage, electrical separation must be ensured using a battery or a safety transformer according to IEC 61558-2-6. EC type test certificate: BVS 06 ATEX F 001  
 Test log: BVS PP 05.2029 EG.

**Selection data for type-tested assemblies/load feeders**

For configuration tables according to type of coordination "1" or "2", see

- Manual "Configuring SIRIUS",  
 Article No.: 3ZX1012-ORA21-0AB0,  
<http://support.automation.siemens.com/WW/view/en/40625241>
- Manual "Configuring SIRIUS Innovations",  
 Article No.: 3ZX1012-ORA21-1AB0,  
<http://support.automation.siemens.com/WW/view/en/39714188>
- SIMOCODE pro PROFIBUS System Manual,  
 Article No.: 3UF7970-0AA01-0,  
<http://support.automation.siemens.com/WW/view/en/20017780>
- SIMOCODE pro PROFINET System Manual,  
 Article No.: 3ZX1012-OUF70-1AB1,  
<http://support.automation.siemens.com/WW/view/en/61896631>

**System manual**

The SIMOCODE pro system manual describes the motor management system and its functions in detail. It provides information on configuration, start-up, servicing and maintenance. A typical example of a reversing starter application is used to teach the user quickly and practically how to use the system. In addition to help on how to identify and rectify faults in the event of a malfunction, the manual also contains special information for servicing and maintenance. For selection of equipment and for planning, it is recommended to consult the system manual.

A detailed description of the DM-F Local and DM-F PROFIsafe fail-safe expansion modules is provided in the system manual "SIMOCODE pro Safety Fail-Safe Digital Modules", which can be downloaded from the Internet.





**Internet**

More information see [www.siemens.com/simocode](http://www.siemens.com/simocode).

# PROFIBUS SIMOCODE 3UF Motor Management and Control Devices SIMOCODE pro







## Basic units

### Selection and ordering data

Version		Screw terminals Article No. 
 <p><b>SIMOCODE pro C</b> PROFIBUS DP interface, 12 Mbit/s, RS 485 4 I/3 O freely assignable, input for thermistor connection, monostable relay outputs Rated control supply voltage <math>U_s</math>: • 24 V DC • 110 ... 240 V AC/DC</p> <p>3UF7000-1A.00-0</p>		<p>3UF7000-1AB00-0 3UF7000-1AU00-0</p>
 <p><b>SIMOCODE pro S</b> PROFIBUS DP interface, 1.5 Mbit/s, RS 485 4 I/2 O freely assignable, input for thermistor connection, monostable relay outputs, can be expanded by a multifunction module Rated control supply voltage <math>U_s</math>: • 24 V DC • 110 ... 240 V AC/DC</p> <p>3UF7020-1A.01-0</p>		<p>3UF7020-1AB01-0 3UF7020-1AU01-0</p>
 <p><b>SIMOCODE pro V</b> PROFIBUS DP interface, 12 Mbit/s, RS 485 4 I/3 O freely assignable, input for thermistor connection, monostable relay outputs, can be expanded by expansion modules Rated control supply voltage <math>U_s</math>: • 24 V DC • 110 ... 240 V AC/DC</p> <p>3UF7010-1A.00-0</p>		<p>3UF7010-1AB00-0 3UF7010-1AU00-0</p>
 <p><b>SIMOCODE pro V PROFINET<sup>1)</sup></b> ETHERNET/PROFINET IO, OPC UA server and web server, 100 Mbit/s, 2 x connection to bus through RJ45, 4 I/3 O freely assignable, input for thermistor connection, monostable relay outputs, can be expanded by expansion modules Rated control supply voltage <math>U_s</math>: • 24 V DC • 110 ... 240 V AC/DC</p> <p>3UF7011-1A.00-0</p>		<p>3UF7011-1AB00-0 3UF7011-1AU00-0</p>

<sup>1)</sup> When using an operator panel with display, the product version must be E07 or higher (from 08/2012).

## Selection and ordering data (continued)

Version	Current setting A	Width mm	Screw terminals Article No.	
<b>SIMOCODE pro (continued)</b>				
<b>Current measuring modules</b>				
 3UF7100-1AA00-0	• Straight-through transformers	0.3 ... 3	45	3UF7100-1AA00-0 3UF7101-1AA00-0 3UF7102-1AA00-0 3UF7103-1AA00-0 3UF7103-1BA00-0 3UF7104-1BA00-0
		2.4 ... 25	45	
		10 ... 100	55	
		20 ... 200	120	
	• Busbar connections	20 ... 200	120	
		63 ... 630	145	
<b>Current/voltage measuring modules for SIMOCODE pro V</b>				
Voltage measuring up to 690 V if required in connection with a decoupling module				
 3UF7110-1AA00-0	• Straight-through transformers	0.3 ... 3	45	3UF7110-1AA00-0 3UF7111-1AA00-0 3UF7112-1AA00-0 3UF7113-1AA00-0 3UF7113-1BA00-0 3UF7114-1BA00-0
		2.4 ... 25	45	
		10 ... 100	55	
		20 ... 200	120	
	• Busbar connections	20 ... 200	120	
		63 ... 630	145	
<b>Decoupling modules</b>				
 3UF7150-1AA00-0	For connecting upstream from a current/voltage measuring module on the system interface when using voltage measurement in insulated, high-resistance or asymmetrically grounded systems and in single-phase systems			3UF7150-1AA00-0
<b>Operator panels</b>				
 3UF7200-1AA00-0	Installation in control cabinet door or front plate, for plugging into all SIMOCODE pro basic units, 10 LEDs for status indication and user-assignable buttons for controlling the motor			3UF7200-1AA00-0 3UF7200-1AA01-0
	• Light gray			
 3UF7200-1AA01-0	• Titanium gray			
<b>Operator panel with display for SIMOCODE pro V</b>				
 3UF7210-1AA00-0	Installation in control cabinet door or front plate, for plugging into SIMOCODE pro V and SIMOCODE pro V PN, 7 LEDs for status indication and user-assignable buttons for controlling the motor, multilingual display, e.g. for indication of measured values, status information or fault messages			3UF7210-1AA00-0

Notes:

System manual "SIMOCODE pro PROFIBUS" see <http://support.automation.siemens.com/WW/view/en/20017780>.

System manual "SIMOCODE pro V PROFINET" see <http://support.automation.siemens.com/WW/view/en/61896631>.

SIMOCODE pro V basic unit in a hardened version via SIPLUS extreme upon request.





# PROFIBUS

## SIMOCODE 3UF Motor Management and Control Devices

### SIMOCODE pro

#### Expansion modules

#### Selection and ordering data (continued)

Version		Screw terminals Article No.
<i>Expansion modules for SIMOCODE pro V</i>		
<p>With SIMOCODE pro V, it is possible to expand the type and number of inputs and outputs in steps. Each expansion module has two system interfaces on the front. Through the one system interface the expansion module is connected to the system interface of the SIMOCODE pro V using a connection cable; through the second system interface, further expansion modules or the operator panel can be connected. The power supply for the expansion modules is provided by the connection cable through the basic unit.</p> <p><u>Note:</u> Please order connection cable separately, see page 3/293.</p>		
<b>Digital modules</b>		
<p>Up to two digital modules can be used to add additional binary inputs and relay outputs to the basic unit. The input circuits of the digital modules are supplied from an external power supply.</p>		
<p>4 binary inputs and 2 relay outputs, up to 2 digital modules can be connected</p>		
	<p><i>Relay outputs</i></p> <p>Monostable</p>	<p><b>3UF7300-1AB00-0</b></p>
	<p><i>Input voltage</i></p> <p>24 V DC</p>	<p><b>3UF7300-1AU00-0</b></p>
	<p>110 ... 240 V AC/DC</p>	<p><b>3UF7310-1AB00-0</b></p>
	<p>Bistable</p>	<p><b>3UF7310-1AU00-0</b></p>
	<p>24 V DC</p>	
	<p>110 ... 240 V AC/DC</p>	<p><b>3UF7310-1AU00-0</b></p>
<b>Analog modules</b>		
<p>Basic unit can be optionally expanded with analog inputs and outputs (0/4 ... 20 mA) by means of the analog module.</p>		
<p>2 inputs (passive) for input and 1 output for output of 0/4 ... 20 mA signals, max. 1 analog module can be connected per pro V basic unit and max. 2 analog modules per pro V PN basic unit</p>		
		<p><b>3UF7400-1AA00-0</b></p>
<p>3UF7400-1AA00-0</p>		
<b>Ground-fault modules<sup>1)</sup></b>		
<p>Ground-fault monitoring using 3UL23 residual-current transformers and ground-fault modules is used in cases where precise detection of the ground-fault current is required or power systems with high impedance are grounded.</p>		
<p>With the ground-fault module, it is possible to determine the precise fault current as a measured value, and to define freely selectable warning and trip limits in a wide range from 30 mA ... 40 A.</p>		
<p>1 input for connecting a 3UL23 residual-current transformer, up to 1 ground-fault module can be connected</p>		
	<p><u>Note:</u> See Catalog IC 10 for residual current transformers.</p>	<p><b>3UF7510-1AA00-0</b></p>
<p>3UF7510-1AA00-0</p>		
<b>Temperature modules</b>		
<p>Independently of the thermistor motor protection of the basic units, up to 3 analog temperature sensors can be evaluated using a temperature module.</p>		
<p>Sensor types: PT100/PT1 000, KTY83/KTY84 or NTC</p>		
<p>3 inputs for connecting up to 3 analog temperature sensors, up to 1 temperature module can be connected per pro V basic unit and max. 2 temperature modules per pro V PN basic unit</p>		
		<p><b>3UF7700-1AA00-0</b></p>
<p>3UF7700-1AA00-0</p>		

<sup>1)</sup> Possible with pro V basic unit from product version E10 or pro V PN basic unit from product version E04.

**Selection and ordering data** (continued)

Version	Screw terminals Article No.	⊕
<b>Expansion modules for SIMOCODE pro S</b>		
<p>With SIMOCODE pro S, it is possible to expand the type and number of inputs and outputs. The expansion module has two system interfaces on the front. Through the one system interface the expansion module is connected to the system interface of the SIMOCODE pro S using a connection cable; through the second system interface, the operator panel can be connected. The power supply for the expansion module is provided by the connection cable through the basic unit.</p> <p><u>Note:</u> Please order connection cable separately, see page 3/293.</p>		
<p><b>Multifunction modules</b></p> <p>The multifunction module is the expansion module of the SIMOCODE pro S device series with the following functions:</p> <ul style="list-style-type: none"> <li>• Digital module function with four digital inputs and two monostable relay outputs</li> <li>• Ground-fault module function with an input for the connection of a 3UL23 residual-current transformer with freely selectable warning and trip limits in a wide zone of 30 mA ... 40 A</li> <li>• Temperature module function with an input for connecting an analog temperature sensor PT100, PT1 000, KTY83, KTY84, or NTC</li> </ul> <p>Max. 1 multifunction module can be connected per pro S basic unit</p> <p>Input voltage of the digital inputs:</p> <ul style="list-style-type: none"> <li>• 24 V DC</li> <li>• 110 ... 240 V AC/DC</li> </ul>		
 <p>3UF7600-1AU01-0</p>	<p><b>3UF7600-1AB01-0</b>  <b>3UF7600-1AU01-0</b></p>	



# PROFIBUS

## SIMOCODE 3UF Motor Management and Control Devices

### SIMOCODE pro

#### Fail-safe expansion modules

#### Selection and ordering data (continued)

Version	Screw terminals Article No.
<i>Fail-safe expansion modules for SIMOCODE pro V</i>	
<p>Thanks to the fail-safe expansion modules, SIMOCODE pro V can be expanded with the function of a safety relay for the fail-safe disconnection of motors. A maximum of 1 fail-safe digital module can be connected; it can be used instead of a digital module.</p> <p>The fail-safe expansion modules are equipped likewise with two system interfaces at the front for making the connection to other system components. Unlike other expansion modules, power is supplied to the modules through a separate terminal connection.</p> <p><u>Note:</u> Please order connection cable separately, see page 3/293.</p>	
 <p>3UF7320-1AB00-0</p> <p><b>DM-F Local fail-safe digital modules<sup>1)</sup></b></p> <p>For fail-safe disconnection using a hardware signal 2 relay enabling circuits, joint switching; 2 relay outputs, common potential disconnected fail-safe; inputs for sensor circuit, start signal, cascading and feedback circuit, safety function adjustable using DIP switches Rated control supply voltage <math>U_S</math>:</p> <ul style="list-style-type: none"> <li>• 24 V DC</li> <li>• 110 ... 240 V AC/DC</li> </ul>	<p><b>3UF7320-1AB00-0</b> <b>3UF7320-1AU00-0</b></p>
 <p>3UF7330-1AB00-0</p> <p><b>DM-F PROFIsafe fail-safe digital modules<sup>1)</sup></b></p> <p>For fail-safe disconnection using PROFIBUS/PROFIsafe or PROFINET/PROFIsafe 2 relay enabling circuits, joint switching; 2 relay outputs, common potential disconnected fail-safe; 1 input for feedback circuit; 3 binary standard inputs Rated control supply voltage <math>U_S</math>:</p> <ul style="list-style-type: none"> <li>• 24 V DC</li> <li>• 110 ... 240 V AC/DC</li> </ul>	<p><b>3UF7330-1AB00-0</b> <b>3UF7330-1AU00-0</b></p>









<sup>1)</sup> Possible with SIMOCODE pro V basic unit, product version E07 and higher (from 05/2011) or SIMOCODE pro V PN basic unit.

Note:

System manual "SIMOCODE pro Safety Fail-Safe Digital Modules" see

<http://support.automation.siemens.com/WW/view/en/50564852>.

#### Selection and ordering data (continued)

Version	Article No.																								
<b>Connection cables (essential accessory)</b>																									
 <p>3UF7932-0AA00-0</p> <p><b>Connection cables</b> In different lengths for connecting basic unit, current measuring module, current/voltage measuring module, operator panel or expansion modules or decoupling module</p> <table border="1"> <thead> <tr> <th>Version</th> <th>Length</th> <th>Article No.</th> </tr> </thead> <tbody> <tr> <td>Flat</td> <td>0.025 m</td> <td>3UF7930-0AA00-0</td> </tr> <tr> <td>Flat</td> <td>0.1 m</td> <td>3UF7931-0AA00-0</td> </tr> <tr> <td>Flat</td> <td>0.3 m</td> <td>3UF7935-0AA00-0</td> </tr> <tr> <td>Flat</td> <td>0.5 m</td> <td>3UF7932-0AA00-0</td> </tr> <tr> <td>Round</td> <td>0.5 m</td> <td>3UF7932-0BA00-0</td> </tr> <tr> <td>Round</td> <td>1.0 m</td> <td>3UF7937-0BA00-0</td> </tr> <tr> <td>Round</td> <td>2.5 m</td> <td>3UF7933-0BA00-0</td> </tr> </tbody> </table>	Version	Length	Article No.	Flat	0.025 m	3UF7930-0AA00-0	Flat	0.1 m	3UF7931-0AA00-0	Flat	0.3 m	3UF7935-0AA00-0	Flat	0.5 m	3UF7932-0AA00-0	Round	0.5 m	3UF7932-0BA00-0	Round	1.0 m	3UF7937-0BA00-0	Round	2.5 m	3UF7933-0BA00-0	
Version	Length	Article No.																							
Flat	0.025 m	3UF7930-0AA00-0																							
Flat	0.1 m	3UF7931-0AA00-0																							
Flat	0.3 m	3UF7935-0AA00-0																							
Flat	0.5 m	3UF7932-0AA00-0																							
Round	0.5 m	3UF7932-0BA00-0																							
Round	1.0 m	3UF7937-0BA00-0																							
Round	2.5 m	3UF7933-0BA00-0																							
<b>PC cables and adapters</b>																									
 <p>3UF7940-0AA00-0</p> <p><b>RS 232 PC cables</b> For connecting to the serial interface of a PC/PG, for communication with SIMOCODE pro through the system interface</p>	3UF7940-0AA00-0																								
 <p>3UF7941-0AA00-0</p> <p><b>USB PC cables</b> For connecting to the USB interface of a PC/PG, for communication with SIMOCODE pro through the system interface</p>	3UF7941-0AA00-0																								
 <p>3UF7941-0AA00-0</p> <p><b>USB/serial adapters</b> To connect an RS 232 PC cable to the USB interface of a PC, recommended for use in conjunction with SIMOCODE pro 3UF7</p>	3UF7946-0AA00-0																								
<b>Memory modules</b>																									
 <p>3UF7900-0AA00-0</p> <p>This enables transmission to a new system, e.g. when a device is replaced, without the need for additional aids or detailed knowledge of the device.</p> <p><b>Memory module for SIMOCODE pro C, SIMOCODE pro S and SIMOCODE pro V</b> For saving the complete parameterization of a SIMOCODE pro C, SIMOCODE pro S or SIMOCODE pro V system</p>	3UF7900-0AA00-0																								
 <p>3UF7901-0AA00-0</p> <p><b>Memory module for SIMOCODE pro V PROFINET</b> For saving the complete parameterization of a SIMOCODE pro V PROFINET system</p>	3UF7901-0AA00-0																								
<b>Interface covers</b>																									
 <p>3UF7950-0AA00-0</p> <p><b>Interface covers</b> For system interface</p> <ul style="list-style-type: none"> <li>• Light gray</li> <li>• Titanium gray</li> </ul>	3UF7950-0AA00-0 3RA6936-0B																								
<b>Addressing plugs</b>																									
 <p>3UF7910-0AA00-0</p> <p><b>Addressing plugs</b> For assigning the PROFIBUS address without using a PC/PG to SIMOCODE pro through the system interface</p>	3UF7910-0AA00-0																								

# PROFIBUS

## SIMOCODE 3UF Motor Management and Control Devices

### SIMOCODE pro

#### Accessories





#### Selection and ordering data (continued)

Version	Article No.												
<b>Accessories for motor control center</b>													
<p>With the draw-out technology often used in motor control centers it is possible to integrate a SIMOCODE pro initialization module in the switchboard on a permanent basis. Feeder-related parameter and address data can then be permanently assigned to this feeder.</p> <p><b>Initialization module<sup>1)</sup></b> For automatic parameterization of SIMOCODE pro S, SIMOCODE pro V and SIMOCODE pro V PROFINET, for fixed-mounted installation in switchboards</p> <p><b>Y connection cable<sup>1)</sup></b> For use in conjunction with the initialization module; connects the basic unit, current measuring module or current/voltage measuring module, and initialization module</p> <table border="1"> <thead> <tr> <th>System interface length</th> <th>Open cable end</th> <th>Article No.</th> </tr> </thead> <tbody> <tr> <td>0.1 m</td> <td>1.0 m</td> <td><b>3UF7931-0CA00-0</b></td> </tr> <tr> <td>0.5 m</td> <td>1.0 m</td> <td><b>3UF7932-0CA00-0</b></td> </tr> <tr> <td>1.0 m</td> <td>1.0 m</td> <td><b>3UF7937-0CA00-0</b></td> </tr> </tbody> </table>	System interface length	Open cable end	Article No.	0.1 m	1.0 m	<b>3UF7931-0CA00-0</b>	0.5 m	1.0 m	<b>3UF7932-0CA00-0</b>	1.0 m	1.0 m	<b>3UF7937-0CA00-0</b>	<p><b>3UF7902-0AA00-0</b></p>
System interface length	Open cable end	Article No.											
0.1 m	1.0 m	<b>3UF7931-0CA00-0</b>											
0.5 m	1.0 m	<b>3UF7932-0CA00-0</b>											
1.0 m	1.0 m	<b>3UF7937-0CA00-0</b>											
<b>Bus connection terminals</b>													
<p><b>Bus connection terminal</b> For shield support and strain relief of the PROFIBUS cable on a SIMOCODE pro S</p>	<b>3UF7960-0AA00-0</b>												
<b>Door adapters</b>													
<p><b>Door adapters</b> For external connection of the system interface, e.g. outside a control cabinet</p>	<b>3UF7920-0AA00-0</b>												
<b>Adapters for operator panel</b>													
<p><b>Adapters for operator panel</b> The adapter enables the smaller 3UF7200 operator panel from SIMOCODE pro to be used in a front panel cutout in which previously, e.g. after a change of system, a larger 3UF52 operator panel from SIMOCODE-DP had been used, degree of protection IP54</p>	<b>3UF7922-0AA00-0</b>												
<b>Labeling strips</b>													
<p><b>Labeling strips</b></p> <ul style="list-style-type: none"> <li>• For pushbuttons of the 3UF720 operator panel</li> <li>• For pushbuttons of the 3UF721 operator panel with display</li> <li>• For LEDs of the 3UF720 operator panel</li> </ul>	<p><b>3UF7925-0AA00-0</b></p> <p><b>3UF7925-0AA01-0</b></p> <p><b>3UF7925-0AA02-0</b></p>												
<b>Push-in lugs</b>													
<p><b>Push-in lugs for screw fixing</b> e.g. on mounting plate, 2 units required per device</p> <ul style="list-style-type: none"> <li>• Can be used for 3UF71.0, 3UF71.1 and 3UF71.2</li> <li>• Can be used for 3UF700, 3UF701, 3UF73, 3UF74, 3UF75 and 3UF77</li> <li>• Can be used for 3UF7020, 3UF7600</li> </ul>	<p><b>3RV2928-0B</b></p> <p><b>3RP1903</b></p> <p><b>3ZY1311-0AA00</b></p>												

<sup>1)</sup> Possible with pro V basic unit, product version E09 (11/2012) and higher, pro S basic unit or pro V PN basic unit.



## Selection and ordering data (continued)

	Version	Article No.
<b>Terminal covers</b>		
 3RT1956-4EA1	<b>Covers for cable lugs and busbar connections</b> <ul style="list-style-type: none"> <li>Length 100 mm, can be used for 3UF71.3-1BA00-0</li> <li>Length 120 mm, can be used for 3UF71.4-1BA00-0</li> </ul>	<b>3RT1956-4EA1</b> <b>3RT1966-4EA1</b>
	<b>Covers for box terminals</b> <ul style="list-style-type: none"> <li>Length 25 mm, can be used for 3UF71.3-1BA00-0</li> <li>Length 30 mm, can be used for 3UF71.4-1BA00-0</li> </ul>	<b>3RT1956-4EA2</b> <b>3RT1966-4EA2</b>
 3RT1956-4EA2	<b>Covers for screw terminals</b> Between contactor and current measuring module or current/voltage measuring module for direct mounting <ul style="list-style-type: none"> <li>Can be used for 3UF71.3-1BA00-0</li> <li>Can be used for 3UF71.4-1BA00-0</li> </ul>	<b>3RT1956-4EA3</b> <b>3RT1966-4EA3</b>
<b>Box terminal blocks</b>		
 3RT195-4G	<b>Box terminal blocks</b> For round and ribbon cables <ul style="list-style-type: none"> <li>Up to 70 mm<sup>2</sup>, can be used for 3UF71.3-1BA00-0</li> <li>Up to 120 mm<sup>2</sup>, can be used for 3UF71.3-1BA00-0</li> <li>Up to 240 mm<sup>2</sup>, can be used for 3UF71.4-1BA00-0</li> </ul>	<b>3RT1955-4G</b> <b>3RT1956-4G</b> <b>3RT1966-4G</b>
<b>Bus termination modules</b>		
 3UF1900-1KA00	<b>Bus termination modules</b> With separate control supply voltage for bus termination following the last unit on the bus line Supply voltage: <ul style="list-style-type: none"> <li>115/230 V AC</li> <li>24 V DC</li> </ul>	<b>3UF1900-1KA00</b> <b>3UF1900-1KB00</b>

# PROFIBUS

## SIMOCODE 3UF Motor Management and Control Devices

### SIMOCODE pro

#### Accessories

#### Selection and ordering data (continued)

##### Parameterization and service software for SIMOCODE pro 3UF7

- Delivered without PC cable

Version	Article No.
<b>SIMOCODE ES (TIA Portal) V12 basic</b>	
<b>Floating license for one user</b> Engineering software, software and documentation on DVD, 6 languages (German/English/French/Italian/Spanish/Chinese), for all SIMOCODE pro with PROFIBUS, online functions through system interface) <ul style="list-style-type: none"> <li>• License key on USB stick, Class A</li> <li>• License key download, Class A</li> </ul>	<b>3ZS1322-4CC10-0YA5</b> <b>3ZS1322-4CE10-0YB5</b>
<b>SIMOCODE ES (TIA Portal) V12 standard</b>	
<b>Floating license for one user</b> Engineering software, software and documentation on DVD, 6 languages (German/English/French/Italian/Spanish/Chinese), for all SIMOCODE pro with PROFIBUS, online functions through system interface parameterizing with integrated graphics editor (CFC-based) <ul style="list-style-type: none"> <li>• License key on USB stick, Class A</li> <li>• License key download, Class A</li> </ul>	<b>3ZS1322-5CC10-0YA5</b> <b>3ZS1322-5CE10-0YB5</b>
<b>Upgrade for SIMOCODE ES 2007</b> Floating license for one user, engineering software, software and documentation on DVD, license key on USB stick, Class A, 6 languages (German/English/French/Italian/Spanish/Chinese), combo license for parallel use of SIMOCODE ES 2007 and SIMOCODE ES V12, for all SIMOCODE pro with PROFIBUS,online functions through the system interface, parameterizing with integrated graphics editor (CFC-based)	<b>3ZS1322-5CC10-0YE5</b>
<b>Powerpack for SIMOCODE ES V12 Basic</b> Floating license for one user, engineering software, license key on USB stick, Class A, 6 languages (German/English/French/Italian/Spanish/Chinese), for all SIMOCODE pro with PROFIBUS,online functions through the system interface, parameterizing with integrated graphics editor (CFC-based)	<b>3ZS1322-5CC10-0YD5</b>
<b>Software Update Service</b> For 1 year with automatic extension, assuming the current software version is in use, engineering software, software and documentation on DVD, online functions through the system interface, parameterizing with integrated graphics editor (CFC-based)	<b>3ZS1322-5CC10-0YL5</b>
<b>SIMOCODE ES (TIA Portal) V12 Premium</b>	
<b>Floating license for one user</b> Engineering software, software and documentation on DVD, 6 languages (German/English/French/Italian/Spanish/Chinese), for all SIMOCODE pro with PROFIBUS, online functions through the system interface and PROFIBUS, parameterizing with integrated graphics editor (CFC-based) <ul style="list-style-type: none"> <li>• License key on USB stick, Class A</li> <li>• License key download, Class A</li> </ul>	<b>3ZS1322-6CC10-0YA5</b> <b>3ZS1322-6CE10-0YB5</b>
<b>Upgrade for SIMOCODE ES 2007</b> Floating license for one user, engineering software, software and documentation on DVD, license key on USB stick, Class A, 6 languages (German/English/French/Italian/Spanish/Chinese), combo license for parallel use of SIMOCODE ES 2007 and SIMOCODE ES V12, for all SIMOCODE pro with PROFIBUS, online functions through the system interface and PROFIBUS, parameterizing with integrated graphics editor (CFC-based)	<b>3ZS1322-6CC10-0YE5</b>
<b>Powerpack for SIMOCODE ES V12 Standard</b> Floating license for one user, engineering software, license key on USB stick, Class A, 6 languages (German/English/French/Italian/Spanish/Chinese), for all SIMOCODE pro with PROFIBUS, online functions through the system interface and PROFIBUS, parameterizing with integrated graphics editor (CFC-based)	<b>3ZS1322-6CC10-0YD5</b>
<b>Software Update Service</b> For 1 year with automatic extension, assuming the current software version is in use, engineering software, software and documentation on DVD, online functions through the system interface and PROFIBUS, parameterizing with integrated graphics editor (CFC-based)	<b>3ZS1322-6CC10-0YL5</b>

#### Notes:

Please order PC cable separately, see page 3/293.

More information see Catalog IC 10, Chapter 14  
 "Parameterization, Configuration and Visualization with SIRIUS",  
 Industry Mall or Interactive Catalog CA 01.

**Selection and ordering data** (continued)

Version	Article No.
<b>SIMOCODE ES 2007 Basic</b>	
 <p><b>Floating license for one user</b> Engineering software, software and documentation on CD, 3 languages (German/English/French), communication through system interface</p> <ul style="list-style-type: none"> <li>• License key on USB stick, Class A</li> <li>• License key download, Class A</li> </ul>	<p><b>3ZS1312-4CC10-0YA5</b> <b>3ZS1312-4CE10-0YB5</b></p>
<b>SIMOCODE ES 2007 Standard</b>	
<p><b>Floating license for one user</b> Engineering software, software and documentation on CD, 3 languages (German/English/French), communication through system interface, integrated graphics editor</p> <ul style="list-style-type: none"> <li>• License key on USB stick, Class A</li> <li>• License key download, Class A</li> </ul>	<p><b>3ZS1312-5CC10-0YA5</b> <b>3ZS1312-5CE10-0YB5</b></p>
<p><b>Upgrade for SIMOCODE ES 2004 and later</b> Floating license for one user, engineering software, software and documentation on CD, license key on USB stick, Class A, 3 languages (German/English/French), communication through the system interface, integrated graphics editor</p>	<p><b>3ZS1312-5CC10-0YE5</b></p>
<p><b>Powerpack for SIMOCODE ES 2007 Basic</b> Floating license for one user, engineering software, license key on USB stick, Class A, 3 languages (German/English/French), communication through the system interface, integrated graphics editor</p>	<p><b>3ZS1312-5CC10-0YD5</b></p>
<p><b>Software Update Service</b> For 1 year with automatic extension, assuming the current software version is in use, engineering software, software and documentation on CD, communication through the system interface, integrated graphics editor</p>	<p><b>3ZS1312-5CC10-0YL5</b></p>
<b>SIMOCODE ES 2007 Premium</b>	
<p><b>Floating license for one user</b> Engineering software, software and documentation on CD, 3 languages (German/English/French), communication through PROFIBUS/PROFINET or system interface, integrated graphics editor, STEP7 Object Manager</p> <ul style="list-style-type: none"> <li>• License key on USB stick, Class A</li> <li>• License key download, Class A</li> </ul>	<p><b>3ZS1312-6CC10-0YA5</b> <b>3ZS1312-6CE10-0YB5</b></p>
<p><b>Upgrade for SIMOCODE ES 2004 and later</b> Floating license for one user, engineering software, software and documentation on CD, license key on USB stick, Class A, 3 languages (German/English/French), communication through PROFIBUS/PROFINET or system interface, integrated graphics editor, STEP7 Object Manager</p>	<p><b>3ZS1312-6CC10-0YE5</b></p>
<p><b>Powerpack for SIMOCODE ES 2007 Standard</b> Floating license for one user, engineering software, license key on USB stick, Class A, 3 languages (German/English/French), communication through PROFIBUS/PROFINET or system interface, integrated graphics editor, STEP7 Object Manager</p>	<p><b>3ZS1312-6CC10-0YD5</b></p>
<p><b>Software Update Service</b> For 1 year with automatic extension, assuming the current software version is in use, engineering software, software and documentation on CD, communication through PROFIBUS/PROFINET or system interface, integrated graphics editor, STEP7 Object Manager</p>	<p><b>3ZS1312-6CC10-0YL5</b></p>

Notes:

Please order PC cable separately, see page 3/293.

More information see Catalog IC 10, Chapter 14 "Parameterization, Configuration and Visualization with SIRIUS", Industry Mall or Interactive Catalog CA 01.

# PROFIBUS

## SIMOCODE 3UF Motor Management and Control Devices

### SIMOCODE pro

#### Accessories

#### Selection and ordering data (continued)

Version	Article No.
<b>SIMOCODE pro block library for SIMATIC PCS 7 Version V8 with Advanced Process Library (APL)</b>	
 <p data-bbox="130 625 316 646">3ZS1632-1XX02-0YA0</p> <p data-bbox="376 406 596 427"><b>Engineering software V8</b></p> <p data-bbox="376 431 970 491">For one engineering station (single license) including runtime software for execution of the AS blocks in an automation system (single license), German/English</p> <p data-bbox="376 495 517 517">Scope of supply:</p> <p data-bbox="376 519 916 578">AS blocks and faceplates for integrating SIMOCODE pro into the PCS 7 process control system with Advanced Process Library, for PCS 7 version V8.0</p> <p data-bbox="376 583 517 604">Type of delivery:</p> <p data-bbox="376 606 708 666">Software and documentation on CD, one license for one engineering station, one license for one automation system</p>	<p data-bbox="1158 406 1353 427"><b>3ZS1632-1XX02-0YA0</b></p>
<p data-bbox="376 672 549 693"><b>Runtime license V8</b></p> <p data-bbox="376 697 1027 757">For execution of the AS blocks in an automation system (single license) Required for using the AS blocks of the engineering software V8 within a plant</p> <p data-bbox="376 761 517 783">Type of delivery:</p> <p data-bbox="376 785 708 810">One license for one automation system, without software and documentation</p>	<p data-bbox="1158 672 1353 693"><b>3ZS1632-2XX02-0YB0</b></p>
<p data-bbox="376 817 900 855"><b>Upgrade for SIMOCODE pro PCS 7 block library, V6.0 or V7 to the SIMOCODE pro V8 version</b></p> <p data-bbox="376 859 970 919">For one engineering station (single license) including runtime software for execution of the AS blocks in an automation system (single license), German/English</p> <p data-bbox="376 923 517 944">Scope of supply:</p> <p data-bbox="376 946 916 1006">AS blocks and faceplates for integrating SIMOCODE pro into the PCS 7 process control system, with Advanced Process Library for PCS 7 version V8.0</p> <p data-bbox="376 1010 517 1032">Type of delivery:</p> <p data-bbox="376 1034 708 1093">Software and documentation on CD, one license for one engineering station, one license for one automation system</p>	<p data-bbox="1158 817 1353 838"><b>3ZS1632-1XX02-0YE0</b></p>

#### Notes:

Please order PC cable separately, see page 3/293.

More information see Catalog IC 10, Chapter 14 "Parameterization, Configuration and Visualization with SIRIUS", Industry Mall or Interactive Catalog CA 01.

**Selection and ordering data** (continued)

Version	Article No.
<b>SIMOCODE pro block library for SIMATIC PCS 7 Version 7</b>	
 <p>3UF7982-0AA00-0</p> <p><b>Engineering software V7</b>            For one engineering station (single license) including runtime software for execution of the AS blocks in an automation system (single license), German/English/French            Scope of supply:            AS blocks and faceplates for integrating SIMOCODE pro into the PCS 7 process control system, for PCS7 version V7.0/V7.1            Type of delivery:            Software and documentation on CD,            one license for one engineering station,            one license for one automation system</p>	<b>3UF7982-0AA10-0</b>
<p><b>Runtime license V7</b>            For execution of the AS blocks in an automation system (single license)            Required for using the AS blocks of the engineering software V7 or the engineering software migration V7-V8 on an additional automation system within a plant            Type of delivery:            One license for one automation system,            without software and documentation</p>	<b>3UF7982-0AA11-0</b>
<p><b>Upgrade for SIMOCODE pro PCS 7 block library, V6.0 or V6.1 to version SIMOCODE pro V7.0/V7.1</b>            For one engineering station (single license) including runtime software for execution of the AS blocks in an automation system (single license), German/English/French            Scope of supply:            AS blocks and faceplates for integrating SIMOCODE pro into the PCS 7 process control system, for PCS7 version V7.0/V7.1            Type of delivery:            Software and documentation on CD,            one license for one engineering station,            one license for one automation system</p>	<b>3UF7982-0AA13-0</b>
<p><b>Engineering software migration V7-V8</b>            For upgrading (migrating) an existing engineering software V7 of the SIMOCODE pro block library for PCS 7            Conditions of use:            Availability of the engineering software V7 (license) of the SIMOCODE pro block library for PCS 7 for the PCS 7 version V7.0 or V7.1            The engineering software migration V7-V8 can be installed directly onto a system with PCS 7 version V8.0; installation of the previous version is unnecessary.            For one engineering station (single license) including runtime software for execution of the AS blocks in an automation system (single license), German/English/French            Scope of supply:            AS blocks and faceplates for integrating SIMOCODE pro into the PCS 7 process control system, for PCS 7 version V8.0            Type of delivery:            software and documentation on CD,            license for upgrading an existing license            for one engineering station and a plant's assigned runtime licenses</p>	<b>3UF7982-0AA20-0</b>

Notes:

Please order PC cable separately, see page 3/293.

More information see Catalog IC 10, Chapter 14  
 "Parameterization, Configuration and Visualization with SIRIUS",  
 Industry Mall or Interactive Catalog CA 01.

Programming and Operating Manual SIMOCODE pro Library for  
 PCS 7 see  
<http://support.automation.siemens.com/WW/view/en/49963525>.



## PROFIBUS SIMOCODE 3UF Motor Management and Control Devices

### 3UF18 current transformers for overload protection

#### Overview

The 3UF18 current transformers are protection transformers and are used for actuating overload relays. Protection transformers are designed to ensure proportional current transfer up to a multiple of the primary rated current. The 3UF18 current transformers convert the maximum current of the corresponding operating range into the standard value of 1 A secondary.

#### Selection and ordering data

	Mounting type	Operating range A	Screw terminals Article No.
<b>For stand-alone installation</b>			
 3UF1843	Screw fixing and snap-on mounting onto TH 35 standard mounting rail according to IEC 60715	0.25 ... 2.5 <sup>1)</sup>	<b>3UF1843-1BA00</b> <b>3UF1843-2AA00</b> <b>3UF1843-2BA00</b> <b>3UF1845-2CA00</b> <b>3UF1847-2DA00</b> <b>3UF1848-2EA00</b>
		1.25 ... 12.5 <sup>1)</sup>	
		2.5 ... 25 <sup>1)</sup>	
		12.5 ... 50	
		16 ... 65	
		25 ... 100	
<b>For mounting onto contactors and stand-alone installation</b>			
 3UF1868	Screw fixing	32 ... 130	<b>3UF1850-3AA00</b> <b>3UF1852-3BA00</b> <b>3UF1854-3CA00</b> <b>3UF1856-3DA00</b> <b>3UF1857-3EA00</b> <b>3UF1868-3FA00</b> <b>3UF1868-3GA00</b>
		50 ... 200	
		63 ... 250	
		100 ... 400	
		125 ... 500	
		160 ... 630	
		205 ... 820	

<sup>1)</sup> The following setting ranges for the protection of EEx e motors are applicable:  
 3UF1843-1BA00, 0.25 ... 1.25 A;  
 3UF1843-2AA00, 1.25 ... 6.3 A;  
 3UF1843-2BA00, 2.5 ... 12.5 A.

#### Accessories

	For contactor type	Article No.
<b>Terminal covers</b>		
 3TX7466-0A	For transformer/contactor assemblies and stand-alone installation for transformer (cover required per connection side)	<b>3TX7446-0A</b> <b>3TX7466-0A</b> <b>3TX7506-0A</b> <b>3TX7536-0A</b> <b>3TX7686-0A</b> <b>3TX7696-0A</b>
	3UF1845	
	3UF1848	
	3UF1850, 3UF1852	
	3UF1854 to 3UF1857	
	3UF1868-3FA00	
	3UF1868-3GA00	
For covering the screw terminal for direct mounting on contactor (cover required per contactor/transformer assembly)	<b>3TX7466-0B</b> <b>3TX7506-0B</b> <b>3TX7536-0B</b> <b>3TX7686-0B</b> <b>3TX7696-0B</b>	
3UF1848		
3UF1850, 3UF1852		
3UF1854 to 3UF1857		
3UF1868-3FA00		
3UF1868-3GA00		

**Overview**

SIRIUS 3RK3 Modular Safety System

The 3RK3 Modular Safety System (MSS) is a freely parameterizable modular safety relay. Depending on the external circuit version, safety-related applications up to Performance Level e according to EN ISO 13849-1 or SIL 3 according to IEC 62061 can be realized.

The modular safety relay enables the interconnection of several safety applications.

The comprehensive error and status diagnostics provides the possibility of finding errors in the system and localizing signals from sensors. Plant downtimes can be reduced as the result.

The MSS comprises the following system components:

- Central units
- Expansion modules
- Interface modules
- Diagnostics modules
- Parameterization software
- Accessories

**Central units**
**MSS Basic**

The 3RK3 Basic central unit is used wherever more than three safety functions need to be evaluated and the wiring parameterization of safety relays would involve great cost and effort. It reads in inputs, controls outputs, and communicates through an interface module with higher-level control systems. An application's entire safety program is processed in the central unit. The 3RK3 Basic central unit is the lowest expansion level and fully functional on its own, without the optional expansion modules.

**MSS Advanced**

The 3RK3 Advanced central unit is the consistent expansion of the Basic central unit with the functionality of an AS-i safety monitor. In addition to having a larger volume of project data and scope of functionality it can be integrated in AS-Interface and therefore make use of the many different possibilities offered by this bus system. The function can be optionally activated in the central unit.

The service-proven insulation piercing method of AS-Interface enables not only the distributed expansion of the project data volume using safe AS-i outputs, safe AS-i sensors and other MSS Advanced or safety monitors (F cross traffic) but also a highly flexible adaptation of the application, e.g. very fast connection of AS-i outputs such as LV HRC command devices, position switches with and without interlock, or light curtains.

Safety-related disconnection using MSS or by distributed means using safe AS-i outputs and the formation of switch-off groups can be realized very easily. The same applies for any subsequent modifications. They are now easily possible by re-addressing, i.e. re-wiring is no longer necessary.

The AS-i bus is connected directly to the central unit.

**MSS ASIsafe**

The MSS ASIsafe basic and MSS ASIsafe extended central units are a logical development of the AS-i safety monitors based on the 3RK3 Modular Safety System.

Like MSS Advanced, MSS ASIsafe detects – in a comparable way to the safety monitors – safe sensor technology on the AS-i bus and switches actuators off in a safety-related manner via a configurable safety logic. It stands out by virtue of its greater project data volume, wider range of functions and the possibility of increasing the integrated I/O project data volume by means of expansion modules from the MSS system family. In this case the range of functions, such as the number and type of the logic elements that can be interconnected, is equivalent to that of MSS Advanced.

**Expansion modules**

With the optional expansion modules, both safety-related and standard, the system is flexibly adapted to the required safety applications.

**Interface modules**

The DP interface module is used for transferring diagnostics data and device status data to a higher-level PROFIBUS network, e.g. for purposes of visualization using HMI. When using the Basic central unit, 32-bit cyclic data can be exchanged with the control system. If an Advanced/ASIsafe central unit is used, the number is doubled to 64-bit cycle data. The acyclic calling of diagnostics data is possible with all central units.

**Diagnostics modules**

Faults, e.g. cross-circuit, are indicated directly on the diagnostics display. The fault is diagnosed directly in plain text by the detailed alarm message. The device is fully functional upon delivery. No programming is required.

**Parameterization software**

Using the MSS ES graphical parameterization tool it is very easy to create the safety functions as well as their logical links on the PC. It is therefore possible to define disconnection ranges, ON-delays, OFF-delays and other dependencies for example.

MSS ES also offers comprehensive functions for diagnostics and commissioning. Documentation of the MSS hardware configuration and the parameterized logic is created automatically.

# PROFIBUS

## SIRIUS 3RK3 Modular Safety System

### General data

### Overview (continued)

3

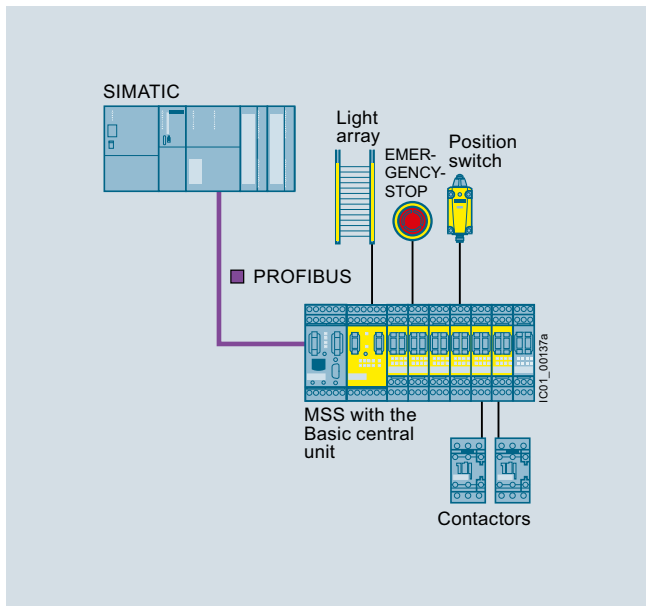

System configuration with the Basic central unit

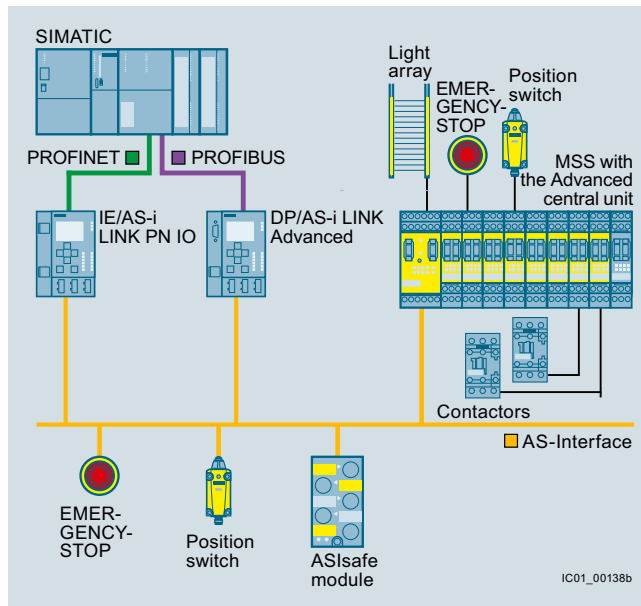

System configuration with the Advanced central unit

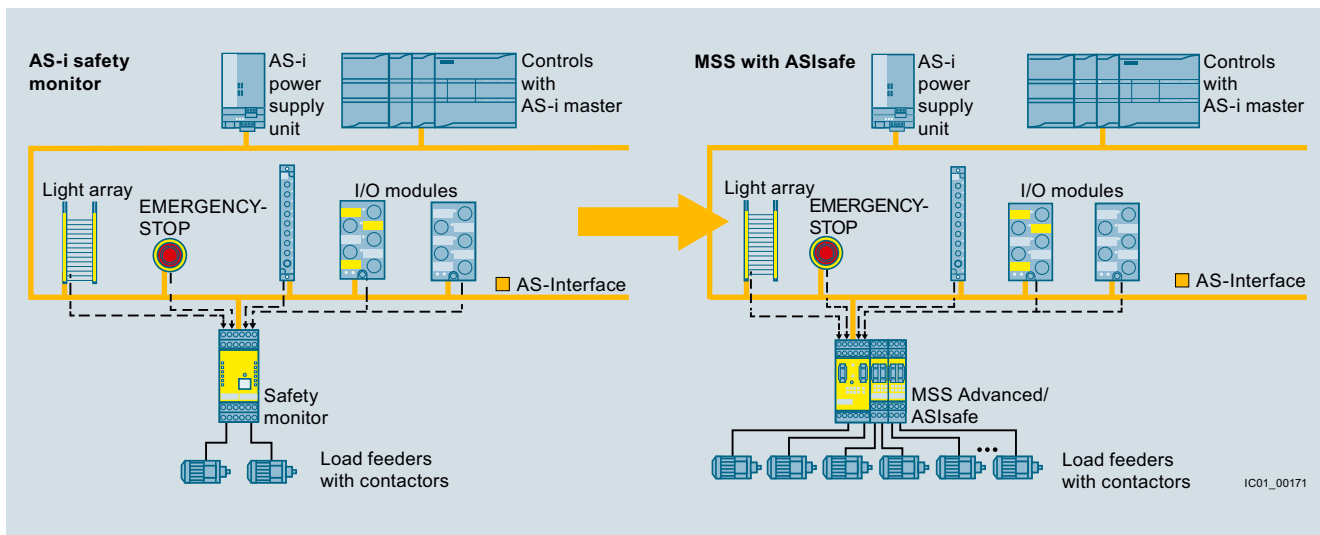

Further development of the system design: from the safety monitor to MSS Advanced/MSS ASIsafe



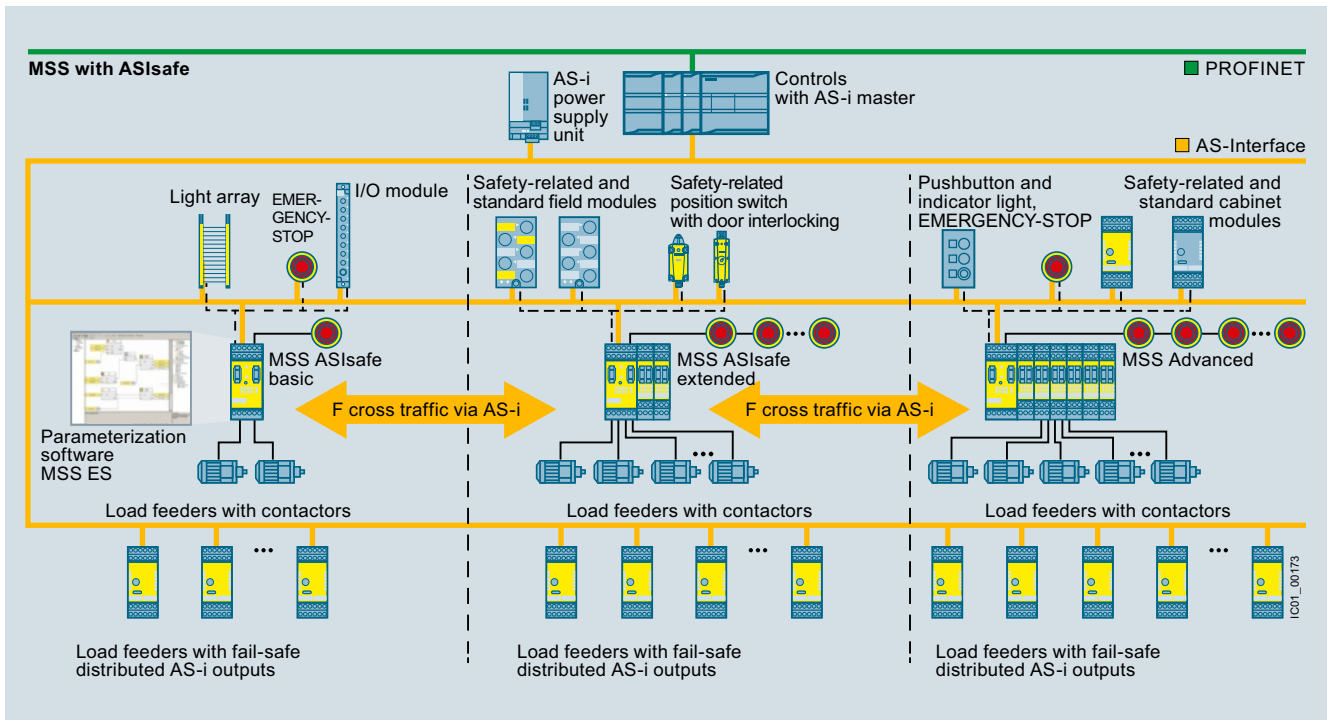

**Overview** (continued)

MSS with ASIsafe

**Connection methods**

Selection tables for the SIRIUS 3RK3 Modular Safety System can be found on the following pages.

-  Screw terminals
-  Spring-type terminals

**Benefits**

- More functionality and flexibility through freely configurable safety logic
- Suitable for all safety applications thanks to compliance with the highest safety standards in factory automation
- For use all over the world through compliance with all product-relevant, globally established certifications
- Modular hardware configuration
- Parameterization by means of software instead of wiring
- Removable terminals for greater plant availability
- Distributed collection from sensors and disconnection of actuators through AS-Interface
- All MSS ES logic functions are also usable for AS-Interface, e. g. muting, interlocking protective door
- Up to 12 independent safe switch-off groups on the AS-i bus
- Volume of project data can be greatly increased by means of AS-Interface
- Up to 50 two-channel enabling circuits per system

# PROFIBUS

## SIRIUS 3RK3 Modular Safety System

### General data

#### Benefits (continued)

##### Communication via PROFIBUS

The 3RK3 Modular Safety System can be connected to PROFIBUS through the DP interface and exchange data with higher-level control systems.

The MSS supports among other things:

- Baud rates up to 12 Mbit/s
- Automatic baud rate detection
- Cyclic services (DPV0) and acyclic services (DPV1)
- Exchange of 32-bit cyclic data with MSS Basic or 64-bit cyclic data with MSS Advanced/MSS ASIsafe
- Diagnostics using data record invocations

##### AS-Interface communication

Using the Advanced and ASIsafe central units, the 3RK3 Modular Safety System can be integrated in AS-Interface.

- MSS can read in up to 31 AS-i sensors
- Up to 12 preprocessed signals per MSS can be placed on the AS-i bus, e.g. for F cross traffic or for disconnecting safe AS-i outputs
- Safe cross traffic between MSS Advanced and MSS ASIsafe or between other AS-i safety monitors
- Standard signals, e.g. for acknowledgment, can also be applied to the bus

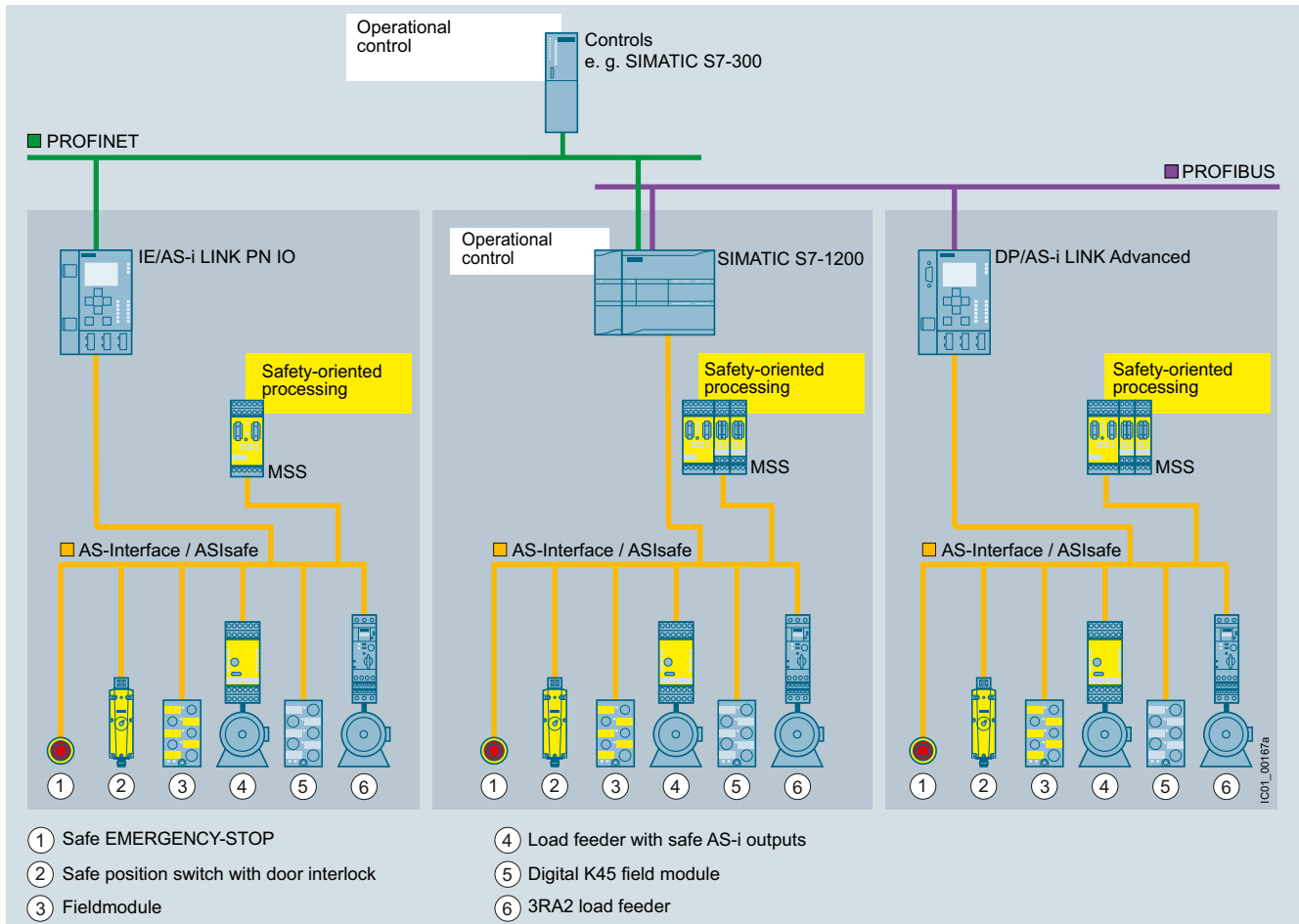

Integration of MSS into AS-Interface as ASIsafe Solution local

#### Notes:

MSS with communication function see page 3/306 onwards.







Accessories see page 3/308 onwards.

More information about AS-Interface with ASIsafe see Chapter 4 (AS-Interface).

More information about MSS ES see also Catalog IC 10, Chapter 14 "Parameterization, Configuration and Visualization with SIRIUS", Industry Mall or Interactive Catalog CA 01.





















## Application

The 3RK3 Modular Safety System can be used for all safety-related requirements in the manufacturing industry and offers the following safety functions:

	Symbol	MSS Basic	MSS Advanced, MSS ASIsafe
<i>Monitoring functions</i>			
<b>Universal monitoring</b> Evaluation of any binary signals from single-channel and two-channel sensors		--	✓
<b>EMERGENCY-STOP</b> Evaluation of EMERGENCY-STOP devices with positive-opening contacts		✓	✓
<b>Safety shutdown mats</b> Evaluation of safety shutdown mats with NC contacts and/or cross-circuit detection		✓	✓
<b>Protective door monitoring</b> Evaluation of protective door signals and/or protective flap signals		✓	✓
<b>Protective door interlocking</b> Evaluation of protective doors with interlock and of the actuation/release of this interlock		--	✓
<b>Enabling switches</b> Evaluation of enabling buttons with NO contact		✓	✓
<b>Two-hand operation</b> Evaluation of two-hand operator controls		✓	✓
<b>ESPE monitoring</b> Evaluation of non-contact protective devices, e.g. light curtains and laser scanners		✓	✓
<b>Muting</b> Temporary bridging of non-contact protective devices, 2/4 sensors in parallel, 4 sensors in sequence		--	✓
<b>Operating mode selector switches</b> Evaluation of operating mode selector switches with NO contacts		✓	✓
<b>Monitoring AS-i (AS-i 2F-DI)</b> Logic element for monitoring of AS-i input slaves		--	✓

✓ Available

-- Not available

	Symbol	MSS Basic	MSS Advanced, MSS ASIsafe
<i>Logic functions</i>			
<b>AND</b>		✓	✓
<b>OR</b>		✓	✓
<b>XOR</b>		✓	✓
<b>NAND</b>		✓	✓
<b>NOR</b>		✓	✓
<b>Negation</b>		✓	✓
<b>Flip-flop</b>		✓	✓
<i>Counting functions</i>			
<b>Counter 0 -&gt; 1</b>		✓	✓
<b>Counter 1 -&gt; 0</b>		✓	✓
<b>Counter 0 -&gt; 1/1 -&gt; 0</b>		✓	✓
<i>Timer functions</i>			
<b>With ON-delay</b>		✓	✓
<b>Passing make contact</b>		✓	✓
<b>With OFF-delay</b>		✓	✓
<b>Clock-pulsing</b>		✓	✓
<i>Start functions</i>			
<b>Monitored start</b>		✓	✓
<b>Manual start</b>		✓	✓
<i>Output functions</i>			
<b>Standard output</b>		✓	✓
<b>F output</b>		✓	✓
<b>AS-i output function</b>		--	✓
<i>Status functions</i>			
<b>Element status</b>		--	✓

## More information

System manual "3RK3 Modular Safety System" see  
<http://support.automation.siemens.com/WW/view/en/26493228>.

**PROFIBUS****SIRIUS 3RK3 Modular Safety System****3RK31 central units****Selection and ordering data**

3RK3111-1AA10

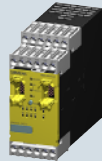
3RK3121-1AC00  
3RK3122-1AC00  
3RK3131-1AC10

Version

Screw terminals



Spring-type terminals



Article No.

Article No.

**3RK31 central units****3RK3 Basic**

Central unit with safety-related inputs and outputs

- 8 fail-safe inputs
- 1 two-channel relay output
- 1 two-channel electronic output

Max. 7 expansion modules can be connected

Note:

Memory module 3RK3931-0AA00 is included in the scope of supply.

**3RK3111-1AA10****3RK3111-2AA10****3RK3 Advanced**

Central units for connecting to AS-Interface with safety-related inputs and outputs and extended scope of functions

- 8 fail-safe inputs
- 1 two-channel relay output
- 1 two-channel electronic output

Max. 9 expansion modules can be connected

Note:

Memory module 3RK3931-0AA00 is included in the scope of supply.

**3RK3131-1AC10****3RK3131-2AC10****3RK3 ASIsafe**

Central units for connecting to AS-Interface with safety-related inputs and outputs and extended scope of functions

- 1 two-channel relay output
- 1 two-channel electronic output

**"Basic" version**

- 2 fail-safe inputs
  - 6 non-fail-safe inputs
- No expansion modules can be connected

**"Extended" version**

- 4 fail-safe inputs
  - 4 non-fail-safe inputs
- Max. 2 expansion modules can be connected







Note:

Memory module 3RK3931-0AA00 is included in the scope of supply.

**3RK3121-1AC00****3RK3121-2AC00****3RK3122-1AC00****3RK3122-2AC00**Notes:More information on MSS see  
[www.siemens.com/sirius-mss](http://www.siemens.com/sirius-mss).

More information on AS-Interface see Chapter 4 (AS-Interface).

**3RK32/33 expansion modules, 3RK35 interface modules, 3RK36 operating and monitoring modules**
**Selection and ordering data** (continued)

				
3RK3211-1AA10 3RK3221-1AA10 3RK3231-1AA10 3RK3242-1AA10	3RK3251-1AA10	3RK3311-1AA10 3RK3321-1AA10	3RK3511-1BA10	3RK3611-3AA00
Version			Screw terminals 	Spring-type terminals 
			Article No.	Article No.
<b>3RK32, 3RK33 expansion modules</b>				
<b>4/8 F-DI</b>				
Safety-related input modules • 8 inputs				
<b>2/4 F-DI 1/2 F-RO</b>				
Safety-related input/output modules • 4 inputs • 2 single-channel relay outputs				
<b>2/4 F-DI 2F-DO</b>				
Safety-related input/output modules • 4 inputs • 2 two-channel electronic outputs				
<b>4/8 F-RO</b>				
Safety-related output modules • 8 single-channel relay outputs				
<b>4 F-DO</b>				
Safety-related output modules • 4 two-channel electronic outputs				
<b>8 DI</b>				
Standard input module • 8 inputs				
<b>8 DO</b>				
Standard output module • 8 electronic outputs				
<b>3RK35 interface modules</b>				
<b>DP interface</b>				
PROFIBUS DP interface, 12 Mbit/s, RS 485, 32-bit cyclic data exchange with Basic central unit or 64-bit with Advanced and ASIsafe central unit, acyclic exchange of diagnostics data				
<b>3RK36 operating and monitoring modules</b>				
<b>Diagnostics module</b>				
			3RK3611-3AA00	--









**Notes:**

Connection cable required, see page 3/308.

 More information on MSS see  
[www.siemens.com/sirius-mss](http://www.siemens.com/sirius-mss).

 More information on AS-Interface see Chapter 4  
 (AS-Interface).

**PROFIBUS****SIRIUS 3RK3 Modular Safety System****Accessories****Selection and ordering data** (continued)

Version	Article No.
<b>Connection cables (essential accessory)</b>	
 <p><b>Connection cable</b> For connection of Central units with expansion modules or interface module</p> <p>3UF7932-0AA00-0</p>	<p>Diagnostics modules with central unit or interface module</p> <p>• Length 0.025 m (flat) • Length 0.1 m (flat) • Length 0.3 m (flat) • Length 0.5 m (flat) • Length 0.5 m (round) • Length 1.0 m (round) • Length 2.5 m (round)</p> <p><b>3UF7930-0AA00-0</b> <b>3UF7931-0AA00-0</b> <b>3UF7935-0AA00-0</b> <b>3UF7932-0AA00-0</b> <b>3UF7932-0BA00-0</b> <b>3UF7937-0BA00-0</b> <b>3UF7933-0BA00-0</b></p>
<b>PC cables and adapters</b>	
 <p><b>RS 232 PC cables</b> For connecting to the serial interface of a PC/PG, for communication with 3RK3 through the system interface</p> <p>3UF7940-0AA00-0</p>	<b>3UF7940-0AA00-0</b>
 <p><b>USB PC cables</b> For connecting to the USB interface of a PC/PG, for communication with 3RK3 through the system interface, recommended for use in connection with 3RK3</p> <p>3UF7941-0AA00-0</p>	<b>3UF7941-0AA00-0</b>
 <p><b>USB/serial adapters</b> For connecting an RS 232 PC cable to the USB interface of a PC</p> <p>3UF7941-0AA00-0</p>	<b>3UF7946-0AA00-0</b>
<b>Door adapters</b>	
 <p><b>Door adapters</b> For external connection of the system interface, e.g. outside a control cabinet</p> <p>3UF7920-0AA00-0</p>	<b>3UF7920-0AA00-0</b>
<b>Interface covers</b>	
 <p><b>Interface cover</b> For system interface</p> <p>3UF7950-0AA00-0</p>	<b>3UF7950-0AA00-0</b>
<b>Memory modules</b>	
 <p><b>Memory modules</b> For backing up the complete parameterization of the 3RK3 Modular Safety System without a PC/PG through the system interface</p> <p>3RK3931-0AA00</p>	<b>3RK3931-0AA00</b>
<b>Push-in lugs</b>	
 <p><b>Push-in lugs for screw fixing</b> e.g. on mounting plate, 2 units required per device Can be used for 3RK3</p> <p>3RP1903</p>	<b>3RP1903</b>

✓ Available

-- Not available



**Note:**

More accessories and components that can be combined with MSS see Chapter 4 (AS-Interface).

**Selection and ordering data** (continued)

**Parameterization, start-up and diagnostics software for 3RK3**

- Runs under Windows XP Professional (Service Pack 2 or 3), Windows 7 32/64-bit Professional/Ultimate/Enterprise (Service Pack 1)
- Delivered without PC cable (please order separately, see page 3/308)

	Version	Article No.
<b>Modular Safety System ES 2008 Basic</b>		
 <p>3ZS1314-4CC10-0YA5</p>	<p><b>Floating license for one user</b>            Engineering software in limited-function version for diagnostics purposes, software and documentation on CD, 3 languages (German/English/French), communication through system interface</p> <ul style="list-style-type: none"> <li>• License key on USB stick, Class A</li> <li>• License key download, Class A</li> </ul>	<p><b>3ZS1314-4CC10-0YA5</b>  <b>3ZS1314-4CE10-0YB5</b></p>
<b>Modular Safety System ES 2008 Standard</b>		
 <p>3ZS1314-5CC10-0YA5</p>	<p><b>Floating license for one user</b>            Engineering software, software and documentation on CD, 3 languages (German/English/French), communication through system interface</p> <ul style="list-style-type: none"> <li>• License key on USB stick, Class A</li> <li>• License key download, Class A</li> </ul>	<p><b>3ZS1314-5CC10-0YA5</b>  <b>3ZS1314-5CE10-0YB5</b></p>
	<p><b>Powerpack for MSS ES 2008 Basic to Standard</b>            Floating license for one user, engineering software, license key on USB stick, Class A, 3 languages (German/English/French), communication through system interface</p>	<p><b>3ZS1314-5CC10-0YD5</b></p>
	<p><b>Software Update Service</b>            For 1 year with automatic extension, assuming the current software version is in use, engineering software, software and documentation on CD, communication through system interface</p>	<p><b>3ZS1314-5CC10-0YL5</b></p>
<b>Modular Safety System ES 2008 Premium</b>		
 <p>3ZS1314-6CC10-0YA5</p>	<p><b>Floating license for one user</b>            Engineering software, software and documentation on CD, 3 languages (German/English/French), communication through PROFIBUS or the system interface, online diagnostics via PROFIBUS, creating, importing and exporting macros</p> <ul style="list-style-type: none"> <li>• License key on USB stick, Class A</li> <li>• License key download, Class A</li> </ul>	<p><b>3ZS1314-6CC10-0YA5</b>  <b>3ZS1314-6CE10-0YB5</b></p>
	<p><b>Powerpack for MSS ES 2008 Standard to Premium</b>            Floating license for one user, engineering software, license key on USB stick, Class A, 3 languages (German/English/French), communication through PROFIBUS or the system interface, online diagnostics via PROFIBUS, creating, importing and exporting macros</p>	<p><b>3ZS1314-6CC10-0YD5</b></p>
	<p><b>Software Update Service</b>            For 1 year with automatic extension, assuming the current software version is in use, engineering software, software and documentation on CD, communication through PROFIBUS or the system interface, online diagnostics via PROFIBUS, creating, importing and exporting macros</p>	<p><b>3ZS1314-6CC10-0YL5</b></p>

**Note:**

Description of the software versions see Catalog IC 10, Chapter 14 "Parameterization, Configuration and Visualization with SIRIUS", Industry Mall or Interactive Catalog CA 01.

# PROFIBUS

## Switching and Protection Devices for Power Distribution

### SENTRON Communication-Capable Circuit Breakers

#### Overview

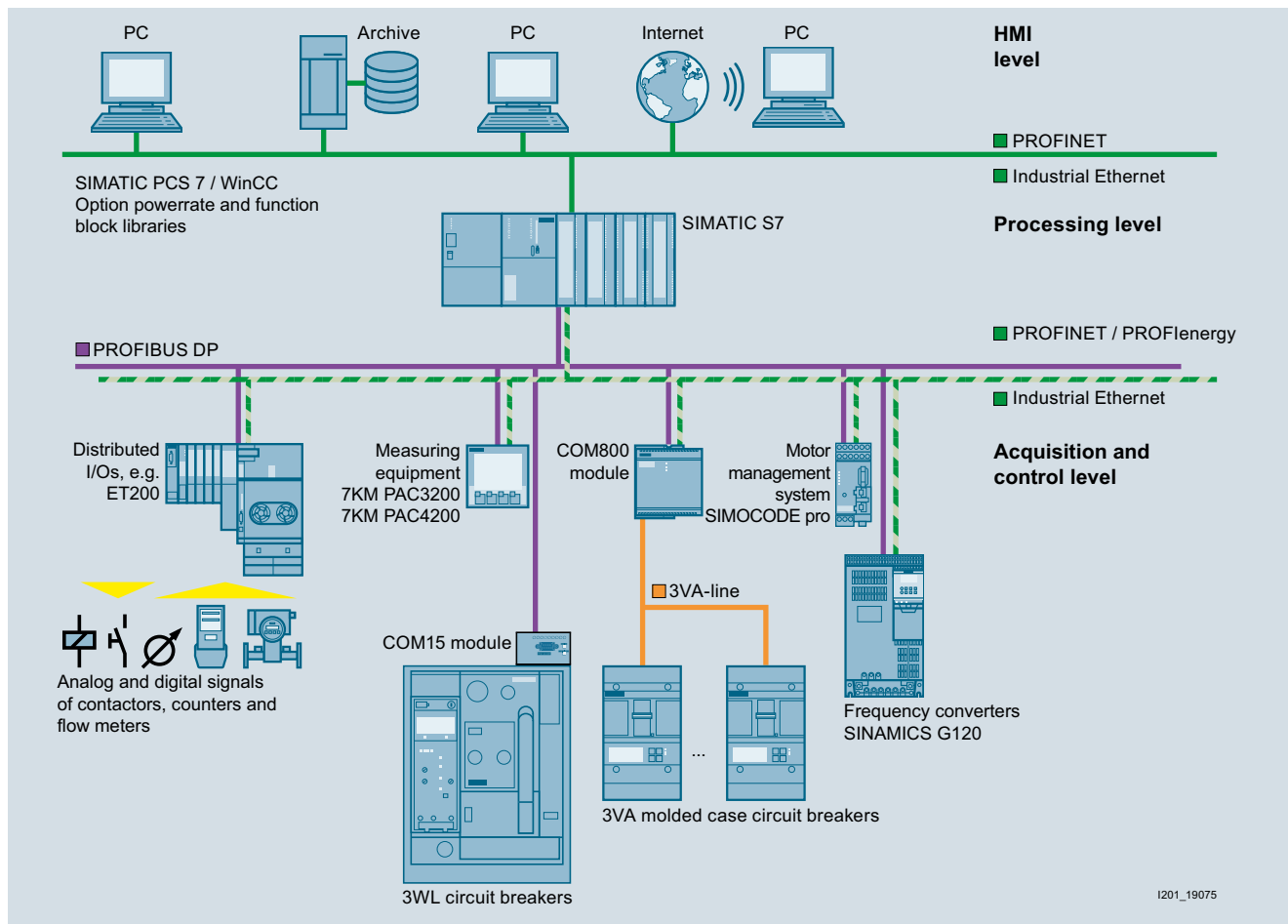

For more information about communication-capable SENTRON circuit breakers, see

- "3VA molded case circuit breakers" Product Information
- Catalog LV 10, Chapters 1 and 2
- Industry Mall, Sections "Building Technologies/Low-Voltage Power Distribution and Electrical Installation Technology"/"Protection Devices"/
  - "Molded Case Circuit Breakers"/**"SENTRON 3VA Molded Case Circuit Breakers"**
  - "Molded Case Circuit Breakers"/**"SENTRON 3VL Molded Case Circuit Breakers"**
  - "Air Circuit Breakers"/**"SENTRON 3WL Air Circuit Breakers"**



### Overview

#### Power monitoring system with the SENTRON product family



Components of the PC-based power monitoring system

The SENTRON product family offers the user not only power monitoring software in the form of SENTRON powermanager but also the corresponding hardware in the form of 7KT/7KM PAC measuring instruments and 3WL/3VL circuit breakers for the realization of a complete power monitoring system.

The components are optimally coordinated with each other. For example, special drivers for the SENTRON devices are integrated in the powermanager software so that on the one hand the power data acquisition can take place without any great configuration effort and, on the other hand, the most important measured values or states are indicated by predefined displays.

This reduces the engineering work for the customer and gives the user the assurance of knowing that the device functions are optimally supported in the software. Power monitoring software, powermanager.

#### Features of powermanager



User interface of powermanager

The power monitoring software powermanager is the central feature of the PC-based power monitoring system and

- is an independent power monitoring software.
- can be operated using a PC and measuring devices with Ethernet connection.
- is expandable from the simple standard application to a fully flexible customer solution.
- is fully scalable with regard to the number of devices and to the software's functions.
- ensures the optimum integration of measuring instruments from the 7KT/7KM PAC range, 3WL/3VL circuit breakers and other modbus devices.

# PROFIBUS

## Power Monitoring

### PC-based Power Monitoring System

#### Benefits

- Transparency of power flows
- Exact knowledge of the consumption profile
- Increase in energy efficiency
- Optimization of power supply contracts
- Compliance with contractual terms
- Assignment of power costs to cost centers
- Optimization of plant maintenance
- Identification of critical plant conditions
- Available languages:
  - German, English, Spanish, Portuguese
- Support of the various device communication interfaces (Modbus RTU, Modbus TCP)
- Status display of devices

#### Application

##### Applications

The product offers a standard power monitoring solution which provides the user with the following basic functions:

- Collection of measured quantities from the devices
- Presentation of the measured quantities from the devices in a predefined standard view for the 7KT PAC1500, 7KM PAC3100, 7KM PAC3200, 7KM PAC4200 measuring instruments and 3WL/3VL circuit breakers
- Free presentation of measured quantities possible, including from non-Siemens devices using generic Modbus drivers
- Archiving of measured quantities
- Monitoring of status and limits, with generation of corresponding signals
- Load curve display for visualizing the archived data and online data
- Cost center reports based on predefined tariffs and archived consumption data
- OPC server
- Configuration of the system including user management
- Load monitoring for complying with power limits
- Virtual computation

This standard solution is designed with cost-efficiency and simple system commissioning in mind.

#### System configuration

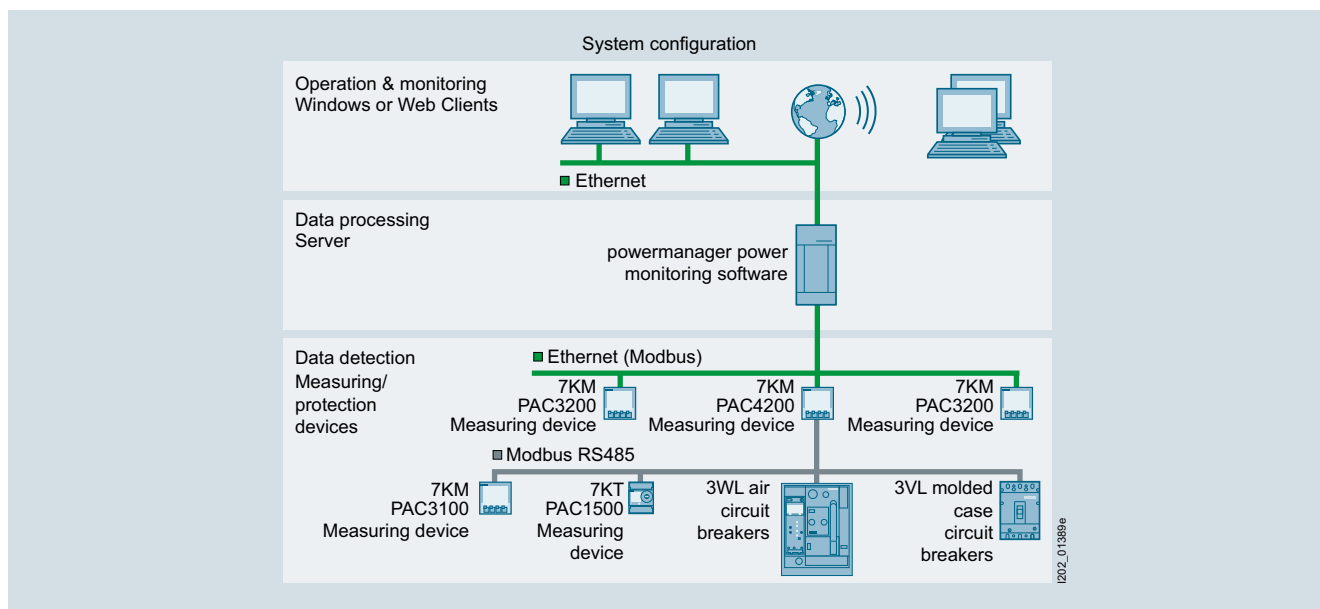

- Integration of measuring devices by means of predefined device templates for the 7KT/7KM PAC measuring devices and the 3WL/3VL circuit breakers
- Integration of existing Modbus-capable
- detecting devices is easy
- Communication through Standard Ethernet
- Integration of devices with RS 485 interface (ModbusRTU) through Modbus gateway, e. g. the 7KM PAC4200 measuring device can be used as gateway

#### Industries

The energy efficiency that can be achieved with consistent power monitoring and the derived optimization measures is crucial for all industries, e. g. in the manufacturing industry, in non-residential buildings, in the field of services, and in infrastructure projects. This has a particular impact on competitiveness, particularly in view of rising energy prices.

**More information****TÜV certification**

TÜV Rhineland Certificate for SENTRON powermanager

**Hardware components**

Hardware components of the PC-based power monitoring system are

- 7KM PAC measuring devices, see measuring devices
- 3WL air circuit breakers, see SENTRON protection, switching, measuring and monitoring devices > Protective devices > Air circuit breakers
- 3VL molded case circuit breakers, see SENTRON protection, switching, measuring and monitoring devices > Protective devices > Molded case circuit breakers

**Software**

The software for the PC-based power monitoring system is powermanager, see Low-voltage power distribution and electrical installation technology > Software > Configuring, visualizing and controlling with SENTRON

**Internet**

You can find more information on the Internet at:

<http://www.siemens.com/lowvoltage/powermonitoring>

# PROFIBUS

## Power Monitoring

### SIMATIC-based Power Data Management System

#### Overview

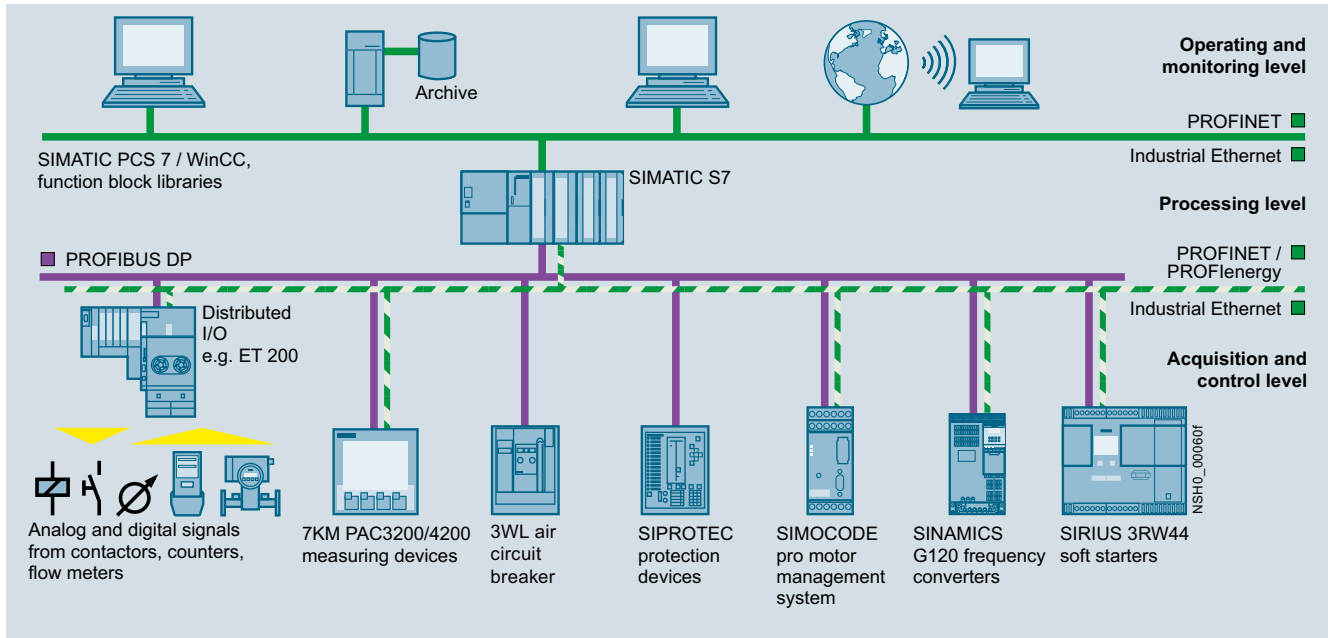

#### *SIMATIC-based solutions for the process and manufacturing industry*

A key feature of the process and manufacturing industry is its very high power consumption. It therefore makes sense to integrate an power data management system in existing systems.

#### **Communication through PROFIBUS DP**

PROFIBUS DP enables integration of a wide range of devices:

- For the protection of distribution boards and loads:
- protective devices, such as circuit breakers
- For control: frequency converters, motor management systems and soft starters
- For detection
  - electrical measured quantities: via the 7KM PAC3200/4200 measuring devices
  - non-electrical measured quantities: via analog/digital converters

#### **PROFINET and PROFinergy**

An increasing number of devices in automation technology offer PROFINET. A 7KM PAC Switched Ethernet PROFINET expansion module is also available for the 7KM PAC3200 und 7KM PAC4200 measuring devices.

PROFinergy is a "Common Application Profile" from the PNO. Thanks to PROFinergy it is possible to assemble an power data management system with standardized device interfaces.

#### **Function block libraries for SIMATIC PCS 7 and WinCC**

The function block library for SIMATIC PCS 7 and WinCC ensures device integration as follows:

- Measured quantities and states can be connected via CFC.
- Structured display of measured quantities and protection parameters for the 3WL/3VL circuit breakers.
- Limit value violations are displayed, archived and acknowledged in the relevant communications system in the usual way
- Circuit breakers can be program-controlled or manually operated with the appropriate user authorization

**Benefits**

- Increased energy efficiency due to exact knowledge of the load profile
- Optimization of power supply contracts
- Assignment of power costs to cost centers
- Optimization of plant maintenance
- Identification of critical plant conditions
- Reliable monitoring of the power limit through automatic load management

**Application**

The SIMATIC PCS 7 and WinCC library function blocks are used in all industries in which PCS 7 and WinCC are used, and the transparency and monitoring of power flows is crucial.

**More information****Hardware components**

Hardware components of the SIMATIC-based power data management system are

- 7KM PAC measuring devices, see measuring devices
- 3WL air circuit breakers, see SENTRON protection, switching, measuring and monitoring devices > Protective devices > Air circuit breakers
- 3VL molded case circuit breakers, see SENTRON protection, switching, measuring and monitoring devices > Protective devices > Molded case circuit breakers

**Software components**

The software components of the SIMATIC-based power data management system are

- Library 7KM PAC3200 for SIMATIC PCS 7
- Library 3WL/3VL for SIMATIC PCS 7
- Library 7KM PAC3200 for SIMATIC WinCC

All software components, see Low-voltage power distribution and electrical installation technology > Software > Configuring, visualizing and controlling with SIMATIC

**Internet**

You can find more information on the Internet at:

<http://www.siemens.com/lowvoltage/powermonitoring>

## PROFIBUS SENTRON Measuring Devices

### 7KM PAC3200 Measuring Devices

#### Overview



7KM PAC measuring devices: 7KM PAC3200 (left), 7KM PAC3100 (center) and 7KM PAC4200 (right)

#### 7KM PAC Measuring Devices

The 7KM PAC measuring devices are used to measure and indicate all relevant network parameters in low-voltage power distribution. They can be used for single-phase measurements as well as for multiphase measurements in 3 and 4-conductor networks (TN, TT, IT).

Energy values for main distribution boards, electrical feeders or individual loads are recorded precisely and reliably, and important measured values are supplied in addition for assessing the state of the plant and the quality of the network.

The 7KM PAC3100 measuring device is fitted with an integrated Modbus RTU interface via RS485, which means there is no need for an expansion module.

#### The specialist solution for precise energy measurement



SENTRON PAC3200 measuring device, English

When, where, and how much energy is used – transparent information is provided by the new 7KM PAC3200 measuring device. This device can be used wherever electrical energy is distributed. 7KM PAC3200 records more than 50 electrical parameters such as voltage, current, power, energy values, frequency, power factor and symmetry. The compact and high-performance power monitoring device records all consumption data extremely accurately and reliably.

#### Benefits

- Simple mounting and commissioning
- High IP65 degree of protection (front side, when installed) permits use in extremely dusty and wet environments
- Intuitive operation via 4 function buttons and multilingual plain text displays
- Easy adaptation to different systems using integrated and optional digital inputs and outputs
- Communication interfaces
- Worldwide use
- Min. 8 languages
- International approvals
- Developed and tested to European and international standards
- Low mounting depth

Additional performance characteristics of the 7KM PAC3200

- Precise energy recording
- Versatile system integration
  - Integrated Ethernet interface
  - Optional communication modules available
  - Multifunctional digital inputs and outputs
  - Limit monitoring
- Can be connected directly to power supply networks up to 690V AC (UL-L) and CATIII without voltage transformers (with the exception of devices with power supply units with extra-low voltage).
- Easy-to-use configuration software powerconfig included in the scope of delivery

Ordering data	Article No.	More information
<b>7KM PAC3200 measuring device</b> Control panel instrument 96 mm x 96 mm screw connections for current and voltage connection AC/DC wide-range power supply unit $U_{AUX}$ : 95 ... 240 V AC $\pm$ 10 %, 50/60 Hz 110 ... 340 V DC $\pm$ 10 % Measuring inputs $U_e$ : max. 3 AC 690/400 V, 50/60 Hz $I_e$ : /1 A or /5 A	<b>7KM2112-0BA00-3AA0</b>	<b>Accessories</b> For accessories, see Catalog LV 10 <b>Current transformers</b> Suitable current transformers can be found in the Catalog LV 10 under "Molded case circuit breakers" <b>Manual</b> The manual/operating instructions for the SENTRON PAC3200 power monitoring device can be found on the Internet at <a href="http://support.automation.siemens.com/WW/view/en/25240652/133300">http://support.automation.siemens.com/WW/view/en/25240652/133300</a>
<b>7KM PAC3200 measuring device</b> Control panel instrument 96 mm x 96 mm screw connections for current and voltage connection DC extra-low voltage power supply unit $U_{AUX}$ : 22 ... 65 V DC $\pm$ 10 % Measuring inputs $U_e$ : max. 3 AC 500/289 V, 50/60 Hz $I_e$ : /1 A or /5 A	<b>7KM2111-1BA00-3AA0</b>	<b>Internet</b> You can find more information on the Internet at: <a href="http://www.siemens.com/powermanagementsystem">http://www.siemens.com/powermanagementsystem</a>
<b>7KM PAC3200 measuring device</b> Control panel instrument 96 mm x 96 mm Ring cable lug connections for current and voltage connection AC/DC wide-range power supply unit $U_{AUX}$ : 95 ... 240 V AC $\pm$ 10 %, 50/60 Hz 110 ... 340 V DC $\pm$ 10 % Measuring inputs $U_e$ : max. 3 AC 690/400 V, 50/60 Hz $I_e$ : /1 A or /5 A	<b>7KM2112-0BA00-2AA0</b>	

## PROFIBUS SENTRON Measuring Devices

### 7KM PAC4200 Measuring Devices

#### Overview



#### **The professional solution for communication and monitoring**

The 7KM PAC4200 measuring devices have the same basic properties as the 7KM PAC3200 measuring devices. The device records a total of around 200 measured values, including basic data for assessing the system quality. Furthermore it has convenient additional functions such as user-defined displays, internal device memory, integral time-of-day and calendar function and gateway function.

#### Benefits

- Simple mounting and commissioning
- High IP65 degree of protection (front side, when installed) permits use in extremely dusty and wet environments
- Intuitive operation via 4 function buttons and multilingual plain text displays
- Easy adaptation to different systems using integrated and optional
  - Digital inputs and outputs
  - Communication interfaces
- Worldwide use
  - Min. 8 languages
  - International approvals
  - Developed and tested to European and international standards
- Low mounting depth

Additional performance characteristics of the 7KM PAC4200:

- Precise energy recording
- Versatile system integration
  - Integrated Ethernet interface
  - Optional communication modules available
  - Multifunctional digital inputs and outputs
  - Limit monitoring
- Can be directly connected to power supply networks up to 690 V AC (UL-L), CATIII without voltage transformer (with the exception of devices with power supply units with extra-low voltage)
- Easy-to-use configuration software powerconfig included in the scope of delivery
- Monitoring of plant status and network quality
  - Basic information for evaluating network quality
  - Logging of plant operations through operational, operating and system events
- Recording of the power range through power averaging (load profile)
- Daily energy meters for apparent, active and reactive energy across 365 days for cut-off date assessment
- Detection of gas, water, compressed air or other energy sources via pulse counter to the digital inputs
- Can be expanded using modules to up to 10 digital inputs and 6 digital outputs
- Counters for apparent, active and reactive energy for the precise detection of the power consumption of a partial process or manufacturing process
- 10/100 Mbit/s Ethernet interface with gateway function for the easy connection of devices with serial RS485 interface via expansion module 7KM PAC RS485 to an Ethernet network
- Comprehensive convenience indicators, such as user-defined displays, bar and status indicators, phase diagram and list and histogram graphics
- Satisfies the accuracy requirements of class 0.2S high-precision utility meters according to IEC 62053-22, which are normally reserved for exacting industrial applications



Ordering data	Article No.	More information
<p><b>7KM PAC4200 measuring device</b></p> <p>Control panel instrument 96 mm x 96 mm screw connections for current and voltage connection AC/DC wide-range power supply unit <math>U_{AUX}</math>: 95 ... 240 V AC <math>\pm</math> 10 %, 50/60 Hz 110 ... 340 V DC <math>\pm</math> 10 % Measuring inputs <math>U_e</math>: max. 3 AC 690/400 V, 50/60 Hz <math>I_e</math>: /1 A or /5 A</p>	<p><b>7KM4212-0BA00-3AA0</b></p>	<p><b>Accessories</b></p> <p>For accessories, see Catalog LV 10</p> <p><b>Current transformers</b></p> <p>Suitable current transformers can be found in the Catalog LV 10 under "Molded case circuit breakers"</p> <p><b>Manual</b></p> <p>The manual / operating instructions for 7KM PAC4200 measuring devices can be found on the Internet at <a href="http://support.automation.siemens.com/WW/view/en/31675630/133300">http://support.automation.siemens.com/WW/view/en/31675630/133300</a></p>
<p><b>7KM PAC4200 measuring device</b></p> <p>Control panel instrument 96 mm x 96 mm screw connections for current and voltage connection DC extra-low voltage power supply unit <math>U_{AUX}</math>: 22 ... 65 V DC <math>\pm</math> 10 % Measuring inputs <math>U_e</math>: max. 3 AC 500/289 V, 50/60 Hz <math>I_e</math>: /1 A or /5 A</p>	<p><b>7KM4211-1BA00-3AA0</b></p>	<p><b>Internet</b></p> <p>You can find more information on the Internet at: <a href="http://www.siemens.com/lowvoltage/powermonitoring">http://www.siemens.com/lowvoltage/powermonitoring</a></p>
<p><b>7KM PAC4200 measuring device</b></p> <p>Control panel instrument 96 mm x 96 mm Ring cable lug connections for current and voltage connection AC/DC wide-range power supply unit <math>U_{AUX}</math>: 95 ... 240 V AC <math>\pm</math> 10 %, 50/60 Hz 110 ... 340 V DC <math>\pm</math> 10 % Measuring inputs <math>U_e</math>: max. 3 AC 690/400 V, 50/60 Hz <math>I_e</math>: /1 A or /5 A</p>	<p><b>7KM4212-0BA00-2AA0</b></p>	

## PROFIBUS SENTRON Measuring Devices

### 7KM PAC Switched Ethernet PROFINET Expansion Module

#### Overview



7KM PAC Switched Ethernet expansion module

The 7KM PAC Switched Ethernet PROFINET expansion module is a plug-in communication module for 7KM PAC3200 and 7KM PAC4200 measuring devices.

It provides the following features:

- Standardized PROFlenergy interface to the measured quantities.
- The measured quantities can be individually selected using a GSDML file. This permits use of cost-effective S7 CPUs.
- Easy parameter assignment using the device display and STEP 7.
- Integrated Ethernet switching allows networking with short cables without additional switches.
- Direct integration in production machine networks using IRT (IRT = Isochronous-Real-Time).
- Full support of PROFINET IO (DHC, DNS, SNMP, SNTIP).
- Device replacement without PG in the PROFINET assembly using LLDP.
- Deterministic reversing time through ring redundancy (MRP).
- Modbus TCP communication
- Communication with powermanager or powerconfig
- 2 x Ethernet (RJ45) sockets.
- Baud rates 10 and 100 Mbit/s.
- Protocols PROFINET IO, PROFlenergy and Modbus TCP.
- No external auxiliary power necessary
- Additional display via the device display and via LEDs on the module

All measured quantities from 7KM PAC3200 and 7KM PAC4200 can be individually selected and cyclically transmitted by means of the GSDML file. This enables optimum use of the process image of the PROFINET controller, e. g. CPU 315-2 PN/DP of SIMATIC S7.

The measured quantities can be read out in acyclic mode using PROFlenergy, a PNO protocol profile. Thanks to PROFlenergy, it is possible to assemble a power monitoring system with devices from various manufacturers using PROFINET.

#### Ordering data

##### 7KM PAC Switched Ethernet PROFINET expansion module

Expansion module for 7KM PAC3200 and 7KM PAC4200 (PROFlenergy)

#### Article No.

**7KM9300-0AE01-0AA0**

### Overview



PAC PROFIBUS DP expansion module for SENTRON PAC3200 Power Monitoring Device

The 7KM PAC PROFIBUS DP expansion module offers the following features:

- The 7KM PAC PROFIBUS DP expansion module offers the following features:
- Plug-in communication module for measuring devices for connection to PROFIBUS DPV1
- 7KM PAC3200 and 7KM PAC4200
- Can be configured locally via the front of the device or using parameterization software
- Using PROFIBUS DPV1, data can be transferred in both cyclic and acyclic modes
- Easy engineering thanks to integration in SIMATIC STEP 7 and/or simple integration via GSD file for other programming systems
- Optimum use of process image of a control system for selection of individual measured quantities for cyclical transfer
- Supports all baud rates from 9.6 kbit/s up to 12 Mbit/s
- Connection through 9-pole Sub-D connector according to IEC 61158
- No external auxiliary power necessary
- Additional display via the device display and via LEDs on the module

### Ordering data

### Article No.

#### 7KM PAC PROFIBUS DP expansion module

Expansion module for 7KM PAC3200 and 7KM PAC4200 (PROFIBUS DPV1)

7KM9300-0AB01-0AA0

## PROFIBUS SENTRON Measuring Devices

### 7KM PAC RS485 Expansion Module

#### Overview



PAC RS485 expansion module for SENTRON PAC3200  
Power Monitoring Device

The 7KM PAC RS485 expansion module offers the following features:

- Plug-in 7KM PAC RS485 communication module for 7KM PAC3200 and 7KM PAC4200 measuring devices
- Can be configured locally from the front of the device or using parameterization software
- Supports the Modbus RTU protocol
- Plug and play
- Supports baud rates 4.8 / 9.6 / 19.2 and 38.4 kbit/s.
- Connection by means of 6-pole screw terminals
- No external auxiliary power necessary
- Status indication via LED on the module
- The 7KM PAC RS485 expansion module is required for the gateway function of the 7KM PAC4200 for communication with simple devices with RS485 interface, such as the 7KM PAC3100, via Ethernet (Modbus TCP).

#### Ordering data

##### 7KM PAC RS485 expansion module

Expansion module for  
7KM PAC3200 and  
7KM PAC4200  
(Modbus RTU)

#### Article No.

**7KM9300-0AM00-0AA0**

**Overview**

SENTRON PAC 4DI/2DO expansion module

The 7KM PAC 4DI/2DO expansion module is used to expand the 7KM PAC4200 measuring device to up to 10 digital inputs and 6 digital outputs and offers the following features.

- Up to two 7KM PAC 4DI/2DO modules can be plugged onto a 7KM PAC4200.
- The 7KM PAC 4DI/2DO expansion modules mean that the internal digital inputs and outputs can be expanded by up to 8 inputs and 4 outputs.
- The 7KM PAC 4DI/2DO expansion modules can be configured locally at the front of the device or via the powerconfig parameterization software.
- The digital inputs can be used without the need for an external power supply as they are self-powered. This is particularly useful for the integration of non-electric measuring devices, such as water or compressed-air counters.
- All functions of the integrated multifunctional inputs/outputs of the 7KM PAC4200 are also available in the 7KM PAC 4DI/2DO expansion module.
- Inputs and outputs can be used as an S0 interface conforming to IEC 62053-31.
- The connection is made via a 9-pole screw terminal.
- No external auxiliary power supply is required.

**Ordering data**
**Article No.**
**7KM PAC 4DI/2DO expansion module**
**7KM9200-0AB00-0AA0**

Expansion module for 7KM PAC4200

## PROFIBUS

### Configuring, Visualizing and Controlling with SIMATIC

#### Library 7KM PAC3200 for SIMATIC PCS

##### Overview

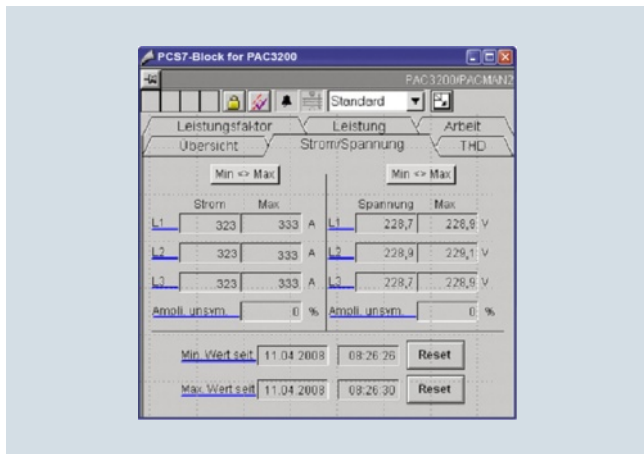

The 7KM PAC3200 for SIMATIC PCS 7 library is a block library for the 7KM PAC3200 and 7KM PAC4200 measuring devices. It allows seamless integration of the measuring devices into the PCS 7 process environment.

The 7KM PAC3200 for SIMATIC PCS 7 library consists of a driver block, a diagnostics block, and the faceplates. The blocks in the SIMATIC S7 supply energy data to the faceplates in the user interface of the process control system, generate signals and guarantee connection to the maintenance system of PCS 7.

##### Faceplates

Faceplates serve as a user interface for operator control and monitoring and enable technologically important values and functions of the 7KM PAC3200 / 4200 measuring device to be displayed and performed as a PCS 7 object.

On the system side, there are bidirectional communication connections both between the faceplates and the function blocks and between the function blocks and the 7KM PAC3200 / 4200 measuring device. They support the display of values in the faceplates and the forwarding of input data to the device.

This transforms the 7KM PAC3200 / 4200 measuring device into an integral component of PCS 7.

The operating systems supported are the same as those for the SIMATIC PCS 7.

##### Benefits

- Full integration of 7KM PAC3200/4200 measuring devices in the PCS 7 process control system through PROFIBUS DPV1 using a certified PCS 7 option
- Reading out and displaying device data
- Inputting limit values for monitoring through the driver block
- Resetting of values on the device (min/max values)

##### Application

The 7KM PAC3200 for SIMATIC PCS 7 library is used in all areas in which PCS 7 is used. Full integration in PCS 7 means that there is no need for a special system environment. Predefined modules and symbols give you the assurance of building on tested and certified product components.

For challenging measurements, the 7KM PAC4200 measuring device can also be used in the functional scope of the 7KM PAC3200.

In addition to the cyclic connection, there is also an acyclic connection for pure visualization tasks. The process image of the SIMATIC CPUs can be used more efficiently with the acyclic connection.

##### Ordering data

##### Article No.

##### Library 7KM PAC3200 for SIMATIC PCS 7<sup>1)</sup>

##### Engineering license

- For operation on one PCS 7 OS (single workstation system or server) and an automation system (AS).
- When using additional PCS 7 OS devices, you need an engineering license for each PCS 7 OS.

**3ZS2781-1CC11-0YG0**

##### Runtime license

- For operation on an additional AS

**3ZS2781-1CC10-6YH0**

<sup>1)</sup> Can also be used for 7KM PAC4200  
For currently supported SIMATIC PCS 7 versions see <http://support.automation.siemens.com>

### Overview

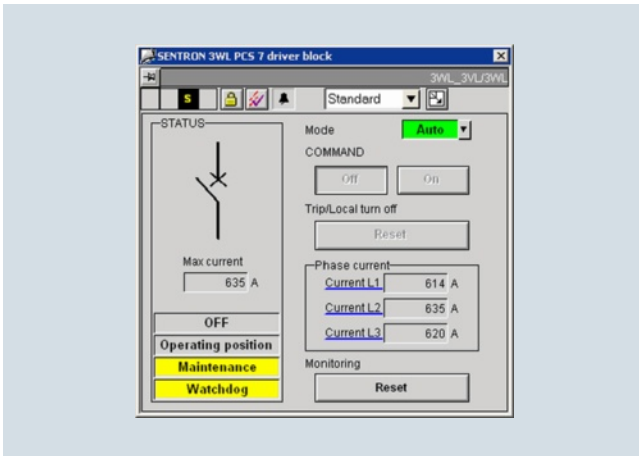

The 3WL / 3VL for SIMATIC PCS 7 library is a block library for the 3WL and 3VL circuit breakers. It allows seamless integration of the circuit breakers into the PCS 7 process environment.

The 3WL / 3VL for SIMATIC PCS 7 library consists of a driver block, a diagnostics block, and the faceplates. The blocks in the SIMATIC S7 supply current, power and energy data to the faceplates in the user interface of the process control system, generate signals and ensure connection to the PCS 7 maintenance system.

#### Faceplates

Faceplates serve as a user interface for operating and monitoring and make it easy for the circuit breaker to be displayed and operated as a PCS 7 object.

The 3WL / 3VL for SIMATIC PCS 7 library provides for continual plant transparency. Critical plant states are recognized quickly and costs due to outages avoided. System availability is permanently increased.

This transforms the circuit breaker into an integral component of PCS 7.

The operating systems supported are the same as those for the SIMATIC PCS 7.

### Benefits

- Full integration of the 3WL/3VL circuit breaker into the PCS 7 process control system through PROFIBUS DPV1 using a certified PCS 7 option
- Remote switching and monitoring
- Read-out of maintenance information
- Automatic information in case of overload, short circuit and faults
- Reading out and displaying device data
- Limit value monitoring by the driver block
- Resetting of values on the device (min/max values)

### Application

The 3WL/3VL for SIMATIC PCS 7 library is used in all areas in which PCS 7 is used. Full integration in PCS 7 means that there is no need for a special system environment. Predefined modules and symbols give you the assurance of building on tested and certified product components.

## PROFIBUS

### Configuring, Visualizing and Controlling with SIMATIC

#### Library 7KM PAC3200 for SIMATIC WinCC

##### Overview

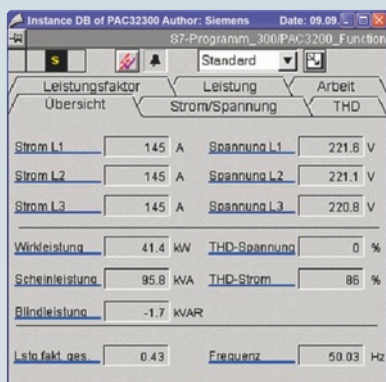

The 7KM PAC3200 for SIMATIC WinCC library is a block library for the 7KM PAC3200 and 7KM PAC4200 measuring devices. It allows seamless integration of the measuring devices into WinCC.

The 7KM PAC3200 for SIMATIC WinCC library consists of a driver block, a diagnostics block, and the faceplates. The blocks in the SIMATIC S7 supply energy data to the faceplates in the WinCC user interface, generate signals and ensure connection to the WinCC signaling system.

##### Faceplates

Faceplates serve as a user interface for operating and monitoring and enable technologically important values and functions of the 7KM PAC3200 / 4200 measuring device to be displayed and performed in WinCC.

On the system side, there are bidirectional communication connections both between the faceplates and the function blocks and between the function blocks and the 7KM PAC3200 / 4200 measuring device. They support the display of values in the faceplates and the forwarding of input data to the device.

This transforms the 7KM PAC3200 / 4200 measuring devices into an integral component of WinCC.

##### System requirements

The 7KM PAC3200 for SIMATIC WinCC library is released for WinCC V 7.0

WinCC options AS-OS Engineering and Basic Process Control must be installed. The function block library is available for S7-300, S7-400 and WinAC RTX.

At least one S7 CPU317-2DP is required for use in the S7-300 area. At least one S7 CPU414-2 is required for use in the S7-400 area.

The operating systems supported are the same as those for SIMATIC WinCC.

##### Benefits

- Full integration of the 7KM PAC3200/4200 measuring devices in SIMATIC WinCC through PROFIBUS DPV1. The library is a certified WinCC option.
- Reading out and displaying device data
- Inputting limit values for monitoring through the driver block
- Resetting of values on the device (min/max values)

##### Application

The 7KM PAC3200 for SIMATIC WinCC library is used in all areas in which WinCC is used. Predefined function blocks and symbols give you the assurance of building on tested and certified product components.

In addition to the cyclic connection, there is also an acyclic connection for pure visualization tasks. The process image of the SIMATIC CPUs can be used more efficiently with the acyclic connection.

##### Ordering data

##### Article No.

##### Library 7KM PAC3200 for SIMATIC WinCC <sup>1)</sup>

##### Engineering license

- For operation on one WinCC OS (single workstation system or server) and an automation system (AS).
- When using additional WinCC OS devices, you need an engineering license for each WinCC OS.

**3ZS2791-1CC11-0YGO**

##### Runtime license

- For operation on an additional AS

**3ZS2791-1CC10-6YH0**

<sup>1)</sup> Can also be used for 7KM PAC4200  
For currently supported SIMATIC WinCC versions see <http://support.automation.siemens.com>



### Overview



#### **powermanager: Power monitoring made easy**

With the PC-based powermanager power monitoring software and the measuring devices of the SENTRON family, Siemens offers an ideal solution for power monitoring in non-residential buildings or smaller and medium-sized industrial plants. Energy costs are reduced and energy availability is increased – with a minimum initial investment and full expandability!

The powermanager records energy and power values as well as electrical parameters such as current, voltage or power factor (cos phi). It is possible not just to display the values, but also to monitor and archive them to perform analyses at a later time. To optimize power demand, this data can be displayed and then compared in the form of a load curve. Quick consumption analyses are possible by means of the supplied cost center reports or by means of freely structured reports according to individual requirements.

#### **The advantages at a glance**

- Low engineering overhead thanks to extensive default settings in the software
- High cost-effectiveness even for small systems thanks to low initial investment
- Direct access also possible over the web
- Comprehensive functions already included in the basic package, e.g. reporting
- Customer-specific adjustments and expansions possible at any time by means of option packages
- Identification of possible optimization and potential savings thanks to transparency in the power distribution
- Important module for power management systems, e.g. when designed according to the new EN 16001 standard
- Price advantage through favorably priced system packages comprising software and hardware

#### **Software functions**

- Recording and visualization of measured energy values
- Limit monitoring using freely configurable alarms
- Display of load profile or any other measured variables as a characteristic curve
- Predefined reports for the allocation of consumption and the resulting costs to any cost centers
- Freely configurable reports based on Excel
- Monitoring of circuit breaker statuses
- Preconfigured project settings enable you to get started easily

### Benefits

- Transparency of power flows
- Exact knowledge of the consumption profile
- Increased power efficiency
- Optimization of power supply contracts
- Compliance with contractual terms
- Allocation of power costs to cost centers
- Optimization of plant maintenance
- Identification of critical plant conditions
- Available languages: German, English, Spanish, Portuguese
- Support of the various device communication interfaces (Modbus RTU, Modbus TCP)
- Status display of devices

### Application

#### **Application**

The product offers a standard power monitoring solution which provides the user with the following basic functions:

- Collection of measured quantities from the devices
- Presentation of the measured quantities from the devices in a predefined standard view for the 7KT PAC1500, 7KM PAC3100, 7KM PAC3200, 7KM PAC4200 measuring devices and 3WL/3VL circuit breakers
- Free presentation of measured quantities possible, including from non-Siemens devices, using generic Modbus drivers
- Archiving of measured quantities
- Monitoring of status and limits, with generation of corresponding signals
- Load curve display for visualizing the archived data and online data
- Cost center reports based on predefined rates and the archived consumption data
- OPC server
- Configuration of the system including user management
- Load monitoring for complying with power limits
- Virtual computation

This standard solution is designed with cost-efficiency and simple system start-up in mind.

# PROFIBUS

## Configuring, Visualizing and Controlling with SENTRON

### powermanager

#### Application (continued)

3

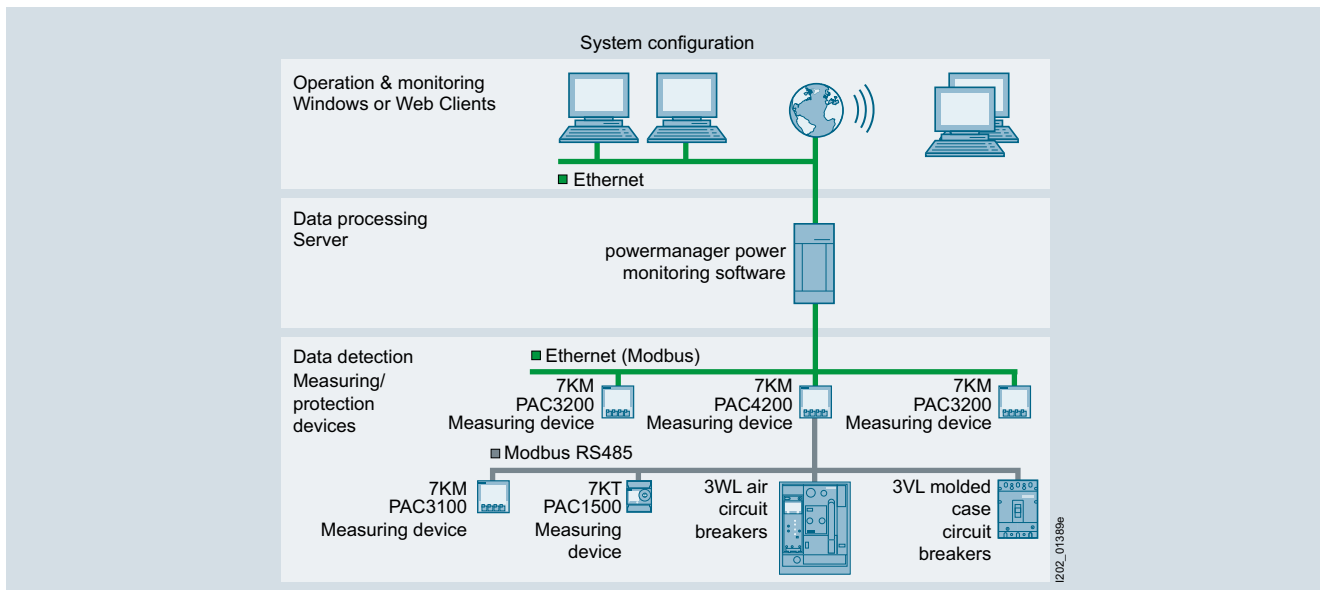

Topology of the power monitoring system with powermanager

#### Structure of a distributed system

Cross-site networking is possible with the "Distributed Systems" functionality:

- Linking of several autonomous SENTRON powermanager systems

- Each system can access and display measured variables and alarms of other systems.
- Cross-system report generation
- Increase in the maximum number of devices thanks to load distribution.

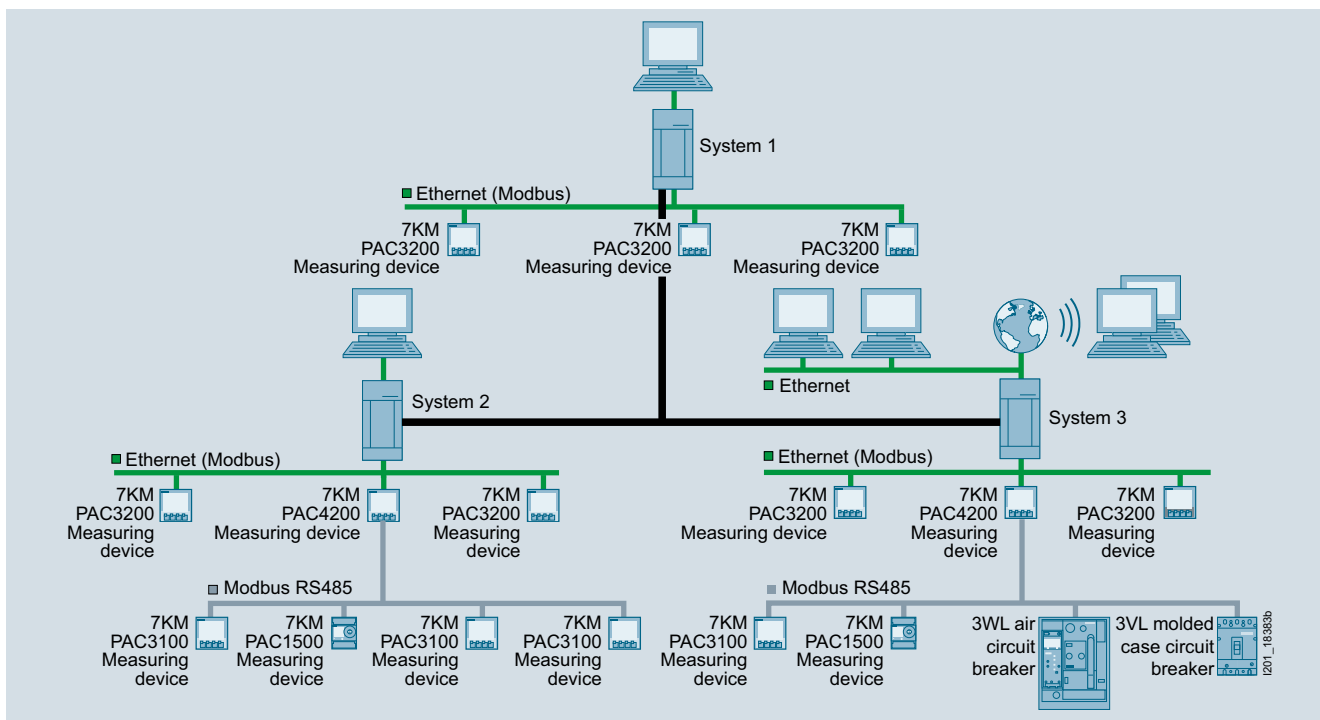

Topology of a distributed power monitoring system with powermanager system packages

Ordering data	Article No.	Article No.
<b>powermanager V 3.0</b> <ul style="list-style-type: none"> <li>• Trial license Up to 10 devices inc. "Expert" and "Web" option packs Full product license limited to 30 days</li> <li>• Basic package Full product license up to 10 devices, installation for client/server</li> <li>• Device pack (20) Device expansion license for up to 20 devices</li> <li>• Device pack (50) Device expansion license for up to 50 devices</li> <li>• Device pack (100) Device expansion license for up to 100 devices</li> <li>• Device pack (200) Device expansion license for up to 200 devices</li> <li>• Device pack (500) Device expansion license for up to 500 devices</li> <li>• Device pack (1 000) Device expansion license for up to 1 000 devices</li> <li>• Update license From V2.0 Lean to V3.0 (10)</li> <li>• Update license From V 2.0 Standard to V 3.0 (50)</li> <li>• Update license From V 2.0 Advanced to V 3.0 (100)</li> <li>• Update license From V 2.0 Maximum to V 3.0 (200)</li> </ul>	<b>3ZS2711-0CC30-0YA7</b>  <b>3ZS2711-0CC30-0YA0</b>  <b>3ZS2711-0CC30-0YD0</b>  <b>3ZS2712-0CC30-0YD0</b>  <b>3ZS2713-0CC30-0YD0</b>  <b>3ZS2714-0CC30-0YD0</b>  <b>3ZS2715-0CC30-0YD0</b>  <b>3ZS2716-0CC30-0YD0</b>  <b>3ZS2711-0CC30-0YE0</b>  <b>3ZS2712-0CC30-0YE0</b>  <b>3ZS2713-0CC30-0YE0</b>  <b>3ZS2714-0CC30-0YE0</b>	<b>Option packs</b> <ul style="list-style-type: none"> <li>• Option pack "Expert" Option for creating/presenting any number of freely configured images</li> <li>• Option pack "Web" Option for access via the Web (e.g. Internet Explorer) for up to 10 clients</li> <li>• Option pack "Client (5)" Expansion for up to 5 clients</li> <li>• Option pack "Distributed Systems (2)" Option for the connection of 2 autonomous powermanager systems For the exchange of measured values and alarms</li> <li>• Option pack "Distributed Systems (5)" Option for the connection of 5 autonomous powermanager systems For the exchange of measured values and alarms</li> <li>• Option pack "Distributed Systems (10)" Option for the connection of 10 autonomous powermanager systems For the exchange of measured values and alarms</li> </ul>
<b>powermanager V 2.0</b> <ul style="list-style-type: none"> <li>• Upgrade license From Lean to Standard</li> <li>• Upgrade license from Standard to Advanced</li> <li>• Upgrade license from Advanced to Maximum</li> </ul>	<b>3ZS2712-0CC20-0YD0</b>  <b>3ZS2713-0CC20-0YD0</b>  <b>3ZS2714-0CC20-0YD0</b>	<b>System packages</b> <p>System 1 Package comprising</p> <ul style="list-style-type: none"> <li>• 1 x powermanager V3.0 Basic Package</li> <li>• 1 x 7KM PAC4200 (+RS 485 module) and</li> <li>• 1 x 7KM PAC3100</li> </ul> <p>System 2 Package comprising</p> <ul style="list-style-type: none"> <li>• 1 x powermanager V3.0 Basic Package</li> <li>• 1 x 7KM PAC4200 (+RS 485 module) and</li> <li>• 1 x 7KT PAC1500 (+Modbus module)</li> </ul> <p>System 3 Package comprising</p> <ul style="list-style-type: none"> <li>• 1 x powermanager V3.0 Basic Package</li> <li>• 3 x 7KM PAC 3200</li> </ul>
		<b>3ZS2710-2CC20-0YH0</b>  <b>3ZS2710-1CC20-0YH0</b>  <b>3ZS2710-3CC00-0YD0</b>  <b>3ZS2718-1CC00-0YH0</b>  <b>3ZS2718-2CC00-0YH0</b>  <b>3ZS2718-3CC00-0YH0</b>  <b>3ZS2812-5CC20-0AY0</b>  <b>3ZS2812-6CC20-0YA0</b>  <b>3ZS2813-2CC20-0YA0</b>

## PROFIBUS

### Configuring, Visualizing and Controlling with SENTRON

#### powermanager

#### More information

##### System configuration

- Integration of measuring devices by means of predefined device templates for the 7KT/7KM PAC measuring devices and the 3WL/3VL circuit breakers
- Easy integration of already existing modbus-enabled measuring devices
- Communication through Standard Ethernet
- Integration of devices with RS485 interface (ModbusRTU) through Modbus gateway, e.g. the 7KM PAC4200 can be used as the gateway

##### System packages

The powermanager system packages enable simple and low-cost entry to power monitoring systems. At the same time, the system offers a sound basis for additional expansion with a host of 7KM/7KT PAC measuring devices and/or other expanded versions of powermanager.

The following system packages are available:

- powermanager System 1 for applications in infrastructure, comprising:
  - powermanager V3.0 Basic (3ZS2711-0CC30-0YA0)
  - 7KM PAC4200 (7KM4212-0BA00-3AA0)
  - 7KM PAC3100 (7KM3133-0BA00-3AA0)
  - 7KM PAC RS485 (7KM9300-0AM00-0AA0)
- powermanager System 2 for applications in buildings, comprising:
  - powermanager V3.0 Basic (3ZS2711-0CC30-0YA0)
  - 7KM PAC4200 (7KM4212-0BA00-3AA0)
  - 7KT PAC1500 (7KT1540)
  - 7KM PAC RS485 (7KM9300-0AM00-0AA0)
  - 7KT PAC RS485 (7KT1907)
- System 3 for applications in industry, comprising:
  - powermanager V3.0 Basic (3ZS2711-0CC30-0YA0)
  - 3x 7KM PAC3200 (7KM2112-0BA00-3AA0)

##### Industries

The energy efficiency that can be achieved through power management with consistent power monitoring and the derived optimization measures is crucial for all industries, e. g. in the manufacturing industry, in non-residential buildings, in the field of services, and in infrastructure projects. This has a particular impact on competitiveness, especially in view of rising energy prices.

##### System requirements

###### Hardware requirements

- Processor: Intel core 2 (or better)
- RAM: at least 2 GB
- Hard disk: min. 10 GB free
- Graphics: VGA with at least 1280 x 1024 pixels and 16-bit color intensity

###### Supported operating systems

- Windows XP: XP with SP3 (32 bit)
- Windows 2003: Professional SP3 (32 bit)
- Windows 7: Professional (32/64 bit)
- Windows Server 2008: Enterprise SP2 (32/64 bit)

###### Supported Excel versions (required for reporting)

- Excel 2003, Excel 2007, Excel 2010 (32 bit)

##### Internet

For a free download for powermanager V 3.0 trial license go to <http://support.automation.siemens.com/WWW/view/en/64850998>

For more information, go to

[www.siemens.com/powermanager](http://www.siemens.com/powermanager)

##### TÜV Certificate of Conformity ISO 50001

The TÜV Certificate of Conformity ensures that the 7KM/KT PAC measuring devices, the 3VL molded case circuit breaker, the 3WL air circuit breaker and the powermanager power monitoring software support the introduction of an operational power management system in accordance with ISO 50001. The ISO 50001 energy saving standard defines binding criteria for companies for sustainable energy management.



TÜV Rhineland Certificate for SENTRON powermanager

The TÜV Certificate is available at

<http://w3.siemens.com/powerdistribution/global/EN/lv/product-portfolio/software/software-sentron/powermanager/tuev-tested-quality/Documents/certificate-of-conformity-110267.pdf>

### Overview

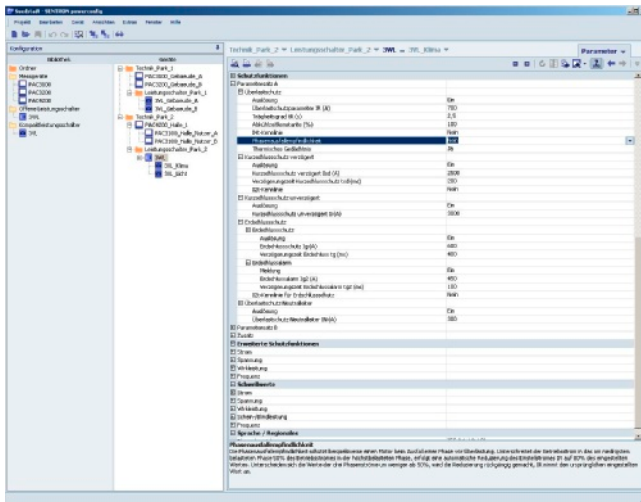

### powerconfig

The powerconfig software is the new combined commissioning and service tool for communication-capable measuring devices and circuit breakers from the SENTRON portfolio.

The PC-based tool makes the parameterization of the devices easier, which gives rise to a considerable time saving, particularly when several devices have to be set up.

With powerconfig, the 3WL and 3VL circuit breakers and the 7KM PAC measuring devices with expansion modules can be parameterized, documented, operated and monitored using various communication interfaces.

### Benefits

- Parameterization, documentation, operation and monitoring in one software
- Documentation of measured values and settings
- Clear presentation of the available parameters including plausibility testing of the inputs
- Display of the available device statuses and measured values in standardized views
- Project-oriented storage of device data
- Consistent operation and usability
- Support of the various device communication interfaces (Modbus RTU, Modbus TCP)
- Supported languages: English and German
- Read-out and saving of device recordings (device-dependent)
- Update of the device firmware and loading of language packs (device-dependent)
- No programming knowledge required for operation
- Communication via PROFIBUS and PROFINET and connection to STEP7 (in preparation)

### Benefits

- Parameterization, documentation, operation and monitoring in one software
- Documentation of measured values and settings
- Clear presentation of the available parameters including plausibility testing of the inputs
- Display of the available device statuses and measured values in standardized views
- Project-oriented storage of device data
- Uniform operation and usability support for the various device communication interfaces (Modbus RTU, Modbus TCP, PROFIBUS, PROFINET)
- Supported languages: English and German
- Read-out and saving of message lists, load profiles, and histories (device-dependent)
- Overview of the circuit breaker statuses with currents and events
- Individually selectable plant documentation
- Update of the device firmware and loading of language packs (device-dependent)
- No programming knowledge required for operation
- Call-up of powerconfig from STEP7 V5.5 SP1 and higher, and communication with devices via PROFIBUS/PROFINET

### Application

#### System requirements

##### Hardware requirements

- Processor: Intel Pentium III, 1 GHz (or better)
- RAM: at least 512 MB
- Hard disk drive: at least 1 GB free
- Color monitor with a minimum resolution of 1 024 x 768 pixels

##### Supported operating systems

- Windows XP: XP with SP3 (32 bit)
- Windows 7 Professional SP1 (32 bit, 64 bit)
- Windows 7 Ultimate SP1 (32 bit, 64 bit)
- Windows 2008 Server (32 bit)

##### Required framework

- Microsoft .NET-Framework in accordance with Readme file

**PROFIBUS**

## Configuring, Visualizing and Controlling with SENTRON

## powerconfig

**Ordering data****Article No.****Library 3WL/3VL for SIMATIC PCS 7<sup>1)</sup>****Engineering license**

- For operation on one PCS 7 OS (single workstation system or server) and an automation system (AS).
- When using additional PCS 7 OS devices, you need an engineering license each PCS 7 OS.

**3ZS2782-1CC10-0YG0****Runtime license**

- For operation on an additional AS

**3ZS2782-1CC10-6YH0**

<sup>1)</sup> Can also be used for 7KM PAC4200  
For currently supported SIMATIC PCS 7 versions see  
<http://support.automation.siemens.com>

**More information**

powerconfig is available free of charge at

<http://support.automation.siemens.com/WW/view/en/63452759>

You can find more information on the Internet at:

<http://www.siemens.com/sentron>

### Overview

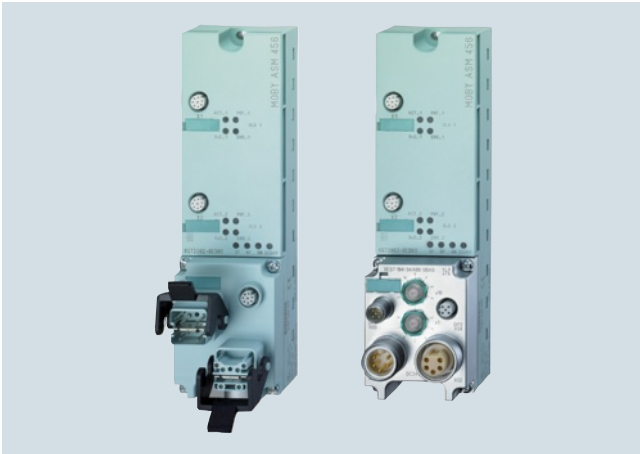

ASM 456 communication module, SIMATIC RF160C

The cost-efficient ASM 456 and SIMATIC RF160C communication modules are stand-alone PROFIBUS DP slaves used to operate the RFID systems MOBY D/U and SIMATIC RF200 / RF300 / RF600 as well as the MV400 code reading systems via PROFIBUS DP:

- SIMATIC S7 (including FB/FC software)
- SINUMERIK
- PC, IPC, non-Siemens PLC
- SIMOTION (with integrated software library)

Thanks to their high degree of protection and ruggedness, they are particularly suitable for machine-level use. The modular structure with different PROFIBUS connection systems allows them to be used in all applications. The uniform plug-in connection system ensures rapid commissioning.

### Benefits

**get** Designed for Industry

- Two parallel MOBY channels ensure real-time mode at dynamic read points.
- Modular design with different bus interfacing possibilities ensures universal implementation.
- Reader connection using an 8-pin M12 connector for quick mounting of all components.
- High-performance hardware ensures fast data exchange with the reader. Consequently, data is available for the application even faster.
- Very easy downloading of firmware via the SIMATIC MANAGER for function expansions and error rectification ensure high availability of the identification system.
- The parameterizable identification-system-specific PROFIBUS diagnostics facilitate start-up and troubleshooting.
- A wide selection of pre-assembled PROFIBUS connecting cables can be ordered for the communication modules. This saves time and money during installation and assures better quality.

### Application

The ASM 456 and SIMATIC RF160C communication modules have been specifically designed for a wide range of applications in industrial automation and logistics. Thanks to the high IP67 degree of protection, the ASM 456 and RF160C can be installed in the process without a control cabinet.

Main application areas for ASM 456 and RF160C:

- Mechanical engineering, automation systems, conveyor systems
- Ancillary assembly lines in the automobile industry/suppliers
- Small assembly lines
- Production, packaging, textile, plastics and printing machines SIMOTION

### Design

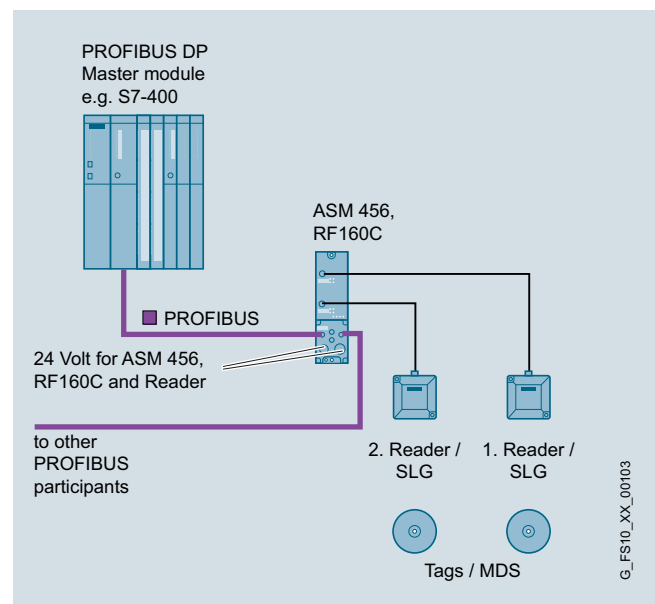

## PROFIBUS

### Industrial Identification Systems

#### ASM 456, SIMATIC RF160C

#### Function

The ASM 456 and the RF160C comprise a basic module and a connection block that must be ordered separately. When connecting PROFIBUS, the customer can choose between ECOFAST connections and M12, 7/8" connections.

A pre-assembled reader cable is used to connect one or two readers/SLGs to the communication module. The standard length of the cable is 2 m. If other cable lengths to the reader are required, an extension cable measuring between 2 m and 50 m can be used. The cable can also be assembled by the customer as required.

The PROFIBUS DP procedure according to EN 50170 Vol. 2 PROFIBUS for communication between the communication module and SIMATIC S7 (or any PROFIBUS master) and the MOBY-specific procedures for communication between ASM and reader are implemented on the communication modules.

The data in the transponder can be accessed as follows:

- Direct addressing via absolute addresses
- Conveniently via the MOBY file handler (MOBY U, RF300 only) using file names (for ASM 456 only)

On the PROFIBUS DP, the communication module occupies a node address on the bus that is set on the connection block. The communication module is integrated into the hardware configuration by means of a device master (GSD) file. Then the communication module can be configured by means of the software tool HW\_Config of the SIMATIC Manager or another PROFIBUS tool.

Error messages and operating states (MDS in the field, transmission, etc.) are indicated additionally by means of LEDs and simplify commissioning and service.

The ASM 456 and RF160C have two reader interfaces which also provides the readers with power. In the communication module, the power supply of the readers has an electronic fuse.

#### ASM 456

The ASM directly accesses the data in the transponder or in the data matrix code by means of absolute addresses (FB/FC45, FB/FC55) or more conveniently using the MOBY file handler (FC56) and file names. The communication module is operated in non-cyclic mode over PROFIBUS DP V1. Consequently, a very large amount of data can be transferred to/from the communication module without overloading the PROFIBUS cycle. This has advantages when transferring large volumes of data. In addition, the communication module can process concatenated transponder commands very quickly in this mode.

Function blocks FB101/116/132 in the SIMATIC S7 are available for the "RFID standard profile" mode. The data in the transponder can be addressed either via absolute addresses or via the file handler. This mode additionally integrates the communication module in SIMOTION.

#### SIMATIC RF160C

The data in the transponder is accessed via absolute addresses. The FC44 function block is available for SIMATIC S7 for this purpose. The RF160C is operated in cyclic mode over PROFIBUS DP-V0. This ensures a deterministic response in data communication in every case. Where large volumes of data are transferred in large-scale bus configurations, the data throughput should be tested with a tool which is provided on the DVD "RFID Systems, Software and Documentation". The programming interface to RF160C is extremely easy to use and can be programmed efficiently in any controller. The RF160C is therefore particularly suitable for use with non-Siemens controllers and older PROFIBUS masters.

#### Technical specifications

Article No.	6GT2002-0ED00	6GT2002-0EF00
Product-type designation	ASM 456 communication module	RF160C communication module
Suitability for installation	PROFIBUS matching DP-V1 in conjunction with RF200/300/600, MOBY D/E/I/U, MV	PROFIBUS matching DP-V0 in conjunction with RF200/300/600, MOBY D/U
Transfer rate with PROFIBUS	9.6 kbit/s ... 12 Mbit/s	9.6 kbit/s ... 12 Mbit/s
Transmission rate at point-to-point connection serial maximum	115.2 kbit/s	115.2 kbit/s
<b>Interfaces</b>		
Design of interface for point-to-point connection	RS422	RS422
Number of readers connectable	2	2
Design of the electrical connection		
• of the PROFIBUS interface	(according to the connection block)	(according to the connection block)
• for supply voltage	(according to the connection block)	(according to the connection block)
Version of the interface to the reader for communication	M12, 8-pin	M12, 8-pin
<b>Mechanical data</b>		
Material	Thermoplastic (Valox 467, fiberglass reinforced)	Thermoplastic (Valox 467, fiberglass reinforced)
Color	IP Basic 714	IP Basic 714
Tightening torque of screw for mounting the equipment maximum	3 N·m	3 N·m



**Technical specifications** (continued)

Article No.	6GT2002-0ED00	6GT2002-0EF00
Product-type designation	ASM 456 communication module	RF160C communication module
<b>Supply voltage, current consumption, power loss</b>		
Supply voltage for DC		
• rated value	24 V	24 V
• minimum	20 V	20 V
• maximum	30 V	30 V
Current consumed at 24 V with DC		
• without connected devices typical	0.08 A	0.08 A
• including connected devices maximum	0.8 A	0.8 A
<b>Permitted ambient conditions</b>		
Ambient temperature		
• during operating	0 ... 55 °C	0 ... 55 °C
• during storage	-40 ... +70 °C	-40 ... +70 °C
• during transport	-40 ... +70 °C	-40 ... +70 °C
Protection class IP	IP 67	IP 67
Resistance against shock	According to IEC 61131-2	According to IEC 61131-2
Resistance against shock	300 m/s <sup>2</sup>	300 m/s <sup>2</sup>
Resistance against vibration	100 m/s <sup>2</sup>	100 m/s <sup>2</sup>
<b>Design, dimensions and weight</b>		
Width	60 mm	60 mm
Height	30 mm	30 mm
Depth	210 mm	210 mm
Net weight	0.21 kg	0.21 kg
Mounting type	2 x M5 screws	2 x M5 screws
Cable length for RS 422 interface maximum	1 000 m	1 000 m
<b>Product properties, functions, components general</b>		
Type of display	4 LEDs per reader connection, 4 LEDs for device status	4 LEDs per reader connection, 4 LEDs for device status
Product function transponder file handler can be addressed	Yes	No
Protocol is supported		
• PROFIBUS DP-V0 protocol	No	Yes
• PROFIBUS DP-V1 protocol	Yes	No
<b>Product functions management, configuration</b>		
Type of parameterization	GSD	GSD
Type of programming	FB 45, FB 55, FC 56, Ident profile (PIB), (FC 45/55 with limited functionality)	FC 44
Type of computer-mediated communication	acyclic communication	Cyclic communication
<b>Standards, specifications, approvals</b>		
Verification of suitability	CE, FCC, cULus	CE, FCC, cULus
<b>Accessories</b>		
Accessories	Connection block for ECOFAST system or M12, 7/8"	Connection block for ECOFAST system or M12, 7/8"

# PROFIBUS

## Industrial Identification Systems

### ASM 456, SIMATIC RF160C

Ordering data	Article No.	Article No.
<b>ASM 456 communication module</b> For connecting 2 readers to PROFIBUS DP-V1.	<b>6GT2002-0ED00</b>	
<b>SIMATIC RF160C communication module</b> For connecting 2 readers to PROFIBUS DP-V0.	<b>6GT2002-0EF00</b>	
<i>Accessory: ECOFAST connection</i>		
<b>ECOFAST connection block</b>	<b>6ES7194-3AA00-0AA0</b>	
<b>PROFIBUS ECOFAST HYBRID plug 180</b> • With male insert (5-pack) • With female insert (5-pack)	<b>6GK1905-0CA00</b> <b>6GK1905-0CB00</b>	
<b>PROFIBUS ECOFAST termination plug</b> With terminating resistors.	<b>6GK1905-0DA10</b>	
<b>PROFIBUS ECOFAST hybrid cable, copper</b> Trailing-type cable (PUR casing) with two shielded copper cables for PROFIBUS DP and four copper cores of 1.5 mm <sup>2</sup> each.		
<b>Sold by the meter</b> Max. delivery unit 1 000 m, minimum ordering quantity 20 m.	<b>6XV1830-7AH10</b>	
<b>Pre-assembled</b> with ECOFAST male and female connector, fixed length:		
0.5 m	<b>6XV1830-7BH05</b>	
1 m	<b>6XV1830-7BH10</b>	
1.5 m	<b>6XV1830-7BH15</b>	
3 m	<b>6XV1830-7BH30</b>	
5 m	<b>6XV1830-7BH50</b>	
10 m	<b>6XV1830-7BN10</b>	
15 m	<b>6XV1830-7BN15</b>	
20 m	<b>6XV1830-7BN20</b>	
25 m	<b>6XV1830-7BN25</b>	
30 m	<b>6XV1830-7BN30</b>	
35 m	<b>6XV1830-7BN35</b>	
40 m	<b>6XV1830-7BN40</b>	
45 m	<b>6XV1830-7BN45</b>	
50 m	<b>6XV1830-7BN50</b>	
<i>Accessory: M12, 7/8" connection</i>		
<b>M12 connection block, 7/8"</b>		<b>6ES7194-3AA00-0BA0</b>
<b>M12 terminating resistor for PROFIBUS</b> Pack with 5 units, minimum ordering quantity 1 pack.		<b>6GK1905-0EC00</b>
<b>PROFIBUS M12 connecting cable</b> Pre-assembled, with 5-pin M12 connector and socket, max. length 100 m.		
0.3 m		<b>6XV1830-3DE30</b>
0.5 m		<b>6XV1830-3DE50</b>
1 m		<b>6XV1830-3DH10</b>
1.5 m		<b>6XV1830-3DH15</b>
2 m		<b>6XV1830-3DH20</b>
3 m		<b>6XV1830-3DH30</b>
5 m		<b>6XV1830-3DH50</b>
10 m		<b>6XV1830-3DN10</b>
15 m		<b>6XV1830-3DN15</b>
Other special lengths with 90° or 120° cable connection		See <a href="http://support.automation.siemens.com/WW/view/en/26999294">http://support.automation.siemens.com/WW/view/en/26999294</a>
<b>7/8" connecting cable</b> Pre-assembled, with 5-pin 7/8" connector and socket, max. length 50 m.		
0.3 m		<b>6XV1822-5BE30</b>
0.5 m		<b>6XV1822-5BE50</b>
1 m		<b>6XV1822-5BH10</b>
1.5 m		<b>6XV1822-5BH15</b>
2 m		<b>6XV1822-5BH20</b>
3 m		<b>6XV1822-5BH30</b>
5 m		<b>6XV1822-5BH50</b>
10 m		<b>6XV1822-5BN10</b>
15 m		<b>6XV1822-5BN15</b>
Other special lengths with 90° or 120° cable connection		See <a href="http://support.automation.siemens.com/WW/view/en/26999294">http://support.automation.siemens.com/WW/view/en/26999294</a>
<b>PROFIBUS FC Standard Cable</b> Standard type with special design for quick mounting, 2-core, shielded, sold by the meter; maximum ordering quantity unit 1 000 m, minimum ordering quantity 20 m.		<b>6XV1830-0EH10</b>
<b>PROFIBUS M12 cable connector</b> Pack with 5 units, minimum ordering quantity 1 pack. • With male insert • With female insert		<b>6GK1905-0EA00</b> <b>6GK1905-0EB00</b>
<b>7/8" cable connector for voltage</b> Pack with 5 units, minimum ordering quantity 1 pack. • With male insert • With female insert		<b>6GK1905-0FA00</b> <b>6GK1905-0FB00</b>
<b>Sealing caps 7/8"</b> For unused 24 V cable extension, pack of 10, minimum ordering quantity 1 pack.		<b>6ES7194-3JA00-0AA0</b>
<b>Power line</b> 5-core, 5 x 1.5 mm <sup>2</sup> , trailing type; sold by the meter; maximum ordering quantity 1 000 m, minimum ordering quantity 20 m.		<b>6XV1830-8AH10</b>

**Ordering data****Article No.****Article No.***General accessories***Stainless steel screws for connection blocks**

Optional screws made of V4A steel for securing the connection blocks on the basic module.  
 For use in wet areas.  
 Pack with 40 units is sufficient for 10 connection blocks.

**6GT2090-0VB00***Accessories for RFID***MOBY U reader cable**

PUR material, CMG approval, suitable for cable carriers.

2 m

**6GT2091-4FH20**

5 m

**6GT2091-4FH50****MOBY D reader cable**

PUR material, CMG approval, suitable for cable carriers, 2 m.

**6GT2691-4FH20****Reader cable for SIMATIC RF200 / RF300 / RF600 / MV400**

or extension cable MOBY U/D and SIMATIC RF200 / RF300 / RF600 / MV400, PUR material, CMG approval, suitable for cable carriers, straight connector

2 m

**6GT2891-4FH20**

5 m

**6GT2891-4FH50**

10 m

**6GT2891-4FN10**

20 m

**6GT2891-4FN20**

50 m

**6GT2891-4FN50**

2 m, plug angled at reader

**6GT2891-4JH20**

5 m, plug angled at reader

**6GT2891-4JH50****Sealing caps M12 for unused reader connections**

Minimum ordering quantity 10 units.

**3RX9802-0AA00****DVD "RFID Systems Software & Documentation"****6GT2080-2AA20**

# PROFIBUS

## Engineering/Network Management/Diagnostics

### SIMATIC PDM

#### Overview

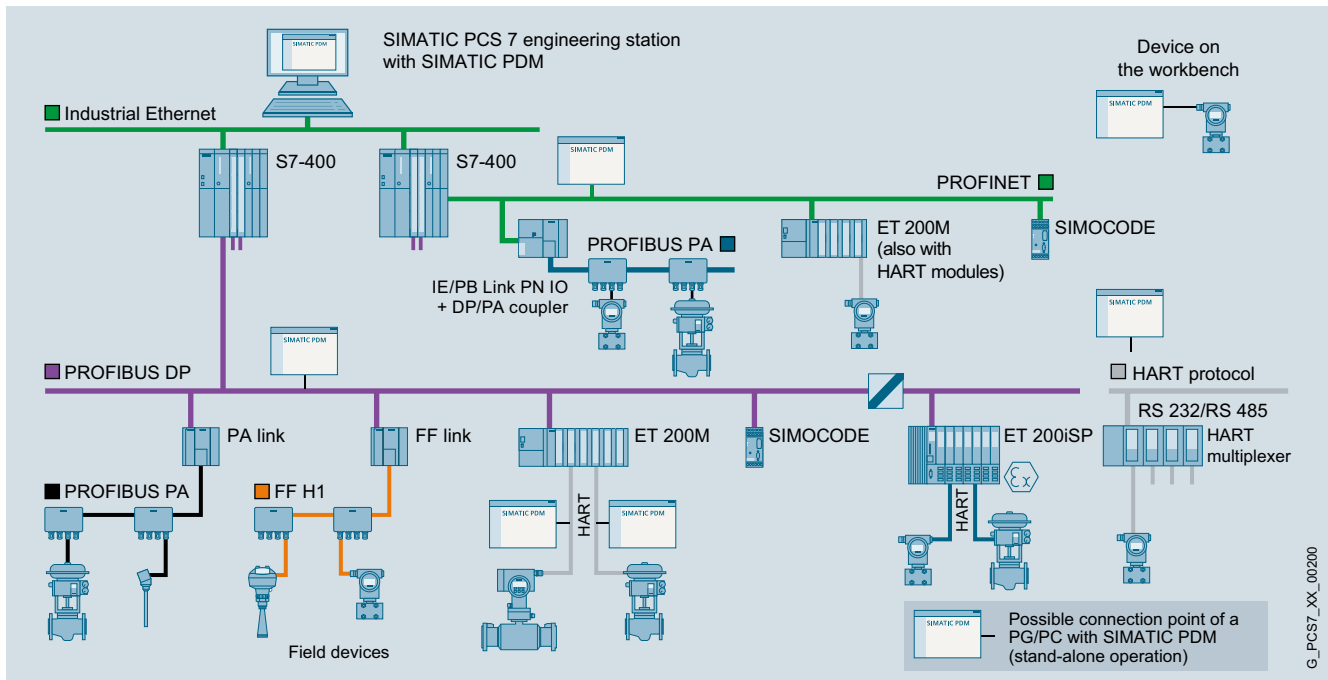

Configuration options with SIMATIC PDM

SIMATIC PDM (Process Device Manager) is a universal, vendor-independent tool for the configuration, parameter assignment, commissioning, diagnostics and servicing of intelligent field devices (sensors and actuators) and field components (remote I/Os, multiplexers, control-room devices, compact controllers), which in the following sections will be referred to simply as devices.

Using *one* software, SIMATIC PDM enables the processing of more than 2 500 devices from Siemens and over 200 vendors worldwide on *one* homogeneous user interface.

The user interface satisfies the requirements of the VDI/VDE GMA 2187 and IEC 65/349/CD directives. Parameters and functions for all supported devices are displayed in a consistent and uniform fashion independent of their communications interface. Even complex devices with several hundred parameters can be represented clearly and processed quickly. Using SIMATIC PDM it is very easy to navigate in highly complex stations such as remote I/Os and even connected field devices.

From the viewpoint of device integration, SIMATIC PDM is the most powerful open device manager available in the world. Devices which previously were not supported can be easily integrated in SIMATIC PDM at any time by importing their device descriptions (EDD). This provides security for your investment and saves you investment costs, training expenses and follow-up costs.

SIMATIC PDM supports the operative system management in particular through:

- Uniform presentation and operation of devices
- Uniform representation of diagnostics information
- Indicators for preventive maintenance and servicing
- Detection of changes in the project and device
- Increasing the operational reliability
- Reducing the investment, operating and maintenance costs
- Forwarding of device information to higher-level Maintenance Stations

When used in SIMATIC PCS 7, SIMATIC PDM is integrated in the asset management of the process control system. You can change directly to the SIMATIC PDM views from the diagnostics faceplates in the Maintenance Station.

The Process Device Manager provides more detailed information for all devices described by means of an Electronic Device Description (EDD), e.g.:

- Detailed diagnostics information (manufacturer information, information on error diagnostics and troubleshooting, further documentation)
- Results of internal condition monitoring functions
- Status information (e.g. local configuration changes)
- Information on changes (audit trail report)
- Parameter information

G\_PCS7\_XX\_00200

## Application

Components	Product packages											
	SIMATIC PDM stand-alone						SIMATIC PDM system-integrated					
	Minimum configuration		Basic configuration		Application-specific configurations		SIMATIC PDM S7		SIMATIC PDM PCS 7			
	SIMATIC PDM Single Point	SIMATIC PDM Basic	SIMATIC PDM Basic	SIMATIC PDM Service	SIMATIC PDM S7	SIMATIC PDM S7	SIMATIC PDM PCS 7	SIMATIC PDM PCS 7	SIMATIC PDM PCS 7	SIMATIC PDM PCS 7	SIMATIC PDM PCS 7	
	V6.1	V8.1	V6.1	V8.1	V6.1	V8.1	V6.1	V8.1	V6.1	V8.1	FF V8.1	
SIMATIC PDM TAGs <sup>1)</sup> in product package	1	1	4	4	128	100	128	100	128	100	100	
<b>SIMATIC PDM expansion options</b>												
TAG options	- 128 TAGs - 512 TAGs - 1 024 TAGs - 2 048 TAGs	<i>cannot be expanded</i>	o	-	-	-	-	-	-	-	-	
Power-Packs	- 128 to 512 TAGs - 512 to 1 024 TAGs - 1 024 to 2 048 TAGs - 2 048 to unlimited TAGs		o	-	o	-	o	-	o	-	-	
Count Relevant Licenses (accumulative)	- 10 TAGs - 100 TAGs - 1 000 TAGs		-	o	-	o	-	o	-	o	o	
SIMATIC PDM Basic			•	•	•	•	•	•	•	•	•	
SIMATIC PDM Extended			-	o	-	o	-	•	-	•	•	
SIMATIC PDM integration in STEP 7/PCS 7			o	o	o	o	•	•	•	•	•	
SIMATIC PDM routing			o	o	o	o	o	o	•	•	•	
SIMATIC PDM Communication FOUNDATION Fieldbus			-	o	-	o	-	o	-	o	•	
SIMATIC PDM Communication via standard HART multiplexer			o	-	o	-	o	-	o	-	-	
SIMATIC PDM HART server			-	o	-	o	-	o	-	o	o	
SIMATIC PDM command interface <sup>2)</sup>			-	o	-	o	-	-	-	-	-	

Table with SIMATIC PDM product structure

- Product component is part of the product package
- o Optional product component for the product package, can be purchased separately
- Product component is not relevant or not available for the product package

### Customer-oriented product structure

SIMATIC PDM can be implemented in different ways within the framework of Totally Integrated Automation (TIA) - as a stand-alone system or integrated in a SIMATIC PCS 7/SIMATIC S7 configuration environment.

The customer-oriented products structure of SIMATIC PDM helps you to adapt the scope of functions and performance to your individual requirements. You have the following options:

#### SIMATIC PDM stand-alone

- Product packages for operation on a mobile computer on PROFIBUS or with direct connection to the device, optionally as:
  - Minimal configuration SIMATIC PDM Single Point for processing of a single field device via point-to-point coupling
  - Application-specific configuration SIMATIC PDM Service for extended service tasks
- Product package SIMATIC PDM Basic as the basis for an individual SIMATIC PDM configuration with optional product components (see table)

<sup>1)</sup> For TAG definition, refer to sections "SIMATIC PDM TAGs for SIMATIC PDM V8.1" and "TAG options/PowerPacks for SIMATIC PDM V6.1"

<sup>2)</sup> Only for applications that are not intended for broad-based implementation; programming knowledge is required.

#### SIMATIC PDM system-integrated

- Product packages for integration of SIMATIC PDM in the engineering system (engineering toolset) and Maintenance Station of the SIMATIC PCS 7 process control system:
  - SIMATIC PDM PCS 7
  - SIMATIC PDM PCS 7-FF (also supports the FOUNDATION Fieldbus H1)
- Product package SIMATIC PDM S7 for integration in a SIMATIC S7 configuration environment

In some circumstances, the various product packages can be expanded with optional product components (for details, see the Design section).

#### Selection criteria

The current range of solutions comprises products of SIMATIC PDM versions 6.1 and 8.1. SIMATIC PDM V8.1 is supplied with the current service pack. The service pack is, however, not named explicitly in the ordering data and in the textual descriptions.

In addition to considering the environment of use and the functional and performance features (for details, see section "Design"), also observe the different system requirements of these SIMATIC PDM versions when selecting the product (see section "Technical specifications").

# PROFIBUS

## Engineering/Network Management/Diagnostics

### SIMATIC PDM

#### Design

Function and performance characteristics	SIMATIC PDM Single Point		SIMATIC PDM Basic		SIMATIC PDM Service		SIMATIC PDM S7		SIMATIC PDM PCS 7		
	V6.1	V8.1	V6.1	V8.1	V6.1	V8.1	V6.1	V8.1	V6.1	V8.1	FF V8.1
<b>TAGs contained</b>	<b>1</b>	<b>1</b>	<b>4</b>	<b>4</b>	<b>128</b>	<b>100</b>	<b>128</b>	<b>100</b>	<b>128</b>	<b>100</b>	<b>100</b>
Project: Create online	•	–	•	•	•	•	•	•	•	•	•
Project: Create offline	–	•	•	•	•	•	•	•	•	•	•
Project: Usable TAG extensions	–	–	•	•	•	•	•	•	•	•	•
Project: Network view	–	•	•	•	•	•	•	•	•	•	•
Project: Plant view	–	•	•	•	•	•	•	•	•	•	•
Project: Export/import devices	–	–	•	•	•	•	•	–	•	–	–
Project: HW Config	–	–	o	o	o	o	•	•	•	•	•
Project: Utilization of SIMATIC PDM options	–	–	•	•	•	•	•	•	•	•	•
Project: Integration in STEP 7/PCS 7	–	–	o	o	o	o	•	•	•	•	•
Communication: HART modem	•	•	•	•	•	•	•	–	•	–	–
Communication: HART interface	•	•	•	•	•	•	•	–	•	–	–
Communication: PROFIBUS DP/PA	•	•	•	•	•	•	•	•	•	•	•
Communication: HART over PROFIBUS DP	–	•	–	•	–	•	–	•	–	•	•
Communication: FF H1	–	–	–	o <sup>1)</sup>	–	o <sup>1)</sup>	–	o	–	o	•
Communication: Modbus	•	•	•	•	•	•	•	–	•	–	–
Communication: SIPART DR	•	–	•	–	•	–	•	–	•	–	–
Communication: SIREC	•	–	•	–	•	–	•	–	•	–	–
Communication: Ethernet	–	•	•	•	•	•	•	–	•	–	–
Communication: PROFINET	–	•	–	•	–	•	–	•	–	•	•
Communication: HART over PROFINET	–	•	–	•	–	•	–	•	–	•	•
Devices: Export/import parameters	•	–	•	o	•	•	•	•	•	•	•
Devices: Comparison of values (online/offline)	•	–	•	o	•	•	•	•	•	•	•
Devices: Comparison of values of two devices	–	–	•	o	•	•	•	•	•	•	•
Devices: Saving parameters	–	•	•	•	•	•	•	•	•	•	•
Devices: Logbook (Audit Trail)	–	–	o	o	•	•	•	•	•	•	•
Devices: Calibration report	–	–	o	o	•	•	•	•	•	•	•
LifeList: Export Scan	–	–	•	o	•	•	•	–	•	–	–
LifeList: Device diagnostics	–	–	o	o	•	•	•	•	•	•	•
LifeList: Define scan area	–	•	o	o	•	o	•	•	•	•	•
LifeList: Save scan	–	–	o	o	•	–	•	–	•	–	–
LifeList: Scan from HW Config	–	–	o	o	o	o	•	•	•	•	•
Communication: S7 routing	–	–	o	o	o	o	o	o	•	•	•
Communication: HART multiplexer	–	–	o	o	o	o	–	o	–	o	o
Communication: Wireless HART	–	–	–	o	o	o	–	o	–	o	o
Function: HART SHC mode (increased communication speed)	–	•	•	•	•	•	•	•	•	•	•
Function: "HART-Long TAG"	–	•	–	•	–	•	–	•	–	•	•

SIMATIC PDM overview of functions and features

- Product component is part of the product package
- o Optional product component for the product package, can be purchased separately
- Product component is not relevant or not available for the product package
- <sup>1)</sup> Not in stand-alone mode

**Design** (continued)**SIMATIC PDM V8.1 incl. SP1 product range****SIMATIC PDM stand-alone**SIMATIC PDM Single Point V8.1

This minimum configuration with handheld functionality is designed for processing exactly *one* field device via point-to-point coupling. It cannot be expanded with functions or TAG options/PowerPacks. Upgrading to a different product variant, e.g. SIMATIC PDM Basic, or a different product version is also not possible. The device functions are supported as defined in the device description.

The following types of communication are possible:

- PROFIBUS DP/PA
- HART communication (modem, RS 232 and via PROFIBUS/PROFINET)
- Modbus
- Ethernet
- PROFINET

SIMATIC PDM Basic V8.1

Provided the system requirements are met, SIMATIC PDM Basic V8.1 can be used for stand-alone operation on any computers (IPC/notebook) with local connection to bus segments or direct connection to the device. The product package features all the basic functions required for operation and parameter assignment of the devices and is enabled for the following communication modes:

- PROFIBUS DP/PA
- HART communication (modem, RS 232 and via PROFIBUS/PROFINET)
- Modbus
- Ethernet
- PROFINET

As a basic block for individual configuration, SIMATIC PDM Basic V8.1 can be upgraded with all the functional options for SIMATIC PDM V8.1 as well as with cumulative 10, 100 or 1 000 SIMATIC PDM TAGs (quantity option as of SIMATIC PDM V7.0). Without TAG expansion, SIMATIC PDM Basic V8.1 is suitable for projects with up to 4 TAGs.

SIMATIC PDM Service V8.1

This product package based on SIMATIC PDM Basic V8.1 for projects with up to 100 TAGs is intended for mobile use in service.

Similar to SIMATIC PDM Basic V8.1, SIMATIC PDM Service V8.1 can be upgraded with all the functional options for SIMATIC PDM V8.1 as well as with cumulative 10, 100 or 1 000 SIMATIC PDM TAGs.

**SIMATIC PDM system-integrated**SIMATIC PDM S7 V8.1

Similar to SIMATIC PDM S7 V6.1, SIMATIC PDM S7 V8.1 is also designed for use in a SIMATIC S7 configuration environment, but differs functionally (for details, see the table "Overview of functions and performance for SIMATIC PDM") and due to the number of TAGs it features (100 TAGs included). SIMATIC PDM S7 V8.1 is therefore not a functionally compatible successor to SIMATIC PDM S7 V6.1.

SIMATIC PDM S7 V8.1 requires the installation of STEP 7 V5.5+SP2 (for using PROFINET communication STEP 7 V5.5+SP3). When selecting a product, note that SIMATIC PDM S7 V8.1 is not backwards compatible, and multiple SIMATIC PDM versions cannot be operated simultaneously.

SIMATIC PDM S7 V8.1 can be expanded with the functional options "SIMATIC PDM Routing V8.1" and "SIMATIC PDM Communication FOUNDATION Fieldbus V8.1" and "SIMATIC PDM HART Server V8.1" as well as with cumulative sets of 10, 100 or 1 000 SIMATIC PDM TAGs.

SIMATIC PDM PCS 7 V8.1 and SIMATIC PDM PCS 7-FF V8.1

SIMATIC PDM PCS 7 V8.1 and SIMATIC PDM PCS 7-FF V8.1 focus on functions different from those of SIMATIC PDM PCS 7 V6.1 (for details, see the table "Overview of functions and performance for SIMATIC PDM"). They support projects with "PROFINET" and "FOUNDATION Fieldbus" communication and can be expanded with the functional option "SIMATIC PDM HART Server".

FOUNDATION Fieldbus functionality is already integrated in SIMATIC PDM PCS 7-FF V8.1. SIMATIC PDM PCS 7 V8.1 can be appropriately expanded if required using the option "SIMATIC PDM Communication FOUNDATION Fieldbus".

SIMATIC PDM PCS 7 V8.1 and SIMATIC PDM PCS 7-FF V8.1 are initially provided with 100 TAGs. This quantity can be further cumulatively expanded with sets of 10, 100 or 1 000 SIMATIC PDM TAGs (quantity option with SIMATIC PDM V7.0 or higher).

SIMATIC PDM PCS 7 V8.1 and SIMATIC PDM PCS 7-FF V8.1 are not functionally compatible successors to SIMATIC PDM PCS 7 V6.x, and are not downward-compatible. The two product packages require installation of SIMATIC PCS 7 as of V8.0 (V8.0+SP1 for the use of PROFINET communication).

When selecting a product, note that it is not possible to operate multiple SIMATIC PDM versions at the same time.

## PROFIBUS

### Engineering/Network Management/Diagnostics

#### SIMATIC PDM

#### Design (continued)

##### Optional product components

###### SIMATIC PDM Extended V8.1 option

The SIMATIC PDM V8.1 Extended option enables you to unlock other system functions of SIMATIC PDM V8.1 for use, for example:

- Change log
- Calibration report
- Extended information in the Lifest
- Export and import functions
- Print functions
- Document manager
- Comparison function

###### SIMATIC PDM integration option in STEP 7/PCS 7 V8.1

This option is used for the integration of SIMATIC PDM V8.1 in a SIMATIC S7 or SIMATIC PCS 7 configuration environment. SIMATIC PDM V8.1 can then be started directly from the hardware configurator (HW Config) in STEP 7/SIMATIC PCS 7.

###### SIMATIC PDM Routing V8.1 option

If SIMATIC PDM V8.1 is used on a central engineering station, the SIMATIC PDM Routing V8.1 option enables handling of every device in the field that can be configured per EDD throughout the plant and across different bus systems and remote I/Os. SIMATIC PDM Routing V8.1 is available for SIMATIC PDM S7 V8.1 as an optional product component. Routing is already integrated into SIMATIC PDM PCS 7 V8.1.

###### SIMATIC PDM Communication FOUNDATION Fieldbus V8.1 option

With this option, SIMATIC PDM can communicate in a SIMATIC S7/PCS 7 engineering environment with field devices on the FOUNDATION Fieldbus H1 via the FF link.

###### Option SIMATIC PDM HART Server V8.1

This option supports use of HART multiplexers from various manufacturers in SIMATIC PDM V8.1. Wireless HART field devices can also be parameterized using SIMATIC PDM V8.1.

###### Option SIMATIC PDM Command Interface V8.1

With this option, the stand-alone product packages SIMATIC PDM Basic and SIMATIC PDM Service can be remotely operated for configuring and field-device operation.

**Note:** The application is functionally limited in SIMATIC PDM V8.1+SP1 and restricted to applications that are not intended for broad-based use. Programming knowledge is necessary.

###### SIMATIC PDM TAGs for SIMATIC PDM V8.1

Depending on the project size, the TAGs supplied with a product can be cumulatively expanded with 10, 100 or 1 000 SIMATIC PDM TAGs. A TAG corresponds to a SIMATIC PDM object, which represents individual field devices or components within a project, e.g. measuring instruments, positioners, switching devices or remote I/Os. TAGs are also relevant for diagnostics with the lifelist of SIMATIC PDM. In this case, TAGs are considered to be all recognized devices with diagnostics capability, whose detailed diagnostics is effected through the device description (EDD).

##### SIMATIC PDM V6.1 product range

###### SIMATIC PDM stand-alone

###### SIMATIC PDM Single Point V6.1

This minimum configuration with handheld functionality is designed for processing exactly *one* field device via point-to-point coupling. It cannot be expanded with functions or TAG options/PowerPacks. The device functions are supported as defined in the device description.

The following types of communication are possible:

- PROFIBUS DP/PA
- HART communication (modem, RS 232)
- Modbus

###### SIMATIC PDM Basic V6.1

Provided the system requirements are met, SIMATIC PDM Basic V6.1 can be used for stand-alone operation on any computer (IPC/notebook) with local connection to bus segments or direct connection to the device. The product package features all the basic functions required for operation and parameter assignment of the devices and is enabled for the following communication modes:

- PROFIBUS DP/PA
- HART communication (modem, RS 232 and via PROFIBUS)
- Modbus
- SIREC bus
- SIPART DR
- Ethernet

As basic module for individual configuration, SIMATIC PDM Basic V6.1 can be expanded with all optional product components, TAG options and PowerPacks for SIMATIC PDM V6.1. Without TAG expansion, SIMATIC PDM Basic V6.1 can manage projects with up to 4 TAGs. Use of the following functions requires at least 128 TAGs:

- Change log
- Calibration report
- Detailed diagnostics in the lifelist

###### SIMATIC PDM Service V6.1

This is a configured product package especially for mobile use in servicing for projects with up to 128 TAGs. It offers service engineers all functions of SIMATIC PDM Basic V6.1 and special service functions such as change log, calibration report and detailed diagnostics in the lifelist.

SIMATIC PDM Service V6.1 can be expanded by the functional options "SIMATIC PDM Integration in STEP 7/PCS 7 V6.1", "SIMATIC PDM Routing V6.1" and "SIMATIC PDM Communication via Standard HART-Multiplexer V6.1" as well as by SIMATIC PDM PowerPacks.



**Design** (continued)***SIMATIC PDM system-integrated***SIMATIC PDM S7 V6.1

SIMATIC PDM S7 V6.1 is a product package for projects with up to 128 TAGs and is configured for the use of SIMATIC PDM in a SIMATIC S7 configuration environment. In addition to SIMATIC PDM Service V6.1, it also offers functions for integration in the hardware configurator (HW Config) of STEP 7 (corresponds to the option "SIMATIC PDM Integration in STEP 7/PCS 7").

SIMATIC PDM S7 V6.1 can be expanded by the functional options "SIMATIC PDM Routing V6.1" and "Communication via Standard HART-Multiplexer V6.1" as well as by SIMATIC PDM PowerPacks.

SIMATIC PDM PCS 7 V6.1

The SIMATIC PDM PCS 7 V6.1 product package is designed for projects with up to 128 TAGs. It extends the functionality of SIMATIC PDM Service V6.1 with routing from the central engineering system to the devices in the field and integrates SIMATIC PDM in the SIMATIC PCS 7 configuration environment by means of HW Config.

SIMATIC PDM PCS 7 V6.1 can be expanded by the options "SIMATIC PDM Communication via Standard HART Multiplexer V6.1" and SIMATIC PDM PowerPacks.

***Optional product components for SIMATIC PDM V6.1***SIMATIC PDM Integration option in STEP 7/PCS 7 V6.1

This option is used for the integration of SIMATIC PDM V6.1 in a SIMATIC S7 or SIMATIC PCS 7 configuration environment. SIMATIC PDM V6.1 can then be started directly from the hardware configurator (HW Config) in STEP 7/SIMATIC PCS 7.

SIMATIC PDM Routing V6.1 option

If you want to use SIMATIC PDM V6.1 in a central engineering system for plant-wide configuration, parameter assignment, commissioning and diagnostics of the devices in the field, you need the "SIMATIC PDM Routing V6.1" option in addition to the "SIMATIC PDM Integration in STEP 7/PCS 7 V6.1" option. From the central engineering system, you can then reach every device in the field that can be configured per EDD throughout the plant and across different bus systems and remote I/Os.

SIMATIC PDM Communication via Standard HART Multiplexer V6.1 option

This option permits SIMATIC PDM to use the HART server for communication with HART field devices via HART multiplexers.

TAG options/PowerPacks for SIMATIC PDM V6.1

A TAG corresponds to a SIMATIC PDM object, which represents individual field devices or components within a project, e.g. measuring instruments, positioners, switching devices or remote I/Os. TAGs are also relevant for diagnostics with the lifelist of SIMATIC PDM. In this case, TAGs are considered to be all recognized devices with diagnostics capability, whose detailed diagnostics is effected through the device description (EDD).

In contrast to PowerPacks, TAG options are only suitable for individual SIMATIC PDM product configurations on the basis of SIMATIC PDM Basic V6.1. Using the SIMATIC PDM TAG options for SIMATIC PDM V6.1, SIMATIC PDM Basic V6.1 can be expanded from 4 TAGs to 128, 512, 1 024 or 2 048 TAGs, and with the help of an additive PowerPack for SIMATIC PDM V6.1 even to unlimited TAGs.

With the PowerPacks for SIMATIC PDM V6.1, product packages based on SIMATIC PDM V6.1 can be provided with additional TAGs. PowerPacks are available for TAG expansion to 512, 1 024, 2 048 and unlimited TAGs.

***Demonstration software***

SIMATIC PDM V6.1 and SIMATIC PDM V8.1 are also available with demo software for demonstration purposes. Storage functions, export/import and extended functionality cannot be used with the demo software. The communication functions are restricted.

# PROFIBUS

## Engineering/Network Management/Diagnostics

### SIMATIC PDM

#### Function

The screenshot displays the SIMATIC PDM interface. On the left, a tree view shows the parameter structure for 'SITRANS TJK FA'. The main area shows a table of parameters with columns for Parameter, Value, Unit, Status, and Name. Below this, there are sections for Identification, Operation Unit, and Device. A 'History trend' window is overlaid, showing a line graph of 'Output Value' in degrees Celsius. The graph shows a fluctuating trend over time, with a current value of 23.1 °C. The x-axis represents time from 9:05:00 AM to 9:06:00 AM on 12/29/2011. The y-axis represents the output value from 23.125 to 23.20.

SIMATIC PDM, parameter view and trend window

#### Core functions

- Adjustment and modification of device parameters
- Comparing (e.g. project and device data)
- Plausibility testing of data input
- Device identification and testing
- Device status indication (operating modes, interrupts, states)
- Simulation
- Diagnostics (standard, detailed)
- Export/import (parameter data, logs, documents)
- Management (e.g. networks and PCs)
- Commissioning functions, e.g. measuring circuit tests of device data
- Device management (lifecycle management)
- Global and device-specific modification logbook for user operations (audit trail)
- Device-specific calibration reports
- Graphic presentations of echo envelope curves, trend displays, valve diagnosis results etc.
- Presentation of incorporated manuals
- Document manager for integration of up to 10 multimedia files

#### Integration

##### Device integration

SIMATIC PDM supports all devices described by EDD (Electronic Device Description). EDD is standardized to EN 50391 and IEC 61804. Internationally it is the most widely used standardized technology for device integration. At the same time, it is the guideline of the established organizations for

- PROFIBUS and PROFINET (PI – PROFIBUS & PROFINET International)
- HART (HCF: HART Communication Foundation)
- FF (Fieldbus Foundation)

The devices are integrated directly in SIMATIC PDM through a company-specific EDD or the current HCF or Fieldbus Foundation libraries. To achieve improved transparency, they can be managed in project-specific device libraries.

Field devices are described in the EDD in terms of functionality and construction using the Electronic Device Description Language (EDDL). Using this description, SIMATIC PDM automatically creates its user interface with the specific device data. Existing devices can be updated, and further devices integrated into SIMATIC PDM, by simply importing the manufacturer's device-specific EDD.

Fieldbus Foundation provides pre-defined device descriptions (standard DD) for the basic functions of specific field device types. The basic functions are implemented using various standard function and transmission blocks.

##### Technical support

If you wish to use devices which cannot be found in the SIMATIC PDM device description library, we would be pleased to help you integrate them.

##### Support Request

You can request support by service specialists at Technical Support by using a "Support Request" on the Internet:

<http://www.siemens.com/automation/support-request>

##### Contacts in the Region

The Technical Support responsible for your Region can be found on the Internet at:

<http://www.automation.siemens.com/partner>

### Technical specifications

	SIMATIC PDM V6.1	SIMATIC PDM V8.1
Hardware	<ul style="list-style-type: none"> <li>PG/PC/notebook with processor corresponding to operating system requirements</li> </ul>	<ul style="list-style-type: none"> <li>PG/PC/notebook with processor corresponding to operating system requirements</li> </ul>
Operating systems (alternative)	<ul style="list-style-type: none"> <li>Microsoft Windows XP Professional SP3, 32-bit</li> <li>Microsoft Windows Server 2003 R2 SP2, 32-bit, Standard Edition</li> </ul>	<ul style="list-style-type: none"> <li>Windows XP Professional SP3 (32-bit)</li> <li>Windows Server 2003 SP2 Standard Edition (32-bit)</li> <li>Windows Server 2003 R2 SP2 Standard Edition (32-bit)</li> <li>Windows 7 Professional/Ultimate/Enterprise SP1 (32-bit/64-bit)</li> <li>Windows Server 2008 SP2 Standard Edition (32-bit)</li> <li>Windows Server 2008 R2 SP1 Standard Edition (64-bit)</li> </ul>
Integration in STEP 7/PCS 7	<ul style="list-style-type: none"> <li>STEP 7 V5.3+SP2</li> <li>STEP 7 V5.4+SP5</li> <li>STEP 7 V5.5 or V5.5+SP1/SP2/SP3</li> <li>SIMATIC PCS 7 V6.1+SP4</li> <li>SIMATIC PCS 7 V7.1 or V7.1+SP1/SP2/SP3</li> <li>SIMATIC PCS 7 V8.0 or V8.0+SP1</li> </ul>	<ul style="list-style-type: none"> <li>SIMATIC PCS 7 V8.0+SP1 (SIMATIC PCS 7 V8.0 without PROFINET communication)</li> <li>STEP 7 V5.5+SP3 (STEP 7 V5.5+SP2 without PROFINET communication)</li> </ul>

### Ordering data

#### Article No.

#### Article No.

#### SIMATIC PDM V8.1

##### SIMATIC PDM stand-alone product packages

###### Minimum configuration

#### SIMATIC PDM Single Point V8.1

for operation and configuration of one field device; communication via PROFIBUS DP/PA, HART (modem, RS 232, PROFIBUS/PROFINET), Modbus, Ethernet or PROFINET, including 1 TAG

cannot be expanded with respect to functions or with TAG option/PowerPack

6 languages (English, German, French, Italian, Spanish, Chinese), software class A, runs with Windows XP Professional 32-bit, Windows 7 Ultimate 32/64-bit, Windows Server 2003 R2 Standard 32-bit, or Windows Server 2008 R2 Standard 64-bit, floating license for 1 user

- Delivery form package  
SIMATIC PDM software and device library on DVD, license key on USB stick, certificate of license
- Delivery form online  
Software image download (SIMATIC PDM and device library), license key download, online certificate of license  
Note:  
E-mail address required!

**6ES7658-3HA18-0YA5**

**6ES7658-3HA18-0YH5**

##### Basic configuration for individual product packages

#### SIMATIC PDM Basic V8.1

Product package for operation and configuration of field devices and components; communication via PROFIBUS DP/PA, HART (modem, RS 232, PROFIBUS/PROFINET), Modbus, Ethernet or PROFINET, including 4 TAGs

6 languages (English, German, French, Italian, Spanish, Chinese), software class A, runs with Windows XP Professional 32-bit, Windows 7 Ultimate 32/64-bit, Windows Server 2003 R2 Standard 32-bit, or Windows Server 2008 R2 Standard 64-bit, floating license for 1 user

- Delivery form package  
SIMATIC PDM software and device library on DVD, license key on USB stick, certificate of license
- Delivery form online  
Software image download (SIMATIC PDM and device library), license key download, online certificate of license  
Note:  
E-mail address required!

**6ES7658-3AB18-0YA5**

**6ES7658-3AB18-0YH5**

# PROFIBUS

## Engineering/Network Management/Diagnostics

### SIMATIC PDM

#### Ordering data

#### Article No.

#### Article No.

##### *Application-specific configuration for mobile service*

#### **SIMATIC PDM Service V8.1**

Product package for stand-alone user in service, with

- SIMATIC PDM Basic
- 100 TAGs

6 languages (English, German, French, Italian, Spanish, Chinese), software class A, runs with Windows XP Professional 32-bit, Windows 7 Ultimate 32/64-bit, Windows Server 2003 R2 Standard 32-bit, or Windows Server 2008 R2 Standard 64-bit, floating license for 1 user

- Delivery form package  
SIMATIC PDM software and device library on DVD, license key on USB stick, certificate of license

- Delivery form online  
Software image download (SIMATIC PDM and device library), license key download, online certificate of license

Note:  
E-mail address required!

**6ES7658-3JD18-0YA5**

**6ES7658-3JD18-0YH5**

##### *Application-specific configuration for integration in SIMATIC S7 configuration environment*

#### **SIMATIC PDM S7 V8.1**

Product package for use in a SIMATIC S7 engineering environment, with

- SIMATIC PDM Basic and Extended
- Integration in STEP 7/PCS 7
- 100 TAGs

6 languages (English, German, French, Italian, Spanish, Chinese), software class A, runs with Windows XP Professional 32-bit, Windows 7 Ultimate 32/64-bit, Windows Server 2003 R2 Standard 32-bit, or Windows Server 2008 R2 Standard 64-bit, floating license for 1 user

Note:  
SIMATIC PDM S7 V8.1 requires the installation of STEP 7 V5.5+SP2/SP3! PROFINET communication is supported as of STEP 7 V5.5+SP3.

- Delivery form package  
SIMATIC PDM software and device library on DVD, license key on USB stick, certificate of license

- Delivery form online  
Software image download (SIMATIC PDM and device library), license key download, online certificate of license

Note:  
E-mail address required!

**6ES7658-3KD18-0YA5**

**6ES7658-3KD18-0YH5**

##### *Application-specific configuration for integration in SIMATIC PCS 7 configuration environment*

#### **SIMATIC PDM PCS 7 V8.1**

Complete package for integration into the engineering toolset of the SIMATIC PCS 7 engineering system

6 languages (English, German, French, Italian, Spanish, Chinese), software class A, runs with Windows XP Professional 32-bit, Windows 7 Ultimate 32/64-bit, Windows Server 2003 R2 Standard 32-bit or Windows Server 2008 R2 Standard 64-bit,

- Floating license for 1 user, with
- SIMATIC PDM Basic and Extended
- Integration in STEP 7/PCS 7
- Routing
- 100 TAGs

Note:  
SIMATIC PDM PCS 7 V8.1 requires the installation of SIMATIC PCS 7 V8.0 or higher! PROFINET communication is supported as of SIMATIC PCS 7 V8.0+SP1.

- Delivery form package  
(without SIMATIC PCS 7 Software Media Package)  
SIMATIC PDM software and device library on DVD, license key USB stick, certificate of license

- Delivery form online  
(without SIMATIC PCS 7 Software Media Package)  
Software image download (SIMATIC PDM and device library), license key download, online certificate of license
- Note: E-mail address required!

**6ES7658-3LD18-0YA5**

**6ES7658-3LD18-0YH5**

#### **SIMATIC PDM PCS 7-FF V8.1**

Complete package for integration into the engineering toolset of the SIMATIC PCS 7 engineering system

6 languages (English, German, French, Italian, Spanish, Chinese), software class A, runs with Windows XP Professional 32-bit, Windows 7 Ultimate 32/64-bit, Windows Server 2003 R2 Standard 32-bit or Windows Server 2008 R2 Standard 64-bit,

- Floating license for 1 user, with
- SIMATIC PDM Basic and Extended
- Integration in STEP 7/PCS 7
- Routing
- FOUNDATION Fieldbus communication
- 100 TAGs

Note:  
SIMATIC PDM PCS 7-FF V8.1 requires the installation of SIMATIC PCS 7 V8.0 or higher! PROFINET communication is supported as of SIMATIC PCS 7 V8.0+SP1.

- Delivery form package  
(without SIMATIC PCS 7 Software Media Package)  
SIMATIC PDM software and device library on DVD, license key USB stick, certificate of license

- Delivery form online  
(without SIMATIC PCS 7 Software Media Package)  
Software image download (SIMATIC PDM and device library), license key download, online certificate of license

Note:  
E-mail address required!

**6ES7658-3MD18-0YA5**

**6ES7658-3MD18-0YH5**

## Ordering data

## Article No.

## Article No.

*Optional product components for SIMATIC PDM V8.1***SIMATIC PDM Extended V8.1**

6 languages (English, German, French, Italian, Spanish, Chinese), software class A, runs with Windows XP Professional 32-bit, Windows 7 Ultimate 32/64-bit, Windows Server 2003 R2 Standard 32-bit, or Windows Server 2008 R2 Standard 64-bit,

floating license for 1 user

- Delivery form package  
License key on USB stick, certificate of license
  - Delivery form online  
License key download, online certificate of license
- Note:  
E-mail address required!

**6ES7658-3NX18-2YB5****6ES7658-3NX18-2YH5****SIMATIC PDM Integration in STEP 7/SIMATIC PCS 7 V8.1**

only required for integration of SIMATIC PDM into HW Config  
6 languages (English, German, French, Italian, Spanish, Chinese), software class A, runs with Windows XP Professional 32-bit, Windows 7 Ultimate 32/64-bit, Windows Server 2003 R2 Standard 32-bit, or Windows Server 2008 R2 Standard 64-bit,

floating license for 1 user

- Delivery form package  
License key on USB stick, certificate of license
  - Delivery form online  
License key download, online certificate of license
- Note:  
E-mail address required!

**6ES7658-3BX18-2YB5****6ES7658-3BX18-2YH5****SIMATIC PDM Routing V8.1**

6 languages (English, German, French, Italian, Spanish, Chinese), software class A, runs with Windows XP Professional 32-bit, Windows 7 Ultimate 32/64-bit, Windows Server 2003 R2 Standard 32-bit, or Windows Server 2008 R2 Standard 64-bit,

floating license for 1 user

- Delivery form package  
License key on USB stick, certificate of license
  - Delivery form online  
License key download, online certificate of license
- Note:  
E-mail address required!

**6ES7658-3CX18-2YB5****6ES7658-3CX18-2YH5****SIMATIC PDM Communication FOUNDATION Fieldbus V8.1**

6 languages (English, German, French, Italian, Spanish, Chinese), software class A, runs with Windows XP Professional 32-bit, Windows 7 Ultimate 32/64-bit, Windows Server 2003 R2 Standard 32-bit, or Windows Server 2008 R2 Standard 64-bit,

floating license for 1 user

- Delivery form package  
(without SIMATIC PCS 7 Software Media Package)  
License key USB stick, certificate of license
  - Delivery form online  
(without SIMATIC PCS 7 Software Media Package)  
License key download, online certificate of license
- Note:  
E-mail address required!

**6ES7658-3QX18-2YB5****6ES7658-3QX18-2YH5****SIMATIC PDM HART Server V8.1**

6 languages (English, German, French, Italian, Spanish, Chinese), software class A, runs with Windows XP Professional 32-bit, Windows 7 Ultimate 32/64-bit, Windows Server 2003 R2 Standard 32-bit, or Windows Server 2008 R2 Standard 64-bit,

floating license for 1 user

- Delivery form package  
(without SIMATIC PCS 7 Software Media Package)  
License key USB stick, certificate of license
  - Delivery form online  
(without SIMATIC PCS 7 Software Media Package)  
License key download, online certificate of license
- Note:  
E-mail address required!

**6ES7658-3EX18-2YB5****6ES7658-3EX18-2YH5****SIMATIC PDM Command Interface V8.1**

6 languages (English, German, French, Italian, Spanish, Chinese), software class A, runs with Windows XP Professional 32-bit, Windows 7 Ultimate 32/64-bit, Windows Server 2003 R2 Standard 32-bit, or Windows Server 2008 R2 Standard 64-bit,

floating license for 1 user

- Delivery form package  
(without SIMATIC PCS 7 Software Media Package)  
License key USB stick, certificate of license

**6ES7658-3SX18-2YB5**

# PROFIBUS

## Engineering/Network Management/Diagnostics

### SIMATIC PDM

#### Ordering data

#### Article No.

#### Article No.

##### *SIMATIC PDM TAGs for SIMATIC PDM V8.1*

##### **SIMATIC PDM TAGs**

TAG licenses for expanding SIMATIC PDM product packages V7.0 or higher, can be accumulated, software class A, floating license for 1 user

- Delivery form package
  - License key on USB stick, certificate of license
  - 10 TAGs
  - 100 TAGs
  - 1 000 TAGs
- Delivery form online
  - License key download, online certificate of license
  - Note:
  - E-mail address required!
  - 10 TAGs
  - 100 TAGs
  - 1 000 TAGs

**6ES7658-3XC00-2YB5**  
**6ES7658-3XD00-2YB5**  
**6ES7658-3XE00-2YB5**

**6ES7658-3XC00-2YH5**  
**6ES7658-3XD00-2YH5**  
**6ES7658-3XE00-2YH5**

##### *Demonstration software*

##### **SIMATIC PDM Demo V8.1**

Storage functions, export/import and advanced functionality disabled; communication functions restricted

6 languages (English, German, French, Italian, Spanish, Chinese), software class A, runs with Windows XP Professional 32-bit, Windows 7 Ultimate 32/64-bit, Windows Server 2003 R2 Standard 32-bit or Windows Server 2008 R2 Standard 64-bit

Delivery form package  
 SIMATIC PDM software and device library on DVD

**6ES7658-3GX18-0YT8**

#### SIMATIC PDM V6.1

##### *SIMATIC PDM stand-alone product packages*

##### *Minimum configuration*

##### **SIMATIC PDM Single Point V6.1**

for operation and configuration of one field device; communication via PROFIBUS DP/PA, HART modem or Modbus, including 1 TAG

cannot be expanded with respect to functions or with TAG option/PowerPack

6 languages (English, German, French, Italian, Spanish, Chinese), software class A, runs with Windows XP Professional/ Server 2003, floating license for 1 user

Delivery form package  
 SIMATIC PDM software and device library on CD/DVD, license key on USB stick, certificate of license

**6ES7658-3HX16-0YA5**

##### *Basic configuration for individual product packages*

##### **SIMATIC PDM Basic V6.1**

Product package for operator input and configuration of field devices and components, communication via PROFIBUS DP/PA, HART (modem, RS 232, PROFIBUS), SIREC bus, SIPART DR, Modbus or Ethernet, including 4 TAGs

6 languages (English, German, French, Italian, Spanish, Chinese), software class A, runs with Windows XP Professional/ Server 2003, floating license for 1 user

Delivery form package  
 SIMATIC PDM software and device library on CD/DVD, license key on USB stick, certificate of license

**6ES7658-3AX16-0YA5**

##### *Application-specific configuration for mobile service*

##### **SIMATIC PDM Service V6.1**

Product package for stand-alone user in service, with

- SIMATIC PDM Basic V6.1
- 128 TAGs

6 languages (English, German, French, Italian, Spanish, Chinese), software class A, runs with Windows XP Professional/ Server 2003, floating license for 1 user

Delivery form package  
 SIMATIC PDM software and device library on CD/DVD, license key on USB stick, certificate of license

**6ES7658-3JX16-0YA5**

Ordering data	Article No.	Article No.	
<i>SIMATIC PDM system-integrated product packages</i>		<i>TAG options/PowerPacks for SIMATIC PDM V6.1</i>	
<i>Application-specific configuration for integration in SIMATIC S7 configuration environment</i>			
<b>SIMATIC PDM S7 V6.1</b> Product package for use in a SIMATIC S7 configuration environment, with <ul style="list-style-type: none"> <li>• SIMATIC PDM Basic V6.1</li> <li>• Integration in STEP 7/PCS 7</li> <li>• 128 TAGs</li> </ul> 6 languages (English, German, French, Italian, Spanish, Chinese), software class A, runs with Windows XP Professional/ Server 2003, floating license for 1 user  Delivery form package SIMATIC PDM software and device library on CD/DVD, license key on USB stick, certificate of license	<b>6ES7658-3KX16-0YA5</b>	<b>SIMATIC PDM TAG option</b> for TAG expansion, additive to SIMATIC PDM Basic V6.1  Software class A, runs with Windows XP Professional/Server 2003, floating license for 1 user  Delivery form package License key on USB stick, certificate of license <ul style="list-style-type: none"> <li>• Up to 128 TAGs</li> <li>• Up to 512 TAGs</li> <li>• Up to 1 024 TAGs</li> <li>• Up to 2 048 TAGs</li> </ul>	<b>6ES7658-3XA16-2YB5</b> <b>6ES7658-3XB16-2YB5</b> <b>6ES7658-3XC16-2YB5</b> <b>6ES7658-3XD16-2YB5</b>
<i>Application-specific configuration for integration in SIMATIC PCS 7 configuration environment</i>			
<b>SIMATIC PDM PCS 7 V6.1</b> Complete package for integration into the engineering toolset of the SIMATIC PCS 7 engineering system  6 languages (English, German, French, Italian, Spanish, Chinese), software class A, runs with Windows XP Professional/ Server 2003  Floating license for 1 user, with <ul style="list-style-type: none"> <li>• SIMATIC PDM Basic</li> <li>• Integration in STEP 7/PCS 7</li> <li>• Routing</li> <li>• 128 TAGs</li> </ul> Delivery form package (without SIMATIC PCS 7 Software Media Package): SIMATIC PDM software and device library on CD/DVD, license key on USB stick, certificate of license	<b>6ES7658-3LX16-0YA5</b>	<b>SIMATIC PDM PowerPack</b> for TAG expansion, for any SIMATIC PDM V6.1 product packages  Software class A, runs with Windows XP Professional/ Server 2003, floating license for 1 user  Delivery form package License key on USB stick, certificate of license <ul style="list-style-type: none"> <li>• 128 TAGs to 512 TAGs</li> <li>• 512 TAGs to 1 024 TAGs</li> <li>• 1 024 TAGs to 2 048 TAGs</li> <li>• 2 048 TAGs to unlimited TAGs</li> </ul>	<b>6ES7658-3XB16-2YD5</b> <b>6ES7658-3XC16-2YD5</b> <b>6ES7658-3XD16-2YD5</b> <b>6ES7658-3XH16-2YD5</b>
<i>Optional product components for SIMATIC PDM V6.1</i>		<i>Demonstration software</i>	
<b>SIMATIC PDM integration in STEP 7/SIMATIC PCS 7 V6.1</b> only required for integration of SIMATIC PDM into HW Config  6 languages (English, German, French, Italian, Spanish, Chinese), software class A, runs with Windows XP Professional/ Server 2003, floating license for 1 user  Delivery form package License key on USB stick, certificate of license	<b>6ES7658-3BX16-2YB5</b>	<b>SIMATIC PDM Demo V6.1</b> Without online communication and storage functionality  6 languages (English, German, French, Italian, Spanish, Chinese), software class A, runs with Windows XP Professional/ Server 2003  Delivery form package (without SIMATIC PCS 7 Software Media Package) SIMATIC PDM software and device library on CD/DVD	<b>6ES7658-3GX16-0YC8</b>
<b>SIMATIC PDM Routing V6.1</b> 6 languages (English, German, French, Italian, Spanish, Chinese), software class A, runs with Windows XP Professional/ Server 2003, floating license for 1 user  Delivery form package License key on USB stick, certificate of license	<b>6ES7658-3CX16-2YB5</b>		
<b>SIMATIC PDM Communication via standard HART multiplexer V6.1</b> 6 languages (English, German, French, Italian, Spanish, Chinese), software class A, runs with Windows XP Professional/Server 2003, floating license for 1 user  Delivery form package License key on USB stick, certificate of license	<b>6ES7658-3EX16-2YB5</b>		

## PROFIBUS

### Engineering/Network Management/Diagnostics

#### SIMATIC PDM

##### More information

###### **Update/Upgrade**

Product packages and optional product components from the product range of SIMATIC PDM V6.0, V6.1 or V8.0 can be directly upgraded to V8.1 (incl. service pack).

Exception: SIMATIC PDM Single Point and SIMATIC PDM Communication via standard HART multiplexer.

Product packages and optional product components from the product range of SIMATIC PDM V7.0 can first be upgraded to V8.0 and then to V8.1.

When upgrading to SIMATIC PDM V8.1, be aware of the compatible versions of SIMATIC PCS 7 and STEP 7.

A Software Update Service in the form of a subscription is also offered for SIMATIC PDM.

For additional information, see the subsections "Updates/upgrades asynchronous to the PCS 7 version" and "Software Update Service" in the "Update/upgrade packages" section.



### Overview

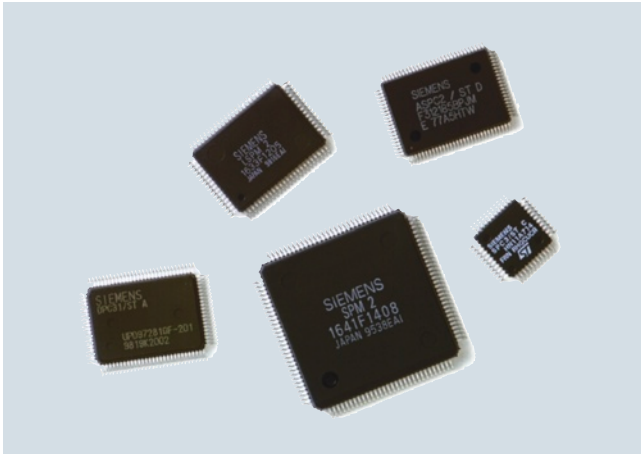

- Easy connection of field devices to PROFIBUS
- Integrated low power management
- Different ASICs for the different functional requirements and application areas

### Application

The PROFIBUS DP ASICs allow equipment manufacturers to connect their devices to PROFIBUS easily.

They can be implemented at transmission rates of up to 12 Mbit/s.

The following blocks are available for different functional requirements and fields of application:

- Master applications:  
ASPC 2
- Intelligent slaves:  
SPC 3 and SPC3LV for PROFIBUS DP, with hardware-controlled bus access;  
DPC 31 with integral 8031 core;  
SPC 4-2.
- Connection in intrinsically safe systems:  
SIM 1-2 for physical connection in intrinsically safe fieldbus systems as a Medium Attachment Unit for IEC 61158-2 at 31.25 Kbit/s. Especially for combining with the SPC 4-2 and DPC 31.
- Simple slaves:  
LSPM 2 with 32 input/output bits for confined spaces
- Connection to fiber-optic conductors:  
FOCSI  
module for electrical conditioning of signals already received or to be sent. The module ensures that the optically transmitted signals are properly electrically restored (retiming/retriggering)

For initial development, order quantities of 5/6 ASICs are possible (not suitable for batch assembly because the pins of the ASIC can be bent due to the packaging; packing units larger than 5/6 units must be used)

The number of ASICs per packing unit depends on the ASIC type (see ordering data).

The ASICs ASPC 2, SPC3, SPC3LV, DPC31, LSPM2 and FOCSI can also be supplied in a lead-free design.

### Design

#### ASPC 2

The ASPC 2 is a preprocessing communications chip for master applications with a maximum transmission rate of 12 Mbit/s. The ASIC has not been disclosed. The brief user manual describes the pins and the electrical properties of the ASPC 2. A separate microprocessor and the appropriate firmware are required for operation. The firmware is tuned to the 80C165 processor and can be obtained by purchasing a license.

#### SPC 3

The SPC 3 is a preprocessing communications chip with a processor interface. The SPC 3 processes message frame identification, address identification, execution of the data back-up sequences and protocol processing for PROFIBUS DP.

Firmware is offered for the Siemens SPC 3 (see ordering data).

#### SPC 3LV

The product portfolio for intelligent PROFIBUS slave applications was expanded by a 3.3 V version. The SPC3LV is 100% compatible in terms of functions and pins to the 5 V version (SPC3).

#### DPC 31

The DPC 31 is a preprocessing communications module with a processor interface and an integrated processor core (C31 core).

It supports the connection of intelligent field devices as slaves on PROFIBUS DP and PROFIBUS PA.

The DPC 31 autonomously processes all communications tasks and has, in addition, an integral C31 core for further applications. It combines the communication properties of the ASICs SPC 3 and SPC 4-2 in one chip. The integrated C31 core can also be programmed as required. Firmware is offered for the Siemens ASIC DPC 31 (see ordering data).

#### SPC 4-2

The SPC 4-2 is a preprocessing communications chip with a processor interface. It is designed for combined applications and due to the Low Power Management function, it is ideally suited to use in intrinsically safe applications. Firmware is offered for the SPC 4-2 by the company TMG itec<sup>1)</sup>. The signals are converted for PROFIBUS PA using the SIM 1-2 module.

<sup>1)</sup> Order from:  
TMG itec  
76137 Karlsruhe  
Tel. +49 (0)721 82 80 60

# PROFIBUS

## PROFIBUS Components

### PROFIBUS DP ASICs

#### Design (continued)

##### SIM 1-2

The SIM 1-2 supplements the SPC 4-2 or DPC 31. Only a few external components are required in addition to these ASICs to be able to connect field devices to an intrinsically safe network in accordance with PROFIBUS PA. In combination with the SPC 4-2 or DPC 31, the functions of a PROFIBUS PA slave can be processed from physical linking through to communication control.

SIM 1-2 supports all send and receive functions (including Jabber Control) as well as the high-resistance decoupling of auxiliary power from the bus cable. It provides an adjustable, stabilized supply voltage and also supports configuration of an electrically isolating power supply with just a few passive components.

The ASIC contains a special interface logic which provides a low-overhead, minimum power interface for galvanic signal separation as an alternative to the standard signal interface.

It can be connected to all Manchester encoders/decoders to the IEC 61 158-2 standard at 31.25 kbit/s.

##### LSPM 2

LSPM 2 is a single-chip solution with 32 input/output bits. It processes all bus communication autonomously. An additional microprocessor and firmware are not required. The compact MQFP casing with 80 pins makes it ideal for applications with low space requirements.

##### FOCSI

This ASIC functions as an expansion to the existing PROFIBUS ASICs. The FOCSI module (Fiber Optic Controller from Siemens) ensures proper electrical conditioning and transfer of the received/sent optical signal. To inject the signal into a fiber-optic conductor, apart from FOCSI, the appropriate optical transmitter and receiver will be required. FOCSI can be used with the PROFIBUS DP ASICs described above.

**Additional ordering data available on request**

#### Technical specifications

	LSPM 2	SPC 3	SPC 3LV	DPC 31
Protocol	PROFIBUS DP	PROFIBUS DP	PROFIBUS DP	PROFIBUS DP, PROFIBUS PA
Application range	simple slave application	intelligent slave application	intelligent slave application	intelligent slave application
Transmission rate, max.	12 Mbit/s	12 Mbit/s	12 Mbit/s	12 Mbit/s
Bus access	in ASIC	in ASIC	in ASIC	in ASIC
Automatic determination of transmission rate	yes	yes	yes	yes
Microprocessor required	no	yes	yes	integrated
Scope of firmware	not required	6 to 24 KB	6 to 24 KB	approx. 38 KB
Message buffer	-	1.5 KB	1.5 KB	6 KB
Power supply	5 V DC	5 V DC	3.3 V DC	3.3 V DC
Power loss, max.	0.35 W	0.5 W	<0.5 W	0.2 W
Permissible ambient temperature	-40 °C ... +75 °C	-40 °C ... +85 °C	-40 °C ... +85 °C	-40 °C ... +85 °C
Housing	MQFP, 80-pin	PQFP, 44-pin	PQFP, 44-pin	PQFP, 100-pin
Frame size	4 cm <sup>2</sup>	2 cm <sup>2</sup>	2 cm <sup>2</sup>	4 cm <sup>2</sup>
Delivery quantities (pcs.)	6/66/330/4 950	6/96/750/960/4 800	5/160/800/1 000/4 800	STEP B: 6/60/300/5 100 STEP C1: 6/66/660/4 620

	SPC 4-2	ASPC 2	SIM 1-2	FOCSI
Protocol	PROFIBUS DP PROFIBUS FMS PROFIBUS PA	PROFIBUS DP PROFIBUS FMS PROFIBUS PA	PROFIBUS PA	-
Application range	Intelligent slave application	Master application	Medium Attachment	Medium Management Unit
Transmission rate, max.	12 Mbit/s	12 Mbit/s	31.25 kbit/s	12 Mbit/s
Bus access	in ASIC	in ASIC	-	-
Automatic determination of transmission rate	yes	yes	-	-
Microprocessor required	yes	yes	-	-
Scope of firmware	3 ... 30 KB	80 KB	not required	not required
Message buffer	3 KB	1 MB (external)	-	-
Voltage supply	5 V DC, 3.3 V	5 V DC	via bus	3.3 V DC
Power loss, max.	0.6 W at 5 V 0.01 W at 3.3 V	0.9 W	0.05 W	0.75 W
Permissible ambient temperature	-40 °C ... +85 °C	-40 °C ... +85 °C	-40 °C ... +85 °C	-40 °C ... +85 °C
Housing	TQFP, 44-pin	P-MQFP, 100-pin	MLPQ, 40-pin	TQFP, 44-pin
Frame size	2 cm <sup>2</sup>	4 cm <sup>2</sup>	36 mm <sup>2</sup>	2 cm <sup>2</sup>
Delivery quantities (pcs.)	5/160	6/66/660/4 620	30/60/1 000	40

Ordering data	Article No.	Article No.
<b>ASIC ASPC 2</b> For constructing master interfaces (quantity discount) <ul style="list-style-type: none"> <li>• 6 units (lead-free)</li> <li>• 66 units (lead-free)</li> <li>• 660 units (lead-free)</li> <li>• 4 620 units (lead-free)</li> </ul>	<b>6ES7195-0AA05-0XA0</b> <b>6ES7195-0AA15-0XA0</b> <b>6ES7195-0AA25-0XA0</b> <b>6ES7195-0AA35-0XA0</b>	<b>ASIC DPC 31 STEP B</b> For constructing intelligent DP slave interfaces (quantity discounts) <ul style="list-style-type: none"> <li>• 6 units (lead-free)</li> <li>• 60 units (lead-free)</li> <li>• 300 units (lead-free)</li> <li>• 5 100 units (lead-free)</li> </ul>
<b>ASIC LSPM 2</b> For constructing simple slave interfaces (quantity discount) <ul style="list-style-type: none"> <li>• 6 units (lead-free)</li> <li>• 66 units (lead-free)</li> <li>• 330 units (lead-free)</li> <li>• 4 950 units (lead-free)</li> </ul>	<b>6ES7195-0BA02-0XA0</b> <b>6ES7195-0BA12-0XA0</b> <b>6ES7195-0BA22-0XA0</b> <b>6ES7195-0BA32-0XA0</b>	<b>ASIC DPC 31 STEP C1</b> For constructing intelligent DP slave interfaces (quantity discounts) <ul style="list-style-type: none"> <li>• 6 units (lead-free)</li> <li>• 66 units (lead-free)</li> <li>• 660 units (lead-free)</li> <li>• 4 620 units (lead-free)</li> </ul>
<b>ASIC SPC 3</b> For constructing intelligent DP slave interfaces (quantity discounts) <ul style="list-style-type: none"> <li>• 6 units (lead-free)</li> <li>• 96 units (lead-free)</li> <li>• 960 units (lead-free)</li> <li>• 4 800 units (lead-free)</li> <li>• 750 units (lead-free) T&amp;R</li> </ul>	<b>6ES7195-0BD04-0XA0</b> <b>6ES7195-0BD14-0XA0</b> <b>6ES7195-0BD24-0XA0</b> <b>6ES7195-0BD34-0XA0</b> <b>6ES7195-0BD44-0XA0</b>	<b>ASIC SPC 4-2</b> For constructing intelligent DP slave interfaces (quantity discounts) <ul style="list-style-type: none"> <li>• 5 units for laboratory development (lead-free)</li> <li>• 160 units (lead-free, 1 tray)</li> </ul>
<b>ASIC SPC 3LV</b> For constructing intelligent DP slave interfaces (quantity discounts) <ul style="list-style-type: none"> <li>• 5 units (lead-free)</li> <li>• 160 units (lead-free)</li> <li>• 800 units (lead-free)</li> <li>• 4 800 units (lead-free)</li> <li>• 1 000 units (lead-free) T&amp;R</li> </ul>	<b>6ES7195-0BG00-0XA0</b> <b>6ES7195-0BG10-0XA0</b> <b>6ES7195-0BG20-0XA0</b> <b>6ES7195-0BG30-0XA0</b> <b>6ES7195-0BG40-0XA0</b>	<b>ASIC SIM 1-2</b> For connection according to IEC H1 for PROFIBUS PA with a transmission rate of 31.25 kbit/s <ul style="list-style-type: none"> <li>• 60 units (in tube)</li> <li>• 1 000 units (tape &amp; reel)</li> </ul>
<b>ASIC FOCSI</b> Fiber Optic Controller from Siemens for conditioning signals for the optical PROFIBUS <ul style="list-style-type: none"> <li>• 40 units (lead-free)</li> </ul>	<b>6ES7195-0EA20-0XA0</b>	<b>Accessories</b>  <b>Firmware for Siemens ASIC SPC 3</b> <ul style="list-style-type: none"> <li>• DP firmware</li> <li>• DPV1 firmware</li> <li>• DPV1 firmware upgrade</li> </ul>
		<b>Firmware for Siemens ASIC DPC 31</b> <ul style="list-style-type: none"> <li>• DPV1 firmware</li> </ul>
		<b>6ES7195-0BE02-0XA0</b> <b>6ES7195-0BE12-0XA0</b> <b>6ES7195-0BE22-0XA0</b> <b>6ES7195-0BE32-0XA0</b>  <b>6ES7195-0BF02-0XA0</b> <b>6ES7195-0BF12-0XA0</b> <b>6ES7195-0BF22-0XA0</b> <b>6ES7195-0BF32-0XA0</b>  <b>6GK1588-3AA00</b> <b>6GK1588-3AA15</b>  <b>6GK1588-3BB02</b> <b>6GK1588-3BB21</b>  <b>6ES7195-2BA00-0XA0</b> <b>6ES7195-2BA01-0XA0</b> <b>6ES7195-2BA02-0XA0</b>  <b>6ES7195-2BB00-0XA0</b>

## More information

### Brochures

Information material for downloading can be found in the Internet:

<http://www.siemens.com/simatic/printmaterial>

### Support

Please contact the following Competence Centers for any technical questions:

#### Germany and Europe

Siemens AG  
 Communication, Development & Certification (ComDeC)  
 PO Box 23555  
 90713 Fürth, Germany  
 Tel.: +49 (911) 750-2080  
 Fax: +49 (911) 750-2100  
 E-mail: [comdec@siemens.com](mailto:comdec@siemens.com)

#### USA and International

PROFI Interface Center (PIC)  
 One Internet Plaza  
 PO Box 4991  
 Johnson City, TN 37602-4991  
 Tel.: +1 (423) - 262 - 2969  
 Fax: +1 (423) - 262 - 2103  
 E-mail: [profibus.sea@siemens.com](mailto:profibus.sea@siemens.com)

# PROFIBUS

## PROFIBUS Components

### Connections/interfaces

#### Overview

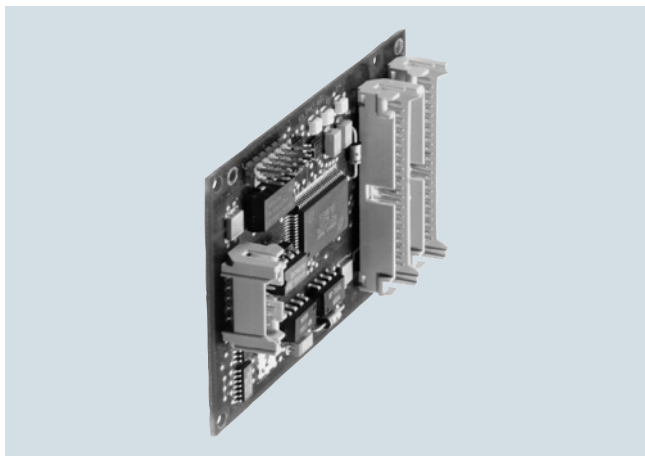

- PC slave board IM 182-1 for the connection of AT-compatible PCs as DP slaves

#### Application

The PROFIBUS DP interface module IM 182-2 makes it easy to connect a slave to PROFIBUS DP. It is based on the ASIC SPC3 of Siemens AG. The interface module can be implemented up to a transmission rate of 12 Mbit/s.

#### Design

IM 182-1 PC slave board

The simple IM 182-1 PC slave card (ISA bus) is based on the ASIC SPC 3. It contains all the physical bus components. A 9-pin Sub-D connector is used for connecting to PROFIBUS DP.

The firmware of the SPC 3 can be used as an accessory on the PC. The 1.5 KB RAM of the SPC 3 forms the interface to the host system. A driver for Windows NT is also offered.

#### Technical specifications

6ES7 182-0AA01-0XA0	
<b>General information</b>	
Application area	Slave applications
ASIC	SPC 3
• Scope of firmware	4 to 24 KB (incl. test program)
<b>Supply voltage</b>	
5 V DC	Yes
<b>Input current</b>	
Current consumption, typ.	250 mA
<b>Processor</b>	
Microprocessor type	Processor of the PG/PC
<b>Interfaces</b>	
PROFIBUS DP	
• Transmission rate, max.	12 Mbit/s
<b>Protocols</b>	
PROFIBUS DP	Yes
<b>Ambient conditions</b>	
Operating temperature	
• Min.	0 °C
• Max.	60 °C
<b>Dimensions</b>	
Width	168 mm
Height	105 mm

#### Ordering data

#### Article No.

##### SIMATIC S5/S7 IM 182-1 PC slave board

6ES7182-0AA01-0XA0

For PROFIBUS DP, max. 12 Mbit/s

##### Accessories

##### Firmware for Siemens ASIC SPC 3 and IM 182-1

- DP firmware
- DPV1 firmware
- DPV1 firmware upgrade

6ES7195-2BA00-0XA0  
6ES7195-2BA01-0XA0  
6ES7195-2BA02-0XA0

#### More information

##### Brochures

Information material for downloading can be found in the Internet:

<http://www.siemens.com/simatic/printmaterial>

##### Manuals

Manuals for PROFIBUS DP connections are available free in the Internet.

##### Support

Please contact the following Competence Centers for any technical questions:

##### Germany and Europe

Siemens AG  
Communication, Development & Certification (ComDeC)  
PO Box 23555  
90713 Fürth, Germany  
Tel.: +49 (911) 750-2080  
Fax: +49 (911) 750-2100  
E-mail: [comdec@siemens.com](mailto:comdec@siemens.com)

##### USA and International

PROFI Interface Center (PIC)  
One Internet Plaza  
PO Box 4991  
Johnson City, TN 37602-4991  
Tel.: +1 (423) - 262 - 2969  
Fax: +1 (423) - 262 - 2103  
E-mail: [profibus.sea@siemens.com](mailto:profibus.sea@siemens.com)

### Overview

#### Development kit

Using the development kits, PROFIBUS hardware and software applications can be developed and tested using the PROFIBUS ASICs DPC31.

The comprehensive, perfectly interacting hardware and software components considerably reduce the development costs for a PROFIBUS device.

The kits provide a fully functional hardware development environment which development engineers can build on with their special requirements for hardware and software. The kit documentation is supplied on CD in English and German.

The kits make our PROFIBUS know-how accessible to other users. The development team is available to provide advice to new users even with their own developments - this consultancy service is also a component part of the development kit.

Following completion of a development, devices can be certified by our experts in the PROFIBUS interface centers – we can help new users here, too.

#### PROFIBUS DP/PA development kit

The kit facilitates set up of PROFIBUS slaves with a variety of PROFIBUS standards:

- PROFIBUS DP-V1 (RS485)
- PROFIBUS PA (IEC 1158) and
- PROFIBUS based on fiber-optic cables.

The development environment shows applications implemented using PROFIBUS-ASICs DPC 31.

Hardware included:

- DPC 31 development board; for developing/testing proprietary applications
- CP 5613; serves as master interface for the PC (PCI card)
- Optical bus terminal; for conversion of copper cables to FOCs
- Pre-assembled PROFIBUS cables

Software included:

- Testing and simulation software under WinNT for use on the PC in connection with the CP 5613 master module
- Sample program for the DPC 31 board
- DPC 31 DPV1 original firmware, including developer license
- Parameterization software for CP 5613 "COM PROFIBUS" for DP operation

When developing PROFIBUS PA applications, order a PROFIBUS DP/PA coupler (6ES7 157-0AC80-0XA0) separately. The DP/PA coupler converts the PROFIBUS DP physical specifications into those of PROFIBUS PA. This module is not included in the development kit!

#### PROFIsafe starter kit V3.4

The PROFIsafe starter kit V3.4 is compatible with version 2.4 of the PROFIsafe profile, as specified in IEC 61784-3-3. It meets a series of user requirements such as multi-instance capability and variable process data length at runtime.

Along with all of the PI specifications required for development, the PROFIsafe starter kit contains the source files for the PROFIsafe driver software (PSD) and a comprehensive implementation manual in English and German. In addition, it includes various CRC calculation tools and tools for creating GSD files with security-related parameters.

Examples of adaptation of the PSD (PROFIsafe Driver) to current PROFIBUS and PROFINET stack interfaces provide assistance for adaptations that may be necessary. Special "slow motion monitors" allow the PROFIsafe protocol processes to be monitored in slow motion. A new feature is support for the iPar server and the TCI interface.

Example applications are provided on the CD-ROM for both PROFIBUS and PROFINET. The hardware components supplied in the development kits offer the user access to the PROFIsafe world, step-by-step.

The PROFIsafe starter kit consists of the following components:

- Current PROFIsafe specifications with current PROFIsafe certificate
- PROFIsafe driver software (as core component of the development package)
- Example GSD file for STEP7 (for PROFIBUS DP/PA development package and DK-ERTEC 200 PN IO)
- Example project for S7-319F (for PROFIBUS DP/PA development package and DK-ERTEC 200 PN IO)
- GSD tools (e.g. GSD editor and CRC calculation tool)
- iPar server software and instructions (FB24)
- Tool calling interface example and instructions
- F programming guidelines
- Layer stacks (V1SL and PN IO)
- Example firmware (for PROFIBUS DP/PA development package and DK-ERTEC 200 PN IO)
- Project for development environment example (for PROFIBUS DP/PA development package and DK-ERTEC 200 PN IO)
- Slow motion monitor (for PROFIBUS: PG-PC and CP5613, for PROFINET: PG-CP1616)
- Comprehensive documentation

# PROFIBUS

## PROFIBUS Components

### Development kits

Ordering data	Article No.
<b>DP/PA development kit</b> For PROFIBUS ASIC DPC 31 and SIM1, English/German	<b>6ES7195-3BA10-0YA0</b>
<b>PROFIsafe starter kit V3.4</b>	<b>6ES7195-3BF02-0YA0</b>

### More information

#### Brochures

Information material for downloading can be found in the Internet:

<http://www.siemens.com/simatic/printmaterial>

#### Manuals

Manuals for PROFIBUS DP connections are available free in the Internet.

#### Support

Please contact the following Competence Centers for any technical questions:

##### Germany and Europe

Siemens AG  
 Communication, Development & Certification (ComDeC)  
 PO Box 23555  
 90713 Fürth, Germany  
 Tel.: +49 (911) 750-2080  
 Fax: +49 (911) 750-2100  
 E-mail: [comdec@siemens.com](mailto:comdec@siemens.com)

##### USA and International

PROFI Interface Center (PIC)  
 One Internet Piazza  
 PO Box 4991  
 Johnson City, TN 37602-4991  
 Tel.: +1 (423) - 262 - 2969  
 Fax: +1 (423) - 262 - 2103  
 E-mail: [profibus.sea@siemens.com](mailto:profibus.sea@siemens.com)



<b>4/2</b>	<b>Introduction</b>	<b>4/80</b>	SIRIUS 3RA27 function modules for AS-Interface
4/2	Communication overview	<b>4/82</b>	<u>Motor starters for use in the control cabinet</u>
4/3	System components	4/82	SIRIUS 3RA6 compact starters
4/4	AS-Interface specification V3.0	4/82	- General data
<b>4/6</b>	<b>ASIsafe</b>	4/85	- 3RA61 direct-on-line starters
4/6	Introduction	4/86	- 3RA62 reversing starters
4/48	DP/AS-i F-Link	4/87	- Accessories
4/40	F-CM AS-i Safety ST for SIMATIC ET 200P	4/92	- Add-on modules for AS-Interface
Ch.3	SIRIUS 3RK3	4/94	- Infeed system for 3RA6
	Modular Safety System	4/101	<u>Motor starters for use in the field, high degree of protection</u>
4/8	AS-Interface safety monitors	4/101	SIRIUS M200D motor starters
4/9	AS-Interface safety modules	4/101	- General data
4/12	SIRIUS 3SF1 mechanical safety switches	4/102	- M200D motor starters for AS-Interface
4/28	SIRIUS 3SF2 cable-operated switches for AS-Interface	4/107	- Accessories
4/29	SIRIUS EMERGENCY-STOP mushroom pushbuttons for AS-Interface	4/111	SIRIUS MCU motor starters for AS-Interface
4/32	AS-Interface F adapters for EMERGENCY-STOP devices	4/111	- General data
<b>4/33</b>	<b>Masters</b>	4/113	- Plastic enclosures, electromechanical switching
4/33	<u>Masters for SIMATIC S7</u>	4/114	- Metal enclosures, electromechanical switching
4/33	CM 1243-2	4/116	- Metal enclosures, electronic switching
4/35	CP 343-2P / CP 343-2	4/117	Motor starters for AS-Interface, 24 V DC
4/37	<u>Masters for SIMATIC ET 200</u>	4/120	<u>SINAMICS G110D distributed inverters</u>
4/37	CM AS-i Master ST for SIMATIC ET 200SP	4/123	<u>3SF5 pushbuttons and indicator lights</u>
4/40	F-CM AS-i Safety ST for SIMATIC ET 200SP	4/123	Housing and front panel module for AS-Interface
<b>4/43</b>	<b>Network transitions</b>	4/123	- General data
4/43	DP/AS-i LINK Advanced	4/124	- With standard fittings
4/46	DP/AS-Interface Link 20E	4/125	- Components
4/48	DP/AS-i F-Link	4/126	- Customized equipment
4/52	IE/AS-i LINK PN IO	4/127	- Front panel module
<b>4/55</b>	<b>Slaves</b>	4/132	<u>8WD4 signaling columns</u>
4/55	<u>I/O modules for use in the field, high degree of protection</u>	<b>4/137</b>	<b>Power supply units and data decoupling modules</b>
4/55	Digital I/O modules, IP67 - Introduction	4/137	AS-Interface power supply units
4/56	Digital I/O modules, IP67 - K60	4/138	30 V power supply units
4/58	Digital I/O modules, IP68/IP69K - K60R	IC 10 <sup>1)</sup>	24 V power supply units
4/60	Digital I/O modules, IP67 - K45	4/140	S22.5 data decoupling modules
4/62	Digital I/O modules, IP67 - K20	4/142	<u>Data decoupling modules for S7-1200</u>
4/64	Analog I/O modules, IP67 - K60	4/142	DCM 1271 data decoupling modules
4/67	<u>I/O modules for use in the control cabinet</u>	<b>4/144</b>	<b>Transmission media</b>
4/67	Introduction	4/144	AS-Interface shaped cables
4/68	SlimLine	<b>4/145</b>	<b>System components and accessories</b>
4/70	F90 module	4/145	Repeater
4/71	Flat module	4/146	Extension plug
4/72	<u>Special integrated solutions</u>	4/147	Addressing units
4/72	AS-interface communication modules	4/149	Analyzer
4/74	<u>Modules with special functions</u>	4/152	Miscellaneous accessories
4/74	Counter modules	<b>4/155</b>	<b>Software</b>
4/75	Ground-fault detection modules	4/155	AS-Interface block library for SIMATIC PCS 7
4/76	Overvoltage protection module	1)	See Catalog IC 10 "Industrial controls".
4/77	AS-Interface connections for LOGO!		
4/78	<u>Contactors and contactor assemblies</u>		
4/78	Power contactors for switching motors – SIRIUS 3RT20 contactors		
4/79	Contactor assemblies – SIRIUS 3RA24 for wye-delta assemblies		

# AS-Interface

## Introduction

### Communication overview

#### Overview

AS-Interface is an open, international standard according to EN 50295 and IEC 62026-2 for process and field communication. Leading manufacturers of actuators and sensors all over the world support the AS-Interface. Interested companies are provided with the electrical and mechanical specifications by the AS-Interface Association.

AS-Interface is a single master system. For automation systems from Siemens, there are communications processors (CPs) communications modules (CMs) and network transitions (links) that control the process or field communication as masters, and actuators and sensors that are activated as AS-Interface slaves.

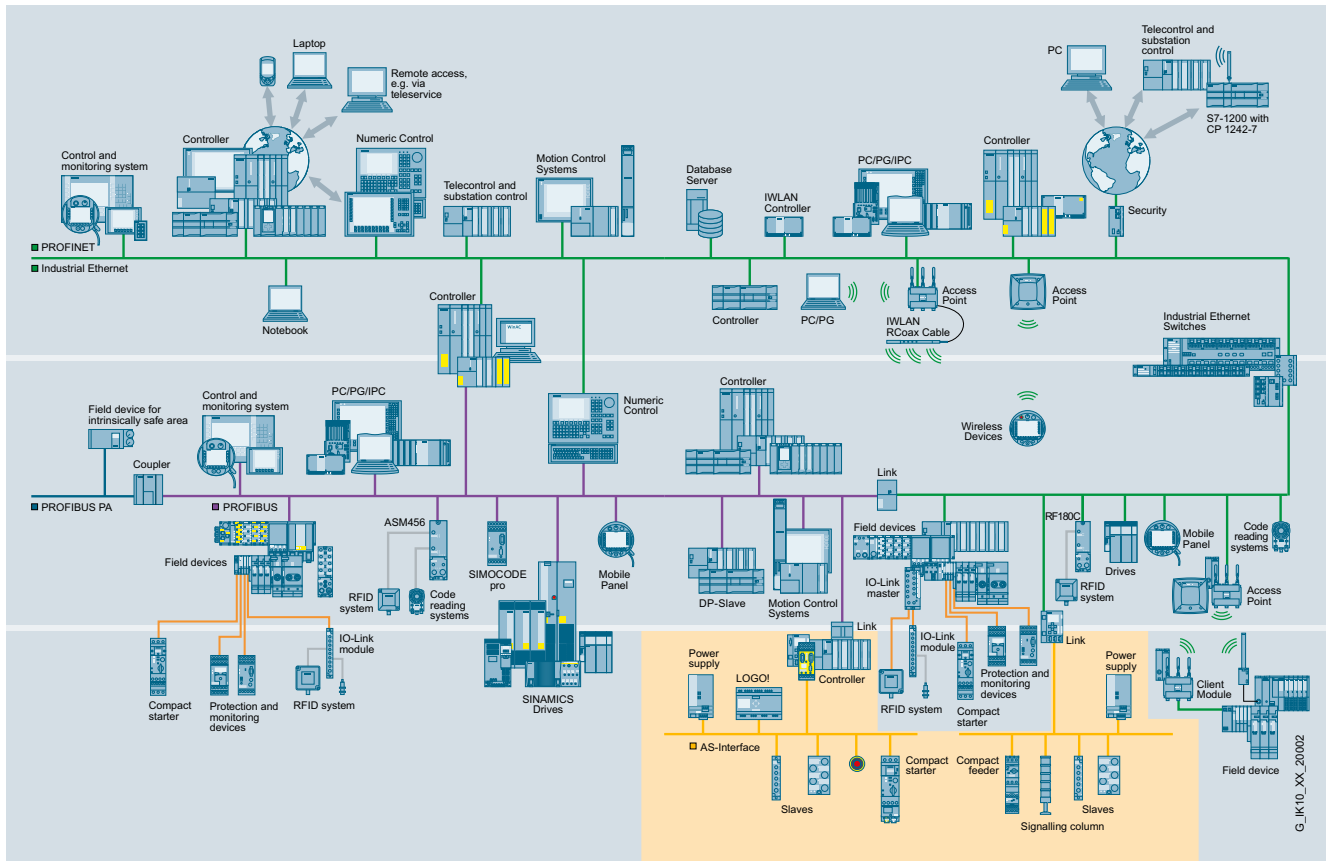

#### Benefits

A key feature of AS-Interface technology is the use of a shared two-conductor cable for data transmission and the distribution of auxiliary power to the sensors/actuators. A power supply unit which meets the requirements of the AS-Interface transmission method and has an external data decoupling module if required is used for the distribution of auxiliary power. The AS-Interface cable used for the wiring is mechanically coded and hence protected against polarity reversal and can be easily contacted by the insulation piercing method.

Elaborately wired control cables in the control cabinet and marshalling racks can be replaced by AS-Interface.

The AS-Interface cable can be connected to any points thanks to a specially developed cable and connection by the insulation piercing method.

With this concept you become extremely flexible and achieve high savings.

#### Application

##### I/O data exchange

The AS-i master transmits automatically the inputs and outputs between the control system and the digital and analog AS-Interface slaves.

Slave diagnostics information is forwarded to the control system when required.

The latest AS-Interface masters according to the AS-Interface Specification V3.0 support integrated analog value processing. This means that data exchange with analog AS-Interface slaves is just as easy as with digital slaves.

##### Command interface

In addition to I/O data exchange with binary and analog AS-Interface slaves the AS-Interface masters provide a number of other functions through the command interface.

Hence it is possible, for example, for slave addresses to be issued, parameter values transferred or configuration information read out from user programs.

For more information see

<http://support.automation.siemens.com/WW/view/en/51678777>.



**Overview**

To implement communication, a system installation has the following main components:

- Master interface modules for central control units such as SIMATIC S7, ET 200/ET 200SP distributed peripherals, or network transitions from PROFIBUS/PROFINET to AS-Interface
- Power supply units, if required in combination with a data decoupling module for the power supply to the slaves
- AS-Interface shaped cables
- Network components such as repeaters and extension plugs (cannot be used for AS-i Power24V)
- Modules for connection of standard sensors/actuators
- Actuators and sensors with integrated AS-i slave
- Secure modules for transferring safety-related data over AS-Interface
- Addressing units for setting the slave addresses during commissioning

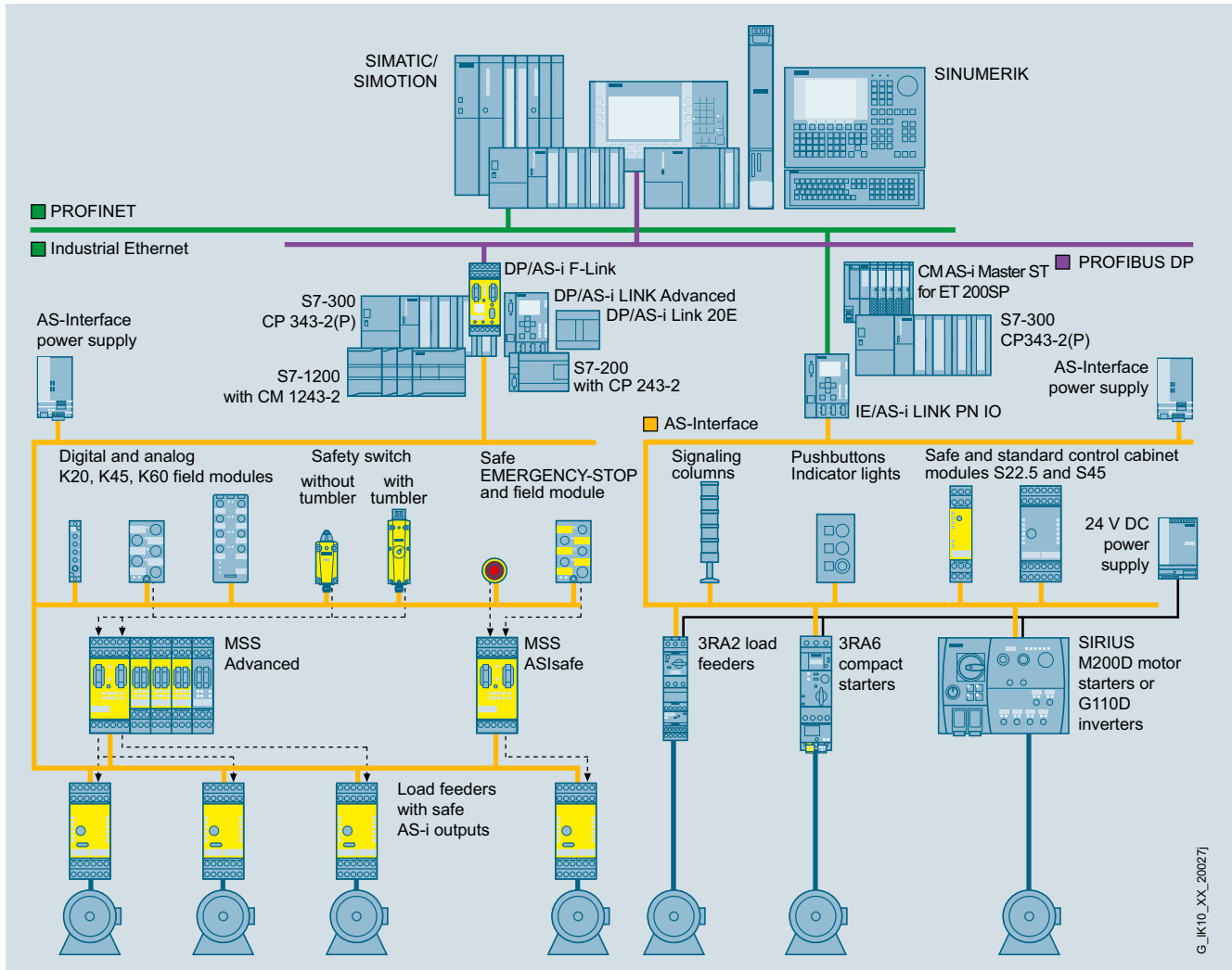

Example of a configuration with the system components

**Features**

Standard	EN 50295 / IEC 62026-2
Topology	Line, star or tree structure (same as electrical wiring)
Transmission medium	Unshielded two-wire cable (2 x 1.5 mm <sup>2</sup> ) for data and auxiliary power
Connection methods	Contacting of the AS-Interface cable by insulation piercing method
Maximum cable length	<ul style="list-style-type: none"> <li>• 100 m without repeater</li> <li>• 200 m with extension plug</li> <li>• 300 m with two repeaters in series connection</li> <li>• 600 m with extension plugs and two repeaters connected in parallel</li> </ul> Larger cable lengths are also possible when additional repeaters are connected in parallel

Maximum cycle time	<ul style="list-style-type: none"> <li>• 5 ms in maximum configuration with 31 standard addresses</li> <li>• 10 ms in maximum configuration with 62 A/B addresses</li> <li>• profile-specific for slaves with extended data, e.g. analog slaves</li> </ul>
Number of stations per AS-Interface line	<ul style="list-style-type: none"> <li>• Up to 62 Slaves (A/B technology)</li> <li>• Integrated analog value transmission</li> </ul>
Number of binary sensors and actuators	Max. 496 DI/496 DO
Access control	<ul style="list-style-type: none"> <li>• Cyclic polling master/slave procedure</li> <li>• Cyclic data acceptance from host (PLC, PC)</li> </ul>
Error safeguard	Identification and repetition of faulty message frames

## AS-Interface

Introduction

AS-Interface specification

### Specification V3.0

#### Overview

##### Scope of the AS-Interface specification

Maximum number of slaves			Number of digital inputs	Number of digital outputs
Digital	Analog	ASIsafe	DI	DO
62	62	31	$62 \times 8 = 496$	$62 \times 8 = 496$

##### Basic data

AS-Interface Specification 3.0 describes a fieldbus system with an AS-i master and up to 62 AS-i slaves.

- The standard slaves continue to occupy one AS-i address (1...31).
- Slaves with extended addressing divide an address into an A address (1A...31A) and a B address (1B...31B). Up to 62 A/B slaves can be connected accordingly to one AS-Interface network.
- Mixed operation of standard slaves and A/B slaves is possible without difficulty. The AS-i master identifies automatically which type of slave is connected. No special adjustments are required of the user.
- A digital AS-i slave has up to 4 digital inputs and 4 digital outputs.
- Transmission of digital input/output data requires a cycle time of max. 5 ms with 31 slaves, see "Communication cycle" for further values.
- Integrated analog value transmission permits access to both analog values and digital values without the need for any special function blocks.

##### Communication cycle

###### Maximum cycle time (digital signals)

- 5 ms with 31 slaves
- 10 ms with 62 slaves
- Up to 20 ms for A/B slaves with 4DI/4DO
- Up to 40 ms for A/B slaves with 8DI/8DO

Each address is queried in max. 5 ms cycle time. If two A/B slaves are operated on one basic address (e.g. 12A and 12B), a maximum 10 ms will be required for updating the data of both slaves.

All slave types can be mixed and used on a single AS-Interface network.

For more information, for example, to find out whether an AS-Interface slave is a standard or A/B slave, refer to "Selection and ordering data" of the relevant slave.

Available masters with the latest AS-Interface specification V3.0

- CP 343-2, CP 343-2P (S7-300 / ET 200M)
- DP/AS-i LINK Advanced
- DP/AS-i F-Link
- DP/AS-Interface Link 20E
- IE/AS-i LINKPNIO
- CM 1243-2 (S7-1200)
- CM AS-i Master ST (ET 200SP)

#### More information

##### AS-Interface system manual

The AS-Interface system manual is available as a free download.

- German  
<http://support.automation.siemens.com/WW/view/de/26250840>
- English  
<http://support.automation.siemens.com/WW/view/en/26250840>

## Overview



AS-Interface data decoupling modules for AS-i Power24V, left: S22.5 data decoupling module, right: DCM 1271 data decoupling module for SIMATIC S7-1200

Parallel wiring frequently dominates, above all, in applications with very few I/Os. Although AS-Interface is similarly well suited for small applications, its use is often prevented by the cost of the 30 V AS-Interface power supply unit which is required in addition.

Through the expansion of AS-Interface with AS-i Power24V and the resulting possibility of using existing standard 24 V DC power supply units in AS-i networks, AS-Interface is now also attractive for applications with a very tight budget.

### Data and power in standard AS-Interface networks up to now

One of the great advantages of AS-Interface is the ability to convey not only data, but also the power needed for the connected slaves and sensors over the same unshielded two-conductor cable. This is owed to the service-proven AS-Interface power supply units which provide integrated data decoupling as well as overload and short-circuit protection and integrated ground-fault monitoring.

### The new technology

Through the expansion of AS-Interface with AS-i Power24V it is now also possible to use 24 V standard power supply units in AS-i networks. The communication technology of AS-Interfaces works at the same high level of quality with an operating voltage of both 30 V DC and 24 V DC.

#### Key data of AS-i Power24V

Number of slaves	Up to 62 standard slaves and up to 31 safe slaves
Topology	Any
Range	Up to 50 m
Components	<ul style="list-style-type: none"> <li>• 24 V power supply unit with little residual ripple and imitation to max. 40 V</li> <li>• AS-i Power24V-capable data decoupling with integrated ground-fault detection</li> <li>• AS-i Power24V-capable masters, slaves and components</li> </ul>

### Requirements for operation of an AS-i Power24V network

- When 24 V power supply units are used, the maximum network range of 50 m must be observed in order to reach slaves and sensors with a sufficient level of voltage (at least 18 V).
- The power supply units must comply with the PELV (Protective Extra Low Voltage) or SELV (Safety Extra Low Voltage) standards, have a residual ripple of  $< 250 \text{ mV}_{pp}$ , and in the event of a fault must limit the output voltage to a maximum of 40 V. SITOP power supply units are recommended, see Catalog IC 10, Chapter 15 "Products for Specific Requirements" → "Stabilized Power Supplies".
- When used in conjunction with standard 24 V power supply units, each AS-Interface network requires Power24V-capable data decoupling with adapted ground-fault detection, see page 4/75.
- For reliable operation of an AS-i network with 24 V voltage, it is important that the masters, slaves and other components are approved for AS-i Power24V. AS-i Power24V-capable AS-i components can also be used without restriction in standard 30 V AS-i networks.
- The use of repeaters or extension plugs in AS-i Power24V networks is not permitted.

### Benefits

AS-i Power24V networks incur no additional costs for an AS-Interface power supply unit because an already existing 24 V power supply unit can be used. This brings the user several benefits:

- The level of standardization of very small applications can be increased further.
- The additional advantages of a modern communication system in terms of commissioning, maintenance and diagnostics can be fully exploited.

### Application

#### Construction of an AS-i Power24V network

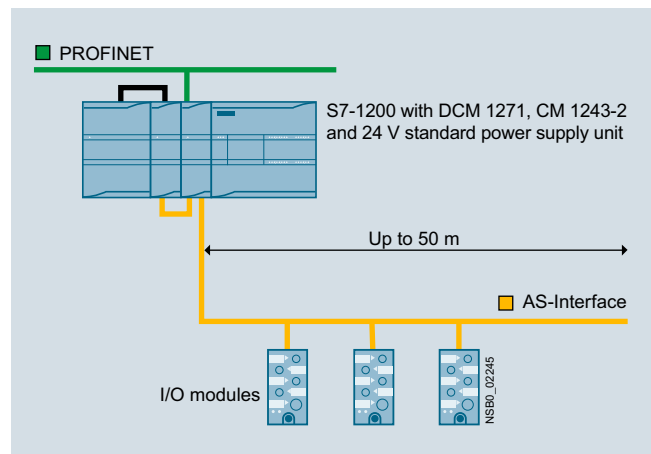

Construction of an AS-i Power24V network with an AS-Interface DCM 1271 data decoupling module and S7-1200 (simple network)

### More information

Complete overview of AS-i Power24V-capable devices currently available from Siemens see <http://support.automation.siemens.com/WW/view/en/42806066>.

## AS-Interface

### ASIsafe

#### Introduction

#### Overview

##### ASIsafe – Safety is included

ASIsafe enables the integration of safety-related components, such as EMERGENCY-STOP pushbuttons, protective door switches or safety light arrays, in an AS-Interface network. These are fully compatible with the familiar AS-Interface components (masters, slaves, power supplies, repeaters, etc.) in accordance with IEC 62026-2 and are operated in conjunction with them on the yellow AS-Interface cable.

##### Tested safety

The transmission method for safety-related signals is approved for implementing applications up to PL e according to EN ISO 13849-1 and up to SIL 3 according to IEC 62061/IEC 61508.

##### Higher-level control

Nodes on the AS-Interface bus are as usual controlled in operation by the standard program of the higher-level SIMATIC (F) CPU or by a SINUMERIK control.

##### AS-i safety solution with F-CPU

##### Configuring safety functions

In order to implement safe functions, the information from the safe and standard nodes must be combined logically and further parameters set. The configuration of the safety functions depends on which safety solution is being used:

- In the case of the AS-i safety solution with F-CPU: In conjunction with the SIMATIC AS-i F-Link as a safe AS-i master, all safety functions and logic operations are configured via STEP 7 and processed in the controller (F-CPU) by the fail-safe program.
- In the case of the AS-i safety solution with local evaluation by MSS: In conjunction with the Modular Safety System, all safety functions and logic operations are configured using the MSS ES software and processed in the MSS central unit.

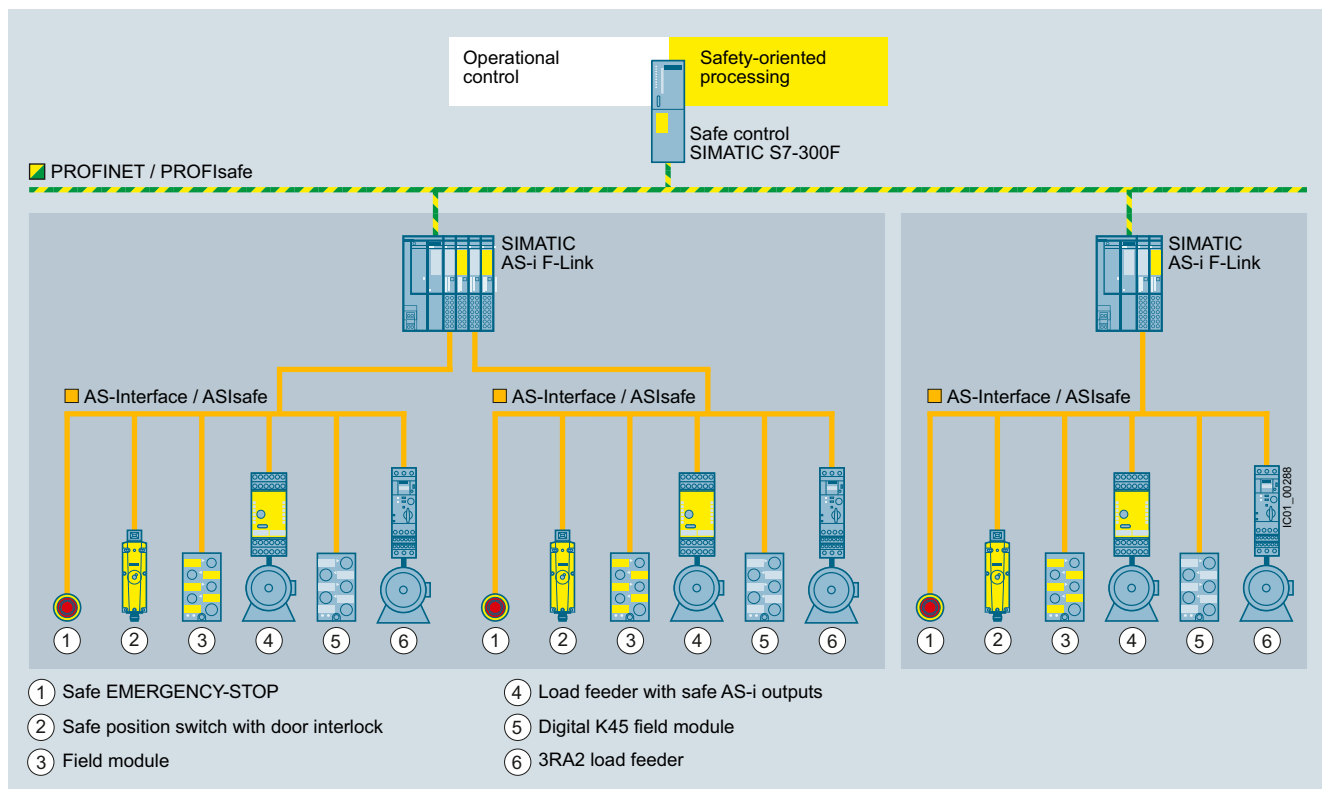

AS-Interface configuration with SIMATIC AS-i F-Link, consisting of an ET 200SP station with CM AS-i Master ST and F-CM AS-i Safety ST modules

The SIMATIC AS-i F-Link allows AS-Interface to be used with fail-safe SIMATIC or SINUMERIK controls.

The allocation of tasks is as follows:

- Acquisition of safety-related signals via safe input slaves on the AS-Interface bus. Further signals can be acquired via other SIMATIC F-DI modules.
- Evaluation and processing of signals via the fail-safe SIMATIC or SINUMERIK control
- Reaction by safe output modules on the AS-Interface bus or other SIMATIC F-DQ modules

The SIMATIC AS-i F-Link is implemented as a modular arrangement of ET 200SP components.

Simple combination of the CM AS-i Master ST and F-CM AS-i Safety ST modules in one ET 200SP station with PROFINET interfacing results in a powerful PN/AS-i F-Link, which can be expanded further in a modular fashion using ET 200SP I/O modules.

Using these design methods, it is possible to create configurations for virtually any application. Besides the single AS-i master, double, triple or generally multiple masters can be realized with or without fail-safe functionality.

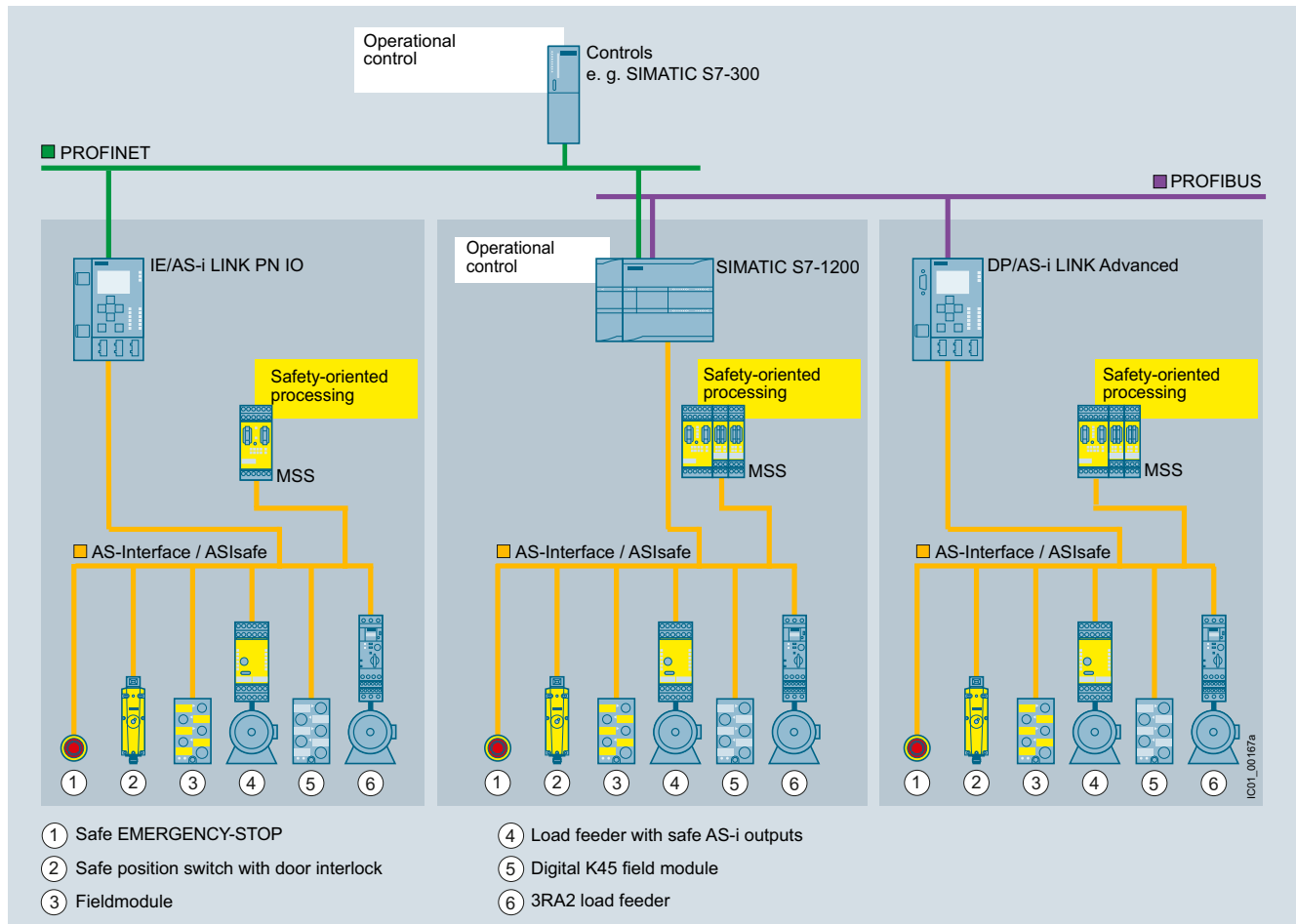
**Overview** (continued)**AS-i safety solution with local evaluation by MSS****AS-Interface design with 3RK3 Modular Safety System (MSS)**

The local AS-i safety solution utilizes the 3RK3 Modular Safety System (MSS) to process safety-related signals. Use of a standard controller (i.e. not an F-CPU) and a standard AS-i master is sufficient for this purpose.

The allocation of tasks is as follows:

- Acquisition of safety-related signals via safe input slaves on the AS-Interface bus. Further signals can be acquired via F-DI inputs of the central unit or the expansion modules of the MSS.

- Acquisition and processing of signals via the central unit of the MSS
- Reaction via safe output modules on the AS-Interface bus of via F-DQ outputs of the central unit or expansion modules of the MSS

**Benefits**

- Easy plant configuration thanks to standardized AS-Interface technology
- Safety-related and standard data on the same bus
- Existing systems can be expanded quickly and easily
- Optimum integration in TIA (Safety Diagnostics) and Safety Integrated
- Inclusion of the safety signals in the plant diagnostics, also on existing HMI panels
- Approved to PL e according to EN ISO 13849-1 or SIL 3 according to IEC 61508
- ASIsafe is certified by TÜV (Germany), NRTL (USA) and INRS (France)

**Application**

Integrated safety technology in the AS-Interface system is used wherever EMERGENCY-STOP pushbuttons, protective door in-

terlocks, safe position switches, light arrays and two-hand operator controls are installed.





**More information**

More information and circuit examples relevant to safety systems see <http://support.automation.siemens.com/WW/view/en/20208582>.

**AS-Interface**

ASIsafe

**AS-Interface safety monitors****Selection and ordering data**

	Version	Article No.
 3RK1105-1BE04-0CA0	<b>Basic safety monitor</b> Version 3 With screw terminals, removable terminals, width 45 mm <ul style="list-style-type: none"> <li>• One enabling circuit (monitor type 1)</li> <li>• Two enabling circuits (monitor type 2)</li> </ul>	<b>Screw terminals</b>   <b>3RK1105-1AE04-0CA0</b> <b>3RK1105-1BE04-0CA0</b>
	<b>Expanded safety monitors</b> Version 3 With screw terminals, removable terminals, width 45 mm <ul style="list-style-type: none"> <li>• One enabling circuit (monitor type 3)</li> <li>• Two enabling circuits (monitor type 4)</li> </ul>	 <b>3RK1105-1AE04-2CA0</b> <b>3RK1105-1BE04-2CA0</b>
	<b>Expanded safety monitors with integrated safe slave</b> Version 3 With screw terminals, removable terminals, width 45 mm <ul style="list-style-type: none"> <li>• Two enabling circuits including control of a safe AS-i output / safe coupling (monitor type 6)</li> </ul>	 <b>3RK1105-1BE04-4CA0</b>
	<b>Basic safety monitors</b> Version 3 With spring-type terminals, removable terminals, width 45 mm <ul style="list-style-type: none"> <li>• One enabling circuit (monitor type 1)</li> <li>• Two enabling circuits (monitor type 2)</li> </ul>	<b>Spring-type terminals</b>   <b>3RK1105-1AG04-0CA0</b> <b>3RK1105-1BG04-0CA0</b>
	<b>Expanded safety monitors</b> Version 3 With spring-type terminals, removable terminals, width 45 mm <ul style="list-style-type: none"> <li>• One enabling circuit (monitor type 3)</li> <li>• Two enabling circuits (monitor type 4)</li> </ul>	 <b>3RK1105-1AG04-2CA0</b> <b>3RK1105-1BG04-2CA0</b>
	<b>Expanded safety monitor with integrated safe slave</b> Version 3 With spring-type terminals, removable terminals, width 45 mm <ul style="list-style-type: none"> <li>• Two enabling circuits including control of a safe AS-i output / safe coupling (monitor type 6)</li> </ul>	 <b>3RK1105-1BG04-4CA0</b>
<b>Accessories</b>   3RK1901-5AA00	<b>ASIsafe CD</b> Included in the scope of supply: <ul style="list-style-type: none"> <li>• ASIMON V3 configuration software on CD ROM, for PC with the 32-bit operating systems Windows XP, Windows Vista Business/Ultimate, Windows 7</li> </ul>	<b>3RK1802-2FB06-0GA1</b>
	<b>Cable sets</b> Included in the scope of supply: <ul style="list-style-type: none"> <li>• PC configuration cable for communication between PC (serial interface) and safety monitor, length approx. 1.50 m</li> <li>• Transfer cable between two safety monitors, length approx. 0.25 m</li> </ul>	<b>3RK1901-5AA00</b>
	<b>Sealable covers</b> For securing against unauthorized configuration of the safety monitor	<b>3RP1902</b>
	<b>Push-in lugs</b> For screw fixing	<b>3RP1903</b>

## Overview

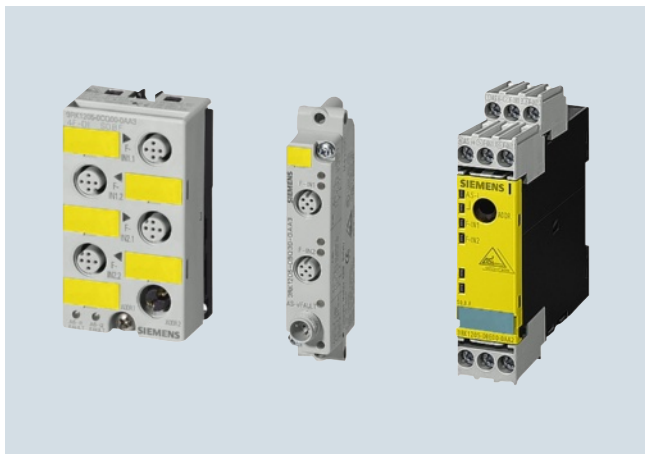

AS-Interface safety modules: K45F (left), K20F (center) and S22.5F (right)



S45F SlimLine module, safe AS-i output

Safety modules for AS-Interface (ASIsafe modules) are available for field use in degree of protection IP67 (K20F and K45F compact modules) and for the control cabinet (S22.5F SlimLine modules) in degree of protection IP20.

A very compact module with an optimum price/performance ratio is thus available for very application.

All modules for the connection of (mechanical) switches and safety sensors with contacts feature cross-circuit monitoring of the connected sensor line. On versions for the connection of solid-state switches and safety sensors (e.g. light arrays) the cross-circuit monitoring must be performed by the sensor.

The following modules are available for selection:

#### **K20F compact safety modules for use in the field**

Being only 20 mm wide, the K20F module is particularly well suited for applications where modules need to be arranged in the most confined space. The K20F modules are connected to the AS-Interface with a round cable with M12 cable box instead of with the AS-Interface flat cable. This enables extremely compact installation. The flexibility of the round cable means that it can also be used on moving machine parts without any problems. The K20 modules are also ideal for such applications as their non-encapsulated design makes them particularly light in weight.

#### **K45F compact safety modules for use in the field**

The platform of the K45F modules covers the following variations:

- Connection of ("mechanical") switches/safety sensors with contacts:
  - K45F 2F-DI: Two safety-related inputs in operation up to Category 2 according to EN ISO 13849-1. If Category 4 is required, a two-channel input is available on the module.
  - K45F 2F-DI/2DO: There are also two standard outputs in addition to the safe inputs. Supplied from the yellow AS-i cable
  - K45F 2F-DI/2DO  $U_{aux}$ : same as K45F 2F-DI/2DO, but supplied from the black 24 V DC cable
  - K45F 4F-DI: Four safety-related inputs in operation up to Category 2, two for Category 4. Extremely compact double slave (uses two full AS-i addresses).
- Connection of solid-state switches / safety sensors (non-contact protective devices, ESPE):
  - K45F LS (light sensor): Safe input module for the connection of electronic safety sensors with testing semiconductor outputs (OSSD)
 In particular non-contact protective devices such as active, optoelectronic light arrays and light arrays for Type 2 and Type 4 according to IEC 61496. Transmitters as well as receivers are supplied with power from the yellow AS-i cable. Matching sensor cables and optionally a separate transmitter supply module are available as accessories.

#### **S22.5F SlimLine safety modules for use in control cabinets and local control cabinets**

The S22.5F SlimLine safety module has two safety inputs. The safe connection of signals to ASIsafe networks in the cabinet is also possible therefore. For operation up to Category 2, both inputs can be separately assigned; if Category 4 is required, a two-channel input is available on the module.

In addition there are two S22.5F module versions which have two standard outputs in addition to the two safety inputs; power is supplied either from only the yellow AS-Interface cable or as auxiliary voltage from the black 24 V DC cable.

#### **S45F SlimLine safety modules with safe outputs for the safe distributed disconnection of actuators**

With the safe S45F SlimLine-Module, the shutdown signal, for example from the Modular Safety System, can be used through the ASIsafe for distributed safety-related disconnection.

To this end, the module has a dual-channel relay output with which an enabling circuit up to safety category 4 and Performance Level e according to EN ISO 13849-1 and SIL 3 according to EN 62061 / IEC 61508 can be deactivated safely.

As an additional possibility the module offers normal switching of the output using an AS-i standard output bit.

The module has three digital inputs and two digital outputs for the additional connection of sensors and actuators. These can be used, inter alia, for the necessary monitoring of downstream contactors of the feedback circuit.

**AS-Interface**

ASIsafe

**AS-Interface safety modules****Selection and ordering data**

Version		Article No.
<b>K20F compact safety modules</b>		
I/O type	$U_{aux}$ 24 V	
2 F-DI	--	<b>3RK1205-0BQ30-0AA3</b>
<b>K45F compact safety modules</b> Modules supplied without mounting plate		
I/O type	$U_{aux}$ 24 V	
2 F-DI	--	<b>3RK1205-0BQ00-0AA3</b>
4 F-DI <sup>1)</sup>	--	<b>3RK1205-0CQ00-0AA3</b>
2 F-DI / 2 DO	--	<b>3RK1405-0BQ20-0AA3</b>
2 F-DI / 2 DO	✓	<b>3RK1405-1BQ20-0AA3</b>
2 F-DI LS type 2 <sup>2)</sup>	--	<b>3RK1205-0BQ21-0AA3</b>
2 F-DI LS type 4 <sup>3)</sup>	--	<b>3RK1205-0BQ24-0AA3</b>
<b>S22.5F SlimLine safety modules</b>		
Connection	I/O type	$U_{aux}$ 24 V
Screw	⊕ 2 F-DI	--
	⊕ 2 F-DI / 2 DO	--
	⊕ 2 F-DI / 2 DO	✓
Spring-type	∞ 2 F-DI	--
	∞ 2 F-DI / 2 DO	--
	∞ 2 F-DI / 2 DO	✓
<b>S45F SlimLine safety module</b>		
Connection	I/O type	$U_{aux}$ 24 V
Screw	⊕ 1F-RO/3DI/2DO	✓
Spring-type	∞ 1F-RO/3DI/2DO	✓

3RK1205-0BQ30-0AA3

3RK1205-0BQ00-0AA3

3RK1205-0BE00-0AA2

3RK1405-1SE15-0AA2

✓ Available or possible

-- Not available or not possible





1) Module occupies two AS-Interface addresses

2) Connection of previous Siemens light curtain FS 400 3RG7843 (type 2) through socket 1/3.

3) Connection of previous Siemens light curtain FS 400 3RG7846 (type 4) through socket 1/3, other makes through socket 2/3.



**Accessories**

	Version	Article No.
 3RK1901-2EA00	<b>K45 mounting plates</b> For mounting K45F <ul style="list-style-type: none"> <li>• For wall mounting</li> <li>• For standard rail mounting</li> </ul>	<b>3RK1901-2EA00</b> <b>3RK1901-2DA00</b>
	<b>24 V supply modules for K45F LS (light sensor)</b> <ul style="list-style-type: none"> <li>• Optional, for transmitter power supply for large protective field widths</li> <li>• Max. current carrying capacity 200mA</li> <li>• Modules supplied without mounting plate</li> </ul>	<b>3RK1901-1NP00</b>
 3RK1901-1AA00	<b>Input bridges for K45F</b> <ul style="list-style-type: none"> <li>• Black version</li> <li>• Red version</li> </ul>	<b>3RK1901-1AA00</b> <b>3RK1901-1AA01</b>
 3RK1901-1KA00	<b>AS-Interface M12 sealing caps</b> For free M12 sockets	<b>3RK1901-1KA00</b>
 3RK1901-1KA01	<b>AS-Interface M12 sealing caps, tamper-proof</b> For free M12 sockets	<b>3RK1901-1KA01</b>

## AS-Interface

### ASIsafe

#### 3SF1 mechanical safety switches

##### Overview

The 3SF1 position switches with safety-related communication can be directly connected using the AS-Interface bus system. The safety functions no longer have to be conventionally wired up.

With the 3SF1 position switches the ASIsafe electronics component is integrated in the switch enclosure.



Examples of selection options in the modular system

##### Modular system

The position switches of the 3SF11.4 and 3SF12.4 series are designed as a modular system comprising different versions of the basic switch and an actuator which must be ordered separately. Thanks to the modular design of the switch the end users can select the right solution for their application from numerous versions and install it themselves in a very short time.

##### Design

The 3SF1 switches are available in four different enclosure sizes:

- Plastic and metal enclosures according to EN 50047, 31 mm wide, with M12 plug
- Metal enclosures according to EN 50041, 40 mm wide, with M12 plug
- Plastic enclosures, 50 mm wide, with M12 plug and M12 socket
- Metal enclosures, 56 mm wide, with M12 plug and M12 socket

##### Display

The switches have a status display with three LEDs:

- LED 1 (yellow): F-IN1
- LED 2 (yellow): F-IN2
- LED 3 (green/red): AS-i/FAULT

##### Connection

Connection to the AS-Interface is by means of a 4-pole M12 connector socket (plastic version) connected to the yellow AS-Interface bus cable.

The wide enclosures (50 or 56 mm) also have an M12 socket for connecting a second position switch. Category 4 according to EN 954-1 is thus achieved.

##### Benefits

The new generation of 3SF1 position switches offers:

- ASIsafe electronics component integrated in the enclosure, with low power consumption < 60 mA
- An extensive range of actuators
- Status display with three LEDs

##### Operating conditions

With the standard position switches, mechanical positions of moving machine parts are converted into electrical signals. Through their modular and uniform design and large number of variants, the devices can comply with practically all requirements in industry.

Devices are available with enclosure versions to suit the particular ambient conditions. Different control tasks can be performed with the best contact blocks suited for the particular purpose. And many different actuator variants are available to match the mechanical configuration of the moving machine parts. Dimensions, fixing points and characteristics are largely in accordance with the EN 50041 or EN 50047 standards.

The devices are suitable for use in any climate.

##### Standards

The switches comply with the standards IEC 60947-1 (Low-Voltage Switchgear and Controlgear, General) and IEC 60947-5-1 (Electromechanical Control Circuit Devices).

The mechanical design of the switches corresponds to the requirements of the fail-safe principle according to EN 1088.

##### Approvals

AS-Interface according to EN 50295 and IEC 62026-2.

With a 3SF1 position switch it is possible to achieve Category 2 according to ISO 13849-1 or SIL 1 according to IEC 61508.

Categories 3 or 4 according to ISO 13849-1 or SIL 2 or 3 according to IEC 61508 can be achieved by using a second 3SE5 position switch.

The 3SF1 position switches are approved according to UL 508, UL 50 and UL 746-C.

##### Manuals

More information see configuration manual "SIRIUS 3SE5 / 3SF1 Position Switches"

<http://support.automation.siemens.com/WW/view/en/43920150>

**Selection and ordering data**
**Modular system**

For the ASIsafe version of the position switch, the basic switch and actuator must be ordered separately.

1 or 2 contacts · 3 LEDs · Degree of protection IP65 (31 mm) or IP66/IP67 (50 mm) · M12 connector socket

Version	Contacts	LEDs	Article No.	
<b>Basic switches (with rounded plunger<sup>1)</sup>) · Enclosure width 31 mm acc. to EN 50047</b>				
	<b>With Teflon plunger,</b> with M12 connector socket, 4-pole channel 1 on NC contact, channel 2 on NC contact			
	<ul style="list-style-type: none"> <li>• Slow-action contacts</li> </ul>	2 NC	24 V DC	➔ <b>3SF1234-1KC05-1BA1</b>
	<ul style="list-style-type: none"> <li>• Snap-action contacts</li> </ul>	2 NC	24 V DC	➔ <b>3SF1234-1LC05-1BA1</b>

ASIsafe basic switch

**Basic switches (with rounded plunger<sup>1)</sup>) · Enclosure width 50 mm**

	<b>With Teflon plunger,</b> with M12 connector socket, 4-pole channel 1 on NC contact, channel 2 on M12 socket, right			
	<ul style="list-style-type: none"> <li>• Slow-action contacts</li> </ul>	1 NC	24 V DC	➔ <b>3SF1244-1KC05-1BA2</b>
	<ul style="list-style-type: none"> <li>• Snap-action contacts</li> </ul>	1 NC	24 V DC	➔ <b>3SF1244-1LC05-1BA2</b>

ASIsafe basic switch

⚙ For online configurator see [www.siemens.com/sirius/configurators](http://www.siemens.com/sirius/configurators).

➔ Positive opening according to IEC 60947-5-1, Appendix K, or positively driven actuator for use in safety circuits.







<sup>1)</sup> For enclosures with widths of 31 mm and 50 mm, the basic switch is a complete unit with rounded plungers.

**AS-Interface**

ASIsafe

3SF1 mechanical safety switches

**Plastic enclosures****Selection and ordering data** (continued)

	Version	Diameter mm	Article No.
<b>Operating mechanisms</b>			
 Roller plunger	<b>Roller plungers, type C acc. to EN 50047</b>		
	• Plastic roller	10	➔ 3SE5000-0AD03
	• High-grade steel roller	10	➔ 3SE5000-0AD04
 With central fixing	<b>Roller plungers with central fixing</b>		
	• Plastic roller	10	➔ 3SE5000-0AD10
	• High-grade steel roller	10	➔ 3SE5000-0AD11
 Roller lever	<b>Roller levers, type E acc. to EN 50047</b>		
	• Metal lever, plastic roller	13	➔ 3SE5000-0AE10
	• Metal lever, high-grade steel roller	13	➔ 3SE5000-0AE11
	• High-grade steel lever, plastic roller	13	➔ 3SE5000-0AE12
	• High-grade steel lever, high-grade steel roller	13	➔ 3SE5000-0AE13
 Angular roller lever	<b>Angular roller levers</b>		
	• Metal lever, plastic roller	13	➔ 3SE5000-0AF10
	• Metal lever, high-grade steel roller	13	➔ 3SE5000-0AF11
	• High-grade steel lever, plastic roller	13	➔ 3SE5000-0AF12
	• High-grade steel lever, high-grade steel roller	13	➔ 3SE5000-0AF13
<b>Twist actuators with lever</b>			
 Twist actuator	<b>Twist actuators, plastic (without lever)</b>		
	Switching right or left, adjustable		➔ 3SE5000-0AK00
 Twist lever	<b>Lever for twist actuators</b>		
	<b>Twist levers, type A acc. to EN 50047</b>		
	• Metal lever, plastic roller	19	➔ 3SE5000-0AA21
	• Metal lever, high-grade steel roller	19	➔ 3SE5000-0AA22
	• Metal lever, roller with ball bearing	19	➔ 3SE5000-0AA23
	• Metal lever, plastic roller	30	➔ 3SE5000-0AA25
	• High-grade steel lever, plastic roller	19	➔ 3SE5000-0AA31
	• High-grade steel lever, high-grade steel roller	19	➔ 3SE5000-0AA32
	<b>Twist levers, length 30 mm, straight<sup>1)</sup></b>		
• Metal lever, plastic roller	19	➔ 3SE5000-0AA24	
• Metal lever, plastic roller	30	➔ 3SE5000-0AA26	
 Twist lever, adjustable length	<b>Twist levers, adjustable length, with grid hole</b>		
	• Metal lever, plastic roller	19	➔ 3SE5000-0AA60
	• Metal lever, high-grade steel roller	19	➔ 3SE5000-0AA61
	• Metal lever, plastic roller	50	➔ 3SE5000-0AA67
	• Metal lever, rubber roller	50	➔ 3SE5000-0AA68
	• High-grade steel lever, plastic roller	19	➔ 3SE5000-0AA62
	• High-grade steel lever, high-grade steel roller	19	➔ 3SE5000-0AA63

➔ Positively driven actuator, for use in safety circuits.



<sup>1)</sup> Can be clinch mounted (turned through 180°, rear of lever).

## Selection and ordering data

### Modular system

For the ASIsafe version of the position switch, the basic switch and actuator must be ordered separately.

2 contacts · 3 LEDs · Degree of protection IP66/IP67 · M12 connector socket

Version	Contacts	LEDs	Article No.	
<b>Basic switches (with rounded plunger<sup>1)</sup>) · Enclosure width 31 mm acc. to EN 50047</b>				
 <p>ASIsafe basic switch</p>	<b>With Teflon plunger,</b> with M12 connector socket, 4-pole channel 1 on NC contact, channel 2 on NC contact			
	<ul style="list-style-type: none"> <li>• Slow-action contacts</li> </ul>	2 NC	24 V DC	 <b>3SF1214-1KC05-1BA1</b>
	<ul style="list-style-type: none"> <li>• Snap-action contacts</li> </ul>	2 NC	24 V DC	 <b>3SF1214-1LC05-1BA1</b>

For online configurator see [www.siemens.com/sirius/configurators](http://www.siemens.com/sirius/configurators).

 Positive opening according to IEC 60947-5-1, Appendix K, or positively driven actuator for use in safety circuits.





































<sup>1)</sup> For enclosures with widths of 31 mm, the basic switch is a complete unit with rounded plungers.

**AS-Interface**

ASIsafe

3SF1 mechanical safety switches

**Metal enclosures****Selection and ordering data** (continued)

Version	Diameter	Article No.
	mm	
<b>Operating mechanisms</b>		
 Plain plungers	<b>Plain plungers</b> • High-grade steel plungers	10  <b>3SE5000-0AB01</b>
 Roller plunger	<b>Roller plungers, type C acc. to EN 50047</b> • Plastic roller • High-grade steel roller	10  <b>3SE5000-0AD03</b> 10  <b>3SE5000-0AD04</b>
 With central fixing	<b>Roller plunger with central fixing</b> • Plastic roller • High-grade steel roller	10  <b>3SE5000-0AD10</b> 10  <b>3SE5000-0AD11</b>
 Roller lever	<b>Roller levers, type E acc. to EN 50047</b> • Metal lever, plastic roller • Metal lever, high-grade steel roller • High-grade steel lever, plastic roller • High-grade steel lever, high-grade steel roller	13  <b>3SE5000-0AE10</b> 13  <b>3SE5000-0AE11</b> 13  <b>3SE5000-0AE12</b> 13  <b>3SE5000-0AE13</b>
 Angular roller lever	<b>Angular roller levers</b> • Metal lever, plastic roller • Metal lever, high-grade steel roller • High-grade steel lever, plastic roller • High-grade steel lever, high-grade steel roller	13  <b>3SE5000-0AF10</b> 13  <b>3SE5000-0AF11</b> 13  <b>3SE5000-0AF12</b> 13  <b>3SE5000-0AF13</b>
<b>Twist actuators with lever</b>		
 Twist actuator	<b>Twist actuators,</b> plastic (without lever) Switching right or left, adjustable	 <b>3SE5000-0AK00</b>
 Twist lever	<b>Lever for twist actuators</b> <b>Twist levers, type A acc. to EN 50047</b> • Metal lever, plastic roller • Metal lever, high-grade steel roller • Metal lever, roller with ball bearing • Metal lever, plastic roller • High-grade steel lever, plastic roller • High-grade steel lever, high-grade steel roller	19  <b>3SE5000-0AA21</b> 19  <b>3SE5000-0AA22</b> 19  <b>3SE5000-0AA23</b> 30  <b>3SE5000-0AA25</b> 19  <b>3SE5000-0AA31</b> 19  <b>3SE5000-0AA32</b>
	<b>Twist levers, length 30 mm, straight<sup>1)</sup></b> • Metal lever, plastic roller • Metal lever, plastic roller	19  <b>3SE5000-0AA24</b> 30  <b>3SE5000-0AA26</b>
 Twist lever, adjustable length	<b>Twist levers, adjustable length, with grid hole</b> • Metal lever, plastic roller • Metal lever, high-grade steel roller • Metal lever, plastic roller • Metal lever, rubber roller • High-grade steel lever, plastic roller • High-grade steel lever, high-grade steel roller	19  <b>3SE5000-0AA60</b> 19  <b>3SE5000-0AA61</b> 50  <b>3SE5000-0AA67</b> 50  <b>3SE5000-0AA68</b> 19  <b>3SE5000-0AA62</b> 19  <b>3SE5000-0AA63</b>

 Positively driven actuator, for use in safety circuits.

<sup>1)</sup> Can be clinch mounted (turned through 180°, rear of lever).

**Selection and ordering data** (continued)

**Modular system**

For the ASIsafe version of the position switch, the basic switch and actuator must be ordered separately.

1 or 2 contacts · 3 LEDs · Degree of protection IP66/IP67 · M12 connector socket





Version	Contacts	LED	Article No.
<b>Basic switches - Enclosure width 40 mm acc. to EN 50041</b>			
 ASIsafe basic switch	With M12 connector socket, 4-pole, channel 1 on NC contact, channel 2 on NC contact		
	<ul style="list-style-type: none"> <li>• Slow-action contacts</li> <li>• Snap-action contacts</li> </ul>	2 NC	24 V DC

**Basic switches - Enclosure width 56 mm**

 ASIsafe basic switch	With M12 connector socket, 4-pole, channel 1 on NC contact, channel 2 on M12 socket, right		
	<ul style="list-style-type: none"> <li>• Slow-action contacts</li> <li>• Snap-action contacts</li> </ul>	1 NC	24 V DC

⚙ For online configurator see [www.siemens.com/sirius/configurators](http://www.siemens.com/sirius/configurators).

⤴ Positive opening according to IEC 60947-5-1, Appendix K, or positively driven actuator for use in safety circuits.

Version	Diameter mm	Article No.
<b>Operating mechanisms</b>		
 Plain plunger	<b>Plain plungers</b>	
	High-grade steel plungers	⤴ <b>3SE5000-0AB01</b>
 Rounded plunger	<b>Rounded plungers, type B, acc. to EN 50041</b>	
	High-grade steel plungers	⤴ <b>3SE5000-0AC02</b>
 Roller plunger	<b>Roller plungers, type C acc. to EN 50041</b>	
	High-grade steel rollers	13 ⤴ <b>3SE5000-0AD02</b>
 Roller lever	<b>Roller levers</b>	
	• Metal lever, plastic roller	22 ⤴ <b>3SE5000-0AE01</b>
	• Metal lever, high-grade steel roller	22 ⤴ <b>3SE5000-0AE02</b>
	• High-grade steel lever, plastic roller	22 ⤴ <b>3SE5000-0AE03</b>
	• High-grade steel lever, high-grade steel roller	22+ ⤴ <b>3SE5000-0AE04</b>
 Angular roller lever	<b>Angular roller levers</b>	
	• Metal lever, plastic roller	22 ⤴ <b>3SE5000-0AF01</b>
	• Metal lever, high-grade steel roller	22 ⤴ <b>3SE5000-0AF02</b>
	• High-grade steel lever, plastic roller	22 ⤴ <b>3SE5000-0AF03</b>
	• High-grade steel lever, high-grade steel roller	22 ⤴ <b>3SE5000-0AF04</b>

⤴ Positively driven actuator, for use in safety circuits.





## AS-Interface

ASIsafe

3SF1 mechanical safety switches

### Metal enclosures

#### Selection and ordering data (continued)

Version	Diameter mm	Article No.	
<b>Twist actuators with lever</b>			
 Twist actuator	<b>Twist actuators</b> , metal (without lever) <ul style="list-style-type: none"> <li>Switching right or left, adjustable</li> <li>For fork levers, latching</li> </ul>	↻ <b>3SE5000-0AH00</b> ↻ <b>3SE5000-0AT10</b>	
	<b>Lever for twist actuators</b> <b>Twist levers 27 mm, type A, according to EN 50041</b> <ul style="list-style-type: none"> <li>Metal lever, plastic roller 19</li> <li>Metal lever, high-grade steel roller 19</li> <li>Metal lever, roller with ball bearing 19</li> <li>Metal lever, 2 plastic rollers 19</li> <li>Metal lever, plastic roller 30</li> <li>Metal lever, plastic roller 50</li> <li>Metal lever, rubber roller 50</li> <li>High-grade steel lever, plastic roller 19</li> <li>High-grade steel lever, high-grade steel roller 19</li> </ul>		↻ <b>3SE5000-0AA01</b> ↻ <b>3SE5000-0AA02</b> ↻ <b>3SE5000-0AA03</b> ↻ <b>3SE5000-0AA04</b> ↻ <b>3SE5000-0AA05</b> ↻ <b>3SE5000-0AA07</b> ↻ <b>3SE5000-0AA08</b> ↻ <b>3SE5000-0AA11</b> ↻ <b>3SE5000-0AA12</b>
 Twist lever	<b>Twist levers, length 35 mm, offset</b> <ul style="list-style-type: none"> <li>Metal lever, plastic roller 19</li> <li>High-grade steel lever, plastic roller 19</li> </ul>		↻ <b>3SE5000-0AA15</b> ↻ <b>3SE5000-0AA16</b>
	<b>Twist levers, length 30 mm, straight<sup>1)</sup></b> <ul style="list-style-type: none"> <li>Metal lever, plastic roller 19</li> <li>Metal lever, plastic roller 30</li> </ul>		↻ <b>3SE5000-0AA24</b> ↻ <b>3SE5000-0AA26</b>
 Twist lever, adjustable length	<b>Twist levers, adjustable length, with grid hole</b> <ul style="list-style-type: none"> <li>Metal lever, plastic roller 19</li> <li>Metal lever, high-grade steel roller 19</li> <li>Metal lever, plastic roller 50</li> <li>Metal lever, rubber roller 50</li> <li>High-grade steel lever, plastic roller 19</li> <li>High-grade steel lever, high-grade steel roller 19</li> </ul>		↻ <b>3SE5000-0AA60</b> ↻ <b>3SE5000-0AA61</b> ↻ <b>3SE5000-0AA67</b> ↻ <b>3SE5000-0AA68</b> ↻ <b>3SE5000-0AA62</b> ↻ <b>3SE5000-0AA63</b>
	<b>Fork levers</b> (for switches with snap-action contacts only) <ul style="list-style-type: none"> <li>2 metal levers, 2 plastic rollers 19</li> <li>2 metal levers, 2 high-grade steel rollers 19</li> <li>2 high-grade steel levers, 2 plastic rollers 19</li> <li>2 high-grade steel levers, 2 high-grade steel rollers 19</li> </ul>		↻ <b>3SE5000-0AT01</b> ↻ <b>3SE5000-0AT02</b> ↻ <b>3SE5000-0AT03</b> ↻ <b>3SE5000-0AT04</b>
 Fork lever			

↻ Positively driven actuator, for use in safety circuits.

<sup>1)</sup> Can be clinch mounted (turned through 180°, rear of lever).



**Overview**

The 3SF1 safety switches with safety-related communication can be directly connected using the AS-Interface bus system. The safety functions no longer have to be conventionally wired up.

With the 3SF1 safety switches the ASIsafe electronics component is integrated in the switch enclosure.



3SF1 safety switches head with separate actuator and with integrated ASIsafe electronics

The 3SF1 safety switches with separate actuator have the same enclosure as standard switches.

**Operation**

The actuator head is included in the scope of supply. For actuation from four directions it can be adjusted through  $4 \times 90^\circ$ . The switches can also be approached from above.

The actuator is not included in the scope of supply of the safety switch and must be ordered separately. There are six variants to choose from, depending on the application.

The actuator is encoded. Simple overruling by hand or auxiliary devices is impossible.

A high-grade steel blocking insert for attaching up to eight padlocks is available for even more safety.

A rubber cap to protect the actuator entry of the actuator head from contamination is available for operation of the enclosures in dusty environments.

**Display**

The switches have a status display with three LEDs:

- LED 1 (yellow): F-IN1
- LED 2 (yellow): F-IN2
- LED 3 (green/red): AS-i/FAULT

**Connection**

Connection to the AS-Interface is by means of a 4-pole M12 connector socket (plastic version) connected to the yellow AS-Interface bus cable.

The wide enclosures (50 or 56 mm) also have an M12 socket for connecting a second safety switch. Category 4 according to ISO 13849-1 is thus achieved.

**Benefits**

The new generation of 3SF1 safety switches with separate actuator offers

- ASIsafe electronics component integrated in the enclosure, with low power consumption  $< 60 \text{ mA}$
- An extensive range of actuators
- Status display with three LEDs

**Operating conditions**

Safety switches with separate actuator are used where the position of doors, covers or protective grilles must be monitored for safety reasons.

The safety switch can only be operated with the matching coded actuator. Simple overruling by hand or auxiliary devices is impossible.

Devices are available with enclosure versions to suit the particular ambient conditions. Different control tasks can be performed with the best contact blocks suited for the particular purpose. Dimensions and fixing points of the enclosure are in accordance with EN 50041 or EN 50047 standards.

The devices are suitable for use in any climate.

**Standards**

The switches comply with the standards IEC 60947-1 (Low-Voltage Switchgear and Controlgear, General) and IEC 60947-5-1 (Electromechanical Control Circuit Devices).

The mechanical design of the switches corresponds to the requirements of the fail-safe principle according to EN 1088.

**Approvals**

AS-Interface according to EN 50295 and IEC 62026-2.

With a 3SF1 safety switch it is possible to achieve Category 3 according to ISO 13849-1 or SIL 2 according to IEC 61508.

Category 4 according to ISO 13849-1 or SIL 3 according to IEC 61508 can be achieved by using an additional 3SE5 safety switch.

The 3SF1 safety switches are approved according to UL 508, UL 50 and UL 746-C.

## AS-Interface

ASIsafe



3SF1 mechanical safety switches with separate actuator

### Plastic enclosures

#### Overview

- Contacts: 1 or 2 slow-action contacts
- Status display with 3 LEDs 24 V DC;  
1: F-IN1, 2: F-IN2, 3: AS-I/FAULT
- Degree of protection IP65 (31 mm) or IP66/IP67 (50 mm)

#### Selection and ordering data

	Version <sup>1)</sup>	Contacts	Article No.
<b>Enclosure width 31 mm acc. to EN 50047</b>			
	<b>5 directions of approach</b> M12 connector socket, 4-pole, channel 1 on NC contact, channel 2 on NC contact  Slow-action contacts	2 NC	➔ <b>3SF1234-1QV40-1BA1</b>
<b>Enclosure width 50 mm</b>			
	<b>5 directions of approach</b> M12 connector socket, 4-pole, channel 1 on NC contact, channel 2 on M12 socket, right  Slow-action contacts	1 NC	➔ <b>3SF1244-1QV40-1BA2</b>

ASIsafe

ASIsafe

⚙ For online configurator see [www.siemens.com/sirius/configurators](http://www.siemens.com/sirius/configurators).



➔ Positive opening according to IEC 60947-5-1, Appendix K.

<sup>1)</sup> Supplied without actuator. Please order separately.

**Overview**

- Contacts: 1 or 2 slow-action contacts
- Status display with 3 LEDs 24 V DC;  
1: F-IN1, 2: F-IN2, 3: AS-I/FAULT
- Degree of protection IP66/IP67

**Selection and ordering data**

	Version <sup>1)</sup>	Contacts	Article No.
<b>Enclosure width 31 mm acc. to EN 50047</b>			
	<b>5 directions of approach</b> M12 connector socket, 4-pole, channel 1 on NC contact, channel 2 on NC contact  Slow-action contacts	2 NC	➔ <b>3SF1214-1QV40-1BA1</b>
<b>Enclosure width 40 mm acc. to EN 50041</b>			
	<b>5 directions of approach</b> M12 connector socket, 4-pole, channel 1 on NC contact, channel 2 on NC contact  Slow-action contacts	2 NC	➔ <b>3SF1114-1QV10-1BA1</b>
<b>Enclosure width 56 mm</b>			
	<b>5 directions of approach</b> M12 connector socket, 4-pole, channel 1 on NC contact, channel 2 on M12 socket, right  Slow-action contacts	1 NC	➔ <b>3SF1124-1QV10-1BA2</b>

ASIsafe

ASIsafe

ASIsafe

⚙ For online configurator see [www.siemens.com/sirius/configurators](http://www.siemens.com/sirius/configurators).

➔ Positive opening according to IEC 60947-5-1, Appendix K.

<sup>1)</sup> Supplied without actuator. Please order separately.

**AS-Interface**

ASIsafe

3SF1 mechanical safety switches with separate actuator

**Accessories****Selection and ordering data**

	Version	Article No.
<b>Actuators</b>		
	<b>Standard actuators</b> Standard actuators, length 75.6 mm	<b>3SE5000-0AV01</b>
	With vertical fixing, length 53 mm	<b>3SE5000-0AV02</b>
	With transverse fixing, length 47 mm	<b>3SE5000-0AV03</b>
	With transverse fixing, plastic <sup>1)</sup> length 47 mm	<b>3SE5000-0AW11</b>
	<b>Radius actuators</b> Direction of approach from left, length 40 mm	<b>3SE5000-0AV04</b>
	Direction of approach from right, length 44.5 mm	<b>3SE5000-0AV06</b>
	Universal radius actuators, length 69 mm	
	<ul style="list-style-type: none"> <li>• Length 77 mm</li> </ul>	<b>3SE5000-0AV05</b>
	<ul style="list-style-type: none"> <li>• Length 77 mm, tab rotated 90°</li> </ul>	<b>3SE5000-0AV05-1AA6</b>
	Universal radius actuators, heavy duty	
<ul style="list-style-type: none"> <li>• Length 67 mm</li> </ul>	<b>3SE5000-0AV07-1AK2</b>	
<ul style="list-style-type: none"> <li>• Length 77 mm</li> </ul>	<b>3SE5000-0AV07</b>	
<b>Optional accessories</b>		
	<b>Protective caps</b> made of black rubber for the actuator head, to protect the actuator openings from contamination (only for enclosure width 40 or 56 mm)	<b>SE5 000-0AV08-1AA2</b>
	<b>Blocking inserts</b> , high-grade steel, for actuator head, for up to 8 padlocks	<b>3SE5000-0AV08-1AA3</b>

Actuator can be used in safety circuits.

<sup>1)</sup> Not suitable for safety switches with interlocking.

## Overview

The 3SF1 safety switches with safety-related communication can be directly connected using the AS-Interface bus system. The safety functions no longer have to be conventionally wired up.

With the 3SF1 safety switches the ASIsafe electronics component is integrated in the switch enclosure.



3SF1 safety switch with solenoid interlocking and with integrated ASIsafe electronics

## Operation

The actuator head is included in the scope of supply. For actuation from four directions it can be adjusted through  $4 \times 90^\circ$ . The switches can also be approached from above.

The actuator is not included in the scope of supply of the safety switch and must be ordered separately. There are eight variants to choose from, depending on the application.

The actuator is encoded. Simple overruling by hand or auxiliary devices is impossible.

A high-grade steel blocking insert for attaching up to eight padlocks is available for even more safety.

A rubber cap to protect the actuator entry of the actuator head from contamination is available for operation of the enclosures in dusty environments.

## Solenoid interlocking

There are two versions for interlocking the actuator:

- Spring-actuated lock (closed-circuit principle) with various release mechanisms
- Solenoid-locked (open-circuit principle)

## Display

The switches have a status display with four LEDs:

- LED 1 (green): AS-i
- LED 2 (red): FAULT
- LED 3 (yellow): F-IN1
- LED 4 (yellow): F-IN2

## Connection

Connection to the AS-Interface is by means of a 4-pole M12 connector socket (plastic version) connected to the yellow AS-Interface bus cable (no additional supply of auxiliary power is required thanks to the low current consumption of the solenoid of max. 170 mA).

## Benefits

The new generation of 3SF13 safety switches with solenoid interlocking offers:

- More safety through higher locking forces:
  - 1300 N for the plastic version
  - 2600 N for the metal version
- Various release mechanisms:
  - Lock release, escape release and emergency release
- ASIsafe electronics integrated in the enclosure; connected through 4-pole M12 connector
- Current consumption of the solenoid maximum 170 mA
- Two contact blocks as standard equipment, hence fewer versions needed
- Same dimensions for all enclosure versions:
  - Plastic, metal
- An extensive range of actuators
- Status display with four LEDs

## Operating conditions

The safety switches with solenoid interlocking are exceptional safety-related devices which prevent an unforeseen or intentional opening of protective doors, protective grilles or other covers as long as a dangerous situation is present (i.e. follow-on motion of the switched-off machine).

The safety switches with solenoid interlocking have the following functions:

- Enabling the machine or process with closed and locked protective device
- Locking the machine or process with opened protective device
- Position monitoring of the protective device and solenoid interlocking

## Standards

The switches comply with the standards IEC 60947-1 (Low-Voltage Switchgear and Controlgear, General) and IEC 60947-5-1 (Electromechanical Control Circuit Devices).

The mechanical design of the switches corresponds to the requirements of the fail-safe principle according to EN 1088.

## Approvals

AS-Interface according to EN 50295 and IEC 62026-2.

The switches are approved for use with locking devices according to EN 1088 and EN 292, Parts 1 and 2.

3SF53 safety switches with solenoid interlocking have a VDE test mark.

With a 3SF13 safety switch it is possible to achieve Category 3 according to ISO 13849-1 or SIL 2 according to IEC 61508.

Category 4 according to ISO 13849-1 (EN 954-1) or SIL 3 according to IEC 61508 can be achieved by using an additional 3SE5 safety switch.

The 3SF1 safety switches are approved according to UL 508, UL 50 and UL 746-C.

## AS-Interface

ASIsafe

3SF1 mechanical safety switches with solenoid interlocking

### Plastic housings

#### Overview

##### 5 directions of approach · Degree of protection IP66/IP67

- Slow-action contacts:
  - Version -1BA1: ASIsafe channel 1 on 1 NC contact from the actuator and channel 2 on 1 NC contact from the solenoid
  - Version -1BA3: ASIsafe channel 1 on the first NC contact from the actuator and channel 2 on the second NC contact from the actuator
  - Version -1BA4: ASIsafe channel 1 on 2 NC contacts from the actuator and channel 2 on 1 NC contact from the solenoid. A discrepancy between the two contacts of the actuator will be evaluated already in the switch.
- Solenoid: Rated operational voltage 24 V DC
- 1 300 N locking force
- Status display with 4 LEDs 24 V DC;
  - 1: AS-i, 2: FAULT, 3: F-IN1, 4: F-IN2

##### Safety level

The new 3SF1324-1S.21-1BA4 safety switches are also recommended where there are several protective door interlocking devices where reliable diagnostics and quick restart capability of equipment is required.



- A response is received from the solenoid.
- No opening of the doors after the solenoid is unlocked.

SIL 2 according to IEC 61508 or PL d according to ISO 13849-1 can be achieved with the AS-i safety monitor or in the DP/AS-i F-Link.

#### Comparison of versions

Version	Contacts Actuator / solenoid	Achievable safety level	Diagnostics Solenoid feedback	Reclosing condition after unlocking the solenoid (depending on the type of evaluation)
3SF1324-1S.21-1BA1	1 NC / 1 NC	SIL 1 / PL c	✓	Door does <u>not</u> have to be opened
	1 NC / 1 NC	SIL 2 / PL d	✓	Door has to be opened
3SF1324-1S.21-1BA3	2 NC	SIL 2 / PL d	--	Door does <u>not</u> have to be opened
3SF1324-1S.21-1BA4	2 NC / 1 NC	SIL 2 / PL d	✓	Door does <u>not</u> have to be opened

#### Selection and ordering data

Interlock <sup>1)</sup>	Contacts Actuator / solenoid	Article No.
<b>1300 N locking force · Enclosure width 54 mm</b>		
 3SF1324-1SD21-...	<b>Spring-actuated locks</b> <ul style="list-style-type: none"> <li>• With auxiliary release</li> </ul>	1 NC / 1 NC → <b>3SF1324-1SD21-1BA1</b>
	<ul style="list-style-type: none"> <li>• With auxiliary release</li> </ul>	2 NC / – → <b>3SF1324-1SD21-1BA3</b>
	<ul style="list-style-type: none"> <li>• With auxiliary release</li> </ul>	2 NC / 1 NC → <b>3SF1324-1SD21-1BA4</b>
	<ul style="list-style-type: none"> <li>• With auxiliary release with lock</li> </ul>	1 NC / 1 NC → <b>3SF1324-1SE21-1BA1</b>
 3SF1324-1SF21-...	<ul style="list-style-type: none"> <li>• With escape release from the front</li> </ul>	1 NC / 1 NC → <b>3SF1324-1SF21-1BA1</b>
	<ul style="list-style-type: none"> <li>• With escape release from the front</li> </ul>	2 NC / 1 NC → <b>3SF1324-1SF21-1BA4</b>
	<ul style="list-style-type: none"> <li>• With escape release from the back and auxiliary release from the front</li> </ul>	1 NC / 1 NC → <b>3SF1324-1SG21-1BA1</b>
	<ul style="list-style-type: none"> <li>• With escape release from the back and auxiliary release from the front</li> </ul>	1 NC / 1 NC → <b>3SF1324-1SG21-1BA4</b>
 3SF1324-1SB21-...	<ul style="list-style-type: none"> <li>• With emergency release from the back and auxiliary release from the front</li> </ul>	1 NC / 1 NC → <b>3SF1324-1SJ21-1BA1</b>
	<b>Solenoid locks</b>	1 NC / 1 NC → <b>3SF1324-1SB21-1BA1</b>
		2 NC / – → <b>3SF1324-1SB21-1BA3</b>

⚙ For online configurator see [www.siemens.com/sirius/configurators](http://www.siemens.com/sirius/configurators).

➡ Positive opening according to IEC 60947-5-1, Appendix K.

<sup>1)</sup> Supplied without actuator. Please order separately.

#### Note:

For actuators and optional accessories see page 4/22.



**Overview****5 directions of approach · Degree of protection IP66/IP67**

- Slow-action contacts:  
Version -1BA1: ASIsafe channel 1 on 1 NC contact from the actuator and channel 2 on 1 NC contact from the solenoid
- Solenoid: Rated operational voltage 24 V DC
- 2 600 N locking force
- Status display with 4 LEDs 24 V DC;  
1: AS-i, 2: FAULT, 3: F-IN1, 4: F-IN2

**Safety level**

Version	Contacts Actuator / solenoid	Achievable safety level	Diagnostics Solenoid feedback	Reclosing condition after unlocking the solenoid (depending on the type of evaluation)
3SF1314-1S.21-1BA1	1 NC / 1 NC	SIL 1 / PL c	✓	Door does <u>not</u> have to be opened
	1 NC / 1 NC	SIL 2 / PL d	✓	Door has to be opened

**Selection and ordering data**

Interlock <sup>1)</sup>	Contacts Actuator / solenoid	Article No.
<b>2600 N locking force · Enclosure width 54 mm</b>		
 3SF1314-1SD21-...	<b>Spring-actuated locks</b>	
	• With auxiliary release	1 NC / 1 NC → <b>3SF1314-1SD11-1BA1</b>
	• With auxiliary release with lock	1 NC / 1 NC → <b>3SF1314-1SE11-1BA1</b>
	• With escape release from the front	1 NC / 1 NC → <b>3SF1314-1SF11-1BA1</b>
	• With escape release from the back and auxiliary release from the front	1 NC / 1 NC → <b>3SF1314-1SG11-1BA1</b>
• With emergency release from the back and auxiliary release from the front	1 NC / 1 NC → <b>3SF1314-1SJ11-1BA1</b>	
 3SF1314-1SF21-...		
 3SF1314-1BF21-...		
	<b>Solenoid locks</b>	1 NC / 1 NC → <b>3SF1314-1SB11-1BA1</b>

⚙ For online configurator see [www.siemens.com/sirius/configurators](http://www.siemens.com/sirius/configurators).

➡ Positive opening according to IEC 60947-5-1, Appendix K.

<sup>1)</sup> Supplied without actuator. Please order separately.

**Note:**

For actuators and optional accessories see page 4/22.

## AS-Interface

ASIsafe

3SF1 mechanical safety switches

### Hinge switches – plastic enclosures

#### Overview

The 3SF1 safety hinge switches with safety-related communication can be directly connected using the AS-Interface bus system. The safety functions no longer have to be conventionally wired up.

With the 3SF1 safety switches the ASIsafe electronics component is integrated in the switch enclosure.

The hinge switches are provided for mounting on hinges. There are two actuator variants here:

- Hollow shaft, inner diameter 8 mm, outer 12 mm
- Solid shaft, diameter 10 mm





For the ASIsafe version of the hinge switch, the basic switch and actuator head must be ordered separately. The basic switches correspond to the standard safety switches (use only versions with snap-action contacts).

The standards and approvals are the same as for the 3SF1 safety switches (see page 4/12).

#### Selection and ordering data

##### Modular system

1 or 2 contacts · 3 LEDs · Degree of protection IP65 (31 mm) or IP66/IP67 (50 mm) · M12 connector socket

Version	Contacts	LEDs	Article No.
<b>Basic switches · Enclosure width 31 mm acc. to EN 50047</b>			
 <p>ASIsafe basic switch</p>	<p><b>With Teflon plunger, with M12 connector socket</b>, 4-pole, channel 1 on NC contact, channel 2 on NC contact</p> <p>Snap-action contacts</p>	2 NC	24 V DC → <b>3SF1234-1LC05-1BA1</b>
<b>Basic switches · Enclosure width 50 mm</b>			
 <p>ASIsafe basic switch</p>	<p><b>With Teflon plunger, with M12 connector socket</b>, 4-pole, channel 1 on NC contact, channel 2 on M12 socket, right</p> <p>Snap-action contacts</p>	1 NC	24 V DC → <b>3SF1244-1LC05-1BA2</b>
<b>Actuator heads</b>			
 <p>Actuator head with hollow shaft</p>	<p><b>With hollow shaft</b></p> <ul style="list-style-type: none"> <li>• Operating angle 10°</li> </ul>		<b>3SE5000-0AU21</b>
 <p>Actuator head with solid shaft</p>	<p><b>With solid shaft</b></p> <ul style="list-style-type: none"> <li>• Operating angle 10°</li> </ul>		<b>3SE5000-0AU22</b>

⚙ For online configurator see [www.siemens.com/sirius/configurators](http://www.siemens.com/sirius/configurators).

➡ Positive opening according to IEC 60947-5-1, Appendix K.



## Overview

The 3SF1 safety hinge switches with safety-related communication can be directly connected using the AS-Interface bus system. The safety functions no longer have to be conventionally wired up.

With the 3SF1 safety switches the ASIsafe electronics component is integrated in the switch enclosure.

The hinge switches are provided for mounting on hinges. There are two actuator variants here:

- Hollow shaft, inner diameter 8 mm, outer 12 mm
- Solid shaft, diameter 10 mm

For the ASIsafe version of the hinge switch, the basic switch and actuator head must be ordered separately. The basic switches correspond to the standard safety switches (use only versions with snap-action contacts).

The standards and approvals are the same as for the 3SF1 safety switches (see page 4/12).

## Selection and ordering data

### Modular system

1 or 2 contacts · 3 LEDs · Degree of protection IP66/IP67 · M12 connector socket

Version	Contacts	LED	Article No.
<b>Basic switches - Enclosure width 31 mm acc. to EN 50047</b>			
 <p>ASIsafe basic switch</p> <p><b>With Teflon plunger,</b> with M12 connector socket, 4-pole channel 1 on NC contact, channel 2 on NC contact</p> <ul style="list-style-type: none"> <li>• Snap-action contacts</li> </ul>	2 NC	24 V DC	➔ <b>3SF1214-1LC05-1BA1</b>
<b>Basic switches - Enclosure width 40 mm acc. to EN 50041</b>			
 <p>ASIsafe basic switch</p> <p><b>With M12 connector socket,</b> 4-pole, channel 1 on NC contact, channel 2 on NC contact</p> <p>Snap-action contacts</p>	2 NC	24 V DC	➔ <b>3SF1114-1LA00-1BA1</b>
<b>Basic switches - Enclosure width 56 mm</b>			
 <p>ASIsafe basic switch</p> <p><b>With M12 connector socket,</b> 4-pole, channel 1 on NC contact, channel 2 on M12 socket, right</p> <p>Snap-action contacts</p>	1 NC	24 V DC	➔ <b>3SF1124-1LA00-1BA2</b>
<b>Actuator heads</b>			
 <p>Actuator head with hollow shaft</p> <p><b>Hollow shaft</b></p> <ul style="list-style-type: none"> <li>• Operating angle 10°</li> </ul>			<b>3SE5000-0AU21</b>
 <p>Actuator head with solid shaft</p> <p><b>Solid shaft</b></p> <ul style="list-style-type: none"> <li>• Operating angle 10°</li> </ul>			<b>3SE5000-0AU22</b>

⚙ For online configurator see [www.siemens.com/sirius/configurators](http://www.siemens.com/sirius/configurators).

➔ Positive opening according to IEC 60947-5-1, Appendix K.

## AS-Interface

ASIsafe

### 3SF2 cable-operated switches for AS-Interface

#### Overview

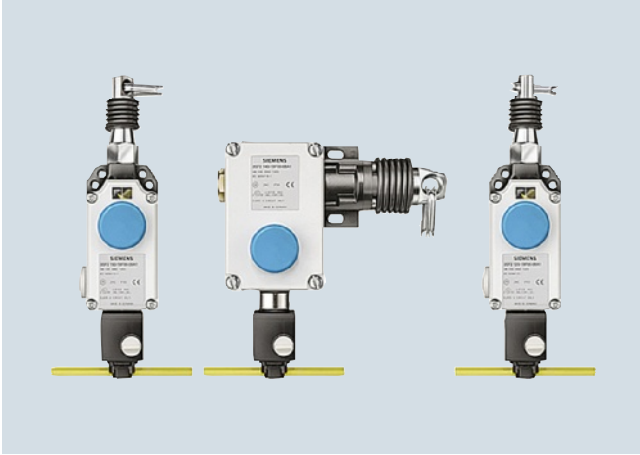

SIRIUS cable-operated switches are used for monitoring or for EMERGENCY-STOP devices on particularly endangered system components.

AS-Interface cable-operated switches can be directly connected via the bus system AS-Interface with safety-related communication. The safety functions no longer have to be conventionally wired up.



As the effective range of a cable-operated switch is only limited by the length of the trip-wire, large systems can also be protected.

#### Standards

The switches with positive latching are suitable for operation in EMERGENCY-STOP devices according to EN ISO 13850. They can achieve up to category 4 according to ISO 13849-1 or SIL 3 according to IEC 61508.

4

#### Selection and ordering data

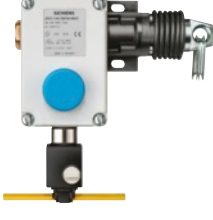
Version	Basic switches	Contacts	Article No.
<b>Cable-operated switch with AS-i F adapter</b>			
 <p>Metal enclosures with dust protection, IP65 latching acc. to ISO 13850, with button reset, 2 NC contacts</p> <ul style="list-style-type: none"> <li>• For wire lengths up to 10 m, with alignment window</li> </ul>	3SE7120-1BF00	2 NC	➔ 3SF2120-1BF00-0BA1
 <ul style="list-style-type: none"> <li>• For wire lengths up to 25 m, with alignment window</li> </ul>	3SE7150-1BF00	2 NC	➔ 3SF2150-1BF00-0BA1
 <ul style="list-style-type: none"> <li>• For wire lengths up to 50 m</li> </ul>	3SE7140-1BF00	2 NC	➔ 3SF2140-1BF00-0BA1

➔ Positive opening according to IEC 60947-5-1, Appendix K.

**SIRIUS EMERGENCY-STOP mushroom pushbuttons for AS-Interface**
**Overview**

EMERGENCY- STOP devices can be directly connected via the standard AS-Interface with safety-related communication. This applies only to series SIRIUS 3SB3 EMERGENCY-STOP mushroom pushbuttons for front panel mounting and installation in an enclosure.

**AS-Interface EMERGENCY-STOP enclosure**

The enclosure is supplied fully equipped and wired. It contains:

- SIRIUS 3SB3 EMERGENCY-STOP mushroom pushbutton with positive latching according to ISO 13850 and rotate-to-unlatch mechanism
- Contact blocks 2 NC contacts
- F slave with 2 safe inputs
- Inscription plate



The plastic enclosures are equipped with a plastic EMERGENCY-STOP mushroom pushbutton, the metal enclosures with a metal EMERGENCY-STOP mushroom pushbutton.

The plastic enclosures are designed with a terminal for the AS-Interface shaped cable (the cable is contacted by the insulation piercing method and routed along the exterior of the enclosure). With metal enclosure versions, the AS-Interface shaped cable (or a round cable) is brought into the enclosure.

The EMERGENCY-STOP enclosures are also available with an M12 connector socket.

4

**Selection and ordering data**

	Version	Connection	Article No.
 5SF5811-0AA08	<b>AS-Interface EMERGENCY-STOP mushroom pushbutton in plastic enclosure</b> <ul style="list-style-type: none"> <li>• Yellow enclosure top</li> <li>• Yellow enclosure top with protective collar</li> <li>• Yellow enclosure top</li> </ul>	Insulation piercing method	<b>3SF5811-0AA08</b>
		Insulation piercing method	<b>3SF5811-0AB08</b>
		M12 connector socket	<b>3SF5811-0AA10</b>
 3SF5811-2AB08	<b>AS-Interface EMERGENCY-STOP mushroom pushbutton in metal enclosure</b> <ul style="list-style-type: none"> <li>• Yellow enclosure top</li> <li>• Yellow enclosure top with protective collar</li> <li>• Yellow enclosure top</li> <li>• Yellow enclosure top with protective collar</li> </ul>	Cable gland	<b>3SF5811-2AA08</b>
		Cable gland	<b>3SF5811-2AB08</b>
		M12 connector socket	<b>3SF5811-2AA10</b>
		M12 connector socket	<b>3SF5811-2AB10</b>
 3SF5811-2AA10			

















**AS-Interface**

ASIsafe

**SIRIUS EMERGENCY-STOP mushroom pushbuttons for AS-Interface****Selection and ordering data**

EMERGENCY-STOP devices acc. to ISO 13850 and IEC 60947-5-5

- With holder for front plate mounting
- Connection with AS-Interface F adapter
- Yellow contrast surfaces must be ordered separately.

	Version	Approval	Article No.
<i>With plastic enclosure</i>			
	<b>EMERGENCY-STOP mushroom pushbuttons, Ø 32 mm,</b> with positive latching according to ISO 13850, with rotate-to-unlatch mechanism		<b>3SB3000-1FA20</b>
Mushroom diameter 32 mm			
	<b>EMERGENCY-STOP mushroom pushbuttons, Ø 40 mm,</b> with positive latching according to ISO 13850, with rotate-to-unlatch mechanism		<b>3SB3000-1HA20</b> <b>3SB3000-1HA26</b>
Mushroom diameter 40 mm, with rotate-to-unlatch mechanism with switch position indication	<ul style="list-style-type: none"> <li>• Without switch position indicator</li> <li>• With mechanical switch position indication</li> </ul>		
	<b>EMERGENCY-STOP mushroom pushbuttons, Ø 40 mm,</b> with positive latching according to ISO 13850, with pull-to-unlatch mechanism		<b>3SB3000-1TA20</b>
Mushroom diameter 40 mm, pull-to-unlatch mechanism			
	<b>EMERGENCY-STOP mushroom pushbuttons, Ø 60 mm,</b> with positive latching according to ISO 13850, with rotate-to-unlatch mechanism		<b>3SB3000-1AA20</b>
Mushroom diameter 60 mm			
	<b>EMERGENCY-STOP mushroom pushbuttons, Ø 40 mm,</b> <b>with RONIS key-operated switch,</b> lock No. SB 30, with positive latching according to ISO 13850, unlocking only possible using key		<b>3SB3000-1BA20</b>
Mushroom diameter 40 mm, with RONIS key-operated switch			
	<b>EMERGENCY-STOP mushroom pushbuttons, Ø 40 mm,</b> <b>with CES key-operated switch,</b> lock No. SSG 10, with positive latching according to ISO 13850, unlocking only possible using key		<b>3SB3000-1KA20</b>
Mushroom diameter 40 mm, with CES key-operated switch			
	<b>EMERGENCY-STOP mushroom pushbuttons, Ø 40 mm,</b> <b>with BKS key-operated switch,</b> lock No. S1, with positive latching according to ISO 13850, unlocking only possible using key		<b>3SB3000-1LA20</b>
Mushroom diameter 40 mm, with O.M.R. key-operated switch			
	<b>EMERGENCY-STOP mushroom pushbuttons, Ø 40 mm,</b> <b>with O.M.R. key-operated switch,</b> lock No. 73037, with positive latching according to ISO 13850, unlocking only possible using key		<b>3SB3000-1MA20</b>
Mushroom diameter 40 mm, with O.M.R. key-operated switch			

For online configurator see [www.siemens.com/sirius/configurators](http://www.siemens.com/sirius/configurators).

















See Industry Mall for accessories such as yellow backing plates.

## SIRIUS EMERGENCY-STOP mushroom pushbuttons for AS-Interface

## Selection and ordering data (continued)

EMERGENCY-STOP devices acc. to ISO 13850 and IEC 60947-5-5

- With holder for front plate mounting
- Connection with AS-Interface F adapter
- Yellow contrast surfaces must be ordered separately.

Version	Approval	Article No.
<b>With metal enclosure</b>		
 Mushroom diameter 32 mm	<b>EMERGENCY-STOP mushroom pushbuttons, Ø 32 mm,</b> with positive latching according to ISO 13850, with rotate-to-unlatch mechanism  • Standard version • Solvent-resistant <sup>1)</sup>	  <b>3SB3500-1FA20</b> <b>3SB3500-1FA20-0PA0</b>
 Mushroom diameter 40 mm, with rotate-to-unlatch mechanism with switch position indication	<b>EMERGENCY-STOP mushroom pushbuttons, Ø 40 mm,</b> with positive latching according to ISO 13850, with rotate-to-unlatch mechanism  Without switch position indicator Without switch position indicator, solvent-resistant <sup>1)</sup> With mechanical switch position indication	  <b>3SB3500-1HA20</b> <b>3SB3500-1HA20-0PA0</b> <b>3SB3500-1HA26</b>
 Mushroom diameter 40 mm, pull-to-unlatch mechanism	<b>EMERGENCY-STOP mushroom pushbuttons, Ø 40 mm,</b> with positive latching according to ISO 13850, with pull-to-unlatch mechanism	  <b>3SB3500-1TA20</b>
 Mushroom diameter 60 mm	<b>EMERGENCY-STOP mushroom pushbuttons, Ø 60 mm,</b> with positive latching according to ISO 13850, with rotate-to-unlatch mechanism	  <b>3SB3500-1AA20</b>
 Mushroom diameter 40 mm, with RONIS key-operated switch	<b>EMERGENCY-STOP mushroom pushbuttons, Ø 40 mm,</b> <b>with RONIS key-operated switch,</b> lock No. SB 30, with positive latching according to ISO 13850, unlocking only possible using key	  <b>3SB3500-1BA20</b>
 Mushroom diameter 40 mm, with CES key-operated switch	<b>EMERGENCY-STOP mushroom pushbuttons, Ø 40 mm,</b> <b>with CES key-operated switch,</b> lock No. SSG 10, with positive latching according to ISO 13850, unlocking only possible using key	  <b>3SB3500-1KA20</b>
 Mushroom diameter 40 mm, with BKS key-operated switch	<b>EMERGENCY-STOP mushroom pushbuttons, Ø 40 mm,</b> <b>with BKS key-operated switch,</b> lock No. S1, with positive latching according to ISO 13850, unlocking only possible using key	  <b>3SB3500-1LA20</b>
 Mushroom diameter 40 mm, with O.M.R. key-operated switch	<b>EMERGENCY-STOP mushroom pushbuttons, Ø 40 mm,</b> <b>with O.M.R. key-operated switch,</b> lock No. 73037, with positive latching according to ISO 13850, unlocking only possible using key	  <b>3SB3500-1MA20</b>

For online configurator see [www.siemens.com/sirius/configurators](http://www.siemens.com/sirius/configurators).

<sup>1)</sup> Not suitable for laser inscription.

See Industry Mall for accessories such as yellow backing plates.

## AS-Interface

ASIsafe

### AS-Interface F adapters for EMERGENCY-STOP devices

#### Overview



The AS-Interface F adapter is used to connect an EMERGENCY-STOP device according to ISO 13850 from the 3SB3 series to the AS-Interface bus system. The F adapter is suitable for control devices with mounting on front plates.



The F adapter has a safe AS-Interface 2I slave and is snapped from behind onto the EMERGENCY-STOP mushroom pushbutton. In the 2I/1O expanded version, an output is also available for actuating an indicator light with LED.

Depending on the version, screw terminals or spring-type terminals or the insulation piercing method are used for connecting to the AS-Interface bus cable. Addressing is performed using the AS-Interface connection or the integrated addressing socket.

Safety category 4 (SIL 3) is achieved with the adapter.

4

#### Selection and ordering data

	Version	Connection	Article No.
 3SF5402-1AA03	<b>AS-Interface F adapter for 3SB3 EMERGENCY-STOP mushroom pushbuttons</b> For mounting on front plates <ul style="list-style-type: none"> <li>• 2I</li> <li>• 2I/1O, with output for LED control</li> </ul>	Screw terminals	<b>3SF5402-1AA03</b> <b>3SF5402-1AB03</b>
		Spring-type terminals	<b>3SF5402-1AA04</b> <b>3SF5402-1AB04</b>
		Insulation piercing method	<b>3SF5402-1AA05</b> <b>3SF5402-1AB05</b>
 3SF5402-1AA04			
 3SF5402-1AA05			

## Overview



CM 1243-2 communication module for S7-1200

The CM 1243-2 communication module is the AS-Interface master for the SIMATIC S7-1200 and has the following features:

- Connection of up to 62 AS-Interface slaves
- Integrated analog value transmission
- Supports all AS-Interface master functions according to the AS-Interface Specification V3.0
- Indication of the operating state on the front of the device displayed via LED
- Display of operating mode, AS-Interface voltage faults, configuration faults and peripheral faults via LED behind the front panel
- Compact enclosure in the design of the SIMATIC S7-1200
- Suitable for AS-i power 24V: in combination with the optional DCM 1271 data decoupling module, a standard 24 V power supply unit can be used.
- Configuration and diagnostics via the TIA Portal

### Design

The CM 1243-2 communication module is positioned to the left of the S7-1200 CPU and linked to the S7-1200 via lateral contacts.

It has:

- Terminals for two AS-i cables (internally jumpered) via two screw terminals each respectively
- One terminal for connection to the functional ground
- LEDs for indication of the operating state and fault statuses of the connected slaves

The screw terminals (included in scope of supply) can be removed to facilitate installation.

### Function

The CM 1243-2 supports all specified functions of the AS-Interface Specification V3.0.

The values of the digital AS-i slaves can be activated via the process image of the S7-1200. During configuration of the slaves in the TIA Portal, the values of the analog AS-i slaves can also be accessed directly in the process image.

It is also possible to exchange all data of the AS-i master and the connected AS-i slaves with the S7-1200 via the data record interface.

Changeover of the operating mode, automatic application of the slave configuration and the re-addressing of a connected AS-i slave can be implemented via the control panel of the CM 1243-2 in the TIA Portal.

The optional DCM 1271 data decoupling module has an integrated detection unit for detecting ground faults on the AS-Interface cable. The integrated overload protection also disconnects the AS-Interface cable if the drive power required exceeds 4 A.

### Notes on safety:

The use of this product requires suitable protective measures (e.g. network segmentation for IT security among others) in order to ensure safe plant operation, see [www.siemens.com/industrialsecurity](http://www.siemens.com/industrialsecurity).

### Configuration

To configure CM 1243-2, you require STEP 7 V11+ SP2 or STEP 7 V12 or higher.

For STEP 7 V11+ SP2 or higher, the additional Hardware Support Package for CM 1243-2 is required. This is available via the Industry Online Support Portal, see <http://support.automation.siemens.com/WW/view/en/54164095>.

The software enables user-friendly configuration and diagnostics of the AS-Interface master and any connected slaves.

Alternatively, you can also apply the AS-Interface ACTUAL configuration at the "touch of a button" via the control panel integrated in the TIA Portal/STEP 7.

## AS-Interface

Masters

Masters for SIMATIC S7

### CM 1243-2

#### Benefits

- More flexibility and versatility in the use of SIMATIC S7-1200 as the result of a significant increase in the number of digital and analog inputs/outputs available
- Very easy configuration and diagnostics of the AS-Interface via the TIA Portal (STEP 7 V11+ SP2 or higher)
- No need for the AS-i power supply unit with AS-i Power24V: The AS-Interface cable is supplied through an existing 24 V DC PELV power supply unit. For decoupling, the AS-i DCM 1271 data decoupling module is required, see page 4/142.
- LEDs for indication of fault statuses for fast diagnostics
- Monitoring of AS-Interface voltage facilitates diagnostics

#### Application

The CM 1243-2 is the AS-Interface master connection for the 12xx CPUs of the SIMATIC S7-1200. Connection to the AS-Interface greatly increases the number of inputs and outputs available for S7-1200 (max. 496 DI/496 DO on the AS-Interface per CM).

The integrated analog value processing also makes the analog values available at the AS-Interface for the S7-1200 (per CM up to 31 standard analog slaves, each with up to 4 channels, or up to 62 A/B analog slaves, each with up to 2 channels).

4

#### Selection and ordering data

Version	Article No.
 <p><b>CM 1243-2 communication modules</b></p> <ul style="list-style-type: none"> <li>• AS-Interface masters for SIMATIC S7-1200</li> <li>• Corresponds to AS-Interface Specification V3.0</li> <li>• Dimensions (W × H × D / mm): 30 × 100 × 75</li> </ul> <p>3RK7243-2AA30-0XB0</p>	<b>3RK7243-2AA30-0XB0</b>

#### Accessories

Version	Article No.
<p><b>5-pole screw terminals</b></p> <p>for AS-i master CM 1243-2 and AS-i DCM 1271 data decoupling module</p> <ul style="list-style-type: none"> <li>• With screw terminals</li> </ul>	 <p><b>3RK1901-3MA00</b></p>

#### More information

Manual "AS-i Master CM 1243-2 and AS-i Data Decoupling Module DCM 1271 for SIMATIC S7-1200" see <http://support.automation.siemens.com/WW/view/en/57358958>.



## Overview



CP 343-2P / CP 343-2

The CP 343-2P is the AS-Interface master for the SIMATIC S7-300 programmable controller and the ET 200M distributed I/O station.

The CP 343-2 is the basic version of the module.

The CP343-2P / CP 343-2 performs the following features:

- Connection of up to 62 AS-Interface slaves
- Integrated analog value transmission (all analog profiles)
- Supports all AS-Interface master functions according to the AS-Interface Specification V3.0
- Display of the operating state and readiness for operation of connected slaves by means of LEDs in the front panel
- Fault indications (e. g. AS-Interface voltage fault, configuration fault) by means of LEDs in the front panel
- Compact enclosure in the design of the SIMATIC S7-300
- Suitable for AS-i Power24V (from product version 2/firmware version 3.1) and for standard AS-i with 30 V voltage.
- With CP 343-2P additionally: Supports the configuration of the AS-Interface network with STEP 7 V5.2 and higher

## Design

The CP 343-2P / CP 343-2 is connected like an I/O module to the S7-300. It has:

- Two terminal connections for direct connection of the AS-Interface cable
- LEDs in the front panel for indicating the operating state and the readiness for operation of all connected and activated slaves
- Pushbuttons for switching over the master operating state and for adopting the existing ACTUAL configuration of the AS-i slave as the DESIRED configuration

## Function

The CP 343-2P / CP 343-2 supports all specified functions of the AS-Interface Specification V3.0.

The CP 343-2P / CP 343-2 occupies 16 bytes each in the I/O address area of the SIMATIC S7-300. The digital I/O data of the standard slaves and A slaves are saved in this area. The digital I/O data of the B slaves and the analog I/O data can be accessed with the S7 system functions for read/write data record.

If required, master calls can be performed with the command interface, e.g. read/write parameters, read/write configuration.

For more information see

<http://support.automation.siemens.com/WW/view/en/51678777>.

## Notes on safety:

The use of this product requires suitable protective measures (e.g. network segmentation for IT security among others) in order to ensure safe plant operation, see [www.siemens.com/industrialsecurity](http://www.siemens.com/industrialsecurity).

## Configuration

All connected AS-Interface slaves are configured at the press of a button. No further configuration of the CP is required.

### With CP 343-2P additionally

The CP 343-2P also supports configuring of the AS-Interface network with STEP 7 V5.2 and higher. Specifying the AS-i configuration in HW-Config facilitates the setting of slave parameters and documentation of the plant. Uploading the ACTUAL configuration of an already configured AS-Interface network is also supported. The saved configuration cannot be overwritten at the press of a button and is therefore tamper-proof.

## Benefits

- Shorter start-up times through simple configuration at the press of a button
- Using it in the ET 200M distributed I/O system allows flexible machine-related structures to be constructed
- Provides diagnostics of the AS-Interface network
- Well suited also for complex applications thanks to connection options for 62 slaves and integral analog value processing
- Reduction of standstill and servicing times in the event of a fault thanks to the LED indicators:
  - Status of the AS-Interface network
  - Slaves connected and their readiness for operation
  - Monitoring of the AS-Interface mains voltage
- Lower costs for stock keeping and spare parts because the CP can be used for the SIMATIC S7-300 as well as for the ET 200M
- With CP 343-2P additionally: Improved plant documentation and support for service assignments thanks to a description of the AS-Interface configuration in the STEP 7 project
- No need for the AS-i power supply unit with AS-i Power24V: The AS-Interface cable is supplied through an existing 24 V DC PELV power supply unit. An AS-i data decoupling module (e.g. 3RK1901-1DE12-1AA0) is required for the decoupling, see page 4/142.
- Operation with AS-Interface power supply (see page 4/142) possible without restrictions.

## AS-Interface

Masters

Masters for SIMATIC S7

CP 343-2P / CP 343-2

### Application



The CP 343-2P / CP 343-2 is the AS-Interface master connection for the SIMATIC S7-300 and the ET 200M.

Through connection to AS-Interface it is possible to access max. 248 DI/248 DO per CP, using 62 A/B slaves with 4DI/4DO each.



With the integrated analog value processing, it is easy to transmit analog signals (per CP up to 62 A/B analog slaves with a maximum of 2 channels each or up to 31 standard analog slaves with a maximum of 4 channels each).

The CP 343-2P is the further development of the CP 343-2 and contains its entire functionality. An existing STEP 7 user program for a CP 343-2 can thus be used without restrictions with a CP 343-2P. It is only in STEP 7 HW-Config that the two modules are configured differently, with the CP 343-2P offering additional options. This is why the CP 343-2P is recommended.

### Selection and ordering data

Version	Article No.
 <p><b>CP 343-2P communications processors</b> For connection of SIMATIC S7-300 and ET 200M to AS-Interface; Configuration of the AS-i network using the SET key or STEP 7 (V5.2 and higher); without front connector; corresponds to AS-Interface Specification V3.0; dimensions (W x H x D / mm): 40 x 125 x 120</p> <p>6GK7343-2AH11-0XA0</p>	<b>6GK7343-2AH11-0XA0</b>
 <p><b>CP 343-2 communications processors</b> Basic version for connection of SIMATIC S7-300 and ET 200M to AS-Interface Configuration of the AS-i network using the SET key; without front connector; corresponds to AS-Interface Specification V3.0; dimensions (W x H x D / mm): 40 x 125 x 120</p> <p>6GK7343-2AH01-0XA0</p>	<b>6GK7343-2AH01-0XA0</b>

### Accessories

Version	Article No.
<p><b>Front connector, 20-pole</b></p> <ul style="list-style-type: none"> <li>• With screw terminals</li> </ul>	 <b>6ES7392-1AJ00-0AA0</b>
<ul style="list-style-type: none"> <li>• With spring-type terminals</li> </ul>	 <b>6ES7392-1BJ00-0AA0</b>

### More information

AS-i block library for PCS 7 for easy connection of AS-Interface to PCS 7 see

- Catalog IC 10, Chapter 14 "Parameterization, Configuration and Visualization with SIRIUS" ⇒ "AS-Interface Block Library for SIMATIC PCS 7"
- Industry Mall: "Automation Technology"  
⇒ "Industrial Controls"  
⇒ "Parameterization, Configuration and Visualization with SIRIUS"  
⇒ "AS-Interface Block Library for SIMATIC PCS 7"

### Manuals

Manuals see  
<http://support.automation.siemens.com/WWW/view/en/14310380/133300>.

## Overview

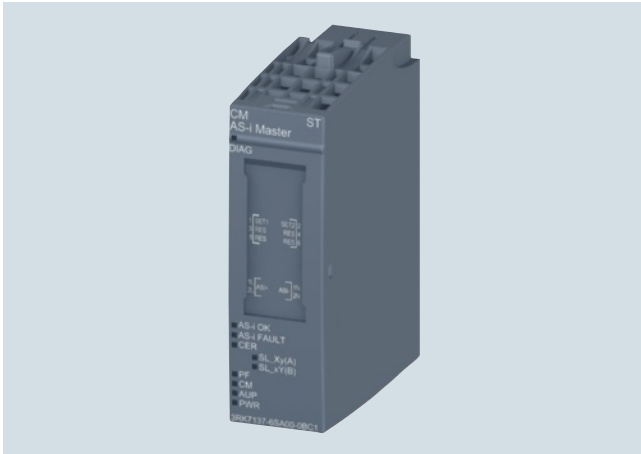

CM AS-i Master ST for SIMATIC ET 200SP

The CM AS-i Master ST communication module is designed for use in the SIMATIC ET 200SP distributed I/O system and has the following features:

- Connection of up to 62 AS-Interface slaves
- Supports all AS-Interface master functions according to the AS-Interface Specification V3.0
- User-friendly configuration with graphic display of the AS-i line in TIA Portal V12.0 or in other systems using GSD
- Supply via AS-Interface cable
- Suitable for AS-i Power24V and for AS-Interface with 30 V voltage
- Integrated ground-fault monitoring for the AS-Interface cable
- Through connection to AS-Interface, the number of digital inputs and outputs available for the control system is greatly increased (max. 496 DI/496 DO on the AS-Interface per CM AS-i Master ST).
- Integrated analog value processing (all analog profiles)

### Basic unit: ET 200SP distributed I/O system

The SIMATIC ET 200SP is a scalable and highly flexible distributed I/O system for connecting the process signals to a central control system via PROFIBUS or PROFINET.

Up to eight CM AS-i Master STs can be plugged into a SIMATIC ET 200SP with the IM 155-6 PN standard interface module.

For more information, see "SIMATIC ET 200SP ET 200SP Distributed I/O System" System Manual, <http://support.automation.siemens.com/WW/view/en/58649293>.

### Design

The CM AS-i Master ST module has an ET 200SP module enclosure with a width of 20 mm. A C0 type BaseUnit (BU) is required for use in the ET 200SP.

The module has LED indicators for diagnostics, operation, AS-i voltage and AS-i slave status and offers informative front-side module inscription for

- Plain-text marking of the module type and function class
- 2D matrix code (article number and serial number)
- Circuit diagram
- Color coding of the CM module type: Light gray
- Hardware and firmware version
- Complete article number

### Function

The CM AS-i Master ST supports all specified functions of the AS-Interface Specification V3.0.

The input/output values of the digital AS-i slaves can be activated via the cyclic process image. The values of the analog AS-i slaves can be reached via data record transfer.

If required, master calls can be performed with the command interface, e.g. read/write parameters, read/write configuration.

Changeover of the operating mode, automatic application of the slave configuration and the re-addressing of a connected AS-i slave can be implemented via the control panel of the CM AS-i Master ST in the TIA Portal.

### Notes on safety:

The use of this product requires suitable protective measures (e.g. network segmentation for IT security among others) in order to ensure safe plant operation, see [www.siemens.com/industrialsecurity](http://www.siemens.com/industrialsecurity).

### Configuration

The following software is required for configuration of the CM AS-i Master ST module:

- STEP 7 (classic), V5.5 SP3 HF4 or higher with HSP 2092 or
- STEP 7 (TIA Portal), V12 or higher or
- the GSD file of the ET 200SP with STEP 7 or another engineering tool

The TIA Portal enables user-friendly configuration and diagnostics of the AS-i master and, in the event of interfacing to a SIMATIC S7-300/S7-400 station, any connected slaves.

Alternatively, you can also apply the AS-Interface ACTUAL configuration as the DESIRED configuration at the "touch of a button" via the control panel integrated in the TIA Portal or connection of an optional button. Configuration with the GSD file is possible only with the button.

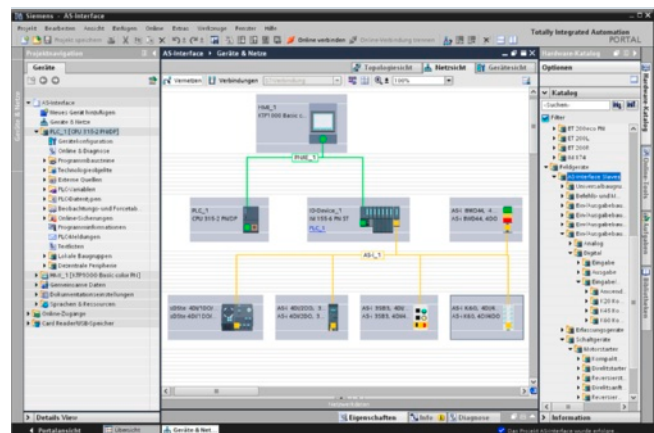

Configuration of an AS-Interface network with CM AS-i Master ST via TIA Portal

The CM AS-i Master ST module occupies 32 input bytes and 32 output bytes in the I/O data of the ET 200SP station.

## AS-Interface

Masters

Masters for SIMATIC ET 200

### CM AS-i Master ST for SIMATIC ET 200SP

#### Benefits

The CM AS-i Master ST for ET 200SP communication module enables modular, easy and high-performance expansion of AS-Interface networks via engineering in the TIA Portal.

Up to eight CM AS-i Master ST units can be plugged into one ET 200SP station with IM 155-6 PN Standard. The maximum configuration depends on the interface module used.

Multiple masters as well as single masters can thus be implemented in the ET 200SP depending on the number of modules.

Together with the interface module, a scalable PROFINET/AS-i Link or PROFIBUS/AS-i Link can be assembled.

#### Application

##### Configuration examples of AS-Interface networks with CM AS-i Master ST for SIMATIC ET 200SP

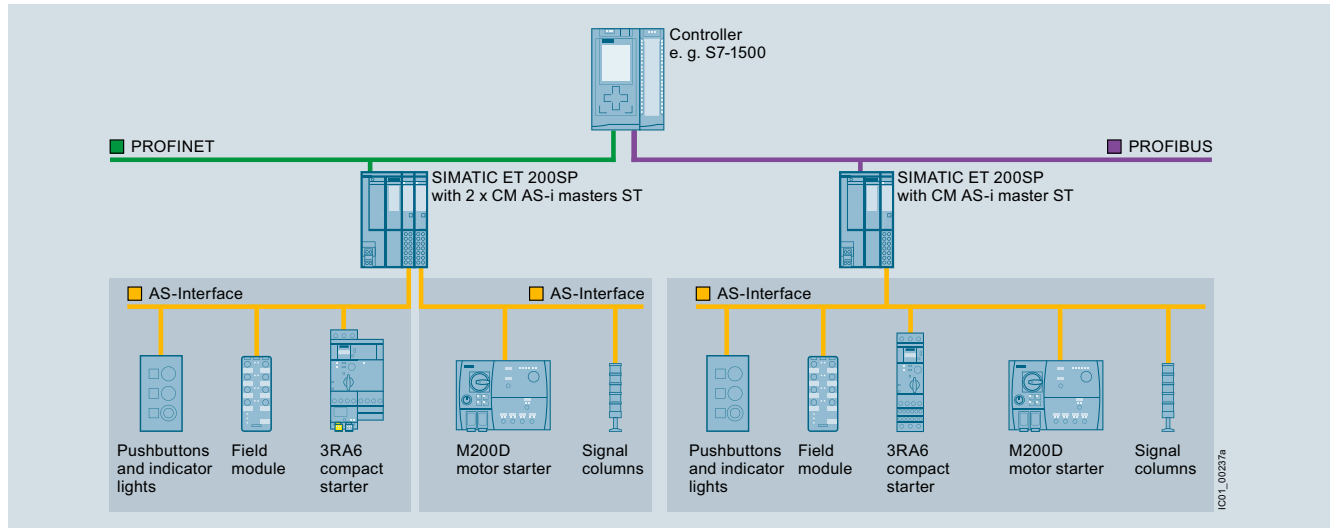



Configuration of AS-Interface networks under a SIMATIC ET 200SP

#### Selection and ordering data

Version	Article No.
 <p><b>CM AS-i Master ST communication modules</b></p> <ul style="list-style-type: none"> <li>AS-Interface master for SIMATIC ET 200SP, can be plugged onto BaseUnit type C0</li> <li>Corresponds to AS-Interface Specification V3.0</li> <li>Dimensions (W × H × D / mm): 20 × 73 × 58</li> </ul>	<b>3RK7137-6SA00-0BC1</b>



3RK7137-6SA00-0BC1

#### Accessories

Version	Spring-type terminals
 <p><b>BaseUnit BU20-P6+A2+4D</b></p> <ul style="list-style-type: none"> <li>BaseUnit (light), BU type C0</li> <li>Suitable for the CM AS-i Master ST module</li> <li>For connection of AS-Interface cable to the CM AS-i Master ST</li> <li>Beginning of an AS-i network, disconnection of AS-i voltage to the left-hand module</li> </ul>	<b>6ES7193-6BP20-0DC0</b> 

6ES7193-6BP20-0DC0

## Accessories (continued)

Version	Article No.	
 <p>6ES7155-6AA00-0BN0</p>	<p><b>PROFINET interface modules IM 155-6 PN Standard</b> Max. 32 I/O modules, max. 256 bytes I/O data per station</p> <ul style="list-style-type: none"> <li>• Including server module and bus adapter 2 x RJ45 (supplied without RJ45 connector)</li> <li>• Including server module (bus adapter must be ordered separately, see below)</li> </ul>	<p><b>6ES7155-6AA00-0BN0</b></p> <p><b>6ES7155-6AU00-0BN0</b></p>
	<p><b>PROFINET interface modules IM 155-6 PN High Feature</b> Max. 64 I/O modules, Max. 1440 bytes I/O data per station</p> <ul style="list-style-type: none"> <li>• Including server module (bus adapter must be ordered separately, see below)</li> </ul>	<p><b>6ES7155-6AU00-0CN0</b></p>
 <p>6ES7193-6AR00-0AA0</p> <p>6ES7193-6AF00-0AA0</p>	<p><b>PROFIBUS interface modules IM 155-6 DP High Feature</b> Max. 32 I/O modules, Max. 244 bytes I/O data per station</p> <ul style="list-style-type: none"> <li>• Including server module and PROFIBUS connector</li> </ul>	<p><b>6ES7155-6BA00-0CN0</b></p>
	<p><b>Bus adapters for PROFINET</b> For connection of the Ethernet cable to the PROFINET IM 155-6 PN interface module</p> <ul style="list-style-type: none"> <li>• Connection 2 x RJ45 (supplied without RJ45 connector)</li> </ul>	<p><b>6ES7193-6AR00-0AA0</b></p>
	<ul style="list-style-type: none"> <li>• Connection 2 x FC (FastConnect)</li> </ul>	<p><b>6ES7193-6AF00-0AA0</b></p>

## More information

### Manuals

"CM AS-i Master ST for SIMATIC ET 200SP" manual see <http://support.automation.siemens.com/WW/view/en/71756485>.

"SIMATIC ET 200SP BaseUnits" manual see <http://support.automation.siemens.com/WW/view/en/59753521>.

"SIMATIC ET 200SP ET 200SP Distributed I/O System" system manual see <http://support.automation.siemens.com/WW/view/en/58649293>.

### Industry Mall

For more information see Industry Mall at "Automation Technology"  
⇒ "Industrial Communication" ⇒ "AS-Interface" ⇒ "Masters"  
⇒ "Masters for SIMATIC ET 200".

## AS-Interface

Masters

Masters for SIMATIC ET 200

### F-CM AS-i Safety ST for SIMATIC ET 200SP

#### Overview

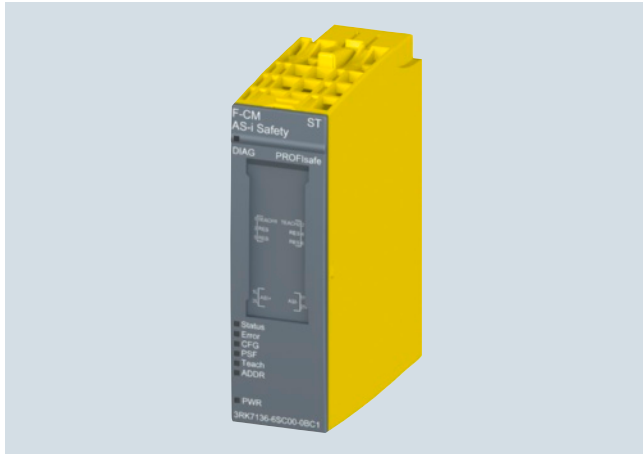

F-CM AS-i Safety ST for SIMATIC ET 200SP

The F-CM AS-i Safety ST fail-safe communication module supplements an AS-Interface network without additional wiring to produce a safety-related AS-i network.

Important features:

- Fail-safe communication module for the ET 200SP
  - 31 fail-safe input channels in the process image
  - 16 fail-safe output channels in the process image
  - Certified up to SIL 3 (IEC 62061/IEC 61508), PL e (EN ISO 13849-1)
  - Parameterization conforms with other fail-safe I/O modules of the ET 200SP
- The communication module supports PROFINET in PROFINET configurations. Suitable for use with fail-safe SIMATIC S7-300F/S7-416F CPUs.
- For reading up to 31 fail-safe AS-i input slaves
  - 2 sensor inputs/signals for each fail-safe AS-i input slave
  - Adjustable evaluation of sensor signals: 2-channel or 2 x 1-channel
  - Integrated discrepancy evaluation in the case of 2-channel signals
  - Integrated AND operation in the case of 2 x 1-channel signals
  - Input delay can be parameterized
  - Start-up test can be set
  - Sequence monitoring can be activated
- For control of up to 16 fail-safe AS-i output circuit groups
  - The output circuit groups are controlled independently of one another.
  - One output circuit group can act on one or more actuators (e.g. to switch drives simultaneously).
  - An actuator (e.g. a contactor) is interfaced via a fail-safe AS-i output module (e.g. safe SlimLine module S45F, Article No. 3RK1405-1SE15-0AA2, see page 4/10).
  - Simple fault acknowledgment via the process image
- Simple module replacement thanks to automatic importing of the safety parameters from the coding element
- Comprehensive diagnostic options
- Can be plugged onto type C1 or type C0 BaseUnits (BU)
- Supply via AS-Interface voltage
- 8 LED indicators for diagnostics, operating state, fault indication and supply voltage

- Informative front-side module inscription
  - Plain-text marking of the module type and function class
  - 2D matrix code (article number and serial number)
  - Circuit diagram
  - Color coding of the CM module type: Light gray
  - Hardware and firmware version
  - Complete article number
- Optional labeling accessories
  - Labeling strips
  - Reference identification label

#### Design

The fail-safe F-CM AS-i Safety ST module has an ET 200SP module enclosure with a width of 20 mm.

One AS-i master according to the AS-i Specification V3.0 and fail-safe AS-i input slaves and/or fail-safe AS-i output modules are needed for operation. The CM AS-i Master ST communication module (Article No. 3RK7137-6SA00-0BC1) is recommended as the AS-i master for the ET 200SP, see page 4/38.

#### SIMATIC AS-i F-Link

Simple combination of the CM AS-i Master ST and F-CM AS-i Safety ST modules in one ET 200SP station with PROFINET interfacing results in a powerful PN/AS-i F-Link, which can be expanded further in a modular fashion.



SIMATIC AS-i F-Link: combination of an ET 200SP interface module, CM AS-i Master ST and F-CM AS-i Safety ST

With the digital and analog I/O modules of the ET 200SP, local inputs and outputs can be realized in the SIMATIC AS-i F-Link so as to ensure that the F-Link complies precisely with customer requirements. Expansion variants for almost every application are possible thanks to the selection of standard and fail-safe I/O modules.

Besides the single AS-i master, double, triple or generally multi-masters can be realized with or without fail-safe functionality.

#### Overview (continued)

##### Supported BaseUnits

With the recommended combination of the CM AS-i Master ST and F-CM AS-i Safety ST modules, the CM module is plugged onto a light type C0 BaseUnit and, directly on the right of it, the F-CM module is plugged onto a dark type C1 BaseUnit. The AS-i cable is connected only on the light BaseUnit of the CM module.

If the F-CM AS-i Safety ST module is not combined with the CM AS-i Master ST module, but another AS-i master is used instead, then the F-CM module is plugged onto a light type C0 BaseUnit. In this case, the AS-i cable is connected on the light BaseUnit of the F-CM module.

##### Note on safety:

The use of this product requires suitable protective measures (e.g. network segmentation for IT security among others) in order to ensure safe plant operation, see [www.siemens.com/industrialsecurity](http://www.siemens.com/industrialsecurity).

##### Configuration

The following software is required for configuration of the F-CM AS-i Safety ST module:

- STEP 7 (classic), V5.5 SP3 HF4 or higher with HSP 2093 and Distributed Safety V5.4 SP5 or F-Configuration Pack SP11

Configuration and programming are done entirely in the STEP 7 user interface. No additional configuration software is needed for commissioning.

Data management – together with all other configuration data of the SIMATIC – is realized completely in the S7 project.

The input and output channels are assigned to the process image automatically and manual linking via configuration function blocks is not necessary.

If the F-CM AS-i Safety ST module is replaced, all necessary settings are automatically imported into the new module.

The F-CM AS-i Safety ST module occupies 16 input bytes and 8 output bytes in the I/O data of the ET 200SP station.

#### Application

Thanks to use of the fail-safe module in the ET 200SP, it is possible to fulfill the safety-related application requirements in a manner that is integrated in the overall automation solution.

The safety functions required for fail-safe operation are integrated in the modules. Communication with the fail-safe SIMATIC S7 CPUs is realized via PROFIsafe.

The safety application is programmed in the SIMATIC S7 F-CPU with Distributed Safety. The fail-safe input signals of the AS-i safe slave modules are read via the

AS-i bus line and are combined with any chosen further signals in the fail-safe program.

The fail-safe output signals can be output through fail-safe SIMATIC output modules or also directly via AS-i – with the aid of fail-safe AS-i output modules, e.g. 3RK1405-1SE15-0AA2 (see page 4/10). No special functions are required for this in the program.

#### Configuration examples of AS-Interface networks with CM AS-i Master ST and F-CM AS-i Safety ST for SIMATIC ET 200SP

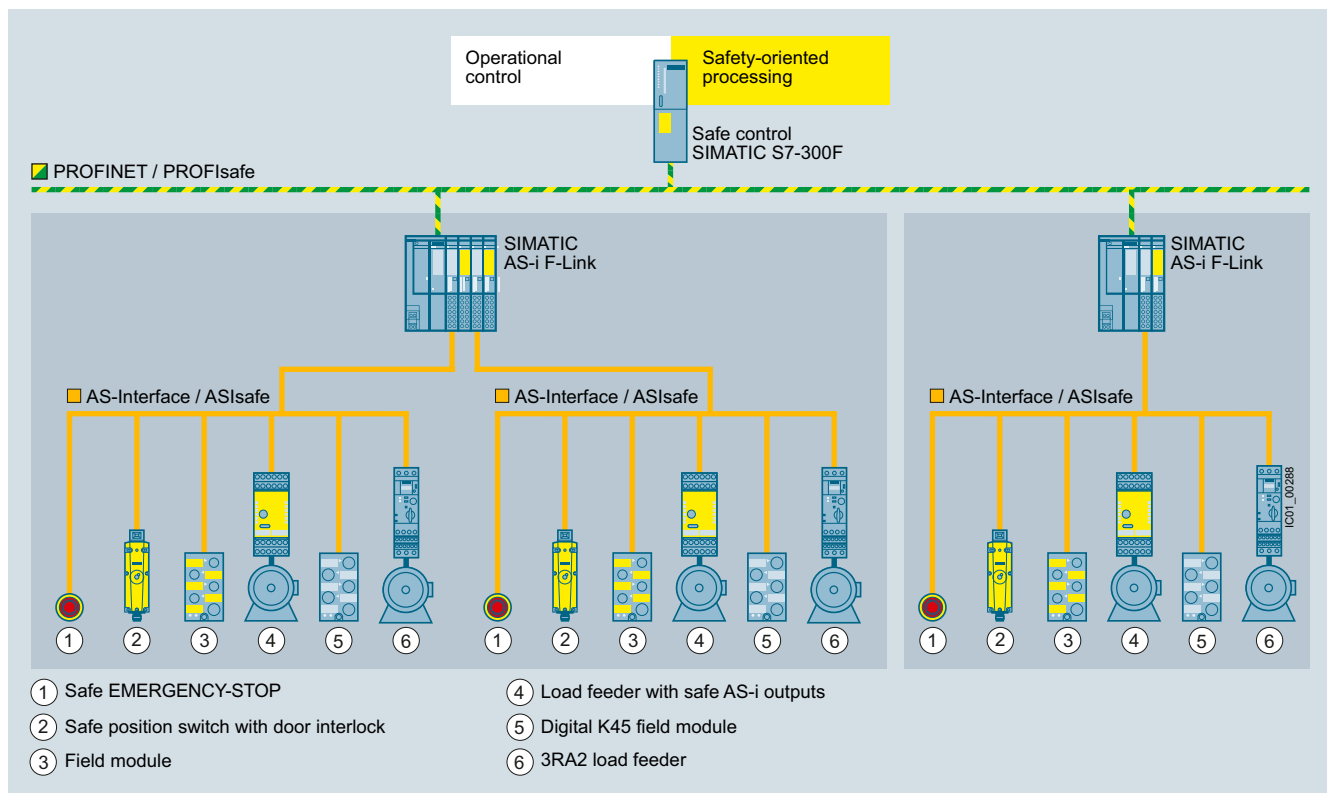

AS-Interface configuration with SIMATIC AS-i F-Link, consisting of an ET 200SP station with CM AS-i Master ST and F-CM AS-i Safety ST modules

## AS-Interface

Masters

Masters for SIMATIC ET 200

### F-CM AS-i Safety ST for SIMATIC ET 200SP

#### Selection and ordering data

Version	Article No.
 <p><b>F-CM AS-i Safety ST communication modules</b></p> <ul style="list-style-type: none"> <li>• Fail-safe module for SIMATIC ET 200SP, can be plugged onto BaseUnit type C1 (alternatively type C0)</li> <li>• An AS-i master, e.g. CM AS-i Master ST, is required for operation (see page 4/38)</li> <li>• Suitable for use up to SIL 3 (IEC 62061/IEC 61508), PL e (EN ISO 13849-1)</li> <li>• Approved for use with PROFINETIM 155-6 PN Standard and IM 155-6 PN High Feature interface modules, under CPU S7-300F or CPU S7-416F. Further approvals on request.</li> <li>• Coding element type F (included in scope of supply)</li> <li>• Dimensions (W × H × D / mm): 20 × 73 × 58</li> </ul>	<p><b>3RK7136-6SC00-0BC1</b></p>

3RK7136-6SC00-0BC1

#### Accessories

Version	Spring-type terminals Article No.
 <p><b>BaseUnit BU20-P6+A2+4B</b></p> <ul style="list-style-type: none"> <li>• BaseUnit (dark), BU type C1</li> <li>• Suitable for the F-CM AS-i Safety ST fail-safe module</li> <li>• Continuation of an AS-i network, connection with the AS-i voltage of the left-hand module</li> </ul>	<p><b>6ES7193-6BP20-0BC1</b></p>
<p><b>Coding element type F (spare part)</b></p> <ul style="list-style-type: none"> <li>• for ET 200SP modules F-CM AS-i Safety ST, F-DI, F-DQ, F-PM-E</li> <li>• Packing unit 5 items</li> </ul>	<p><b>6ES7193-6EF00-1AA0</b></p>

6ES7193-6BP20-0BC1

Further accessories see page 4/39.

#### More information

##### Manuals

"F-CM AS-i Safety ST Module" manual see  
<http://support.automation.siemens.com/WW/view/en/90265988>.

"SIMATIC ET 200SP BaseUnits" manual see  
<http://support.automation.siemens.com/WW/view/en/59753521>.

"SIMATIC ET 200SP ET 200SP Distributed I/O System" system manual see  
<http://support.automation.siemens.com/WW/view/en/58649293>.

##### Industry Mall

For more information see Industry Mall at "Automation Technology" ⇒ "Industrial Communication" ⇒ "AS-Interface" ⇒ "Masters" ⇒ "Masters for SIMATIC ET 200".



### Overview



DP/AS-i LINK Advanced

PN	DP-M	DP-S	ASI-M		
		●	●		

The DP/AS-i LINK Advanced is a compact network transition between PROFIBUS (DP Slave) and AS-Interface, with the following features:

- Single and double AS-Interface master (according to AS-Interface Specification V3.0) for connection of 62 AS-Interface slaves or 124 AS-Interface slaves (with a double master)
- Integrated analog value transmission (all analog profiles)
- Integrated ground-fault monitoring for the AS-Interface cable
- User-friendly local diagnostics and startup by means of a full graphic display and control keys or through a web interface with a standard browser on the PC screen
- Optimum TIA integration using STEP 7
- Integration in non-Siemens engineering tools using the PROFIBUS GSD file
- Vertical integration (standard web interface) through Industrial Ethernet
- Supply voltage from the AS-Interface shaped cable or alternatively with 24 V DC (optional)
- Suitable for AS-i Power24V (from product version 4 / firmware version 2.2) and for Standard AS-i with 30 V voltage
- Module exchange without entering the connection parameters (e.g. PROFIBUS address) using C-PLUG (optional)

### Design

- Compact plastic enclosure in degree of protection IP20 for standard rail mounting
- COMBICON plug-in screw terminals
- Compact design:
  - Pixel graphics display in the front panel for detailed display of the operating state and readiness for operation of all connected AS-Interface slaves
  - 6 pushbuttons for starting up and testing the AS-Interface line directly on the DP/AS-i LINK Advanced
  - LED indication of the operating state of PROFIBUS DP and AS-Interface
  - Integrated Ethernet port (RJ45 socket) for user-friendly start-up, diagnostics and testing of DP/AS-i LINK Advanced through a web interface using a standard browser
- Small mounting depth thanks to recessed plug mounting
- Operation without fans and batteries

### Functionality

#### Communications

The DP/AS-i LINK Advanced enables a PROFIBUS DP master to cyclically access the I/O data of all the slaves of a lower-level AS-Interface segment. Also supported are the expanded slave types with higher I/O data volume according to AS-i Specification V3.0.

The DP/AS-i LINK Advanced occupies the following address area:

- As a single master: 32 bytes of input data and 32 bytes of output data in which the I/O data of the connected AS-Interface slaves (standard and A/B slaves) of an AS-i line are stored.
- As double master, double the number of bytes
- Optional additional I/O bytes for data from analog slaves

The size of the input/output image can be compressed so that only the actually required I/O address area is occupied in the system of the DP master. The integrated evaluation of analog signals is just as easy as access to digital values because the analog process data also lie directly in the I/O address area of the CPU.

PROFIBUS DP-V1 Masters also provide the option of triggering AS-Interface Master calls over the acyclic PROFIBUS services (e. g. write parameters, amend addresses, read diagnostic values). Using an operating display in AS-i Link it is possible to fully commission the lower-level AS-Interface line.

DP/AS-i LINK Advanced is equipped with an additional Ethernet port which enables use of the integrated web server. The web server can be called up with any standard web browser (e. g. Internet Explorer) without additional software. It allows all diagnostics information to be shown on the PC and the bus configuration and, if applicable, any adjustments, to be displayed. Firmware updates are also possible using this port.

The optional C-PLUG supports module exchange without entering the connection parameters (PROFIBUS address etc.), keeping downtimes to a minimum in the event of a fault.

#### Diagnostics

The following diagnostics is possible using LEDs, the display and control keys, web interface or STEP 7:

- Operating state of the DP/AS-i LINK Advanced
- Status of the link as a PROFIBUS DP slave
- Diagnostics of the AS-Interface network
- Message frame statistics
- Standard diagnostics pages in the web interface for fast diagnostics access through Ethernet using a standard browser
- For the use of the web interfaces no network settings are necessary on the PC (Zeroconf procedure).
- The reporting of diagnostic events is optionally possible via E-Mail or SNMP Trap. The integrated diagnostic buffer saves the events including time stamp.

#### Notes on safety:

The use of this product requires suitable protective measures (e.g. network segmentation for IT security among others) in order to ensure safe plant operation, see [www.siemens.com/industrialsecurity](http://www.siemens.com/industrialsecurity).

#### Configuration

The DP/AS-i LINK Advanced can be configured as follows:

- With STEP 7 as of V5.4: With STEP 7 the AS-Interface configuration can be uploaded in STEP 7. Furthermore, AS-Interface slaves can also be conveniently configured in HW-Config (slave selection dialog).
- By adopting the ACTUAL configuration of the AS-Interface on the display
- Alternatively DP/AS-i LINK Advanced can be integrated into the engineering tool over the PROFIBUS GSD file (e.g. STEP 7 versions below V5.4 or engineering tools from third-party software houses).

## AS-Interface

### Network transitions

#### DP/AS-i LINK Advanced

##### Benefits

- Short startup times through simple configuration at the press of a button and testing of the AS-Interface line using the display or web interface
- Reduction of standstill and servicing times in the event of a slave failure thanks to user-friendly diagnostics using the display or web interface and through simple module exchange with the help of the C-PLUG exchange medium
- Reduced amount of engineering work thanks to user-friendly configuration of Siemens slaves using the slave catalog in HW-Config (STEP 7)
- Costs saved by the double AS-Interface master when large volumes of project data are involved
- Saves the need for AS-i power supply with AS-i Power24V: The AS-Interface cable assembly is fed through an existing 24 V DC PELV power supply unit. For decoupling, an AS-i data decoupling module is required, see power supply units and data decoupling modules.
- Standard mode with AS-Interface power supply (see power supply units and data decoupling modules) possible without restrictions, whereby no further operational voltage is required.

##### Application

The DP/AS-i LINK Advanced is a PROFIBUS DP-V1 slave (according to IEC 61158/IEC 61784) and an AS-Interface master (based on AS-Interface Specification V3.0 according to IEC 62026-2). It enables transparent data access to AS-Interface from PROFIBUS DP.

##### Exchanging data with the PROFIBUS DP master

PROFIBUS DP masters (DP-V0) can exchange I/O data with AS-Interface in cyclic mode. PROFIBUS DP masters with acyclic services (DP-V1) are able in addition to initiate AS-Interface master calls (e.g. reading/writing the AS-i configuration during normal operation). As such, the DP/AS-i LINK Advanced is particularly well suited for a distributed construction and for connection of a lower-level AS-Interface network.

##### Single masters

For applications with typical volumes of project data, it is sufficient to use the DP/AS-i LINK Advanced in its version as an AS-Interface single master. The single master can operate up to 248 DI/248 DO, using 62 A/B slaves with 4 DI/4 DO each.

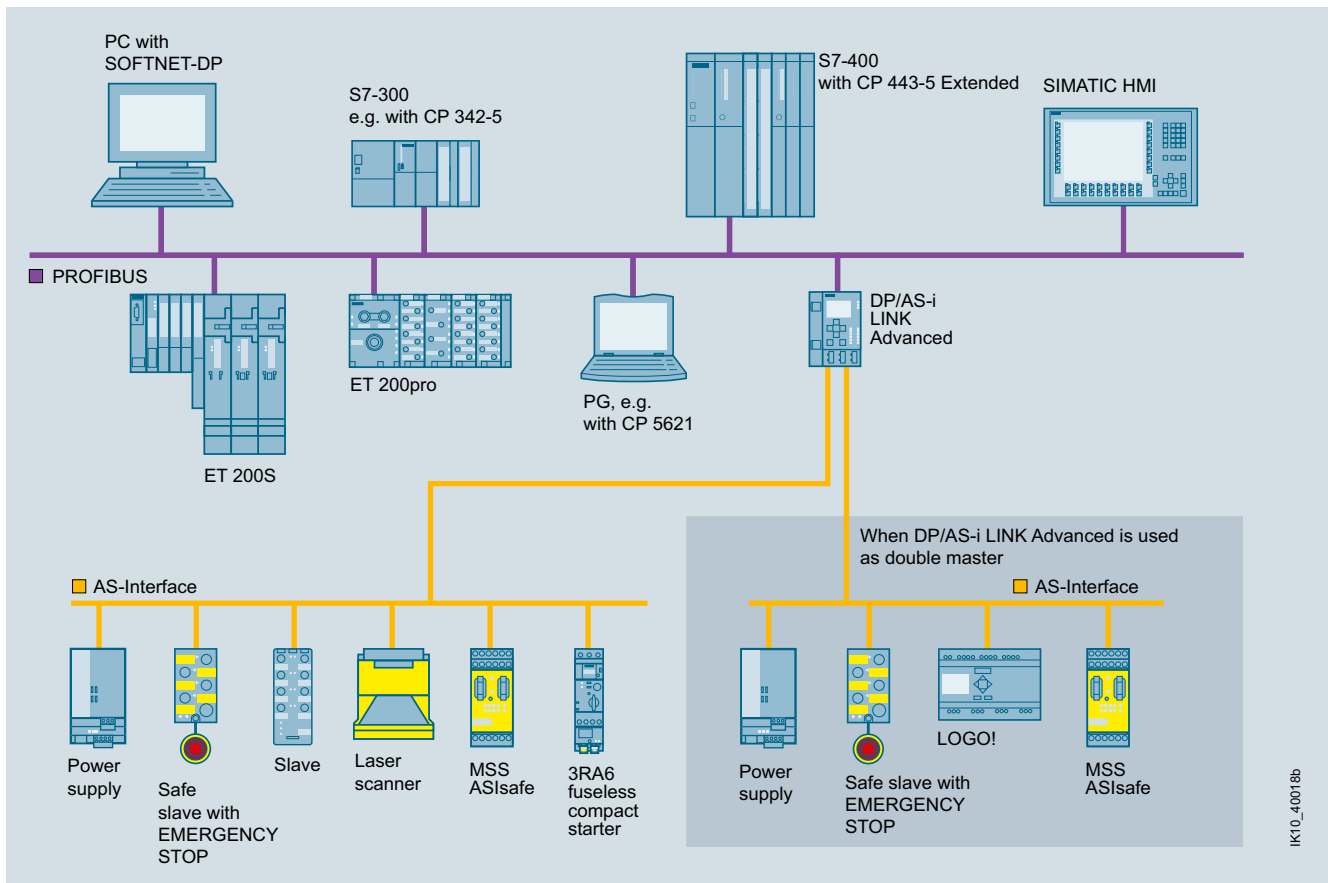

##### Double masters

For applications with large volumes of project data, the DP/AS-i LINK Advanced is used in its version as an AS-Interface double master. In this case, twice the volume of project data can be used on two AS-Interface lines running independently of each other. The double master can operate up to 496 DI/496 DO, using 2 AS-i networks each with 62 A/B slaves with 4DI/4DO each.



Integration of AS-Interface on PROFIBUS through DP/AS-i LINK Advanced as single/double master

### Selection and ordering data

Version		Combicon connection Article No. 
 DP/AS-i LINK Advanced	<b>DP/AS-i LINK Advanced</b> Network transition between PROFIBUS DP and AS-Interface; degree of protection IP20; including COMBICON plug-in screw terminals for connection of an AS-Interface cable (two AS-Interface cables for double masters) and the optional 24 V supply; corresponds to AS-Interface Specification 3.0; dimensions (W x H x D / mm): 90 x 132 x 88.5 <ul style="list-style-type: none"> <li>• Single master with display</li> <li>• Double master with display</li> </ul>	<b>6GK1415-2BA10</b> <b>6GK1415-2BA20</b>
<b>Accessories</b>		
<b>C-PLUG</b> Exchange medium for the simple exchange of devices in the event of a fault; for accommodating configuration and application data, can be used in SIMATIC NET products with a C-PLUG slot		<b>6GK1900-0AB00</b>
<b>PROFIBUS FastConnect Standard Cable GP</b> FastConnect standard type with special design for fast installation, 2-core, shielded		<b>6XV1830-0EH10</b>
<b>PROFIBUS FastConnect RS485 bus connectors with angled cable feeder (35°)</b> With insulation displacement connection, the max. transmission rate is 12 Mbit/s Activatable terminating resistor is integrated <ul style="list-style-type: none"> <li>• Without PG connection socket</li> <li>• With PG connection socket</li> </ul>		<b>6ES7972-0BA60-0XA0</b> <b>6ES7972-0BB60-0XA0</b>
<b>PROFIBUS FastConnect Stripping Tool</b> Preset stripping tool for speedy stripping of PROFIBUS FastConnect bus cables		<b>6GK1905-6AA00</b>
<b>IE FC RJ45 Plug 90</b> RJ45 plug-in connector for Industrial Ethernet, with robust metal enclosure and integrated insulation displacement contacts for connection of Industrial Ethernet FC installation cables; with 90° cable feeder <ul style="list-style-type: none"> <li>• 1 pack = 1 unit</li> <li>• 1 pack = 10 units</li> <li>• 1 pack = 50 units</li> </ul>		<b>6GK1901-1BB20-2AA0</b> <b>6GK1901-1BB20-2AB0</b> <b>6GK1901-1BB20-2AE0</b>

### More information

Manuals see

<http://support.automation.siemens.com/WWW/view/en/28602701/133300>.

AS-i block library for PCS 7 for easy connection of AS-Interface to PCS 7 see

- Catalog IC 10, Chapter 14 "Parameterization, Configuration and Visualization with SIRIUS" ⇒ "AS-Interface Block Library for SIMATIC PCS 7"
- Industry Mall: "Automation Technology"  
 ⇒ "Industrial Controls"  
 ⇒ "Parameterization, Configuration and Visualization with SIRIUS"  
 ⇒ "AS-Interface Block Library for SIMATIC PCS 7"

## AS-Interface

### Network transitions

#### DP/AS-Interface Link 20E

#### Overview



DP/AS-Interface Link 20E

PN	DP-M	DP-S	ASI-M		
		●	●		

DP/AS-Interface Link 20E connects PROFIBUS DP to AS-Interface and has the following features:

- PROFIBUS DP slave and AS-Interface master
- Up to 62 AS-Interface slaves, each with 4 digital inputs and 4 digital outputs as well as analog slaves can be connected
- Integrated analog value transmission (all analog profiles)
- Supports all AS-Interface master functions according to the AS-Interface Specification V3.0
- Supply from AS-Interface cable; hence no additional power supply required
- Suitable for AS-i Power24V (from product version 2 / firmware version 3.1) and for Standard AS-i with 30 V voltage
- Supports the uploading of the AS-Interface configuration in STEP 7 V5.2 and higher

#### Design

- Compact plastic enclosure in degree of protection IP20 for standard rail mounting
- LEDs in the front panel for indicating the operating state and functional readiness of all connected slaves
- Setting of PROFIBUS DP address is possible by pressing a button
- LED indication of the PROFIBUS DP slave address, DP bus faults and diagnostics
- Two pushbuttons for switching over the operating state and for adopting the existing ACTUAL configuration as the DESIRED configuration

#### Functionality

##### Communications

The DP/AS-Interface Link 20E enables a DP master to access all the slaves of an AS-Interface network.

The DP/AS-Interface Link 20E occupies a standard 32 bytes of input data and 32 bytes of output data in which the digital I/O data of the connected AS-Interface slaves (standard and A/B slaves) of an AS-i line are stored.

The size of the input/output image can be compressed so that only the actually required I/O address area is occupied in the system of the DP master.

The analog I/O data can be accessed with the S7 system functions for read/write data records.

##### Configuration

The DP/AS-Interface Link 20E is configured as follows:

- With STEP 7 as of Version V5.1 SP2:  
With STEP 7 configuring the AS-Interface configuration can be uploaded in STEP 7 V5.2 and higher. Furthermore, AS-Interface slaves from Siemens can also be conveniently configured in HW Config (slave selection dialog).
- By adopting the ACTUAL configuration of the AS-Interface by using the SET pushbutton on the front panel
- Alternatively, DP/AS-Interface Link 20E can be integrated by means of the PROFIBUS GSD file in the engineering tool (e.g. for STEP 7 V5.1 and lower or for non-Siemens engineering tools).

#### Benefits

- Reduction of installation costs because the power is supplied entirely via the AS-Interface cable, which means that no additional power supply is required.
- Short startup times thanks to easy configuration at the touch of a button
- The LED indicators help reduce downtime and service times if a slave fails.
- Easy and fast startup through reading out the AS-Interface configuration

#### Application

The DP/AS-Interface Link 20E is a PROFIBUS DP slave (according to IEC 61158 / IEC 61784) and an AS-Interface master (according to IEC 62026-2). It enables the AS-Interface to be operated on PROFIBUS DP.

DP/AS-Interface Link 20E can operate up to 248 DI/248 DO when using 62 A/B slaves with 4DI/4DO each.

PROFIBUS DP masters (DP-V0) can exchange digital I/O data cyclically with the AS-Interface.

PROFIBUS DP masters with acyclic services (DP-V1) are also able to exchange analog I/O data and initiate AS-Interface master calls (e. g. reading/writing the AS-i configuration during normal operation).

**Application** (continued)

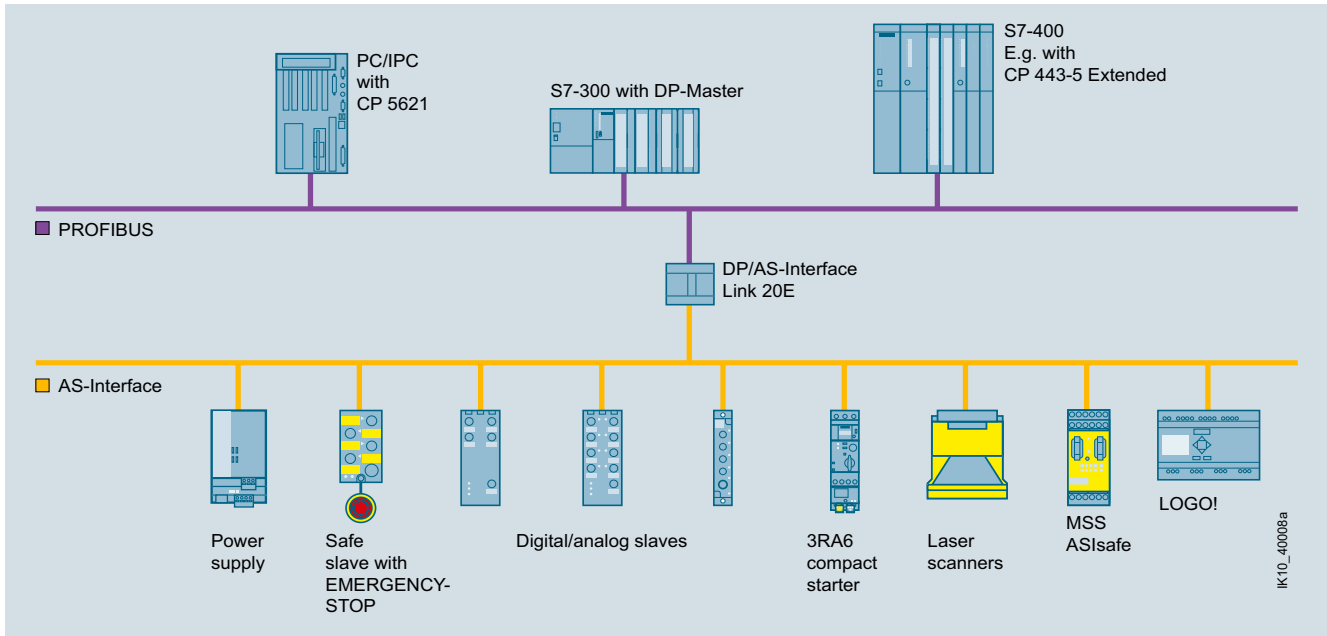

Transition from PROFIBUS DP to AS-Interface using DP/AS-Interface Link 20E

**Selection and ordering data**

Version		Screw terminals Article No.
 <p><b>DP/AS-Interface Link 20E</b> Network transition between PROFIBUS DP and AS-Interface in degree of protection IP20; including screw terminals for connection of the AS-Interface cable; corresponds to AS-Interface Specification V3.0; dimensions (W x H x D / mm): 90 x 80 x 60 (dimensions without fixing lugs)</p>		<b>6GK1415-2AA10</b>
<p>6GK1 415-2AA10 <i>Accessories</i></p>	<p><b>PROFIBUS FC Standard Cable GP</b> FastConnect standard type with special design for fast installation, 2-core, shielded</p>	<b>6XV1830-0EH10</b>
<p><b>PROFIBUS FastConnect</b> With insulation displacement connection, the max. transmission rate is 12 Mbit/s. Activatable terminating resistor is integrated.</p> <ul style="list-style-type: none"> <li>• RS485 bus connector with 90° cable feeder                     <ul style="list-style-type: none"> <li>- Without PG connection socket</li> <li>- With PG connection socket</li> </ul> </li> <li>• RS485 bus connector with angled cable feeder (35°)                     <ul style="list-style-type: none"> <li>- Without PG connection socket</li> <li>- With PG connection socket</li> </ul> </li> </ul>	<p><b>6ES7972-0BA52-0XA0</b> <b>6ES7972-0BB52-0XA0</b> <b>6ES7972-0BA60-0XA0</b> <b>6ES7972-0BB60-0XA0</b></p>	
<p><b>PROFIBUS FastConnect Stripping Tool</b> Preset stripping tool for speedy stripping of PROFIBUS FastConnect bus cables</p>	<b>6GK1905-6AA00</b>	

**More information**

Manuals see  
<http://support.automation.siemens.com/WWW/view/en/28602858/133300>.

## AS-Interface

### Network transitions

#### DP/AS-i F-Link

#### Overview



DP/AS-i F-Link

PN	DP-M	DP-S	ASI-M		
		●	●		

The DP/AS-i F-Link is a compact, safety-related network transition between PROFIBUS (DP Slave) and AS-Interface, with the following features:

- Monitoring the inputs of safety-related digital AS-i slaves (ASIsafe slaves) and forwarding of data through PROFIsafe. No additional safety-related components required for the AS-Interface (e. g. MSS ASIsafe Modular Safety System)
- Can be used up to PL e according to EN ISO 13849-1 and to SIL 3 according to IEC 62061/IEC 61508.
- Connection of up to 62 AS-Interface slaves
- Supports all AS-Interface master functions according to the AS-Interface Specification V3.0
- Typically easy transmission of non-safety-related input/output data of all AS-i slaves
- Integrated analog value transmission (all analog profiles)
- Direct integration in PROFIBUS networks.  
Optional integration in PROFINET environments through PROFINET/PROFIBUS gateway (IE/PB Link PN IO) or through SIMATIC S7-315/317/319 F PN/DP or S7-416F-3 PN/DP
- Connection to ET 200S with IM-F-CPU using DP master module is possible
- Optimum TIA integration in STEP 7 using Object Manager, integration in non-Siemens engineering tools using PROFIBUS GSD file
- Local diagnostics using LEDs and display with control keys

#### Design

- Rugged, slim plastic enclosure, degree of protection IP20, for standard mounting rail or wall mounting (with adapter)
- Compact design:
  - LEDs in the front panel for indicating the operating state and functional readiness of all connected slaves
  - 2 buttons on the front for start-up and call-up of diagnostics information
  - 4 LEDs for display of the operating state of the device, of PROFIBUS DP and the AS-Interface network
  - Front PROFIBUS DP connection with sub D connector
  - Removable terminal blocks for connection of AS-i +/- and control supply voltage (over 24 V DC PELV power supply unit)
  - Narrow width (45 mm)
- Operation without fans and batteries
- Fast device replacement in the event of a fault

#### Functionality

##### Communication principle

The PROFIBUS DP master or the safe control communicates with the AS-Interface slaves over the DP/AS-i F-Link. The AS-Interface process data are mapped in different data areas for non-safety-related input and output data and safety-related input data.

##### Diagnostics

Extensive diagnostics is possible using the four LEDs, display and control keys or SIMATIC S7. Further details can be found in the manual.

#### Configuration

The DP/AS-i F-Link is configured as follows:

- With STEP 7 as of Version V5.4 SP1: In particular, Siemens AS-Interface slaves can be conveniently configured via the slave selection dialog.
- Uploading the actual configuration of an already configured AS-Interface network in a STEP 7 project is possible.
- Alternatively, DP/AS-i F-Link can be integrated by means of the PROFIBUS GSD file in the engineering tool  
As a startup aid, it is also possible to adopt the ACTUAL configuration in the appliance storage device directly on the appliance to activate the AS-interface slaves.

#### Programming

In contrast to the MSS ASIsafe Modular Safety System, the DP/AS-i F-Link is a pure gateway, which does not run through its own safety logic. Programming of the safety function is implemented at the level of the higher-level fail-safe PLC, e. g.:

- With Distributed Safety, Version V5.4 SP1 or higher for SIMATIC S7-300F/416F
- With the SAFETY INTEGRATED "SI-Basic" or "SI-COMFORT NCU" software for SINUMERIK 840D pl/sl

The safety and standard range can access the digital and analog I/O data of the connected AS-Interface slaves directly through the I/O address area of the CPU.

### Benefits

- Gaps in (bus-based) safety technology closed: safety-related signals (EMERGENCY-STOP, door interlock, light curtains etc.) collected with AS-i and transferred to higher-level F-PLC. This enables:
  - Quick installation, easy commissioning: benefits of AS-i can now be systematically leveraged in the field for Safety Integrated.
  - Cost-effective solution as ASIsafe is ideally suited for the collection of "fewer but more distributed fail-safe bits"
- Price advantage: As a fully fledged AS-i master according to Specification V3.0, more inputs and outputs can be used, e.g.:
  - Up to 248 DI/248 DO when using 62 A/B slaves with 4DI/4DO each
  - Up to 62 digital or analog slaves
- Investment protection:
  - Connection to PROFIBUS networks, such as DP/AS-i LINK Advanced or DP/AS-Interface Link 20E
  - Downward compatibility to AS-Interface Specification V2
  - Open for modern automation concepts with AS-i
- Teaching the code sequences of ASIsafe slaves is possible at the press of a button
- Reduced amount of engineering work thanks to user-friendly configuration of all AS-i slaves from Siemens using the slave selection dialog in HW-Config (STEP 7), including setting the F-parameter of the ASIsafe slaves modeled on PROFIsafe slaves
- Cost-savings thanks to programming of the safety logic with the familiar, powerful commands of the distributed safety packages from the fail-safe SIMATIC PLC in F-FBD or F-LAD, incl. TUV-certified function blocks for typical safety applications
- Use in machine tools under SINUMERIK 840 D (pl/sl) possible
- Reduction of standstill and servicing times in the event of a slave failure thanks to user-friendly diagnostics using the display and through simple module exchange (only a few settings by control keys are required, without use of the configuring tool)

### Application

#### Links between PROFIsafe and ASIsafe

The DP/AS-i F-Link is a PROFIBUS DP-V1 slave (according to IEC 61158 and IEC 61784) and an AS-Interface master (based on AS-Interface Specification V3.0 according to IEC 62026-2). It enables transparent data access to AS-Interface from PROFIBUS DP. The DP/AS-i F-Link is also an AS-i master with which safety-related input data can be passed from ASIsafe slaves via the PROFIsafe protocol to a fail-safe CPU with PROFIBUS DP master. No additional safety cabling or monitoring is required (in particular no MSS ASIsafe Modular Safety System).

The transmission of binary values or analog values is possible depending on the slave type. All slaves according to AS-Interface Specification V2.0, V2.1 or V3.0 can be used as AS-i slaves.

PROFIBUS DP masters according to DP-V0 or DP-V1 can exchange I/O data with lower-level AS-i slaves in cyclic mode. PROFIBUS DP masters with acyclic services according to DP-V1 are able in addition to initiate AS-i command calls (e.g. reading/writing the AS-i configuration during normal operation). In addition to digital I/O data, analog data can also be saved with high performance in the cyclic I/O of a fail-safe S7-300/S7-416 F-CPU.

In configuring mode the DP/AS-i F-Link reads in the configuration data of the peripherals on the AS-Interface. Slave addresses can be set using the display and the control keys, and the code sequences of safe AS-i slaves can be taught.

During operation, four display LEDs and the display provide detailed diagnostics information, which directly localizes the fault if required. Using the PLC user program it is possible to read out diagnostics data records and make them available to a higher-level operating and monitoring system (e. g. WinCC Flexible or TRANSLINE HMI).

# AS-Interface

## Network transitions

### DP/AS-i F-Link

#### Application (continued)

#### Network connectivity

The DP/AS-i F-Link can be used in PROFIBUS and PROFINET networks as follows:

4

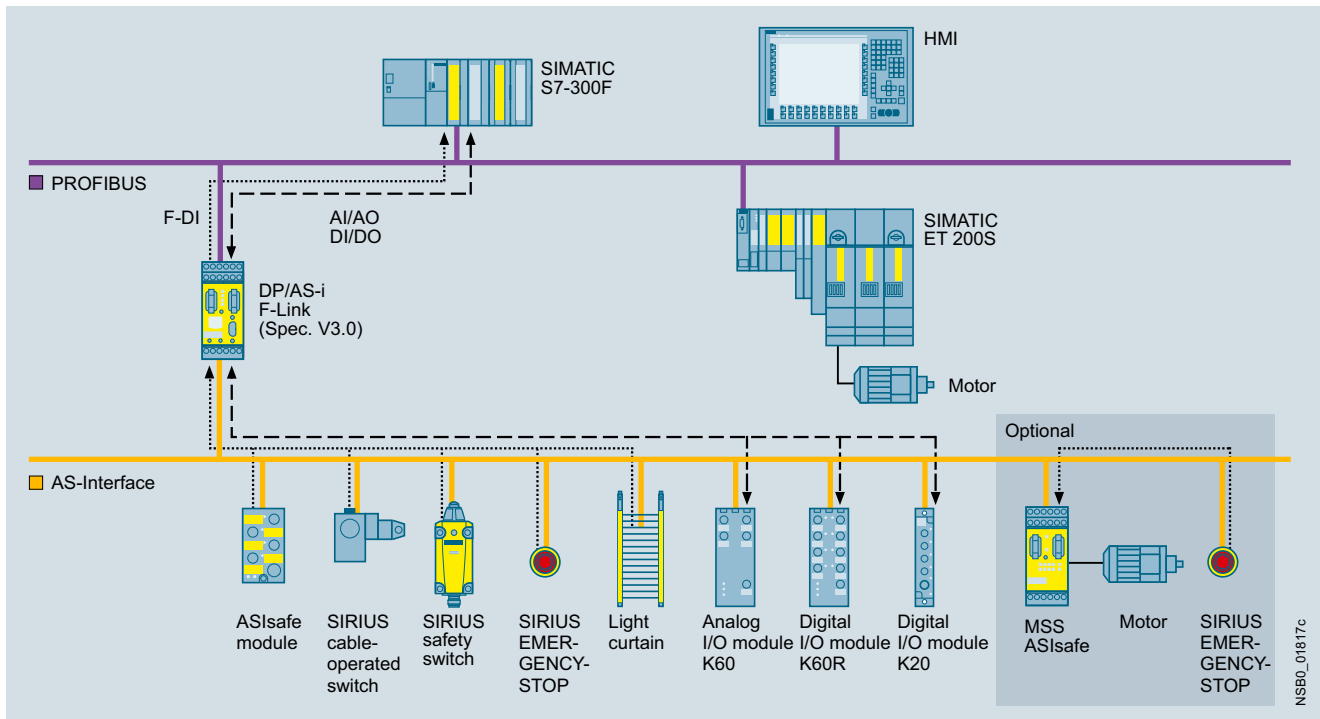

Integration in PROFIBUS networks under SIMATIC F-PLC

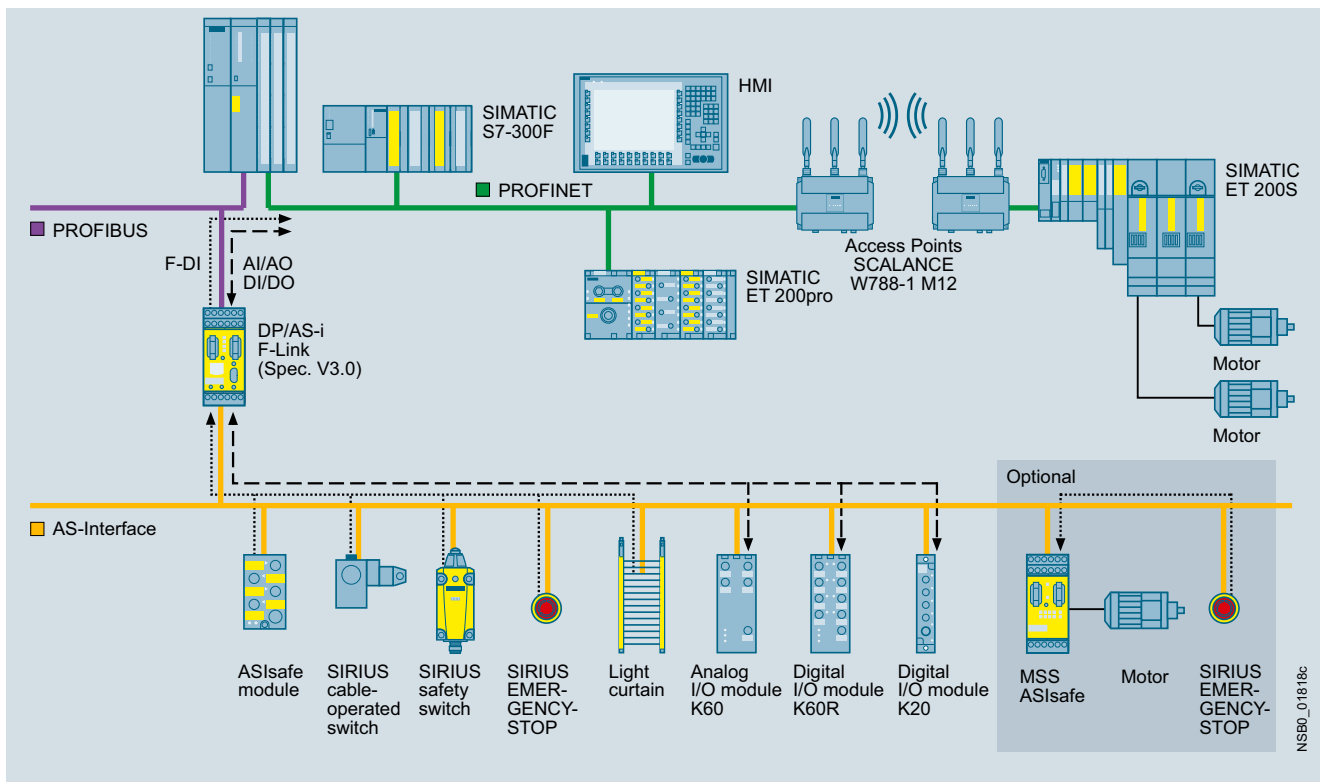

Integration in PROFINET networks under SIMATIC F-PLC (alternatively through IE/PB Link)





### Application (continued)

#### Further network connectivity options

- Integration in PROFINET networks under SIMATIC F PLC through IE/PB Link
- Integration in SINUMERIK Power Line and Solution Line
- Integration under non-Siemens fail-safe control systems using PROFIBUS GSD file, see <http://support.automation.siemens.com/WW/view/en/113250>

### Selection and ordering data

Version		Article No.
 <p>DP/AS-i F-Link</p>	<p><b>DP/AS-i F-Link</b></p> <p>Network transition between PROFIBUS DP and AS-Interface for safety-related data transmission from ASIsafe to PROFIBUS DP – PROFIsafe in degree of protection IP20; corresponds to AS-Interface Specification V3.0; not approved for AS-i Power24V; dimensions (W x H x D / mm): 45 x 104 x 120</p> <ul style="list-style-type: none"> <li>• With screw terminals</li> <li>• With spring-type terminals</li> </ul>	<div style="display: flex; align-items: center;"> <div style="margin-right: 10px;">    </div> <div> <p><b>3RK3141-1CD10</b></p> <p><b>3RK3141-2CD10</b></p> </div> </div>

### More information

For more accessories for the PROFIBUS connection see page 4/47.

For the DP/AS-i F-Link manual see <http://support.automation.siemens.com/WW/view/en/24196041>.

Circuit examples for safety systems with DP/AS-i F-Link see <http://support.automation.siemens.com/WW/view/en/24509484>.

The F-Link Object Manager must be installed for configuration with STEP 7 / HW-Config, see <http://support.automation.siemens.com/WW/view/en/24724923>.

## AS-Interface

### Network transitions

#### IE/AS-i LINK PN IO

#### Overview



IE/AS-i LINK PN IO

PN	DP-M	DP-S	ASI-M		
●			●		

The IE/AS-i LINK PN IO is a compact network transition between PROFINET/Industrial Ethernet (PROFINET IO Device) and AS-Interface, with the following features:

- Single and double AS-Interface master (according to AS-Interface Specification V3.0) for connection of 62 AS-Interface slaves or 124 AS-Interface slaves (with a double master)
- Integrated analog value transmission (all analog profiles)
- Integrated ground-fault monitoring for the AS-Interface cable
- User-friendly local diagnostics and startup by means of a full graphic display and control keys or through a web interface with a standard browser on the PC screen
- Optimum TIA integration using STEP 7
- Integration in non-Siemens engineering tools using the PROFINET GSD file
- Vertical integration (standard web interface) through Industrial Ethernet
- Supply via AS-Interface cable or with 24 V DC
- Suitable for AS-i Power24V (from product version 4 / firmware version 2.2) and for AS-Interface with 30 V voltage
- Module exchange without entering the connection parameters (IP address etc.) using C-PLUG (optional)
- Costs saved by the double AS-Interface master when large volumes of project data are involved

#### Design

- Compact plastic enclosure in degree of protection IP20 for standard rail mounting
- COMBICON plug-in screw terminals
- Compact design:
- Pixel graphics display in the front panel for detailed display of the operating state and readiness for operation of all connected AS-Interface slaves
- Six pushbuttons for starting up and testing the AS-Interface line directly on the IE/AS-i LINK PN IO
- LED display of the operating state of PROFINET IO and AS-Interface
- Integrated 2-port switch (RJ45 socket) for connection to Industrial Ethernet
- Small mounting depth thanks to recessed plug mounting
- Operation without fans and batteries

#### Functionality

##### Communications

The IE/AS-i LINK PN IO enables a PROFINET IO controller to cyclically access the I/O data of all the slaves of a lower-level AS-Interface segment. Also supported are the expanded slave types with higher I/O data volume according to AS-i Specification V3.0.

The IE/AS-i LINK PN IO occupies the following address area:

- As a single master with full expansion: 62 bytes of input data and 62 bytes of output data in which the I/O data of the connected AS-Interface slaves (standard and A/B slaves) of an AS-i line are stored.
- As double master, double the number of bytes
- Optional additional I/O bytes for data from analog slaves

The size of the input/output image can be compressed so that only the actually required I/O address area is occupied in the system of the IO controller.

The integrated evaluation of analog signals is just as easy as access to digital values because the analog process data also lie directly in the I/O address area of the CPU.

PROFINET IO controllers are able in addition to initiate AS-Interface master calls (e. g. to write parameters, change addresses, read diagnostic values) through the acyclic PROFINET services.

Using an operating display in AS-Interface Link it is possible to fully commission the lower-level AS-i line.

The IE/AS-i LINK PN IO is equipped with two Ethernet ports which are connected by an internal switch. With the Ethernet it is possible in addition to use the integrated web server. The web server can be called up with any standard web browser (e. g. Internet Explorer) without additional software. It enables the PC to present all diagnostics information and to display the set bus configuration and parameters as well as their adaptation where applicable. Firmware updates are also possible using this port.

The optional C-PLUG supports module exchange without entering the connection parameters (e. g. IP address), keeping downtimes to a minimum in the event of a fault.

##### Diagnostics

The following diagnostics is possible using the display and control keys, web interface or STEP 7:

- Operating state of the IE/AS-i LINK PN IO
- Status of the link as a PROFINET IO device
- Diagnostics of the AS-Interface network
- Message frame statistics
- Standard diagnostics pages in the web interface for fast diagnostics access through Ethernet using a standard browser
- The reporting of diagnostic events is optionally possible via E-Mail or SNMP Trap. The integrated diagnostic buffer saves the events including time stamp.

##### Notes on safety:

The use of this product requires suitable protective measures (e.g. network segmentation for IT security among others) in order to ensure safe plant operation, see [www.siemens.com/industrialsecurity](http://www.siemens.com/industrialsecurity).

##### Configuration

The IE/AS-i LINK PN IO is configured as follows:

- STEP 7 V5.4 or higher is required for configuring the full functional scope of the IE/AS-i LINK PN IO. With STEP 7 configuring the AS-Interface configuration can be uploaded in STEP 7 V5.4 SP2 and higher. Furthermore, AS-Interface slaves from Siemens can also be conveniently configured in HW Config (slave selection dialog).
- Alternatively, IE/AS-i LINK PN IO can be integrated by means of the PROFINET GSD file in the engineering tool (e. g. for STEP 7 V5.4 SP2 and lower, TIA portal, or for non-Siemens engineering tools).

### Benefits

- Short startup times through simple configuration at the press of a button and testing of the AS-Interface line using the display or web interface
- Reduction of standstill and servicing times in the event of a slave failure thanks to user-friendly diagnostics using the display or web interface
- Costs saved by the double AS-Interface master when large volumes of project data are involved
- Saves the need for AS-i power supply with AS-i Power24V: The AS-Interface cable assembly is fed through an existing 24 V DC PELV power supply unit. For decoupling, an AS-i data decoupling module is required, see power supply units and data decoupling modules.
- Standard mode with AS-Interface power supply (see power supply units and data decoupling modules) possible without restrictions, whereby no further operational voltage is required

### Application

The DP/AS-i LINK PN IO is a PROFINET IO device (according to IEC 61158/IEC 61784) and an AS-Interface master (based on AS-Interface Specification V3.0 according to IEC 62026-2). It enables transparent data access to AS-Interface from Industrial Ethernet.

#### Exchanging data with PROFINET IO controllers

PROFINET IO controllers can exchange I/O data with AS-Interface in cyclic mode and can perform AS-i master calls in addition with acyclic services (e.g. reading/writing the AS-i configuration during normal operation). IE/AS-i LINK PN IO is, therefore, suitable for distributed configurations and for integrating a lower-level AS-Interface network.

#### Single masters

For applications with typical volumes of project data, it is sufficient to use the IE/AS-i LINK PN IO in its version as an AS-i single master. The single master can operate up to 248 DI/248 DO, using 62 A/B slaves with 4DI/4DO each.

#### Double masters

For applications with large volumes of project data, the IE/AS-i LINK PN IO is used in its version as an AS-i double master. In this case, twice the volume of project data can be used on two AS-i lines running independently of each other. The double master can operate up to 496 DI/496 DO, using 2 AS-i networks with 62 A/B slaves each with 4DI/4DO each.

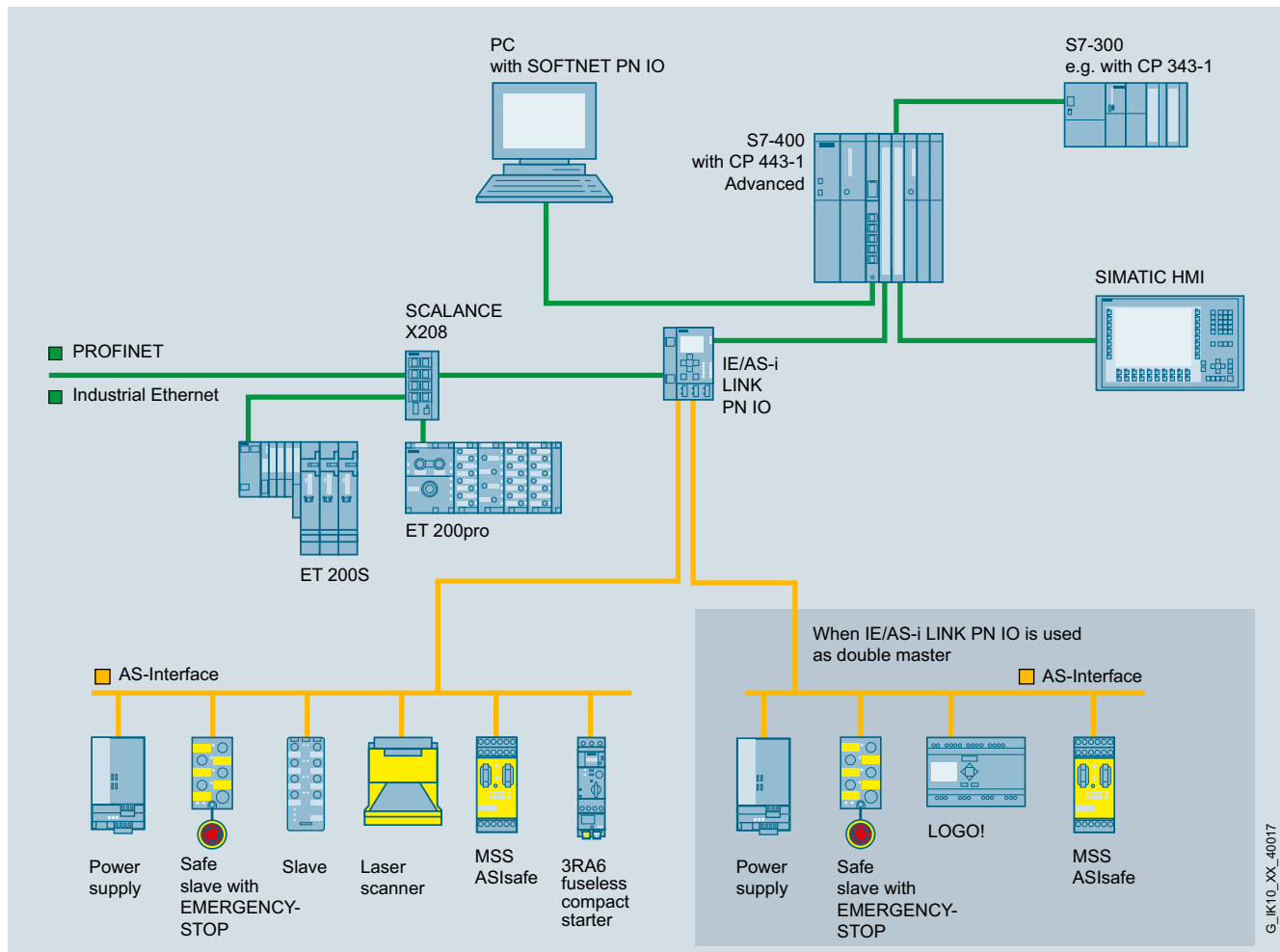

Integration of AS-Interface on PROFINET through IE/AS-i LINK PN IO as single/double master

## AS-Interface

### Network transitions

#### IE/AS-i LINK PN IO

#### Application (continued)

##### Wireless communication

Using an upstream IWLAN client module, e.g. SCALANCE W748-1 RJ45, an AS-Interface line can be integrated in the PROFINET world by wireless means.

Sample uses are applications which up to now have been performed with fault-prone tow chain or collector wire technology. Maintenance costs are thus reduced.

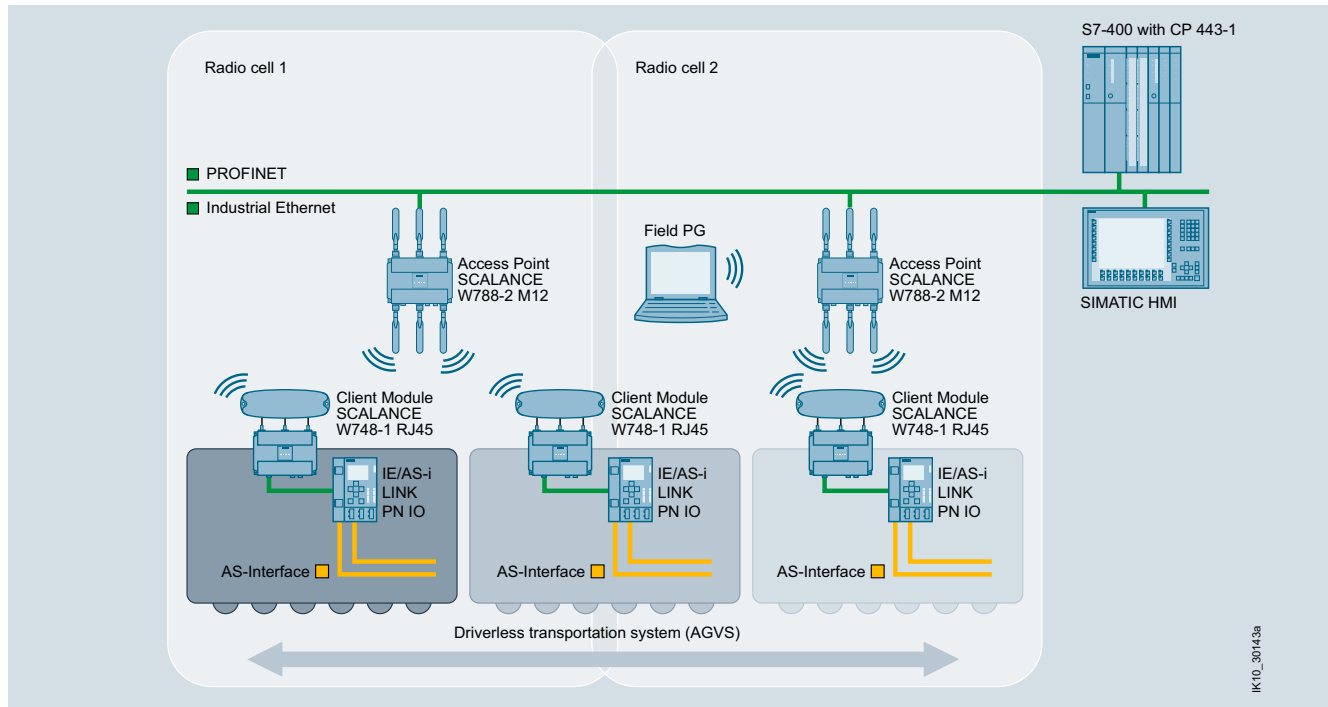

Wireless communication between Industrial Ethernet and AS-Interface components

#### Selection and ordering data

Version	Combicon connection Article No.
 <p><b>IE/AS-i LINK PN IO</b></p> <p>Network transition between PROFINET/Industrial Ethernet and AS-Interface in degree of protection IP20; including COMBICON plug-in screw terminals for connecting an AS-Interface cable (two AS-Interface cables for a double master) and the optional 24 V supply; corresponds to AS-Interface Specification 3.0; dimensions (W x H x D / mm): 90 x 132 x 88.5</p> <ul style="list-style-type: none"> <li>• Single master with display</li> <li>• Double master with display</li> </ul>	<p><b>6GK1411-2AB10</b></p> <p><b>6GK1411-2AB20</b></p>
<p><b>Accessories</b></p> <p><b>C-PLUG</b></p> <p>Exchange medium for the simple exchange of devices in the event of a fault; for accommodating configuration and application data; can be used in SIMATIC NET products with a C-PLUG slot</p> <p><b>IE FC RJ45 Plug 90</b></p> <p>RJ45 plug-in connector for Industrial Ethernet, with robust metal enclosure and integrated insulation displacement contacts for connection of Industrial Ethernet FC installation cables; with 90° cable feeder</p> <ul style="list-style-type: none"> <li>• 1 pack = 1 unit</li> <li>• 1 pack = 10 units</li> <li>• 1 pack = 50 units</li> </ul>	<p><b>6GK1900-0AB00</b></p> <p><b>6GK1901-1BB20-2AA0</b></p> <p><b>6GK1901-1BB20-2AB0</b></p> <p><b>6GK1901-1BB20-2AE0</b></p>

#### More information

Manuals see  
<http://support.automation.siemens.com/WWW/view/en/29992487/13330>.

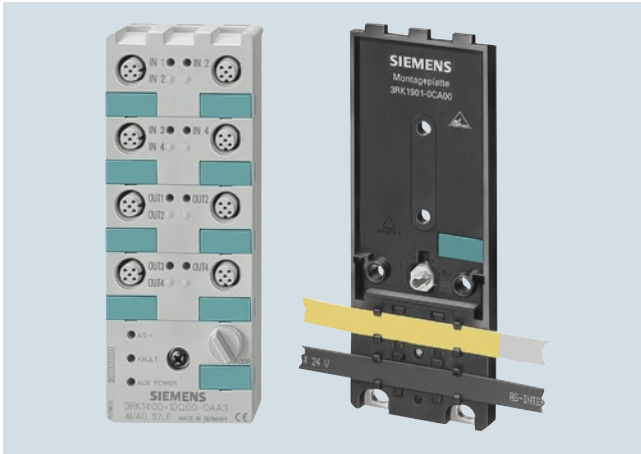
**Overview**

K60



K20



K45

Three coordinated series of AS-Interface compact modules with digital and analog compact modules and a high degree of protection are available for use in the field:

- Series K60 (digital and analog)
- Series K45 (digital)
- Series K20 (digital)

All compact modules are characterized by particularly simple handling. The K60 and K45 modules are mounted with a mounting plate. The mounting plate is used to mount the AS-Interface flat cables and enables mounting on a wall or standard mounting rail.

The particularly narrow K20 modules are directly mounted without a mounting plate and connected to the AS-Interface using a round cable.

**Connection types**

For flexible connection of different sensors and actuators, the following PIN assignments are available on the I/O modules with M12 sockets:

**Standard assignment**

With the standard assignment, one sensor/actuator is connected per M12 socket. In this case the signal for the outputs is acquired at PIN4 while the signal for the inputs is acquired at PIN4 and PIN2. As the result, sensors can be connected directly to PIN2 and PIN4.

**Y assignment**

With the Y assignment, two sensors or two actuators can be connected to one M12 socket. In this case, both PIN4 and PIN2 are provided for one sensor signal and one actuator signal on each M12 socket.

**Y-II assignment**

The Y-II assignment offers the following options:

- Individual connection of a sensor/actuator to one M12 socket
- Connection of two sensors/actuators to one M12 socket as follows:
  - The signal of the first sensor/actuator is connected to PIN4 of the first socket.
  - The signal of the second sensor/actuator is connected to PIN2 of the first socket and to PIN4 of the second socket. In this case, the second socket is not required and is closed with a sealing cap.

**Overview of digital compact modules**

The following table provides an overview of the important features of the digital compact modules.

Version	K60	K45	K20
8 inputs/2 outputs	✓	--	--
8 inputs	✓	--	--
4 inputs/4 outputs	✓	✓	✓
4 inputs/3 outputs	✓	--	--
4 inputs/2 outputs	✓	--	--
4 inputs	✓	✓	✓
2 inputs/2 outputs	--	✓	✓
4 outputs	✓	✓	✓
3 outputs	--	✓	--
AS-Interface connection	Flat cable / round cable	Flat cable	Round cable
I/O connection method	M12	M12/M8	M12/M8
Pin assignment	Standard/Y-II/Y	Standard/Y	Standard/Y
Degree of protection	IP65/IP67/IP68/IP69K	IP65/IP67	IP65/IP67
ATEX 3D (Zone 22)	✓	--	--
Extended address mode	✓	✓	✓

✓ Available

-- Not available

## AS-Interface

Slaves

I/O modules for use in the field, high degree of protection

### Digital I/O modules IP67 – K60

#### Overview

The K60 digital AS-Interface compact modules are characterized by optimized handling characteristics and user-friendliness. They permit the mounting times and startup times of AS-Interface to be reduced by up to 40 %.

#### **Mounting and connection of the AS-Interface shaped cables**

Assembly of the K60 modules is performed with a mounting plate which accommodates the AS-Interface shaped cables. Two different mounting plates are offered for

- Wall mounting
- Standard rail mounting

The mounting plate and the compact module are joined together by means of a screw, with simultaneous contacting of the AS-Interface cable by the service-proven insulation piercing method.

#### **Addressing and connection of the sensors/actuators**

Addressing of the K60 modules is performed using an addressing socket integrated in the compact module. The addresses can also be assigned after installation.

#### K60 modules with a maximum of four digital inputs and outputs

These compact modules contain the M12 standard connections for inputs and outputs. Using M12 standard connectors, a maximum of four sensors and four actuators can be connected to the compact module.

#### K60 compact modules with a maximum of eight digital inputs

These modules have eight digital inputs for connection through M12 plugs.

The module requires two AS-Interface addresses for processing all eight inputs. The addressing can thus be performed through a double addressing socket integrated in the module.

#### K60 compact modules with four digital inputs and outputs according to AS-Interface Specification 3.0

The extended address mode (A/B addresses) AS-Interface Specification 3.0 enables the connection of up to 62 slaves on one AS-Interface network. With the extended address mode, four outputs are now possible even with A/B slaves (instead of only three outputs possible up to now with Specification 2.1). Hence with full expansion of an AS-Interface network, there are now 248 inputs as well as 248 outputs available on one AS-i network.

Please note, however,

- that these modules can be used only with a master according to AS-i Specification 3.0
- that the cycle times for the outputs may be up to 20 ms.

#### **K60 data couplers**

An AS-Interface data coupler has been added to the K60 compact module range. Integrated in this module are two AS-i slaves which are connected to two different AS-i networks. Each of the two integrated slaves has four virtual inputs and four virtual outputs. The bidirectional data transmission of four data bits between two AS-i networks is thus possible in a simple and cost-effective manner. The data coupler need its own address in each AS-i network.

Each AS-i network works with a different cycle time depending on the number of stations. Hence two AS-i networks are not necessarily synchronous. For this reason the AS-i data coupler can be used to transmit only standard data and no safety data.

#### **K60 compact modules for use in hazardous areas (ATEX)**

Two versions of the K60 modules are available for operation in Zone 22 hazardous areas according to Classification II 3D (dusty atmosphere, non-conductive dust). The version with four inputs and four outputs has the designation (Ex) II 3D Ex tD A22 IP65X T75°C and the version with four inputs has the designation (Ex) II 3D Ex tD A22 IP65X T60°C.

Special conditions have to be observed for the safe operation of these devices. In particular the module must be protected by suitable measures from mechanical damage.



#### More information

For other conditions for safe operation see <http://support.automation.siemens.com/WW/view/en/18290447>.

## Selection and ordering data

Version						Article No.
 3RK 1400-1DQ00-0AA3	<b>Digital I/O modules, IP67 - K60</b>					
	<ul style="list-style-type: none"> <li>• PNP transistor</li> <li>• Width 60 mm</li> <li>• Connection method: M12</li> <li>• Modules supplied without mounting plate</li> </ul>					
	Type	Current carrying capacity of outputs	Slave type	Pin assignment	Sensor power supply off	
	8 inputs/ 2 outputs <sup>1)</sup>	2 A	A/B	Special	AS-i	<b>3RK2400-1HQ00-0AA3</b>
	8 inputs <sup>1)</sup>	--	Standard	Y-II	AS-i	<b>3RK1200-0DQ00-0AA3</b>
		--	A/B	Y-II	AS-i	<b>3RK2200-0DQ00-0AA3</b>
		--	A/B	Y-II	$U_{aux}$	<b>3RK2200-1DQ00-1AA3</b>
	4 inputs/ 4 outputs	2 A	Standard	Y-II	AS-i	<b>3RK1400-1DQ00-0AA3</b>
		2 A	Standard	Standard	AS-i	<b>3RK1400-1CQ00-0AA3</b>
		1 A	Standard	Y-II	AS-i	<b>3RK1400-1DQ01-0AA3</b>
		1 A	Standard	Standard	AS-i	<b>3RK1400-1DQ03-0AA3</b>
		2 A	A/B (Spec. 3.0)	Y-II	AS-i	<b>3RK2400-1DQ00-0AA3</b>
		2 A	A/B (Spec. 3.0)	Y-II	$U_{aux}$	<b>3RK2400-1DQ00-1AA3</b>
	4 inputs/ 3 outputs	2 A	A/B	Y-II	AS-i	<b>3RK2400-1FQ03-0AA3</b>
	4 inputs/ 2 outputs	2 A	Standard	Y-II	AS-i	<b>3RK1400-1MQ00-0AA3</b>
4 inputs	--	Standard	Y-II	AS-i	<b>3RK1200-0CQ00-0AA3</b>	
	--	A/B	Y-II	AS-i	<b>3RK2200-0CQ00-0AA3</b>	
2x2 inputs/ 2x2 outputs	1 A	Standard	Y	AS-i	<b>3RK1400-1DQ02-0AA3</b>	
4 outputs	2 A	Standard	Y-II	--	<b>3RK1100-1CQ00-0AA3</b>	
	2 A	A/B (Spec. 3.0)	Y-II	--	<b>3RK2100-1CQ00-0AA3</b>	
<b>Digital I/O modules IP67 – K60, version ATEX (Ex) II 3D Ex tD A22 IP65X T75°C/60°C</b>						
<ul style="list-style-type: none"> <li>• PNP transistor</li> <li>• Width 60 mm</li> <li>• Current carrying capacity of the inputs: 200 mA</li> <li>• Connection method: M12</li> <li>• Modules supplied without mounting plate</li> </ul>						
Type	Current carrying capacity of outputs	Slave type	Pin assignment			
4 inputs/ 4 outputs	2 A	Standard	Y-II		<b>3RK1400-1DQ05-0AA3</b>	
4 inputs	--	Standard	Y-II		<b>3RK1200-0CQ05-0AA3</b>	
<b>Digital I/O modules IP67 - K60 data couplers</b>						
• Modules supplied without mounting plate						
Type	Current carrying capacity of outputs	Slave type	Pin assignment			
Data coupler 4 inputs/4 outputs (virtual)	--	Standard	--		<b>3RK1408-8SQ00-0AA3</b>	

## Accessories

 3RK 1901-0CA00	<b>K60 mounting plates</b> Suitable for all K60 compact modules <ul style="list-style-type: none"> <li>• Wall mounting</li> <li>• Standard rail mounting</li> </ul>	<b>3RK1901-0CA00</b> <b>3RK1901-0CB01</b>
	 3RK 1901-1KA00	<b>AS-Interface M12 sealing caps</b> For free M12 sockets
 3RK 1902-0AR00	<b>Sealing sets</b> <ul style="list-style-type: none"> <li>• For K60 mounting plate and standard distributor</li> <li>• Cannot be used for K45 mounting plate</li> <li>• One set contains one straight and one shaped seal</li> </ul>	<b>3RK1902-0AR00</b>

<sup>1)</sup> Module occupies two AS-Interface addresses

## AS-Interface

Slaves

I/O modules for use in the field, high degree of protection

### Digital I/O modules IP68/IP69K – K60R

#### Overview

##### Operation in particularly harsh environments

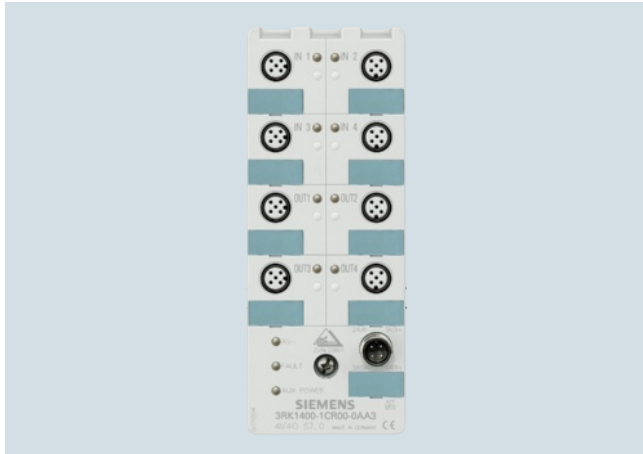

K60R module in degree of protection IP68/IP69K

Modules with degree of protection IP67 cannot be used in areas exposed to permanently high levels of humidity, in applications with drilling emulsions and cutting oils or when cleaning with high-pressure cleaners. The answer for these applications is provided by the expansion of the K60 compact modules with the K60R module with degree of protection IP68/IP69K.

The K60R modules are connected instead of the AS-Interface flat cable using a round cable with M12 cable box. The AS-Interface bus cable and the 24 V DC auxiliary power supply are routed in this case in a shared round cable.

Degree of protection IP68 permits many new applications that were impossible with the former field modules with degree of protection IP67. In applications such as filling plants or machine tools, the K60R with degree of protection IP68 enables the module to be used directly in zones exposed to permanent loading by humidity. It is thus possible to make even more rigorous savings in wiring with AS-Interface. For more information on IP68 test conditions see section "IP68/IP69KK tests."

Cleaning with high-pressure cleaners, such as is regularly performed in the food and drinks industry for instance, is possible without difficulty (IP69K).

In applications with tow chains, many users rely on placing the AS-Interface bus cable in a round cable. With the K60R module, a round cable connection is possible for direct connection to a round cable. No adapter is required.

#### Mounting

The same mounting plates are used as for the K60 modules. Instead of using flat cables, the K60R is connected using a 4-pole round cable with an M12 connection. With the K60R the mounting plate thus serves only as a fixture and ground terminal.

#### Addressing

Addressing is performed using the same socket as for the bus connection. Connecting the module to the addressing unit takes place over a 3-pole standard M12 cable.

When the mounting is finished, the module is connected with the addressing cable to the addressing unit and addressed. The addressing cable is then removed and the module connected to the bus cable.

#### Connection

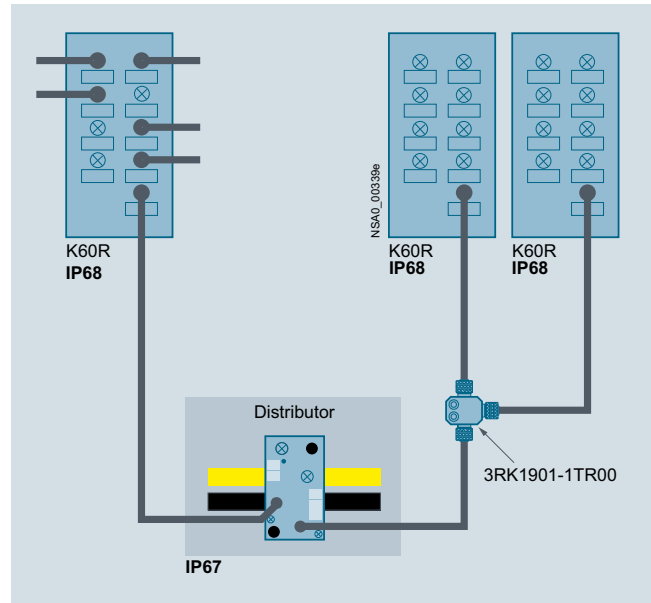

K60R connection options

In the IP67 environment, the service-proven standard components are connected using flat cables. Spur lines are laid into the IP68 environment by means of an AS-Interface M12 feeder (3RK1901-1NR..). The module is connected with a round cable to an M12 cable box. For this purpose, the module has an M12 bus connection instead of the former addressing socket. The AS-Interface bus cable and the 24 V DC auxiliary voltage are routed together in a 4-pole round cable. There must be no ground conductor in this round cable. Connection to ground is made through the mounting plate.

In the IP68 environment, only cables with extruded M12 plugs may be used.

To connect more than one K60R module to one spur line, the spur line can be split again using a T distributor (3RK1901-1TR00) with degree of protection IP68.

Please note the following conditions:

- The configuration guidelines for AS-Interface apply. For all M12 connecting cables, the maximum permissible current is limited to 4 A. The cross-section of these cables amounts to just 0.34 mm<sup>2</sup>. For connection of the K60R modules, the aforementioned M12 connecting cables can be used for the spur lines. The voltage drop caused by the ohmic resistance (approx. 0.11 Ω/m) must be taken into account.
- For round cable connections with shared AS-i and  $U_{aux}$  in a single cable, the following maximum lengths apply:
  - Per spur line from feeder to module: maximum 5 m
  - Total of all round cable segments in an AS-Interface network: maximum 20 m

#### IP68/IP69K tests

- K60R modules were tested with the following tests:
- Stricter test than IP67: 90 min at 1.8 m depth of water (IP67: 30 min at 1 m depth of water)
- Salt water test: Five months in salt water, 20 cm deep, at room temperature
- Test with particularly creepable oil: Five months completely under oil at room temperature



**Overview** (continued)







- Test with drilling emulsion: Five months at room temperature (components of the drilling emulsion: Anionic and non-ionic emulsifiers, paraffinic low-aromatic mineral oil, boric acid alkanolamines, corrosion inhibitors, oil content 40 %)
- Test in oil bath (Excellence 416 oil) with alternating oil bath temperature: 130 cycles of 15 to 55 °C, two months
- Cleaning with a high-pressure cleaner according to IP69K: 80 to 100 bar, 10 to 15 cm distance, time per side > 30 s, water temperature 80 °C

To simulate requirements as realistically as possible, the modules were artificially aged prior to the tests by 15 temperature cycles of -25/+85 °C. During the test, the modules were connected to 3RX1 connecting cables. Unassigned connections were closed with 3RK1901-1KA00 sealing caps.

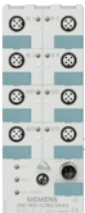
Note:

Screw caps and M12 connections must be tightened with the correct torque.

**Selection and ordering data**

Version	Article No.																				
 <p><b>Digital I/O modules, IP68/IP69K - K60R</b></p> <ul style="list-style-type: none"> <li>• 4 inputs/4 outputs</li> <li>• Width 60 mm</li> <li>• IP68/IP69K</li> <li>• Standard assignment</li> <li>• Current carrying capacity: <ul style="list-style-type: none"> <li>- 200 mA (inputs)</li> <li>- 2 A (outputs)</li> </ul> </li> <li>• Standard slave</li> <li>• Modules supplied without mounting plate</li> </ul> <p>3RK1400-1CR00-0AA3</p>	<b>3RK1400-1CR00-0AA3</b>																				
<p><b>Accessories</b></p>  <p>3RK1901-0CA00</p> <ul style="list-style-type: none"> <li>• Wall mounting</li> <li>• Standard rail mounting</li> </ul> <p><b>K60 mounting plates</b> Suitable for all K60 and K60R compact modules</p>	<b>3RK1901-0CA00</b> <b>3RK1901-0CB01</b>																				
 <p>3RK1901-1KA00</p> <p><b>AS-Interface M12 sealing caps</b> For free M12 sockets</p>	<b>3RK1901-1KA00</b>																				
 <p>3RK1901-1NR21</p> <p><b>AS-Interface M12 feeders, current carrying capacity up to 4 A</b></p> <table border="1"> <thead> <tr> <th>For flat cable</th> <th>For</th> <th>Cable length</th> <th>Cable end in feeder</th> <th></th> </tr> </thead> <tbody> <tr> <td>AS-i/U<sub>aux</sub></td> <td>M12 socket</td> <td>--</td> <td>Not available</td> <td><b>3RK1901-1NR20</b></td> </tr> <tr> <td>AS-i/U<sub>aux</sub></td> <td>M12 cable box</td> <td>1 m</td> <td>Not available</td> <td><b>3RK1901-1NR21</b></td> </tr> <tr> <td>AS-i/U<sub>aux</sub></td> <td>M12 cable box</td> <td>2 m</td> <td>Not available</td> <td><b>3RK1901-1NR22</b></td> </tr> </tbody> </table>	For flat cable	For	Cable length	Cable end in feeder		AS-i/U <sub>aux</sub>	M12 socket	--	Not available	<b>3RK1901-1NR20</b>	AS-i/U <sub>aux</sub>	M12 cable box	1 m	Not available	<b>3RK1901-1NR21</b>	AS-i/U <sub>aux</sub>	M12 cable box	2 m	Not available	<b>3RK1901-1NR22</b>	<b>3RK1901-1NR20</b> <b>3RK1901-1NR21</b> <b>3RK1901-1NR22</b>
For flat cable	For	Cable length	Cable end in feeder																		
AS-i/U <sub>aux</sub>	M12 socket	--	Not available	<b>3RK1901-1NR20</b>																	
AS-i/U <sub>aux</sub>	M12 cable box	1 m	Not available	<b>3RK1901-1NR21</b>																	
AS-i/U <sub>aux</sub>	M12 cable box	2 m	Not available	<b>3RK1901-1NR22</b>																	
 <p>3RK1901-1NR04</p> <p><b>AS-Interface M12 feeders, 4-fold, current carrying capacity up to 4 A</b></p> <table border="1"> <thead> <tr> <th>For flat cable</th> <th>For</th> <th>Cable length</th> <th>Cable end in feeder</th> <th></th> </tr> </thead> <tbody> <tr> <td>AS-i/U<sub>aux</sub></td> <td>4-fold M12 socket, delivery includes mounting plate (for wall and standard rail mounting)</td> <td>--</td> <td>Not available</td> <td><b>3RK1901-1NR04</b></td> </tr> </tbody> </table>	For flat cable	For	Cable length	Cable end in feeder		AS-i/U <sub>aux</sub>	4-fold M12 socket, delivery includes mounting plate (for wall and standard rail mounting)	--	Not available	<b>3RK1901-1NR04</b>	<b>3RK1901-1NR04</b>										
For flat cable	For	Cable length	Cable end in feeder																		
AS-i/U <sub>aux</sub>	4-fold M12 socket, delivery includes mounting plate (for wall and standard rail mounting)	--	Not available	<b>3RK1901-1NR04</b>																	
 <p>3RK1901-1TR00</p> <p><b>M12 T distributors</b></p> <ul style="list-style-type: none"> <li>• IP68</li> <li>• 1 x M12 plug</li> <li>• 2 x M12 box</li> </ul>	<b>3RK1901-1TR00</b>																				
 <p>3RK1902-4PB15-3AA0</p> <p><b>M12 connecting cables</b></p> <ul style="list-style-type: none"> <li>• 3-pole</li> <li>• For addressing AS-i slaves with M12 bus connection</li> <li>• Cable length 1.5 m</li> </ul>	<b>3RK1902-4PB15-3AA0</b>																				

## AS-Interface

Slaves

I/O modules for use in the field, high degree of protection

### Digital I/O modules IP67 – K45

#### Overview



K45 compact modules

The K45 series of compact modules supplements the large K60 compact modules which have a proven track record in industry. They are the logical consequence for rounding off the bottom end of the existing product range.

The acclaimed advantages of the existing K60 compact modules are fully emulated by the K45 modules. The K45 modules, however, have a considerably smaller footprint and mounting depth.

Yet in spite of these small dimensions all the modules have large labels and an integrated addressing socket.

Two mounting plates are offered for the K45 compact modules:

- The mounting plate for wall mounting has a hole pattern that is identical to that of the K60 compact modules. This means that K60 compact modules can be mounted together with K45 modules in an aligned arrangement. The shaped cables can be inserted in the recesses of the mounting plates where they cause no hindrance.
- The mounting plate for standard rail mounting

#### Connection of the AS-Interface shaped cables

The mounting plate and the compact module are joined together by means of a screw, with simultaneous contacting of the AS-Interface cable by the service-proven insulation piercing method.

Now, mounting the AS-Interface shaped cables is in fact easier than ever. The yellow and black AS-Interface shaped cable can be inserted into the mounting plates from the left or right regardless of the position of the coding lug. The correct polarity of the applied voltages is thus guaranteed.

#### Addressing and connection of the sensors/actuators

Addressing of the K45 compact modules is performed using an addressing socket integrated in the module. The addresses can be assigned even when mounted.

#### K45 modules with a maximum of four digital inputs and outputs

These compact modules contain up to four M12 standard connections or M8 standard connections for inputs and outputs. Using M12 or M8 standard connectors, a maximum of four sensors and four actuators can be connected to the compact module. Depending upon the module, the sockets can have a double assignment.

Pin assignment: Y – i.e. via a socket, two sensors or one sensor/one actuator is connected.

#### K45 modules with a maximum of eight digital inputs

These modules have eight digital inputs for connection through M12 plugs. The sockets have a double assignment. Pin assignment: Y – i.e. via a socket, two sensors or one sensor/one actuator is connected.

The module requires two AS-Interface addresses for processing all eight inputs. The addresses can be assigned through a double addressing socket integrated in the module.

#### K45 modules with four digital inputs and outputs/four digital outputs according to AS-i Specification 3.0

The extended address mode (A/B addresses) according to AS-Interface Specification 3.0 enables the connection of up to 62 slaves on one AS-i network. With this extended address mode, four outputs are now possible even with A/B slaves (instead of only three outputs possible up to now with Specification 2.1). Hence with full expansion of an AS-Interface network, there are now 248 inputs as well as 248 outputs available on one AS-Interface system.

Please note, however,

- that these modules can be used only with a master according to AS-i Specification 3.0
- that the cycle times for the outputs may be up to 20 ms.

Depending on the module, the sockets can have a double assignment. Pin assignment: Y – i.e. via a socket, two sensors or one sensor/one actuator is connected.

## Selection and ordering data

Version	Article No.						
 <p>3RK1400-0GQ20-0AA3</p>	<b>Digital I/O modules, IP67 - K45</b>						
	<ul style="list-style-type: none"> <li>• PNP transistor</li> <li>• Width 45 mm</li> <li>• Current carrying capacity of the inputs: 200 mA</li> <li>• Modules supplied without mounting plate</li> </ul>						
	Type	Current carrying capacity of outputs	Slave type	Pin assignment	$U_{aux}$ 24 V	Connection methods	
	8 inputs <sup>1)</sup>	--	A/B	Y	--	M12	<b>3RK2200-0DQ20-0AA3</b>
	4 inputs	--	Standard	Standard	--	M12	<b>3RK1200-0CQ20-0AA3</b>
			Standard	Standard	--	M8 screw	<b>3RK1200-0CT20-0AA3</b>
			A/B	Standard	--	M12	<b>3RK2200-0CQ20-0AA3</b>
			A/B	Standard	--	M8 screw	<b>3RK2200-0CT20-0AA3</b>
	2 x 2 inputs	--	A/B	Y	--	M12	<b>3RK2200-0CQ22-0AA3</b>
	2 inputs/ 2 outputs	2 A <sup>2)</sup>	Standard	Standard	✓	M12	<b>3RK1400-1BQ20-0AA3</b>
	2 x (1 input/ 1 output)	0.2 A	Standard	Y	--	M12	<b>3RK1400-0GQ20-0AA3</b>
	4 x (1 input/ 1 output)	0.2 A	A/B (Spec. 3.0)	Y	--	M12	<b>3RK2400-0GQ20-0AA3</b>
	4 x (1 input/ 1 output)	0.5 A	A/B (Spec. 3.0)	Y	✓	M12	<b>3RK2400-1GQ20-1AA3</b>
	4 outputs	1 A	A/B (Spec. 3.0)	Standard	✓	M12	<b>3RK2100-1CQ20-0AA3</b>
3 outputs	1 A	A/B	Standard	✓	M12	<b>3RK2100-1EQ20-0AA3</b>	
4 outputs	1 A	Standard	Standard	✓	M12	<b>3RK1100-1CQ20-0AA3</b>	
2 outputs/ 2 inputs	2 A	A/B	Standard	✓	M12	<b>3RK2400-1BQ20-0AA3</b>	

## Accessories



3RK1901-2EA00

**K45 mounting plates**

- For wall mounting
- For standard rail mounting

**3RK1901-2EA00**  
**3RK1901-2DA00**



3RK1901-1KA00

**AS-Interface sealing caps**

- For free M12 sockets
- For free M8 sockets

**3RK1901-1KA00**  
**3RK1901-1PN00**



3RK1901-1PN00

- ✓ Available
- Not available

<sup>1)</sup> Module occupies two AS-Interface addresses

<sup>2)</sup> The typical current carrying capacity per output increases with version "E12" from 1.5 to 2 A (available since approx. 07/2003).

## AS-Interface

Slaves

I/O modules for use in the field, high degree of protection

### Digital I/O modules, IP67 – K20

#### Overview



Digital I/O modules, IP67 - K20

The K20 compact module series rounds off the AS-Interface compact modules with a particularly slim design and a width of a mere 20 mm. Thanks to its extremely compact dimensions, these modules are particularly suited for handling machine applications in the field of production engineering where modules need to be arranged in the smallest of spaces.

Robotics is yet another application area. Instead of the AS-Interface flat cable, the K20 modules are connected to AS-Interface over a round cable with M12 cable box. The AS-Interface bus cable and the 24 V DC auxiliary power supply are routed in this case in a shared round cable. This enables extremely compact installation.

The flexibility of the round cable means that it can also be used on moving machine parts without any problems. The K20 modules are also ideal for such applications as their non-encapsulated design makes them particularly light in weight.

In applications with tow chains, many users rely on placing the AS-Interface bus cable in a round cable. In this case, the K20 modules support direct connection to the round cable. No flat to round cable adapter is required.











The K20 compact module series includes standard AS-Interface modules, as well as an ASIsafe version for the connection of safety-related sensors, such as EMERGENCY-STOP push-buttons or protective door monitoring. All standard AS-Interface K20 modules support, as far as technically possible, the expanded address mode (A/B addresses) according to AS-Interface Specification 2.1, which enables connection of 62 stations to an AS-Interface network. The K20 module with four inputs and four outputs works in expanded address mode according to AS-Interface specification 3.0 which, for the first time, supports four outputs with an A/B slave, thus enabling 248 inputs and 248 outputs in a fully expanded AS-Interface network.

For particularly space-saving dimensions, the sensors and actuators are connected over M8 plug-in connectors. Alternatively, M12 connectors with Y assignment can be used.

#### Selection and ordering data

Version						Article No.
 3RK2200-0CT30-0AA3	<b>Digital I/O modules, IP67 – K20</b>					
	Width 20 mm					
	Type	Current carrying capacity of outputs	Slave type	Pin assignment	Connection methods	
	4 inputs	--	A/B	Standard	M8	<b>3RK2200-0CT30-0AA3</b>
		--	A/B	Y	M12	<b>3RK2200-0CQ30-0AA3</b>
	2 inputs/ 2 outputs	1	A/B	Standard	M8	<b>3RK2400-1BT30-0AA3</b>
		1	A/B	Y	M12	<b>3RK2400-1BQ30-0AA3</b>
	4 outputs	1	A/B (Spec. 3.0)	Standard	M8	<b>3RK2100-1CT30-0AA3</b>
	4 inputs/ 4 outputs	1	Standard	Standard	M8	<b>3RK1400-1CT30-0AA3</b>
1		A/B (Spec. 3.0)	Standard	M8	<b>3RK2400-1CT30-0AA3</b>	
2 safe inputs	--	Standard	Y-II	M12	<b>3RK1205-0BQ30-0AA3</b>	

**Selection and ordering data** (continued)

Version	Article No.																																			
<b>Accessories</b>																																				
 3RK1901-1KA00  3RK1901-1PN00	<b>AS-Interface sealing caps</b> <ul style="list-style-type: none"> <li>• For free M12 sockets</li> <li>• For free M8 sockets</li> </ul>																																			
 3RK1901-1NN10	<b>AS-Interface compact distributors, for AS-Interface flat cable</b> Current carrying capacity up to 8 A																																			
 3RX9801-0AA00	<b>AS-Interface M12 feeders</b> <ul style="list-style-type: none"> <li>• Degree of protection IP67</li> <li>• Current carrying capacity up to 2 A</li> </ul> <table border="1"> <thead> <tr> <th>For flat cable</th> <th>For</th> <th>Cable length</th> <th>Cable end in feeder</th> <th></th> </tr> </thead> <tbody> <tr> <td>AS-i</td> <td>M12 socket</td> <td>--</td> <td>Available</td> <td><b>3RX9801-0AA00</b></td> </tr> </tbody> </table>	For flat cable	For	Cable length	Cable end in feeder		AS-i	M12 socket	--	Available	<b>3RX9801-0AA00</b>																									
For flat cable	For	Cable length	Cable end in feeder																																	
AS-i	M12 socket	--	Available	<b>3RX9801-0AA00</b>																																
 3RK1901-1NR10  3RK1901-1NR11	<b>AS-Interface M12 feeders</b> <ul style="list-style-type: none"> <li>• Degree of protection IP67/IP68/IP69K</li> <li>• Current carrying capacity up to 4 A</li> </ul> <table border="1"> <thead> <tr> <th>For flat cable</th> <th>For</th> <th>Cable length</th> <th>Cable end in feeder</th> <th></th> </tr> </thead> <tbody> <tr> <td>AS-i</td> <td>M12 socket</td> <td>--</td> <td>Not available</td> <td><b>3RK1901-1NR10</b></td> </tr> <tr> <td>AS-i</td> <td>M12 cable box</td> <td>1 m</td> <td>Not available</td> <td><b>3RK1901-1NR11</b></td> </tr> <tr> <td>AS-i</td> <td>M12 cable box</td> <td>2 m</td> <td>Not available</td> <td><b>3RK1901-1NR12</b></td> </tr> <tr> <td>AS-i/U<sub>aux</sub></td> <td>M12 socket</td> <td>--</td> <td>Not available</td> <td><b>3RK1901-1NR20</b></td> </tr> <tr> <td>AS-i/U<sub>aux</sub></td> <td>M12 cable box</td> <td>1 m</td> <td>Not available</td> <td><b>3RK1901-1NR21</b></td> </tr> <tr> <td>AS-i/U<sub>aux</sub></td> <td>M12 cable box</td> <td>2 m</td> <td>Not available</td> <td><b>3RK1901-1NR22</b></td> </tr> </tbody> </table>	For flat cable	For	Cable length	Cable end in feeder		AS-i	M12 socket	--	Not available	<b>3RK1901-1NR10</b>	AS-i	M12 cable box	1 m	Not available	<b>3RK1901-1NR11</b>	AS-i	M12 cable box	2 m	Not available	<b>3RK1901-1NR12</b>	AS-i/U <sub>aux</sub>	M12 socket	--	Not available	<b>3RK1901-1NR20</b>	AS-i/U <sub>aux</sub>	M12 cable box	1 m	Not available	<b>3RK1901-1NR21</b>	AS-i/U <sub>aux</sub>	M12 cable box	2 m	Not available	<b>3RK1901-1NR22</b>
For flat cable	For	Cable length	Cable end in feeder																																	
AS-i	M12 socket	--	Not available	<b>3RK1901-1NR10</b>																																
AS-i	M12 cable box	1 m	Not available	<b>3RK1901-1NR11</b>																																
AS-i	M12 cable box	2 m	Not available	<b>3RK1901-1NR12</b>																																
AS-i/U <sub>aux</sub>	M12 socket	--	Not available	<b>3RK1901-1NR20</b>																																
AS-i/U <sub>aux</sub>	M12 cable box	1 m	Not available	<b>3RK1901-1NR21</b>																																
AS-i/U <sub>aux</sub>	M12 cable box	2 m	Not available	<b>3RK1901-1NR22</b>																																
 3RK1901-1NR04	<b>AS-Interface M12 feeders, 4-fold</b> Current carrying capacity up to 4 A <table border="1"> <thead> <tr> <th>For flat cable</th> <th>For</th> <th>Cable length</th> <th>Cable end in feeder</th> <th></th> </tr> </thead> <tbody> <tr> <td>AS-i/U<sub>aux</sub></td> <td>4-fold M12 socket, delivery includes mounting plate (for wall and standard rail mounting)</td> <td>--</td> <td>Not available</td> <td><b>3RK1901-1NR04</b></td> </tr> </tbody> </table>	For flat cable	For	Cable length	Cable end in feeder		AS-i/U <sub>aux</sub>	4-fold M12 socket, delivery includes mounting plate (for wall and standard rail mounting)	--	Not available	<b>3RK1901-1NR04</b>																									
For flat cable	For	Cable length	Cable end in feeder																																	
AS-i/U <sub>aux</sub>	4-fold M12 socket, delivery includes mounting plate (for wall and standard rail mounting)	--	Not available	<b>3RK1901-1NR04</b>																																
 3RK1901-1TR00	<b>M12 T distributors</b> <ul style="list-style-type: none"> <li>• IP68</li> <li>• 1 x M12 plug</li> <li>• 2 x M12 box</li> </ul>																																			
 6ES7194-1KA01-0XA0	<b>M12 Y-shaped coupler plugs</b> For connection of two sensors to one M12 socket with Y assignment																																			
 3RK1902-4PB15-3AA0	<b>M12 connecting cables</b> <ul style="list-style-type: none"> <li>• 3-pole</li> <li>• For addressing AS-i slaves with M12 bus connection</li> <li>• Cable length 1.5 m</li> </ul>																																			

## AS-Interface

Slaves

I/O modules for use in the field, high degree of protection

### Analog I/O modules IP67 – K60

#### Overview



K60 analog compact module

AS-Interface analog modules from the K60 compact series detect or issue analog signals locally. These modules are linked to the higher-level controller through an AS-Interface master according to Specification 2.1 or Specification 3.0.

The analog modules are divided into the following groups:

- Input modules
  - for sensors with current signal
  - for sensors with voltage signal
  - for sensors with thermal resistor
- Output modules
  - for current actuators
  - for voltage actuators

The input modules according to Profile 7.3/7.4 are available with two or four input channels. It is possible in addition to convert the two-channel module to using only one input channel, thus enabling very short times before the analog value is available. The conversion is effected by means of a jumper plug at socket 3. The transmission times achieved with analog modules according to Profile 7.A.9 are shorter by half than those achieved with Profile 7.3/7.4. Operation is adjustable in this case, e.g. it is possible to choose with the ID1 code whether the module is operated with one or two channels.

The output modules are configured as two-channel modules as standard.

The input and output channels are electrically separated from the AS-Interface network. If sensors with a higher power requirement are to be connected, more power can be supplied through the auxiliary voltage as an alternative to the internal supply.

In the manual, the modules are presented in great detail along with their technical specifications and in-depth notes on operation. Sample function blocks round off the manual.



#### Benefits

- Analog modules are just as easy to integrate in AS-Interface as digital modules
- Analog values can be easily detected and issued locally
- Preprocessing of the analog value transmission in the master enables rapid evaluation of the analog values
- Up to four values can be detected using one analog module
- Faster transmission and conversion of analog values thanks to the new option for a switchover to single-channel operation

In addition, Specification 3.0 now also offers:

- A/B technology, now also with analog modules
- On average, double fast transmission times (only 3 or 4 cycles, depending on the resolution selected)
- Variable adjustable mode: 12 bit or 14 bit resolution, 1 or 2-channel, selectable over the ID1 code
- Extra simple handling of analog value processing with masters of Specification 3.0, the DP/AS-i LINK Advanced

**Selection and ordering data**

Version	Article No.			
 <p><b>Analog I/O modules IP67 - K60, analog profile 7.3</b></p> <ul style="list-style-type: none"> <li>• Slave type: Standard</li> <li>• Width 60 mm</li> <li>• Modules supplied without mounting plate</li> </ul>				
	1 or 2 inputs (selectable using jumper plug at socket 3)	Current	4 ... 20 mA or ±20 mA (selectable) <sup>1)</sup>	<b>3RK1207-1BQ40-0AA3</b>
		Voltage	± 10 V or 1 ... 5 V (selectable)	<b>3RK1207-2BQ40-0AA3</b>
		Thermal resistance	Pt 100 or Ni 100 or 0 ... 600 Ω (selectable) <sup>1)</sup>	<b>3RK1207-3BQ40-0AA3</b>
	4 inputs	Current	4 ... 20 mA or ±20 mA (selectable)	<b>3RK1207-1BQ44-0AA3</b>
		Voltage	± 10 V or 1 ... 5 V (selectable)	<b>3RK1207-2BQ44-0AA3</b>
		Thermal resistance	Pt 100 or Ni 100 or 0 ... 600 Ω (selectable)	<b>3RK1207-3BQ44-0AA3</b>
	<b>Outputs</b>		<b>Type</b>	<b>Output range</b>
	2 outputs	Current for 2-wire actuators	4 ... 20 mA or ±20 mA or 0 ... 20 mA (selectable) <sup>1)</sup>	<b>3RK1107-1BQ40-0AA3</b>
		Voltage for 2-wire actuators	± 10 V or 0 ... 10 V or 1 ... 5 V (selectable)	<b>3RK1107-2BQ40-0AA3</b>
	 <p><b>Analog I/O modules IP67 - K60, analog profile 7.A.9</b></p> <ul style="list-style-type: none"> <li>• Slave type: A/B (Spec. 3.0)</li> <li>• Width 60 mm</li> <li>• Modules supplied without mounting plate</li> </ul>			
		1 or 2 inputs (variably adjustable)	Current	4 ... 20 mA or ±20 mA (selectable)
Voltage			± 10 V or 1 ... 5 V (selectable)	<b>3RK2207-2BQ50-0AA3</b>

<sup>1)</sup> Some modules are available in the extended temperature range (from -25 to 70 °C) and for use in difficult environmental conditions (coated according to environment standard IEC 60721).

Description	SIPLUS Article No.	Corresponds to module
SIPLUS AS-Interface 2AA, IP67	6AG1107-1BQ40-7AA3	3RK1107-1BQ40-0AA3
SIPLUS AS-Interface 2AI, IP67	6AG1207-1BQ40-7AA3	3RK1207-1BQ40-0AA3
SIPLUS AS-Interface 2AI, IP67	6AG1207-3BQ40-7AA3	3RK1207-3BQ40-0AA3





For more information see [www.siemens.com/siplus-extreme](http://www.siemens.com/siplus-extreme).

**AS-Interface**

Slaves

I/O modules for use in the field, high degree of protection

**Analog I/O modules IP67 – K60****Selection and ordering data** (continued)

	Version	Article No.
<b>Accessories</b>		
	<b>Manual "AS-Interface Analog Modules K60"</b>  <b>K60 mounting plates</b> <ul style="list-style-type: none"> <li>• Wall mounting</li> <li>• Standard rail mounting</li> </ul>	See <a href="http://support.automation.siemens.com/WW/view/en/6007797">http://support.automation.siemens.com/WW/view/en/6007797</a>  <b>3RK1901-0CA00</b> <b>3RK1901-0CB01</b>
 3RK1901-0CA00	<b>M12 sealing caps</b>	<b>3RK1901-1KA00</b>
 3RK1901-1KA00	<b>Sealing sets</b> <ul style="list-style-type: none"> <li>• For mounting plate K60 and distributor</li> <li>• Cannot be used for K45 mounting plate</li> <li>• One set contains one straight and one shaped seal</li> </ul>	<b>3RK1902-0AR00</b>
 3RK1902-0AR00	<b>Jumper plugs</b> For changing over the 2-channel input modules	<b>3RK1901-1AA00</b>
 3RK1901-1AA00		

4



## Overview

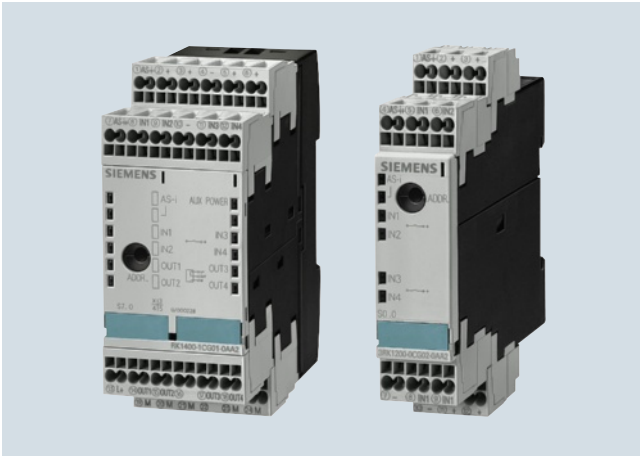

SlimLine S22.5/S45



Flat module

F90 module<sup>1)</sup>

For AS-Interface applications inside control cabinets, there are various module series for the most diverse requirements:

- SlimLine S22.5
- SlimLine S45
- F90 module<sup>1)</sup>
- Flat module

All modules of these series can be snap-mounted directly on a standard mounting rail or be fastened using screws.

AS-Interface modules in IP20 have direct terminals for the AS-Interface cables and therefore do not require a base.

Type series	Spectrum	Mounting onto TH 35 standard mounting rail according to IEC 60715	Wall mounting using push-in lugs (type 3RP1903)	Other possibilities
SlimLine S22.5	<ul style="list-style-type: none"> <li>• 4I (standard and A/B modules)</li> <li>• 4O</li> <li>• 2I/2O (steady-state/relay outputs)</li> <li>• Counters<sup>2)</sup></li> <li>• Ground-fault detection modules<sup>2)</sup></li> </ul>	✓	✓	--
SlimLine S45	<ul style="list-style-type: none"> <li>• 4I/4O (steady-state/relay outputs)</li> <li>• 4I/4O with floating I/Os</li> <li>• 4I/3O (A/B modules)</li> <li>• 4I/4O (A/B modules Spec. 3.0)</li> </ul>	✓	✓	--
F90 module	<ul style="list-style-type: none"> <li>• 4I/4O (screw terminals)</li> <li>• 4I/4O (connection using Combi-con connector)</li> <li>• 16I</li> </ul>	✓	--	--
Flat module	<ul style="list-style-type: none"> <li>• 4I/4O (screw terminals)</li> </ul>	--	--	Integrated lugs for screw fixing

✓ Available

-- Not available

<sup>1)</sup> See Catalog IC 10, Chapter 2 "Industrial Communication".

<sup>2)</sup> For more information about these modules see "Modules with Special Functions" from page 4/74.

## AS-Interface

Slaves

I/O modules for use in the control cabinet

### SlimLine

#### Overview

##### *SlimLine modules of the S22.5 and S45 series*

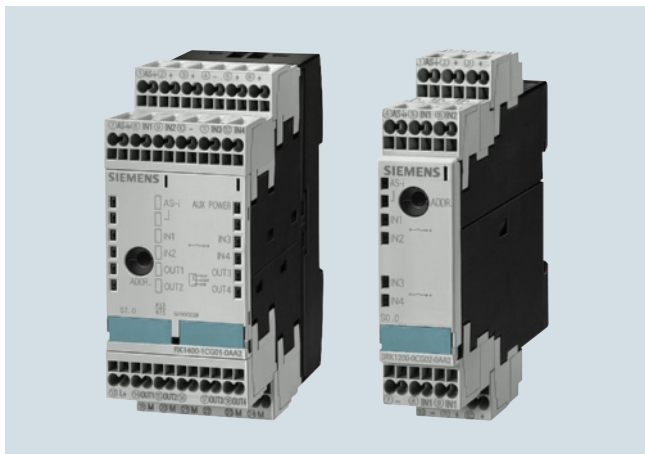

SlimLine S45 module (left) and S22.5 module (right)

The AS-Interface series of modules for the "SlimLine" control cabinet with degree of protection IP20 creates space in the cabinet and in distributed local boxes.

For these modules, the priority was placed on a narrow design. They have a width of only 22.5 mm or 45 mm.

Standard sensors/actuators and the AS-Interface cable can be connected using removable screw terminals or spring-type terminals.

Integrated adapters enable mounting onto a standard mounting rail. Disassembly from the standard mounting rail is quick and easy and requires no tools.

With an additional accessory (push-in lugs), the modules can also be screwed on.

All modules are fitted at the front with LEDs which indicate the module's status.

An addressing socket integrated at the front enables the module to be addressed also when it is installed.

In addition to the digital input/output modules, there are modules of design S22.5 with special functions. These include:

- Counter modules
- Ground-fault detection modules

For more information about these modules see

- section "Modules with Special Functions" on page 4/74
- Industry Mall: Section "Automation Technology"
  - ⇒ "SIRIUS Industrial Controls"
  - ⇒ "Industrial Communication"
  - ⇒ "AS-Interface" ⇒ "Slaves"
  - ⇒ "Modules with Special Functions"







The AS-Interface Specification 3.0 adds a number of completely new features to the AS-Interface bus system. The extended address mode (A/B addresses) enables the connection of up to 62 slaves on one AS-Interface network. With the extended address mode according to Specification 3.0, four outputs are now possible for the first time even with A/B slaves (instead of only three outputs possible up to now with Specification 2.1). Hence with full expansion of an AS-Interface network, there are now 248 inputs as well as 248 outputs available on one AS-Interface system.

Modules with four inputs and four outputs as A/B slaves according to Specification 3.0 are also available for the control cabinet as SlimLine S45 modules.

#### Note:

Please note that the modules according to Specification 3.0 can be used only with a new master according to AS-Interface Specification 3.0, and that the cycle times for the outputs must not exceed 20 ms.

#### Selection and ordering data





Version		Article No.				
 <p><b>SlimLine S22.5 modules</b></p> <ul style="list-style-type: none"> <li>Inputs: PNP transistor</li> <li>Width 22.5 mm</li> </ul>						
 <p>3RK1200-0CE00-0AA2</p>	4 inputs	Screw	⊕ Standard	2-wire	--	<b>3RK1200-0CE00-0AA2</b>
			⊕ Standard	2- and 3-wire	--	<b>3RK1200-0CE02-0AA2</b>
			⊕ A/B slave	2- and 3-wire	--	<b>3RK2200-0CE02-0AA2</b>
	2 inputs/ 2 outputs	Spring-type	∞ Standard	2-wire	--	<b>3RK1200-0CG00-0AA2</b>
			∞ Standard	2- and 3-wire	--	<b>3RK1200-0CG02-0AA2</b>
			∞ A/B slave	2- and 3-wire	--	<b>3RK2200-0CG02-0AA2</b>
 <p>3RK1400-0BG00-0AA2</p>	2 inputs/ 2 outputs	Screw	⊕ Standard	2-wire	PNP transistor 2 A	<b>3RK1400-0BE00-0AA2</b>
			⊕ Standard	2-wire	Relays	<b>3RK1402-0BE00-0AA2</b>
	4 outputs	Spring-type	∞ Standard	2-wire	PNP transistor 2 A	<b>3RK1400-0BG00-0AA2</b>
			∞ Standard	2-wire	Relays	<b>3RK1402-0BG00-0AA2</b>
 <p><b>SlimLine S45 modules</b></p> <ul style="list-style-type: none"> <li>Inputs: PNP transistor</li> <li>Width 45 mm</li> </ul>						
 <p>3RK1400-1CG00-0AA2</p>	4 inputs/ 4 outputs	Screw	⊕ Standard	2- and 3-wire	PNP transistor 1 A	<b>3RK1400-1CE00-0AA2</b>
			⊕ Standard	2- and 3-wire	PNP transistor 2 A	<b>3RK1400-1CE01-0AA2</b>
			⊕ Standard	2- and 3-wire floating	PNP transistor 1 A floating	<b>3RK1402-3CE01-0AA2</b>
			⊕ Standard	2- and 3-wire	Relays	<b>3RK1402-3CE00-0AA2</b>
			⊕ A/B (Spec. 3.0)	2- and 3-wire	PNP transistor 2 A	<b>3RK2400-1CE01-0AA2</b>
			∞ Standard	2- and 3-wire	PNP transistor 1 A	<b>3RK1400-1CG00-0AA2</b>
	4 inputs/ 3 outputs	Spring-type	∞ Standard	2- and 3-wire	PNP transistor 2 A	<b>3RK1400-1CG01-0AA2</b>
			∞ Standard	2- and 3-wire floating	PNP transistor 1 A floating	<b>3RK1402-3CG01-0AA2</b>
			∞ Standard	2- and 3-wire	Relays	<b>3RK1402-3CG00-0AA2</b>
			∞ A/B (Spec. 3.0)	2- and 3-wire	PNP transistor 2 A	<b>3RK2400-1CG01-0AA2</b>
			⊕ A/B slave	2- and 3-wire	PNP transistor 2 A	<b>3RK2400-1FE00-0AA2</b>
			∞ A/B slave	2- and 3-wire	PNP transistor 2 A	<b>3RK2400-1FG00-0AA2</b>
<b>Accessories</b>						
 <p>3RP1902</p>	<b>Sealable covers</b> To secure against unauthorized addressing		<b>3RP1902</b>			
	 <p>3RP1903</p>	<b>Push-in lugs</b> For screw fixing		<b>3RP1903</b>		

**AS-Interface**

Slaves

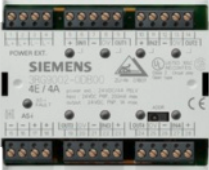
I/O modules for use in the control cabinet

**F90 Module****Selection and ordering data**

Version	Article No.					
 <p><b>F90 module</b></p> <ul style="list-style-type: none"> <li>• Standard slave</li> <li>• Width 90 mm</li> </ul> <p>3RG9002-0DB00</p>	4 inputs/ 4 outputs	Screw		2- and 3-wire PNP transistor	PNP transistor 1 A	<b>3RG9002-0DB00</b>
				2- and 3-wire PNP transistor	PNP transistor 2 A	<b>3RG9002-0DA00</b>
	2- and 3-wire PNP transistor floating			PNP transistor 2 A	<b>3RG9002-0DC00</b>	
	16 inputs	Combicon <sup>1)</sup>		2- and 3-wire PNP transistor	PNP transistor 1 A	<b>3RG9004-0DB00</b>
				2- and 3-wire PNP transistor	PNP transistor 2 A	<b>3RG9004-0DA00</b>
				2- and 3-wire PNP transistor floating	PNP transistor 2 A	<b>3RG9004-0DC00</b>
	16 inputs	Screw		PNP transistor	--	<b>3RG9002-0DE00</b>
				Combicon <sup>1)</sup>		PNP transistor

**Accessories****Combicon connector sets**

For 4I/4O and 16E modules with Combicon connection; one set comprises:

- 4 x 5-pole plug for connection
- Standard sensors/actuators
- 2 x 4-pole plug for AS-Interface and external auxiliary voltage

**3RX9810-0AA00**

<sup>1)</sup> Scope of supply does not include Combicon connector set 3RX9810-0AA00, this must be ordered separately, see "Accessories".

**Overview**

Flat module

The flat module for the control cabinet in degree of protection IP20 has 4 inputs and 4 outputs.



The module is fitted at the front with an LED which indicates the module's status.

With the integrated lugs, the modules can be screwed on.

An integrated addressing socket enables the module to be addressed when it is installed.

Standard sensors/actuators and the AS-Interface cable can be connected using screw terminals.

**Selection and ordering data**

Version		Screw terminals Article No. 
 <p><b>Flat module</b></p> <ul style="list-style-type: none"> <li>• 4 inputs/4 outputs</li> <li>• 200 mA for all I/Os</li> </ul> <p>3RK1400-0CE00-0AA3</p>		<p><b>3RK1400-0CE00-0AA3</b></p>

## AS-Interface

Slaves

Special integrated solutions

### AS-interface communication modules

#### Overview

#### AS-Interface communication modules for printed circuit board installation

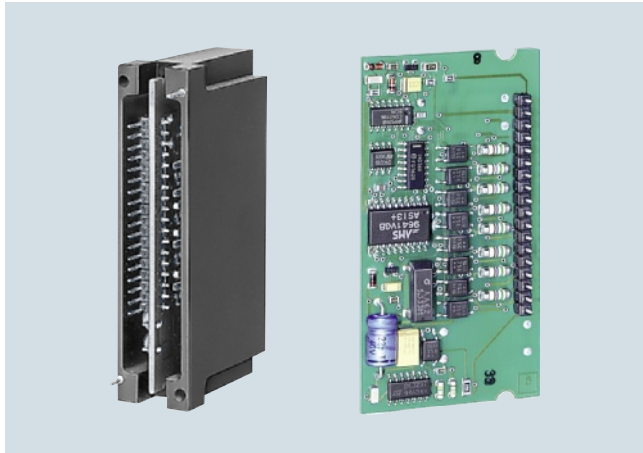

AS-Interface communication module 3RK1400-0CD00-0AA3 (left), AS-Interface communication module 3RK2400-1FD00-0AA2 (right)

#### 3RK1400-0CD00-0AA3 AS-Interface communication modules for printed circuit board installation

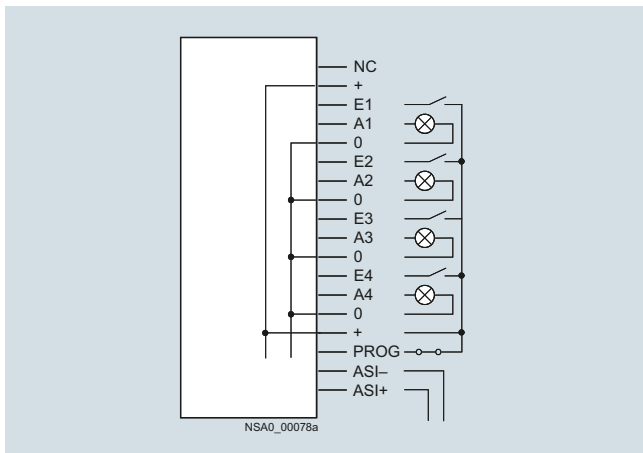

3RK1400-0CD00-0AA3

With the 4I/4O module for printed circuit board installation, it is possible for up to four mechanical contacts to be queried or indicator lights to be operated, the necessary energy being provided by the AS-Interface system (yellow AS-Interface cable).

#### Note:

If the switching outputs are overloaded, the module does not respond to invoking by a master.

#### 3RK1400-0CD01-0AA3 AS-Interface communication modules for printed circuit board installation

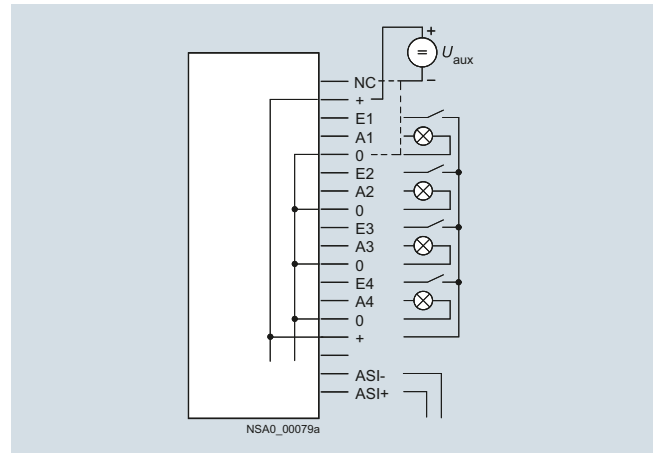

3RK1400-0CD01-0AA3

With the 4I/4O module 3RK1400-0CD01-0AA3 for printed circuit board installation, it is possible for up to four mechanical contacts to be queried or indicator lights to be operated, the necessary energy for the inputs and outputs being provided from the auxiliary voltage (24 V PELV). If (+) is connected to  $U_{aux+}$  and (NC) to  $U_{aux-}$ , the outputs are not short-circuit and overload proof; if  $U_{aux-}$  is connected to (0), the outputs are overload and short-circuit proof (maximum summation current 200 mA). In this case, the module does not respond even to invoking by a master when the switching outputs are overloaded.

#### 3RG9005-0SA00 AS-Interface communication modules for printed circuit board installation

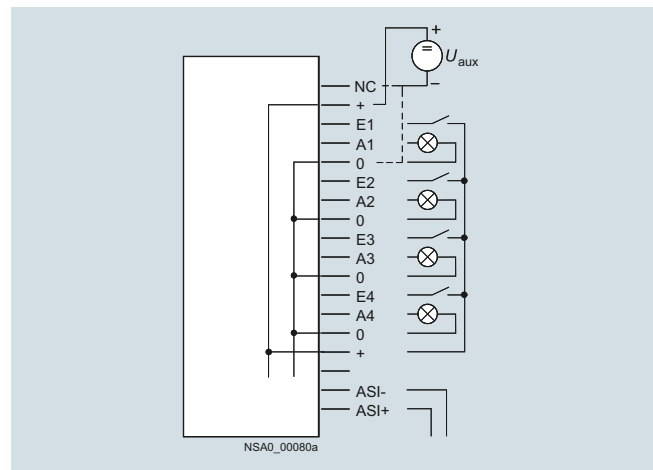

3RG9005-0SA00

With the 4I/4O module for printed circuit board mounting, it is possible for up to four mechanical contacts to be queried or indicator lights to be operated, the power for inputs and outputs being provided from an auxiliary voltage (24 V PELV). If (+) is connected to  $U_{aux+}$  and (NC) to  $U_{aux-}$ , the outputs are not short-circuit and overload proof; if  $U_{aux-}$  is connected to (0), the outputs are overload and short-circuit proof (maximum summation current 200 mA). In this case, the module does not respond even to invoking by a master when the switching outputs are overloaded.

**Overview** (continued)
**3RK1400-1CD00-0AA2, 3RK2400-1FD00-0AA2**  
**AS-Interface communication modules**  
**for printed circuit board installation**

Connection	Connection pad
AS-i +	27, 29
AS-i -	28, 30
Sensor+	17, 18, 23, 24
Sensor-	13, 14, 19, 20
IN1	21
IN2	22
IN3	15
IN4	16
$U_{aux+}$ (L24+)	2, 4
$U_{aux-}$ (M24)	1, 3
OUT1	9
OUT2	10
OUT3	5
OUT4	6 (not assigned for 3RK2400-1FD00-0AA2 4I/3O module)
OUT-	7, 8
Not assigned	11, 12, 25, 26

With the 4I/4O or 4I/3O module for printed circuit board installation, it is possible for up to four mechanical contacts or 3-conductor sensors according to IEC 947-5-2 to be connected.

Up to four indicator lights via the 4I/4O module or up to three indicator lights via the 4I/3O module can also be controlled. The power for short-circuit proof solid-state switching outputs is provided from an auxiliary voltage (24 V PELV).

Mounting is very easy using a "Card Edge Board-to-Board Connector". This connector can be ordered for vertical and horizontal mounting from the company AMP, for example:

- 180° version for vertical mounting (AMP):  
Type 530843-2
- 90° version for horizontal mounting (AMP):  
Type 650118-1

If the inputs are loaded with more than 200 mA, the module does not respond to invoking by a master.

**3RK1200-0CD00-0AA2**  
**AS-Interface communication modules**  
**for printed circuit board installation**

Connection	Connection pad
AS-i +	27, 29
AS-i -	28, 30
Sensor+	17, 18, 23, 24
Sensor-	13, 14, 19, 20
IN1	21
IN2	22
IN3	15
IN4	16
Not assigned	1, 2, 3, 4, 5, 6, 7, 8, 9, 10, 11, 12, 25, 26



With the 4I module for printed circuit board installation, it is possible for up to four mechanical contacts or 3-conductor sensors to be connected, the power for inputs being provided from the AS-Interface cable.

Mounting is very easy using a "Card Edge Board-to-Board Connector". This connector can be ordered for vertical and horizontal mounting from the company AMP, for example:

- 180° version for vertical mounting (AMP):  
Type 530843-2
- 90° version for horizontal mounting (AMP):  
Type 650118-1

If the inputs are loaded with more than 200 mA, the module does not respond to invoking by a master.

**Selection and ordering data**

Version	Slave type	Article No.
 3RK1400-0CD00-0AA3	<b>4 inputs / 4 outputs</b> <ul style="list-style-type: none"> <li>• Supply of I/Os using AS-Interface cable (max. 200 mA) - Printed circuit board with solder pins, protected by enclosure</li> </ul>	Standard <b>3RK1400-0CD00-0AA3</b>
	<ul style="list-style-type: none"> <li>• Supply of I/Os using external auxiliary voltage (24 V PELV) - Printed circuit board with solder pins, protected by enclosure - Printed circuit board with solder pins for horizontal mounting</li> </ul>	Standard Standard Standard
	<ul style="list-style-type: none"> <li>• Supply of outputs using external auxiliary voltage (24 V PELV) - Printed circuit board with gold-plated direct connector for 30-pole male connector socket for simple installation with direct connector</li> </ul>	Standard <b>3RK1400-0CD01-0AA3</b> <b>3RG9005-0SA00</b> <b>3RK1400-1CD00-0AA2</b>
 3RG9005-0SA00	<b>4 inputs / 3 outputs</b> <ul style="list-style-type: none"> <li>• Supply of outputs using external auxiliary voltage (24 V PELV) - Printed circuit board with gold-plated direct connector for 30-pole male connector socket for simple installation with direct connector</li> </ul>	A/B <b>3RK2400-1FD00-0AA2</b>
<b>4 inputs</b> <ul style="list-style-type: none"> <li>• Printed circuit board with gold-plated direct connector</li> <li>• For 30-pole male connector socket</li> <li>• For simple installation with direct connector</li> </ul>	Standard	<b>3RK1200-0CD00-0AA2</b>

# AS-Interface

Slaves

Modules with special functions

## Counter modules

### Overview



Counter module with spring-type terminals

The counter module is used to send hexadecimally coded count values (LSB=D0, MSB=D3) to a higher-level controller. The count value is increased by one for each valid count pulse at terminal 8. Beginning at 0, the module counts up to 15 and then begins again at 0. The controller adopts the current value and determines the number of pulses between two host invocations through subtraction from the previous value. The total number of count pulses is determined by adding these differences.

For the values sent to be unambiguous, no more than 15 count values are allowed between two host invocations or AS-Interface master invocations at terminal 8. The maximum permissible transmission frequency is calculated from these times:

$$f_{Tmax} = 15 / T_{max}$$

$T_{max}$  : max. possible transmission time from the slave to the host

A further condition for the maximum frequency is the required pulse shape. For the counter to accept a pulse as valid, a Low must have been applied at the input for at least 300  $\mu$ s and a High for at least 1 ms.

This results in a maximum frequency of  $f_{Zmax} = 1 / 1.3 \text{ ms} = 769 \text{ Hz}$  independently of the control system (see figure below).

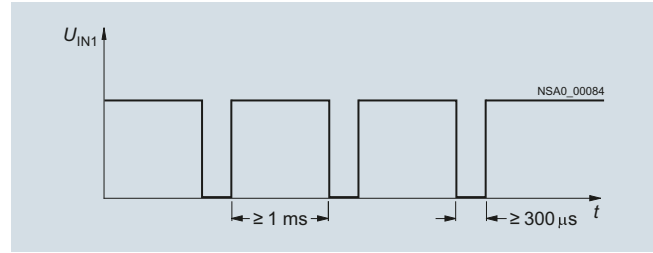

Maximum frequency for the counter module

If the time criterion stipulated in the figure is violated, the count value is rejected.

The counter is active only for the reset parameter P2 (default). The counter is deleted when P2 is set, and the incoming count pulses are not registered until after P2 is reset again.

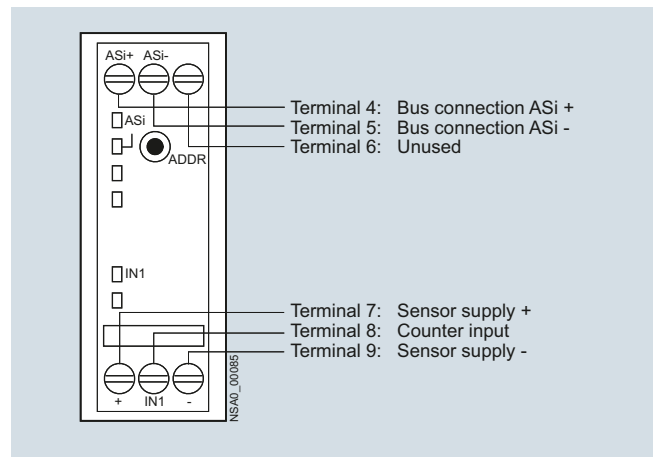

**Note:**

A customized function block is necessary or must be programmed.



Counter module connection options

### Selection and ordering data

Version	Article No.
<p><b>Counter modules</b></p> <p>Width 22.5 mm</p> <ul style="list-style-type: none"> <li>• With screw terminals</li> <li>• With spring-type terminals</li> </ul>	<p>⊕ <b>3RK1200-0CE03-0AA2</b></p> <p>⊖ <b>3RK1200-0CG03-0AA2</b></p>
<p></p> <p>3RK1200-0CE03-0AA2</p> <p></p> <p>3RK1200-0CG03-0AA2</p>	



## Overview



Ground-fault detection module

"Ground faults in any control circuit must not lead to unintentional starting or potentially hazardous movements or prevent the machine from stopping." (IEC 60204-1/VDE 0113-1).

The AS-Interface ground-fault detection module is used to meet these requirements. Using this module from the SlimLine series, ground faults in AS-Interface systems can be reliably detected and reported.

The following ground faults are detected:

- Ground fault from AS-i "+"
- Ground fault from AS-i "-"
- Ground fault from sensors and actuators which are supplied from the AS-Interface voltage.

Note:

Not suitable for AS-Interface Power24V.

## Selection and ordering data

Version		Article No.
 <p>3RK1408-8KE00-0AA2</p>	<p><b>Ground-fault detection modules</b></p> <p>Width 22.5 mm</p> <ul style="list-style-type: none"> <li>• With screw terminals</li> <li>• With spring-type terminals</li> </ul>	<p>⊕ <b>3RK1408-8KE00-0AA2</b></p> <p>⊖ <b>3RK1408-8KG00-0AA2</b></p>

## AS-Interface

Slaves

Modules with special functions

### Overvoltage protection modules

#### Overview



AS-Interface overvoltage protection module

The AS-Interface overvoltage protection module (protection module) protects downstream AS-Interface devices or individual sections in AS-i networks from conducted overvoltages which can be caused by switching operations and remote lightning strikes. The location of the protection module forms within the lightning protection zone concept the transition from zone 1 to 2/3. Direct lightning strikes must be coped with using additional protective measures at the transitions from lightning protection zone 0A to 1.

With the AS-Interface overvoltage protection module, it is now also possible to integrate AS-Interface in the overall overvoltage protection concept of a plant or machine.

The module has the same design and degree of protection (IP67) as the AS-Interface K45 compact modules. It is a passive module without AS-i IC and as such does not need its own address on the AS-Interface network. The module can be used to protect the AS-Interface cable and the cable for the auxiliary voltage from overvoltage. Overvoltages are discharged through a ground cable with a green/yellow oil-proof outer sheath. This cable is fixed in the module and must be connected with low resistance to the system's ground.

#### Rated discharge current $I_{sn}$

The rated discharge current is the peak value of a surge current of the form 8/20  $\mu$ s (microseconds), for which the protection module is designed in accordance with a specified test program. With waveform 8/20, 100 % of the value is achieved after 8  $\mu$ s and 50 % after 20  $\mu$ s.

#### Protection level $U_p$

The protection level of a protection module is the highest momentary value of the voltage at the terminals, established in individual tests and characterizes the capability of a protection module to limit overvoltages to a residual level.

#### Configuration guidelines

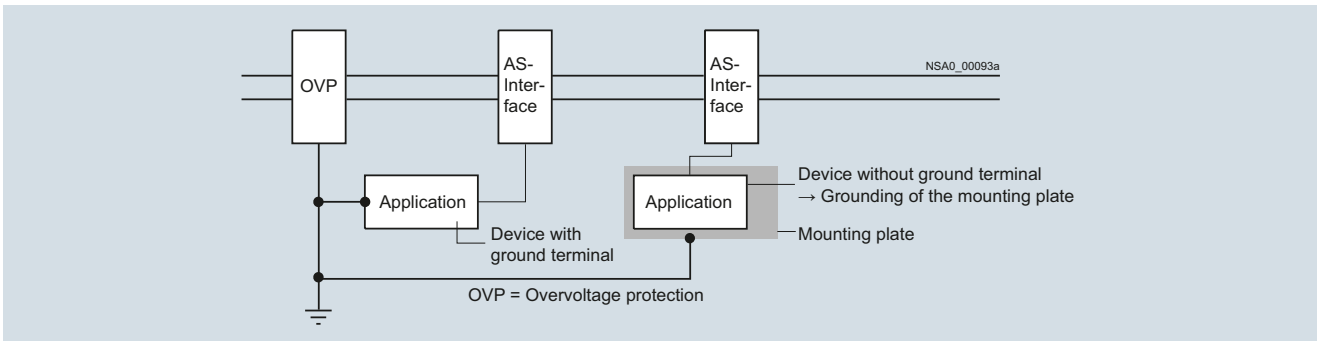

The grounding of protection modules and the units to be protected must be effected through a shared grounding point.

If insulated devices are protected, their mounts must be included in the grounding points.

#### Sample application

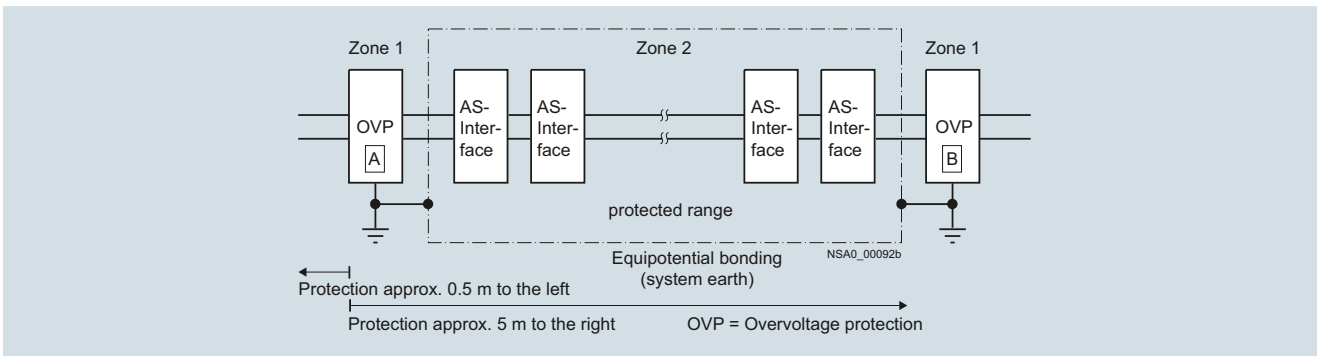

#### Selection and ordering data

Version	Article No.
 <p><b>AS-Interface overvoltage protection module</b> Delivery includes mounting plate (for wall and standard rail mounting)</p>	<b>3RK1901-1GA01</b>

### Overview

#### Every LOGO! can now be connected to the AS-Interface system



Using the AS-Interface connection for LOGO!, an intelligent slave can be integrated in the AS-Interface system. With the modular interface it becomes possible to integrate the different basic units in the system according to their functionality. Similarly, functionalities can be quickly and easily adapted to new requirements by exchanging the basic unit.

The interface module provides four inputs and four outputs on the system. These inputs and outputs do not actually exist in hardware terms, however, but are only virtually present through the interface on the bus.

AS-Interface connections for LOGO!

### Selection and ordering data

Version		Article No.
 <p>3RK1400-OCE10-0AA2</p>	<p><b>AS-Interface connections for LOGO!</b></p> <ul style="list-style-type: none"> <li>• 4 virtual inputs</li> <li>• 4 virtual outputs</li> </ul>	<p><b>3RK1400-OCE10-0AA2</b></p>

## AS-Interface

Slaves

Contactors and contactor assemblies

### Power contactors for switching motors > SIRIUS 3RT20 contactors

#### Overview

##### **Contactors with communication interface, sizes S00 and S0**

Contactor versions with communication interface are required to establish a connection to the control system via IO-Link or AS-Interface. The link is established by means of function modules mounted on the front of the contactor.

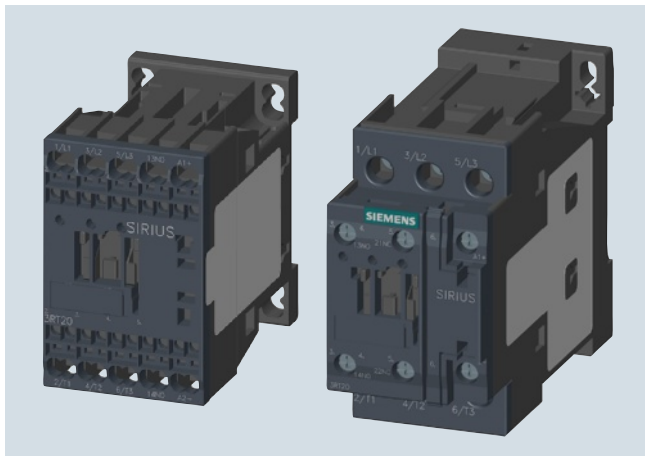

Contactor size S00 with communication interface and spring-type terminals and contactor size S0 with screw terminals

##### Standards

IEC 60947-1, EN 60947-1,  
IEC 60947-4-1, EN 60947-4-1,  
IEC 60947-5-1, EN 60947-5-1 (auxiliary switches)

The 3RT20 contactors for switching motors are climate-proof and are suitable and tested for use worldwide.

If the devices are used in ambient conditions which deviate from common industrial conditions (IEC 60721-3-3 "Stationary Use, Weather-Protected"), information must be obtained about possible restrictions with regard to the reliability and endurance of the device and possible protective measures. In this case contact our Technical Assistance.

3RT2 contactors are finger-safe according to EN 50274.

The contactors are suitable for screw fixing or for mounting onto TH 35 standard mounting rails according to IEC 60715.

##### Contact reliability

If voltages  $\leq 110$  V and currents  $\leq 100$  mA are to be switched, the auxiliary contacts of the 3RT2 contactor or 3RH21 contactor relay should be used as they guarantee a high level of contact reliability.

These auxiliary contacts are suitable for solid-state circuits with currents  $\geq 1$  mA at a voltage  $\geq 17$  V.

##### Connection methods

The 3RT2 contactors are available with screw terminals or spring-type terminals.

##### Short-circuit protection of the contactors

For short-circuit protection of contactors without overload relays, see Technical specifications (see Note).

To assemble fuseless motor feeders you must select combinations of motor starter protector and contactor as explained in "3RA2 Load Feeders".

##### Motor protection

3RU21 thermal overload relays or 3RB30 solid-state overload relays can be fitted to the 3RT2 contactors for protection against overload. The overload relays must be ordered separately.

##### Ratings of three-phase motors

The quoted rating (in kW) refers to the output power on the motor shaft (according to the nameplate).

##### Control supply voltage

Contactors with communication interface are available with 24 V DC operation.

##### Note:

For selection and ordering data for 3RT20 contactors and 3RA23 reversing contactor assemblies with communication interface see Chapter 5, "IO-Link".

##### **Manuals and configurator**

For more information, see

- System manual "SIRIUS Innovations – System Overview", <http://support.automation.siemens.com/WW/view/en/60311318>
- Manual "SIRIUS Innovations – SIRIUS 3RT2 Contactors/ Contactor Assemblies", <http://support.automation.siemens.com/WW/view/en/60306557>

Online configurator see [www.siemens.com/sirius/configurators](http://www.siemens.com/sirius/configurators).

## Overview

These 3RA24 contactor assemblies for wye-delta starting are designed for standard applications.

### Note:

Contactor assemblies for wye-delta starting in special applications such as very heavy starting or wye-delta starting of special motors must be customized. Help with designing such special applications is available from Technical Assistance.

The 3RA24 contactor assemblies for wye-delta starting can be ordered as follows:

- Complete, fully wired and tested, with electrical and mechanical interlock
- As individual parts for customer assembly.

A dead interval of 50 ms on reversing is already integrated in the function module for wye-delta starting. The auxiliary contacts integrated in the contactors (see Chapter 5, "IO-Link") are unassigned.

## Selection and ordering data

### Fully-wired and tested contactor assemblies

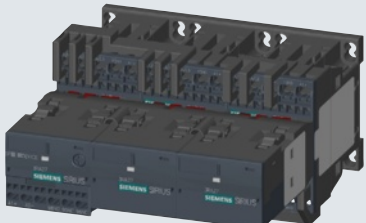
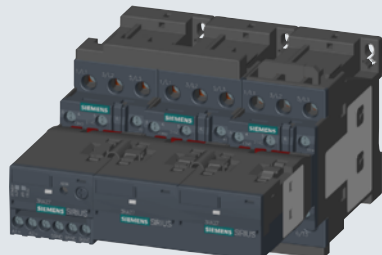
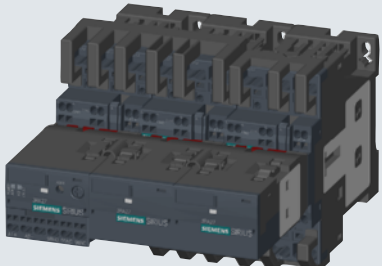
							
3RA241.-8XE31-2BB4	3RA242.-8XE32-1BB4	3RA242.-8XE32-2BB4					
Rated data AC-3							
Operational current $I_e$ up to	Ratings of three-phase motors <sup>1)</sup> at 50 Hz and				Rated control supply voltage $U_s$ <sup>1)</sup>	Screw terminals	Spring-type terminals
400 V	230 V	400 V	500 V	690 V	V		
A	kW	kW	kW	kW		Article No.	Article No.

### DC operation

#### Size S00

For AS-Interface connection

12	3.3	5.5	7.2	9.2	24 DC
16	4.7	7.5	10.3	9.2	24 DC
25	5.5	11	11	11	24 DC

3RA2415-8XH31-1BB4	3RA2415-8XH31-2BB4
3RA2416-8XH31-1BB4	3RA2416-8XH31-2BB4
3RA2417-8XH31-1BB4	3RA2417-8XH31-2BB4

#### Size S0

For AS-Interface connection

25	7.1	11	15.6	19	24 DC
32 / 40	11.4	15 / 18.5	19	19	24 DC
50	--	22	19	19	24 DC

3RA2423-8XH32-1BB4	3RA2423-8XH32-2BB4
3RA2425-8XH32-1BB4	3RA2425-8XH32-2BB4
3RA2426-8XH32-1BB4	3RA2426-8XH32-2BB4

For online configurator see [www.siemens.com/sirius/configurators](http://www.siemens.com/sirius/configurators).

<sup>1)</sup> Guide value for 4-pole standard motors at 50 Hz 400 V AC.

The actual starting and rated data of the motor to be switched must be considered when selecting the units.

### Components for customer assembly

Assembly kits with wiring modules and mechanical connectors are available for contactor assemblies for wye-delta starting. Contactors, overload relays, function modules for wye-delta starting, auxiliary switches for electrical interlock – if required also infeed terminals – must be ordered separately.

The wiring kits for sizes S00 and S0 contain the top and bottom main conducting path connections between the line and delta contactors (top) and between the delta and star contactors (bottom).

### Selection of contactors for customer assembly

Rated data AC-3 at 50 Hz 400 V AC			Size	Line/delta contactor	Star contactor	Article No. complete
Rating	Operational current $I_e$	Motor current				
kW	A	A				
5.5	12	9.5 ... 13.8	S00-S00-S00	3RT2015-.BB41-0CC0	3RT2015-.BB41-0CC0	3RA2415-8XH31-.BB4
7.5	16	12.1 ... 17		3RT2017-.BB41-0CC0	3RT2015-.BB41-0CC0	3RA2416-8XH31-.BB4
11	25	19 ... 25		3RT2018-.BB41-0CC0	3RT2016-.BB41-0CC0	3RA2417-8XH31-.BB4
11	25	19 ... 25	S0-S0-S0	3RT2024-.BB40-0CC0	3RT2024-.BB40-0CC0	3RA2423-8XH32-.BB4
15	32	24.1 ... 34		3RT2026-.BB40-0CC0	3RT2024-.BB40-0CC0	3RA2425-8XH32-.BB4
18.5	40	34.5 ... 40		3RT2026-.BB40-0CC0	3RT2024-.BB40-0CC0	3RA2425-8XH32-.BB4
22	50	31 ... 43		3RT2027-.BB40-0CC0	3RT2026-.BB40-0CC0	3RA2426-8XH32-.BB4

## AS-Interface

Slaves

Contactors and contactor assemblies

### SIRIUS 3RA27 function modules for AS-Interface

#### Overview





The function modules for mounting onto contactors enable the configuration of starters and contactor assemblies for direct-on-line, reversing and wye-delta starting without any additional, complicated wiring of the individual components.

They include the key control functions required for the particular feeder, e.g. timing and interlocking, and can be connected to the control system via the bus system.

#### Manuals

For more information see manual "SIRIUS Function Modules for AS-Interface", <http://support.automation.siemens.com/WW/view/en/39318922>

#### Selection and ordering data

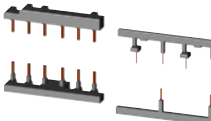
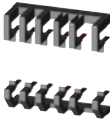
Version	Screw terminals Article No.	Spring-type terminals Article No.
<b>Function modules for direct-on-line starting</b>		
 3RA2712-1AA0  3RA2712-2AA0 <b>AS-Interface connection</b>	3RA2712-1AA0	3RA2712-2AA0
<b>Function modules for reversing starting<sup>1)</sup></b>		
 3RA2712-1BA00  3RA2712-2BA00 <b>AS-Interface connection,</b> comprising one basic and one coupling module	3RA2712-1BA00	3RA2712-2BA00
<b>Assembly kits for making 3-pole contactor assemblies</b>		
 3RA2923-2AA1  3RA2923-2AA2 The assembly kit contains: Mechanical interlock, 2 connecting clips for 2 contactors, wiring modules on the top and bottom	3RA2913-2AA1  3RA2923-2AA1 --	3RA2913-2AA2  -- 3RA2923-2AA2
<ul style="list-style-type: none"> <li>• For size S00</li> <li>• For size S0               <ul style="list-style-type: none"> <li>- For main, auxiliary and control current</li> <li>- Only for main current<sup>2)</sup></li> </ul> </li> </ul>		

Suitable contactors or reversing contactor assemblies with communication interface are required (see Chapter 5, "IO-Link").



#### Note:

When using the function modules, no other auxiliary switches are allowed to be connected to the basic units.

<sup>1)</sup> For prewired contactor assemblies for reversing starting with communication interface see Chapter 5, "IO-Link". When these contactor assemblies are used, the assembly kit for the wiring is already integrated.

<sup>2)</sup> Version in size S0 with spring-type terminals:  
 Only the wiring modules for the main circuit are included.  
 No connectors are included for the auxiliary and control circuit.

## Selection and ordering data (continued)

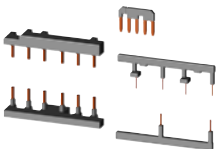
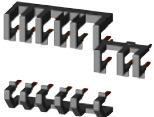
Version	Screw terminals Article No.	Spring-type terminals Article No.
<b>Function modules for wye-delta starting<sup>1)</sup></b>		
 3RA2712-1CA00  3RA2712-2CA00 <b>AS-Interface connection,</b> comprising one basic module and two coupling modules	3RA2712-1CA00	3RA2712-2CA00
<b>Assembly kits for making 3-pole contactor assemblies</b>		
 3RA2923-2BB1  3RA2923-2BB2 <b>Assembly kits for making 3-pole contactor assemblies</b> The assembly kit contains: Mechanical interlock, 4 connecting clips for 3 contactors, star jumper, wiring modules on the top and bottom <sup>2)</sup>	3RA2913-2BB1  3RA2923-2BB1 --  3RA2924-2BB1	3RA2913-2BB2  -- 3RA2923-2BB2  --
<ul style="list-style-type: none"> <li>• For size S00</li> <li>• For size S0               <ul style="list-style-type: none"> <li>- For main, auxiliary and control current</li> <li>- Only for main current</li> </ul> </li> </ul> The assembly kit contains: Mechanical interlock, 2 connecting clips for 3 contactors, wiring modules on the top and bottom <sup>2)</sup> , 3-phase infeed terminals	<ul style="list-style-type: none"> <li>• For size S0</li> </ul>	

Suitable contactors with communication interface are required (see Chapter 5, "IO-Link").

Note:

When using the function modules, no other auxiliary switches are allowed to be connected to the basic units.

<sup>1)</sup> For complete contactor assemblies for wye-delta starting including function modules, see page 4/79.

<sup>2)</sup> When using the function modules for wye-delta starting, the wiring modules for the auxiliary current are not required.

Version	Article No.
<b>Accessories</b>	
 3RA2910-0 <b>Sealable covers</b> for 3RA27, 3RA28, 3RA29	3RA2910-0

## AS-Interface

Slaves

Motor starters for use in the control cabinet

SIRIUS 3RA6 compact starters > General data

### Overview

#### 3RA6 fuseless compact starters and infeed system for 3RA6



3RA62 reversing starter

#### Integrated functionality

The SIRIUS 3RA6 compact starters are a generation of innovative load feeders with the integrated functionality of a motor starter protector, contactor and solid-state overload relay. In addition, various functions of optional mountable accessories (e.g. auxiliary switches, surge suppressors) are already integrated in the SIRIUS compact starter.

#### Field of application

The SIRIUS compact starters can be used wherever standard three-phase motors up to 32 A (approx. 15 kW/400 V) are directly started.

The compact starters are not suitable for the protection of DC loads.

Approvals according to IEC, UL, CSA and CCC standards have been issued for the compact starters.

#### Low variance of devices

Thanks to wide setting ranges for the rated current and wide voltage ranges, the equipment variance is greatly reduced compared to conventional load feeders.

#### Very high operational reliability

The high short-circuit breaking capacity and defined shut-down when the end of service life is reached means that the SIRIUS compact starter achieves a very high level of operational reliability that would otherwise have only been possible with considerable additional outlay. This sets it apart from devices with similar functionality.

#### Safe disconnection

The auxiliary switches (NC contacts) of the 3RA6 compact starters are designed as mirror contacts. It is therefore possible to use safe disconnection equipment, e.g. EMERGENCY-STOP, up to Category 2 (EN 954-1), or combine it with other redundant switching devices for use up to Category 3 or 4.

#### Communications integration through AS-Interface

To enable communications integration through AS-Interface there is an AS-i add-on module available in several versions for mounting instead of the control circuit terminals on the SIRIUS compact starter.

The design of the AS-i add-on module permits a group of up to 62 feeders with a total of four cables to be connected to the control system. This reduces wiring work considerably compared to the parallel wiring method.

#### Communications integration using IO-Link

SIRIUS 3RA64, 3RA65 compact starters for IO-Link see Chapter 5: "IO-Link".

#### Permanent wiring/easy replacement

Using the SIRIUS infeed system for 3RA6 it is possible to carry out the wiring in advance without a compact starter needing to be connected.

A compact starter is very easily replaced simply by pulling it out of the device without disconnecting the wiring.

Even with screw connections or mounting on a standard mounting rail there is no need to disconnect any wiring (on account of the removable main and control circuit terminals) in order to replace a compact starter.

#### Consistent solution from the infeed to the motor feeder

The SIRIUS infeed system for 3RA6 with integrated PE bar is offered as a user-friendly possibility of feeding in summation currents up to 100 A with a maximum conductor cross-section of 70 mm<sup>2</sup> and connecting the motor cable directly without additional intermediate terminals.

#### Screw and spring-type terminals

The SIRIUS compact starters and the infeed system for 3RA6 are available with screw and spring-type terminals.



Screw terminals



Spring-type terminals

#### System configurator for engineering

A free system configurator is available to reduce further the amount of engineering work for selecting the required compact starters and matching infeed.

#### **Types of infeed for the 3RA6 fuseless compact starters**

On the whole four different infeed possibilities are available:

- Parallel wiring
- Use of three-phase busbars (combination with SIRIUS motor starter protectors and SIRIUS contactors possible)
- 8US busbar adapters
- SIRIUS infeed system for 3RA6

To comply with the clearance and creepage distances demanded according to UL 508 there are the following infeed possibilities:



## Overview (continued)

Type of infeed	Infeed terminal (acc. to UL 508, type E)	Type
Parallel wiring	Terminal block for "Self-Protected Combination Motor Controller (Type E)"	<b>3RV2928-1H</b>
Three-phase busbars	Three-phase infeed terminal for constructing "Type E Starters", UL 508	<b>3RV2925-5EB</b>
Infeed system for 3RA6	Infeed on left, 50/70 mm <sup>2</sup> , screw terminal with 3 sockets, outgoing terminal with screw/spring-type connections, including PE bar	<b>3RA6813-8AB</b> (screw terminals), <b>3RA6813-8AC</b> (spring-type terminals)

## SIRIUS 3RA6 compact starters

The SIRIUS 3RA6 compact starters are universal motor feeders according to IEC 60947-6-2. As control and protective switching devices (CPS) they can connect, convey and disconnect the thermal, dynamic and electrical loads from short-circuit currents up to  $I_q = 53$  kA, i.e. they are practically weld-free. They combine the functions of a motor starter protector, a contactor and a solid-state overload relay in one enclosure. Direct-on-line starters with 45 mm width and reversing starters with 90 mm width are available as variants.

The reversing starter version comes with not only an internal electrical interlock but also with a mechanical interlock to prevent simultaneous actuation of both directions of rotation.

The compact starters have isolating features in accordance with IEC 60947.2 and can be used as disconnecter units (main control switch according to DIN EN 60204 or DIN VDE 0113). Isolation is effected by moving the handle into the "OFF" position, disconnection by means of the control contacts is not enough.

3RA6 fuseless compact starters are supplied for 5 different current setting ranges. The 3RA61 and 3RA62 have 2 control voltage ranges (AC/DC), the 3RA64 and 3RA65 have one control voltage range (DC):

Current setting range	At 400 V AC for three-phase motors Standard output P	Rated control supply voltage for	
		3RA61, 3RA62 compact starters	3RA64, 3RA65 compact starters for IO-Link
A	kW	V AC/DC	V DC
0.1 ... 0.4	0.09	24	24
0.32 ... 1.25	0.37	110 ... 240	
1 ... 4	1.5		
3 ... 12	5.5		
8 ... 32	15		

## Note:

The 3RA1 load feeders can be used for fuseless load feeders > 32 A up to 100 A.

The SENTRON 3VL circuit breakers and the SIRIUS 3RT contactors can be used for fuseless load feeders > 100 A.

## Operating conditions

The SIRIUS 3RA6 compact starters are suitable for use in any climate. They are intended for use in enclosed rooms in which no severe operating conditions (such as dust, caustic vapors, hazardous gases) prevail. Suitable covers must be provided for installation in dusty and damp locations.

The SIRIUS compact starters are generally designed to degree of protection IP20. The permissible ambient temperature during operation is -20 to +60 °C.

The rated short-circuit current  $I_{CS}$  according to IEC 60947-6-2 is 53 kA at 400 V.

## Note:

The maximum permissible short-circuit currents of the device versions for the various forms of power supply and voltages are available on request from Technical Assistance:

Tel.: +49 (9 11) 8 95-59 00

E-mail: [technical-assistance@siemens.com](mailto:technical-assistance@siemens.com).

## Overload tripping times

The tripping time in the event of overload can be set on the device to normal startup conditions (CLASS 10) and to heavy starting conditions (CLASS 20). As the breaker mechanism still remains closed after an overload, resetting is possible by either local manual reset or autoreset after 3 minutes cooling time.

With autoreset there is no need to open the control cabinet.

## Diagnostics options

The compact starter provides the following diagnostics options:

- With LEDs
  - Connection to the control voltage
  - Position of the main contacts
- With mechanical display
  - Tripping due to overload
  - Tripping due to short circuit
  - Tripping due to malfunction (end of service life reached because of worn switching contacts or a worn switching mechanism or faults in the control electronics)

These states can also be evaluated in the higher-level control system:

- With parallel wiring using the integrated auxiliary and signaling switches of the compact starter
- With AS-Interface or IO-Link in even greater detail using the respective communication interface

## Four complement versions for 3RA61/3RA62 compact starters

- For standard mounting rail or screw fixing: basic version including 1 pair of main circuit terminals and 1 pair of control circuit terminals
- For standard mounting rail or screw fixing when using the AS-i add-on module: without control circuit terminals because the AS-i add-on module is plugged on instead
- For use with the infeed system for 3RA6: without main circuit terminals because they are supplied with the infeed system and the expansion modules
- For use with the infeed system for 3RA6 and the AS-i add-on module: without terminal complement (also for reordering when replacing the compact starter)
- The control circuit terminals are always required by the compact starters for IO-Link; the main circuit terminals depend on the use of the infeed system.

## AS-Interface

Slaves

Motor starters for use in the control cabinet

### SIRIUS 3RA6 compact starters > General data

#### Overview (continued)

##### More components of the 3RA6

Apart from the control supply voltage, "Overload" (1 CO) and "Short circuit / Function fault" (1 NO) signaling contacts are already integrated into the 3RA61/3RA62 – and lockable via two 6-pole removable control circuit terminals. The 3RA61 has two auxiliary contacts (1 NO + 1 NC) for displaying the position of the main contacts. Unlike the 3RA61 direct-on-line starter, the 3RA62 reversing starter has one auxiliary contact (1 S) per direction of rotation per main contact.

Available for the 3RA61 and 3RA64 direct-on-line starters is a slot for an optional auxiliary switch block (optionally 2 NO, 2 NC or 1 NO + 1 NC) and for the 3RA62 and 3RA65 reversing starters there are two slots (for auxiliary switch blocks see "Accessories" on page 4/88).

In contrast to the direct-on-line starter, the 3RA62 reversing starter has one auxiliary contact (1 NC) per direction of rotation per main contact.

##### Positively-driven operation of the auxiliary contacts

There is positively-driven operation between individual auxiliary circuits for the compact starter in the version as a direct-on-line starter for parallel wiring (3RA61) between the auxiliary circuits of the NC contacts (NC 21-22) and the NO contacts (NO 13-14) in the basic unit.

In addition, the optional auxiliary switch block offers positively-driven contacts in the 3RA69 13-1A version, each with one normally closed contact and one normally open contact.

#### Benefits

The SIRIUS 3RA6 compact starters offer a number of benefits:

- Compact design saves space in the control cabinet
- Little planning and assembly work and far less wiring thanks to a single complete unit with one article number
- Little variance through wide voltage range and 5 wide setting ranges for the rated current mean low stock levels
- High plant availability through integrated functionalities such as prevention of main contact welding and disconnection at end of service life
- Greater productivity through automatic device reset in case of overload and differentiated detection of overload and short circuit
- Easy checking of the wiring and testing of the motor direction prior to start-up thanks to optional "control kits"
- Speedy replacement of devices thanks to removable terminals with spring-type and screw connections in the main and control circuit
- Efficient power distribution through the related SIRIUS infeed system for 3RA6
- Direct connection of the motor feeder cable to the SIRIUS infeed system for 3RA6 thanks to integrated PE bar
- Connecting and looping through incoming feeders up to a cross-section of 70 mm<sup>2</sup>
- When using the infeed system for 3RA6, possibility of directly connecting the motor cable without intermediate terminals
- Integration in Totally Integrated Automation thanks to the optional connection to AS-Interface or IO-Link

The SIRIUS 3RA6 compact starters create the basis for high-availability and future-proof machine concepts.

**Selection and ordering data**



Width 45 mm

Rated short-circuit current  $I_{CS} = 53 \text{ kA}$  at 400 V

A set of 3RA69 40-0A adapters is required for screw fixing.

Standard three-phase motor 4-pole at 400 V AC <sup>1)</sup> Standard output $P$	Setting range for solid-state overload release	Instantaneous overcurrent release
---	--	--------------------------------------

Article No.	Article No.
-------------	-------------

kW	A	A
----	---	---

*For use with the infeed system for 3RA6 and with the AS-i add-on module or as a replacement device, without main and control circuit terminals*

0.09	0.1 ... 0.4	56
0.37	0.32 ... 1.25	56
1.5	1 ... 4	56
5.5	3 ... 12	168
15	8 ... 32	448

3RA6120-0A 30	--
3RA6120-0B 30	--
3RA6120-0C 30	--
3RA6120-0D 30	--
3RA6120-0E 30	--

Screw terminals	Spring-type terminals
-----------------	-----------------------

*For standard mounting rail or screw fixing, including 1 pair of main circuit terminals and 1 pair of control circuit terminals*

0.09	0.1 ... 0.4	56
0.37	0.32 ... 1.25	56
1.5	1 ... 4	56
5.5	3 ... 12	168
15	8 ... 32	448

3RA6120-1A 32	3RA6120-2A 32
3RA6120-1B 32	3RA6120-2B 32
3RA6120-1C 32	3RA6120-2C 32
3RA6120-1D 32	3RA6120-2D 32
3RA6120-1E 32	3RA6120-2E 32

*For use in the infeed system for 3RA6, without main circuit terminals with 1 pair of control circuit terminals*

0.09	0.1 ... 0.4	56
0.37	0.32 ... 1.25	56
1.5	1 ... 4	56
5.5	3 ... 12	168
15	8 ... 32	448

3RA6120-1A 33	3RA6120-2A 33
3RA6120-1B 33	3RA6120-2B 33
3RA6120-1C 33	3RA6120-2C 33
3RA6120-1D 33	3RA6120-2D 33
3RA6120-1E 33	3RA6120-2E 33

**Article No. supplements for rated control supply voltage**

- 24 V AC/DC
- 110 ... 240 V AC/DC

*For standard mounting rail or screw fixing when using the AS-i add-on module with 1 pair of main circuit terminals without control circuit terminals  
Rated control supply voltage 24 V AC/DC*

0.09	0.1 ... 0.4	56
0.37	0.32 ... 1.25	56
1.5	1 ... 4	56
5.5	3 ... 12	168
15	8 ... 32	448

3RA6120-1AB34	3RA6120-2AB34
3RA6120-1BB34	3RA6120-2BB34
3RA6120-1CB34	3RA6120-2CB34
3RA6120-1DB34	3RA6120-2DB34
3RA6120-1EB34	3RA6120-2EB34

<sup>1)</sup> The actual starting and rated data of the motor to be protected must be considered when selecting the units.



## AS-Interface

Slaves

Motor starters for use in the control cabinet

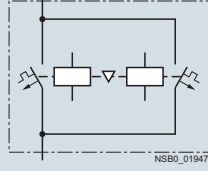

### SIRIUS 3RA6 compact starters > 3RA62 reversing starters

#### Selection and ordering data

		<b>Reversing duty</b> 	Width 90 mm	
			Rated short-circuit current $I_{CS} = 53 \text{ kA}$ at 400 V	
			Two sets of 3RA69 40-0A adapters are required for screw fixing.	
3RA62 50-1CP32	3RA62 50-2DP32			
Standard three-phase motor 4-pole at 400 V AC <sup>1)</sup> Standard output P	Setting range for solid-state overload release	Instantaneous overcurrent release	<b>Article No.</b>	<b>Article No.</b>
				
kW	A	A		

*For use with the infeed system for 3RA6 and with the AS-i add-on module or as a replacement device, without main and control circuit terminals*

0.09	0.1 ... 0.4	56
0.37	0.32 ... 1.25	56
1.5	1 ... 4	56
5.5	3 ... 12	168
15	8 ... 32	448

3RA6250-0A 30	--
3RA6250-0B 30	--
3RA6250-0C 30	--
3RA6250-0D 30	--
3RA6250-0E 30	--
<b>Screw terminals</b> 	<b>Spring-type terminals</b> 

*For standard mounting rail or screw fixing, including 1 pair of main circuit terminals and 1 pair of control circuit terminals*

0.09	0.1 ... 0.4	56
0.37	0.32 ... 1.25	56
1.5	1 ... 4	56
5.5	3 ... 12	168
15	8 ... 32	448

3RA6250-1A 32	3RA6250-2A 32
3RA6250-1B 32	3RA6250-2B 32
3RA6250-1C 32	3RA6250-2C 32
3RA6250-1D 32	3RA6250-2D 32
3RA6250-1E 32	3RA6250-2E 32

*For use in the infeed system for 3RA6, without main circuit terminals with 1 pair of control circuit terminals*

0.09	0.1 ... 0.4	56
0.37	0.32 ... 1.25	56
1.5	1 ... 4	56
5.5	3 ... 12	168
15	8 ... 32	448

3RA6250-1A 33	3RA6250-2A 33
3RA6250-1B 33	3RA6250-2B 33
3RA6250-1C 33	3RA6250-2C 33
3RA6250-1D 33	3RA6250-2D 33
3RA6250-1E 33	3RA6250-2E 33

**Article No. supplements for rated control supply voltage**

- 24 V AC/DC
- 110 ... 240 V AC/DC

*For standard mounting rail or screw fixing when using the AS-i add-on module with 1 pair of main circuit terminals without control circuit terminals*  
**Rated control supply voltage 24 V AC/DC**

0.09	0.1 ... 0.4	56
0.37	0.32 ... 1.25	56
1.5	1 ... 4	56
5.5	3 ... 12	168
15	8 ... 32	448

3RA6250-1AB34	3RA6250-2AB34
3RA6250-1BB34	3RA6250-2BB34
3RA6250-1CB34	3RA6250-2CB34
3RA6250-1DB34	3RA6250-2DB34
3RA6250-1EB34	3RA6250-2EB34

<sup>1)</sup> The actual starting and rated data of the motor to be protected must be considered when selecting the units.

**Overview****Accessories for SIRIUS 3RA6 compact starters**

The following accessories are available specially for the 3RA6 compact starters:

- AS-i add-on module:  
see page 4/92 onwards "AS-interface add-on modules"
- External auxiliary switch blocks: Snap-on auxiliary switch as versions 2 NO, 2 NC and 1 NO + 1 NC with screw or spring-type terminals; the contacts of the auxiliary switch block open and close jointly with the main contacts of the compact starter. The NC contacts are designed as mirror contacts.
- Control kit: Aid for manually closing the main contacts in order to check the wiring and motor direction under conditions of short-circuit protection
- Adapter for screw fixing the compact starter, including push-in lugs
- Main circuit terminals: Available with screw and spring-type terminals
- Main circuit terminals mixed connection method:  
With the main circuit terminals mixed connection method it is also possible in the main circuit to switch from screw terminals on the line side to spring-type terminals on the outgoing side. This enables for example the side-by-side mounting of several compact starters and their cost-efficient connection using three-phase busbars on the infeed side. The motors are then connected directly by the quick and reliably contacting spring-type connection method.

**Accessories for UL applications**

The terminal block for "Self-Protected Combination Motor Controller", type E is available for complying with the clearance and creepage distances demanded according to UL 508.

**Accessories for infeed using three-phase busbar systems**

The three-phase busbars can be used as an easy, time-saving and clearly arranged means of feeding SIRIUS 3RA6 compact starters with screw connection. Motor starter protector sizes S00 and S0 can also be integrated.

The busbars are suitable for between 2 and 5 devices. However, any kind of extension up to a maximum summation current of 63 A is possible by clamping the tags of an additional busbar (rotated by 180°) underneath the terminals of the respective last motor starter protector.

A connecting piece is required for the combination with 3RV1 motor starter protector size S00. Motor starter protectors S00 and S0 of the 3RV2 series can be combined in any way (without a special connecting piece). The motor starter protectors are supplied by appropriate infeed terminals. Special infeed terminals are required for constructing "Type E Starters" according to UL/CSA.

The three-phase busbar systems are finger-safe but empty connection tags must be fitted with covers. They are designed for any short-circuit stress which can occur at the output side of connected SIRIUS 3RA6 compact starters or motor starter protectors.

**Busbar adapters for 60 mm systems**

The compact starters are mounted directly with the aid of busbar adapters on busbar systems with 60 mm center-to-center clearance in order to save space and to reduce infeed times and costs. These feeders are suitable for copper busbars with a width from 12 to 30 mm. The busbars can be 4 to 5 mm or 10 mm thick.

The 8US busbar system can be loaded with a maximum summation current of 630 A.

The "reversing starter" version requires a device holder along side the busbar adapter for lateral mounting.

The compact starters are snapped onto the adapter and connected on the line side. This prepared unit is then plugged directly onto the busbar system, and is thus connected both mechanically and electrically at the same time.

**Note:**

For more accessories such as incoming and outgoing terminals, flat copper profiles etc., see Catalog LV 10.

**Accessories for operation with closed control cabinet doors**







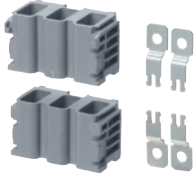

Door-coupling rotary operating mechanisms for standard and emergency-stop applications are available for operating the compact starter with closed control cabinet doors.

**AS-Interface**

Slaves

Motor starters for use in the control cabinet

**SIRIUS 3RA6 compact starters > Accessories****Selection and ordering data**

Version	Article No.
<i>Accessories specially for 3RA6 compact starters</i>	
 3RA6950-0A <b>Control kit</b> For mechanical actuation of the compact starter	<b>3RA6950-0A</b>
 3RA6940-0A <b>Adapters for screw fixing the compact starter</b> (set including push-in lugs) Direct-on-line starters require one set, reversing starters two sets.	<b>3RA6940-0A</b>
<b>Screw terminals</b> 	
 3RA6911-1A <b>Auxiliary switch blocks for compact starters</b> <ul style="list-style-type: none"> <li>• 2 NO</li> <li>• 2 NC</li> <li>• 1 NO +1 NC (these auxiliary contacts are positively driven.)</li> </ul>	<b>3RA6911-1A</b> <b>3RA6912-1A</b> <b>3RA6913-1A</b>
 3RA6920-1A <b>Main circuit terminals</b> (incoming and outgoing side)	<b>3RA6920-1A</b>
 3RA6920-1B <b>Control circuit terminals</b> <ul style="list-style-type: none"> <li>• For 3RA61</li> <li>• For 3RA62</li> </ul>	<b>3RA6920-1B</b> <b>3RA6920-1C</b>
<b>Spring-type terminals</b> 	
 3RA6911-2A <b>Auxiliary switch blocks for compact starters</b> <ul style="list-style-type: none"> <li>• 2 NO</li> <li>• 2 NC</li> <li>• 1 NO +1 NC (these auxiliary contacts are positively driven.)</li> </ul>	<b>3RA6911-2A</b> <b>3RA6912-2A</b> <b>3RA6913-2A</b>
 3RA6920-2A <b>Main circuit terminals</b> (incoming and outgoing side)	<b>3RA6920-2A</b>
 3RA6920-2B <b>Control circuit terminals</b> <ul style="list-style-type: none"> <li>• For 3RA61</li> <li>• For 3RA62</li> </ul>	<b>3RA6920-2B</b> <b>3RA6920-2C</b>

## Selection and ordering data (continued)

Version	Article No.
---------	-------------

**Accessories specially for 3RA6 compact starters (continued)**

3RA6920-3A

**Main circuit terminals mixed connection method**

1 set comprises:

- 1 joint block on the line side with screw terminals
- 1 joint block on the outgoing side with spring-type terminals

**3RA6920-3A**

Version	Article No.
---------	-------------

**Terminals for "Self-Protected Combination Motor Controllers (Type E)" acc. to UL 508 for infeed through parallel wiring with compact starters**

3RV2928-1H

Note:

UL 508 demands 1-inch clearance and 2-inch creepage distance at line side for "Combination Motor Controller Type E". Terminal blocks are not required for use according to CSA. These terminal blocks cannot be used in combination with 3RV19.5 three-phase busbars.

**Terminal blocks type E**

For extended clearance and creepage distances (1 and 2 inch)

**3RV2928-1H**

Number of compact starters and motor starter protectors that can be connected Without lateral accessories	Modular spacing mm	Rated current $I_n$ at 690 V A	For motor starter protectors Size	Article No.
--	-----------------------	---	--------------------------------------	-------------

**Three-phase busbars for infeed with 3RA6**

3RV1915-1AB



3RV1915-1BB



3RV1915-1CB



3RV1915-1DB

For feeding several compact starters and/or motor starter protectors with screw terminals, mounted side-by-side on standard mounting rails, insulated, with touch protection.

2	45	63	S00, S0 <sup>1)</sup>
3	45	63	S00, S0 <sup>1)</sup>
4	45	63	S00, S0 <sup>1)</sup>
5	45	63	S00, S0 <sup>1)</sup>

**3RV1915-1AB**  
**3RV1915-1BB**  
**3RV1915-1CB**  
**3RV1915-1DB**

<sup>1)</sup> Not suitable for 3RV11/3RV21 motor starter protectors for motor protection with overload relay function and for 3RV17/3RV27 and 3RV18/3RV28 circuit breakers according to UL 489 / CSA C22.2 No.5-02.

Joint clamping of 3RV1 motor starter protector sizes S00 and S0 is not possible on account of the different modular spacings and the different height of the terminals. The 3RV1915-5DB connecting piece is available for connecting the compact starters to the 3RV1 motor starter protector size S00. Motor starter protectors S00/S0 of the 3RV2 series can be jointly clamped; no connecting piece has to be used.

Version	Modular spacing mm	For motor starter protectors Size	Article No.
---------	-----------------------	--------------------------------------	-------------

**Covers for connection tags of the three-phase busbars**

3RV1915-6AB

Touch protection for empty positions

--

S00, S0

**3RV1915-6AB**

## AS-Interface

Slaves

Motor starters for use in the control cabinet

### SIRIUS 3RA6 compact starters > Accessories

#### Selection and ordering data (continued)

	Conductor cross-section			Tightening torque	For compact starters and motor starter protectors	Article No.
	Solid or stranded	Finely stranded with end sleeve	AWG cables, solid or stranded			
	mm <sup>2</sup>	mm <sup>2</sup>	AWG	Nm	Size	

#### Three-phase feeder terminals for three-phase busbars



3RV1925-5AB

##### Connection from top

2.5 ... 25	4 ... 16	10-4	4	S0	<b>3RV1925-5AB</b>
------------	----------	------	---	----	--------------------



3RV2915-5B

##### Connection from below<sup>1)</sup>

2.5 ... 25	4 ... 16	10-4	Input: 4; Output: 2 ... 2.5	S00, S0	<b>3RV2915-5B</b>
------------	----------	------	--------------------------------	---------	-------------------

#### Three-phase infeed terminals for constructing "Type E Starters" according to UL 508 for three-phase busbars



3RV2925-5EB

##### Connection from top

2.5 ... 25	4 ... 16	10-4	--	S0	<b>3RV2925-5EB</b>
------------	----------	------	----	----	--------------------

<sup>1)</sup> This terminal is connected in place of a switch, please take the space requirement into account.

Version	Article No.
---------	-------------

#### Busbar adapters for 60 mm system



8US12 11-1NS10

For flat copper profiles according to DIN 46433  
Width: 12 ... 30 mm  
Thickness: 4 ... 5 mm or 10 mm

**8US1211-1NS10**

#### Device holders for lateral mounting along side the busbar adapter for 60 mm systems

Required in addition to the busbar adapter for mounting a reversing starter



8US12 50-1AA10

**8US150-1AA10**

Version	Color of handle	Version of extension shaft	Article No.
		mm	

#### Door-coupling rotary operating mechanisms for operating the compact starter with closed control cabinet doors



3RV2926-0B



The door-coupling rotary operating mechanisms consist of a knob, a coupling driver and a 130 mm long extension shaft (6 mm x 6 mm). The door-coupling rotary operating mechanisms are designed to degree of protection IP65. The door interlocking prevents accidental opening of the control cabinet door in the ON position of the motor starter protector. The OFF position can be locked with up to 3 padlocks.

<b>Door-coupling rotary operating mechanisms</b>	Black	130	<b>3RV2926-0B</b>
--	-------	-----	-------------------

<b>EMERGENCY-STOP door-coupling rotary operating mechanisms</b>	Red/yellow	130	<b>3RV2926-0C</b>
---	------------	-----	-------------------

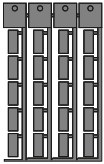

**Selection and ordering data** (continued)

Version	Article No.
<b>Tools for opening spring-type terminals</b>	
 <b>Screwdrivers</b> For all SIRIUS devices with spring-type terminals Length approx. 200 mm, 3.0 mm x 0.5 mm, titanium gray/black, partially insulated 3RA2908-1A	<b>Spring-type terminals</b>  <b>3RA2908-1A</b>
<b>Blank labels</b>	
 <b>Unit labeling plates<sup>1)</sup></b> for SIRIUS devices 20 mm x 7 mm, titanium gray 3RT2900-1SB20	<b>3RT2900-1SB20</b>

<sup>1)</sup> PC labeling system for individual inscription of unit labeling plates available from: murrplastik Systemtechnik GmbH [www.murrplastik.com](http://www.murrplastik.com).

**More information**

The system manual "SIRIUS Compact Starter and Accessories" can be downloaded from the Download Center at <https://support.automation.siemens.com/WW/view/en/27136554/133300>.

## AS-Interface

Slaves

Motor starters for use in the control cabinet

### SIRIUS 3RA6 compact starters > Add-on modules for AS-Interface

#### Overview

Various AS-i add-on modules are available for communication of the 3RA6 compact starter with the control system using AS-Interface:

- Standard version
- With two local inputs
- With two free external inputs
- With one free external input and one free external output
- With two free external outputs
- For local control

The AS-i add-on modules can be combined only in connection with compact starters with a rated control supply voltage of 24 V AC/DC.

#### AS-i add-on module for local controller

With this new module it is also possible for the connected compact starter to be operated directly using simple switches, i.e. without recourse to AS-i communication, if required.

##### "Automatic" mode

NC contacts can be connected to the inputs Y2 and Y4 through the local terminals on the AS-i add-on module. If the "+" connections are connected simultaneously to both local inputs, the AS-i add-on module will be in "Automatic" mode, i.e. it will communicate with the control system through AS-Interface.

##### Local control

Opening the two inputs Y2 and Y4 will result in the direct disconnection of the compact starter. Operation through AS-i communication is finished and the compact starter can now be switched on and off directly using NO contacts (one NO contact per direction of rotation on the reversing starter).

"LED AUX Power" must light up green, the 24 V DC supply must be ensured and the AS-i control supply voltage must no longer be applied.

##### Resetting to "Automatic" mode

Simultaneous application of a "1" signal at the local inputs. The availability bit DI 0 is switched to a "1" signal.

If AS-i communication is reset, the motor is first switched off and then on again when requested by the control system.

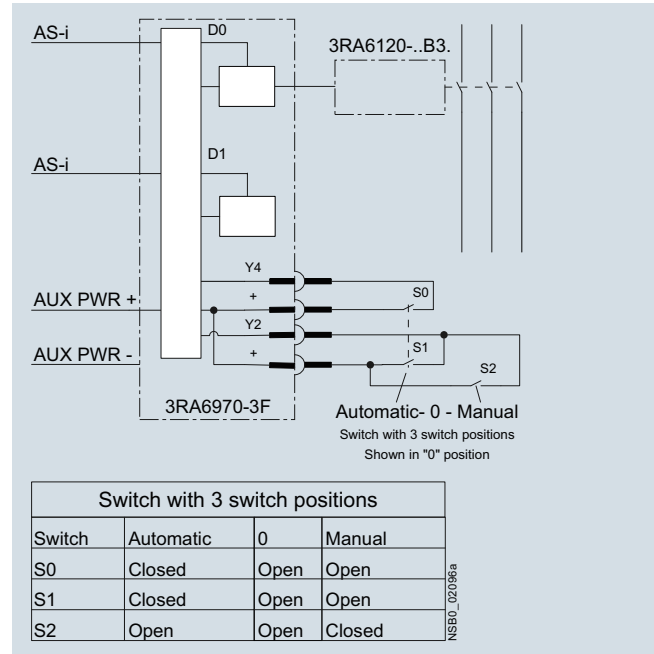



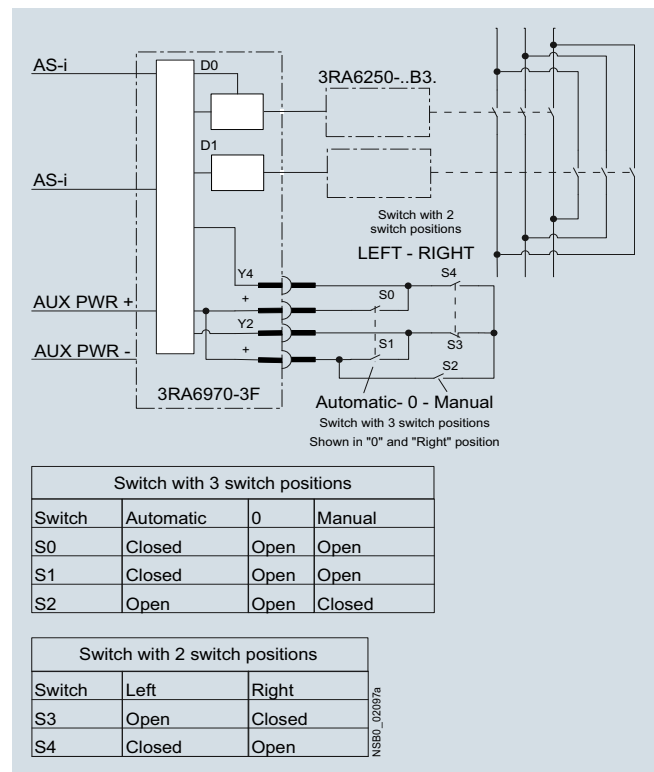

Circuit diagram example for controlling a 3RA61 20 direct-on-line starter using an AS-i add-on module for local control



Circuit diagram example for controlling a 3RA6250 reversing starter using an AS-i add-on module for local control

**Selection and ordering data**

Version	Article No.
<b>AS-i add-on modules</b>	
 3RA6970-3A	<b>Standard version</b> For communication of the compact starter with the control system using AS-Interface <b>3RA6970-3A</b>
 3RA6970-3B to -3F	<b>With two local inputs</b> For safe disconnection through local safety relays, e.g. cable-operated switches <b>3RA6970-3B</b>
	<b>With two free external inputs</b> Replaces the digital standard inputs "Motor On" and "Group warning" <b>3RA6970-3C</b>
	<b>With one free external input and one free external output</b> Replaces the digital standard input "Group warning" <b>3RA6970-3D</b>
	<b>With two free external outputs</b> Only for direct-on-line starters, replaces the digital standard output "Motor left" <b>3RA6970-3E</b>
	<b>For local control</b> Control of the compact starter optionally using AS-Interface or local switches <b>3RA6970-3F</b>
<b>Spare parts for AS-i add-on modules</b>	
	<b>Connectors for data and auxiliary supply cable</b> with 2 insulation displacement terminations for standard litz wires 2 x 0.5 ... 0.75 mm <sup>2</sup> <ul style="list-style-type: none"> <li>• Flat, yellow, extender</li> <li>• Flat, black, extender</li> </ul> <b>3RK1901-0NA00</b> <b>3RK1901-0PA00</b>
<b>Accessories for AS-i add-on modules</b>	
 3RK1904-2AB02	<b>AS-Interface addressing unit V 3.0</b> <ul style="list-style-type: none"> <li>• For AS-Interface modules and sensors and actuators with integrated AS-Interface in accordance with AS-i Specification V3.0</li> <li>• For setting the AS-i address of standard slaves, and slaves with extended addressing mode (A/B slaves)</li> <li>• With input/output test function and many other commissioning functions</li> <li>• Battery operation with 4 batteries type AA (IEC LR6, NEDA 15)</li> <li>• Scope of supply:               <ul style="list-style-type: none"> <li>- Addressing unit with 4 batteries</li> <li>- Addressing cable, with M12 plug to addressing plug (hollow plug), length 1.5m</li> </ul> </li> </ul> <b>3RK1904-2AB02</b>

## AS-Interface

Slaves

Motor starters for use in the control cabinet

### SIRIUS 3RA6 compact starters > Infeed system for 3RA6

#### Overview

The infeed system for 3RA6 compact starters enables far less wiring in the main circuit and, thanks to the easy exchangeability of the compact starters, reduces the usual downtimes for maintenance work during the plant's operating phase.

The infeed system provides the possibility of completely prewiring the main circuit without a compact starter needing to be connected at the same time. As the result of the removable terminals in the main circuit, compact starters can be integrated in an infeed system in an easy manner (without the use of tools).

In addition, the integrated PE bar means it is optionally possible to connect the motor cable directly to the infeed system without additional intermediate terminals. The infeed system for 3RA6 compact starters is designed for summation currents up to 100 A with a maximum 70 mm<sup>2</sup> conductor cross-section on the feeder terminal block.

The infeed system can be mounted on a standard mounting rail or flat surfaces.

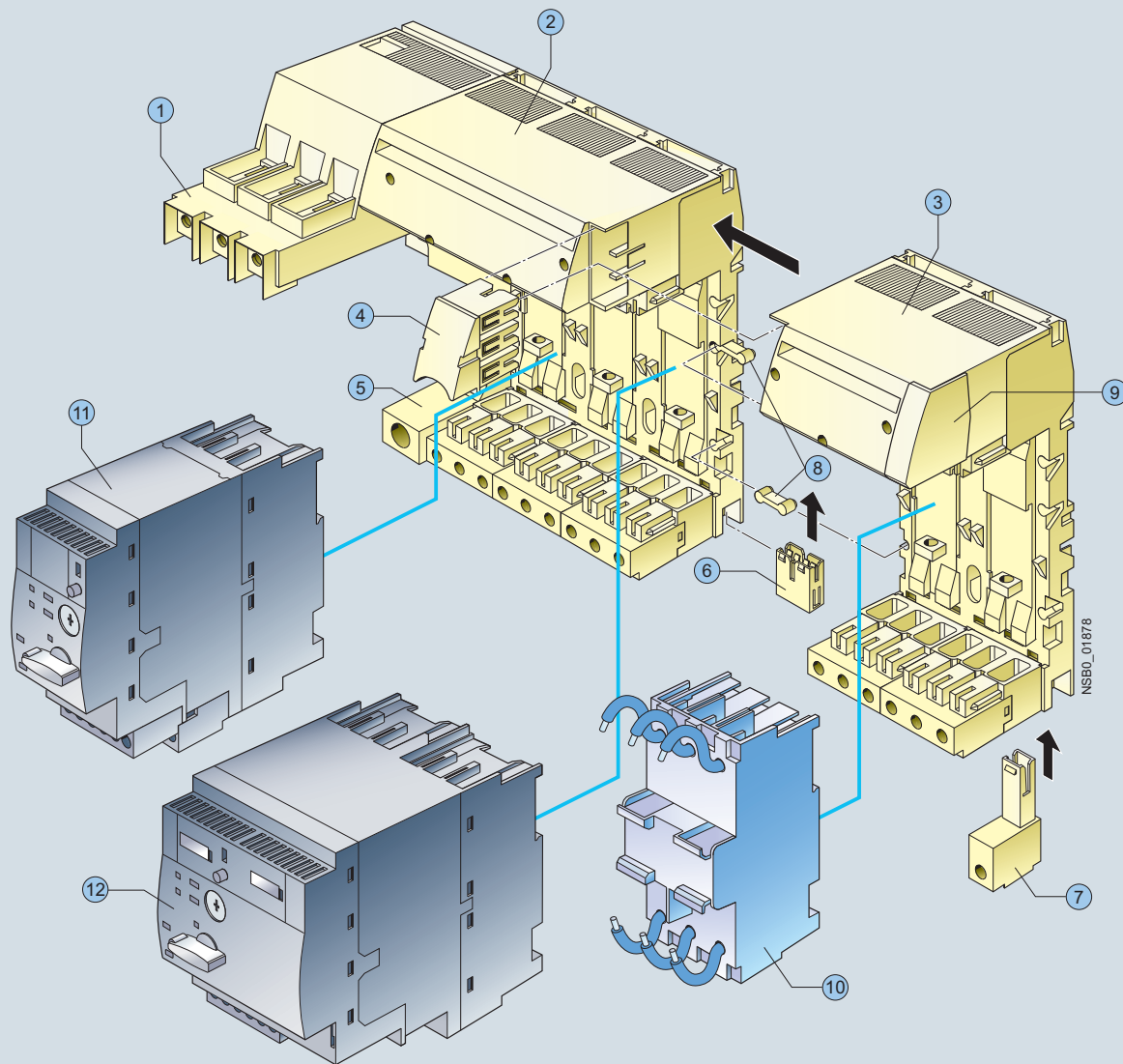

- |                                 |  |
|---------------------------------|--|
| ① Feeder terminal               | ⑦ PE pick-off  |
| ② Three-socket expansion module | ⑧ Connecting wedges  |
| ③ Two-socket expansion module   | ⑨ End cover  |
| ④ Expansion plug                | ⑩ 45 mm adapter for SIRIUS motor starter protector size S0 |
| ⑤ PE infeed                     | ⑪ 3RA61 direct-on-line starter                             |
| ⑥ PE expansion plug             | ⑫ 3RA62 reversing starter                                  |

Infeed system for 3RA6 compact starters

**Overview** (continued)**① Infeed**

The 3-phase infeed is available with screw connection (25/35 mm<sup>2</sup> up to 63 A or 50/70 mm<sup>2</sup> up to 100 A) and spring-type connection (25/35 mm<sup>2</sup> up to 63 A).

The infeed with spring-typed terminal can be fitted on the left as well as on the right to an expansion module.

The infeed with screw terminal is supplied only with a 3-socket expansion module and permanently fitted on the left side.

The infeeds with screw connection enable connection of the main conductors (L1, L2, L3) either from above or from below.

The infeed with screw connection is supplied complete with 1 end cover, the infeed with spring-load connection complete with 2 end covers.

**② Three-socket expansion modules**

The expansion module with 3 sockets for compact starters is available with screw connection and with spring-type connection.

Expansion modules enable the infeed system to be expanded and can be fitted to each other in any number.

Two expansion modules are held together with the help of 2 connecting wedges and 1 expansion plug. These assembly parts are included in the scope of supply of the respective expansion module.

When the infeed system for 3RA6 is used, the compact starters (plug-in modules) are easily assembled and disassembled even when live.

Optional possibilities:

- PE connection on motor outgoing side
- Outfeed for external auxiliary devices
- Connection to 3RV29 infeed system
- Integration of SIRIUS 3RV1 and 3RV2 motor starter protectors size S0 up to 25 A (using 3RA6890-0BA adapter)

**③ Two-socket expansion modules**

If only 2 instead of 3 additional sockets are required, then the 2-socket expansion module is the right choice. It has the same functionality as the 3-socket expansion module.

**④ Expansion plug**

Two expansion modules can be connected together using the expansion plug. Flexible expansion of the infeed system is thus possible.

**⑤ PE infeeds**

This module enables a PE cable to be connected.

The PE infeed can be ordered with screw connection and spring-type connection (35 mm<sup>2</sup>) and can be fitted on the right or left to the expansion block.

**⑥ PE expansion plug**

The PE expansion plug is inserted from below and enables two PE bars to be connected.

**⑦ PE pick-off**

The PE pick-off is available with screw connection and spring-type connection (6/10 mm<sup>2</sup>). It is snapped into the infeed system from below.

**⑧ Connecting wedges**

Two connecting wedges are used to hold together 2 expansion modules.

**⑨ End covers**

On the last expansion module of a row, the socket provided for the expansion plug can be covered by inserting the end cover.

**⑩ 45 mm adapters for SIRIUS 3RV1, 3RV2 motor starter protectors**

SIRIUS 3RV1 and 3RV2 motor starter protectors size S0 with screw connection can be fitted to the adapter, enabling them to be plugged into the infeed system.

**IP20 terminal covers for increasing finger-safety**

Universally configured terminal covers are available for the 3-phase infeeds with screw connection 25/35 mm<sup>2</sup> and 50/70 mm<sup>2</sup>:

- 3RA68 80-2AB terminal covers for infeeds with screw connection 25/35 mm<sup>2</sup> (3RA6812-8AB/AC)
- 3RA68 80-3AB terminal covers for infeeds with screw connection 50/70 mm<sup>2</sup> (3RA6813-8AB/AC)

The terminal covers can be used in two ways on the infeed terminals of the infeeds with screw connection 25/35 mm<sup>2</sup> and 50/70 mm<sup>2</sup> (see illustration):

- If the terminals are connected, the cables are also covered:
  - by approx. 14 mm with the 3RA6880-2AB
  - by approx. 18 mm with the 3RA6880-3AB
- On clamping points without connected cables, the covers can be turned once and then pushed over the clamping points for finger-safe covering of the metal parts.

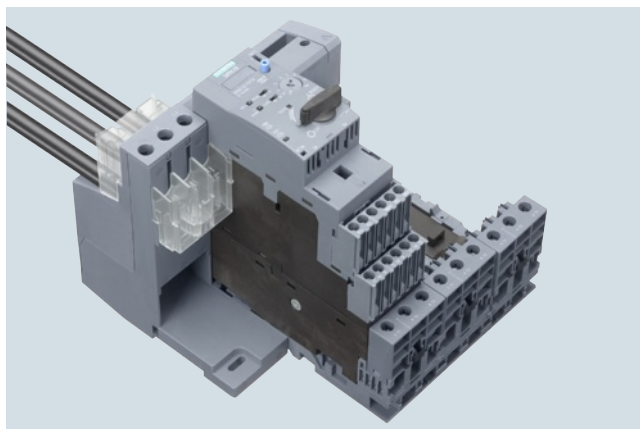

Use of the 3RA6880-2AB terminal cover on the infeed with screw connection 25/35 mm<sup>2</sup> (3RA6812-8AB/AC). The upper cover increases the finger-safety for the connected conductors. The identical lower cover is turned for use and prevents touching of the voltage-carrying metal parts of the feeder terminal. For better recognition, the covers are shown as transparent in this illustration and not in their original color.

**Terminal blocks**

Using the terminal block the 3 phases can be fed out of the system; this means that single-phase, two-phase and three-phase components can also be integrated in the system.

After the end cover is pulled out, the terminal block can be plugged onto an expansion module.

**Expansion plug for SIRIUS 3RV29 infeed systems**

After the end cover is pulled out, the expansion plug for the SIRIUS 3RV29 infeed system can be plugged onto an expansion module. It connects the infeed system for 3RA6 compact starters with the SIRIUS 3RV29 infeed system.

## AS-Interface

Slaves

Motor starters for use in the control cabinet

### SIRIUS 3RA6 compact starters > Infeed system for 3RA6

#### Overview (continued)

##### Maximum rated operational current

The following maximum rated operational currents apply for the components of the infeed system for 3RA6:

Component	Maximum rated operational current A
Infeed with screw connection 50/70 mm <sup>2</sup>	100
Infeed with screw connection 25/35 mm <sup>2</sup>	63
Infeed with spring-type connection 25/35 mm <sup>2</sup>	63
Expansion plug	63

With side-by-side mounting of several expansion modules, the maximum rated operational current from the second expansion module to the end of the row is 63 A.

##### Proposal for upstream short-circuit protection devices

The following short-circuit data apply for the components of the infeed system for 3RA6 compact starters.

Conductor cross-section mm <sup>2</sup>	Inscriptions	Proposal for upstream short-circuit protection device
--	--------------	---

##### Short-circuit protection for infeed block (25/35 mm<sup>2</sup>) with screw connection

2.5 ... 35	$I_{d, \max} = 19 \text{ kA}, I^2t = 440 \text{ kA}^2\text{s}$	<b>3RV1041-4JA10</b>
------------	--	----------------------

##### Short-circuit protection for infeed block (50/70 mm<sup>2</sup>) with screw connection

2.5 ... 70	$I_{d, \max} = \text{approx. } 22 \text{ kA}$	<b>3RV1041-4MA10</b>
------------	---	----------------------

##### Short-circuit protection for infeed block with spring-type connection

4	$I_{d, \max} = 9.5 \text{ kA}, I^2t = 85 \text{ kA}^2\text{s}$	<b>3RV1021-4DA10</b>
---	--	----------------------

6	$I_{d, \max} = 12.5 \text{ kA}, I^2t = 140 \text{ kA}^2\text{s}$	<b>3RV1031-4EA10</b>
---	--	----------------------

10	$I_{d, \max} = 15 \text{ kA}, I^2t = 180 \text{ kA}^2\text{s}$	<b>3RV1031-4HA10</b>
----	--	----------------------

16/25	$I_{d, \max} = 19 \text{ kA}, I^2t = 440 \text{ kA}^2\text{s}$	<b>3RV1041-4JA10</b>
-------	--	----------------------

##### Short-circuit protection for terminal block

1.5	$I_{d, \max} = 7.5 \text{ kA}$	<b>5SY...</b>
-----	--------------------------------	---------------

2.5	$I_{d, \max} = 9.5 \text{ kA}$	<sup>1)</sup>
-----	--------------------------------	---------------

4	$I_{d, \max} = 9.5 \text{ kA}$	
---	--------------------------------	--

6	$I_{d, \max} = 12.5 \text{ kA}$	
---	---------------------------------	--

<sup>1)</sup> To prevent the possibility of short circuits, the cables on the terminal block must be installed so that they are short-circuit proof according to EN 60439-1 Section 7.5.5.1.2.

**Selection and ordering data**

Version	Article No.
<b>Three-phase infeeds and expansion modules</b>	
 <p><b>3RA6812-8AB</b></p>	<p><b>Infeeds with screw connection 25/35 mm<sup>2</sup> left</b></p> <p>Infeeds with screw connection at line side with a permanently fitted 3-socket expansion module with screw or spring-type terminals on the outgoing side and integrated PE bar</p> <p>Expansion module with 3 sockets for 3 direct-on-line starters or 1 direct-on-line starter and 1 reversing starter</p> <ul style="list-style-type: none"> <li>• Screw terminals on the outgoing side</li> <li>• Spring-type terminals on the outgoing side</li> </ul>
 <p><b>3RA6812-8AC</b></p>	
 <p><b>3RA6813-8AB</b></p>	<p><b>Infeeds with screw connection 50/70 mm<sup>2</sup> left</b></p> <p>Infeeds with screw connection at line side with a permanently fitted 3-socket expansion module with screw or spring-type terminals on the outgoing side and integrated PE bar</p> <p>Expansion module with 3 sockets for 3 direct-on-line starters or 1 direct-on-line starter and 1 reversing starter, suitable for UL operation according to UL 508 Type E</p> <ul style="list-style-type: none"> <li>• Screw terminals on the outgoing side</li> <li>• Spring-type terminals on the outgoing side</li> </ul>
 <p><b>3RA6813-8AC</b></p>	
 <p><b>3RA6830-5AC</b></p>	<p><b>Infeeds with spring-type connection 25/35 mm<sup>2</sup> left or right</b></p> <p>Up to 63 A</p>









**Screw terminals****3RA6812-8AB****3RA6812-8AC****Screw terminals****3RA6813-8AB****3RA6813-8AC****Spring-type terminals****3RA6830-5AC**

**AS-Interface**

Slaves

Motor starters for use in the control cabinet

**SIRIUS 3RA6 compact starters > Infeed system for 3RA6****Selection and ordering data** (continued)

	Version	Article No.
<b>Expansion modules</b>		
 <p data-bbox="129 593 252 619">3RA6822-0AB</p>	<p data-bbox="371 380 655 406"><b>Two-socket expansion modules</b></p> <p data-bbox="371 408 743 491">with screw or spring-type connection and integrated PE bar with 2 sockets for 2 direct-on-line starters or 1 reversing starter</p> <p data-bbox="371 493 730 540">Expansion plug and 2 connecting wedges are included in the scope of supply.</p> <ul data-bbox="371 587 523 612" style="list-style-type: none"> <li>• Screw terminals</li> </ul>	<p data-bbox="1169 544 1318 570"><b>Screw terminals</b> </p> <p data-bbox="1169 585 1297 610"><b>3RA6822-0AB</b></p>
 <p data-bbox="129 838 252 863">3RA6822-0AC</p>	<ul data-bbox="371 666 571 691" style="list-style-type: none"> <li>• Spring-type terminals</li> </ul>	<p data-bbox="1169 619 1369 644"><b>Spring-type terminals</b> </p> <p data-bbox="1169 659 1297 685"><b>3RA6822-0AC</b></p>
 <p data-bbox="129 1083 252 1108">3RA6823-0AB</p>	<p data-bbox="371 870 671 895"><b>Three-socket expansion modules</b></p> <p data-bbox="371 898 1126 959">with screw or spring-type connection and integrated PE bar with 3 sockets for 3 direct-on-line starters or 1 direct-on-line starter and 1 reversing starter</p> <p data-bbox="371 961 730 1008">Expansion plug and 2 connecting wedges are included in the scope of supply.</p> <ul data-bbox="371 1055 523 1081" style="list-style-type: none"> <li>• Screw terminals</li> </ul>	<p data-bbox="1169 1012 1318 1038"><b>Screw terminals</b> </p> <p data-bbox="1169 1053 1297 1078"><b>3RA6823-0AB</b></p>
 <p data-bbox="129 1327 252 1353">3RA6823-0AC</p>	<ul data-bbox="371 1129 571 1155" style="list-style-type: none"> <li>• Spring-type terminals</li> </ul>	<p data-bbox="1169 1087 1369 1112"><b>Spring-type terminals</b> </p> <p data-bbox="1169 1127 1297 1153"><b>3RA6823-0AC</b></p>

4



**Selection and ordering data** (continued)









Version	Article No.
<b>Accessories for infeed systems for 3RA6</b>	
<b>PE infeeds 25/35 mm<sup>2</sup></b>	
 <p>3RA6860-6AB</p> <ul style="list-style-type: none"> <li>Screw terminals</li> </ul>	<p><b>Screw terminals</b> </p> <p><b>3RA6860-6AB</b></p>
 <p>3RA6860-5AC</p> <ul style="list-style-type: none"> <li>Spring-type terminals</li> </ul>	<p><b>Spring-type terminals</b> </p> <p><b>3RA6860-5AC</b></p>
<b>PE pick-offs 6/10 mm<sup>2</sup></b>	
 <p>3RA6870-4AB</p> <ul style="list-style-type: none"> <li>Screw terminals</li> </ul>	<p><b>Screw terminals</b> </p> <p><b>3RA6870-4AB</b></p>
 <p>3RA6870-3AC</p> <ul style="list-style-type: none"> <li>Spring-type terminals</li> </ul>	<p><b>Spring-type terminals</b> </p> <p><b>3RA6870-3AC</b></p>
<b>Expansion plugs</b>	
 <p>3RA6890-0EA</p> <p>PE expansion plug</p>	<p><b>3RA6890-0EA</b></p>
 <p>3RA6890-1AB</p> <p>Expansion plug between 2 expansion modules Is included in the scope of supply of the expansion modules.</p>	<p><b>3RA6890-1AB</b></p>
 <p>3RA6890-1AA</p> <p>Expansion plug for SIRIUS 3RV29 infeed system Connects infeed system for 3RA6 to 3RV29 infeed system</p>	<p><b>3RA6890-1AA</b></p>

**AS-Interface**

Slaves

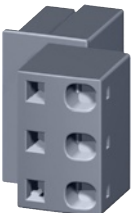
Motor starters for use in the control cabinet

**SIRIUS 3RA6 compact starters > Infeed system for 3RA6****Selection and ordering data** (continued)

Version	Article No.
<i>Accessories for infeed systems for 3RA6 (Continued)</i>	
 <p><b>45 mm adapters</b> For SIRIUS size S0 3RV1 and 3RV2 motor starter protectors up to 25 A</p> <ul style="list-style-type: none"> <li>Screw terminals (conductor cross-section AWG 10)</li> </ul> <p>3RA6890-0BA</p>	<p><b>Screw terminals</b> </p> <p><b>3RA6890-0BA</b></p>
<p><b>Terminal covers for infeeds with screw connection</b> IP 20 terminal covers for infeeds with screw connection 25/35 mm<sup>2</sup> (3RA68 12-8AB/AC) (2 units per pack)</p>  <p>3RA6880-2AB</p>	<p><b>3RA6880-2AB</b></p>
<p>IP 20 terminal covers for infeeds with screw connection 50/70 mm<sup>2</sup> (3RA68 13-8AB/AC) (2 units per pack)</p>  <p>3RA6880-3AB</p>	<p><b>3RA6880-3AB</b></p>
<p><b>Terminal blocks</b> For integration of single-phase, 2-phase and 3-phase external components</p> <ul style="list-style-type: none"> <li>Spring-type terminals</li> </ul>  <p>3RV2917-5D</p>	<p><b>Spring-type terminals</b> </p> <p><b>3RV2917-5D</b></p>
<i>Tools for opening spring-type terminals</i>	
<p><b>Screwdrivers</b> For all SIRIUS devices with spring-type terminals</p> <p>Length approx. 200 mm, 3,0 mm x 0,5 mm, titanium gray/black, partially insulated</p>  <p>3RA2908-1A</p>	<p><b>Spring-type terminals</b> </p> <p><b>3RA2908-1A</b></p>

4

**Overview**

SIRIUS M200D AS-i Basic motor starters with manual local operation

The intelligent, highly flexible SIRIUS M200D motor starters for distributed configurations are designed to start, monitor and protect motors and loads up to 5.5 kW.

The M200D motor starters are available in four versions:

M200D AS-i Basic	M200D AS-i Standard	M200D PROFIBUS	M200D PROFINET
Motor control with			
AS-i communication		PROFIBUS	PROFINET
Mechanical or electronic switching			
✓	✓	✓	✓
Electronic switching with soft starter functionality			
--	✓	✓	✓

✓ Function available

-- Function not available

**Basic functionality**

All M200D motor starter versions have the following functions:

- Available as direct-on-line and reversing starters in a rugged design
- Electromechanical or electronic switching version
- Little variance – only 2 device versions up to 5.5 kW thanks to wide range setting
- All versions have the same enclosure dimensions
- Degree of protection IP65
- Quick and fail-safe wiring of system and motor cables using ISO 23570 plug-in connector technology (Q4/2 and Q8/0)
- Robust and widely used M12 connection method for digital inputs and outputs
- Integrated feeder connector monitoring
- Full motor protection through overload protection and a temperature sensor (PTC, TC)
- Short-circuit and overload protection integrated
- Integrated repair switch lockable with 3 locks (multi-level service)
- Uniform wiring to the G110D/G120D frequency inverters and to the ET200pro distributed peripherals system
- Extensive diagnostics concept using LEDs
- Optional integrated manual local control with key-operated switch (ordering option)
- Optionally available brake actuation with voltages from 180 V DC (no rectifier needed in motor) or 230/400 V AC (order versions)

**Benefits**

M200D motor starters provide the following advantages for customers:

- High plant availability through plug-in capability of the main circuit, communication and IOs – relevant for installing and replacing devices
- Cabinet-free construction and near-motor installation thanks to the high degree of protection IP65
- The motor starters record the actual current flow for the parameterizable electronic motor overload protection. Reliable messages concerning the overshooting or undershooting of setpoint values for comprehensive motor protection. All motor protection functions can be defined by simple parameterization
- Low stock levels and low order costs through a wide setting range for the current or a wide setting range for the electronic motor protection of 1:10 (only 2 device versions up to 5.5 kW)
- The integrated wide range for the current enables a single device to cover numerous standard motors of different sizes
- Comprehensive offering of accessories, including ready-assembled cables
- The M200D motor starters can be installed with a few manual steps. The integrated plug-in technology enables far lower wiring outlay: preassembled cables can be plugged directly onto the motor starter module
- Easy and user-friendly installation because all versions have the same enclosure dimensions
- Fast and user-friendly commissioning using optional manual local control
- Increase of process speed through integrated functions such as "Quick Stop" and "Disable Quick Stop", e.g. at points and crossings
- Optional manual local control with momentary-contact and latching operation for easier start-up and easier servicing

**Application**

The high degree of protection IP65 makes the M200D motor starters suitable in particular for use on extensive conveying systems such as are found in mail sorting centers, airports, automotive factories and the packing industry.

For simple operating mechanism tasks, particularly in conveyor applications, the new SINAMICS G110D frequency inverter series with a performance range from 0.75 kW to 7.5 kW and degree of protection IP65 is the ideal partner for the M200D motor starters.

The SINAMICS G110D frequency inverters permit stepless speed control of three-phase asynchronous motors and meet the requirements of conveyor applications with frequency control (for more information see catalog D 31).

## AS-Interface

Slaves

Motor starters for use in the field, high degree of protection

SIRIUS M200D motor starters > M200D motor starters for AS-Interface

### Overview

For motor control using AS-Interface there are the following M200D motor starter versions: SIRIUS M200D AS-i Basic and SIRIUS M200D AS-i Standard (basic functionality see page 4/101 "SIRIUS M200D Motor Starters" ⇒ "General Data" ⇒ "Overview").

#### **SIRIUS M200D AS-i Basic**

##### Functionality

- Easy and fast on-site start-up through parameterization of local setting knobs (DIP switches) and rotary coding switches for adjusting the rated operational current. The rotary coding switch has an OFF position for deactivating the overload protection with the help of the thermal motor model when using a temperature sensor.

##### Communications

- AS-i communication with A/B addressing according to Spec V2.1
- The AS-i bus is connected cost-effectively using an M12 connection on the device. Of the 4 digital inputs, 2 are contained in the process image and can therefore be used in the PLC program. The other 2 inputs are locally effective and permanently assigned with functions.
- The LEDs can provide comprehensive diagnostics of the device on the spot. In addition to diagnostics using the PAE process image, the device can create up to 15 different diagnostic signals per slave. The message with the highest priority can be read out through the AS-i communication. This is yet another new development which distinguishes the M200D AS-i Basic motor starter from the rest of the market and adds innovative technology, maximum availability and transparency to the system.

#### **SIRIUS M200D AS-i Standard**

The intelligent, highly flexible M200D AS-i Standard motor starters in A/B technology are designed to start and protect motors and loads up to 5.5 kW. They are available in direct-on-line or reversing starter versions, in a mechanical version and also an electronic version (the latter with soft start function).

The M200D AS-i Standard motor starter is the most functional member of the SIRIUS motor starter family in the high degree of protection IP65 for AS-i communication. Consistency with other products of the SIRIUS M200D motor starter range and with the frequency converter and ET200pro peripherals system is assured.

##### Functionality

- AS-i communication with A/B addressing according to Spec 3.0
- Electronic version also with soft start function
- AS-i slave profile 7AE/7A5 with process image 6I/4O
- Full TIA integration: All digital inputs and outputs exist in the cyclic process image and are visible through AS-i, providing maximum flexibility and best adaptability to the application.
- Additionally expanded diagnostics using data record through AS-i bus
- Complete plant monitoring using statistics data record and current value monitoring by means of data records
- Parameterization through AS-i bus with the help of data records or an expanded process image from the user program
- Control of the motor starter using a command data record from the user program
- Flexible assignment of the digital inputs and outputs with all available assignable input actions
- Parameterization using Motor Starter ES at the local interface (ordering option for start-up software)
- Diagnostics with the help of Motor Starter ES (ordering option for start-up software)

##### Mounting and installation

The M200D motor starters can be installed with a few manual steps. The integrated plug-in technology enables far lower wiring outlay. Connecting cables can be plugged directly onto the motor starter module. Swapping of the connecting wires and malfunctions within the plant are prevented by preassembled cables. The AS-i bus is connected cost-effectively using an M12 connection on the device. All versions have identical enclosure dimensions for easier system design and conversion.

##### Parameterization and configuration

The particularly robust M200D AS-i Standard motor starter is characterized by numerous functions which can be flexibly parameterized. It enables highly flexible parameterization through the AS-i bus using data records from the user program as well as user-friendly local parameterization using the Motor Starter ES start-up software through the local point-to-point interface.

Functions can be flexibly assigned to the digital inputs and outputs, adapting them to all possible conveyor applications. All motor protection functions, limit values and reactions can be defined by parameterization. The AS-i Standard is unique. In its 6I/4O process image the motor starter sends all 4 digital inputs and the digital output via the process image to the PLC in cyclic mode. System configuration and system documentation are facilitated not least by a number of CAX data.

##### Operation

The new motor starter generation is characterized by high functionality, maximum flexibility and the highest level of automation.

All digital inputs and outputs exist in the cyclic process image. All limit values for monitoring functions and their reactions are parameterizable and therefore adaptable to the application. The motor starters record the actual current flow. Evaluating the current of the parameterizable solid-state overload protection increases the availability of the drives, as do reliable messages concerning the overshooting or undershooting of setpoint values.

##### Diagnostics and maintenance

The M200D sets new standards for diagnostics. In addition to diagnostics using the PAE process image and diagnostics by "parameter echo" (up to 15 different diagnostic signals per slave can be read out via AS-i communication), the possibility of reading out diagnostic data records is unique on the market.

The AS-i Standard is recommended in particular for expansive and highly automated system components because the possibility of monitoring devices and systems with data records (statistical data, measured values and device diagnostics) provides an in-depth view of the plant from the control room, guaranteeing the monitoring process and increasing plant availability.

The integrated maintenance timer can be used to implement preventative maintenance and avoid plant downtimes through look-ahead servicing.

Local control of a drive is possible using the ordering option with integrated manual operation. This is yet another new development which distinguishes the M200D AS-i Standard motor starter from the rest of the market and adds innovative technology, maximum availability and transparency to the plant.

**Overview** (continued)

**SIRIUS M200D**  
**AS-i Basic**



**SIRIUS M200D**  
**AS-i Standard**

**Device functions (firmware features)****Slave on the bus**

Fieldbus	✓ AS-i	
Slave type	✓ A/B acc. to Spec 2.1	✓ A/B acc. to Spec 3.0
Profile	✓ 7.A.E	✓ 7.A.E & 7.A.5
Number of assigned AS-i addresses on the bus	✓ 1	✓ 2
Number of stations per AS-i master	✓ Max. 62 devices	✓ Max. 31 devices
AS-i master profile	✓ M3 and higher	✓ M4 and higher

**Parameterization**

DIP switches	✓	--
Potentiometer for rated operational current	✓	--
Motor Starter ES	--	✓
Data records through AS-i	--	✓

**Diagnostics**

Diagnostics through parameter channel	✓	
Acyclic through data records	--	✓
Expanded process image PAE 4 bytes	--	✓

**Process image**

Process image	✓ 4I/30	✓ 6I/40
---------------	---------	---------

**Data channels**

Local optical interface (manual local)	✓	
AS-i bus	✓	
Motor Starter ES via local interface	--	✓
Motor Starter ES via bus	--	

**Data records<sup>1)</sup> (acyclic)**

Parameterization	--	✓
Diagnostics	--	✓
Measured values	--	✓
Statistics	--	✓
Commands	--	✓

**Inputs**

Number	✓ 4	
• Of which in the process image	✓ 2 through AS-i	✓ 4 through AS-i
Input action	✓ Permanently assigned functions, see manual	✓ Parameterizable: flexible
Quick stop	✓ Permanent function: latching, edge-triggered	✓ Parameterizable function: latching (edge-triggered), non-latching (level-triggered)

**Outputs**

Number	✓ 1	
Output action	✓ Permanent function: assigned with group fault	✓ Parameterizable: For function, see manual

**Brake output**

180 V DC / 230/400 V AC / none	✓	
--------------------------------	---	--

**Motor protection**

Overload protection	✓ Electronic, wide range 1:10	
Short-circuit protection	✓	
Full motor protection	✓	
Temperature sensor	✓ Parameterizable using DIP switches: PTC or Thermoclick or deactivated	✓ Parameterizable using Motor Starter ES, data record: PTC or Thermoclick or deactivated

✓ Function available

-- Function not available

1) The data records are a reduced selection compared with PROFIBUS/PROFINET.

## AS-Interface

Slaves

Motor starters for use in the field, high degree of protection

SIRIUS M200D motor starters > M200D motor starters for AS-Interface

### Overview (continued)



**SIRIUS M200D**  
**AS-i Basic**



**SIRIUS M200D**  
**AS-i Standard**

#### Device functions (firmware features)

##### Device function

Repair switch	✓	
Lower current limit monitoring	--	✓ Parameterizable
Upper current limit monitoring	--	✓ Parameterizable
Zero current detection	✓ Permanent function: disconnection, less than 18.75% of the rated operational current $I_e$	✓ Parameterizable
Blocking current	✓ Permanent function: starting up of the motor: tripping limit up to 800% of the rated operational current $I_e$ for 10 s Active operation: Threshold for tripping "blocking current" up to 400% of the rated operational current $I_e$	✓ Parameterizable
Unbalance	✓ Permanent function: up to 30 % of the rated operational current $I_e$ (only mechanical MS)	✓ Parameterizable
Load type	✓ Permanent function: 3-phase	✓ Parameterizable: 1 and 3-phase
Tripping class	✓ Parameterizable using DIP switches: CLASS 10/deactivated	Parameterizable using Motor Starter ES, data record: CLASS 5, 10, 15, 20
Protection against voltage failure	✓	✓ Parameterizable: activated/deactivated
<b>Soft starter control function</b>		
Soft start function	--	✓ Only solid-state version
Bypass function	--	✓ Only solid-state version
✓ Function available -- Function not available		

### Application

The M200D AS-i standard is particularly suitable for highly automated applications in conveyor systems, which require that devices and systems be monitored to prevent or limit plant downtime. The option of planning the functions of the motor starter or its interfaces also makes fine-adjustment to the function of the motor starter in the application possible and hence provides for extreme flexibility.

**Selection and ordering data**



M200D AS-i Basic without manual local control



M200D AS-i Basic with manual local control

Version	Article No.
<b>Electromechanical starters (with integrated contactor)</b>	3RK1315-6 ■ S41- ■ AA ■
<b>Setting range for rated operational current / A</b>	
• 0.15 ... 2	K
• 1.5 ... 12	L
<b>Direct-on-line starters/ reversing starters</b>	
• Direct-on-line starters	0
• Reversing starters	1
• Direct-on-line starters with manual local operation	2
• Reversing starters with manual local operation	3
<b>Brake actuation</b>	
• Without brake actuation	0
• Brake actuation (230/400 V AC)	3
• Brake actuation (180 V DC)	5

Version	Article No.
<b>Electronic starters (with thyristors)</b>	3RK1315-6 ■ S71- ■ AA ■
<b>Setting range for rated operational current / A</b>	
• 0.15 ... 2	K
• 1.5 ... 9	N
<b>Direct-on-line starters/ reversing starters</b>	
• Direct-on-line starters	0
• Reversing starters	1
• Direct-on-line starters with manual local operation	2
• Reversing starters with manual local operation	3
<b>Brake actuation</b>	
• Without brake actuation	0
• Brake actuation (230/400 V AC)	3
• Brake actuation (180 V DC)	5



## AS-Interface

Slaves

Motor starters for use in the field, high degree of protection

SIRIUS M200D motor starters > M200D motor starters for AS-Interface – Standard

### Selection and ordering data



M200D AS-i Standard without manual local control



M200D AS-i Standard with manual local control

Version	Article No.
<b>Electromechanical starters (with integrated contactor)</b>	3RK1325-6 ■ S41- ■ AA ■
<b>Setting range for rated operational current / A</b>	
• 0.15 ... 2	K
• 1.5 ... 12	L
<b>Direct-on-line starters/ reversing starters</b>	
• Direct-on-line starters	0
• Reversing starters	1
• Direct-on-line starters with manual local operation	2
• Reversing starters with manual local operation	3
<b>Brake actuation</b>	
• Without brake actuation	0
• Brake actuation (230/400 V AC)	3
• Brake actuation (180 V DC)	5

Version	Article No.
<b>Electronic starters (with thyristors)</b>	3RK1325-6 ■ S71- ■ AA ■
<b>Setting range for rated operational current / A</b>	
• 0.15 ... 2	K
• 1.5 ... 12	L
<b>Direct-on-line starters/ reversing starters</b>	
• Direct-on-line starters	0
• Reversing starters	1
• Direct-on-line starters with manual local operation	2
• Reversing starters with manual local operation	3
<b>Brake actuation</b>	
• Without brake actuation	0
• Brake actuation (230/400 V AC)	3
• Brake actuation (180 V DC)	5

4

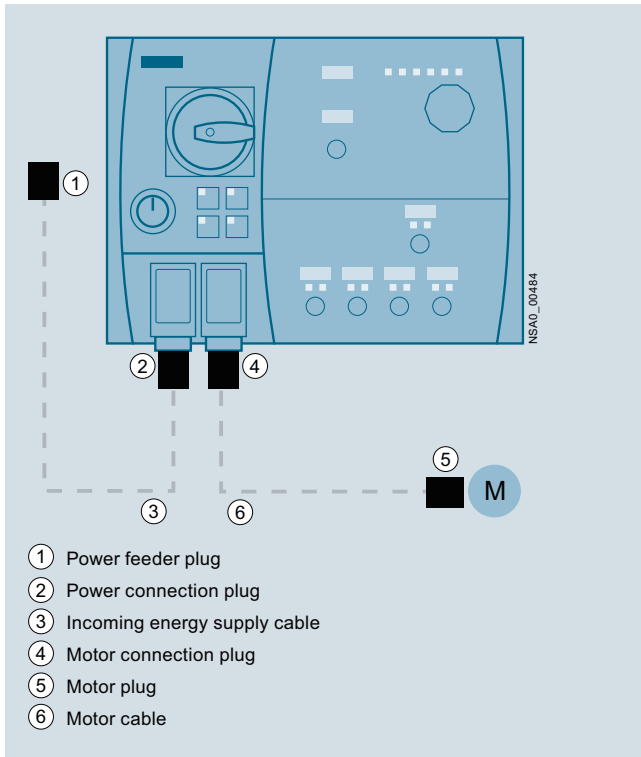

**Overview**

Power and motor connection on the M200D motor starter  
 (in this example: M200D for AS-i)

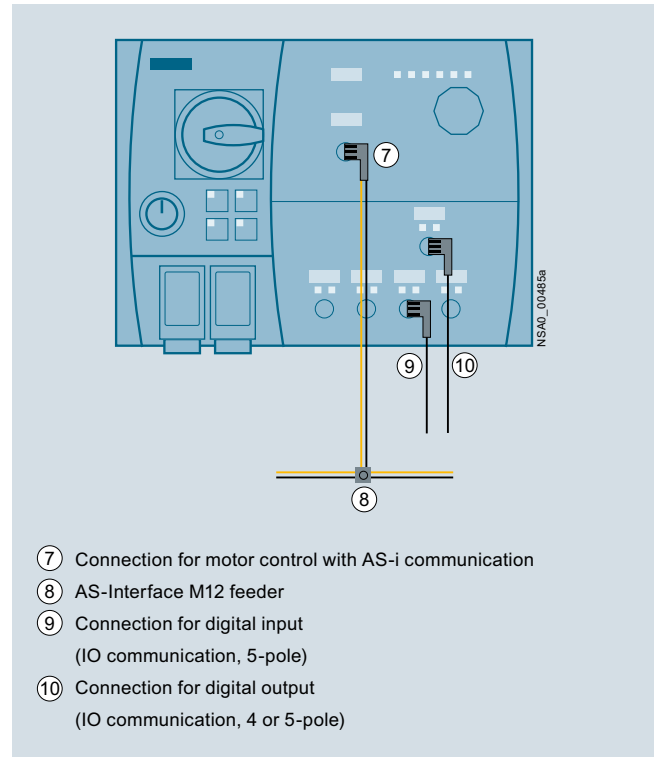

Communication connection using AS-Interface and  
 digital inputs and outputs

## AS-Interface

Slaves

Motor starters for use in the field, high degree of protection

### SIRIUS M200D motor starters > Accessories

#### Selection and ordering data

The accessories listed below represent a basic selection sorted by:

- Accessories for all M200D motor starters
- Accessories for M200D motor starters for AS-interface

#### Note:

More connection technology products, see "Siemens Solution Partners Automation" under "Distributed Field Installation System" technology.

Version	Article No.
<b>Mountable accessories</b>	
<b>M200D protective brackets</b>	<b>3RK1911-3BA00</b>
<b>Incoming power supply</b>	
<b>① Power feeder plugs</b> Connector set for power supply, e.g. for connecting to T terminal connectors, comprising a coupling enclosure, straight outgoing feeder (with bracket), pin insert for HAN Q4/2, incl. gland <ul style="list-style-type: none"> <li>• 5 male contacts 2.5 mm<sup>2</sup></li> <li>• 5 male contacts 4 mm<sup>2</sup></li> <li>• 5 male contacts 6 mm<sup>2</sup></li> </ul>	<b>3RK1911-2BS60</b> <b>3RK1911-2BS20</b> <b>3RK1911-2BS40</b>
<b>② Power connection plugs</b> Connector set for power supply for connection to M200D motor starters, comprising a cable-end connector hood, angular outgoing feeder, female insert for HAN Q4/2, incl. gland <ul style="list-style-type: none"> <li>• 5 female contacts 2.5 mm<sup>2</sup> 2 female contacts 0.5 mm<sup>2</sup></li> <li>• 5 female contacts 4 mm<sup>2</sup> 2 female contacts 0.5 mm<sup>2</sup></li> <li>• 5 female contacts 6 mm<sup>2</sup> 2 female contacts 0.5 mm<sup>2</sup></li> </ul>	<b>3RK1911-2BE50</b> <b>3RK1911-2BE10</b> <b>3RK1911-2BE30</b>
<b>② + ⑦ ③ Power connection cable</b> Assembled at one end with "N" and jumper pin 11 and 12 for plug monitoring, with HAN Q4/2, angular; open at one end; 5 x 4 mm <sup>2</sup> <ul style="list-style-type: none"> <li>• Length 1.5 m</li> <li>• Length 5.0 m</li> </ul>	<b>3RK1911-0DC13</b> <b>3RK1911-0DC33</b>
<b>Motor cable</b>	
<b>④ Motor connection plugs</b> Connector set for motor cable for connection to M200D motor starters, comprising a cable-end connector hood, angular outgoing feeder, pin insert for HAN Q8/0, incl. gland <ul style="list-style-type: none"> <li>• 8 male contacts 1.5 mm<sup>2</sup></li> <li>• 6 male contacts 2.5 mm<sup>2</sup></li> </ul>	<b>3RK1902-0CE00</b> <b>3RK1902-0CC00</b>
<b>⑤ Motor plugs</b> Connector set for motor cable for connection to motors, comprising a cable-end connector hood, straight outgoing feeder, female insert for HAN 10e, incl. star jumper, incl. gland <ul style="list-style-type: none"> <li>• 7 female contacts 1.5 mm<sup>2</sup></li> <li>• 7 female contacts 2.5 mm<sup>2</sup></li> </ul>	<b>3RK1911-2BM21</b> <b>3RK1911-2BM22</b>
<b>④ + ⑦ ⑥ Motor cables, assembled at one end</b> For connection to M200D motor starter, HAN Q8/0, angular, length 5 m <ul style="list-style-type: none"> <li>• Motor cables for motor without brake, 4 x 1.5 mm<sup>2</sup></li> <li>• Motor cables for motor without brake with thermistor, 6 x 1.5 mm<sup>2</sup></li> <li>• Motor cable for motor with brake actuation, braking voltage 400 V AC or 180 V DC, 6 x 1.5 mm<sup>2</sup></li> <li>• Motor cable for motor with brake actuation, braking voltage 400 V AC or 180 V DC and thermistor, 8 x 1.5 mm<sup>2</sup></li> <li>• Motor cable for motor with brake actuation, braking voltage 230 V AC, 6 x 1.5 mm<sup>2</sup></li> <li>• Motor cable for motor with brake actuation, braking voltage 230 V AC and thermistor, 8 x 1.5 mm<sup>2</sup></li> </ul>	<b>3RK1911-0EB31</b> <b>3RK1911-0EF31</b> <b>3RK1911-0ED31</b> <b>3RK1911-0EG31</b> <b>3RK1911-0EH31</b> <b>3RK1911-0EE31</b>

## Selection and ordering data (continued)

Version	Article No.
<b>Motor control with IO communication</b>	
 <p><b>M12 plugs, straight</b> Screw fixing, 5-pole screw terminals, max. 0.75 mm<sup>2</sup>, A-coded, max. 4 A</p> <p>3RK1902-4BA00-5AA0</p>	3RK1902-4BA00-5AA0
 <p><b>M12 plugs, angular</b> Screw fixing, 5-pole screw terminals, max. 0.75 mm<sup>2</sup>, A-coded, max. 4 A</p> <p>3RK1902-4DA00-5AA0</p>	3RK1902-4DA00-5AA0
 <p><b>Control cables, assembled at one end</b> M12 plugs, angular, screw fixing, 5-pole, 5 x 0.34 mm<sup>2</sup>, A-coded, black PUR sheath, max. 4 A</p> <ul style="list-style-type: none"> <li>• Cable length 1.5 m</li> <li>• Cable length 5 m</li> <li>• Cable length 10 m</li> </ul> <p>3RK1902-4H...-5AA0</p>	3RK1902-4HB15-5AA0 3RK1902-4HB50-5AA0 3RK1902-4HC01-5AA0
 <p><b>Control cable, assembled at both ends</b> Straight M12 plug, straight M12 socket, screw fixing, 3-pole, 3 x 0.34 mm<sup>2</sup>, A-coded, black PUR sheath, max. 4 A</p> <ul style="list-style-type: none"> <li>• Cable length 1.5 m</li> </ul> <p>3RK1902-4PB15-3AA0</p>	3RK1902-4PB15-3AA0
<b>Further accessories</b>	
 <p><b>Handheld devices</b> For M200D motor starters (including ET 200pro, ET 200S High-Feature and ECOFAST), for local operation. 3RK1922-2BP00 serial interface cable must be ordered separately.</p> <p>3RK1922-3BA00</p>	3RK1922-3BA00
	<p><b>RS 232 interface cable</b> for serial data link</p> <p>3RK1922-2BP00</p>
	<p><b>USB interface cables, length 2.5 m</b></p> <p>6SL3555-0PA00-2AA0</p>
 <p><b>M12 sealing caps</b> For sealing unused input or output sockets – not for M12 AS-i connection (one set contains 10 sealing caps)</p> <p>3RK1902-0CW00</p>	3RK1901-1KA00
	<p><b>Crimping tools for pins/sockets 4 mm<sup>2</sup> and 6 mm<sup>2</sup></b></p> <p>3RK1902-0CW00</p>
	<p><b>Dismantling tool for HAN Q4/2</b></p> <p>3RK1902-0AB00</p>
	<p><b>Dismantling tool for male and female contacts (HAN Q8/0)</b></p> <p>3RK1902-0AJ00</p>

## AS-Interface

Slaves

Motor starters for use in the field, high degree of protection

SIRIUS M200D motor starters > Accessories

### Selection and ordering data (continued)

Version	Article No.																				
<b>Only for M200D motor starters for AS-interface</b>																					
<b>Motor control with AS-i communication</b>																					
 <p>3RK1902-4GB50-4AA0</p> <p>⑦ <b>Control cables, assembled at one end</b> M12 socket, angular, screw fixing, 4-pole, 4 x 0.34 mm<sup>2</sup>, A-coded, black PUR sheath, max. 4 A</p> <ul style="list-style-type: none"> <li>Cable length 5 m</li> </ul>	<b>3RK1902-4GB50-4AA0</b>																				
 <p>3RK1902-4CA00-4AA0</p> <p>⑦ <b>M12 socket, angular,</b> screw fixing, 4-pole screw terminal, max. 0.75 mm<sup>2</sup>, A-coded, max. 4 A</p>	<b>3RK1902-4CA00-4AA0</b>																				
 <p>3RK1901-1NR21</p> <p>⑧ <b>AS-Interface M12 feeder</b></p> <table border="1"> <thead> <tr> <th>For flat cable</th> <th>For</th> <th>Cable length</th> <th>Cable end in feeder</th> <th></th> </tr> </thead> <tbody> <tr> <td>AS-i/U<sub>aux</sub></td> <td>M12 socket</td> <td>--</td> <td>Not available</td> <td><b>3RK1901-1NR20</b></td> </tr> <tr> <td>AS-i/U<sub>aux</sub></td> <td>M12 cable box</td> <td>1 m</td> <td>Not available</td> <td><b>3RK1901-1NR21</b></td> </tr> <tr> <td>AS-i/U<sub>aux</sub></td> <td>M12 cable box</td> <td>2 m</td> <td>Not available</td> <td><b>3RK1901-1NR22</b></td> </tr> </tbody> </table>	For flat cable	For	Cable length	Cable end in feeder		AS-i/U <sub>aux</sub>	M12 socket	--	Not available	<b>3RK1901-1NR20</b>	AS-i/U <sub>aux</sub>	M12 cable box	1 m	Not available	<b>3RK1901-1NR21</b>	AS-i/U <sub>aux</sub>	M12 cable box	2 m	Not available	<b>3RK1901-1NR22</b>	
For flat cable	For	Cable length	Cable end in feeder																		
AS-i/U <sub>aux</sub>	M12 socket	--	Not available	<b>3RK1901-1NR20</b>																	
AS-i/U <sub>aux</sub>	M12 cable box	1 m	Not available	<b>3RK1901-1NR21</b>																	
AS-i/U <sub>aux</sub>	M12 cable box	2 m	Not available	<b>3RK1901-1NR22</b>																	
 <p>3RK1901-1MN00</p> <p><b>Cable terminating pieces</b> For sealing of open cable ends (shaped AS-Interface cable) in IP67</p>	<b>3RK1901-1MN00</b>																				
<b>Further accessories</b>																					
 <p>3RK1904-2AB02</p> <p><b>AS-Interface addressing unit V 3.0</b></p> <ul style="list-style-type: none"> <li>For AS-Interface modules and sensors and actuators with integrated AS-Interface in accordance with AS-i Specification V3.0</li> <li>For setting the AS-i address of standard slaves, and slaves with extended addressing mode (A/B slaves)</li> <li>With input/output test function and many other commissioning functions</li> <li>Battery operation with 4 batteries type AA (IEC LR6, NEDA 15)</li> <li>Scope of supply: <ul style="list-style-type: none"> <li>- Addressing unit with 4 batteries</li> <li>- Addressing cable, with M12 plug to addressing plug (hollow plug), length 1.5 m</li> </ul> </li> </ul>	<b>3RK1904-2AB02</b>																				
 <p>3RK1902-4PB15-3AA0</p> <p><b>M12 addressing cables to M12</b></p> <ul style="list-style-type: none"> <li>Standard M12 cable for addressing slaves with M12 connection, e.g. K60R modules</li> <li>When using the current version of the 3RK1904-2AB01 addressing unit</li> <li>1.5 m</li> </ul>	<b>3RK1902-4PB15-3AA0</b>																				

**Overview****Portfolio of the SIRIUS 3RK43 MCU motor starter family**

The SIRIUS MCU motor starter family (MCU = Motor Control Unit) rounds off the bottom end of the SIRIUS motor starter range.

This series of motor starters in a high degree of protection is a system solution for the cabinet-free controlling of AC loads in the field.

The MCU product range extends from I/O-controlled motor starters – addressing a central sub-distribution board via I/O stations – in a plastic enclosure for simple applications to motor starters with AS-i communication in a rugged metal enclosure for demanding tasks.

(For complete range, see Catalog IC 10 ⇒ Motor Starters for Use in the Field, High Degree of Protection)

The MCU motor starters are completely pre-wired inside, have a high degree of protection and are designed for switching and protecting any AC loads. They are mostly used on standard three-phase motors in direct or reversing duty up to 5.5 kW at 400/500 V AC (electromechanical switching) and 400/460 V AC (electronic switching).

The motor and short-circuit protection integrated in the MCUs consists either of an electromechanical controlgear assembly or solid-state overload protection and a motor starter protector unit for short-circuit protection.

MCUs with metal enclosure are designed for the switching of three-phase motors. Integrated control of the electrically operated motor brake with a braking voltage of 230 V AC or 400 V AC is a standard feature. The braking voltage is routed to the motor over the motor cable.

SIRIUS MCU motor starters have the following main features:

- Direct-on-line or reversing starters
- Up to 5.5 kW
- High degree of protection, namely IP55 on MCU motor starters in a plastic enclosure and IP54 on motor starters in a metal enclosure, enables distributed configurations in the field and saves space in the control cabinet
- Electromechanical or electronic switching
- Easy and user-friendly control and monitoring through AS-Interface bus communication
- Controlled stopping through 230 V AC brake control or 400 V AC for motor brake
- Integrated lockable repair switch
- Comprehensive motor protection thanks to integrated overload and short-circuit protection with SIRIUS 3RV motor starter protectors or integrated solid-state overload relays (solid-state starters)
- Overload protection with thermal release (bimetal) or solid-state overload relay with wide range setting
- Power and load connection by means of an M screw
- Main power loop possible (daisy chain; max. 2 x 6 mm<sup>2</sup>)

- Robust and widely used M12 connection method for digital inputs and outputs to connect I/O stations and the AS-i bus connection increase flexibility and prevent errors in the system configuration.
- The LEDs (for AS-i bus connection) can provide comprehensive diagnostics of the device on the spot.
- Simple mounting for AS-i and external auxiliary voltage (24 V DC) over an M12 connection
- Manual operation: An integrated key-operated switch "MAN-0-AUTO" and a selector button for switching on, switching off and changing the direction of rotation for control purposes during commissioning or maintenance

**MCU motor starters with AS-i bus connection in a plastic enclosure**

This motor starter version offers an economical solution for controlling and monitoring conveyor belts, pumps, fans or compressors.

On this MCU the control commands and the status queries are sent over the AS-i bus. The yellow cable (bus) and the black AS-i cable for 24 V DC AUX are connected through an M12 plug.

The transparent enclosure top permits monitoring of the status LEDs. These MCUs come completely pre-wired inside.

**MCU motor starters with AS-i bus connection in a metal enclosure for electromechanical or electronic switching**

These MCUs with their rugged metal enclosure in degree of protection IP54 are ideal in particular for controlling and monitoring three-phase motors in harsh ambient conditions such as are often found in conveyor systems.

A special feature of this version is the manual local operation of the motor starter.

The key-operated switch "MAN-0-AUTO" for selecting Manual, 0 or Automatic mode prevents unauthorized changes of operating mode. In automatic mode the MCU is controlled through the AS-i bus.

In manual mode a selector button is used for switching on, switching off and changing the direction of rotation.

The status/diagnostics LEDs fitted to the cover indicate the current operating state of the motor starter.

Unlike the electromechanical starter, the electronic motor starter has wear-free solid-state switching devices which guarantee a high switching frequency.

Another highlight of the electronic switching version is the solid-state overload relay for motor protection, which has a wide setting range for the motor current.



## AS-Interface

Slaves

Motor starters for use in the field, high degree of protection

### SIRIUS MCU motor starters for AS-Interface > General data

#### Overview (continued)

			
	3RK4320-3.R51-.BA0	3RK4320-3.Q54-.BA.	3RK4320-5.Q64-.BA.
<b>Type</b>	<b>SIRIUS MCU motor starters for AS-Interface</b>		
	<b>Plastic enclosure</b>	<b>Metal enclosure</b>	<b>Metal enclosure</b>
	<b>Electromechanical switching</b>	<b>Electromechanical switching</b>	<b>Electronic switching</b>

#### Device functions (software features)

##### Slave on the bus

Fieldbus	✓	AS-i	
Bus connection	✓	M12	
Slave type	✓	AS-i Spec 2.0	✓ A/B acc. to Spec 2.1
AS-i Slave Profile IO.ID.ID2	✓	3.0.F	✓ 7.A.E
Number of assigned AS-i addresses on the bus	✓	1	
Number of stations	✓	Max. 31 devices	✓ Max. 62 devices

##### Diagnostics

LED	✓		
-----	---	--	--

##### Process image

Process image	✓	2I/2O	✓ 4I/3O
---------------	---	-------	---------

##### Data channels

Manual local operation	--		✓
------------------------	----	--	---

##### Inputs

Number	✓	1	✓	2
• Of which in the process image	✓	DI1	✓	DI2 / DI3
Connection	✓	Screw terminal, internal	✓	M12 - A coded
Input signal	✓	Switching contact or 2-wire Bero	✓	Switching contact or 2/3-wire Bero
Input level	✓	AS-i +		

##### Outputs

Number	✓	1 on the direct-on-line starter 0 on the reversing starter	✓	1
• Of which in the process image	✓	DO1	✓	DO2
Connection	✓	Screw terminal, internal	✓	M12 - A coded
Output level	✓	Relay contact, floating	✓	AUX-PWR+ (24 V DC)

##### Motor protection

Overload protection	✓	Thermal overload release	✓	Electronic overload releases Wide range
Short-circuit protection	✓			
Auto RESET	--		✓	
Temperature sensor	--		✓	TC (Thermoclick)

##### Device function

Response when repair switch is tripped	✓	Signal through AS-i		
Plug monitoring	--		Possible (with plug option)	

✓ Function available

-- Function not available.

4

## Overview

### MCU for AS-i, plastic enclosure

- Direct-on-line or reversing starters up to 12 A at 400 V AC (50/60 Hz)
- Repair switches (black/gray) lockable with padlocks (max. 3 units)
- Integrated overload and short-circuit protection with SIRIUS 3RV motor starter protectors/circuit breakers Class 10 with short-circuit breaking capacity  $I_{CU} = 50 \text{ kA}$  at 400 V AC
- Overload protection with thermal release (bimetal)
- Transparent plastic enclosure with LED status displays for monitoring the AS-i status
- IP55 degree of protection
- Cable connections by means of M screws
- Main power loop possible (daisy chain; max.  $2 \times 6 \text{ mm}^2$ )
- AS-Interface through M12 plug-in terminal
- 4 x M20 glands enclosed
- Communication: AS-Interface 2I/2O (standard slaves)

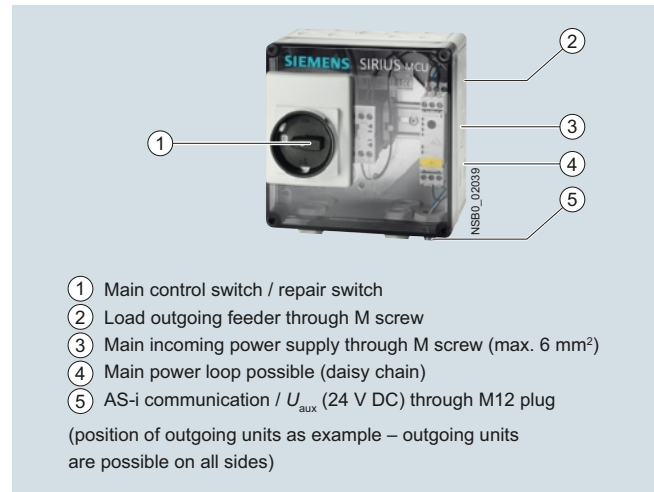

MCU for AS-i, plastic enclosure

## Selection and ordering data

	Rated current $I_e$	Suitable for three-phase motors <sup>1)</sup> with $P$	Setting range Thermal overload release	Article No.
	A	kW	A	

### Direct-on-line starters

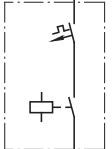
 Direct-on-line start	0.63	0.18	0.45 ... 0.63	<b>3RK4320-3AR51-0BA0</b>
	0.8	0.18	0.55 ... 0.8	<b>3RK4320-3BR51-0BA0</b>
	1	0.25	0.7 ... 1	<b>3RK4320-3CR51-0BA0</b>
	1.25	0.37	0.9 ... 1.25	<b>3RK4320-3DR51-0BA0</b>
	1.6	0.55	1.1 ... 1.6	<b>3RK4320-3ER51-0BA0</b>
	2	0.75	1.4 ... 2	<b>3RK4320-3FR51-0BA0</b>
	2.5	0.75	1.8 ... 2.5	<b>3RK4320-3GR51-0BA0</b>
	3.2	1.10	2.2 ... 3.2	<b>3RK4320-3HR51-0BA0</b>
	4	1.50	2.8 ... 4	<b>3RK4320-3JR51-0BA0</b>
	5	1.50	3.5 ... 5	<b>3RK4320-3KR51-0BA0</b>
	6.3	2.20	4.5 ... 6.3	<b>3RK4320-3LR51-0BA0</b>
	8	3.00	5.5 ... 8	<b>3RK4320-3MR51-0BA0</b>
	10	4.00	7 ... 10	<b>3RK4320-3NR51-0BA0</b>
12.5	5.50	9 ... 12.5	<b>3RK4320-3PR51-0BA0</b>	

### Reversing starters

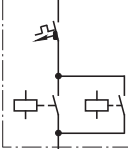
 Reversing duty	0.63	0.18	0.45 ... 0.63	<b>3RK4320-3AR51-1BA0</b>
	0.8	0.18	0.55 ... 0.8	<b>3RK4320-3BR51-1BA0</b>
	1	0.25	0.7 ... 1	<b>3RK4320-3CR51-1BA0</b>
	1.25	0.37	0.9 ... 1.25	<b>3RK4320-3DR51-1BA0</b>
	1.6	0.55	1.1 ... 1.6	<b>3RK4320-3ER51-1BA0</b>
	2	0.75	1.4 ... 2	<b>3RK4320-3FR51-1BA0</b>
	2.5	0.75	1.8 ... 2.5	<b>3RK4320-3GR51-1BA0</b>
	3.2	1.10	2.2 ... 3.2	<b>3RK4320-3HR51-1BA0</b>
	4	1.50	2.8 ... 4	<b>3RK4320-3JR51-1BA0</b>
	5	1.50	3.5 ... 5	<b>3RK4320-3KR51-1BA0</b>
	6.3	2.20	4.5 ... 6.3	<b>3RK4320-3LR51-1BA0</b>
	8	3.00	5.5 ... 8	<b>3RK4320-3MR51-1BA0</b>
	10	4.00	7 ... 10	<b>3RK4320-3NR51-1BA0</b>
12.5	5.50	9 ... 12.5	<b>3RK4320-3PR51-1BA0</b>	

<sup>1)</sup> Guide value for 4-pole standard motors at 50 Hz 400 V AC.  
The actual starting and rated data of the motor to be protected must be considered when selecting the units.

## AS-Interface

Slaves

Motor starters for use in the field, high degree of protection

SIRIUS MCU motor starters for AS-Interface > Metal enclosure, electromechanical switching

### Overview

MCU for AS-i, metal enclosure, electromechanical

- Direct-on-line or reversing starters up to 12 A
- Repair switches (black/gray) lockable with padlocks (max. 3 units)
- Short-circuit protection with SIRIUS 3RV motor starter protectors/circuit breakers CLASS 10 with short-circuit breaking capacity  $I_{cu} = 50 \text{ kA}$  at AC 400 V
- Overload protection with thermal release (bimetal)
- Manual operation and key-operated switch for operating mode selection
- LED status display of the operating states
- Metal enclosure
- Degree of protection IP54
- Switched brake control 400 V or 230 V
- Cable connections by means of M screws
- Main power loop possible (daisy chain; max.  $2 \times 6 \text{ mm}^2$ )
- 2 x M25 glands
- 1 x M12 plug for AS-i/auxiliary voltage (24 V DC)
- 2 x M12 socket for connection of 2 sensors
- 1 x M12 socket for connection of one actuator
- Communication: AS-Interface 4I/3O (slaves in A/B technology can be addressed)

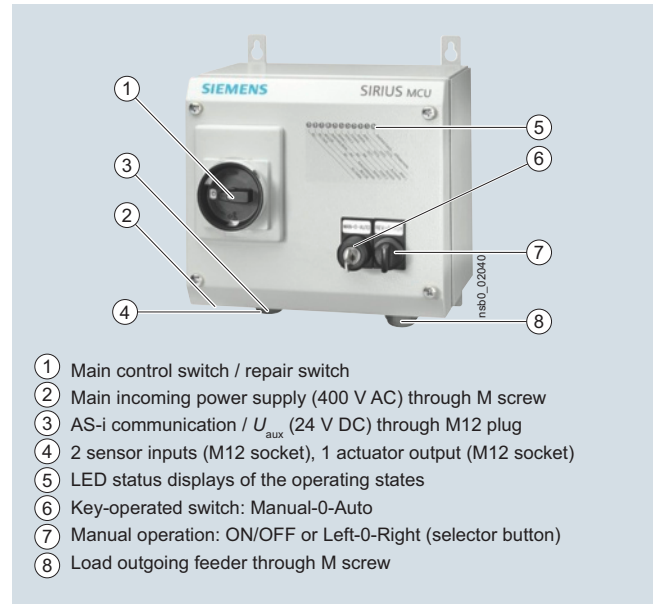

MCU for AS-i, metal enclosure, electromechanical switching

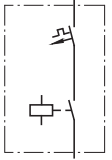

## Selection and ordering data

	Rated current $I_e$	Suitable for three-phase motors <sup>1)</sup> with $P$	Setting range Thermal overload release	Article No.
	A	kW	A	
<b>Direct-on-line starters</b>				
	0.63	0.18	0.45 ... 0.63	<b>3RK4320-3AQ54- 0BA</b> ■
	0.8	0.18	0.55 ... 0.8	<b>3RK4320-3BQ54- 0BA</b> ■
	1	0.25	0.7 ... 1	<b>3RK4320-3CQ54- 0BA</b> ■
	1.25	0.37	0.9 ... 1.25	<b>3RK4320-3DQ54- 0BA</b> ■
	1.6	0.55	1.1 ... 1.6	<b>3RK4320-3EQ54- 0BA</b> ■
	2	0.75	1.4 ... 2	<b>3RK4320-3FQ54- 0BA</b> ■
	2.5	0.75	1.8 ... 2.5	<b>3RK4320-3GQ54- 0BA</b> ■
	3.2	1.10	2.2 ... 3.2	<b>3RK4320-3HQ54- 0BA</b> ■
	4	1.50	2.8 ... 4	<b>3RK4320-3JQ54- 0BA</b> ■
	5	1.50	3.5 ... 5	<b>3RK4320-3KQ54- 0BA</b> ■
	6.3	2.20	4.5 ... 6.3	<b>3RK4320-3LQ54- 0BA</b> ■
	8	3.00	5.5 ... 8	<b>3RK4320-3MQ54- 0BA</b> ■
	10	4.00	7 ... 10	<b>3RK4320-3NQ54- 0BA</b> ■
	12.5	5.50	9 ... 12.5	<b>3RK4320-3PQ54- 0BA</b> ■
<b>Brake control / V</b>				
• 230				
• 400				

## Reversing starters

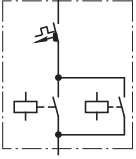
	0.63	0.18	0.45 ... 0.63	<b>3RK4320-3AQ54- 1BA</b> ■
	0.8	0.18	0.55 ... 0.8	<b>3RK4320-3BQ54- 1BA</b> ■
	1	0.25	0.7 ... 1	<b>3RK4320-3CQ54- 1BA</b> ■
	1.25	0.37	0.9 ... 1.25	<b>3RK4320-3DQ54- 1BA</b> ■
	1.6	0.55	1.1 ... 1.6	<b>3RK4320-3EQ54- 1BA</b> ■
	2	0.75	1.4 ... 2	<b>3RK4320-3FQ54- 1BA</b> ■
	2.5	0.75	1.8 ... 2.5	<b>3RK4320-3GQ54- 1BA</b> ■
	3.2	1.10	2.2 ... 3.2	<b>3RK4320-3HQ54- 1BA</b> ■
	4	1.50	2.8 ... 4	<b>3RK4320-3JQ54- 1BA</b> ■
	5	1.50	3.5 ... 5	<b>3RK4320-3KQ54- 1BA</b> ■
	6.3	2.20	4.5 ... 6.3	<b>3RK4320-3LQ54- 1BA</b> ■
	8	3.00	5.5 ... 8	<b>3RK4320-3MQ54- 1BA</b> ■
	10	4.00	7 ... 10	<b>3RK4320-3NQ54- 1BA</b> ■
	12.5	5.50	9 ... 12.5	<b>3RK4320-3PQ54- 1BA</b> ■
<b>Brake control / V</b>				
• 230				
• 400				

<sup>1)</sup> Guide value for 4-pole standard motors at 50 Hz 400 V AC.  
The actual starting and rated data of the motor to be protected must be considered when selecting the units.

## AS-Interface

Slaves

Motor starters for use in the field, high degree of protection

### SIRIUS MCU motor starters for AS-Interface > Metal enclosure, electronic switching

#### Overview

MCU for AS-i, metal enclosure, electronic

- Direct-on-line or reversing starters up to 12 A
- Switching frequency up to 3 600/h
- Repair switches (black/gray) lockable with padlocks (max. 3 units)
- Short-circuit protection with SIRIUS 3RV motor starter protectors/circuit breakers
- Overload protection with solid-state overload relay
- Manual operation and key-operated switch for operating mode selection
- LED status display of the operating states
- Metal enclosure
- Degree of protection IP54
- Switched brake control 400 V or 230 V
- Cable connections by means of M screws
- Main power loop possible (daisy chain; max. 2 x 6 mm<sup>2</sup>)
- 2 x M25 glands
- 1 x M12 plug for AS-i/auxiliary voltage (24 V DC)
- 2 x M12 plugs for connection of 2 sensors
- 1 x M12 socket for connection of one actuator
- Communication: AS-Interface 4I/3O (slaves in A/B technology can be addressed)

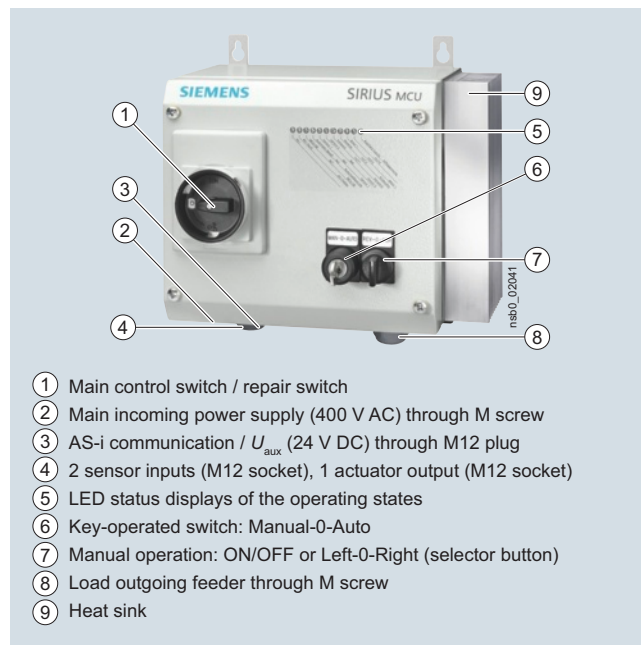

MCU for AS-i, metal enclosure, electronic switching

#### Selection and ordering data

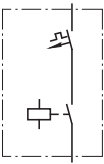
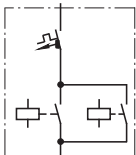
	Rating for three-phase motor Rated value <sup>1)</sup>	Current setting value of the inverse-time delayed over- load release $I_e$	Brake control	Article No.
	kW	A	V	
<b>Direct-on-line starters</b>				
 Direct-on-line start	0.12 ... 0.37	0.32 ... 1.25	230	<b>3RK4320-5DQ64-0BA2</b>
	0.55 ... 1.5	1 ... 4	230	<b>3RK4320-5JQ64-0BA2</b>
	1.1 ... 5.5	3 ... 12	230	<b>3RK4320-5PQ64-0BA2</b>
	0.12 ... 0.37	0.32 ... 1.25	400	<b>3RK4320-5DQ64-0BA3</b>
	0.55 ... 1.5	1 ... 4	400	<b>3RK4320-5JQ64-0BA3</b>
	1.1 ... 5.5	3 ... 12	400	<b>3RK4320-5PQ64-0BA3</b>
<b>Reversing starters</b>				
 Reversing duty	0.12 ... 0.37	0.32 ... 1.25	230	<b>3RK4320-5DQ64-1BA2</b>
	0.55 ... 1.5	1 ... 4	230	<b>3RK4320-5JQ64-1BA2</b>
	1.1 ... 5.5	3 ... 12	230	<b>3RK4320-5PQ64-1BA2</b>
	0.12 ... 0.37	0.32 ... 1.25	400	<b>3RK4320-5DQ64-1BA3</b>
	0.55 ... 1.5	1 ... 4	400	<b>3RK4320-5JQ64-1BA3</b>
	1.1 ... 5.5	3 ... 12	400	<b>3RK4320-5PQ64-1BA3</b>

<sup>1)</sup> Guide value for 4-pole standard motors at 50 Hz 400 V AC.  
The actual starting and rated data of the motor to be protected must be considered when selecting the units.

**Overview**

AS-Interface 3RK1400-1MQ01-0AA4 double direct-on-line starter 24 V DC

With the K60 AS-Interface 24 V DC motor starters for the low-end performance range up to 70 W, it is now possible to connect 24 V DC motors and the associated sensors directly to the AS-Interface quickly and easily.



Connection of an actuator roller with integrated DC motor to an AS-Interface 24 V DC motor starter

Three different versions are available:

- Single direct-on-line starters (without brake and reversible quick-stop function)
- Double direct-on-line starters (with brake and reversible quick-stop function)
- Reversing starters (with brake and reversible quick-stop function)

DC motors are connected to the module using M12 plug-in connections. The sensors and the module electronics can be supplied from the yellow AS-Interface cable. An auxiliary voltage (24 V DC) is only required for supplying the outputs, which can be provided via the black AS-Interface cable.

**Quick-stop function**

All AS-Interface 24 V DC motor starters feature a quick-stop function which can be switched on and off as required using a switch integrated into the module. The quick-stop function allows a connected motor to be disconnected immediately using an applied sensor signal (High). The switch for the quick-stop function is located alongside the input sockets and is protected by an M12 sealing cap.

**Brake**

The double direct-on-line starter and the single reversing starter versions feature an integrated permanently set brake function, i.e. as soon as the output signal is set to "0", the motor is braked.

**Start-up using integrated buttons**

Buttons integrated into the module (below the output sockets) can be used to set the motor used. The buttons are protected by an M12 sealing cap.

**Note concerning double and reversing starters:**

If an input with the quick-stop function receives a "High" signal, the corresponding output (e.g. quick-stop input 1  $\Rightarrow$  output 1) is switched off within the device (the motor is braked). The manual key function (Key 1/2) for local operation is only permitted to be used during "CPU Stop" in the higher-level PLC.

**Note concerning single direct-on-line starters:**

If an input with the quick-stop function receives a "High" signal, the corresponding output (e.g. quick-stop input 1  $\Rightarrow$  output 1) is switched off within the device (the motor runs down without being braked). The manual key function (Key 1) for local operation is only permitted to be used and defined during "CPU Stop" in the higher-level PLC.

# AS-Interface

Slaves

Motor starters for use in the field, high degree of protection

## Motor starters for AS-Interface, 24 V DC

### Overview (continued)

#### Applications

##### Single direct-on-line starter without brake (with adjustable quick-stop function)

1st possibility: Connection to a maximum of four sensors without pollution indication

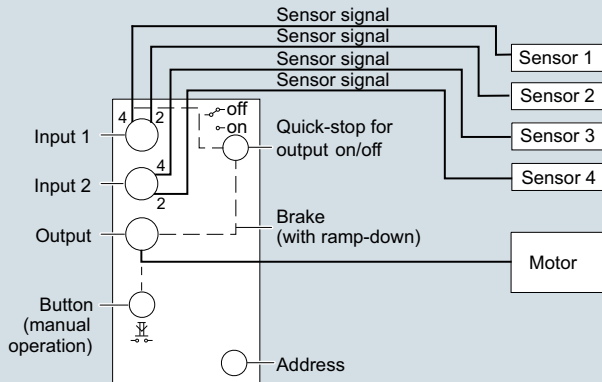

2nd possibility: Connection to a maximum of two sensors with pollution indication

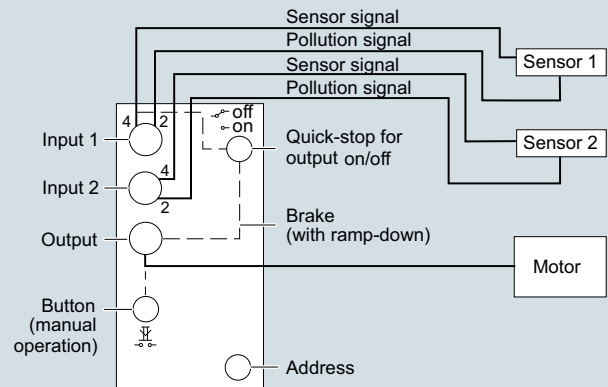

##### Double direct-on-line starter with brake (with adjustable quick-stop function)

1st possibility: Connection to a maximum of four sensors without pollution indication

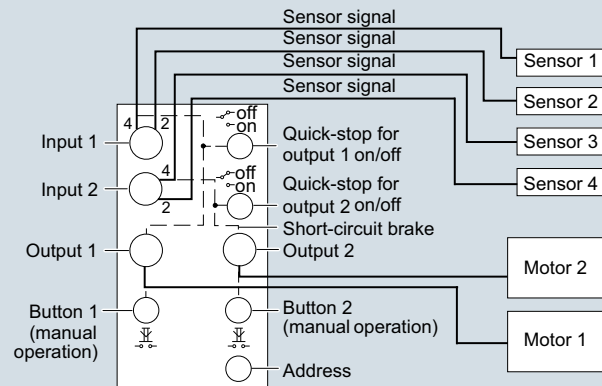

2nd possibility: Connection to a maximum of two sensors with pollution indication

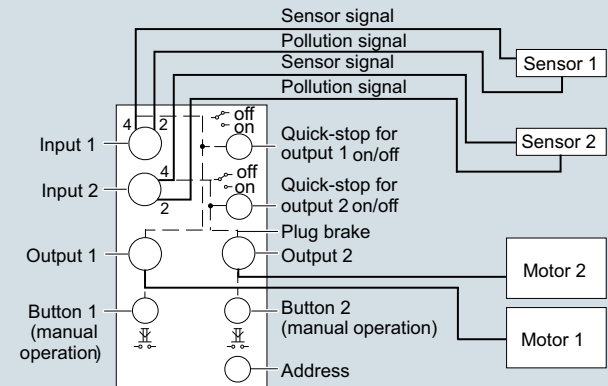

##### Single reversing starter with brake (with adjustable quick-stop function)

1st possibility: Connection to a maximum of four sensors without pollution indication

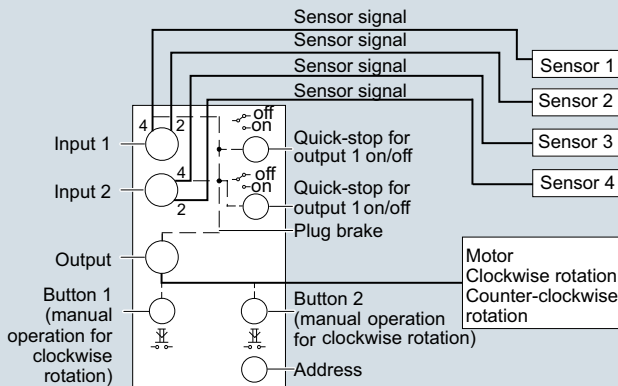

2nd possibility: Connection to a maximum of two sensors with pollution indication

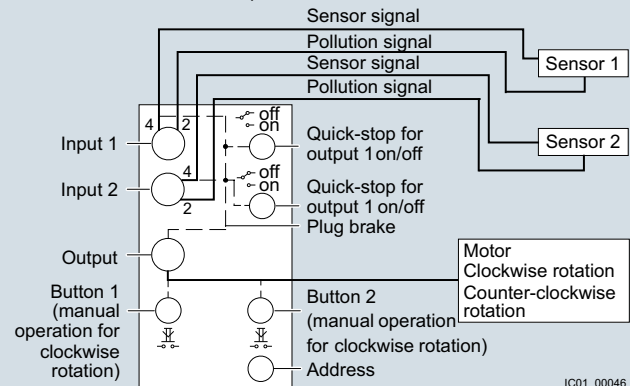

IC01\_00046





4

**Selection and ordering data**

Version	Inputs/outputs	Current carrying capacity of outputs A	Slave type	Article No.	
<b>Motor starters (width 60 mm)</b>					
	<b>Single direct-on-line starters<sup>1)</sup></b>	4 inputs / 1 output	2	Standard	<b>3RK1400-1NQ01-0AA4</b>
	<b>Double direct-on-line starters<sup>1)</sup></b>	4 inputs / 2 outputs	1 x 3 or 2 x 2	Standard	<b>3RK1400-1MQ01-0AA4</b>
	<b>Single reversing starters<sup>1)</sup></b>	4 inputs / 1 output	2.5	Standard	<b>3RK1400-1MQ03-0AA4</b>

3RK1400-1MQ01-0AA4

<sup>1)</sup> Modules supplied without mounting plate.

Version	Article No.	
<b>Accessories</b>		
	<b>K60 mounting plates</b> Suitable for all K60 compact modules <ul style="list-style-type: none"> <li>• Wall mounting</li> <li>• Standard rail mounting</li> </ul>	<b>3RK1901-0CA00</b> <b>3RK1901-0CB01</b>
	<b>AS-Interface M12 sealing caps</b> For free M12 sockets	<b>3RK1901-1KA00</b>
	<b>AS-Interface M12 sealing caps, tamper-proof</b> For free M12 sockets	<b>3RK1901-1KA01</b>
	<b>Sealing sets</b> <ul style="list-style-type: none"> <li>• For K60 mounting plate and standard distributor</li> <li>• Cannot be used for K45 mounting plate</li> <li>• Set contains one straight and one shaped seal</li> </ul>	<b>3RK1902-0AR00</b>

3RK1901-0CA00

3RK1901-1KA00

3RK1901-1KA01

3RK1902-0AR00

## AS-Interface

### Slaves

#### SINAMICS G110D distributed inverters

##### Overview

The new SINAMICS G110D distributed frequency inverter series is the solution for basic drive tasks especially in the field of conveyor systems. The inverter allows the speed of three-phase induction motors to be continually controlled and fulfills the requirements of conveyor-related applications with open-loop frequency control. It can be optimally integrated into the system thanks to its compact and low-profile design in an IP65 degree of protection. This drive can be optimally integrated into the Siemens TIA world of automation via AS-Interface.

With its wide power range from 0.75 kW to 7.5 kW, it is suitable for a wide range of distributed drive solutions.



Example: SINAMICS G110D, frame size FSA

##### Reasons for using distributed drive systems

- Modular drive solutions – therefore standardized mechatronic elements that can be individually tested
- A control cabinet is not required, resulting in a smaller space requirement and lower cooling requirements
- Long cables between the inverter and motor can be avoided (which means lower power losses, reduced noise emission and lower costs for shielded cables and additional filters)
- Distributed configurations offer considerable benefits for conveyor systems with their extensive coverage (e.g. in the automotive and logistics sectors)

##### Siemens family of distributed drives

Siemens offers an innovative portfolio of inverters to optimally implement distributed drive solutions. The strengths of the individual members of the drive family permit simple adaptation to the widest range of application demands:

- Identical connection systems
- Identical mounting dimensions for SINAMICS G110D and SINAMICS G120D
- Standard commissioning and engineering tool

Products from the family of distributed drives:

- SINAMICS G110D inverters
- SINAMICS G120D inverters
- SINAMICS G110M frequency inverters
- SIMATIC ET 200pro FC-2 frequency converters (available soon)
- SIRIUS M200D motor starters

##### Device design

SINAMICS G110D is a compact inverter in degree of protection IP65 where the Control Unit (CU) and Power Module (PM) function units are combined in one device.

The closed-loop control electronics controls and monitors the power electronics in several different control modes that can be selected. The digital inputs and analog inputs on the device mean that sensors can be simply and directly connected at the drive. The input signals can either be directly linked within the closed-loop control or they can be transferred to the central control via AS-Interface for further processing within the context of the overall system.

The power electronics supply the motor in the power range from 0.75 kW to 7.5 kW. It is controlled (open-loop) from the micro-processor-based control. State-of-the-art IGBT technology with pulse-width-modulation is used for highly reliable and flexible motor operation. It also features an extensive range of functions offering a high degree of protection for the inverter and motor. The unusually flat mechanical construction is optimized so that the device can be directly used in the plant. The compact inverter has the same drilling dimensions for all of the power ratings (standard "footprint"); further, the dimensions are identical to those of the SINAMICS G120D inverter. This significantly simplifies design engineering, installation and retrofitting of the system.

The latest technical documentation (catalogs, dimension drawings, certificates, manuals and operating instructions) are available on the Internet at:

<http://www.siemens.com/sinamics-g110d/documentation>

and offline on the DVD-ROM CA 01 in the DT Configurator. In addition, the DT Configurator can be used in the Internet without requiring any installation. The DT Configurator is available in the Industry Mall at the following address:

<http://www.siemens.com/dt-configurator>

##### STARTER commissioning tool

The STARTER commissioning tool (V4.1.3 and higher) supports the commissioning and maintenance of SINAMICS G110D inverters. The operator guidance combined with comprehensive, user-friendly functions for the relevant drive solution allow you to commission the device quickly and easily.

**Benefits**

- Wide range of power ratings from 0.75 kW to 7.5 kW
- Fast commissioning and maintenance as well as extended diagnostic functions and communications capability with AS-Interface according to Specification 3.0
  - Reduced number of interfaces
  - Plant-wide engineering
  - Easy to handle
- Mechanical design, installation and retrofit of systems are significantly simplified as a result of the compact and space-saving design with an extremely low profile and with the same drilling dimensions for all power ratings; further, the dimensions are identical with those of the SINAMICS G120D inverter.
- Simple commissioning and maintenance using the same, standardized connectors for the bus, power and I/O connections (ISO 23570) for the complete power range of SINAMICS G110D and SINAMICS G120D inverters.
- The same connectors are used as for the SIRIUS M200D motor starter
- Simple, standard implementation of complete distributed plant and system concepts by using products in a scalable fashion:
  - SIRIUS M200D (motor starter)
  - SINAMICS G110D (inverter for basic, conveyor-related applications)
  - SINAMICS G110M (distributed inverter integrated in the motor)
  - SIMATIC ET 200pro FC-2 (available soon)
  - SINAMICS G120D (inverter for sophisticated, conveyor-related applications)
- High degree of operator friendliness by using the Intelligent Operator Panel (IOP) to parameterize, diagnose, control (open-loop) and copy drive parameters in the BOP
- Easy to replace using a plug-in design and the use of a memory card provide the highest degree of service friendliness
- Simple connection, engineering, data management as well as control of the inverter in complex plants and systems as a result of the consequential integration in TIA (Totally Integrated Automation)
- Using the optional maintenance switch, the inverter can be simply disconnected from the line supply when service is required, without any additional components or without additional wiring costs when engineering the system
- Using the optional manual local control, commissioning can be carried out fast and limited to specific areas, the application can be manually pre-tested on site and the system can be cleared or emptied without requiring complex options.
- By being able to connect up to five sensors directly at the unit, practically all of the drive-relevant information can be directly managed; local pre-processing of the signals relieves the fieldbus to achieve fast and reproducible response times
- Integrated class A EMC filter (acc. to EN 55011)
- Integrated brake control, brake voltages supported: 180 V DC and 205 V DC
- Integrated motor protection using a thermal motor model and evaluation of PTC, KTY or bimetal temperature sensors
- Simple device replacement and fast copying of parameters to the memory card using the optional memory card holder and the optional memory card
- Engineering and commissioning using standard engineering tools such as SIZER (V3.2 and higher), STARTER (V4.1.3 and higher) and Drive ES ensure fast engineering and simple commissioning - STARTER is integrated into STEP 7 with Drive ES Basic, with all of the benefits of central data management and unified communication
- Software parameters for easy adaptation to 50 Hz or 60 Hz motors (IEC or NEMA motors)
- Increased degree of ruggedness and longer service life as the electronic modules are coated
- Globally certified acc. to CE, UL, C-tick

**Application**

SINAMICS G110D is ideally suited for basic conveyor system applications in the industrial environment for which a distributed drive with communications capability is required. This is especially true for distribution logistics and for airports.

Further, SINAMICS G110D is suitable for many additional low-performance applications in many sectors, e.g. in the automotive sector, in the food and beverages industry (without tensesides) and in the packaging industry.

**Selection and ordering data**

Rated power <sup>1)</sup>		Rated output current <sup>2)</sup>	Input current	Frame size	SINAMICS G110D with integrated class A line filter	SINAMICS G110D with integrated class A line filter and integrated maintenance switch
kW	hp				Article No.	Article No.
<b>380 ... 500 V 3 AC <sup>3)</sup></b>						
0.75	1	2.3	2.0	FSA	<b>6SL3511-0PE17-5AM0</b>	<b>6SL3511-1PE17-5AM0</b>
1.5	1.5 <sup>4)</sup>	4.3	3.8	FSA	<b>6SL3511-0PE21-5AM0</b>	<b>6SL3511-1PE21-5AM0</b>
3	4	7.7	7.0	FSA	<b>6SL3511-0PE23-0AM0</b>	<b>6SL3511-1PE23-0AM0</b>
4	5	10.2	9.1	FSB	<b>6SL3511-0PE24-0AM0</b>	<b>6SL3511-1PE24-0AM0</b>
5.5	7.5	13.2	12.2	FSC	<b>6SL3511-0PE25-5AM0</b>	<b>6SL3511-1PE25-5AM0</b>
7.5	10	19.0	17.9	FSC	<b>6SL3511-0PE27-5AM0</b>	<b>6SL3511-1PE27-5AM0</b>

<sup>1)</sup> Rated power based on the rated output current  $I_{rated}$ . The rated output current  $I_{rated}$  is based on the duty cycle for high overload (HO).

<sup>2)</sup> The rated output current  $I_{rated}$  is based on the duty cycle for high overload (high overload HO). These current values apply at 400 V and are specified on the rating plate.

<sup>3)</sup> 500 V +10% is possible outside the UL range.

<sup>4)</sup> Not governed by a specific standard.

## AS-Interface

### Slaves

#### SINAMICS G110D distributed inverters

##### Ordering data

##### Article No.

###### Accessories

###### Manual local control with key-operated switch

Easy to use for local operation and commissioning

6SL3555-0PL00-2AA0

###### RS232 interface cable

Connecting cable for commissioning the SINAMICS G110D frequency inverter with the STARTER commissioning tool

3RK1922-2BP00

###### USB interface cable

Connecting cable for commissioning the SINAMICS G110D frequency inverter with the STARTER commissioning tool

6SL3555-0PA00-2AA0

###### Braking resistors for SINAMICS G110D frequency inverter

To reduce the excess energy of the DC link

- Rated power 0.75 kW and 1.5 kW
- Rated power 3 kW and 4 kW
- Rated power 5.5 kW and 7.5 kW

6SL3501-0BE08-6AA0

6SL3501-0BE12-1AA0

6SL3501-0BE14-1AA0

###### Intelligent Operator Panel IOP Handheld

For use with frequency inverters with SINAMICS G120, SINAMICS G120P, SINAMICS G110D, SINAMICS G120D or SIMATIC ET 200pro FC-2

Included in the scope of delivery:

- Intelligent Operator Panel IOP
- Handheld housing
- Rechargeable batteries (4 x AA)
- Charging unit (international)
- RS232 connecting cable (3 m long, can only be used for SINAMICS G120 and SIMATIC ET 200S FC-2)
- USB cable (1 m long)

6SL3255-0AA00-4HA0

###### Memory card

The parameter settings for an inverter fit on the memory card. When service is required, e.g. after the inverter has been replaced and the data have been downloaded from the memory card the drive system is immediately ready for use again.

- SINAMICS memory card (SD card)

6SL3054-4AG00-2AA0

###### Card holder for memory card

To use the memory card, a card holder is required that can be plugged in either under the blanking cover or under the optional manual local control

6SL3555-0PM00-0AA0

###### Connector kit for braking resistor

For using or connecting other braking resistors with the SINAMICS G110D

6SL3563-4RA00-0GA00

###### UL connector fitting set

For power and motor, for using SINAMICS G110D in UL-compliant applications

6SL3563-4UA00-0GA0

###### Protection bar

For protecting the connector against shearing due to mechanical stress

- For frame sizes FSA and FSB
- For frame size FSC

6SL3263-1HA20-0GA0

6SL3263-1HC20-0GA0

###### Adapter

For mounting the SINAMICS G110D instead of a SIRIUS M200D motor starter

6SL3263-1GA20-0GA0

##### More information

Further information on technical data, accessories and ordering data is available in Catalog D 31 and online in the Siemens Industry Mall.



**Overview**

Distributed command devices of the 3SB3 series can be quickly connected to the AS-Interface using AS-Interface enclosures. Using suitable components you can make your own enclosures with integrated AS-Interface or flexibly modify existing enclosures.

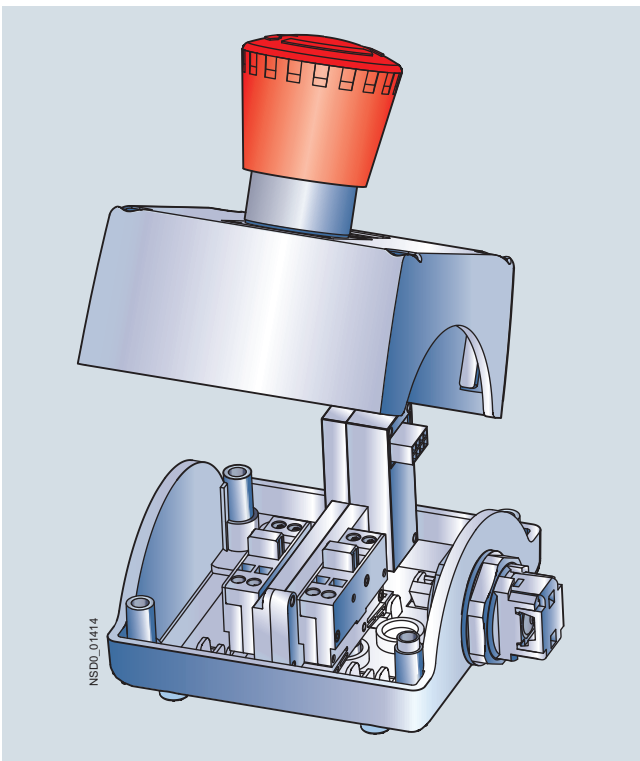
**Enclosures**

Color of enclosure cover:

- Gray, RAL 7035 or
- Yellow, RAL 1004, for EMERGENCY-STOP.

Color of enclosure base:

- Black, RAL 9005.

**Installation of AS-Interface slaves**

The following slave types are available for connecting the command points:

- Slave in A/B technology with 4 inputs and 3 outputs
- Slave with 4 inputs and 4 outputs
- F Slave with two secure inputs for EMERGENCY-STOP mushroom pushbutton

The following table shows the maximum number of equippable slaves:

Enclosures for	Number of slaves for enclosures without EMERGENCY-STOP	Number of slaves for enclosures with EMERGENCY-STOP
1 command point	Not available	1 × F slave
2 command points	1 × slave 4I/4O or 4I/3O	Not available
3 command points	1 × slave 4I/4O or 4I/3O	1 × slave 4I/4O or 4I/3O + 1 × F slave
4 command points	2 × slave 4I/4O or 4I/3O <sup>1)</sup>	2 × slave 4I/4O or 4I/3O + 1 × F slave <sup>1)</sup>
6 command points	2 × slave 4I/4O or 4I/3O	2 × slave 4I/4O or 4I/3O + 1 × F slave

<sup>1)</sup> Applies to plastic enclosures. For metal enclosures with 4 command points, only 1 × slave 4I/4O or 4I/3O is possible.

**Connection**

One set of links is required in each case to connect a slave to contact blocks, to lampholders and to the connection element.

The connection elements are mounted in the front-end cable glands and are used for connection of the AS-Interface or for bringing unused inputs or outputs out of the enclosure.

For connection to AS-Interface selection can be made between:

- Terminal for shaped AS-Interface cable.  
The cable is contacted by the insulation piercing method and routed past the enclosure on the outside (possible only with plastic enclosure).
- Cable gland for the shaped AS-Interface cable or round cable. The cable is routed into the enclosure (preferable for metal enclosure).
- Connection using M12 plug.

If less than all inputs/outputs of the installed slaves in an enclosure are used for connecting the command devices, free inputs and outputs can be routed on request to the outside through an M12 socket on the top or bottom side of the enclosure.

To supply inputs with power, the S+ connection of the slave must be assigned to the socket, for outputs the OUT- connection must be assigned.

Addressing is performed using the AS-Interface connections or the integrated addressing socket. An external power supply is not required.

**Note:**

You can find dimensional drawings, manuals and other technical information on the Internet at [www.siemens.com/industrial-controls/support](http://www.siemens.com/industrial-controls/support)

## AS-Interface

Slaves

3SF5 pushbuttons and indicator lights

Enclosure and front panel module for AS-Interface > With standard fittings

### Overview

Enclosures with standard fittings are available with:

- 1 to 3 command points,
- Operational voltage through AS-Interface (approx. 30 V),
- Vertical mounting type
- Plastic enclosures are equipped with plastic actuators and indicators, metal enclosures are equipped with metal actuators and indicators.





The enclosures without EMERGENCY-STOP each have one user module with 4I/3O; the enclosures with EMERGENCY-STOP mushroom pushbuttons have a safe AS-Interface slave integrated in the enclosure.

Enclosures with EMERGENCY-STOP mushroom pushbuttons are fitted with two NC contact blocks, which are wired to the safe slave. The contact blocks and lampholders (with spring-type terminals) of the control device, and the AS-Interface slaves, are mounted in the base of the enclosure and are cable-connected.



The plastic enclosures are designed with a connection for the AS-Interface flat cable (the cable is run passed the outside of the enclosure). For metal enclosures, the AS-Interface cable is run inside the enclosure.

The tops of enclosures with EMERGENCY-STOP mushroom pushbuttons are yellow. They are also available with an M12 connector.

### Selection and ordering data

	Version	Article No.	
 3SF5811-0AA08   3SF5812-0DA00	<i>Equipping options</i> (A, B, C = identification letters of the command points)  <b>With M12 top connector</b> A = EMERGENCY-STOP mushroom pushbuttons  <b>With terminal for insulation piercing method at top</b> A = EMERGENCY-STOP mushroom pushbuttons A = EMERGENCY-STOP mushroom pushbuttons, with protective collar B = Pushbutton green, label "I" A = Pushbutton red, label "O" B = Pushbutton white, label "I" A = Pushbutton black, label "O" C = Indicator light clear, label without inscription B = Pushbutton green, label "I" A = Pushbutton red, label "O" C = Indicator light clear, label without inscription B = Pushbutton white, label "I" A = Pushbutton black, label "O" C = Pushbutton black, label "II" B = Pushbutton black, label "I" A = Pushbutton red, label "O"	<i>No. of command points</i>  1  1 1 2 2 3 3 3	
		<b>3SF5811-0AA10</b>  <b>3SF5811-0AA08</b> <b>3SF5811-0AB08</b> <b>3SF5812-0DA00</b> <b>3SF5812-0DB00</b> <b>3SF5813-0DA00</b> <b>3SF5813-0DC00</b> <b>3SF5813-0DB00</b>	
	 3SF5811-2AB08   3SF5812-2DA00   3SF5813-2DA00	<i>Equipping options</i> (A, B, C = identification letters of the command points)  <b>With M12 top connector</b> A = EMERGENCY-STOP mushroom pushbuttons A = EMERGENCY-STOP mushroom pushbuttons, with protective collar  <b>With cable gland at top</b> A = EMERGENCY-STOP mushroom pushbuttons yellow enclosure top A = EMERGENCY-STOP mushroom pushbuttons, yellow enclosure top, with protective collar B = Pushbutton green, label "I" A = Pushbutton red, label "O" B = Pushbutton white, label "I" A = Pushbutton black, label "O" C = Indicator light clear, label without inscription B = Pushbutton green, label "I" A = Pushbutton red, label "O" C = Indicator light clear, label without inscription B = Pushbutton white, label "I" A = Pushbutton black, label "O" C = Pushbutton black, label "II" B = Pushbutton black, label "I" A = Pushbutton red, label "O"	<i>No. of command points</i>  1 1  1 1 2 2 3 3 3
			<b>3SF5811-2AA10</b> <b>3SF5811-2AB10</b>  <b>3SF5811-2AA08</b> <b>3SF5811-2AB08</b> <b>3SF5812-2DA00</b> <b>3SF5812-2DB00</b> <b>3SF5813-2DA00</b> <b>3SF5813-2DC00</b> <b>3SF5813-2DB00</b>

**Selection and ordering data****For self-equipping of the enclosures**

Version	Article No.
<i>No. of command points</i>	
 <p><b>AS-Interface slaves</b></p> <p>F slave, 2 safe inputs, for plastic enclosure, EMERGENCY-STOP, without protective collar</p> <p>F slave, 2 safe inputs, for plastic or metal enclosure EMERGENCY-STOP, with protective collar</p> <p>A/B slave, 4 inputs/3 outputs, for plastic enclosure</p> <p>Slave, 4 inputs/4 outputs, for plastic enclosure</p> <p><b>Set of links</b></p> <p>For F slave</p> <p>For slave 4I/4O or A/B slave 4I(3O)</p>	<p>1 ... 6</p> <p>1</p> <p>2 ... 6</p> <p>2 ... 6</p> <p><b>3SF5900-0BA</b></p> <p><b>3SF5900-0BB</b></p>
 <p><b>Connection elements</b></p> <p>For AS-Interface shaped cable, connection by insulation piercing method, for plastic enclosure</p> <p>For AS-Interface connection using M12 plug, for plastic enclosure</p> <p>For bringing out unused inputs/outputs through an M12 socket, for plastic enclosure</p> <p>For AS-Interface shaped cable, cable is routed into the enclosure, for plastic or metal enclosure</p> <p>For round cable, cable is routed into the enclosure, for plastic or metal enclosure</p>	<p>1 ... 3</p> <p>4 ... 6</p> <p>1 ... 3</p> <p>4 ... 6</p> <p>1 ... 3</p> <p>4 ... 6</p> <p>1 ... 3</p> <p>4 ... 6</p> <p>1 ... 3</p> <p>4 ... 6</p> <p><b>3SF5900-0CA</b></p> <p><b>3SF5900-0CB</b></p> <p><b>3SF5900-0CC</b></p> <p><b>3SF5900-0CD</b></p> <p><b>3SF5900-0CE</b></p> <p><b>3SF5900-0CF</b></p> <p><b>3SF5900-0CG</b></p> <p><b>3SF5900-0CH</b></p> <p><b>3SF5900-0CJ</b></p> <p><b>3SF5900-0CK</b></p>
<i>No. of command points</i>	
 <p><b>AS-Interface slaves</b></p> <p>F slave, 2 safe inputs, for metal enclosure EMERGENCY-STOP, without protective collar</p> <p>F slave, 2 safe inputs, for plastic or metal enclosure EMERGENCY-STOP, with protective collar</p> <p>A/B slave, 4 inputs/3 outputs, for metal enclosure</p> <p>Slave, 4 inputs/4 outputs, for metal enclosure</p> <p><b>Set of links</b></p> <p>For F slave</p> <p>For slave 4I/4O or A/B slave 4I(3O)</p> <p><b>Connection elements</b></p> <p>For AS-Interface connection using M12 plug, for metal enclosure</p> <p>For bringing out unused inputs/outputs through an M12 socket, for metal enclosure</p> <p>For AS-Interface shaped cable, cable is routed into the enclosure, for plastic or metal enclosure</p> <p>For round cable, cable is routed into the enclosure, for plastic or metal enclosure</p>	<p>1 ... 6</p> <p>1</p> <p>2 ... 6</p> <p>2 ... 6</p> <p><b>3SF5900-0BA</b></p> <p><b>3SF5900-0BB</b></p> <p>1 ... 3</p> <p>4 ... 6</p> <p>1 ... 3</p> <p>4 ... 6</p> <p>1 ... 3</p> <p>4 ... 6</p> <p>1 ... 3</p> <p>4 ... 6</p> <p><b>3SF5500-0CA</b></p> <p><b>3SF5500-0DA</b></p> <p><b>3SF5500-0CB</b></p> <p><b>3SF5500-0CC</b></p> <p><b>3SF5900-2CC</b></p> <p><b>3SF5900-2CD</b></p> <p><b>3SF5900-2CE</b></p> <p><b>3SF5900-2CF</b></p> <p><b>3SF5900-0CG</b></p> <p><b>3SF5900-0CH</b></p> <p><b>3SF5900-0CJ</b></p> <p><b>3SF5900-0CK</b></p>

**Note:**

You can find empty enclosures and elements of equipment in Catalog IC 10, Chapter "Commanding and signaling devices" and in the Industry Mall at [www.siemens.com/industrymall](http://www.siemens.com/industrymall).

## AS-Interface

Slaves

3SF5 pushbuttons and indicator lights

Enclosure and front panel module for AS-Interface > Customized equipment

### Overview



Enclosures can be equipped with optional command devices for implementing customized command device-to-AS-Interface connections.

Customized enclosures are available with between 2 and 6 command points.

One command point comprises:

- 1 actuator or indicator
- Up to 3 contact blocks or up to 2 contact blocks + 1 lampholder
- 1 inscription label

For plastic enclosures the command points are equipped as standard with plastic actuators and indicators, for metal enclosures they are equipped with metal actuators and indicators.

#### Installation of AS-Interface slaves

The following slave types are available for connecting the command points:

- Slave in A/B technology with 4 inputs and 3 outputs
- Slave with 4 inputs and 4 outputs
- F Slave with 2 safe inputs for EMERGENCY-STOP

The following table shows the maximum number of equippable slaves:

Enclosures for	Number of slaves for enclosures without EMERGENCY-STOP	Number of slaves for enclosures with EMERGENCY-STOP
2 command points	1 × slave 4I/4O or 4I/3O	Version not available
3 command points	1 × slave 4I/4O or 4I/3O	1 × slave 4I/4O or 4I/3O + 1 × F slave
4 command points	2 × slave 4I/4O or 4I/3O <sup>1)</sup>	2 × slave 4I/4O or 4I/3O + 1 × F slave <sup>1)</sup>
6 command points	2 × slave 4I/4O or 4I/3O	2 × slave 4I/4O or 4I/3O + 1 × F slave

<sup>1)</sup> Applies to plastic enclosures. For metal enclosures with 4 command points, only 1 × slave 4I/4O or 4I/3O is possible.

#### Connection

The customized enclosure is supplied fully equipped and wired. For connection to AS-Interface selection can be made between:

- Terminal for shaped AS-Interface cable.  
The cable is contacted by the insulation piercing method and routed past the enclosure on the outside (possible only with plastic enclosure).
- Cable gland for the shaped AS-Interface cable or round cable. The cable is routed into the enclosure (preferable for metal enclosure).
- Connection using M12 plug.

If less than all inputs/outputs of the installed slaves in an enclosure are used for connecting the command devices, free inputs and outputs can be routed on request to the outside through an M12 socket on the top or bottom side of the enclosure. The required pin assignments for the M12 socket must be stated on the order form.

To supply inputs with power, the S+ connection of the slave must be assigned to the socket, for outputs the OUT- connection must be assigned.

Addressing is performed using the AS-Interface connections or the integrated addressing socket. An external power supply is not required.

#### EMERGENCY-STOP

On enclosures with EMERGENCY-STOP, the EMERGENCY-STOP mushroom pushbutton can be wired conventionally or via a safe AS-Interface slave.

When the EMERGENCY-STOP mushroom pushbutton is conventionally wired, up to three switching contacts can be selected for the EMERGENCY-STOP function. If EMERGENCY-STOP is interrogated via AS-Interface, two contacts can be used for the safety circuit.

When the pushbutton is conventionally wired, an EMERGENCY-STOP contact block can be interrogated via AS-Interface if required.

#### Selection and ordering data

Customized enclosures are selected and ordered directly via the 3SB3/3SF5 configurator for pushbuttons and indicator lights.

An electronic order form will be generated for the additional options. You reach the configurator via the electronic catalog CA 01 on CD-ROM or DVD, or via the online catalog (Mall) on the Internet:

[www.siemens.com/industrymall](http://www.siemens.com/industrymall)

Select the configurator for "Pushbutton Units and Indicator Lights 3SB3, 3SF5" from the configurator list. Start the configuring process by selecting list entry "Execute" and select "Customized enclosure ASI".

The list price of the complete enclosure is generated in the configurator for the customized equipment. To utilize this service, you must register and log on in the configurator.

Please send the electronically generated order form in parallel with the order to our Competence Center at [sirius-attach.aud@siemens.com](mailto:sirius-attach.aud@siemens.com)

If you are unable to access either of these media, please contact our Technical Assistance.

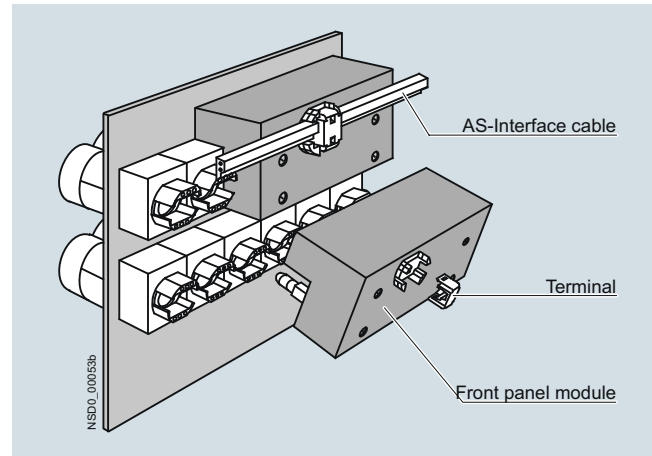
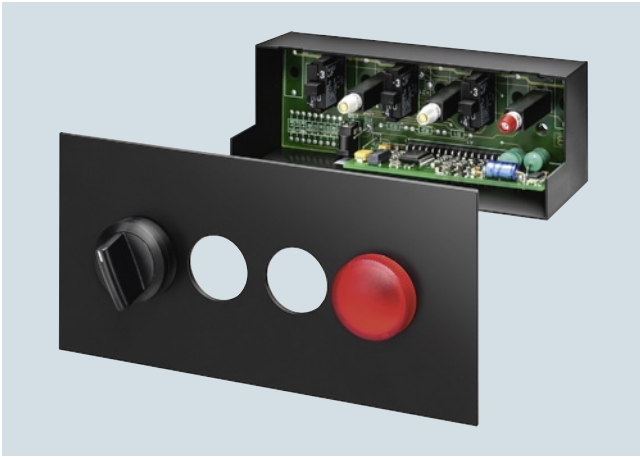
**Overview**

Series 3SB3 command devices installed in front panels can be connected to the AS-Interface bus system by means of the AS-Interface front panel module. Round or square pushbuttons and indicator lights made of plastic or metal can be used. It is not possible to use mushroom pushbuttons or acoustic signaling devices.

The front panel module consists of:

- Slave 4I/4O
- 4 3SB3 commanding and signaling devices
- Accessories (lamps, name plates, mounting parts)

Elements of equipment must be stated on the order form (see next page).

The front panel module is attached by screws to the rear face of the front panel over a group of four actuators or indicators which are lined up horizontally or vertically. The contact blocks and lampholders are integrated in the module.

The grid size required to mount command devices in the front panel measures 30 mm × 45 mm.

The AS-Interface shaped cable is connected by the insulation piercing method via a terminal at the rear of the module.

Addressing of the module is performed using the AS-Interface connections or the integrated addressing socket.

**Selection and ordering data**

Version	Article No.
<b>AS-Interface front panel module for 3SB3 command devices</b>	
4I/4O	<b>3SF5874-4AZ</b>

# AS-Interface

Slaves

3SF5 pushbuttons and indicator lights

Enclosure and front panel module for AS-Interface > Front panel module

## Selection and ordering data

The front panel module must be stated on the order form which is enclosed with the order. This order form cannot be generated by the 3SB3/3SF5 configurator. To receive an electronic copy of the order form, please contact our Technical Support:

Tel. +49 (911) 895-59 00  
Fax +49 (911) 895-59 07

All required options such as, for example, type of actuators and indicators, switching contacts, lampholders or accessories (inscription labels and lamp type) must be stated on the order form.

The order codes to be stated on the form can be found in the list of the options which are available for a surcharge.

The price for the unit is calculated from the basic price of the module and the surcharges applicable to optional equipment.

The surcharges include all components that are needed to meet the stated equipment requirements (actuators and indicators, switching contacts, lampholders and accessories).

## Order form

Order form front panel module

to [sirius-attach.aud@siemens.com](mailto:sirius-attach.aud@siemens.com)

Date

Customer order reference code

Supplier order reference code

### 1. No. of command points

4 command points

### 2. Design of actuators

- Round, plastic
- Square, plastic
- Round, metal

### 3. Name plates

- None
- With name plate including attached inscription label 12.5 mm x 27 mm
- With name plate including attached inscription label 27 mm x 27 mm

### 4. Equipment

(top view of panel front face)

Labeling of name plates

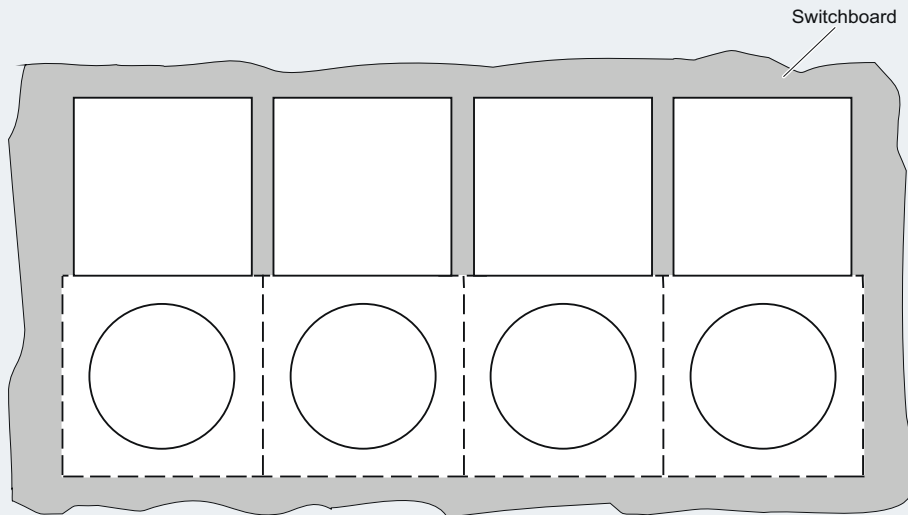

Equipment (codes)

A	B	C	D

Design of contact blocks

left	right	left	right	left	right	left	right
<input type="checkbox"/> 1 NO	<input type="checkbox"/> 1 NO	<input type="checkbox"/> 1 NO	<input type="checkbox"/> 1 NO	<input type="checkbox"/> 1 NO	<input type="checkbox"/> 1 NO	<input type="checkbox"/> 1 NO	<input type="checkbox"/> 1 NO
<input type="checkbox"/> 1 NC	<input type="checkbox"/> 1 NC	<input type="checkbox"/> 1 NC	<input type="checkbox"/> 1 NC	<input type="checkbox"/> 1 NC	<input type="checkbox"/> 1 NC	<input type="checkbox"/> 1 NC	<input type="checkbox"/> 1 NC

NSDQ\_00057d

### 5. Lamps for illuminated actuators and indicator lights

- 24 V incandescent lamp (also used if no other option is selected)
- 30 V incandescent lamp
- Super bright LED (the color of the LED matches the color of the actuator/indicator light)

## Selection and ordering data (continued)

## Selection of equipment according to order form

Version	Codes according to colors													
	Black		Red		Yellow		Green		Blue		White		Clear	
<b>Actuators and indicators</b>														
Pushbuttons with flat button	D	BK	D	RD	D	YE	D	GN	D	BU	D	WH	D	CL
Illuminated pushbuttons with flat button	–		DL	RD	DL	YE	DL	GN	DL	BU	DL	WH	DL	CL
Pushbuttons with raised button	DH	BK	DH	RD	DH	YE	–		DH	BU	–		–	
Illuminated pushbuttons with raised button	–		DHL	RD	DHL	YE	DHL	GN	DHL	BU	–		DHL	CL
Pushbuttons with raised front ring	DHF	BK	DHF	RD	DHF	YE	DHF	GN	DHF	BU	DHF	WH	–	
Pushbuttons with raised front ring, castellated <sup>1)</sup>	DFZ	BK	DFZ	RD	DFZ	YE	DFZ	GN	DFZ	BU	DFZ	WH	–	
Pushbutton switches with flat button	DS	BK	DS	RD	DS	YE	DS	GN	DS	BU	DS	WH	–	
Illuminated pushbutton switches with flat button	–		DLS	RD	DLS	YE	DLS	GN	DLS	BU	DLS	WH	DLS	CL
Indicator lights, smooth lens	–		L	RD	L	YE	L	GN	L	BU	L	WH	L	CL

## Selector switches with 2 switch positions

Switching sequence O-I, latching 

Non-illuminated	K1	BK	K1	RD	–		K1	GN	–		K1	WH	–	
Illuminated	–		BK1	RD	BK1	YE	BK1	GN	BK1	BU	–		BK1	CL

Switching sequence O-I, momentary contact 

Non-illuminated	K2	BK	K2	RD	–		K2	GN	–		K2	WH	–	
Illuminated	–		BK2	RD	BK2	YE	BK2	GN	BK2	BU	–		BK2	CL

## Selector switches with 3 switch positions

Switching sequence I-O-II, latching 

Non-illuminated	K4	BK	K4	RD	–		K4	GN	–		K4	WH	–	
Illuminated	–		BK4	RD	BK4	YE	BK4	GN	BK4	BU	–		BK4	CL

Switching sequence I-O-II, momentary contact 

Non-illuminated	K5	BK	K5	RD	–		K5	GN	–		K5	WH	–	
Illuminated	–		BK5	RD	BK5	YE	BK5	GN	BK5	BU	–		BK5	CL

Switching sequence I-O-II, latching to the right, momentary contact to the left 

Non-illuminated	K6	BK	K6	RD	–		K6	GN	–		K6	WH	–	
-----------------	----	----	----	----	---	--	----	----	---	--	----	----	---	--

Switching sequence I-O-II, latching to the left, momentary contact to the right 

Non-illuminated	K7	BK	K7	RD	–		K7	GN	–		K7	WH	–	
-----------------	----	----	----	----	---	--	----	----	---	--	----	----	---	--

<sup>1)</sup> For plastic version only.

## Note:

For more information about actuators and indicator lights, see Catalog IC 10, Chapter "Commanding and signaling devices" and in the Industry Mall at: [www.siemens.com/industrymall](http://www.siemens.com/industrymall).

**AS-Interface**

Slaves

3SF5 pushbuttons and indicator lights

Enclosure and front panel module for AS-Interface &gt; Front panel module

**Selection and ordering data** (continued)**Selection of equipment according to order form**

Version	Codes Key can be removed in position							
	O	I	II	O and I	O and II	I and II	I, O and II	

**Locks with 2 switch positions****Switching sequence O-I, latching** 

Type RONIS:										
Lock No. SB30	RSB	1A	RSB	1E	–	RSB	1AE	–	–	–
Type CES:										
Lock No. SSG 10	CES	1A	CES	1E	–	CES	1AE	–	–	–
Lock No. LSG 1	CESL	1A	–	–	–	CESL	1AE	–	–	–
Type CES with key monitoring:										
Lock No. SSG 10	CES SU	1A								
Type BKS:										
Lock No. S1	BKS	1A	BKS	1E	–	BKS	1AE	–	–	–
Lock No. E1 (for VW)	BKS A	1A	–	–	–	BKS A	1AE	–	–	–
Lock No. E2 (for VW)	BKS E	1A	–	–	–	BKS E	1AE	–	–	–
Lock No. E7 (for VW)	BKS C	1A	–	–	–	BKS C	1AE	–	–	–
Lock No. E9 (for VW)	BKS B	1A	–	–	–	BKS B	1AE	–	–	–
Type O.M.R.:										
Black, lock No. 73034	OMR BK	1A	OMR BK	1E	–	OMR BK	1AE	–	–	–

**Switching sequence O-I, momentary contact** 

Type RONIS:										
Lock No. SB30	RSB	2A	–	–	–	–	–	–	–	–
Type CES:										
Lock No. SSG 10	CES	2A	–	–	–	–	–	–	–	–
Lock No. LSG 1	CESL	2A	–	–	–	–	–	–	–	–
Type BKS:										
Lock No. S1	BKS	2A	–	–	–	–	–	–	–	–
Type O.M.R.:										
Black, lock No. 73034	OMR BK	2A	–	–	–	–	–	–	–	–

**Locks with 3 switch positions****Switching sequence I-O-II, latching** 

Type RONIS:												
Lock No. SB30	RSB	4A	RSB	4E	RSB	4D	–	–	RSB	4ED	RSB	4EAD
Type CES:												
Lock No. SSG 10	CES	4A	CES	4E	CES	4D	–	–	CES	4ED	CES	4EAD
Type CES with key monitoring:												
Lock No. SSG 10	CES SU	4A										
Type BKS:												
Lock No. S1	BKS	4A	BKS	4E	BKS	4D	–	–	BKS	4ED	BKS	4EAD
Type O.M.R.:												
Black, lock No. 73034	OMR BK	4A	–	–	–	–	–	–	OMR BK	4ED	OMR BK	4EAD

**Switching sequence I-O-II, momentary contact** 

Type RONIS:										
Lock No. SB30	RSB	5A	–	–	–	–	–	–	–	–
Type CES:										
Lock No. SSG 10	CES	5A	–	–	–	–	–	–	–	–
Type BKS:										
Lock No. S1	BKS	5A	–	–	–	–	–	–	–	–
Type O.M.R.:										
Black, lock No. 73034	OMR BK	5A	–	–	–	–	–	–	–	–

**Note:**

For more information about actuators and indicator lights, see Catalog IC 10, Chapter "Commanding and signaling devices" and in the Industry Mall at: [www.siemens.com/industrymall](http://www.siemens.com/industrymall).



**Selection and ordering data** (continued)**Selection of equipment according to order form**

Version	Codes Key can be removed in position						
	O	I	II	O and I	O and II	I and II	I, O and II

**Locks with 3 switch positions****Switching sequence I–O–II, latching to the right, momentary contact to the left** 

Type RONIS: Lock No. SB30	RSB	6A	–	RSB	6D	–	RSB	6AD	–	–
Type CES: Lock No. SSG 10	CES	6A	–	CES	6D	–	CES	6AD	–	–
Type BKS: Lock No. S1	BKS	6A	–	BKS	6D	–	BKS	6AD	–	–
Type O.M.R.: Black, lock No. 73034	OMR BK	6A	–	OMR BK	6D	–	OMR BK	6AD	–	–

**Switching sequence I–O–II, latching to the left, momentary contact to the right** 

Type RONIS: Lock No. SB30	RSB	7A	RSB	7E	–	RSB	7AE	–	–	–
Type CES: Lock No. SSG 10	CES	7A	CES	7E	–	CES	7AE	–	–	–
Type BKS: Lock No. S1	BKS	7A	BKS	7E	–	BKS	7AE	–	–	–
Type O.M.R.: Black, lock No. 73034	OMR BK	7A	OMR BK	7E	–	–	–	–	–	–

**Note:**

For more information about actuators and indicator lights, see Catalog IC 10, Chapter "Commanding and signaling devices" and in the Industry Mall at: [www.siemens.com/industrymall](http://www.siemens.com/industrymall).

## AS-Interface

Slaves

8WD4 signaling columns

### General data

#### Overview

The 8WD4 signaling columns are flexible in design and versatile in use.

They are used in machines or in automatic processes for monitoring complex procedures or as visual or acoustic warning devices in emergency situations, e.g. for displaying individual assembly stages.



8WD44 signaling columns with connection to AS-Interface cables

Two product series are available:

- 8WD42
  - Thermoplast enclosure, diameter 50 mm
  - Degree of protection IP54
- 8WD44
  - Thermoplast enclosure, diameter 70 mm
  - Advanced design and significantly improved illumination
  - Fast and flexible connection using spring-type terminals (optional)
  - Integrated degree of protection IP65

A signaling column (from top to bottom) consists of the cover, several light elements, the AS-Interface adapter element, the connection element and (depending on the mounting method) different fixing components.

One acoustic element can be optionally mounted per signaling column. The cover is included in the scope of supply of the acoustic element and fixed in place. The cover supplied with the connection element is then not needed.

#### Communications via AS-Interface

The 8WD4 signaling columns can be directly connected to the AS-Interface bus system through an adapter element that can be integrated in the column. Wiring outlay is reduced as the result.

##### Connection

8WD42:

The two-wire bus cable is fixed to the screw terminals in the connection element. The adapter element must be the first module to be mounted on the connection element. A maximum of 4 signaling elements can then be mounted on it.

The 8WD4228-0BB adapter element is a standard slave.

8WD44:









The two-wire bus cable is fixed to the screw or spring-type terminals in the connection element. The adapter element must be the first module to be mounted on the connection element. The signaling elements can then be mounted on it.

The 8WD4428-0BE adapter element is a standard slave.

A maximum of 4 signaling elements can be mounted on it.

The 8WD4428-0BD adapter element with A/B technology enables the connection of up to 62 slaves on one AS-Interface system. The addressing socket provides user-friendly parameterization of the AS-Interface elements. A maximum of 3 signaling elements can be mounted on it.

**Selection and ordering data**

	Version	Rated voltage	Color	Article No.
<b>Acoustic elements</b> <sup>1)</sup>				
	<b>Buzzer elements</b> 80 dB, pulsating or continuous tone, adjustable by means of a wire jumper	24 V AC/DC	Black	<b>8WD4220-0FA</b>
<b>Light elements for incandescent lamps/LEDs, BA 15d bases</b> <sup>2)</sup>				
 	<b>Continuous light elements</b>	24 ... 230 V AC/DC	Red Green Yellow Clear Blue	<b>8WD4200-1AB</b> <b>8WD4200-1AC</b> <b>8WD4200-1AD</b> <b>8WD4200-1AE</b> <b>8WD4200-1AF</b>
<b>Light elements with integrated LED</b>				
	<b>Continuous light elements</b>	24 V AC/DC	Red Green Yellow Clear Blue	<b>8WD4220-5AB</b> <b>8WD4220-5AC</b> <b>8WD4220-5AD</b> <b>8WD4220-5AE</b> <b>8WD4220-5AF</b>
 	<b>Blinklight elements</b>	24 V AC/DC	Red Green Yellow Clear Blue	<b>8WD4220-5BB</b> <b>8WD4220-5BC</b> <b>8WD4220-5BD</b> <b>8WD4220-5BE</b> <b>8WD4220-5BF</b>
<b>Adapter elements for AS-Interface</b>				
	<b>AS-Interface adapter elements</b> With/without external auxiliary voltage, switchable • Standard AS-i	for 4 signaling elements	Black	<b>8WD4228-0BB</b>
<b>Connection elements</b> <sup>3)</sup>				
	<b>Connection elements with cover</b> Screw terminals • For mounting on pipes, brackets and floors		Black	<b>8WD4208-0AA</b>

<sup>1)</sup> One acoustic element can be mounted per signaling column.  
The cover is included in the scope of supply of the acoustic elements and fixed in place.

<sup>2)</sup> The lamp is not included in the scope of supply. Please order separately.

<sup>3)</sup> The connection element with cover is an essential part for assembling the signaling columns.

**AS-Interface**

Slaves

8WD4 signaling columns

**8WD42 signaling columns, 50 mm diameter****Selection and ordering data** (continued)

	Version	Article No.
<b>Mounting</b>		
	<b>Feet, single</b>	Plastic, for mounting on pipes Metal, for pipe lengths > 400 mm Plastic, for floor mounting (without pipe)
		<b>8WD4308-0DB</b> <b>8WD4308-0DC</b> <b>8WD4208-0DE</b>
	<b>Adjustable-angle feet</b> for positioning in 7.5° increments <sup>1)</sup>	Plastic, for mounting on pipes, incl. rubber seal
		<b>8WD4408-0DF</b>
	<b>Pipes, single</b>	Length 100 mm Length 150 mm Length 250 mm Length 400 mm Length 1 000 mm
		<b>8WD4208-0EF</b> <b>8WD4308-0EE</b> <b>8WD4308-0EA</b> <b>8WD4308-0EB</b> <b>8WD4308-0ED</b>
	<b>Sockets for feet</b>	Side cable outlet (can also be used without feet)
		Side cable outlet, with magnetic fixing <sup>2)</sup>
		<b>8WD4308-0DD</b> <b>8WD4308-0DE</b>
	<b>Brackets for mounting with foot</b>	
		<b>8WD4408-0CC</b>
	<b>Brackets for wall mounting</b> (plastic)	Mounting without feet and pipe
		<b>8WD4208-0CD</b>
	<b>Adapters for single-hole mounting</b>	Mounting without feet and pipe, with M18 thread and fixing nut
		<b>8WD4208-0EH</b>
<b>Lamps</b>		
	<b>Incandescent lamps, 5 W, 24 V AC/DC</b> Base BA 15d	
		<b>8WD4328-1XX</b>
	<b>LEDs, 24 V AC/DC</b> Base BA 15d	Red Green Yellow Clear Blue
		<b>8WD4428-6XB</b> <b>8WD4428-6XC</b> <b>8WD4428-6XD</b> <b>8WD4428-6XE</b> <b>8WD4428-6XF</b>

<sup>1)</sup> Markings for 30°, 45°, 60° and 90°.

<sup>2)</sup> For horizontal mounting, only 1 element is recommended.

**Selection and ordering data**

	Version	Rated voltage	Color	Article No.
<b>Acoustic elements</b> <sup>1)</sup>				
	<b>Buzzer elements</b> 85 dB, pulsating or continuous tone, adjustable by means of a wire jumper	24 V AC/DC	Black	<b>8WD4420-0FA</b>
	<b>Siren elements</b> , multi-tone, 100 dB, 8 tones and volume are adjustable	24 V AC/DC	Black	<b>8WD4420-0EA2</b>
	<b>Siren elements</b> 108 dB, IP40	24 V DC	Black	<b>8WD4420-0EA</b>
<b>Light elements for incandescent lamps/LEDs, BA 15d bases</b> <sup>2)</sup>				
	<b>Continuous light elements</b>	12 ... 230 V AC/DC	Red	<b>8WD4400-1AB</b>
			Green	<b>8WD4400-1AC</b>
			Yellow	<b>8WD4400-1AD</b>
			Clear	<b>8WD4400-1AE</b>
			Blue	<b>8WD4400-1AF</b>
<b>Light elements with integrated flash lamp</b> <sup>3)</sup>				
	<b>Flashlight elements</b> with integrated electronic flash	24 V DC	Red	<b>8WD4420-0CB</b>
			Green	<b>8WD4420-0CC</b>
			Yellow	<b>8WD4420-0CD</b>
			Clear	<b>8WD4420-0CE</b>
			Blue	<b>8WD4420-0CF</b>
<b>Light elements with integrated LED</b>				
	<b>Continuous light elements</b>	24 V AC/DC	Red	<b>8WD4420-5AB</b>
			Green	<b>8WD4420-5AC</b>
			Yellow	<b>8WD4420-5AD</b>
			Clear	<b>8WD4420-5AE</b>
			Blue	<b>8WD4420-5AF</b>
	<b>Blinklight elements</b>	24 V AC/DC	Red	<b>8WD4420-5BB</b>
			Green	<b>8WD4420-5BC</b>
			Yellow	<b>8WD4420-5BD</b>
			Clear	<b>8WD4420-5BE</b>
			Blue	<b>8WD4420-5BF</b>
	<b>Rotating light elements</b>	24 V AC/DC	Red	<b>8WD4420-5DB</b>
			Green	<b>8WD4420-5DC</b>
			Yellow	<b>8WD4420-5DD</b>
			Clear	<b>8WD4420-5DE</b>
			Blue	<b>8WD4420-5DF</b>
<b>Adapter elements for AS-Interface</b>				
	<b>AS-Interface adapter elements</b>			
	With/without external auxiliary voltage, switchable			
	• A/B technology	for 3 signaling elements	Black	<b>8WD4428-0BD</b>
	• Standard AS-i	for 4 signaling elements	Black	<b>8WD4428-0BE</b>
<b>Connection elements</b> <sup>4)</sup>				
	<b>Connection elements with cover</b>		Black	
	Screw terminals			
	• For mounting on pipes			<b>8WD4408-0AA</b>
	• For mounting on brackets and floors			<b>8WD4408-0AB</b>
	Spring-type terminals			
• For mounting on pipes			<b>8WD4408-0AD</b>	
• For mounting on brackets and floors			<b>8WD4408-0AE</b>	
Cover (replacement)				<b>8WD4408-0XA</b>

<sup>1)</sup> One acoustic element can be mounted per signaling column.  
The cover is included in the scope of supply of the acoustic elements and fixed in place.

<sup>2)</sup> The lamp is not included in the scope of supply. Please order separately.

<sup>3)</sup> The lamp is included in the scope of supply.

<sup>4)</sup> The connection element with cover is an essential part for assembling the signaling columns.

**AS-Interface**

Slaves

8WD4 signaling columns

8WD44 signaling columns, 70 mm diameter

**Selection and ordering data** (continued)

	Version	Article No.
<b>Mounting</b>		
	<b>Foot with pipe</b> Pipe length 100 mm	<b>8WD4308-0DA</b>
	<b>Feet, single</b> Plastic, for mounting on pipes Metal, for pipe lengths > 400 mm	<b>8WD4308-0DB</b> <b>8WD4308-0DC</b>
	<b>Adjustable-angle feet</b> for positioning in 7.5° increments <sup>1)</sup> Plastic, for mounting on pipes, incl. rubber seal	<b>8WD4408-0DF</b>
	<b>Pipes, single</b> Length 100 mm Length 150 mm Length 250 mm Length 400 mm Length 1 000 mm	<b>8WD4208-0EF</b> <b>8WD4308-0EE</b> <b>8WD4308-0EA</b> <b>8WD4308-0EB</b> <b>8WD4308-0ED</b>
	<b>Sockets for feet</b> Side cable outlet (can also be used without feet)  Side cable outlet, with magnetic fixing <sup>2)</sup>	<b>8WD4308-0DD</b> <b>8WD4308-0DE</b>
	<b>Brackets for wall mounting</b> (mounting without feet and pipe)  For single-sided mounting  For double-sided mounting	<b>8WD4308-0CA</b> <b>8WD4308-0CB</b>
	<b>Brackets for mounting with foot</b>	<b>8WD4408-0CC</b>
	<b>Brackets for base mounting</b> Mounting without feet and pipe	<b>8WD4408-0CD</b>
	<b>Adapters for mounting on pipes according to NPT</b> Mounting on pipes, Ø 25 mm, with NPT 1/2" thread	<b>8WD4308-0DF</b>
<b>Lamps</b>		
	<b>Incandescent lamps, 5 W, 24 V AC/DC</b> Base BA 15d	<b>8WD4328-1XX</b>
	<b>LEDs, 24 V AC/DC</b> Base BA 15d  Red Green Yellow Clear Blue	<b>8WD4428-6XB</b> <b>8WD4428-6XC</b> <b>8WD4428-6XD</b> <b>8WD4428-6XE</b> <b>8WD4428-6XF</b>

1) Markings for 30°, 45°, 60° and 90°.

2) For horizontal mounting, only 1 element is recommended.

## Overview



AS-Interface power supply unit for 3 A

AS-Interface power supply units feed 30 V DC into the AS-Interface cable and supply the AS-Interface components. They include power-optimized data decoupling for the separation of communication signals and control supply voltage. As the result, AS-Interface is able to convey both data and power along a single line. The power supply units are resistant to overload and short circuits.

## Dimensions

AS-Interface power supply units have compact dimensions in widths of 50 / 70 / 120 mm. No distances from other devices need to be observed when mounting the power supply units.

## Features



- Higher rating: The power supply units deliver currents of 2.6 to 8 A.
- Integrated data decoupling: As the result, AS-Interface is able to convey both data and power along a single line.
- Integrated ground-fault detection: The power supply units perform the reliable detection and signaling of ground faults according to IEC 60204-1. The AS-Interface voltage can be disconnected automatically in the event of a ground fault.
- Integrated overload detection: An output overload is detected and reported over a diagnostics LED.
- Diagnostics memory: Any ground faults or overloads on the output side are stored in a diagnostics memory until the device is RESET.
- Remote RESET and remote signaling: Using relay contacts, a ground fault can be signaled and evaluated by a central controller and/or indicator light.
- Diagnostics LEDs: Three different LEDs indicate the status of the AS-Interface power supply locally at the power supply unit.
- Ultra-wide input range / two-phase connection: The ultra-wide input range of 120 to 500 V of the 8 A version means that the supply units can be used in virtually any network worldwide. In addition, this version dispenses with the need for an N-conductor as the device can be connected directly between 2 phases of a network.
- Operation with 24 V DC: The 3 A power supply unit is also available as a version with a 24 V DC input. This power supply unit is suitable for use in battery-powered systems or in systems with UPS (uninterruptible power supply).
- Removable terminal blocks with spring-type connections: For easy exchanging of devices, each power supply unit has three removable terminal blocks: for the input side, for the output side and for Signal/RESET connections.

4

## Benefits

- Complete solution for supplying AS-Interface networks while making full use of the maximum possible cable length per AS-i segment
- Only AS-i masters and AS-i slaves need to be connected to the AS-Interface cable in order to operate AS-Interface
- Compact, space-saving dimensions
- Reliable power supply even for large numbers of AS-Interface modules with a high power requirement
- Integrated ground-fault and overload detection saves the need for additional components and enhances safety
- Fast fault detection and reduced downtimes thanks to diagnostics memory, remote signaling and remote RESET
- Reduced downtimes as the result of removable terminal blocks which enable the fast exchanging of devices
- Ultra-wide input range of the 8 A version permits single-phase and two-phase operation and saves the need for an N-conductor
- Can be used world-wide thanks to, for example, UL/CSA approval (UL 508)
- With the 2.6 A version the output power is restricted to max. 100 W for use in NEC Class 2 circuits

## Selection and ordering data

Version	Spring-type terminals	Article No.
<b>AS-Interface power supply units, IP20</b>		
<ul style="list-style-type: none"> <li>• AS-i single output 30 V DC</li> <li>• With integrated ground-fault detection</li> <li>• With the 2.6 A version, the output power is restricted to max. 100 W (for use in NEC Class 2 circuits)</li> <li>• Dimensions: Width: 50 mm (3 A/2.6 A); 70 mm (5 A), 120 mm (8 A); Height: 125 mm; Depth: 125 mm</li> </ul>		
		
3RX9501-0BA00		
		
3RX9503-0BA00		
Output current	Input voltage	
2.6 A/max. 100 W	120/230 V AC (selectable)	<b>3RX9501-2BA00</b>
3 A	120/230 V AC (selectable)	<b>3RX9501-0BA00</b>
3 A	24 V DC	<b>3RX9501-1BA00</b>
5 A	120/230 V AC (selectable)	<b>3RX9502-0BA00</b>
8 A	120/230 ... 500 V AC (selectable)	<b>3RX9503-0BA00</b>

## AS-Interface

### Power supply units and data decoupling modules

#### 30 V power supply units

##### Overview



PSN130S 30 V power supply units for 3 A, 4 A and 8 A

The PSN130S 30 V power supply units feed 30 V DC into the AS-Interface cable and supply the AS-Interface components, but do not include data decoupling. Data decoupling modules are needed in addition therefore to separate communication signals and control supply voltage, see page 4/140 or 4/142.

The power supply units are resistant to overload and short circuits.

##### Dimensions

The 30 V power supply units have compact dimensions in widths of 50 and 70 mm. No distances from other devices need to be observed when mounting the power supply units.

##### Features

- Primary clocked power supply units for connection to a single-phase AC network
- Power for currents of 3, 4 and 8 A
- The output voltage is floating, and resistant to short-circuits and no-load operation. In the event of an overload, the output voltage will be reduced or switched off. After a short-circuit or overload the devices will start up again automatically.
- In the event of a device fault, the output voltage will be limited to max. 37 V.
- Modular installation devices in degree of protection IP20 and safety class I
- Diagnostics: With an output voltage > 26.5 V DC, the green LED (30V O.K.) is lit and the signaling contact 13-14 is closed.

##### Benefits

- Low-cost alternative solution for supplying AS-Interface networks while making full use of the maximum possible cable length per AS-i segment
- Cost advantage particularly for multiple networks
- Compact, space-saving dimensions
- Reliable power supply even for large numbers of AS-Interface modules with a high power requirement
- Can be used world-wide thanks to, for example, UL/CSA approval (UL 508)

##### Application

#### Configuration examples of AS-Interface networks with a 30 V power supply unit

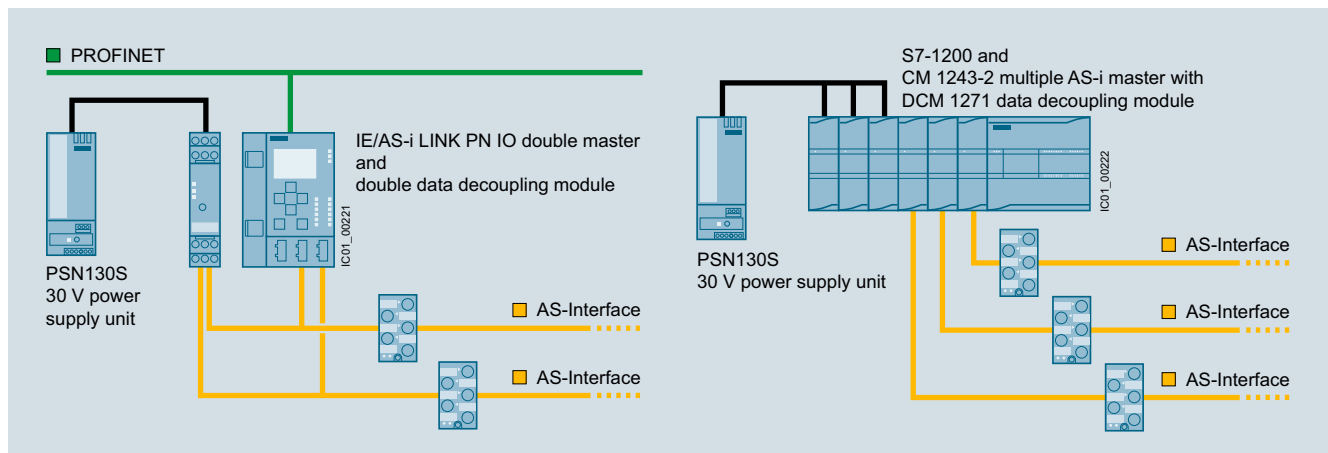

Configuration of AS-Interface multiple networks, each with one PSN130S 30 V power supply unit (examples with schematic representation):  
 Left: Double network based on the S22.5 double data decoupling module and IE/AS-i LINK PN IO double master  
 Right: Triple network based on the SIMATIC S7-1200 with DCM 1271 data decoupling modules and CM 1243-2 communication processors



### Technical specifications

Version		3 A	4 A	8 A
<b>Input data</b>				
• Input voltage, rated value $U_e$	V AC	120 / 230 V, single-phase, automatic selection		
• Input voltage range	V AC	85 ... 132 / 174 ... 264		
• Mains frequency	Hz	50 / 60		
• Power consumption at full load, typ.	W	103	139	270
<b>Output data</b>				
• Output voltage, rated value $U_a$	V DC	30		
• Residual ripple	mV <sub>SS</sub>	< 150		
• Output current, rated value at -20 °C ... +60 °C	A	3	4	8
• Max. output current at +60 °C ... +70 °C	A	3	3	4
<b>Degree of efficiency in rated conditions</b>				
• Degree of efficiency	%	87	88	90
• Power loss, typ.	W	12	17	25
<b>Protection and monitoring</b>				
• Output overvoltage protection	V	< 37		
• Current limit, typ.	A	4	5.5	11
<b>Safety</b>				
• Electrical separation primary / secondary		Output voltage PELV / SELV according to IEC 60950 and EN 50178		
• Safety class		I		
• Degree of protection		IP20		

Version		3 A	4 A	8 A
<b>Approvals</b>				
• UL		UL 508 / CSA 22.2		
• Pollution degree		IEC 60950		
• Overvoltage category and electrical separation		EN 50178 and IEC 61558		
<b>EMC</b>				
• Emitted interference (class B)		IEC 61000-6-3		
• Line harmonics limit		IEC 61000-3-2		
• Interference immunity		IEC 61000-6-2		
<b>Operating data</b>				
Ambient temperature				
• Operation	°C	-20 ... +70		
• Transport / storage	°C	-40 ... +85		
Pollution degree		2		
Humidity class		Climate class according to DIN 50010, relative air humidity max. 100 %, without condensation		
<b>Dimensions and weight</b>				
• Width	mm	50	50	70
• Height x depth	mm	125 x 126.5		
• Weight	kg	0.4	0.4	0.7

### Selection and ordering data

Version		Screw terminals	Article No.
 <p><b>PSN130S 30 V DC power supply units (without AS-i data decoupling)</b></p> <ul style="list-style-type: none"> <li>• Output voltage 30 V DC</li> <li>• Dimensions: Width: 50 mm (3 A / 4 A); 70 mm (8 A); Height: 125 mm; Depth: 126.5 mm</li> </ul>			
Output current	Input voltage		
3 A	120 / 230 V AC (automatic selection)		<b>3RX9511-0AA00</b>
4 A	120 / 230 V AC (automatic selection)		<b>3RX9512-0AA00</b>
8 A	120 / 230 V AC (automatic selection)		<b>3RX9513-0AA00</b>

### More information

Operating instructions and more technical information see <http://support.automation.siemens.com/WW/view/en/64364000>.

## AS-Interface

### Power supply units and data decoupling modules

#### S22.5 data decoupling modules

##### Overview



AS-Interface S22.5 double data decoupling module:  
Screw terminal version (picture left),  
Spring-type terminal version (picture right)

With the aid of the S22.5 data decoupling module, the AS-Interface network can also be supplied with 24 V DC or 30 V DC from a standard power supply unit and the transmission of data and power can be realized along one cable. The combination of data decoupling modules and standard power supply units is therefore a cost-efficient alternative to the service-proven AS-Interface power supply units. The quality of the data signals and the reliable operation of the AS-i network are not negatively affected as the result.

##### Features of the S22.5 data decoupling module

- Degree of protection IP20
- Narrow design: 22.5 mm wide
- Version with screw or spring-type terminals
- Versions for single and double data decoupling
- Supply of several AS-i networks with a single power supply unit
- Operation with 24 V DC or 30 V DC, grounded or non-grounded
- Adjustable current limiting up to 2 x 4 A
- Integrated ground-fault detection with fault storage
- Diagnostics LEDs and signaling contacts
- RESET by button or remote RESET

##### Ground-fault detection

The integrated ground-fault detection works with a grounded and non-grounded supply: The connection of negative pole and ground (upstream from the data decoupling module) customary with 24 V DC power supplies is permitted. A ground fault to the negative or positive pole on the AS-Interface network (downstream from the data decoupling module) is detected and stored as a fault and will be signaled using LEDs and a relay contact.

##### Benefits

- Compatible expansion of the AS-Interface system
- An existing standard power supply unit with 24 V DC or 30 V DC can be used for supplying AS-i networks
- The AS-Interface system can also be used in tightly budgeted applications because no AS-Interface power supply unit needs to be purchased
- Applications benefit in addition from the advantages of a modern bus system:
  - High level of standardization
  - Additional diagnostics and maintenance information
  - Faster commissioning
- Easy and cost-efficient design of single and multiple networks is possible

##### Application

The AS-Interface data decoupling module is designed for AS-Interface networks with 30 V supply or 24 V supply (AS-iPower24V).

Operation of an AS-i network with the data decoupling module and a 30 V standard power supply unit is technically equivalent to the use of an AS-Interface power supply unit and offers the service-proven features of AS-Interface for all applications.

AS-Interface Power24V uses a 24 V power supply unit in conjunction with a data decoupling module and is particularly suitable for

- Compact machines using AS-Interface input/output modules
- Applications in the control cabinet for AS-Interface integration of SIRIUS Innovations contactors and compact starters (3RT2 contactors through 3RA27 function modules or 3RA6 compact starters through 3RA69 AS-i add-on modules).

When using the double data decoupling module or other data decoupling modules, several AS-Interface networks can be operated with a single power supply unit. This results in an additional cost advantage.

##### Note:

The power supply units must comply with the PELV (Protective Extra Low Voltage) or SELV (Safety Extra Low Voltage) standards, have a residual ripple of  $< 250 \text{ mV}_{pp}$ , and in the event of a fault, must limit the output voltage to a maximum of 40 V. We recommend SITOP power supply units, see Catalog IC 10, Chapter 15 "Products for Specific Requirements"  $\Rightarrow$  "Stabilized Power Supplies" or PSN130S 30 V power supplies, see page 4/138.

##### Note on AS-i Power24V:

The length of an AS-i Power24V network is restricted to 50 m in order to limit the voltage drop along the cable.

AS-i masters, AS-i slaves and the sensors and actuators supplied through the AS-i cable must be designed for the reduced voltage. Sensors and actuators for the standard voltage range of 10 to 30 V can be supplied with sufficient voltage.

Please also continue to observe the requirements specified in the section "Extension of AS-i Power24V" for implementation of AS-i Power24V, see page 4/5.

For more information on AS-i Power24V, see "AS-Interface System Manual"

<http://support.automation.siemens.com/WW/view/en/26250840>.



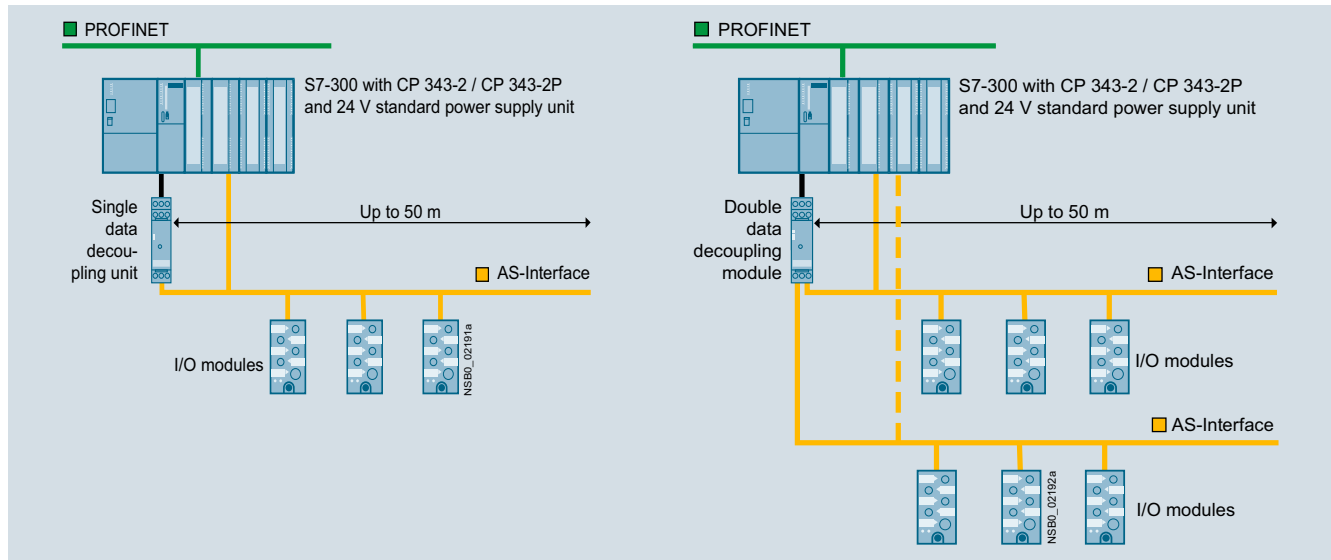

**Application**

**Construction of an AS-i Power24V network with an AS-Interface S22.5 data decoupling module**



Construction of an AS-i Power24V network with an AS-Interface S22.5 data decoupling module: Picture left: single network, picture right: multiple network

**Selection and ordering data**

Version	Article No.
 3RK1901-1DE12-1AA0 <b>S22.5 data decoupling modules</b> With screw terminals, removable terminals, width 22.5 mm, height 101 mm, depth 115 mm • Single data decoupling module, 1 x 4 A • Double data decoupling module, 2 x 4 A	<b>Screw terminals</b>  <b>3RK1901-1DE12-1AA0</b> <b>3RK1901-1DE22-1AA0</b>
	<b>Spring-type terminals</b>  <b>3RK1901-1DG12-1AA0</b> <b>3RK1901-1DG22-1AA0</b>
 3RK1901-1DG12-1AA0 <b>S22.5 data decoupling modules</b> With spring-type terminals, removable terminals, width 22.5 mm, height 105 mm, depth 115 mm • Single data decoupling module, 1 x 4 A • Double data decoupling module, 2 x 4 A	

**Circuit diagrams**

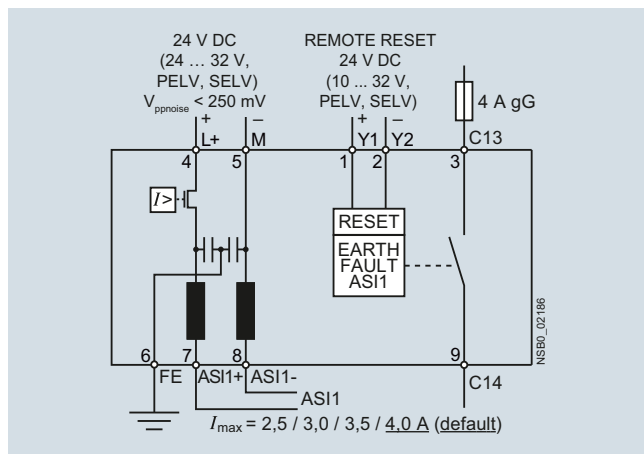

Single data decoupling module

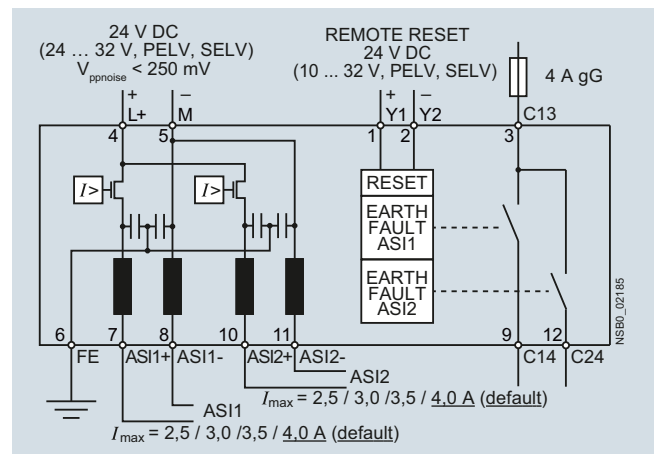

Double data decoupling module

## AS-Interface

Power supply units and data decoupling modules  
Data decoupling modules for S7-1200

### DCM 1271 data decoupling module

#### Overview



DCM 1271 data decoupling module for SIMATIC S7-1200

With the aid of the DCM 1271 data decoupling module, the AS-Interface network can also be supplied with 24 V DC or 30 V DC from a standard power supply unit and the transmission of data and power can be realized along one cable.

The DCM 1271 data decoupling module has the same enclosure design as the S7-1200 module and is therefore ideal for combining with the CM 1243-2 AS-i master.

#### Features of the DCM 1271 data decoupling module

- Design: S7-1200, 30 mm wide, degree of protection IP20
- Detachable terminals (scope of supply)
- Single data decoupling
- Supply of several AS-i networks with a single power supply unit
- Operation with 24 V DC or 30 V DC, grounded or non-grounded
- Current limiting at 4 A
- Integrated ground-fault detection
- Diagnostics LEDs for ground faults and overloads
- Signaling contacts for ground-fault detection

#### Ground-fault detection

The integrated ground-fault detection works with a grounded and non-grounded supply: The connection of negative pole and ground (upstream from the data decoupling module) customary with 24 V DC power supplies is permitted. A ground fault to the negative or positive pole on the AS-Interface network (behind the data decoupling module) is identified and signaled via LED and a transistor output.

#### Benefits

- An existing standard power supply unit with 24 V DC or 30 V DC can be used for supplying AS-i networks
- The AS-Interface system can also be used in tightly budgeted applications because no AS-Interface power supply unit needs to be purchased
- Applications benefit in addition from the advantages of a modern bus system:
  - High level of standardization
  - Additional diagnostics and maintenance information
  - Faster commissioning

#### Application

The AS-Interface data decoupling module is designed for AS-Interface networks with 30 V supply or 24 V supply (AS-Interface Power24V).

Operation of an AS-i network with the data decoupling module and a 30 V standard power supply unit is technically equivalent to the use of an AS-Interface power supply unit and offers the service-proven features of AS-Interface for all applications.

AS-Interface Power24V uses a 24 V power supply unit in conjunction with a data decoupling module and is particularly suitable for

- Compact machines using AS-Interface input/output modules
- Applications in the control cabinet for AS-Interface integration of SIRIUS Innovations contactors and compact starters (3RT2 contactors through 3RA27 function modules or 3RA6 compact starters through 3RA69 AS-i add-on modules)

#### Note:

The power supply units must comply with the PELV (Protective Extra Low Voltage) or SELV (Safety Extra Low Voltage) standards, have a residual ripple of  $< 250 \text{ mV}_{\text{pp}}$ , and in the event of a fault, must limit the output voltage to a maximum of 40 V. We recommend SITOP power supply units, see Catalog IC 10, Chapter 15 "Products for Specific Requirements"  $\Rightarrow$  "Stabilized Power Supplies" or PSN130S 30 V power supplies, see page 4/138.

#### Note on AS-i Power24V:

The length of an AS-i Power24V network is restricted to 50 m in order to limit the voltage drop along the cable.

AS-i masters, AS-i slaves and the sensors and actuators supplied through the AS-i cable must be designed for the reduced voltage. Sensors and actuators for the standard voltage range of 10 to 30 V can be supplied with sufficient voltage.

Please also continue to observe the requirements specified in the section "Extension of AS-i Power24V" for implementation of AS-i Power24V, see page 4/5.

#### Construction of an AS-i Power24V network with AS-Interface DCM 1271 data decoupling module

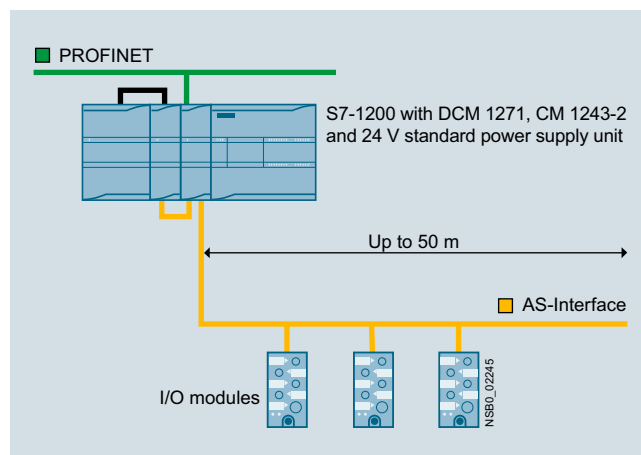

**Selection and ordering data**

Version	Article No.
 <p><b>DCM 1271 data decoupling modules</b></p> <ul style="list-style-type: none"> <li>• With screw terminals, removable terminals (included in the scope of supply)</li> <li>• Dimensions (W × H × D / mm): 30 × 100 × 75</li> </ul>	<b>3RK7271-1AA30-0AA0</b>

3RK7271-1AA30-0AA0

**Accessories**

Version	Screw terminals Article No.
<p><b>Screw terminals</b></p> <ul style="list-style-type: none"> <li>• 5-pole for AS-i master CM 1243-2 and AS-i DCM 1271 data decoupling module</li> <li>• 3-pole for AS-i DCM 1271 data decoupling module for connecting the power supply unit</li> </ul>	<p><b>3RK1901-3MA00</b></p> <p><b>3RK1901-3MB00</b></p>

4

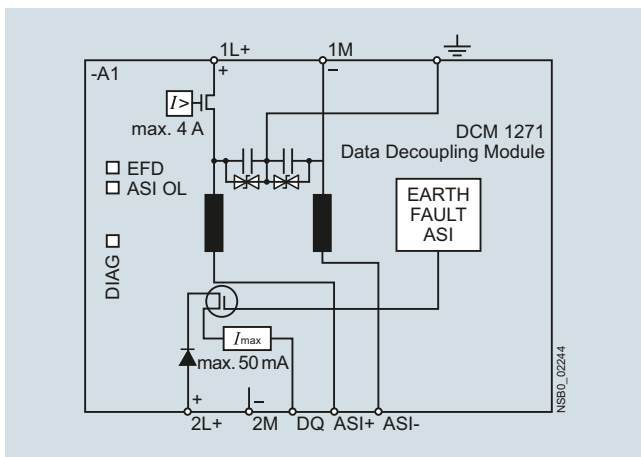
**Circuit diagrams**

DCM 1271 single data decoupling module

**More information**Manuals see <http://support.automation.siemens.com/WW/view/en//50414115/133300>.

For more information on AS-i Power24V, see

"AS-Interface System Manual" <http://support.automation.siemens.com/WW/view/en/26250840>.

## AS-Interface

Transmission media

### AS-Interface shaped cables

#### Overview

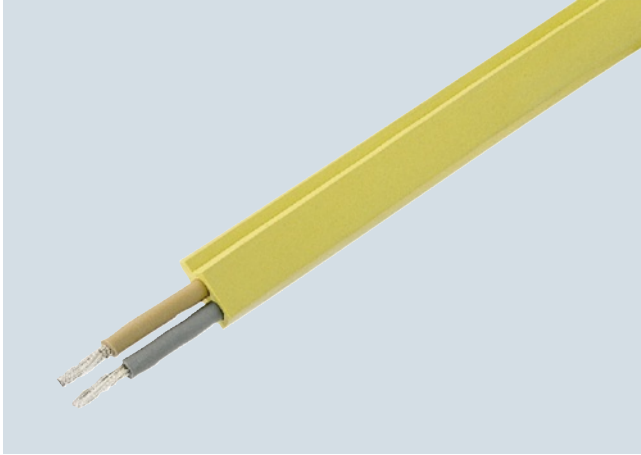

AS-Interface shaped cable

The actuator-sensor interface – the networking system used for the lowest field area – is characterized by very easy mounting and installation. A new connection method was developed specially for AS-Interface.

The stations are connected using the AS-Interface cable. This two-wire AS-Interface shaped cable has a trapezoidal shape, thus ruling out polarity reversal.

Connection is effected by the insulation piercing method. In other words, male contacts pierce the shaped AS-Interface cable and make reliable contact with the two wires. Cutting to length and stripping are superfluous. Consequently, AS-Interface stations (e.g. I/O modules, intelligent devices) can be connected in the shortest possible time and exchanging devices is quick.

To enable use in the most varied ambient conditions (e.g. in an oily environment), the AS-Interface cable is available in different materials (rubber, TPE, PUR).

For special applications it is also possible to use an unshielded standard round cable H05VV-F 2 x 1.5 mm<sup>2</sup> according to AS-i Specification. With AS-Interface, data and energy for the sensors (e.g. proximity switches) and actuators (e.g. indicator lights) are transmitted over the yellow AS-Interface cable.

The black AS-Interface cable must be used for actuators with a 24 V DC supply (e.g. solenoid valves) and a high power requirement.

#### Suitable for operation in tow chains

The use of the AS-Interface shaped cables with TPE and PUR outer sheath was checked in a tow chain test with the following conditions:

Chain length	m	6
Travel	m	10
Bending radius	mm	75
Travel speed	m/s	4
Acceleration	m/s <sup>2</sup>	4
Number of cycles		10 million
Duration of test		approx. 3 years (11 000 cycles per day)

After termination of the 10 million cycles, only slight wear was visible due to the lugs of the tow chain. No damage to the cores and core insulation could be detected.

#### Note:

When using a tow chain, the cables must be installed in such a way that they are not subject to tensile forces. On no account may the cables be twisted, but they must be routed flat through the tow chain.

#### Selection and ordering data

Version	Article No.			
<b>AS-Interface shaped cables</b>				
 3RX90...-0AA00	Rubber	Yellow (AS-Interface)	100-m roll	<b>3RX9010-0AA00</b>
		Yellow (AS-Interface)	1-km drum	<b>3RX9012-0AA00</b>
		Black (24 V DC)	100-m roll	<b>3RX9020-0AA00</b>
		Black (24 V DC)	1-km drum	<b>3RX9022-0AA00</b>
TPE	Yellow (AS-Interface)	100-m roll	<b>3RX9013-0AA00</b>	
	Yellow (AS-Interface)	1-km drum	<b>3RX9014-0AA00</b>	
	Black (24 V DC)	100-m roll	<b>3RX9023-0AA00</b>	
	Black (24 V DC)	1-km drum	<b>3RX9024-0AA00</b>	
TPE special version according to UL Class 2	Yellow (AS-Interface)	100-m roll	<b>3RX9017-0AA00</b>	
	Black (24 V DC)	100-m roll	<b>3RX9027-0AA00</b>	
PUR	Yellow (AS-Interface)	100-m roll	<b>3RX9015-0AA00</b>	
	Yellow (AS-Interface)	1-km drum	<b>3RX9016-0AA00</b>	
	Black (24 V DC)	100-m roll	<b>3RX9025-0AA00</b>	
	Black (24 V DC)	1-km drum	<b>3RX9026-0AA00</b>	

### Overview



AS-Interface repeater

The AS-Interface repeater is used to extend the AS-Interface cable.

- In its basic version, an AS-i network comprises one segment with a maximum cable length of 100 m. An extension plug (see next page) can be used to increase the cable length for a segment to a maximum of 200 m.
- If this is insufficient, however, you can use one or more repeaters.
- A repeater adds an extra segment to an existing segment. The extra segment can have a cable length of up to 100 m (without extension plug) or up to 200 m (with an extension plug in the extra segment).
- Each segment requires a separate AS-i power supply unit.
- Electrical separation of the two AS-Interface shaped cable lines
- Slaves can be used on both sides of the repeater.
- The additional power supply can increase the current infeed for slaves/sensors and lower the voltage drop on the AS-i cable.
- Separate display of the correct AS-Interface voltage for each segment.
- Installed in K45 module enclosure IP67 with mounting plate
- Easy mounting

#### Design of an AS-Interface network with repeaters

- Parallel switching of several repeaters possible (star configuration)
- Combination of series and parallel switching possible

The following conditions apply:

- When used without an extension plug no more than two repeaters are permitted between AS-i master and slave (repeaters connected in series).
- When used with an extension plug no more than one repeater is permitted between AS-i master and slave.

In safety-related applications the following also applies:

- When used without an extension plug, no more than two repeaters are permitted between evaluation unit (e.g. MSS ASIsafe Modular Safety System) and ASIsafe input slave or safe output module.
- When used with an extension plug, no more than one repeater is permitted between evaluation unit (e.g. MSS ASIsafe Modular Safety System) and ASIsafe input slave or safe output module.

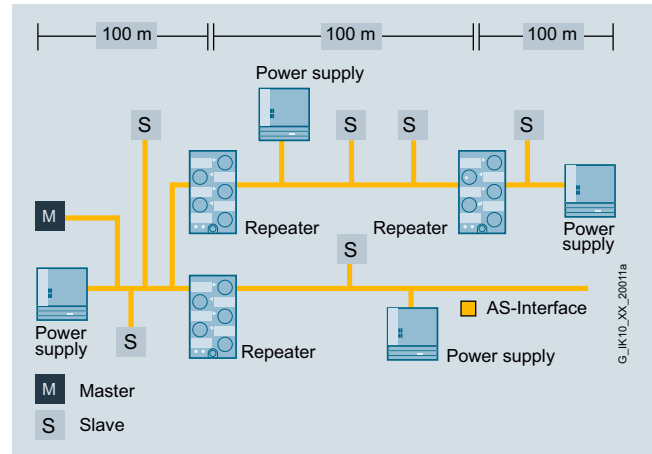

Design of an example AS-Interface network with repeaters (without extension plug)

#### Note:

The AS-Interface repeater is not suitable for AS-i Power24V networks. It is recommended for use in AS-Interface networks with AS-Interface power supply units (e.g. 3RX9501-0BA00).

### Benefits

- More possibilities of use and greater freedom for plant planning through extension of the AS-Interface network
- Reduced downtime and servicing times in the event of a fault thanks to separate display of the correct AS-Interface voltage for each side

### Application

The repeater is used to extend the AS-Interface network. In this case there are AS-Interface slaves and one AS-Interface power supply unit on each side of the repeater.

In the case of a line topology with two repeaters and three extension plugs, the AS-Interface network can be extended by 600 m overall, see example design with extension plug on the next page.

### Selection and ordering data

Version	Article No.
 <p><b>Repeaters for AS-Interface</b> For cable extension, scope of supply includes mounting plate (for wall and standard rail mounting)</p>	<b>6GK1210-0SA01</b>

6GK1 210-0SA01

## AS-Interface

### System Components and Accessories

#### Extension plug

#### Overview



AS-Interface extension plug:  
Picture left: extension plug compact, picture right: extension plug plus

With the extension plug, it is possible to double the cable length possible in an AS-Interface segment from 100 to 200 m.

Only one power supply unit is needed to supply power to the slaves on the up to 200 m long segment.

The following versions of the extension plug are available:

- Extension plug Compact: a passive component that can be connected directly to the AS-Interface shaped cable
- Extension plug plus: The Extension plug plus has an integrated A/B slave that enables any undervoltage supply to be signaled to the AS-Interface master. It has an M12 plug and can be connected to the AS-Interface M12 feeder with degree of protection IP67.

#### Design of an AS-Interface segment with an extension plug

With an AS-Interface segment with a cable length of more than 100 m and up to a maximum of 200 m, the extension plug is installed in a radius of approx.  $\pm 10$  m at that point of the network which is furthest from the power supply unit. The extension plug is not allowed to be used in AS-Interface networks smaller than 100 m. As with all AS-Interface networks, any network structure (line, tree, star) is possible when using the extension plug. Only one extension plug is required per 200 m segment, even with a tree or star structure.

#### Note:



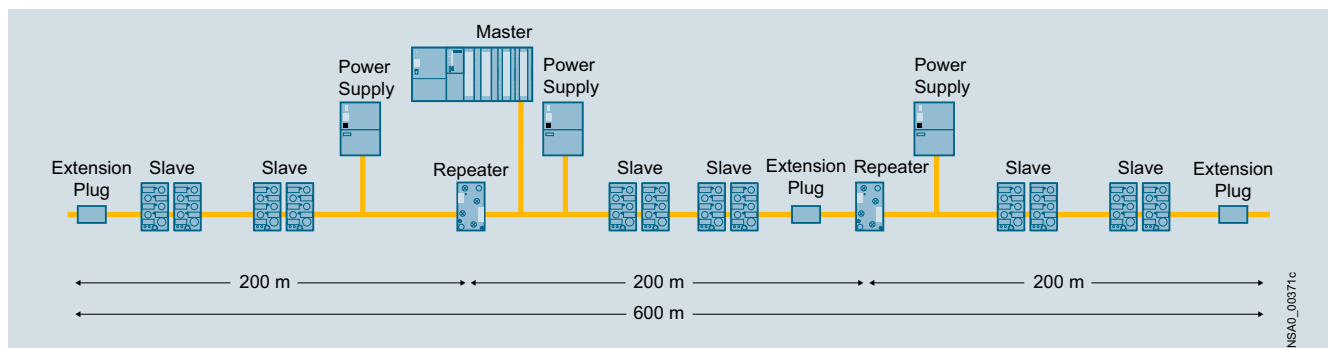

With the compact extension plug and the M12 feeder 3RK1901-1NR10 (4 A), the AS-Interface shaped cable has to be terminated using the cable terminating piece, see "miscellaneous accessories", page 4/152.

The AS-Interface extension plug is not suitable for AS-i Power24V networks.



Maximum network size with repeaters and extension plug (master at center of network)

#### Selection and ordering data

Version	Article No.
 3RK1901-1MX02 <b>AS-Interface extension plug compact</b> <ul style="list-style-type: none"> <li>• Doubling of the cable length to 200 m per AS-Interface segment</li> <li>• With direct connection to AS-Interface shaped cable</li> </ul>	3RK1901-1MX02
 3RK1901-1MX01 <b>AS-Interface extension plug plus</b> <ul style="list-style-type: none"> <li>• Doubling of the cable length to 200 m per AS-Interface segment</li> <li>• Mounting on AS-Interface M12 feeders (to be ordered separately)</li> <li>• Undervoltage monitoring signal through integrated AS-Interface slave to AS-Interface master</li> </ul>	3RK1901-1MX01
<b>Accessories</b>  3RX9801-0AA00 <b>AS-Interface M12 feeders</b> <ul style="list-style-type: none"> <li>• Transition of shaped AS-Interface cable to a standard round cable</li> <li>• Current carrying capacity up to 2 A</li> <li>• Degree of protection IP67</li> </ul>	3RX9801-0AA00
 3RK1901-1NR10 <b>AS-Interface M12 feeders</b> <ul style="list-style-type: none"> <li>• Transition of AS-Interface cable without <math>U_{aux}</math> with M12 socket</li> <li>• Max. 4 A</li> <li>• Degree of protection IP67/IP68/IP69K</li> </ul>	3RK1901-1NR10



### Overview



The innovated addressing unit for AS-Interface of the AS-i Specification V3.0

The addressing unit is used to assign an address during commissioning to each AS-Interface slave. The device detects a connected slave module or a complete AS-i network and displays the found module in the LCD display. Via the Up/Down keys each address can be individually set. By turning the rotary switch, further commissioning functions are selected intuitively. The innovative device has been adapted to the current AS-i Specification V3.0 and can now also handle the I/O data of the latest slaves.

#### Functionality

- Reading out and adjusting the slave address 0 to 31 or 1A to 31A, 1B to 31B, with automatic addressing aid and prevention of double addresses
- Reading out the slave profile (IO, ID, ID2)
- Reading out and adjusting the ID1 code
- Input/output test when commissioning the slaves:  
Read input signals and write outputs with all digital and analog slaves according to AS-Interface Specification V3.0, including safe input slaves and complex CTT2 slaves
- Measuring the voltage on the AS-Interface cable (measuring range from 2 to 35 V)
- Display of the operational current in case of direct connection of an AS-i slave (measuring range from 0 to 150 mA)
- Storage of complete network configurations (profiles of all slaves) to simplify the addressing
- Adjusting the slave parameters for commissioning
- Reading out the identification and diagnostics of CTT2 slaves
- Reading out the code table of safe input slaves (ASIsafe)

#### Note:

For operation of the addressing unit on an AS-Interface cable with connected power supply unit, the following applies:  
The AS-Interface addressing unit is suitable for standard AS-i networks and AS-i Power24V networks (operational voltage on the AS-Interface cable min. 19 V).

### Benefits

- Increased power supply to the slaves to 150 mA
- Better utilization of the battery capacity thanks to improved circuitry
- Support for the current AS-i Specification V3.0
- Expanded display for simultaneously displaying input and output states
- Clearly recognizable display of status of digital inputs/outputs in binary format (0 / 1), optionally also available as hexadecimal values
- Intuitive display of analog data either as decimal, hexadecimal or as a percentage (e.g. 100 % corresponds to input/output value 20 mA)
- I/O data of complex slaves (CTT2 profile) can be displayed
- Decoded display of the input data of safe input slaves, including code table
- Simplification of the operating steps when setting the slave address with automatic read back of the set address
- Addressing cable, ready for operation even without screwing in tight into the M12 socket, thus faster availability of the addressing unit
- Proven compact housing with smooth keys and rotary switch
- Connection of standard AS-i networks possible with 30 V as well as Power24V networks
- Complex slaves with high operating current can be addressed without external supply
- Longer operating time per battery pack
- Can be used with all types of digital and analog slaves
- Comprehensive and fast input/output test of plants, even for A/B modules with 4 DI / 4 DO and current analog modules with an A/B address
- Faster and more reliable commissioning of the AS-Interface modules
- One-hand operation possible, with unique selection of the functions
- Universal applicability for all AS-i networks

## AS-Interface







### System Components and Accessories

#### Addressing units

#### Technical specifications

3RK1904-2AB02 AS-Interface addressing unit			
<b>Parameters</b>			
Measuring range		V	2 ... 35
• Voltage		A	0 ... 0.150
• Current (for slaves)			
Measuring accuracy in % of the measured value		%	± 3.5 + 2 digits
• Voltage		%	± 5 + 2 digits
• Current (for slaves)			
Input resistance for voltage measurement		kΩ	300
<b>Power supply</b>			
Standard power supply			4 batteries 1.5 V type AA, IEC LR6 (NEDA15) or corresponding batteries (preferably NiMH)
Recommendation for current-intensive application			4 high-grade alkaline manganese batteries 1.5 V type AA
Automatic disconnection for a longer battery life			Approx. 5 minutes (or approx. 1 minute when data exchange is active) after last operation
<b>Ambient conditions</b>			
Ambient temperature		°C	0 ... +50
Storage temperature		°C	-20 ... +75 without batteries
Relative air humidity, max.		%	75, condensation not permitted
Altitude above sea level, max.		m	2000
Location			Only indoors
<b>Mechanical design</b>			
Degree of protection			IP40
Dimensions, W x H x D		mm	84 x 195 x 35
Connection			M12 socket: Pin 1: ASI+; Pin 3: ASI-; Pin 2, 4, 5: Not used
Weight with batteries		kg	0.450

#### Selection and ordering data

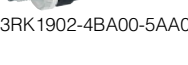
Version	Article No.
 <p><b>AS-Interface addressing unit V 3.0</b></p> <ul style="list-style-type: none"> <li>For AS-Interface modules and sensors and actuators with integrated AS-Interface in accordance with AS-i Specification V3.0</li> <li>For setting the AS-i address of standard slaves, and slaves with extended addressing mode (A/B slaves)</li> <li>With input/output test function and many other commissioning functions</li> <li>Battery operation with 4 batteries type AA (IEC LR6, NEDA 15)</li> <li>Scope of supply:           <ul style="list-style-type: none"> <li>- Addressing unit with 4 batteries</li> <li>- Addressing cable, with M12 plug to addressing plug (hollow plug), length 1.5 m</li> </ul> </li> </ul>	<b>3RK1904-2AB02</b>
<p><b>Accessories</b></p>  <p><b>Addressing cable, with M12 plug to M12 socket<sup>2)</sup></b></p> <ul style="list-style-type: none"> <li>For addressing slaves with M12 connection, e.g. K20 or K60R modules or light curtains</li> <li>Length 1.5 m, 3-pole, 3 x 0.34 mm<sup>2</sup></li> </ul>	<b>3RK1902-4PB15-3AA0</b>
 <p><b>AS-Interface M12 feeders</b></p> <ul style="list-style-type: none"> <li>Transition of AS-Interface cable to a standard round cable</li> <li>Insulation piercing method for connection of AS-Interface cable</li> <li>M12 socket for connection of standard round cable</li> <li>Current carrying capacity up to 2 A</li> </ul>	<b>3RX9801-0AA00</b>
 <p><b>AS-Interface M12 feeders</b></p> <ul style="list-style-type: none"> <li>Transition of AS-Interface cable without <math>U_{aux}</math>, with M12 socket</li> <li>Insulation piercing method for connection of AS-Interface cable</li> <li>M12 socket for connection of standard round cable</li> </ul>	<b>3RK1901-1NR10</b>
 <p><b>M12 cable plug<sup>3)</sup></b></p> <ul style="list-style-type: none"> <li>Extruded M12 plug (angled cable feeder 90°), other cable end open</li> <li>Length: 5 m, 5-pole, color: Black</li> </ul>	<b>3RK1902-4HB50-5AA0</b>
 <p><b>M12 plug straight<sup>3)</sup></b></p> <ul style="list-style-type: none"> <li>For screw fixing, 5-pole screw terminal, max. 0.75 mm<sup>2</sup></li> <li>A-coded, max. 4 A</li> </ul>	<b>3RK1902-4BA00-5AA0</b>
 <p><b>Addressing cable, with M12 plug to addressing plug (hollow plug)<sup>1)</sup></b></p> <ul style="list-style-type: none"> <li>Included in the scope of supply of the addressing unit</li> <li>Length 1.5 m</li> </ul>	<b>Z236A</b>

<sup>1)</sup> Can be ordered only via GMC-I Messtechnik GmbH, see Catalog IC 10, Chapter 16 "Appendix ⇒ "External Partners"

<sup>2)</sup> Not included in scope of supply of the 3RK1904-2AB02 addressing unit.

<sup>3)</sup> For connecting the addressing unit to an AS-i network via AS-Interface M12 feeder, a connecting cable (M12 plug to M12 connector) must be produced and requires the following wiring:  
 - M12 cable plug: Pin 1 / core brown ↔ M12 plug: Pin 1  
 - M12 cable plug: Pin 3 / core blue ↔ M12 plug: Pin 3  
 - Pin 2, 4, 5 not connected.

### Overview



AS-Interface analyzer

The AS-Interface analyzer is used to test AS-Interface networks. Installation errors, e. g. loose contacts or EMC interference under extreme loads, can be revealed by this device.

Thanks to the easy-to-use software the user can assess the quality of complete networks even if he lacks detailed specialist knowledge of AS-Interface. In addition it is an easy matter with the AS-Interface analyzer to create test logs from the records produced, thus providing documentation for startups and service assignments.

For advanced AS-Interface users there are trigger functions for detailed diagnostics.

### Connection

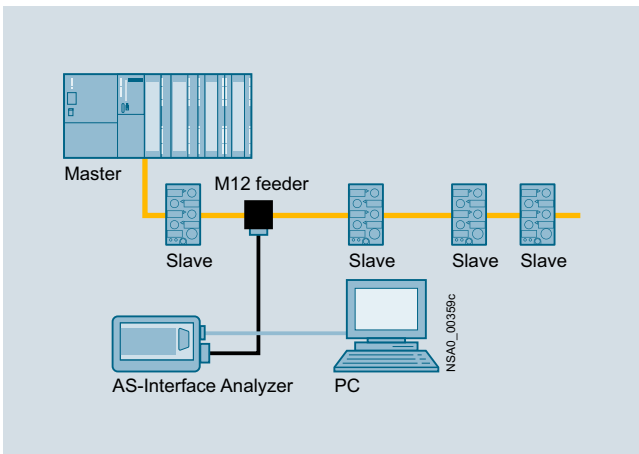

Connection of AS-Interface analyzer to PC and AS-Interface network

The AS-Interface analyzer follows the communication on the AS-Interface network as a passive station. The unit is supplied simultaneously from the AS-Interface cable.

This analyzer interprets the physical signals on the AS-Interface network and records the communication.

The data thus obtained are transferred through an RS 232 interface to a PC such as a notebook, for evaluation with the supplied diagnostics software.

### Benefits

- Simple and user-friendly operation enables diagnostics of AS-Interface networks without help from specialists
- Speedy troubleshooting thanks to intuitive display in statistics mode
- Test logs provide verification of the state and quality of the installation for service and approval
- Recorded logs facilitate remote diagnostics by technical assistance
- Comprehensive trigger functions enable exact analysis
- Process data can be monitored online

### Application

#### Online statistics

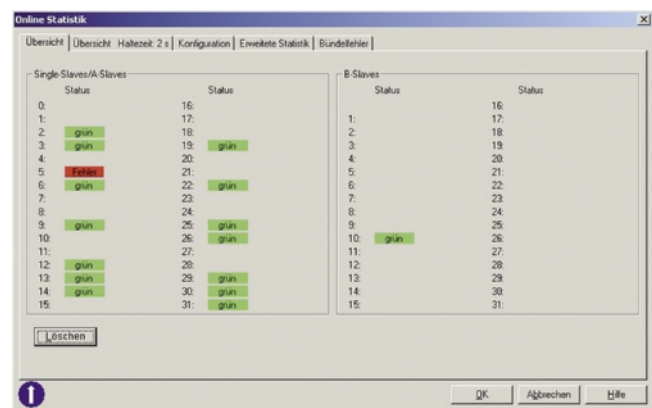

Online statistics, overview

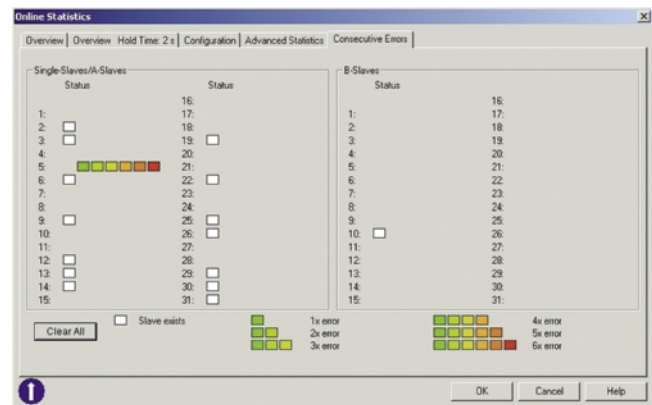

Online statistics, details, e.g. here a fault on slave 5

This mode provides a quick overview of the existing AS-Interface system. The error rates are displayed per slave in a traffic-light function (green, yellow, red).

The bus configuration and the currently transmitted data of the slaves are shown in a well arranged presentation.

With the expanded statistics function, it is possible to determine the error rates as the number of transmitted or faulty bus message frames.

The bundle error overview shows in steps how many multiple repetitions of message frames occurred in order to enable a selective and look-ahead assessment of the transmission quality.

# AS-Interface

## System Components and Accessories

### Analyzer

#### Data mode

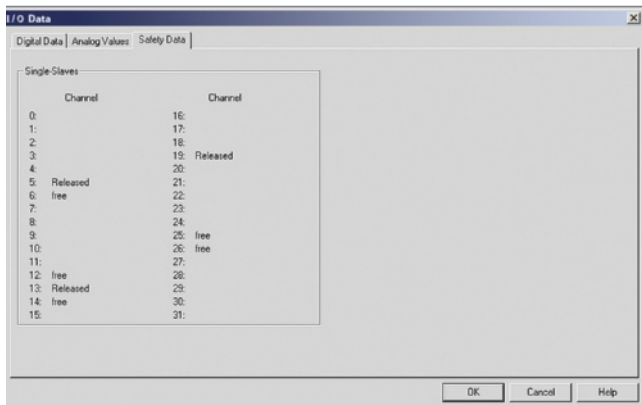

Presentation of the I/O data: Safety data

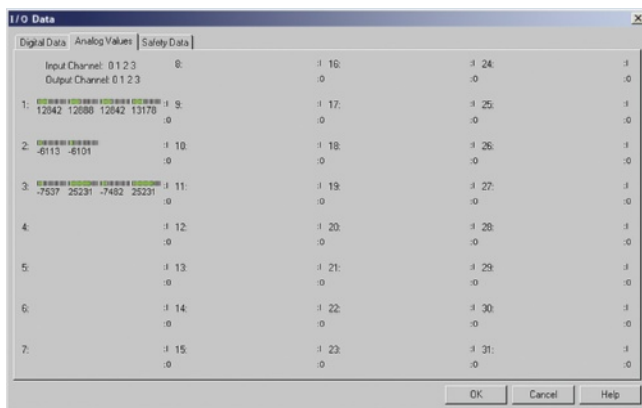

Presentation of the I/O data: Analog values

In this mode, the analyzer shows not only the digital input/output values but also the current analog values and the input status of the safety slaves.

#### Trace mode

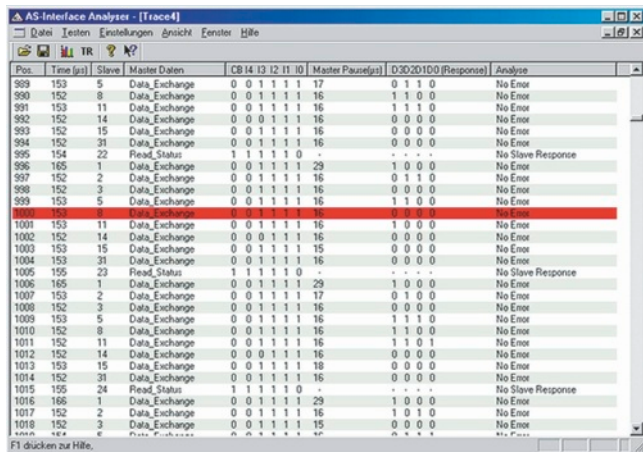

Presentation of message frames in trace mode

The presentation of message frames in the style of a classic fieldbus analyzer is indispensable for complex troubleshooting. Extensive trigger functions and recording and viewing filters are available for this purpose.

An external trigger input and trigger output round off the scope of functions in order to find even the most difficult errors.

For troubleshooting in connection with ASIsafe applications, changes of status in the code tables of safety slaves are identified and assessed.

#### Test log

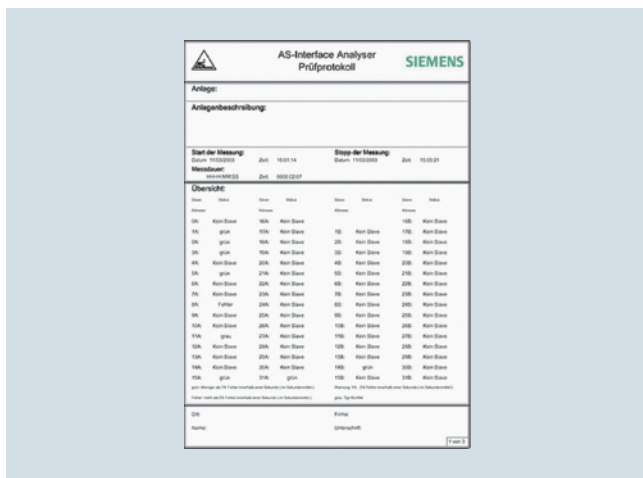

Example of a test log





The recorded data of the online statistics are easy to output and document using a test log. Verification of the state of the plant can thus be provided for approvals or service assignments.

The integrated measurement assistant records the bus signals for a variable duration, thereby triggering creation of an automatic test log. A standardized quality test of AS-i plants is thus possible.

#### Note:

The AS-Interface analyzer is suitable for standard AS-i networks and AS-i Power24V networks (operational voltage min. 20 V).

### Selection and ordering data









Version		Article No.
 <p>3RK1904-3AB01</p>	<p><b>AS-Interface analyzers</b></p> <ul style="list-style-type: none"> <li>• For testing AS-Interface actuator/sensor interface systems</li> <li>• For troubleshooting and service assignments in installations and networks with AS-Interface systems</li> <li>• Dimensions (W x H x D): 145 x 30 x 92 mm</li> <li>• Scope of supply:               <ul style="list-style-type: none"> <li>• AS-Interface analyzers</li> <li>• RS 232 cable for connecting to PC</li> <li>• USB-to-serial/RS 232 adapter</li> <li>• Screwdriver                   <ul style="list-style-type: none"> <li>- Magnetic adhesive tape for fastening the analyzer to metal surfaces</li> <li>- Service case with foam insert, dimensions (W x H x D / mm): approx. 260 x 70 x 200</li> <li>- Diagnostics software (CD-ROM) for PC (Windows 95/98, ME, 2000, NT, XP, Vista Home Basic, Home Premium, Business, Ultimate, Windows 7)</li> </ul> </li> </ul> </li> </ul>	<p><b>3RK1904-3AB01</b></p>
<p><i>Accessories</i></p>		
 <p>3RX9801-0AA00</p>	<p><b>AS-Interface M12 feeders</b></p> <ul style="list-style-type: none"> <li>• Transition of shaped AS-Interface cable to a standard round cable</li> <li>• Insulation piercing method for connection of AS-Interface cable</li> <li>• M12 socket for connection of standard round cable</li> <li>• Current carrying capacity up to 2 A</li> <li>• Degree of protection IP67</li> </ul>	<p><b>3RX9801-0AA00</b></p>
 <p>3RK1901-1NR10</p>	<p><b>AS-Interface M12 feeders</b></p> <ul style="list-style-type: none"> <li>• Transition of AS-Interface cable without <math>U_{aux}</math>, with M12 socket</li> <li>• Insulation piercing method for connection of AS-Interface cable</li> <li>• M12 socket for connection of standard round cable</li> <li>• Max. 4 A</li> <li>• Degree of protection IP67/IP68/IP69K</li> </ul>	<p><b>3RK1901-1NR10</b></p>
 <p>3RK1902-4HB50-5AA0</p>	<p><b>M12 cable plugs</b></p> <ul style="list-style-type: none"> <li>• Cable: PUR, 5-pole</li> <li>• Length: 5 m</li> <li>• Color: Black</li> <li>• Extruded M12 plug (angled cable feeder 90°), other cable end open</li> </ul>	<p><b>3RK1902-4HB50-5AA0</b></p>

## AS-Interface





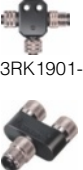



### System Components and Accessories

#### Miscellaneous accessories

#### Selection and ordering data

Version	Article No.																																			
 <p><b>AS-Interface system manual</b> Free download of technical information and overview of the AS-Interface product range from Siemens, scope: approx. 600 pages</p> <ul style="list-style-type: none"> <li>For German version, see <a href="http://support.automation.siemens.com/WW/view/de/26250840">http://support.automation.siemens.com/WW/view/de/26250840</a></li> <li>For English version, see <a href="http://support.automation.siemens.com/WW/view/en/26250840">http://support.automation.siemens.com/WW/view/en/26250840</a></li> </ul>																																				
 <p>3RK2703-3AB02-1AA1</p> <p><b>AS-Interface compact distributors, for AS-Interface flat cable</b></p> <ul style="list-style-type: none"> <li>Current carrying capacity up to 8 A</li> <li>Degree of protection IP67/IP68/IP69K</li> </ul>	<b>3RK1901-1NN10</b>																																			
 <p>3RK1901-1NN10</p> <p><b>AS-Interface M12 feeders</b></p> <ul style="list-style-type: none"> <li>Degree of protection IP67</li> <li>Current carrying capacity up to 2 A</li> </ul> <table border="1"> <thead> <tr> <th>For flat cable</th> <th>For</th> <th>Cable length</th> <th>Cable end in feeder</th> <th></th> </tr> </thead> <tbody> <tr> <td>AS-i</td> <td>M12 socket</td> <td>--</td> <td>Available</td> <td><b>3RX9801-0AA00</b></td> </tr> </tbody> </table>	For flat cable	For	Cable length	Cable end in feeder		AS-i	M12 socket	--	Available	<b>3RX9801-0AA00</b>																										
For flat cable	For	Cable length	Cable end in feeder																																	
AS-i	M12 socket	--	Available	<b>3RX9801-0AA00</b>																																
 <p>3RK1901-1NR10</p> <p><b>AS-Interface M12 feeders</b></p> <ul style="list-style-type: none"> <li>Degree of protection IP67/IP68/IP69K</li> <li>Current carrying capacity up to 4 A</li> </ul> <table border="1"> <thead> <tr> <th>For flat cable</th> <th>For</th> <th>Cable length</th> <th>Cable end in feeder</th> <th></th> </tr> </thead> <tbody> <tr> <td>AS-i</td> <td>M12 socket</td> <td>--</td> <td>Not available</td> <td><b>3RK1901-1NR10</b></td> </tr> <tr> <td>AS-i</td> <td>M12 cable box</td> <td>1 m</td> <td>Not available</td> <td><b>3RK1901-1NR11</b></td> </tr> <tr> <td>AS-i</td> <td>M12 cable box</td> <td>2 m</td> <td>Not available</td> <td><b>3RK1901-1NR12</b></td> </tr> <tr> <td>AS-i/U<sub>aux</sub></td> <td>M12 socket</td> <td>--</td> <td>Not available</td> <td><b>3RK1901-1NR20</b></td> </tr> <tr> <td>AS-i/U<sub>aux</sub></td> <td>M12 cable box</td> <td>1 m</td> <td>Not available</td> <td><b>3RK1901-1NR21</b></td> </tr> <tr> <td>AS-i/U<sub>aux</sub></td> <td>M12 cable box</td> <td>2 m</td> <td>Not available</td> <td><b>3RK1901-1NR22</b></td> </tr> </tbody> </table>	For flat cable	For	Cable length	Cable end in feeder		AS-i	M12 socket	--	Not available	<b>3RK1901-1NR10</b>	AS-i	M12 cable box	1 m	Not available	<b>3RK1901-1NR11</b>	AS-i	M12 cable box	2 m	Not available	<b>3RK1901-1NR12</b>	AS-i/U <sub>aux</sub>	M12 socket	--	Not available	<b>3RK1901-1NR20</b>	AS-i/U <sub>aux</sub>	M12 cable box	1 m	Not available	<b>3RK1901-1NR21</b>	AS-i/U <sub>aux</sub>	M12 cable box	2 m	Not available	<b>3RK1901-1NR22</b>	
For flat cable	For	Cable length	Cable end in feeder																																	
AS-i	M12 socket	--	Not available	<b>3RK1901-1NR10</b>																																
AS-i	M12 cable box	1 m	Not available	<b>3RK1901-1NR11</b>																																
AS-i	M12 cable box	2 m	Not available	<b>3RK1901-1NR12</b>																																
AS-i/U <sub>aux</sub>	M12 socket	--	Not available	<b>3RK1901-1NR20</b>																																
AS-i/U <sub>aux</sub>	M12 cable box	1 m	Not available	<b>3RK1901-1NR21</b>																																
AS-i/U <sub>aux</sub>	M12 cable box	2 m	Not available	<b>3RK1901-1NR22</b>																																
 <p>3RK1901-1NR11</p> <p><b>AS-Interface M12 feeders, 4-fold</b></p> <ul style="list-style-type: none"> <li>Degree of protection IP67</li> <li>Current carrying capacity up to 4 A</li> </ul> <table border="1"> <thead> <tr> <th>For flat cable</th> <th>For</th> <th>Cable length</th> <th>Cable end in feeder</th> <th></th> </tr> </thead> <tbody> <tr> <td>AS-i/U<sub>aux</sub></td> <td>4-fold M12 socket, delivery includes mounting plate (for wall and standard rail mounting)</td> <td>--</td> <td>Not available</td> <td><b>3RK1901-1NR04</b></td> </tr> </tbody> </table>	For flat cable	For	Cable length	Cable end in feeder		AS-i/U <sub>aux</sub>	4-fold M12 socket, delivery includes mounting plate (for wall and standard rail mounting)	--	Not available	<b>3RK1901-1NR04</b>																										
For flat cable	For	Cable length	Cable end in feeder																																	
AS-i/U <sub>aux</sub>	4-fold M12 socket, delivery includes mounting plate (for wall and standard rail mounting)	--	Not available	<b>3RK1901-1NR04</b>																																
 <p>3RK1901-1NR04</p> <p><b>M12 T distributors</b></p> <ul style="list-style-type: none"> <li>IP68</li> <li>1 x M12 plug</li> <li>2 x M12 box</li> </ul>	<b>3RK1901-1TR00</b>																																			
 <p>3RK1901-1TR00</p> <p><b>M12 Y-shaped coupler plugs</b></p> <p>For connection of two sensors to one M12 socket with Y assignment</p>	<b>6ES7194-1KA01-0XA0</b>																																			
 <p>6ES7194-1KA01-0XA0</p>																																				

## Selection and ordering data (continued)

Version	Article No.
 3RK1901-1KA00	<b>AS-Interface M12 sealing caps</b> For free M12 sockets <b>3RK1901-1KA00</b>
 3RK1901-1KA01	<b>AS-Interface M12 sealing caps, tamper-proof</b> For free M12 sockets <b>3RK1901-1KA01</b>
 3RK1901-1PN00	<b>AS-Interface M8 sealing caps</b> For free M8 sockets <b>3RK1901-1PN00</b>
 3RK1901-1MD00	<b>AS-Interface M20 seals</b> <ul style="list-style-type: none"> <li>• For AS-Interface cable, shaped</li> <li>• For insertion in M20 glands</li> </ul> <b>3RK1901-1MD00</b>
 3RK1901-3QM00	<b>Cable adapters for flat cables</b> Connection of AS-Interface cable to metric gland with insulation piercing method <ul style="list-style-type: none"> <li>• Continuation using standard cable               <ul style="list-style-type: none"> <li>- For M16 gland</li> <li>- For M20 gland</li> </ul> </li> <li>• Continuation using pins               <ul style="list-style-type: none"> <li>- For M16 gland</li> <li>- For M20 gland</li> </ul> </li> </ul> <b>3RK1901-3QM00</b> <b>3RK1901-3QM10</b> <b>3RK1901-3QM01</b> <b>3RK1901-3QM11</b>
 3RK1901-3QA00	<b>Cable clips for cable adapters</b> <b>3RK1901-3QA00</b>
 3RK1901-1MN00	<b>Cable terminating pieces</b> For sealing of open cable ends (shaped AS-Interface cable) in IP67 <b>3RK1901-1MN00</b>
 3RK1901-2EA00	<b>K45 mounting plates</b> <ul style="list-style-type: none"> <li>• For wall mounting</li> <li>• For standard rail mounting</li> </ul> <b>3RK1901-2EA00</b> <b>3RK1901-2DA00</b>
 3RK1901-0CA00	<b>K60 mounting plates</b> Suitable for all K60 compact modules <ul style="list-style-type: none"> <li>• For wall mounting</li> <li>• For standard rail mounting</li> </ul> <b>3RK1901-0CA00</b> <b>3RK1901-0CB01</b>

## AS-Interface

### System Components and Accessories

#### Miscellaneous accessories

#### Selection and ordering data (continued)

	Version	Article No.
 3RK1902-0AR00	<b>Sealing sets</b> <ul style="list-style-type: none"> <li>For K60 mounting plate and standard distributor</li> <li>Cannot be used for K45 mounting plate</li> <li>One set contains one straight and one shaped seal.</li> </ul>	<b>3RK1902-0AR00</b>
	<b>Labels</b> <ul style="list-style-type: none"> <li>For K45 and K60 compact modules</li> <li>20 x 9 mm, pastel turquoise</li> <li>19 frames with 20 labels each</li> </ul>	<b>3RT1900-1SB50</b>
 3RK1902-4GB50-4AA0	<b>Control cables, assembled at one end</b> Angular M12 socket for screw fixing, 4-pole, 4 x 0.34 mm <sup>2</sup> , A-coded, black PUR sheath, max. 4 A <ul style="list-style-type: none"> <li>Cable length 5 m</li> </ul>	<b>3RK1902-4GB50-4AA0</b>
 3RK1902-4CA00-4AA0	<b>Angular M12 socket</b> for screw fixing, 4-pole screw terminals, max. 0.75 mm <sup>2</sup> , A-coded, max. 4 A	<b>3RK1902-4CA00-4AA0</b>
 3RK1902-4BA00-5AA0	<b>M12 plugs, straight</b> For screw fixing, 5-pole screw terminals, max. 0.75 mm <sup>2</sup> , A-coded, max. 4 A	<b>3RK1902-4BA00-5AA0</b>
 3RK1902-4DA00-5AA0	<b>M12 plugs, angled</b> For screw fixing, 5-pole screw terminals, max. 0.75 mm <sup>2</sup> , A-coded, max. 4 A	<b>3RK1902-4DA00-5AA0</b>
 3RK1902-4H...-5AA0	<b>Control cables, assembled at one end</b> M12 plugs, angled, for screw fixing, 5-pole, 5 x 0.34 mm <sup>2</sup> , A-coded, black PUR sheath, max. 4 A <ul style="list-style-type: none"> <li>Cable length 1.5 m</li> <li>Cable length 5 m</li> <li>Cable length 10 m</li> </ul>	<b>3RK1902-4HB15-5AA0</b> <b>3RK1902-4HB50-5AA0</b> <b>3RK1902-4HC01-5AA0</b>
 3RK1902-4PB15-3AA0	<b>Control cable, assembled at both ends</b> Straight M12 plug, straight M12 socket, for screw fixing, 3-pole, 3 x 0.34 mm <sup>2</sup> , A-coded, black PUR sheath, max. 4 A <ul style="list-style-type: none"> <li>Cable length 1.5 m</li> <li>Also for addressing AS-i slaves with M12 bus connection (e.g. K20, K60R compact modules, M200D motor starters)</li> </ul>	<b>3RK1902-4PB15-3AA0</b>



## Overview

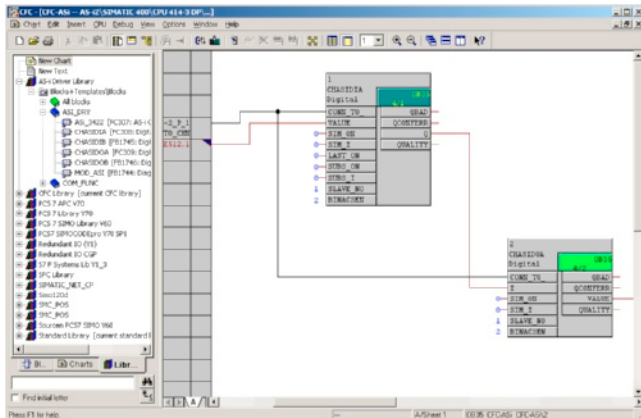

AS-Interface function block library for SIMATIC PCS 7: User interface

The AS-Interface block library for PCS 7 is integrated in the SIMATIC PCS 7 process control system and expands it for integration of the AS-Interface system.

As the result, the advantages of AS-Interface such as the considerable reduction of wiring outlay for distributed actuators/sensors and very simple installation can also be used in a system based on PCS 7.

The library contains modules for accessing the I/O data of AS-i slaves, modules for diagnostics of the AS-i system, and a faceplate for the PCS 7 Maintenance Station.

### Supported AS-Interface modules

The AS-Interface block library for PCS 7 can be used with the following AS-i master and link modules:

- CP 343-2 (in ET 200M station) 6GK7343-2AH01-0XA0
- CP 343-2P (in ET 200M station) 6GK7343-2AH11-0XA0
- DP/AS-i LINK Advanced single master 6GK1415-2BA10
- DP/AS-i LINK Advanced double master 6GK1415-2BA20
- IE/AS-i LINK PN IO single master 6GK1411-2AB10 (only for block library for PCS 7 V8 with APL)
- IE/AS-i LINK PN IO double master 6GK1411-2AB20 (only for block library for PCS 7 V8 with APL)

The AS-i CP 343-2 and CP 343-2P masters are supported within an ET 200M station connected through PROFIBUS.

For direct connection to PROFIBUS it is possible to use DP/AS-i LINK Advanced as an AS-i single master and double master.

Digital AS-i standard slaves and A/B slaves (according to AS-Interface Specification V 3.0) can be used on the CP 343-2 and CP 343-2P.

In combination with the IE/AS-i LINK PN IO (for PCS 7 V8 with APL) and the DP/AS-i LINK Advanced, it is also possible to integrate analog AS-i slaves.

### Hardware and software requirements

The libraries require the following PCS 7 versions:

- Engineering software V8: PCS 7 version V8.0 SP1 and higher
- Engineering software migration V7-V8: PCS 7 version V8.0 and higher
- Engineering software V7: PCS 7 version V6.1, V7.0 or V7.1

The engineering software migration V7-V8 comprises the same interconnection logic of the CFC blocks as the engineering software V7 and is recommended for the switch to PCS 7 V8 with only a few adjustments required in the CFC editor.

The engineering software V8 uses APL interconnection logic and is recommended for new PCS 7 projects.

### Types of delivery and license

The block library supplied on CD-ROM allows the user to run the required engineering software on the engineering station (single license) including the runtime software for executing the AS modules in an automation system (single license).

If the AS modules are to be used in additional automation systems, the corresponding number of runtime licenses are required which are supplied without a data carrier.

No additional licenses are required in order to use the faceplates on further operator stations.

### Benefits

- Easy connection of AS-Interface to PCS 7
- Engineering work reduced to positioning and connecting the blocks in the CFC
- With no additional configuring steps required for connection to the PCS 7 Maintenance Station, diagnostics for the AS-i system is optimally guaranteed.



### Application

The AS-Interface block library for PCS 7 is used in systems based on PCS 7 where the actuators and sensors are to be connected using AS-Interface.

## AS-Interface Software

### AS-Interface block library for SIMATIC PCS 7

#### Selection and ordering data

	Version	Article No.	
<b>AS-Interface block library for SIMATIC PCS 7 version V8 with Advanced Process Library (APL)</b>			
 <p data-bbox="130 593 316 617">3ZS1635-1XX02-0YA0</p>	<p data-bbox="354 387 582 410"><b>Engineering software V8</b></p> <p data-bbox="354 412 1045 474">For one engineering station (single license) including runtime software for execution of the AS blocks in an automation system (single license), German/English</p> <p data-bbox="354 476 933 561">Scope of supply: AS blocks and faceplates for integrating AS-Interface into the PCS 7 process control system with Advanced Process Library (APL), for PCS 7 version V8.0, SP1, and higher</p> <p data-bbox="354 563 694 649">Type of delivery: Software and documentation on CD, one license for one engineering station, one license for one automation system</p>	<p data-bbox="1177 387 1372 410"><b>3ZS1635-1XX02-0YA0</b></p>	
<b>Runtime license V8</b>			
<p data-bbox="354 687 957 710">For execution of the AS blocks in an automation system (single license)</p> <p data-bbox="354 712 901 755">Required for using the AS blocks of the engineering software V8 on an additional automation system within a plant</p> <p data-bbox="354 757 694 825">Type of delivery: One license for one automation system, without software and documentation</p>			<p data-bbox="1177 657 1372 680"><b>3ZS1635-2XX02-0YB0</b></p>
<b>AS-Interface block library for SIMATIC PCS 7 version V6.1/V7/V8 (Migration)</b>			
 <p data-bbox="130 1076 316 1100">3ZS1635-1XX01-0YA0</p>	<p data-bbox="354 870 582 893"><b>Engineering software V7</b></p> <p data-bbox="354 895 1045 957">For one engineering station (single license) including runtime software for execution of the AS blocks in an automation system (single license), German/English</p> <p data-bbox="354 959 917 1023">Scope of supply: AS blocks and faceplates for integrating AS-Interface into the PCS 7 process control system, for PCS 7 version V6.1, V7.0 or V7.1</p> <p data-bbox="354 1025 694 1110">Type of delivery: Software and documentation on CD, one license for one engineering station, one license for one automation system</p>	<p data-bbox="1177 870 1372 893"><b>3ZS1635-1XX01-0YA0</b></p>	
<b>Runtime license V7</b>			
<p data-bbox="354 1149 957 1172">For execution of the AS blocks in an automation system (single license)</p> <p data-bbox="354 1174 1093 1217">Required for using the AS blocks of the engineering software V7 or the engineering software migration V7-V8 on an additional automation system within a plant</p> <p data-bbox="354 1219 694 1287">Type of delivery: One license for one automation system, without software and documentation</p>			<p data-bbox="1177 1119 1372 1142"><b>3ZS1635-2XX01-0YB0</b></p>
<b>Engineering software migration V7-V8</b>			
<p data-bbox="354 1325 933 1368">For upgrading (migrating) an existing engineering software V7 of the AS-Interface block library for PCS 7</p> <p data-bbox="354 1370 997 1434">Conditions of use: Availability of the engineering software V7 (license) of the AS-Interface block library for PCS 7 for the PCS 7 version V6.1, V7.0 or V7.1</p> <p data-bbox="354 1436 1109 1478">The engineering software migration V7-V8 can be installed directly onto a system with PCS 7 version V8.0; installation of the previous version is unnecessary.</p> <p data-bbox="354 1481 957 1544">For one engineering station (single license) including runtime software for execution of the AS blocks in an automation system (single license), German/English</p> <p data-bbox="354 1547 869 1610">Scope of supply: AS blocks and faceplates for integrating AS-Interface into the PCS 7 process control system, for PCS 7 version V 8.0</p> <p data-bbox="354 1613 782 1713">Type of delivery: software and documentation on CD, license for upgrading an existing license for one engineering station and a plant's assigned runtime licenses</p>			<p data-bbox="1177 1295 1372 1319"><b>3ZS1635-1XX11-0YE0</b></p>

#### More information

Programming manual for AS-Interface block library for SIMATIC PCS 7 version V8 with Advanced Process Library (APL) see <http://support.automation.siemens.com/WW/view/en/37432054/133300>.

Programming manual for AS-Interface block library for SIMATIC PCS 7 version V6.1/V7/V8 (Migration) see <http://support.automation.siemens.com/WW/view/en/46504691>.

#### Notes:

The associated service pack SP1 of the block library is included in the scope of delivery of engineering software V7 and engineering software migration V7-V8.

Service Pack SP1 can also be downloaded from the Internet, see <http://support.automation.siemens.com/WW/view/en/37432054/133100>.



<b>5/2</b>	<b>Introduction</b>	<b>5/36</b>	<b>SIRIUS 3RR24 monitoring relays for mounting onto 3RT2 contactors for IO-Link</b>
5/2	Communication overview	5/36	General data
5/3	System components	5/39	Current and active current monitoring
5/8	IO-Link specification	<b>5/43</b>	<b>SIRIUS 3UG48 monitoring relays for stand-alone installation for IO-Link</b>
<b>5/9</b>	<b>Masters</b>	5/43	General data
5/9	IO-Link master module for S7-1200	5/46	Line monitoring
5/9	- SM 1278 4xIO-Link master	5/47	Voltage monitoring
5/10	IO-Link master module for ET 200SP	5/48	Current monitoring
5/10	- CM 4xIO-Link	5/49	Power factor and active current monitoring
5/12	IO-Link master modules for ET 200S		Residual current monitoring
5/12	- IO-Link 4SI electronic modules	5/50	- Residual-current monitoring relays
5/12	- SIRIUS 4SI electronic modules	5/51	- 3UL23 residual-current transformers
5/13	- SIRIUS 4SI electronic modules	5/52	Speed monitoring
5/14	IO-Link master modules for ET 200eco PN	5/53	Accessories
<b>5/15</b>	<b>Input modules</b>	<b>5/54</b>	<b>SIRIUS 3RS14, 3RS15 temperature monitoring relays for IO-Link</b>
5/15	General data	5/54	General data
5/16	IO-Link K20 modules	5/56	Relays, digitally adjustable for 1 sensor
<b>5/18</b>	<b>Contactors and contactor assemblies</b>	5/58	Relays, digitally adjustable for up to 3 sensors
5/18	SIRIUS 3RT20 contactors, 3-pole, 3 ... 18.5 kW	5/59	Accessories
5/20	SIRIUS 3RA23 reversing contactor assemblies	<b>5/60</b>	<b>RFID systems</b>
5/22	SIRIUS 3RA24 contactor assemblies for wye-delta starting	5/61	SIMATIC RF210R
5/24	SIRIUS 3RA27 function module for IO-Link	5/63	SIMATIC RF220R
<b>5/26</b>	<b>SIRIUS 3RB24 solid-state overload relays for IO-Link</b>	5/65	SIMATIC RF260R
5/26	3RB24 for IO-Link, up to 630 A for High-Feature applications		
5/30	Current measuring modules		
5/31	Accessories		
<b>5/33</b>	<b>SIRIUS 3RA6 compact starters</b>		
5/33	SIRIUS 3RA64, 3RA65 compact starters for IO-Link		
5/35	Accessories for compact starters for IO-Link		

# IO-Link

## Introduction

### Communication overview

#### Overview

IO-Link is an open communication standard for sensors and actuators – defined by the Profibus User Organization (PNO). IO-Link technology is based on the point-to-point connection of sensors and actuators to the control system.

Parameter and diagnostics data are transmitted in addition to the cyclic operating data for the connected sensors/actuators. The simple, unshielded three-wire cable customary for standard sensors is used for this purpose.

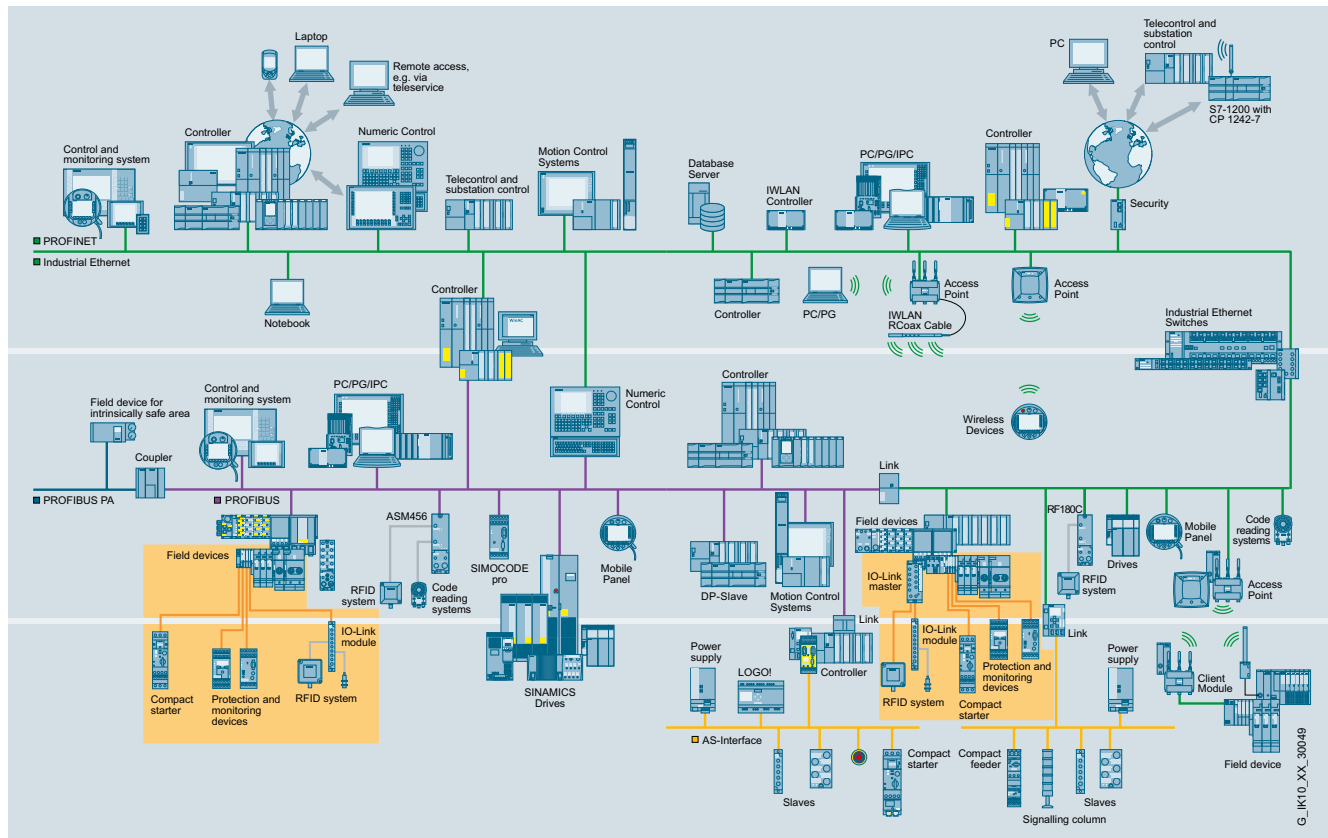

5

#### Benefits

##### Engineering

- Standardized, open system for greater flexibility (non-Siemens IO-Link devices can be integrated in engineering)
- Uniform, transparent configuring and programming through integrated engineering (SIMATIC STEP 7)
- Unassigned SIMATIC function blocks for easy parameterization, diagnostics and read-out of measured values
- Efficient engineering thanks to pre-integration into SIMATIC HMI
- Low error rate in CAD circuit diagram design as a result of reduced control current wiring

##### Installation and commissioning

- Faster assembly with minimized error rate as a result of reduced control current wiring
- Less space required in the control cabinet
- Low-cost circuitry where there are several feeders by making full use of existing components

##### Operation and maintenance

- High transparency in the system right down to field level and integration into power management systems
- Reduction in downtimes and maintenance times thanks to system-wide diagnostics and faster fault correction
- Support of predictive maintenance
- Shorter changeover times, even for field devices, by means of parameter and recipe management

#### Application

IO-Link can be used in the following main applications:

- Easy connection of complex IO-Link sensors/actuators with a large number of parameters and diagnostic data to the control system
- Replacement of sensor boxes for connecting binary sensors with the IO-Link input modules optimized in terms of cabling
- Optimized cable connection of switching devices to the control system
- Simple transmission of energy values from the device to the control system for integration into a user program or power management

In these cases, all the diagnostics data are transmitted to the higher-level control system through IO-Link. The parameter settings can be changed during operation. Central data storage means that it is possible to exchange an IO-Link sensor/actuator without a PC or programming device.

##### Integration in STEP 7

Integration of the device configuration in the STEP 7 environment guarantees:

- Quick and easy engineering
- Consistent data storage
- Quick localization and rectification of faults

### Overview



IO-Link product family

To implement communication, a system installation has the following main components:

- An IO-Link master
- One or more IO-Link devices, such as sensors (e.g. RFID systems), actuators or combinations thereof
- A standard 3-wire sensor/actuator cable

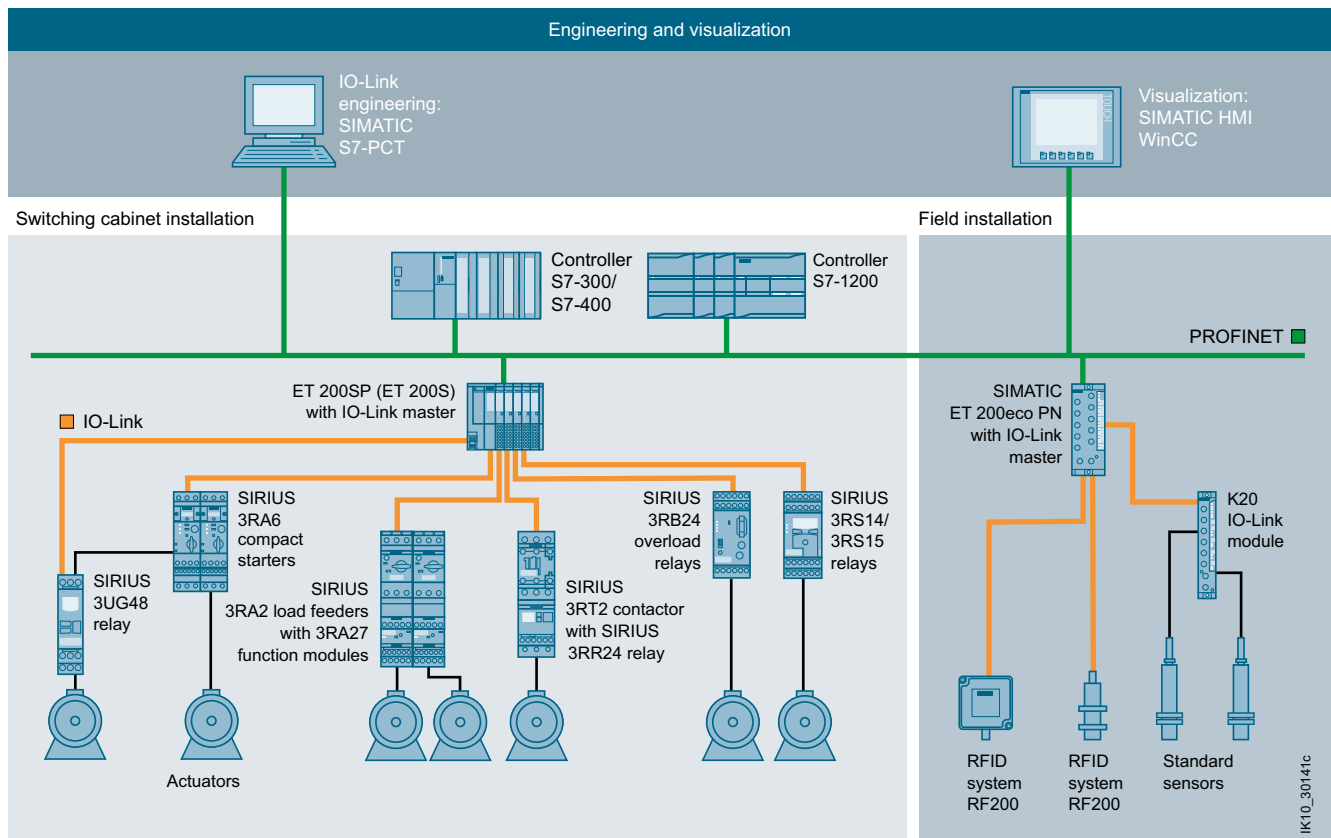

Example of a configuration with the system components

## IO-Link

### Introduction

#### System components

#### Overview (continued)

##### Compatibility of IO-Link

IO-Link guarantees compatibility between IO-Link-capable modules and standard modules as follows:

- IO-Link sensors can be operated both on IO-Link modules (masters) and standard input modules.
- IO-Link sensors/actuators as well as today's standard sensors/actuators can be used on IO-Link masters.
- If conventional components are used in the IO-Link system, then of course only the standard functions are available at this point.

##### Load feeders and motor starters

Through IO-Link it is possible to control not only sensors but also actuators in the form of load feeders and motor starters.

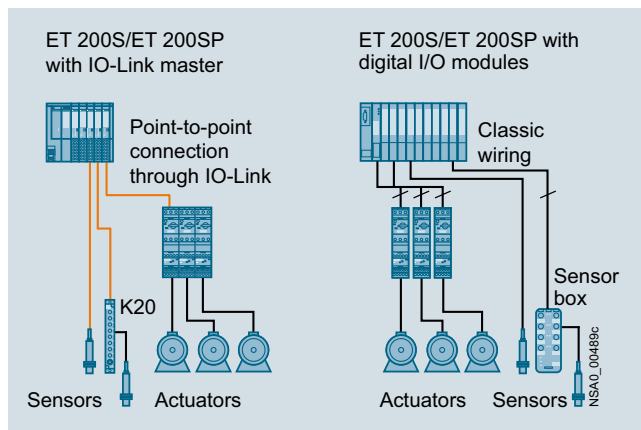

Possibilities for connecting load feeders and motor starters to IO-Link or in the conventional way

##### Analog signals

Another advantage of IO-Link technology is that analog signals are digitized already in the IO-Link sensor itself and are digitally transmitted by the IO-Link communication. As the result, faults are prevented and there is no extra cost for cable shielding.

##### Enhanced through IO-Link input modules

IO-Link compatibility also permits connection of standard sensors/actuators, i.e. conventional sensors/actuators can also be connected to IO-Link. This is particularly effective with the IO-Link input modules, which allow several sensors to be connected at one time via a cable to the controller.

##### Grouping of motor starters

The SIRIUS controls allow four starters to be combined to form a group.



Connection of a motor starter group made up of three 3RA64 direct-on-line starters and a 3RA65 reversing starter

In this way up to 16 starters can be operated on a single IO-Link master. This leads to a reduction in the installation space and control wiring required.

**Overview** (continued)**Monitoring relays**

By using monitoring relays with IO-Link it is now possible to send data that has already been recorded and evaluated in the devices directly to the controller. This avoids the use of duplicated sensors.

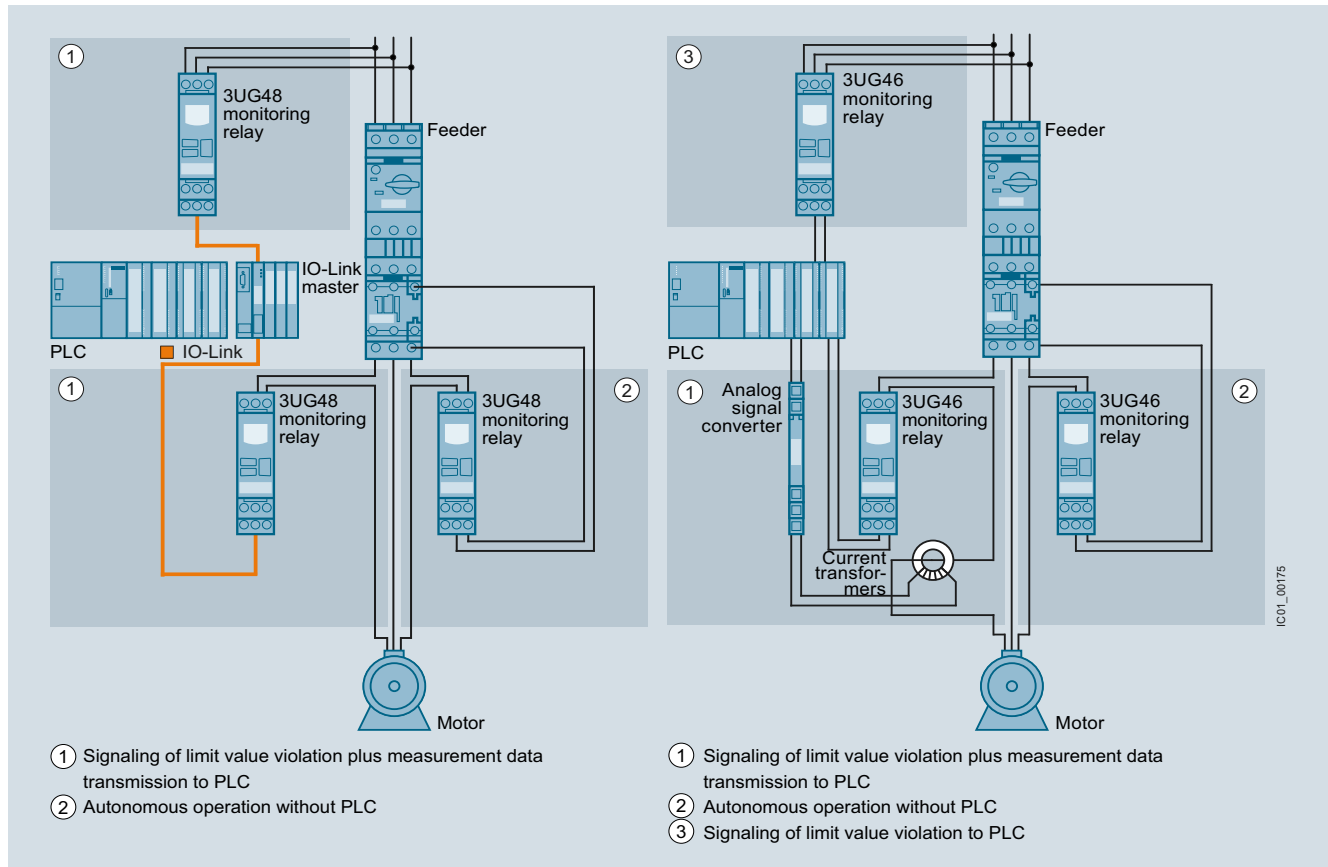

Possibilities for connecting monitoring relays to IO-Link or in the conventional way

## IO-Link

### Introduction

#### System components

#### Overview (continued)

##### Wireless communication

Using an upstream IWLAN client module, such as SCALANCE W722-1 RJ45, allows IO-Link to be integrated into the PROFINET world via a distributed I/O. Possible uses include acting as an alternative to fault-prone cable carrier or collector wire technology. The individual diagnostics options

offered by the various IO-Link devices provide greater transparency for the production process. Just like the parameter data for a device, these diagnostics data can be evaluated remotely using the possibilities offered by SIMATIC. This supports remote maintenance down to the lowest level in the field.

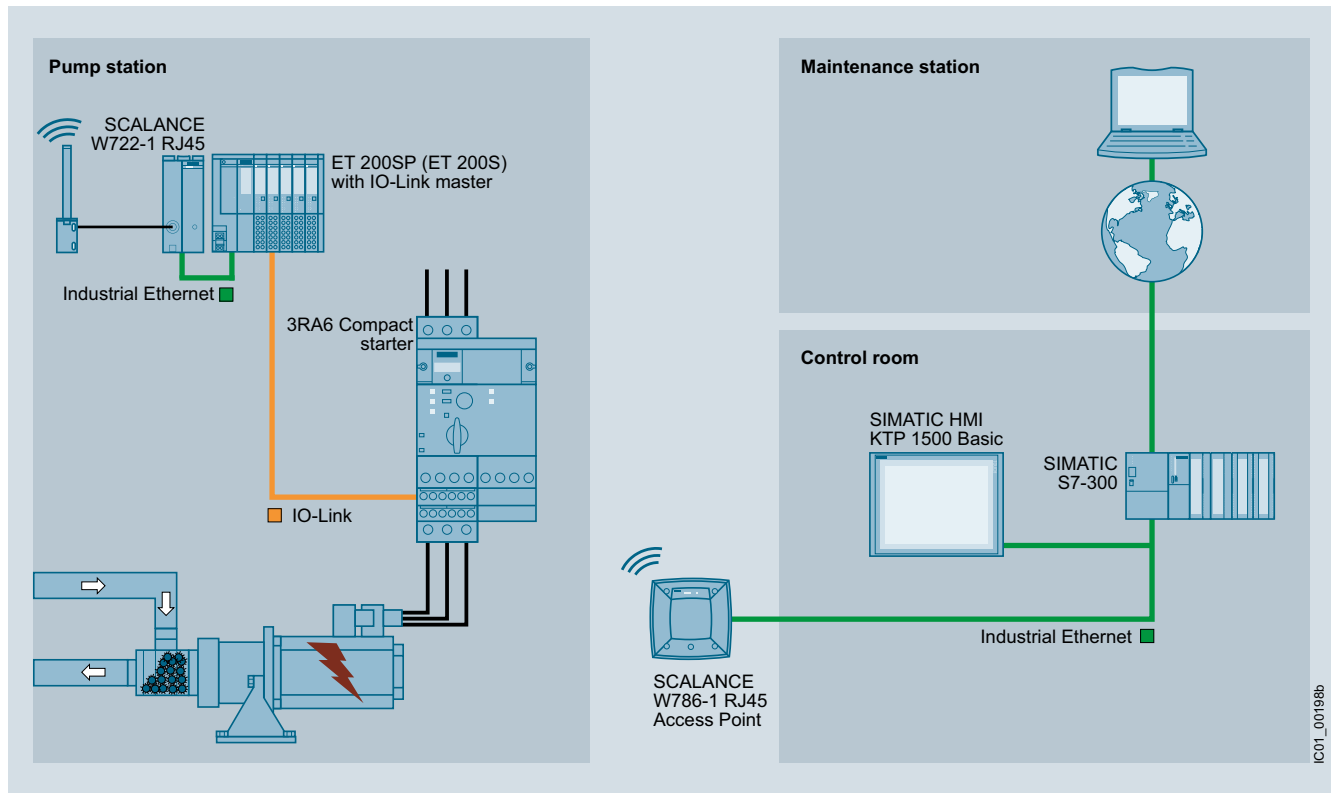

Wireless communication between Industrial Ethernet and IO-Link components

IC01\_00198b



## Overview (continued)

## IO-Link components

## IO-Link master, software, cables

CM 4xIO-Link  
for ET 200SP

STEP 7 PCT

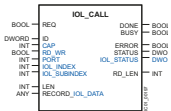
IO-Link Call  
function blockWinCC flexible  
template project

## Masters

IO-Link masters for S7-1200

- SM1278 4xIO-Link

See page 5/9

IO-Link master modules for ET 200SP

- CM 4xIO-Link

See page 5/10

IO-Link master modules for ET 200S

- IO-Link 4SI electronic modules
- SIRIUS 4SI electronic modules

see pages 5/13

IO-Link master modules for ET 200eco PN  
see page 5/14.

## Software

## STEP 7 PCT

Engineering software for configuring  
the IO-Link master modules for S7-1200,  
ET 200SP, ET 200S, ET 200eco

- Available as a stand-alone version or integrated into STEP 7 (V5.5 SP1 or later) and TIA (V12 or later)
- Retrieval of parameter and diagnostics data from the IO-Link devices connected to the master
- Monitoring of the process image of the IO-Link devices
- Open interface for importing further IO-DDS
- Freely available for download from Industry Online Support<sup>1)</sup>

## IO-Link Call function block

STEP 7 function block for easy acyclical data  
exchange in the user program

- Freely available for download from Industry Online Support<sup>2)</sup>

## WinCC flexible template project

Easy integration of IO-Link devices into the  
user program by using ready-made WinCC  
flexible templates

- Freely available for download from Industry Online Support<sup>3)</sup>

## IODD files

IO-Link Device Description (IODD) files  
provide the device description for IO-Link

- Comprehensive IODD catalog of SIEMENS IO-Link devices
- Freely available for download from Industry Online Support<sup>4)</sup>

## Cable

3-wire standard cable

see for example catalog ID 10 "Industrial  
Identification Systems"

## IO-Link devices



K20 input module

## Detection with IO-Link

## IO-Link input modules

K20 input module

- 4 inputs, M12 connections
- 8 inputs, standard M8 connections

See page 5/15

## IO-Link devices (continued)

SIMATIC RF210R,  
SIMATIC RF220R,  
SIMATIC RF260R

## IO-Link RFID systems

SIMATIC RF200 RFID system in the HF range

- SIMATIC RF210R, SIMATIC RF220R, SIMATIC RF260R products
- Simple identification tasks (read-only), such as reading an ID number
- No RFID-specific programming, ideal for those new to RFID
- Simple connection via master modules for IO-Link, such as SIMATIC ET 200S and ET 200eco
- Use with the tried and tested ISO 15693 transponders (MOBY D)  
see Catalog ID 10 "Industrial Identification Systems"

## Switching with IO-Link

## Contactors and contactor assemblies

Power contactors for switching motors

- SIRIUS 3RT2 contactors, 3-pole, up to 18.5 kW

See page 5/18

Contactor assemblies

- SIRIUS 3RA23 reversing contactor assemblies
- SIRIUS 3RA24 contactor assemblies for wye-delta starting

See page 5/22

SIRIUS 3RA27 function modules for IO-Link

- For direct-on-line starters, reversing starters and wye-delta starters

See page 5/24

## Motor starters for use in the control cabinet

SIRIUS 3RA6 compact starters

- 3RA64 direct-on-line starters
- 3RA65 reversing starters
- Infeed system for 3RA6

see page 5/33

SIRIUS 3RA2711  
function module for IO-LinkSIRIUS 3RA64  
direct-on-line starterSIRIUS 3RB24  
overload relaySIRIUS 3RR24  
monitoring relaySIRIUS 3UG48  
monitoring relaySIRIUS 3RS14  
temperature monitoring relay

## Contactors with IO-Link

## Overload relays

SIRIUS 3RB24 solid-state overload relays for  
IO-Link

- Evaluation module
- Current measuring modules from 0.3 to 630 A
- Controlling direct-on-line, reversing and star-delta starters via IO-Link in conjunction with contactors
- Full motor protection
- Diagnostics and current value transmission via IO-Link

See page 5/26

## Monitoring with IO-Link

## SIRIUS 3RR24 monitoring relays for IO-Link

- Monitoring of current, phase failure, open circuit and phase sequence
- Designed for mounting on 3RT2 contactors

See page 5/36

## SIRIUS 3UG48 monitoring relays for IO-Link

- Monitoring network, voltage, current, cos  $\varphi$ , residual current or speed depending on device design
- On/tripping delay time can be adjusted

See page 5/43

## SIRIUS 3RS14, 3RS15 temperature monitoring relays for IO-Link

- Temperature monitoring with connected sensors
- Two limit values, can be adjusted separately

See page 5/54

1) <http://support.automation.siemens.com/WWW/view/en/37936752>2) <http://support.automation.siemens.com/WWW/view/en/82981502>3) <http://support.automation.siemens.com/WWW/view/en/38006560>4) <http://support.automation.siemens.com/WWW/view/en/29801139/133100>

## IO-Link

### Introduction

#### IO-Link specification

#### Overview

##### Principles of the IO-Link specification

According to the IO-Link specification, communication functions as follows:

- Transmission takes place via an unshielded three-wire cable no more than 20 m long, of the kind normally used for standard sensors.
- Analog values which have already been digitized are transmitted in the form of message frames, which may correspond to  $\pm 10$  V or 4 to 20 mA.
- Digital communication from 0 to 24 V on the so-called C/Q cable
- Most of the values transmitted are measured values from the sensors which include the units.
- The sensors and actuators are described by the IO-Link Device Description (IODD).
- While the IO-Link specification permits an infinite number of ports, an IO-Link master currently only supports four ports. Only one IO-Link device (slave) can be connected to each port (point-to-point connection).
- The transmission rates between IO-Link master and the devices are as follows:
  - via COM1: 4 800 Bd
  - via COM2: 38 400 Bd
  - via COM3: 230 400 Bd
- The average cycle time is 2 ms for the reading/writing of 16 data bits at a transmission rate of 38 400 Bd.

##### IO-Link protocol

For the dialog between device and master, IO-Link uses a standard protocol, the standard asynchronous communication interface (UART) in "semi-duplex" mode.

The IO-Link protocol supports both the Standard IO mode (SIO) and the IO-Link communication mode (COM).

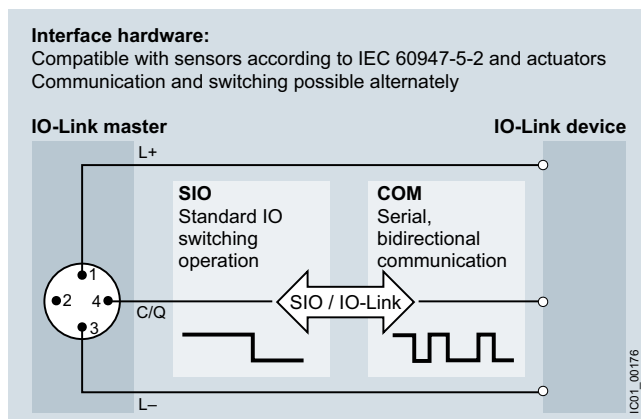

The structure of the protocol and its message frames depends on the types of data to be transmitted.

##### Data types

In the IO-Link specification a distinction is made between the following data types:

##### Process data

The process data of the devices are transmitted cyclically in a data frame, provided the process data width does not exceed 2 bytes. In the case of larger process data widths up to 32 bytes, parts are transmitted one after the other in several cycles. As of Version 1.1 of the specification, up to 32 bytes of process data can be transferred in a single cycle.

##### Service data (SD)

With the aid of the service data, parameter values or device statuses can be read out. It is also possible to write the parameter values or transmit commands via the service data. Service data are always exchanged acyclically and in response to an inquiry from the IO-Link master.

##### Events

Via events it is possible to transmit device events or statuses such as contamination, overheating, short circuits etc., from the device via the IO-Link master to the PLC or to visualize them.

The events are sent on the initiative of the devices via the "event flag", which the master evaluates. The master itself can also generate events.

Three categories of event are defined:

- Error signals (errors)
- Maintenance data (warnings)
- Device functions (notifications)

##### Data storage

As of Specification V1.1, a data storage concept has been created for IO-Link. In this concept, the IO-Link device initiates the storage of its data on a higher-level parameter server. In the event that a device is replaced, the parameter server can restore the original parameterization. It is therefore possible to replace the devices without re-parameterization.

The IO-Link master can contain the parameter server.

The parameter server can also be implemented centrally in the PLC or in a system server. In this case the IO-Link master passes on the corresponding information.

##### IO-Link master

The IO-Link master is the interface to higher-level control systems. The IO-Link master presents itself as a normal fieldbus node, and is integrated into the appropriate network configurator via the relevant device description (e. g. GSD, FDCML, EDS etc.).

##### IO-Link Device Description (IODD)

The IO-Link Device Description (IODD) has been defined to provide a full, transparent description of system characteristics as far as the IO-Link device. It is based on the open XML standard.

The IODD contains information on communication characteristics, device parameters, identification, process and diagnostics data, and is supplied by the manufacturer. The design of the IODD is the same for all devices from all manufacturers, and is always presented in the same way by the IODD Interpreter Tools. This therefore ensures that the handling is the same for all IO-Link devices, whatever the manufacturer.

##### New in IO-Link Specification V1.1

The IO-Link Specification is currently available in Version 1.1, and standardized in accordance with IEC 61131-9.

Specification V1.1 offers the following new features compared with the previous Specification V1.0:

- Transmission of up to 32 bytes of process or service data in one cycle
- Data storage concept

### Overview



SM 1278 4xIO-Link master

The SM 1278 4xIO-Link master signal module is an IO-Link master, and can be used in the SIMATIC S7-1200 automation system.

#### Features

- IO-Link master according to IO-Link specification V1.1
- Up to four IO-Link devices (3-wire connections) can be connected to each IO-Link master module.
- Data transmission rates COM1 (4.8 kBd), COM2 (38.4 kBd), COM3 (230.4 kBd), automatic adjustment to the transmission rate supported by the device
- Port-by-port parameterizable diagnostics
- Up to eight IO-Link master modules can be used depending on the SIMATIC S7-1200 CPU in use.

#### Central data storage

The device parameters are kept in the master module according to the specification V1.1.

#### Note:

When the SM 1278 4xIO-Link master module is exchanged, the IO-Link parameter data are not assigned automatically.

### Configuration

#### Module integration

To integrate the module you need the STEP 7 V13 TIA Portal engineering tool.

#### Configuration

S7-PCT V3.2 and higher is required in addition for IO-Link configuration.

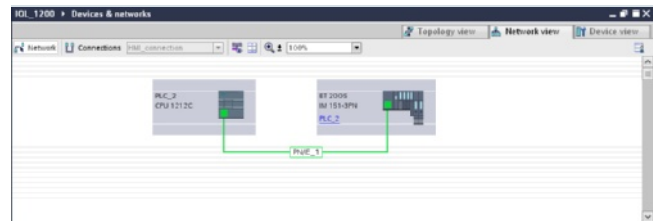

PROFINET configuration with SIMATIC S7-1200 CPU and ET 200S distributed I/O with IO-Link master modules

The address areas for exchanging the cyclic data (process values) are defined by IO-Link in the device view of the PROFINET device.

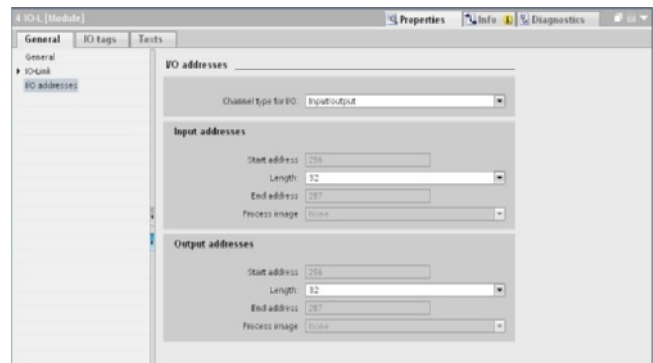

Device view with setting of the address range by IO-Link via TIA Portal

### Selection and ordering data

Version	Article No.
 <p><b>SM 1278 4xIO-Link master signal modules</b></p> <ul style="list-style-type: none"> <li>• IO-Link master for SIMATIC S7-1200</li> <li>• Corresponds to IO-Link specification V1.1</li> <li>• Dimensions (W x H x D / mm): 45 x 100 x 75</li> <li>• Up to eight IO-Link master modules can be used depending on the SIMATIC S7-1200 CPU in use.</li> <li>• Firmware updates</li> </ul>	<b>6ES7278-4BD32-0XB0</b>

6ES7278-4BD32-0XB0

### More information

For more information about SIMATIC S7-1200 see <http://support.automation.siemens.com/WW/view/en/86567043>.

#### Manuals

Manual "SIMATIC IO-Link System" see <http://support.automation.siemens.com/WW/view/en/65949252>.

### Industry Mall

More information see Industry Mall at "Automation Technology" ⇒ "Industrial Communication" ⇒ "IO-Link" ⇒ "Masters" ⇒ "IO-Link Master Module for S7-1200"

## IO-Link

### Masters

#### IO-Link master module for ET 200SP

#### CM 4xIO-Link

#### Overview



IO-Link master CM 4xIO-Link

The CM 4xIO-Link communication module is the IO-Link master, for use in the ET 200SP distributed I/O system.

#### Features

- IO-Link master as serial communication module with 4 ports according to IO-Link specification V1.1
- Module exchange with automatic data recovery without engineering for IO-Link master and IO-Link device
- Up to four IO-Link devices (3-wire connections) can be connected to each IO-Link master module.
- Data transmission rates COM1 (4.8 kBd), COM2 (38.4 kBd), COM3 (230.4 kBd), automatic adjustment to the transmission rate supported by the device
- Port-by-port parameterizable diagnostics
- PROFlenergy support
- Parameterization of IO-Link parameters by S7-PCT V3.0 and higher

#### Central data storage

If the communication module is pulled off the BaseUnit, part of the electronic coding element will remain in the BaseUnit. Stored in this part are the parameters of the CM 4xIO-Link and the parameters of the IO-Link devices. When a new (not yet parameterized) IO-Link master is plugged on, it will adopt the parameters from the electronic coding element.

#### Connection

All type A0 BaseUnits can be used for the CM 4xIO-Link communication module, i.e. all variants of the BaseUnit (without/with infeed, -AUX).

#### Configuration

##### Module integration

To integrate the module you need the engineering tool STEP 7 V5.5 and higher or STEP 7 V11 TIA Portal.

##### Configuration

S7-PCT V3.0 and higher is required in addition for IO-Link configuration.

The following diagram shows a PROFINET configuration in which PROFINET ET 200SP and ET 200eco PN devices are integrated with IO-Link masters.



Configuration of a PROFINET network with lower-level IO-Link masters

The address areas for exchanging the cyclic data (process values) are defined by IO-Link in the device view of the PROFINET device.

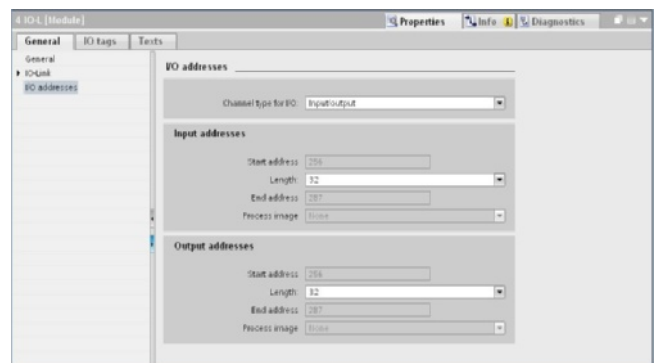

Device view with setting of the address range by IO-Link via TIA Portal

### Selection and ordering data

Version	Article No.
 <p><b>CM 4xIO-Link communication modules</b></p> <ul style="list-style-type: none"> <li>• IO-Link master for SIMATIC ET 200SP, can be plugged onto BaseUnit</li> <li>• Corresponds to IO-Link specification V1.1</li> <li>• Dimensions (W × H × D / mm): 15 × 100 × 75</li> </ul>	<p><b>6ES7137-6BD00-0BA0</b></p>

6ES7137-6BD00-0BA0

### Accessories

Version	Article No.
 <p><b>BaseUnit</b></p> <ul style="list-style-type: none"> <li>• BaseUnit BU15-P16+A10+2D for CM 4xIO-Link to SIMATIC ET 200SP</li> <li>• For opening a new voltage group via the plugged-in peripheral module</li> <li>• Current carrying capacity per process terminal max. 2 A</li> </ul>	<p><b>6ES7193-6BP20-0DA0</b></p>

6ES7193-6BP20-0DA0

### More information

#### Manuals

Manual "SIMATIC IO-Link System" see  
<http://support.automation.siemens.com/WW/view/en/65949252>.

System manual "ET 200SP Distributed I/O System" see  
<http://support.automation.siemens.com/WW/view/en/58649293>.

Product manual "SIMATIC ET 200SP Communication Module  
 IO-Link Master CM 4xIO-Link" see  
<http://support.automation.siemens.com/WW/view/en/67328527>.

#### Industry Mall

For more information see Industry Mall at  
 "Automation Technology" ⇒ "Industrial Communication"  
 ⇒ "IO-Link" ⇒ "Masters" ⇒ "IO-Link Master Module for ET 200SP".

## IO-Link

### Masters

### IO-Link master modules for ET 200S

#### 4SI IO-Link electronic modules

#### Overview



IO-Link 4SI electronic module for ET 200S

The 4SI IO-Link electronic module is an IO-Link master and enables easy integration of sensors and actuators from different manufacturers in the SIMATIC ET 200S multifunctional, distributed I/O system at a total of four ports.

#### Features



- Up to four IO-Link devices (3-wire connection) can be connected to each IO-Link master module. 3RA6 compact starters or load feeders with 3RA27 function modules can even be bundled in groups of four devices on one IO-Link port. It is possible therefore to connect up to 16 load feeders to the control system at one IO-Link master module.
- Up to four standard sensors (2-wire/3-wire connection) can be connected.
- The 4SI IO-Link electronic module has a width of 15 mm and can be used with the following universal terminal modules:
  - TM-E15S26-A1 (screw terminals)
  - TM-E15C26-A1 (spring-type terminals)
  - TM-E15N26-A1 (FastConnect)
- Supports firmware update (STEP 7 V5.4 SP4 and higher).
- Corresponds to IO-Link Specification V1.0

#### Selection and ordering data

Version	Connection	Article No.
 <b>IO-Link 4SI electronic module</b>	Screw terminals, spring-type terminals or FastConnect, depending on universal terminal module	<b>6ES7138-4GA50-0AB0</b>

6ES7138-4GA50-0AB0

#### Accessories

Version	Connection	Article No.
<b>Universal terminal modules for ET 200S</b>		
Module type		
• TM-E15S26-A1	Screw terminals	 <b>6ES7193-4CA40-0AA0</b>
• TM-E15C26-A1	Spring-type terminals	 <b>6ES7193-4CA50-0AA0</b>
• TM-E15N26-A1	FastConnect	 <b>6ES7193-4CA80-0AA0</b>

#### More information

##### Manuals

Product manual "SIMATIC ET 200S distributed I/O 4SI IO-Link electronic modules" see <http://support.automation.siemens.com/WW/view/en/29825814>

##### Industry Mall

More information and technical specifications see Industry Mall under "Automation"  
 ⇒ "Industrial Communication" ⇒ "IO-Link" ⇒ "Masters"  
 ⇒ "IO-Link Master Modules for ET 200S".

## Overview



SIRIUS 4SI electronic module for ET 200S

The SIRIUS 4SI electronic module allows the simple and cost-effective connection of SIRIUS devices with IO-Link to the multi-functional, distributed I/O system SIMATIC ET 200S at a total of four ports.

### Features



- Up to 4 SIRIUS devices can be connected at the 4 ports of the SIRIUS 4SI electronic module. 3RA6 compact starters or load feeders with 3RA27 function modules can even be bundled in groups of four devices on one IO-Link port. It is possible therefore to connect up to 16 load feeders to the control system at one IO-Link master module.
- The SIRIUS 4SI electronic module has a width of 15 mm and can be used with the following universal terminal modules:
  - TM-E15S26-A1 (screw terminals)
  - TM-E15C26-A1 (spring-type terminals)
  - TM-E15N26-A1 (FastConnect)
- Supports firmware update (STEP 7 V5.4 SP5 and higher)
- Corresponds to IO-Link Specification V1.0

## Selection and ordering data

Version	Connection	Article No.
 <b>SIRIUS 4SI electronic modules</b>	Screw terminals, spring-type terminals or FastConnect, depending on universal terminal module	<b>3RK1005-0LB00-0AA0</b>

3RK1005-00LB00-0AA00

## Accessories

Version	Connection	Article No.
<b>Universal terminal modules for ET 200S</b>		
Module type		
• TM-E15S26-A1	Screw terminals	 <b>6ES7193-4CA40-0AA0</b>
• TM-E15C26-A1	Spring-type terminals	 <b>6ES7193-4CA50-0AA0</b>
• TM-E15N26-A1	FastConnect	 <b>6ES7193-4CA80-0AA0</b>

## More information

### Manuals

Product manual "ET 200S distributed I/O system - 4SI SIRIUS electronic modules" see <http://support.automation.siemens.com/WW/view/en/37856470>.

### Industry Mall

More information and technical specifications see Industry Mall under "Automation" ⇒ "Industrial Communication" ⇒ "IO-Link" ⇒ "Masters" ⇒ "IO-Link Master Modules for ET 200S".

## IO-Link Masters

### IO-Link master modules for ET 200eco PN

#### Overview



IO-Link master module for ET 200eco PN

The ET 200eco PN IO-Link master module is an IO-Link master and enables easy connection of sensors and actuators from different manufacturers to the I/Os directly in the machine's field area.

#### Features

- Up to four IO-Link devices (3-wire connection) can be connected to each IO-Link master module.
- Up to eight standard sensors (8 DI) and up to four standard actuators (4 DO) can be connected in addition.

#### Selection and ordering data

	Version	Connection	Article No.
	<b>IO-Link master modules for ET 200eco PN</b> Block I/Os in IP65	M12	<b>6ES7148-6JA00-0AB0</b>

6ES7148-6JA00-0AB0

#### More information

##### Manuals

Manual "SIMATIC Distributed I/O ET 200eco PN" see <http://support.automation.siemens.com/WW/view/en/29999018>

##### Industry Mall

More information and technical specifications see Industry Mall under "Automation"  
⇒ "Industrial Communication" ⇒ "IO-Link" ⇒ "Masters"  
⇒ "IO-Link Master Modules for ET 200eco PN".



## Overview



IO-Link input modules

Using IO-Link technology, it is basically possible to connect standard sensors to IO-Link masters. However, connecting standard sensors directly to the IO-Link master does not exploit the full potential of IO-Link. The solution lies in the technology of the IO-Link modules. Their use is a more economically attractive solution in comparison with the direct connection of a sensor.

IO-Link input modules are a sensible addition to the ET 200S distributed peripherals. The IO-Link input module technology enhances IO-Link via a pure point-to-point cable connection towards decentralized structures. The maximum cable length of an IO-Link connection between an IO-Link module and an IO-Link master is 20 m. The use of sensor boxes with accordingly complex and error-prone wiring is no longer necessary.

### Transmission of parameter and diagnostic signals

The IO-Link input modules also offer the possibility of transmitting parameters and diagnostic signals. This enables for example the inputs of modules to be parameterized as NC contacts or NO contacts through IO-Link. An overload or short circuit in the sensor supply is signaled to the control system through the IO-Link master.

### M8 and M12 terminals

M8 and M12 terminals are available for connecting the sensors. Connection to the IO-Link master is made using a standard M12 connecting cable.

## Benefits

The use of IO-Link input modules has the following benefits:

- Economical use of innovative IO-Link technology also for binary sensors
- Optimum use of all ports of the IO-Link master
- Connection of several binary sensors/actuators to one port of the IO-Link master, hence low-cost connection of also binary sensors/actuators to the control system through IO-Link
- Reduction of digital input modules in the peripheral station
- Use of parameters also for binary sensors (e. g. NC contacts, NO contacts and input delay can be parameterized)
- Reduction of cabling and hence less risk of wiring errors by dispensing with sensor boxes
- Expansion toward distributed structures using pure point-to-point wiring
- Easy and elegant integration of sensors within a radius of 20 m around an ET 200S station
- Possibility of transmitting parameter and diagnostic signals (e.g. sensor supply overload)
- Can also be used in harsh ambient conditions thanks to the very compact design and degree of protection IP67

## Application

IO-Link input modules are particularly used where sensor boxes had previously been used for the connection of binary sensors.

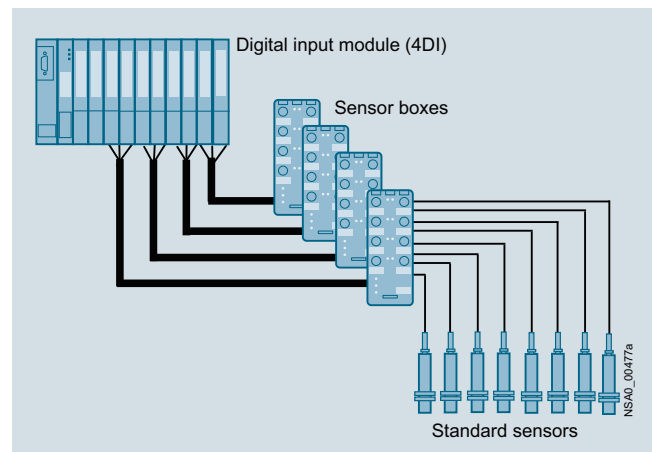

Former technology with sensor boxes

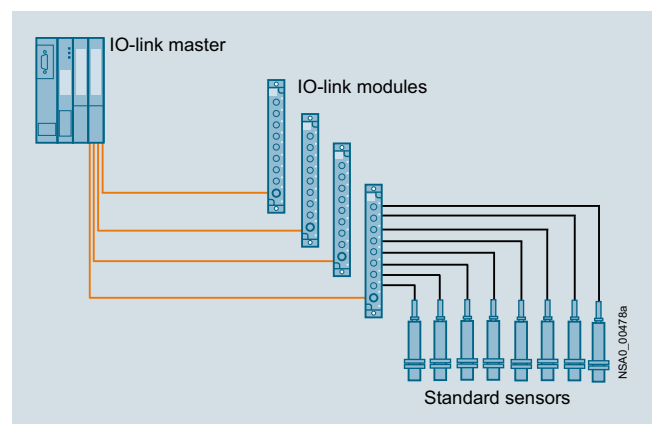



Technology with IO-Link input modules

**IO-Link**

## Input modules

**IO-Link K20 modules****Selection and ordering data**

	Type	Pin assignment	Connection	Article No.
 3RK5010-0BA10-0AA0	<b>IO-Link K20 modules</b> • 4 inputs • 8 inputs	Y	M12	<b>3RK5010-0BA10-0AA0</b> <b>3RK5010-0CA00-0AA0</b>
		Standard	M8	
 3RK5010-0CA00-0AA0				

## Accessories

	Type	Article No.
 3RK1901-1KA00	<b>M12 sealing caps</b> For free M12 sockets	<b>3RK1901-1KA00</b>
 3RK1901-1PN00	<b>M8 sealing caps</b> For free M8 sockets	<b>3RK1901-1PN00</b>
 3RK1902-4GB50-4AA0	<b>Control cables, assembled at one end</b> Angular M12 socket for screw fixing, 4-pole, 4 x 0.34 mm <sup>2</sup> , A-coded, black PUR sheath, max. 4 A • Cable length 5 m	<b>3RK1902-4GB50-4AA0</b>
 3RK1902-4CA00-4AA0	<b>Angular M12 socket</b> for screw fixing, 4-pole screw terminals, max. 0.75 mm <sup>2</sup> , A-coded, max. 4 A	<b>3RK1902-4CA00-4AA0</b>
 3RK1902-4BA00-5AA0	<b>M12 plugs, straight</b> For screw fixing, 5-pole screw terminals, max. 0.75 mm <sup>2</sup> , A-coded, max. 4 A	<b>3RK1902-4BA00-5AA0</b>
 3RK1902-4DA00-5AA0	<b>M12 plugs, angled</b> For screw fixing, 5-pole screw terminals, max. 0.75 mm <sup>2</sup> , A-coded, max. 4 A	<b>3RK1902-4DA00-5AA0</b>
 3RK1902-4H...-5AA0	<b>Control cables, assembled at one end</b> M12 plugs, angled, for screw fixing, 5-pole, 5 x 0.34 mm <sup>2</sup> , A-coded, black PUR sheath, max. 4 A • Cable length 1.5 m • Cable length 5 m • Cable length 10 m	<b>3RK1902-4HB15-5AA0</b> <b>3RK1902-4HB50-5AA0</b> <b>3RK1902-4HC01-5AA0</b>
 3RK1902-4PB15-3AA0	<b>Control cable, assembled at both ends</b> Straight M12 plug, straight M12 socket, for screw fixing, 3-pole, 3 x 0.34 mm <sup>2</sup> , A-coded, black PUR sheath, max. 4 A • Cable length 1.5 m	<b>3RK1902-4PB15-3AA0</b>
 6ES7194-1KA01-0XA0	<b>M12 Y-shaped coupler plugs</b> For connection of two sensors to one M12 socket with Y assignment	<b>6ES7194-1KA01-0XA0</b>

## More information

**Industry Mall**

More information and technical specifications see Industry Mall under "Automation" ⇒ "Industrial Communication" ⇒ "IO-Link" ⇒ "Input Modules" ⇒ "IO-Link K20 Modules".

## IO-Link

### Contactors and contactor assemblies

#### SIRIUS 3RT20 contactors, 3-pole, 3 ... 18.5 kW

##### Overview

##### **Contactors with communication interface, sizes S00 and S0**

Contactor versions with communication interface are required to establish a connection to the control system via IO-Link or AS-Interface. The link is established by means of function modules mounted on the front of the contactor.

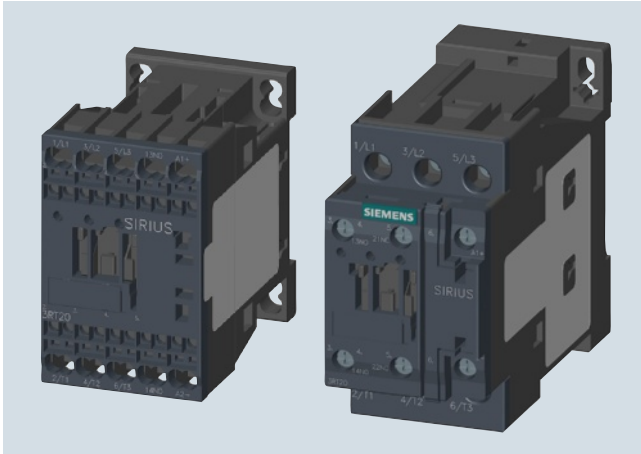

Contactor size S00 with communication interface and spring-type terminals and contactor size S0 with screw terminals

##### Standards

IEC 60947-1, EN 60947-1,  
IEC 60947-4-1, EN 60947-4-1,  
IEC 60947-5-1, EN 60947-5-1 (auxiliary switches)

The 3RT20 contactors for switching motors are climate-proof and are suitable and tested for use worldwide.

If the devices are used in ambient conditions which deviate from common industrial conditions (IEC 60721-3-3 "Stationary Use, Weather-Protected"), information must be obtained about possible restrictions with regard to the reliability and endurance of the device and possible protective measures. In this case contact our Technical Assistance.

3RT2 contactors are finger-safe according to EN 50274.

The contactors are suitable for screw fixing or for mounting onto TH 35 standard mounting rails according to IEC 60715.

##### Contact reliability

If voltages  $\leq 110$  V and currents  $\leq 100$  mA are to be switched, the auxiliary contacts of the 3RT2 contactor or 3RH21 contactor relay should be used as they guarantee a high level of contact reliability.

These auxiliary contacts are suitable for solid-state circuits with currents  $\geq 1$  mA at a voltage  $\geq 17$  V.

##### Connection methods

The 3RT2 contactors are available with screw terminals or spring-type terminals.

##### Short-circuit protection of the contactors

Short-circuit protection of the contactors without overload relay, see "Technical specifications" (see Note).

To assemble fuseless motor feeders you must select combinations of motor starter protector and contactor as explained in "3RA2 Load Feeders".

##### Motor protection

3RU21 thermal overload relays or 3RB30 solid-state overload relays can be fitted to the 3RT2 contactors for protection against overload. The overload relays must be ordered separately.

##### Ratings of three-phase motors

The quoted rating (in kW) refers to the output power on the motor shaft (according to the nameplate).

##### Control supply voltage

Contactors with communication interface are available with 24 V DC operation.

##### **Manuals and configurator**

For more information, see



- System manual "SIRIUS Innovations – System Overview", <http://support.automation.siemens.com/WW/view/en/60311318>
- Manual "SIRIUS Innovations – SIRIUS 3RT2 Contactors/ Contactor Assemblies", <http://support.automation.siemens.com/WW/view/en/60306557>

For online configurator see

[www.siemens.com/sirius/configurators](http://www.siemens.com/sirius/configurators).

## Selection and ordering data

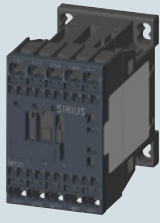
**DC operation · DC solenoid system**  
**Rated control supply voltage 24 V**

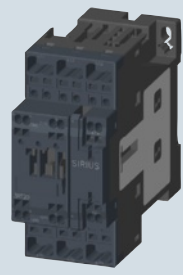
			
3RT201.-1BB4.-0CC0	3RT201.-2BB4.-0CC0	3RT202.-1BB40-0CC0	3RT202.-2BB40-0CC0
Rated data	Auxiliary contacts	Screw terminals	Spring-type terminals
AC-2 and AC-3, $T_U$ : Up to 60 ?	AC-1, $T_U$ : 40 ?		
Operational current $I_e$ up to 400 V	Rating of three-phase motors <sup>1)</sup> at 50 Hz and <b>400 V</b>	Operational current $I_e$ up to 690 V	Ident. No.      Version
A	kW	A	NO      NC
		Article No.	Article No.

For screw and snap-on mounting onto TH 35 standard mounting rail

Size S00

**Contactors with communication interface**

Terminal designations in accordance with DIN EN 50012 or DIN EN 50005

- With auxiliary contact 1 NO, Ident. No. **10**

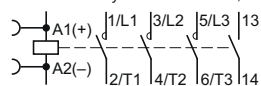

- With auxiliary contact 1 NC, Ident. No. **01**

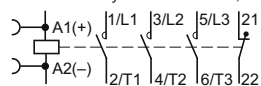

7	<b>3</b>	18	<b>10</b>	1	--	<b>3RT2015-1BB41-0CC0</b>	<b>3RT2015-2BB41-0CC0</b>
			<b>01</b>	--	1	<b>3RT2015-1BB42-0CC0</b>	<b>3RT2015-2BB42-0CC0</b>
9	<b>4</b>	22	<b>10</b>	1	--	<b>3RT2016-1BB41-0CC0</b>	<b>3RT2016-2BB41-0CC0</b>
			<b>01</b>	--	1	<b>3RT2016-1BB42-0CC0</b>	<b>3RT2016-2BB42-0CC0</b>
12	<b>5.5</b>	22	<b>10</b>	1	--	<b>3RT2017-1BB41-0CC0</b>	<b>3RT2017-2BB41-0CC0</b>
			<b>01</b>	--	1	<b>3RT2017-1BB42-0CC0</b>	<b>3RT2017-2BB42-0CC0</b>
16	<b>7.5</b>	22	<b>10</b>	1	--	<b>3RT2018-1BB41-0CC0</b>	<b>3RT2018-2BB41-0CC0</b>
			<b>01</b>	--	1	<b>3RT2018-1BB42-0CC0</b>	<b>3RT2018-2BB42-0CC0</b>

Size S0

**Contactors with communication interface**

Terminal designations according to EN 50012

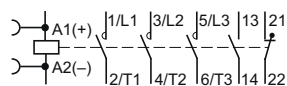

9	<b>4</b>	40	<b>11</b>	1	1	<b>3RT2023-1BB40-0CC0</b>	<b>3RT2023-2BB40-0CC0</b>
12	<b>5.5</b>	40	<b>11</b>	1	1	<b>3RT2024-1BB40-0CC0</b>	<b>3RT2024-2BB40-0CC0</b>
16	<b>7.5</b>	40	<b>11</b>	1	1	<b>3RT2025-1BB40-0CC0</b>	<b>3RT2025-2BB40-0CC0</b>
25	<b>11</b>	40	<b>11</b>	1	1	<b>3RT2026-1BB40-0CC0</b>	<b>3RT2026-2BB40-0CC0</b>
32	<b>15</b>	50	<b>11</b>	1	1	<b>3RT2027-1BB40-0CC0</b>	<b>3RT2027-2BB40-0CC0</b>
38	<b>18.5</b>	50	<b>11</b>	1	1	<b>3RT2028-1BB40-0CC0</b>	<b>3RT2028-2BB40-0CC0</b>

For online configurator see [www.siemens.com/sirius/configurators](http://www.siemens.com/sirius/configurators).

<sup>1)</sup> Guide value for 4-pole standard motors at 50 Hz 400 V AC.  
The actual starting and rated data of the motor to be switched must be considered when selecting the units.

## IO-Link

### Contactors and contactor assemblies

#### SIRIUS 3RA23 reversing contactor assemblies

##### Overview

The 3RA23 contactor assemblies for reversing can be ordered as follows:

- Complete, fully wired and tested, with mechanical and electrical interlock
- As individual parts for customer assembly.

The functions modules for establishing the connection to the control system must be separately ordered in both cases.

The auxiliary contacts integrated in the contactors (see page 5/19) can be freely assigned when function modules are used.

##### Selection and ordering data

###### Fully-wired and tested contactor assemblies

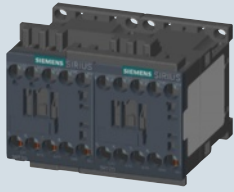
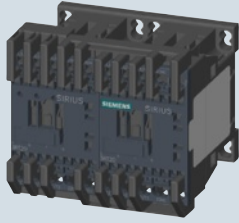
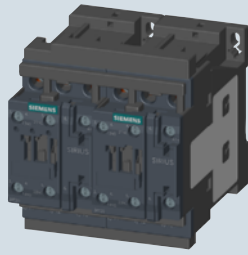
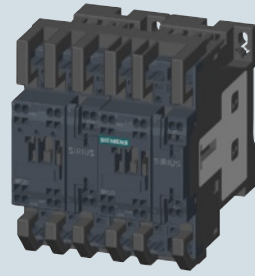
							
3RA231.-8XE30-1BB4		3RA231.-8XE30-2BB4		3RA2324-8XE30-1BB4		3RA2324-8XE30-2BB4	
Rated data AC-2 and AC-3				Screw terminals		Spring-type terminals	
Operational current $I_e$ up to		Ratings of three-phase motors <sup>1)</sup> at 50 Hz and					
400 V		230 V	400 V	500 V	690 V		
A		kW		kW		Article No.	
						Article No.	

##### DC operation 24 V

Size S00

###### With communication interface

7	2.2	<b>3</b>	3.5	4	<b>3RA2315-8XE30-1BB4</b>	<b>3RA2315-8XE30-2BB4</b>
9	3	<b>4</b>	4.5	5.5	<b>3RA2316-8XE30-1BB4</b>	<b>3RA2316-8XE30-2BB4</b>
12	3	<b>5.5</b>	5.5	5.5	<b>3RA2317-8XE30-1BB4</b>	<b>3RA2317-8XE30-2BB4</b>
16	4	<b>7.5</b>	7.5	7.5	<b>3RA2318-8XE30-1BB4</b>	<b>3RA2318-8XE30-2BB4</b>

Size S0

###### With communication interface

12	3	<b>5.5</b>	7.5	7.5	<b>3RA2324-8XE30-1BB4</b>	<b>3RA2324-8XE30-2BB4</b>
16	4	<b>7.5</b>	10	11	<b>3RA2325-8XE30-1BB4</b>	<b>3RA2325-8XE30-2BB4</b>
25	5.5	<b>11</b>	11	11	<b>3RA2326-8XE30-1BB4</b>	<b>3RA2326-8XE30-2BB4</b>
32	7.5	<b>15</b>	18.5	18.5	<b>3RA2327-8XE30-1BB4</b>	<b>3RA2327-8XE30-2BB4</b>
38	7.5	<b>18.5</b>	18.5	18.5	<b>3RA2328-8XE30-1BB4</b>	<b>3RA2328-8XE30-2BB4</b>

For online configurator see [www.siemens.com/sirius/configurators](http://www.siemens.com/sirius/configurators).

<sup>1)</sup> Guide value for 4-pole standard motors at 50 Hz 400 V AC. The actual starting and rated data of the motor to be switched must be considered when selecting the units.

**Selection and ordering data** (continued)**Components for customer assembly**

Assembly kits for all sizes are available for customer assembly of reversing contactor assemblies.

Contactors, overload relays and function modules for reversing starting must be ordered separately.

Selection of contactors for customer assembly

Rated data AC-2 and AC-3 for 50 Hz 400 V AC		Size	Article No.		
Rating kW	Operational current $I_e$ A		Contactor	Assembly kit	Complete assemblies
3	7	<b>S00</b>	3RT2015-.BB4.-0CC0	3RA2913-2AA.	<b>3RA2315-8XB30-.BB4</b>
4	9		3RT2016-.BB4.-0CC0		<b>3RA2316-8XB30-.BB4</b>
5.5	12		3RT2017-.BB4.-0CC0		<b>3RA2317-8XB30-.BB4</b>
7.5	16		3RT2018-.BB4.-0CC0		<b>3RA2318-8XB30-.BB4</b>
5.5	12	<b>S0</b>	3RT2024-.BB40-0CC0	3RA2923-2AA.	<b>3RA2324-8XB30-.BB4</b>
7.5	16		3RT2025-.BB40-0CC0		<b>3RA2325-8XB30-.BB4</b>
11	25		3RT2026-.BB40-0CC0		<b>3RA2326-8XB30-.BB4</b>
15	32		3RT2027-.BB40-0CC0		<b>3RA2327-8XB30-.BB4</b>
18.5	38		3RT2028-.BB40-0CC0		<b>3RA2328-8XB30-.BB4</b>

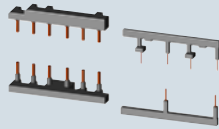
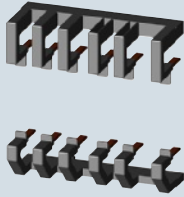
 3RA2923-2AA1			 3RA2923-2AA2		
Type			Article No.	Article No.	

**Assembly kits for making 3-pole contactor assemblies**

3RT201	<b>S00-S00</b>	The assembly kit contains: Mechanical interlock, 2 connecting clips for 2 contactors, wiring modules on the top and bottom • For main, auxiliary and control circuits	<b>3RA2913-2AA1</b>	<b>3RA2913-2AA2</b>
3RT202	<b>S0-S0</b>	The assembly kit contains: Mechanical interlock, 2 connecting clips for 2 contactors, wiring modules on the top and bottom • For main, auxiliary and control circuits • Only for main circuit <sup>1)</sup>	<b>3RA2923-2AA1</b>	<b>3RA2923-2AA2</b>

<sup>1)</sup> Version in size S0 with spring-type terminals:  
Only the wiring modules for the main circuit are included.  
No connectors are included for the auxiliary and control circuit.

## IO-Link

### Contactors and contactor assemblies

#### SIRIUS 3RA24 contactor assemblies for wye-delta starting

##### Overview

These 3RA24 contactor assemblies for wye-delta starting are designed for standard applications.

##### Note:

Contactor assemblies for wye-delta starting in special applications such as very heavy starting or wye-delta starting of special motors must be customized. Help with designing such special applications is available from Technical Assistance.

The 3RA24 contactor assemblies for wye-delta starting can be ordered as follows:

- Complete, fully wired and tested, with electrical and mechanical interlock
- As individual parts for customer assembly.

A dead interval of 50 ms on reversing is already integrated in the function module for wye-delta starting. The auxiliary contacts integrated in the contactors (see page 5/19) are unassigned.

##### Selection and ordering data

##### Fully-wired and tested contactor assemblies

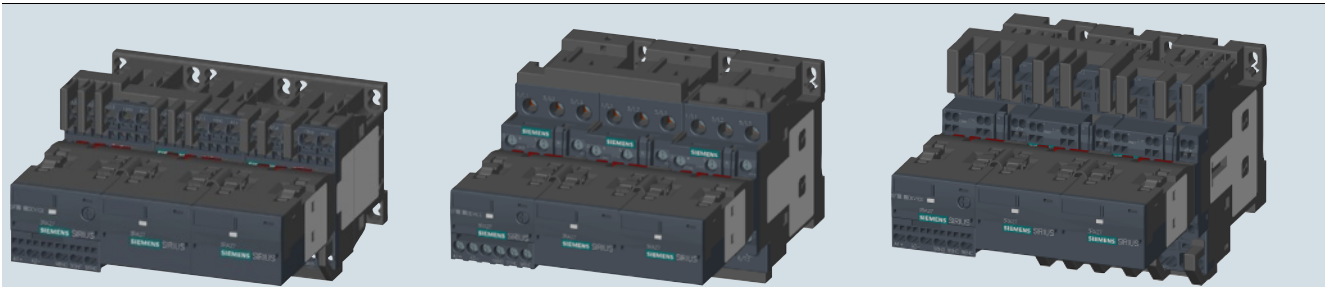

3RA241.-8XE31-2BB4

3RA242.-8XE32-1BB4

3RA242.-8XE32-2BB4

Rated data AC-3

Operational current  $I_e$  up toRatings of three-phase motors<sup>1)</sup> at 50 Hz and400 V      230 V      **400 V**      500 V      690 V

A              kW              kW              kW              kW              V

Rated control supply voltage  $U_s$ 

Screw terminals



Spring-type terminals



Article No.

Article No.

##### DC operation 24 V

##### Size S00

##### For IO-Link connection

12	3.3	<b>5.5</b>	7.2	9.2	24 DC
16	4.7	<b>7.5</b>	10.3	9.2	24 DC
25	5.5	<b>11</b>	11	11	24 DC

**3RA2415-8XE31-1BB4****3RA2415-8XE31-2BB4****3RA2416-8XE31-1BB4****3RA2416-8XE31-2BB4****3RA2417-8XE31-1BB4****3RA2417-8XE31-2BB4**

##### Size S0

##### For IO-Link connection

25	7.1	<b>11</b>	15.6	19	24 DC
32 / 40	11.4	<b>15 / 18.5</b>	19	19	24 DC
50	--	<b>22</b>	19	19	24 DC

**3RA2423-8XE32-1BB4****3RA2423-8XE32-2BB4****3RA2425-8XE32-1BB4****3RA2425-8XE32-2BB4****3RA2426-8XE32-1BB4****3RA2426-8XE32-2BB4**

For online configurator see [www.siemens.com/sirius/configurators](http://www.siemens.com/sirius/configurators).

<sup>1)</sup> Guide value for 4-pole standard motors at 50 Hz 400 V AC.

The actual starting and rated data of the motor to be switched must be considered when selecting the units.



**Selection and ordering data** (continued)**Components for customer assembly**

Assembly kits with wiring modules and mechanical connectors are available for contactor assemblies for wye-delta starting. Contactors, overload relays, function modules for wye-delta starting, auxiliary switches for electrical interlock – if required also infeed terminals – must be ordered separately.

The wiring kits for sizes S00 and S0 contain the top and bottom main conducting path connections between the line and delta contactors (top) and between the delta and star contactors (bottom).

**Selection of contactors for customer assembly**

Rated data AC-3 at 50 Hz 400 V AC			Size	Article No.		Complete assemblies
Rating kW	Operational current $I_e$ A	Motor current A		Line/delta contactor	Star contactor	
5.5	12	9.5 ... 13.8	<b>S00-S00-S00</b>	3RT2015-.BB4.-0CC0	3RT2015-.BB4.-0CC0	<b>3RA2415-8XE31-.BB4</b>
7.5	16	12.1 ... 17		3RT2017-.BB4.-0CC0	3RT2015-.BB4.-0CC0	<b>3RA2416-8XE31-.BB4</b>
11	25	19 ... 25		3RT2018-.BB4.-0CC0	3RT2016-.BB4.-0CC0	<b>3RA2417-8XE31-.BB4</b>
11	25	19 ... 25	<b>S0-S0-S0</b>	3RT2024-.BB40-0CC0	3RT2024-.BB40-0CC0	<b>3RA2423-8XE32-.BB4</b>
15	32	24.1 ... 34		3RT2026-.BB40-0CC0	3RT2024-.BB40-0CC0	<b>3RA2425-8XE32-.BB4</b>
18.5	40	34.5 ... 40		3RT2026-.BB40-0CC0	3RT2024-.BB40-0CC0	<b>3RA2425-8XE32-.BB4</b>
22	50	31 ... 43		3RT2027-.BB40-0CC0	3RT2026-.BB40-0CC0	<b>3RA2426-8XE32-.BB4</b>

For contactors, see page 5/19.

For contactors	Size	Version	Article No.	Article No.
			<b>Screw terminals</b>	<b>Spring-type terminals</b>
Type				

**Assembly kits for making 3-pole contactor assemblies**

3RT201	<b>S00</b>	The assembly kit contains: Mechanical interlock, 4 connecting clips for 3 contactors; star jumper, wiring modules on the top and bottom • For main, auxiliary and control circuits	<b>3RA2913-2BB1</b>	<b>3RA2913-2BB2</b>
3RT202	<b>S0</b>	The assembly kit contains: Mechanical interlock, 4 connecting clips for 3 contactors, star jumper, wiring modules on the top and bottom <sup>1)</sup> • For main, auxiliary and control circuits • Only for main circuit <sup>2)</sup>	<b>3RA2923-2BB1</b>	--
	<b>S0</b>	The assembly kit contains: mechanical interlock; 2 connecting clips for 3 contactors, wiring modules on the top and bottom, 3-phase infeed terminals • For main, auxiliary and control circuits	--	<b>3RA2923-2BB2</b>
			<b>3RA2924-2BB1</b>	--

<sup>1)</sup> When using the function modules for wye-delta starting, the wiring modules included in the assembly kit for the auxiliary current are not required.

<sup>2)</sup> Version in size S0 with spring-type terminals:  
Only the wiring modules for the main circuit are included.  
No connectors are included for the auxiliary and control circuit.

## IO-Link

### Contactors and contactor assemblies

#### SIRIUS 3RA27 function module for IO-Link

##### Overview







The function modules for mounting onto contactors enable the configuration of starters and contactor assemblies for direct-on-line, reversing and wye-delta starting without any additional, complicated wiring of the individual components.

They include the key control functions required for the particular feeder, e.g. timing and interlocking, and can be connected to the control system via IO-Link.

##### Manuals

For more information see manual "SIRIUS Function Modules for IO-Link", <http://support.automation.siemens.com/WW/view/en/39319600>

##### Selection and ordering data

Version	Screw terminals	Spring-type terminals
Article No.	Article No.	Article No.
<b>Function modules for direct-on-line starting</b>		
 3RA2711-1AA0  3RA2711-2AA0	<b>IO-Link connection</b> Includes one module connector for assembling an IO-Link group	3RA2711-1AA0 3RA2711-2AA0
<b>Function modules for reversing starting <sup>1)</sup></b>		
 3RA2711-1BA0  3RA2711-2BA0	<b>IO-Link connection,</b> comprising one basic and one coupling module and an additional module connector for assembling an IO-Link group	3RA2711-1BA0 3RA2711-2BA0
<b>Function modules for wye-delta starting <sup>2)</sup></b>		
 3RA2711-1CA0  3RA2711-2CA0	<b>IO-Link connection,</b> comprising one basic module and two coupling modules, plus an additional module connector for assembling an IO-Link group	3RA2711-1CA0 3RA2711-2CA0





Suitable contactors or reversing contactor assemblies with communication interface are required (see pages 5/19 and 5/20).

##### Note:

When using the function modules, no other auxiliary switches are allowed to be connected to the basic units.

- 1) For prewired contactor assemblies for reversing starting with communication interface, see page 5/20. When these contactor assemblies are used, the assembly kit for the wiring is already integrated.
- 2) For complete contactor assemblies for wye-delta starting incl. function modules, see page 5/22.

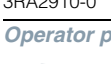
## Selection and ordering data (continued)

Version	Article No.	
<b>Accessories</b>		
 <p>3RA2711-0EE01</p>	<p><b>Module connector set</b>, comprising:</p> <ul style="list-style-type: none"> <li>• 2 module connectors, 14-pole, short</li> <li>• 2 interface covers</li> </ul>	3RA2711-0EE01
 <p>3RA2711-0EE02</p>	<p><b>Module connectors</b>, 14-pole, 8 cm</p> <p>For size jump S00-S0 + 1 space</p>	3RA2711-0EE02
 <p>3RA2711-0EE03</p>	<p><b>Module connectors</b>, 14-pole, 21 cm</p> <p>For various space combinations</p>	3RA2711-0EE03
 <p>3RA2711-0EE04</p>	<p><b>Module connectors</b>, 10-pole, 8 cm</p> <p>For separate auxiliary voltage infeed within an IO-Link group</p>	3RA2711-0EE04
 <p>3RA2910-0</p>	<p><b>Sealable covers</b></p> <p>for 3RA27, 3RA28, 3RA29</p>	3RA2910-0
<b>Operator panels<sup>1)</sup></b>		
 <p>3RA6935-0A</p>	<p><b>Operator panel (set)</b>, comprising:</p> <ul style="list-style-type: none"> <li>• 1 x operator panel</li> <li>• 1 x enabling module</li> <li>• 1 x interface cover</li> <li>• 1 x fixing terminal</li> </ul>	3RA6935-0A
	<p><b>Connection cable</b>, length 2 m, 10- to 14-pole</p> <p>For connecting the operator panel to the communication module</p>	3RA2711-0EE11
	Enabling modules (replacement)	3RA6936-0A
	Interface covers (replacement)	3RA6936-0B

<sup>1)</sup> Suitable only for communication through IO-Link.

## IO-Link

### SIRIUS 3RB24 solid-state overload relays for IO-Link

#### 3RB24 for IO-Link, up to 630 A for High-Feature applications

#### Overview

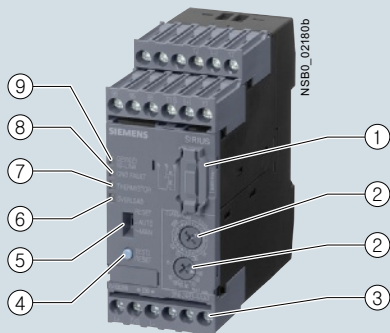

- ① Plug-in point for operator panel:  
enables connection of the 3RA6935-0A operator panel.
- ② Motor current and trip class setting:  
Setting the device to the motor current and to the required trip class dependent on the start-up conditions is easy with the two rotary switches.
- ③ Connecting terminals (removable terminal block):  
The generously sized terminals permit connection of two conductors with different cross-sections for the auxiliary, control and sensor circuits. Connection is possible with screw connection and alternatively with spring-type connection.
- ④ Test/RESET button:  
Enables testing of all important device components and functions, plus resetting of the device after a trip when manual RESET is selected.
- ⑤ Selector switch for manual/automatic RESET:  
With this switch you can choose between manual and automatic RESET.
- ⑥ Red LED "OVERLOAD":  
A continuous red light signals an active overload trip; a flickering led light signals an imminent trip (overload warning).
- ⑦ Red LED "THERMISTOR":  
A continuous red light signals an active thermistor trip.
- ⑧ Red LED "GND FAULT":  
A continuous red light signals an active ground-fault trip.
- ⑨ Green LED "DEVICE/IO-Link":  
A continuous green light signals that the device is working correctly, a green flickering light signals the communication through IO-Link.

#### SIRIUS 3RB24 evaluation module

The modular 3RB24 solid-state overload relay, which is powered via IO-Link (with monostable auxiliary contacts) up to 630 A (up to 820 A possible with a series transformer) have been designed for inverse-time delayed protection of loads with normal and heavy starting ("Function" see Manual "SIRIUS 3RB24 Solid-State Overload Relay for IO-Link", <http://support.automation.siemens.com/WW/view/en/46165627>) against excessive temperature rises due to overload, phase unbalance or phase failure. It comprises an evaluation unit, a current measuring module and a connecting cable.

The 3RB24 evaluation module also offers a motor starter function: The contactors, which are connected via the auxiliary contacts, can also be actuated for operation via IO-Link. In this way, direct, reversing and star-delta starters up to 630 A (or 830 A) can be connected to the controller wirelessly via the IO-Link controller.

An overload, phase unbalance or phase failure result in an increase of the motor current beyond the set rated motor current.

This current rise is detected by means of the current measuring module (see page 5/30) and electronically evaluated by the evaluation module which is connected to it. The evaluation electronics sends a signal to the auxiliary contacts. The auxiliary contacts then switch off the load by means of a contactor.

The break time depends on the ratio between the tripping current and current setting  $I_{\text{e}}$  and is stored in the form of a long-term stable tripping characteristic (see "Characteristic Curves" <http://support.automation.siemens.com/WW/view/en/20357046/134300>). The "tripped" status is signaled by means of a continuously illuminated red "OVERLOAD" LED and also reported as a group fault via IO-Link.

The LED indicates imminent tripping of the relay due to overload, phase unbalance or phase failure by flickering when the limit current has been violated. This warning can also be reported to the higher-level PLC via IO-Link at the 3RB24 overload relay.

In addition to the described inverse-time delayed protection of loads against excessive temperature rises, the 3RB24 solid-state overload relays also allow direct temperature monitoring of the motor windings (full motor protection) by connection with broken-wire interlock of a PTC sensor circuit. With this temperature-dependent protection, the loads can be protected against overheating caused indirectly by reduced coolant flow, for example, which cannot be detected by means of the current alone. In the event of overtemperature, the devices switch off the contactor, and thus the load, by means of the auxiliary contacts. The "tripped" status is signaled by means of a continuously illuminated "THERMISTOR" LED and also reported as a group fault via IO-Link.

To protect the loads against incomplete ground faults due to damage to the insulation, humidity, condensed water, etc., the 3RB24 solid-state overload relays offer the possibility of internal ground-fault detection (for details, see Manual "SIRIUS 3RB24 Solid-State Overload Relay for IO-Link", <http://support.automation.siemens.com/WW/view/en/46165627>, not possible in conjunction with contactor assemblies for wye-delta starting). In the event of a ground fault, the 3RB24 relays trip instantaneously.

The "tripped" status is signaled by means of a flashing red LED "Ground Fault" and reported at the 3RB24 overload relay as a group fault via IO-Link.

The reset after overload, phase unbalance, phase failure, thermistor or ground-fault tripping is performed manually by key on site, via IO-Link or by electrical remote RESET or automatically after the cooling time (motor model) or for thermistor protection after sufficient cooling. Power cuts in devices due to function monitors (broken wire or short-circuit on the thermistor) can only be reset on-site ("Function" see Manual "SIRIUS 3RB24 Solid-State Overload Relay for IO-Link", <http://support.automation.siemens.com/WW/view/en/46165627>).

**Overview** (continued)

In conjunction with a function expansion module, the motor current measured by the microprocessor can be output in the form of an analog signal DC 4 to 20 mA for operating rotary coil instruments or for feeding into analog inputs of programmable logic controllers.

The current values can be transmitted to the higher-level controller via IO-Link.

The 3RB24 solid-state overload relay for IO-Link is suitable for operation with frequency converters. Please follow the instructions in the manual "SIRIUS 3RB24 Solid-State Overload Relay for IO-Link", see <http://support.automation.siemens.com/WW/view/en/46165627>.

The devices are manufactured in accordance with environmental guidelines and contain environmentally friendly and reusable materials. They comply with all important worldwide standards and approvals.

**Type of protection "increased safety EEx e and explosion-proof enclosure EEx d" in accordance with ATEX Directive 94/9/EC**

The 3RB24 solid-state overload relay (monostable) are suitable for the overload protection of explosion-proof motors of types of protection EEx e and EEx d.

They comply with the requirements of IEC 60079-7 (Electrical devices for areas subject to explosion hazards - Increased safety "e" as well as for flameproof enclosure "d").

EC type test certificate for Group II, Category (2) G/D has been submitted. On request.

**Overload relays overview – matching contactors**

Overload relays	Current measuring module	Current range	Contactors (type, size, rating in kW)							
			3RT201.	3RT202.	3RT103.	3RT104.	3RT105.	3RT106.	3RT107.	3TF68/3TF69
Type	Type	A	S00	S0	S2	S3	S6	S10	S12	Size 14
			3/4/5.5/7.5	5.5/7.5/11	15/18.5/22	30/37/45	55/75/90	110/132/160	200/250	375/450

**SIRIUS 3RB24 solid-state overload relays<sup>1)</sup>**

3RB24

3RB2483 +	3RB2906	0.3 ... 25	✓	✓	--	--	--	--	--	--
	3RB2906	10 ... 100	✓	✓	✓	✓	--	--	--	--
	3RB2956	20 ... 200	--	✓	✓	✓	✓	--	--	--
	3RB2966	63 ... 630	--	--	--	--	--	✓	✓	✓
	3RB2906 + 3UF18	630 ... 820	--	--	--	--	--	--	--	✓

✓ Can be used

-- Cannot be used

<sup>1)</sup> "Technical specifications" for the use of overload relays with trip class ≥ CLASS 20 can be found in "Short-circuit protection with fuses for motor feeders", see Configuration Manuals

- "SIRIUS Configuration – Selection Data for Fuseless Load Feeders", <http://support.automation.siemens.com/WW/view/en/40625241>

- "Configuring SIRIUS Innovations – Selection data for Fuseless and Fused Load Feeders", <http://support.automation.siemens.com/WW/view/en/39714188>.

**Benefits**

The key features and benefits of the 3RB24 solid-state overload relays for IO-Link are listed in the overview table (see Catalog IC 10, Chapter 7 "Protection Equipment" → "Overload Relays" → "General Data").

**Connection methods**

The evaluation modules of the 3RB24 solid-state overload relays for High-Feature applications are available with screw terminals (box terminals) or spring-type terminals at the auxiliary current end.

The 3RB29 current measuring modules are designed as straight-through modules. From size S6 upwards they are also available with an optional busbar connection.



Screw terminals



Spring-type terminals

The various terminals are indicated in the corresponding tables by the displayed symbols.

**IO-Link****SIRIUS 3RB24 solid-state overload relays for IO-Link****3RB24 for IO-Link, up to 630 A for High-Feature applications****Application****Industries**

The 3RB24 solid-state overload relays are suitable for customers from all industries who want to guarantee optimum inverse-time delayed and temperature-dependent protection of their electrical loads (e.g. motors) under normal and heavy starting conditions (CLASS 5 to 30), minimize project completion times, inventories and energy consumption, and optimize plant availability and maintenance management.

**Application area**

The 3RB24 solid-state overload relays have been designed for the protection of three-phase asynchronous and single-phase AC motors.

In addition to protection function, these devices can be used together with contactors as direct or reversing starters (star-delta (wye-delta) start also possible), which are controlled via IO-Link. This makes it possible to directly control drives via IO-Link from a higher-level controller or on site via the optional hand-held device lamps and also, for example, to return current values directly via IO-Link.

If single-phase AC motors are to be protected by the 3RB24 solid-state overload relays, the main current paths of the current measuring modules must be series-connected ("Circuit Diagrams" see Manual "SIRIUS 3RB24 Solid-State Overload Relay for IO-Link", <http://support.automation.siemens.com/WW/view/en/46165627>).

**Ambient conditions**

The devices are insensitive to external influences such as shocks, corrosive ambient conditions, ageing and temperature fluctuations.

For the temperature range from  $-25\text{ °C}$  to  $+60\text{ °C}$ , the 3RB24 solid-state overload relays compensate the temperature in accordance with IEC 60947-4-1.

Configuration notes for use of the devices below  $-25\text{ °C}$  or above  $+60\text{ °C}$  on request.

### Selection and ordering data

**3RB24 solid-state overload relays (evaluation modules) for full motor protection, stand-alone installation, CLASS 5, 10, 20 and 30, adjustable**

Type	3RB2483-4A.1
<b>Features and technical specifications</b>	
Overload protection, phase failure protection and unbalance protection	✓
Supplied from an external voltage	✓ 24 V DC through IO-Link
Direct-on-line or reversing starters (wye-delta starting also possible) controllable through IO-Link	✓
Auxiliary contacts	✓ 1 CO and 1 NO in series
Manual and automatic RESET	✓
Remote-RESET	✓ (electrically or via IO-Link)
Four LEDs for operating and status displays	✓
TEST function and self-monitoring	✓
Internal ground-fault detection	✓
Screw or spring-type terminals for auxiliary, control and sensor circuits	✓
Input for PTC sensor circuit	✓
Analog output	✓
<b>IO-Link-specific functions</b>	
• Connection of direct-on-line, reversing and star-delta starters to the controller via IO-Link	✓
• On-site controlling of the starter using the hand-held device	✓
• Accessing process data (e.g. current values in all three phases) via IO-Link	✓
• Accessing parameterization and diagnostics data (e.g. tripped signals) via IO-Link	✓

✓ Available

PU (UNIT, SET, M) = 1

PS\* = 1 unit

PG = 41G

Size	Version	Image	Terminal Type	Article No.
contactor			Screw terminals	3RB2483-4AA1
			Spring-type terminals	3RB2483-4AC1

### Evaluation modules

S00 ... S12

Monostable

3RB2483-4AA1

3RB2483-4AC1

### Notes:

Overview of overload relays – matching contactors see page 5/27.

Analog input modules, e.g. SM 331, must be configured for 4-wire measuring transducers. The analog input module may not supply current to the analog output of the 3RB24 relay.

For current measuring modules and related connecting cables see next page, "Accessories" see pages 5/31 and 5/32.

## IO-Link

### SIRIUS 3RB24 solid-state overload relays for IO-Link

#### Current measuring modules





##### Overview

The current measuring modules are designed as system components for connecting to 3RB24 evaluation units. Using these evaluation units the motor current is measured and the measured value sent to the evaluation unit for evaluation.

The current measuring modules in sizes S00 to S3 up to 55 mm wide are equipped with straight-through transformers and can be snap-fitted under the evaluation units. The larger evaluation units are installed directly on the contactor or as stand-alone units.

##### Selection and ordering data

###### Current measuring modules for mounting onto contactor<sup>1)</sup> and stand-alone installation<sup>1) 2)</sup> (essential accessories)

	Size contactor <sup>3)</sup>	Rating for three-phase motor, rated value <sup>4)</sup>	Current setting value of the inverse-time delayed overload release	Short-circuit protection with fuse, type of coordination "2", operational class gG <sup>5)</sup>	For overload relays	Article No.
		kW	A			
<b>Sizes S00/S0<sup>2) 6)</sup></b>						
	S00/S0	0,09 ... 1,1	0,3 ... 3	20	3RB24	<b>3RB2906-2BG1</b> <b>3RB2906-2DG1</b>
		1,1 ... 11	2,4 ... 25	63		
<b>Sizes S2/S3<sup>2) 6)</sup></b>						
	S2/S3	5,5 ... 45	10 ... 100	315	3RB24	<b>3RB2906-2JG1</b>
<b>Size S6<sup>1) 6)</sup></b>						
	S6 with busbar connection	11 ... 90	20 ... 200	315	3RB24	<b>3RB2956-2TH2</b>
	For mounting onto S6 contactors with box terminals	11 ... 90	20 ... 200	315	3RB24	<b>3RB2956-2TG2</b>
<b>Sizes S10/S12<sup>1)</sup></b>						
	S10/S12 and size 14 (3TF68/ 3TF69)	37 ... 450	63 ... 630	800	3RB24	<b>3RB2966-2WH2</b>

##### Note:

The connecting cable between the current measuring module and the evaluation module is not included in the scope of supply; please order separately.

1) The current measuring modules with an Article No. ending with "2" are designed for mounting onto contactor and stand-alone installation. For 3TF68/3TF69 contactors, direct mounting is not possible.

2) The current measuring modules with an Article No. ending with "1" are designed for stand-alone installation.

3) Observe maximum rated operational current of the devices.

4) Guide value for 4-pole standard motors at 50 Hz 400 V AC. The actual starting and rated data of the motor to be protected must be considered when selecting the units.

5) Maximum protection by fuse only for overload relay, type of coordination "2". For fuse values in connection with contactors see Configuration Manuals

- "Configuring SIRIUS Innovations – Selection Data for Fuseless and Fused Load Feeders",  
<http://support.automation.siemens.com/WW/view/en/39714188>

- "SIRIUS Configuration – Selection Data for Fuseless Load Feeders",  
<http://support.automation.siemens.com/WW/view/en/40625241>.

6) The modules with an Article No. with "G" in penultimate position are equipped with a straight-through transformer.

##### Accessories

	Size contactor	Version	For overload relays	Article No.
<b>Connecting cables (necessary accessories)</b>				
	S00 ... S3	For connection between evaluation module and current measuring module	3RB24, 3RB29	<b>3RB2987-2B</b>
		• Length 0.1 m (only for mounting of the evaluation module directly onto the current measuring module)		
	S00 ... S12	• Length 0.5 m	3RB24, 3RB29	<b>3RB2987-2D</b>

Additional general accessories see page 5/32.



## Overview



### Overload relays for High-Feature applications

The following optional accessories are available for the 3RB24 solid-state overload relays:

- Operator panel for the 3RB24 evaluation modules
- Manual for the 3RB24 evaluation modules
- Sealable covers for the 3RB24 evaluation modules
- Terminal covers for the 3RB29 current measuring modules size S6 and S10/S12
- Box terminal blocks for the 3RB29 current measuring modules size S6 and S10/S12
- Push-in lugs for screw fixing for 3RB24 evaluation modules and 3RB2906 current measuring modules

## Selection and ordering data

### Accessories for 3RB24 overload relays

Version	For overload relays	Article No.
<b>Operator panels for evaluation modules</b>		
 3RA6935-0A <b>Operator panels (set)</b> One set comprises: • 1 x operator panel • 1 x 3RA6936-0A enabling module • 1 x 3RA6936-0B interface cover • 1 x fixing terminal <b>Note:</b> The connecting cable between the evaluation module and the operator panel is not included in the scope of supply; please order separately.	3RB24	<b>3RA6935-0A</b>
<b>Connecting cable</b> Length 2.5 m (round), for connecting the evaluation module to the operator panel	3RB24	<b>3UF7933-0BA00-0</b>
<b>Enabling modules (replacement)</b>	3RB24	<b>3RA6936-0A</b>
<b>Interface covers</b>	3RB24	<b>3RA6936-0B</b>
<b>Manuals</b>		
 Manual "Solid-State Overload Relay for IO-Link"	3RB24	
The manual can be downloaded free of charge in PDF format from the Internet, see <a href="http://support.automation.siemens.com/WW/view/en/46165627">http://support.automation.siemens.com/WW/view/en/46165627</a> .		

Additional general accessories see next page.

**IO-Link**

## SIRIUS 3RB24 solid-state overload relays for IO-Link

## Accessories

**Selection and ordering data** (continued)**General accessories**

Version	Size	For overload relays	Article No.
<b>Sealable covers for evaluation modules</b>			
 For covering the setting knobs	--	3RB24	<b>3RB2984-2</b>
3RB2984-2			



**Terminal covers for current measuring modules**

Version	Size	For overload relays	Article No.
<b>Covers for cable lugs and busbar connections</b>			
• Length 100 mm	S6	3RB2956	<b>3RT1956-4EA1</b>
• Length 120 mm	S10/S12	3RB2966	<b>3RT1966-4EA1</b>
<b>Covers for box terminals</b>			
• Length 25 mm	S6	3RB2956	<b>3RT1956-4EA2</b>
• Length 30 mm	S10/S12	3RB2966	<b>3RT1966-4EA2</b>
<b>Covers for screw terminals</b>			
between contactor and overload relay, without box terminals (1 unit required per combination)	S6	3RB2956	<b>3RT1956-4EA3</b>
	S10/S12	3RB2966	<b>3RT1966-4EA3</b>
3RT1956-4EA2			

**Box terminal blocks for current measuring modules**

Version	Size	For overload relays	Article No.
For round and ribbon cables			
• Up to 70 mm <sup>2</sup>	S6 <sup>1)</sup>	3RB2956	<b>3RT1955-4G</b>
• Up to 120 mm <sup>2</sup>	S6	3RB2956	<b>3RT1956-4G</b>
• Up to 240 mm <sup>2</sup>	S10/S12	3RB2966	<b>3RT1966-4G</b>
For technical specifications for conductor cross-sections see Reference Manual "Protection Equipment – 3RU1, 3RB2 Overload Relays", <a href="http://support.automation.siemens.com/WWW/view/en/35681297">http://support.automation.siemens.com/WWW/view/en/35681297</a> .			
3RT195-4G			

**Push-in lugs for evaluation modules and current measuring modules**

Version	Size	For overload relays	Article No.
 For screw fixing the evaluation modules	--	3RB24	<b>3RP1903</b>
3RP1903			
 For screw fixing the current measuring modules (2 units per module)	S00 ... S3	3RB2906	<b>3RB1900-0B</b>
3RB1900-0B			

<sup>1)</sup> In the scope of supply for 3RT1054-1 contactors (55 kW).

Version	Size	Color	For overload relays	Spring-type terminals Article No.
<b>Tools for opening spring-type terminals</b>				
 <b>Screwdrivers</b> For all SIRIUS devices with spring-type terminals	Length approx. 200 mm, 3.0 mm x 0.5 mm	Titanium gray/black, partially insulated	Main and auxiliary circuit connection: 3RB24	<b>3RA2908-1A</b>
3RA2908-1A				

**Blank labels**

Version	Size	Color	For overload relays	Article No.
 <b>Unit labeling plates<sup>1)</sup></b> for SIRIUS devices	20 mm x 7 mm	Pastel turquoise	3RB24	<b>3RT1900-1SB20</b>
	20 mm x 7 mm	Titanium gray	3RB24	<b>3RT2900-1SB20</b>
3RT1900-1SB20				
3RT2900-1SB20				

<sup>1)</sup> PC labeling system for individual inscription of unit labeling plates available from: murrplastik Systemtechnik GmbH (see Catalog IC 10, Chapter 16, "Appendix" ⇒ "External Partners").

## Overview

### Communications integration using IO-Link

The 3RA64/65 compact starters comply with IO-Link specification V1.0. Up to 4 compact starters in IO-Link version (reversing and direct-on-line starters) can be connected together and easily linked to the IO-Link master through a standardized IO-Link connection. The 4SI SIRIUS electronic module can be used, for example, as an IO-Link master for the connection to the SIMATIC ET 200S distributed I/O system.

The IO-Link connection enables a high density of information in the local range.

The diagnostics data of the process collected by the 3RA6 compact starter, e.g. short circuit, end of service life, limit position etc., are not only indicated on the compact starter itself but also transmitted to the higher-level control system through IO-Link.







Thanks to the optionally available operator panel, which can be installed in the control cabinet door, it is easy to control the 3RA6 compact starter with IO-Link from the control cabinet door.

### Note

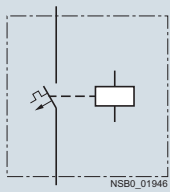
For general data about 3RA6 compact starters, see Chapter 4 "AS-Interface" ⇒ "3RA6 Compact Starters" ⇒ "General Data"

## Selection and ordering data

### 3RA64 direct-on-line starters

				<b>Rated control supply voltage 24 V DC</b> Width 45 mm Rated short-circuit current $I_{CS} = 53 \text{ kA}$ at 400 V A set of 3A6940-0A adapters is required for screw fixing.	
3RA64 with 3RA6911-1A auxiliary switch block		Direct-on-line start		NSB0_01946	
Standard three-phase motor 4-pole at 400 V AC <sup>1)</sup> Standard output $P$	Setting range for solid-state overload release	Instantaneous overcurrent release	<b>Screw terminals</b>	<b>Spring-type terminals</b>	
					
kW	A	A	<b>Article No.</b>	<b>Article No.</b>	

**For standard mounting rail or screw fixing, including 1 pair of main circuit terminals and 1 pair of control circuit terminals**



0.09	0.1 ... 0.4	56	<b>3RA6400-1AB42</b>	<b>3RA6400-2AB42</b>
0.37	0.32 ... 1.25	56	<b>3RA6400-1BB42</b>	<b>3RA6400-2BB42</b>
1.5	1 ... 4	56	<b>3RA6400-1CB42</b>	<b>3RA6400-2CB42</b>
5.5	3 ... 12	168	<b>3RA6400-1DB42</b>	<b>3RA6400-2DB42</b>
15	8 ... 32	448	<b>3RA6400-1EB42</b>	<b>3RA6400-2EB42</b>

**For use in the infeed system for 3RA6, without main circuit terminals with 1 pair of control circuit terminals**

0.09	0.1 ... 0.4	56	<b>3RA6400-1AB43</b>	<b>3RA6400-2AB43</b>
0.37	0.32 ... 1.25	56	<b>3RA6400-1BB43</b>	<b>3RA6400-2BB43</b>
1.5	1 ... 4	56	<b>3RA6400-1CB43</b>	<b>3RA6400-2CB43</b>
5.5	3 ... 12	168	<b>3RA6400-1DB43</b>	<b>3RA6400-2DB43</b>
15	8 ... 32	448	<b>3RA6400-1EB43</b>	<b>3RA6400-2EB43</b>

<sup>1)</sup> The actual starting and rated data of the motor to be protected must be considered when selecting the units.

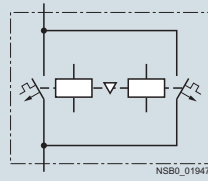
**IO-Link****SIRIUS 3RA6 compact starters****SIRIUS 3RA64, 3RA65 compact starters for IO-Link****Selection and ordering data** (continued)**3RA65 reversing starters**

 <p>3RA65 with 3RA6911-1A auxiliary switch blocks</p>		<p><b>Reversing duty</b></p>  <p>NSB0_01947</p>		<p><b>Rated control supply voltage 24 V DC</b></p> <p>Width 90 mm</p> <p>Rated short-circuit current <math>I_{CS} = 53 \text{ kA}</math> at 400 V</p> <p>Two sets of 3RA6940-0A adapters are required for screw fixing.</p>	
Standard three-phase motor 4-pole at 400 V AC <sup>1)</sup>	Setting range for solid-state overload release	Instantaneous overcurrent release	<b>Screw terminals</b>	<b>Spring-type terminals</b>	
Standard output $P$					
kW	A	A	<b>Article No.</b>	<b>Article No.</b>	

*For standard mounting rail or screw fixing, including 1 pair of main circuit terminals and 1 pair of control circuit terminals*

0.09	0.1 ... 0.4	56	<b>3RA6500-1AB42</b>	<b>3RA6500-2AB42</b>
0.37	0.32 ... 1.25	56	<b>3RA6500-1BB42</b>	<b>3RA6500-2BB42</b>
1.5	1 ... 4	56	<b>3RA6500-1CB42</b>	<b>3RA6500-2CB42</b>
5.5	3 ... 12	168	<b>3RA6500-1DB42</b>	<b>3RA6500-2DB42</b>
15	8 ... 32	448	<b>3RA6500-1EB42</b>	<b>3RA6500-2EB42</b>

*For use in the infeed system for 3RA6, without main circuit terminals with 1 pair of control circuit terminals*

0.09	0.1 ... 0.4	56	<b>3RA6500-1AB43</b>	<b>3RA6500-2AB43</b>
0.37	0.32 ... 1.25	56	<b>3RA6500-1BB43</b>	<b>3RA6500-2BB43</b>
1.5	1 ... 4	56	<b>3RA6500-1CB43</b>	<b>3RA6500-2CB43</b>
5.5	3 ... 12	168	<b>3RA6500-1DB43</b>	<b>3RA6500-2DB43</b>
15	8 ... 32	448	<b>3RA6500-1EB43</b>	<b>3RA6500-2EB43</b>

<sup>1)</sup> The actual starting and rated data of the motor to be protected must be considered when selecting the units.

## Overview

### Accessories for SIRIUS 3RA6 compact starters in IO-Link version



The following accessories are available specially for the 3RA64, 3RA65 compact starters:

- The 4SI SIRIUS electronic module as IO-Link master allows for the simple and economical connection of SIRIUS controls with IO-Link (e.g. up to four groups of 4 compact starters) to the multifunctional SIMATIC ET 200S distributed I/O system.
- Additional connection cables for side-by-side mounting of up to 4 compact starters
- Operator panel for on-site control and diagnostics of up to 4 compact starters coupled to each other

### Note

Accessories for all 3RA6 SIRIUS compact starters, see Chapter 4 "AS-Interface" ⇒ "3RA6 Compact Starters" ⇒ "Accessories"

## Selection and ordering data

Version	Article No.
<i>Accessories especially for 3RA64, 3RA65 compact starters for IO-Link</i>	
 <p>3RA6931-0A</p> <p><b>Additional connection cables (flat) for side-by-side mounting of up to 4 compact starters</b></p> <ul style="list-style-type: none"> <li>• 10-pole           <ul style="list-style-type: none"> <li>- 8 mm<sup>1)</sup></li> <li>- 200 mm<sup>1)</sup></li> </ul> </li> <li>• 14-pole           <ul style="list-style-type: none"> <li>- 8 mm<sup>2)</sup></li> <li>- 200 mm</li> </ul> </li> </ul>	<p><b>3RA6932-0A</b></p> <p><b>3RA6933-0B</b></p> <p><b>3RA6931-0A</b></p> <p><b>3RA6933-0C</b></p>
 <p>3RA6935-0A</p> <p><b>Operator panel</b> (incl. enabling module, blanking cover and mounting bracket)</p>	<p><b>3RA6935-0A</b></p>
<b>Enabling module</b>	<b>3RA6936-0A</b>
<b>Blanking cover</b>	<b>3RA6936-0B</b>
<b>Connection cable (round) for connecting the operator panel</b> 10-pole, 2 000 mm	<b>3RA6933-0A</b>

<sup>1)</sup> 10-pole connection cables are required for EMERGENCY-STOP group concepts.

<sup>2)</sup> Is included in the scope of supply of the SIRIUS 3RA6 compact starter in IO-Link version.

## IO-Link

### SIRIUS 3RR24 monitoring relays for mounting onto 3RT2 contactors for IO-Link

#### General data

#### Overview

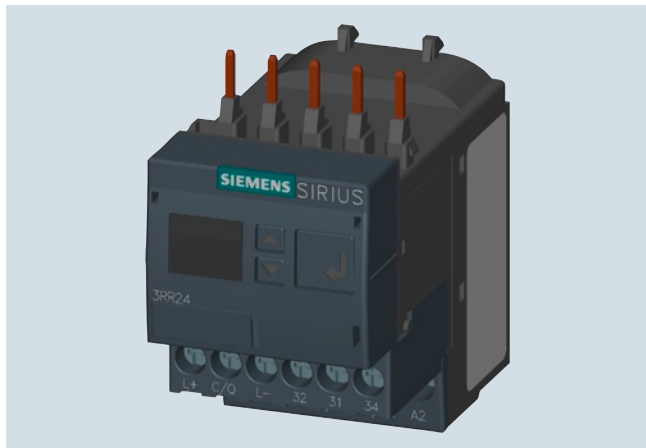

Features	3RR24	Benefits
<b>General data</b>		
<b>Sizes</b>		
Dimensions in mm (W x H x D)		<ul style="list-style-type: none"> <li>• Are coordinated with the dimensions, connections and technical characteristics of the other devices in the SIRIUS modular system (contactors, soft starters, etc.)</li> <li>• Permit the mounting of slim and compact load feeders in widths of 45 mm (S00 and S0)</li> <li>• Simplify configuration</li> </ul>
<ul style="list-style-type: none"> <li>• Screw terminals</li> <li>• Spring-type terminals</li> </ul>		
<b>Current range</b>	S00: 1.6 ... 16 A S0: 4 ... 40 A	<ul style="list-style-type: none"> <li>• Is adapted to the other devices in the SIRIUS modular system</li> <li>• Just a single version per size with a wide setting range enables easy configuration</li> </ul>
<b>Permissible ambient temperature</b> During operation	-25 ... +60 °C	<ul style="list-style-type: none"> <li>• Suitable for applications in the control cabinet, worldwide</li> </ul>
<b>Monitoring functions</b>		
<b>Current overshoot</b>	✓ (Three-phase)	<ul style="list-style-type: none"> <li>• Provides optimum inverse-time delayed protection of loads against excessive temperature rises due to overload</li> <li>• Enables detection of filter blockages or pumping against closed gate valves</li> <li>• Enables drawing conclusions about wear, poor lubrication or other maintenance-relevant phenomena</li> </ul>
<b>Current undershoot</b>	✓ (Three-phase)	<ul style="list-style-type: none"> <li>• Enables detection of overload due to a slipping or torn belt</li> <li>• Guarantees protection of pumps against dry running</li> <li>• Facilitates monitoring of the functions of resistive loads such as heaters</li> <li>• Permits energy savings through monitoring of no-load operation</li> </ul>
<b>Apparent current monitoring</b>	✓ (selectable)	<ul style="list-style-type: none"> <li>• Precision current monitoring especially in a motor's rated and upper torque range</li> </ul>
<b>Active current monitoring</b>	✓ (selectable)	<ul style="list-style-type: none"> <li>• Optimum current monitoring over a motor's entire torque range through the patented combination of power factor and apparent current monitoring</li> </ul>
<b>Range monitoring</b>	✓ (Three-phase)	<ul style="list-style-type: none"> <li>• Simultaneous monitoring of current overshoot and undershoot with a single device</li> </ul>
<b>Phase failure, open circuit</b>	✓ (Three-phase)	<ul style="list-style-type: none"> <li>• Minimizes heating of three-phase motors during phase failure through immediate disconnection</li> <li>• Prevents operation of hoisting equipment with reduced load carrying capacity</li> </ul>
<b>Phase sequence monitoring</b>	✓ (selectable)	<ul style="list-style-type: none"> <li>• Prevents starting of motors, pumps or compressors in the wrong direction of rotation</li> </ul>
<b>Internal ground-fault detection (residual current monitoring)</b>	✓ (selectable)	<ul style="list-style-type: none"> <li>• Provides optimum protection of loads against high-resistance short circuits or ground faults due to moisture, condensed water, damage to the insulation material, etc.</li> <li>• Eliminates the need for additional special equipment</li> <li>• Saves space in the control cabinet</li> <li>• Reduces wiring overhead and costs</li> </ul>
<b>Blocking current monitoring</b>	✓ (selectable)	<ul style="list-style-type: none"> <li>• Minimizes heating of three-phase motors when blocked during operation through immediate disconnection</li> <li>• Minimizes mechanical loading of the system by acting as an electronic shear pin</li> </ul>
<b>Operating hours counter</b>	✓	<ul style="list-style-type: none"> <li>• Gives the time during which there was a measurable current in at least 2 current paths</li> <li>• As an indicator for upcoming maintenance or replacement of machine and system components</li> </ul>
<b>Operating cycles counter</b>	✓	<ul style="list-style-type: none"> <li>• Is incremented by one each time a breaking operation is detected, in other words a transition from three-phase current flow to no measurable current flow</li> <li>• As an indicator for upcoming maintenance or replacement of contact blocks</li> </ul>

✓ Available

## Overview (continued)

Features	3RR24	Benefits
<b>Features</b>		
<b>RESET function</b>	✓	<ul style="list-style-type: none"> <li>Allows manual or automatic resetting of the relay</li> <li>Resetting directly on the device, by switching the control supply voltage off and on or via IO-Link (remote RESET)</li> </ul>
<b>ON-delay time</b>	0 ... 999.9 s	<ul style="list-style-type: none"> <li>Enables motor starting without evaluation of the starting current</li> <li>Can be used for monitoring motors with lengthy start-up</li> </ul>
<b>Tripping delay time</b>	0 ... 999.9 s	<ul style="list-style-type: none"> <li>Permits brief threshold value violations during operation</li> <li>Prevents frequent warnings and disconnections with currents near the threshold values</li> </ul>
<b>Operating and indicating elements</b>	Displays and buttons	<ul style="list-style-type: none"> <li>For setting the threshold values and delay times</li> <li>For selectable functions</li> <li>For quick and selective diagnostics</li> <li>Displays for permanent display of measured values</li> </ul>
<b>Integrated contacts</b>	1 CO contact, 1 semiconductor output (in SIO mode)	<ul style="list-style-type: none"> <li>Enable disconnection of the system or process when there is an irregularity</li> <li>Can be used to output signals</li> </ul>
<b>Design of load feeders</b>		
<b>Short-circuit strength up to 100 kA at 690 V</b> (in conjunction with the corresponding fuses or the corresponding motor starter protector)	✓	<ul style="list-style-type: none"> <li>Provides optimum protection of the loads and operating personnel in the event of short circuits due to insulation faults or faulty switching operations</li> </ul>
<b>Electrical and mechanical matching to 3RT2 contactors</b>	✓	<ul style="list-style-type: none"> <li>Simplifies configuration</li> <li>Reduces wiring outlay and costs</li> <li>Enables stand-alone installation as well as space-saving direct mounting</li> </ul>
<b>Spring-type terminals for main circuit and auxiliary circuits</b>	✓ (optional)	<ul style="list-style-type: none"> <li>Enables fast connections</li> <li>Permits vibration-resistant connections</li> <li>Enables maintenance-free connections</li> </ul>
<b>Other features</b>		
<b>Suitable for single- and three-phase loads</b>	✓	<ul style="list-style-type: none"> <li>Enables the monitoring of single-phase systems through parallel infeed at the contactor or looping the current through the three phase connections</li> </ul>
<b>Wide setting ranges</b>	✓	<ul style="list-style-type: none"> <li>Reduce the number of variants</li> <li>Minimize the configuration outlay and costs</li> <li>Minimize storage overheads, storage costs, tied-up capital</li> </ul>
<b>Power supply</b>	24 V DC	<ul style="list-style-type: none"> <li>Direct via IO-Link master or via an external auxiliary voltage independent of the IO-Link</li> <li>Minimizes the configuring overhead and costs</li> </ul>

✓ Available

## IO-Link

SIRIUS 3RR24 monitoring relays for mounting onto 3RT2 contactors for IO-Link

### General data

#### Overview (continued)

##### Possible combinations of 3RR24 monitoring relays with 3RT2 contactors for IO-Link

Monitoring relays	Current range	Contactors (type, size, rating)	
		3RT201	3RT202
Type	A	S00 3/4/5.5/7.5 kW	S0 5.5/7.5/11/15/18.5 kW
3RR2441	1.6 ... 16	✓	With stand-alone installation support
3RR2442	4 ... 40	With stand-alone installation support	✓

✓ Available

#### Notes:

Devices required for the communication via IO-Link:

- Any controller that supports the IO-Link (e.g. ET 200S with CPU or S7-1200), see Catalog ST 70 "Products for Totally Integrated Automation"
- IO-Link master (e.g. 4SI or 4SI IO-Link electronic module for SIMATIC ET200S or SM 1278 for S7-1200) see Catalog ST 70 "Products for Totally Integrated Automation"

Each monitoring relay requires an IO-Link channel.

#### Connection methods

Selection tables for the 3RR24 monitoring relays can be found on the following pages.



Screw terminals



Spring-type terminals

5

#### More information

Configuration Manual "Configuring SIRIUS Innovations – Selection Data for Fuseless and Fused Load Feeders" see <http://support.automation.siemens.com/WW/view/en/39714188>.

System Manual "Industrial Controls – SIRIUS Innovations" see <http://support.automation.siemens.com/WW/view/en/60311318>.

Manual "3UG48/3RR24 Monitoring Relays for IO-Link" see <http://support.automation.siemens.com/WW/view/en/54375430>.

#### Notes on safety:

System networking requires suitable protective measures (including network segmentation for IT security) in order to ensure safe plant operation, see [www.siemens.com/industrialsecurity](http://www.siemens.com/industrialsecurity).

More information about the subject of Industrial Security see [www.siemens.com/industrialsecurity](http://www.siemens.com/industrialsecurity).



## Overview

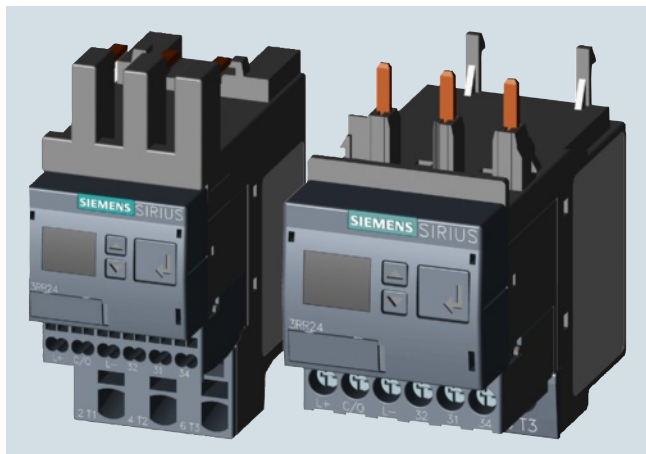

SIRIUS 3RR2441 and 3RR2442 current monitoring relay

The SIRIUS 3RR24 current monitoring relays for IO-Link are suitable for the load monitoring of motors or other loads. In three phases they monitor the rms value of AC currents for overshooting or undershooting of set threshold values.

Whereas apparent current monitoring is used above all in connection with the rated torque or in case of overload, the active current monitoring option, which is also selectable, can be used to observe and evaluate the load factor over a motor's entire torque range.

The 3RR24 current monitoring relays for IO-Link can be integrated directly in the feeder by mounting onto the 3RT2 contactor; separate wiring of the main circuit is therefore superfluous. No separate transformers are required.

For a line-oriented configuration or simultaneous use of an overload relay, terminal supports for stand-alone installation are available for separate standard rail mounting.

The SIRIUS 3RR24 current monitoring relays for IO-Link also offer many other options based upon the monitoring functions of the conventional SIRIUS 3RR2 monitoring relays:

- Measured value transmission to a controller, including resolution and unit, may be parameterizable as to which value is cyclically transmitted
- Transmission of alarm flags to a controller
- Full diagnosis capability by inquiry as to the cause of the fault in the diagnosis data record
- Remote parameterization is also possible, in addition to or instead of local parameterization
- Rapid parameterization of the same devices by duplication of the parameterization in the controller
- Parameter transmission by upload to a controller by IO-Link call or by parameter server (if IO-Link master from IO-Link Specification V 1.1 and higher is used)
- Consistent central data storage in the event of parameter change locally or via a controller
- Automatic reparameterizing when devices are exchanged
- Blocking of local parameterization via IO-Link possible
- Faults are saved in parameterizable and non-volatile fashion to prevent an automatic start-up after voltage failure and to make sure diagnostics data is not lost
- By integration into the automation level the option exists of parameterizing the monitoring relay at any time via a display unit or displaying the measured values in a control room or locally at the machine/control cabinet.

Even without communication via IO-Link the devices continue to function fully autonomously:

- Parameterization can take place locally at the device, independently of a controller.
- In the event of failure or before the controller becomes available the monitoring relays work as long as the control supply voltage (24 V DC) is present.
- If the monitoring relays are operated without the controller, the 3RR24 monitoring relays for IO-Link have, thanks to the integrated SIO mode, an additional semiconductor output, which switches when the adjustable warning threshold is exceeded.

Thanks to the combination of autonomous monitoring relay function and integrated IO-Link communication, redundant sensors and/or analog signal converters – which previously took over the transmission of measured values to a controller, leading to considerable extra cost and wiring outlay – are no longer needed.

Because the output relays are still present, the monitoring relays increase the functional reliability of the system, since the controller can only fulfill the control tasks if the current measured values are available, whereas the output relays can also be used for the disconnection of the system if limit values that cannot be reached during operation are exceeded.

For further information on the IO-Link communication system, see page 5/2 onwards.

## IO-Link

### SIRIUS 3RR24 monitoring relays for mounting onto 3RT2 contactors for IO-Link

#### Current and active current monitoring

##### Benefits

- Can be mounted directly on 3RT2 contactors and 3RA23 reversing contactor assemblies, in other words, there is no need for additional wiring in the main circuit
- Optimally coordinated with the technical characteristics of the 3RT2 contactors
- No separate current transformer required
- Variably adjustable to overshoot, undershoot or range monitoring
- Freely configurable delay times and RESET response
- Display of ACTUAL value and status messages
- All versions with removable control current terminals
- All versions with screw or spring-type terminals
- Simple determination of the threshold values through direct reference to actually measured values for setpoint loading
- Range monitoring and selectable active current measurement mean that only one device for monitoring a motor is required along the entire torque curve
- In addition to current monitoring it is also possible to monitor for current unbalance, broken cables, phase failure, phase sequence, residual current and motor blocking.
- Integrated counter for operating cycles counter and operating hours to support requirements-based maintenance of the monitored machine or application
- Simple cyclical transmission of the current measured values, relay switching states and events to a controller
- Remote parameterization
- Automatic reparameterizing when devices are exchanged
- Simple duplication of identical or similar parameterizations
- Reduction of control current wiring
- Elimination of testing costs and wiring errors
- Reduction of configuration work
- Integration in TIA means clear diagnostics if a fault occurs
- Cost saving and space saving in control cabinet due to the elimination of AI and IO modules as well as analog signal converters and duplicated sensors

##### Application

- Monitoring of current overshoot and undershoot
- Monitoring of broken conductors
- Monitoring of no-load operation and load shedding, e.g. in the event of a torn V-belt or no-load operation of a pump
- Monitoring of overload, e.g. on pumps due to a dirty filter system
- Monitoring the functionality of electrical loads such as heaters
- Monitoring of wrong phase sequence on mobile equipment such as compressors or cranes
- Monitoring of high-impedance short-circuits, e. g. due to damaged insulation or moisture

The use of SIRIUS monitoring relays for IO-Link is particularly recommended for machines and plant in which these relays, in addition to their monitoring function, are to be connected to the automation level for the rapid, simple and fault-free provision of the current measured values and/or for remote parameterization.

The monitoring relays can either relieve the controller of monitoring tasks or, as a second monitoring entity in parallel to and independent of the controller, increase the reliability in the process or in the system. In addition, the elimination of AI and IO modules allows the width of the controller to be reduced despite significantly expanded functionality.





## SIRIUS 3RR24 monitoring relays for mounting onto 3RT2 contactors for IO-Link

## Current and active current monitoring



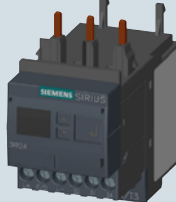
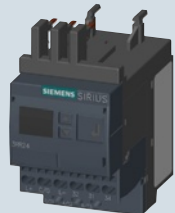



## Selection and ordering data

**SIRIUS 3RR24 current monitoring relays for IO-Link**

- For load monitoring of motors or other loads
- Multi-phase monitoring of undercurrent and overcurrent
- Starting and tripping delay can be adjusted separately
- Tripping delay 0 to 999.9 s
- Auto or Manual RESET

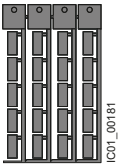
   					
Size	Measuring range	Hysteresis	Control supply voltage $U_s$	Screw terminals 	Spring-type terminals 
	A	A	V	Article No.	Article No.
Digitally adjustable, LCD, open-circuit or closed-circuit principle, 1 CO, 1 semiconductor output (in SIO mode), 3-phase current monitoring, active current or apparent current monitoring, current unbalance monitoring, phase sequence monitoring, residual current monitoring, blocking current monitoring, operating hours counter, operating cycles counter, reclosing delay time 0 ... 999.9 min, start-up delay 0 ... 999.9 s, separate settings for warning and alarm thresholds					
<b>S00</b>	1.6 ... 16	0.1 ... 3	24 DC	<b>3RR2441-1AA40</b>	<b>3RR2441-2AA40</b>
<b>S0</b>	4 ... 40	0.1 ... 8	24 DC	<b>3RR2442-1AA40</b>	<b>3RR2442-2AA40</b>

**IO-Link****SIRIUS 3RR24 monitoring relays for mounting onto 3RT2 contactors for IO-Link****Current and active current monitoring****Accessories**

	Use	Version	Size	Article No.
<b>Terminal supports for stand-alone installation<sup>1)</sup></b>				
 3RU2916-3AA01	For 3RR24	For separate mounting of the overload relays or monitoring relays; screw and snap-on mounting onto TH 35 standard mounting rail according to IEC 60715	<ul style="list-style-type: none"> <li>Screw connection</li> </ul>	<b>Screw terminals</b>  3RU2916-3AA01 3RU2926-3AA01
				<ul style="list-style-type: none"> <li>Spring-type connection</li> </ul>
<b>Blank labels</b>				
 3RT2900-1SB20	For 3RR24	<b>Unit labeling plates<sup>2)</sup></b> For SIRIUS devices 20 mm x 7 mm, titanium gray		3RT2900-1SB20
<b>Sealable covers</b>				
 3RR2940	For 3RR24	<b>Sealable covers</b> For securing against unintentional or unauthorized adjustment of settings		3RR2940
<b>Tools for opening spring-type terminals</b>				
 3RA2908-1A	For auxiliary circuit connections	<b>Screwdrivers</b> For all SIRIUS devices with spring-type terminals, 3.0 mm x 0.5 mm, length approx. 200 mm, titanium gray/black, partially insulated		<b>Spring-type terminals</b>  3RA2908-1A

<sup>1)</sup> The accessories are identical to those of the 3RU21 thermal overload relays and the 3RB3 solid-state overload relays, see Catalog IC 10, Chapter 7 "Protection Equipment".

<sup>2)</sup> PC labeling system for individual inscription of unit labeling plates available from: murrplastik Systemtechnik GmbH see Catalog IC 10, Chapter 16, "Appendix" ⇒ "External Partners".

## Overview



SIRIUS 3UG48 monitoring relays

The SIRIUS 3UG4 monitoring relays for electronic and mechanical variables monitor all important characteristics that allow conclusions to be drawn about the functionality of a plant. Both sudden disturbances and gradual changes, which may indicate the need for maintenance, are detected.

Thanks to their relay outputs, the monitoring relays permit direct disconnection of the affected system components as well as alerting e.g. by triggering a warning light. Thanks to adjustable delay times the 3UG4 monitoring relays can respond very flexibly to brief faults such as voltage dips or load changes and can thus avoid unnecessary alarms and disconnections and increase system availability.

### 3UG48 monitoring relays for IO-Link

The SIRIUS 3UG48 monitoring relays for IO-Link also offer many other options based upon the monitoring functions of the tried-and-tested SIRIUS 3UG4 monitoring relays:

- Measured value transmission to a controller, including resolution and unit, may be parameterizable as to which value is cyclically transmitted
- Transmission of alarm flags to a controller
- Full diagnosis capability by inquiry as to the cause of the fault in the diagnosis data record
- Remote parameterization is also possible, in addition to or instead of local parameterization
- Rapid parameterization of the same devices by duplication of the parameterization in the controller
- Parameter transmission by upload to a controller by IO-Link call or by parameter server (if IO-Link master from IO-Link Specification V 1.1 and higher is used)
- Consistent central data storage in the event of parameter change locally or via a controller
- Automatic reparameterizing when devices are exchanged
- Blocking of local parameterization via IO-Link possible
- Faults are saved in parameterizable and non-volatile fashion to prevent an automatic start-up after voltage failure and to make sure diagnostics data is not lost
- Integration into the automation level provides the option of parameterizing the monitoring relays at any time via a display unit, or displaying the measured values in a control room or locally at the machine/control cabinet.

Even without communication via IO-Link the devices continue to function fully autonomously:

- Parameterization can take place locally at the device, independently of a controller.
- In the event of failure or before the controller becomes available the monitoring relays work as long as the control supply voltage (24 V DC) is present.
- If the monitoring relays are operated without the controller, the 3UG48 monitoring relays have, thanks to the integrated SIO mode, an additional semiconductor output, which switches when the adjustable warning threshold is exceeded.

Thanks to the combination of autonomous monitoring relay function and integrated IO-Link communication, redundant sensors and/or analog signal converters – which previously took over the transmission of measured values to a controller, leading to considerable extra cost and wiring outlay – are no longer needed.

Because the output relays are still present, the monitoring relays increase the functional reliability of the system, since the controller can only fulfill the control tasks if the current measured values are available, whereas the output relays can also be used for the disconnection of the system if limit values that cannot be reached during operation are exceeded.

The individual 3UG48 monitoring relays for IO-Link offer the following functions in different combinations:

- Phase sequence
- Phase failure, neutral conductor failure
- Phase asymmetry
- Undershooting and/or overshooting of limit values for voltage
- Undershooting and/or overshooting of limit values for current
- Undershooting and/or overshooting of power factor limit values
- Monitoring of the active current or the apparent current
- Monitoring of the residual current
- Undershooting and/or overshooting of limit values for speed

#### Note:

Further information on the IO-Link bus system see page 5/2 onwards.

#### Notes on safety:

System networking requires suitable protective measures (including network segmentation for IT security) in order to ensure safe plant operation.

More information about the subject of Industrial Security see [www.siemens.com/industrialsecurity](http://www.siemens.com/industrialsecurity).

**IO-Link**

## SIRIUS 3UG48 monitoring relays for stand-alone installation for IO-Link

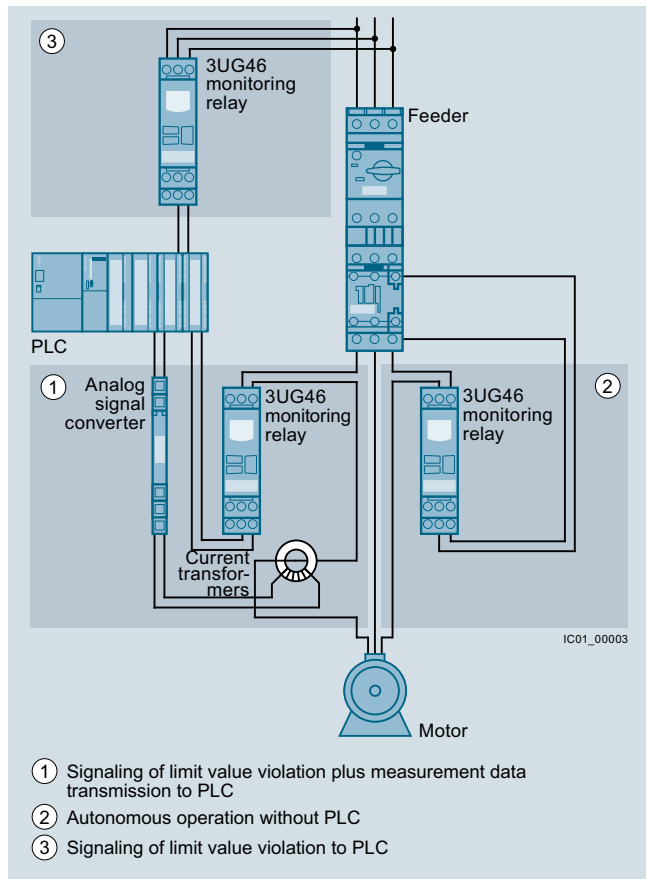
**General data****Overview** (continued)

Use of conventional monitoring relays

**Notes:**

Devices required for the communication via IO-Link:

- Any controller that supports the IO-Link (e.g. ET 200S with CPU or S7-1200), see Catalog ST 70 "Products for Totally Integrated Automation"
- IO-Link master (e.g. 4SI or 4SI IO-Link electronic module for SIMATIC ET200S or SM 1278 for S7-1200) see Catalog ST 70 "Products for Totally Integrated Automation"

Each monitoring relay requires an IO-Link channel.

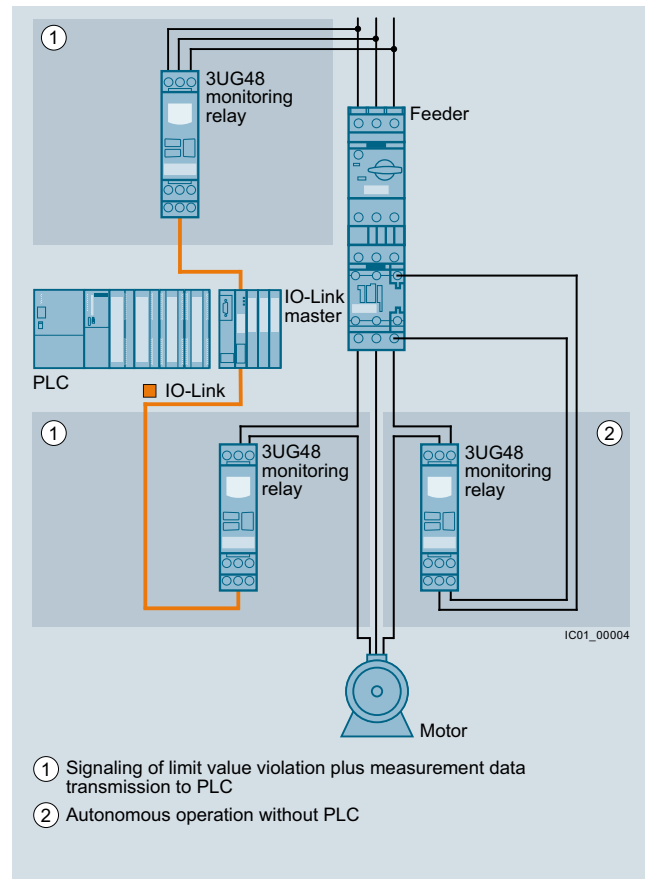

Monitoring relays for IO-Link

**Connection methods**

Selection tables for the 3UG48 monitoring relays can be found on the following pages.

- ⊕ Screw terminals
- ∞ Spring-type terminals

**Benefits**

- Simple cyclical transmission of the current measured values, relay switching states and events to a controller
- Remote parameterization
- Automatic reparameterizing when devices are exchanged
- Simple duplication of identical or similar parameterizations
- Reduction of control current wiring
- Elimination of testing costs and wiring errors
- Reduction of configuration work
- Integration in TIA means clear diagnostics if a fault occurs
- Cost saving and space saving in control cabinet due to the elimination of AI and IO modules as well as analog signal converters and duplicated sensors

**Application**

The use of SIRIUS monitoring relays for IO-Link is particularly recommended for machines and plant in which these relays, in addition to their monitoring function, are to be connected to the automation level for the rapid, simple and fault-free provision of the current measured values and/or for remote parameterization.

The monitoring relays can either relieve the controller of monitoring tasks or, as a second monitoring entity in parallel to and independent of the controller, increase the reliability in the process or in the system. In addition, the elimination of AI and IO modules allows the width of the controller to be reduced despite significantly expanded functionality.

**More information**

Manual "3UG48/3RR24 Monitoring Relays for IO-Link" see <http://support.automation.siemens.com/WW/view/en/54375430>.

**Notes on safety:**

System networking requires suitable protective measures (including network segmentation for IT security) in order to ensure safe plant operation.

More information about the subject of Industrial Security see [www.siemens.com/industrialsecurity](http://www.siemens.com/industrialsecurity).

## IO-Link

### SIRIUS 3UG48 monitoring relays for stand-alone installation for IO-Link

#### Line monitoring

#### Overview



SIRIUS 3UG4815 monitoring relay

Solid-state line monitoring relays provide maximum protection for mobile machines, plants and hoisting equipment or for unstable networks. Network and voltage faults can thus be detected early and rectified before far greater damage ensues.

The line monitoring relays with IO-Link monitor phase sequence, phase failure (with or without N conductor monitoring), phase asymmetry and undervoltage and/or overvoltage.

Phase asymmetry is evaluated as the difference between the greatest and the smallest phase voltage relative to the greatest phase voltage. Undervoltage or overvoltage exist if the set limit values for at least one phase voltage are overshot or undershot. The rms value of the voltage is measured.

#### Benefits

- Can be used in any network from 160 to 630 V AC worldwide thanks to wide voltage range
- Variably adjustable to overshoot, undershoot or range monitoring
- Freely configurable delay times and RESET response
- Width 22.5 mm
- Display and transmission of actual value and network fault type to controller
- All versions with removable terminals
- All versions with screw or spring-type terminals

#### Application

The relays are used above all for mobile equipment, e.g. air conditioning compressors, refrigerating containers, building site compressors and cranes.

Function	Application
Phase sequence	• Direction of rotation of the drive
Phase failure	• A fuse has tripped • Failure of the control supply voltage • Broken cable
Phase asymmetry	• Overheating of the motor due to asymmetrical voltage • Detection of asymmetrically loaded networks
Undervoltage	• Increased current on a motor with corresponding overheating • Unintentional resetting of a device • Network collapse, particularly with battery power
Overvoltage	• Protection of a plant against destruction due to overvoltage

#### Selection and ordering data

- Adjustable via IO-Link and locally, with illuminated LCD
- Power supply with 24 V DC via IO-Link or external auxiliary voltage
- Auto or Manual RESET
- Open or closed-circuit principle
- 1 CO contact, 1 semiconductor output (in SIO mode)

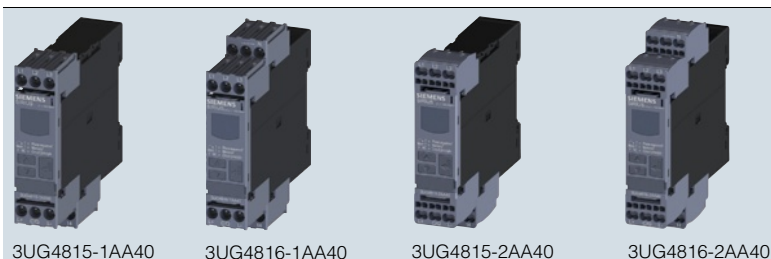

3UG4815-1AA40	3UG4816-1AA40	3UG4815-2AA40	3UG4816-2AA40	Adjustable hysteresis	Under-voltage detection	Over-voltage detection	Stabilization time adjustable sDEL	Tripping delay time adjustable Del	Version of auxiliary contacts	Measurable mains voltage <sup>1)</sup>	Screw terminals	Spring-type terminals
				V			s	s		V AC	Article No.	Article No.

#### Monitoring of phase sequence, phase failure, phase asymmetry, overvoltage and undervoltage

1 ... 20	✓	✓	0.1 ... 999.9	0.1 ... 999.9	1 CO + 1 Q <sup>2)</sup>	160 ... 690	<b>3UG4815-1AA40</b>	<b>3UG4815-2AA40</b>
----------	---	---	---------------	---------------	--------------------------	-------------	----------------------	----------------------

#### Monitoring of phase sequence, phase and N conductor failure, phase asymmetry, overvoltage and undervoltage

1 ... 20	✓	✓	0.1 ... 999.9	0.1 ... 999.9	1 CO + 1 Q <sup>2)</sup>	90 ... 400 to N	<b>3UG4816-1AA40</b>	<b>3UG4816-2AA40</b>
----------	---	---	---------------	---------------	--------------------------	-----------------	----------------------	----------------------

✓ Function available

<sup>1)</sup> Absolute limit values.

<sup>2)</sup> In SIO mode.

For accessories see page 5/53.



## Overview

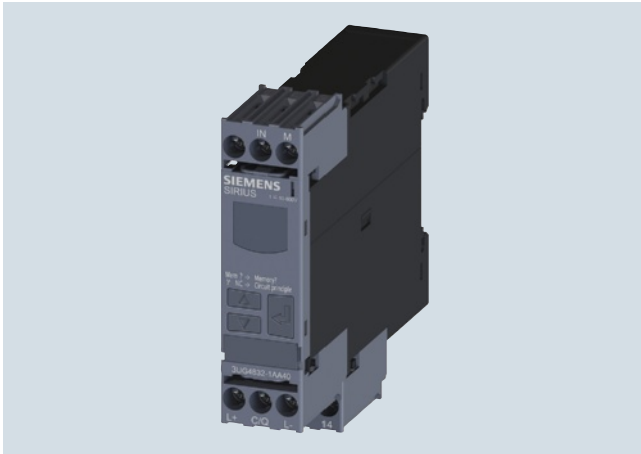

SIRIUS 3UG4832 monitoring relays

The relays monitor single-phase AC voltages (rms value) and DC voltages against the set limit value for overshoot and undershoot.

## Benefits



- Variably adjustable to overshoot, undershoot or range monitoring
- Freely configurable delay times and RESET response
- Width 22.5 mm
- Display and transmission of actual value and status messages to controller
- All versions with removable terminals
- All versions with screw or spring-type terminals

## Application

- Protection of a plant against destruction due to overvoltage
- Switch-on of a plant at a defined voltage and higher
- Protection from undervoltage due to overloaded control supply voltages, particularly with battery power

## Selection and ordering data

- Adjustable via IO-Link and locally, with illuminated LCD
- Power supply with 24 V DC via IO-Link or external auxiliary voltage
- Auto or Manual RESET
- Open or closed-circuit principle
- 1 CO contact, 1 semiconductor output (in SIO mode)

Measuring range	Adjustable hysteresis	ON-delay time adjustable onDel	Tripping delay time separately adjustable U $\blacktriangle$ Del/U $\blacktriangledown$ Del	3UG4832-1AA40	3UG4832-2AA40
V AC/DC	V	s	s	<b>Screw terminals</b> 	<b>Spring-type terminals</b> 
<b>Monitoring of voltage for overshoot and undershoot</b>				<b>Article No.</b>	<b>Article No.</b>
10 ... 600	0.1 ... 300	0 ... 999.9	0 ... 999.9	<b>3UG4832-1AA40</b>	<b>3UG4832-2AA40</b>

For accessories see page 5/53.

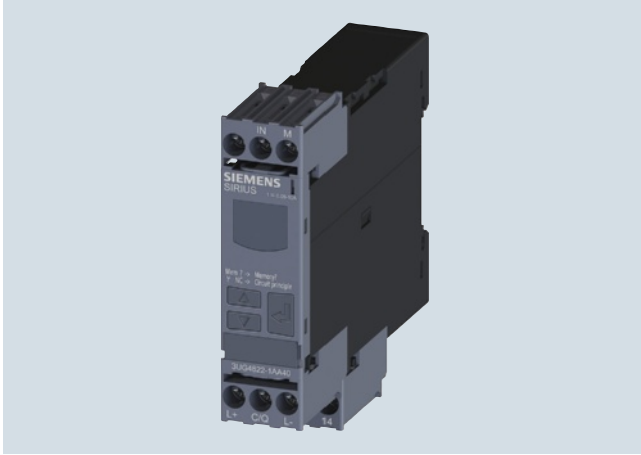
**IO-Link****SIRIUS 3UG48 monitoring relays for stand-alone installation for IO-Link****Current monitoring****Overview**

SIRIUS 3UG4822 monitoring relays

The relays monitor single-phase AC (rms value) and DC currents against the set limit value for overshoot and undershoot.

**Benefits**

- Variably adjustable to overshoot, undershoot or range monitoring
- Freely configurable delay times and RESET response
- Width 22.5 mm
- Display and transmission of actual value and status messages to controller
- All versions with removable terminals
- All versions with screw or spring-type terminals

**Application**

- Overcurrent and undercurrent monitoring
- Monitoring the functionality of electrical loads
- Monitoring for broken conductors

**Selection and ordering data**

- Adjustable via IO-Link and locally, with illuminated LCD
- Power supply with 24 V DC via IO-Link or external auxiliary voltage
- Adjustable converter factor to display the measured primary current when external current transformer used
- Auto or Manual RESET
- Open or closed-circuit principle
- 1 CO contact, 1 semiconductor output (in SIO mode)



3UG4822-1AA40



3UG4822-2AA40

Measuring range	Adjustable hysteresis	ON-delay time adjustable onDel	Tripping delay time separately adjustable U▲Del/L▼Del	Screw terminals	Spring-type terminals
AC/DC A	A	s	s	⊕	∞
				Article No.	Article No.

**Monitoring of current for overshooting and undershooting**

0.05 ... 10	0.01 ... 5	0.1 ... 999.9	0.1 ... 999.9
-------------	------------	---------------	---------------

**3UG4822-1AA40****3UG4822-2AA40**

For accessories see page 5/53.

For AC currents  $I > 10$  A it is possible to use commercially available current transformers, e.g. the Siemens 4NC current transformer, as accessories, see Catalog LV 10, "Low-Voltage Power Distribution and Electrical Installation Technology".

## Overview

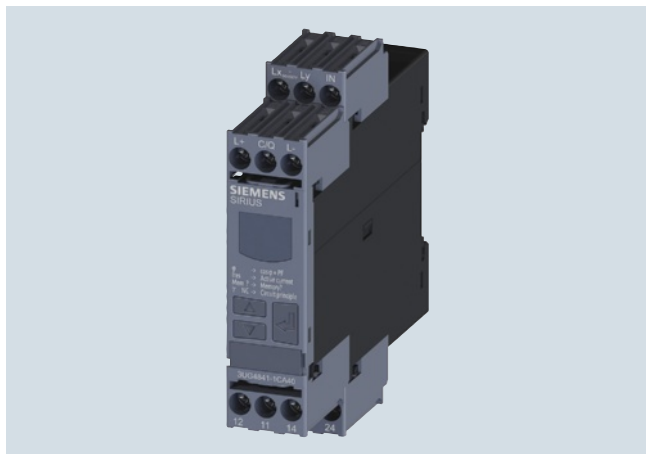

SIRIUS 3UG4841 monitoring relay

The 3UG4841 power factor and active current monitoring devices enable the load monitoring of motors.

Whereas power factor monitoring is used above all for monitoring no-load operation, the active current monitoring option can be used to observe and evaluate the load factor over the entire torque range.

## Benefits

- Monitoring of even small single-phase motors with a no-load supply current below 0.5 A
- Simple determination of threshold values by the direct collection of measured variables on motor loading
- Range monitoring and active current measurement enable detection of cable breaks between control cabinets and motors, as well as phase failures
- Power factor and/or  $I_{res}$  (active current) can be selected as the measurement principle
- Width 22.5 mm
- Display and transmission of actual value and status messages to controller
- All versions with removable terminals
- All versions with screw or spring-type terminals

## Application

- No-load monitoring and load shedding, such as in the event of a V-belt tear
- Underload monitoring in the low performance range, e.g. in the event of pump no-load operation
- Monitoring of overload, e.g. due to a dirty filter system
- Power factor monitoring in networks for control of compensation equipment
- Broken cable between control cabinet and motor

## Selection and ordering data



- For monitoring the power factor  $\varphi$  and the active current  $I_{res}$
- Suitable for single- and three-phase currents
- Adjustable via IO-Link and locally, with illuminated LCD
- Power supply with 24 V DC via IO-Link or external auxiliary voltage
- Overshoot, undershoot or range monitoring adjustable
- Upper and lower limit values can be adjusted separately
- Permanent display of actual value and tripping state
- 1 CO contact each for undershoot and overshoot, 1 semiconductor output (in SIO mode)



3UG4841-1CA40



3UG4841-2CA40

Measuring range		Voltage range of the measuring voltage <sup>1)</sup>	Hysteresis		ON-delay time adjustable onDel	Tripping delay time adjustable $U\blacktriangle\text{Del}/U\blacktriangledown\text{Del}$ , $\varphi\blacktriangle\text{Del}/\varphi\blacktriangledown\text{Del}$	<b>Screw terminals</b> 	<b>Spring-type terminals</b> 
For power factor	For active current $I_{res}$	50/60 Hz AC	Adjustable for power factor	Adjustable for active current $I_{res}$	s	s	<b>Article No.</b>	<b>Article No.</b>
P.f.	A	V	P.f.	A				

### Monitoring of power factor and active current for overshooting and undershooting

0.1 ... 0.99	0.2 ... 10	90 ... 690	0.1 ... 0.2	0.1 ... 3	0 ... 999.9	0 ... 999.9
--------------	------------	------------	-------------	-----------	-------------	-------------

3UG4841-1CA40

3UG4841-2CA40

<sup>1)</sup> Absolute limit values.

For accessories see page 5/53.

For AC active currents  $I_{res} > 10$  A it is possible to use commercially available current transformers, e.g. Siemens 4NC current converter, as accessories, see Catalog LV 10 "Low-Voltage Power Distribution and Electrical Installation Technology".

## IO-Link

SIRIUS 3UG48 monitoring relays for stand-alone installation for IO-Link  
Residual current monitoring

### Residual-current monitoring relays

#### Overview



SIRIUS 3UG4825 monitoring relay

The 3UG4825 residual-current monitoring relays are used in conjunction with the 3UL23 residual current transformers for monitoring plants in which higher residual currents are increasingly expected due to environmental conditions. Monitoring encompasses pure AC residual currents or AC residual currents with a pulsating DC fault current component (transformer type A in accordance with DIN VDE 0100-530/IEC TR 60755).

#### Benefits





- High measuring accuracy  $\pm 7.5\%$
- Permanent self-monitoring
- Parameterization of the devices locally or via IO-Link possible
- Variable threshold values for warning and disconnection
- Freely configurable delay times and RESET response
- Display and transmission of actual value and status messages to controller
- High level of flexibility and space saving through installation of the transformer inside or outside the control cabinet
- Width 22.5 mm
- All versions with removable terminals
- All versions with screw or spring-type terminals

#### Application

Monitoring of plants in which residual currents can occur, e.g. due to dust deposits or moisture, porous cables and leads, or capacitive residual currents

#### Selection and ordering data

- For monitoring residual currents from 0.03 to 40 A, from 16 to 400 Hz
- For 3UL23 residual-current transformers with feed-through opening from 35 to 210 mm
- Permanent self-monitoring
- Certified in accordance with IEC 60947, functionality corresponds to IEC 62020
- Digitally adjustable, with illuminated LCD
- Permanent display of actual value and tripping state
- Separately adjustable limit value and warning threshold
- 1 changeover contact each for warning threshold and tripping threshold

						
					3UG4825-1CA40	3UG4825-2CA40
Measurable current	Adjustable response value current	Switching hysteresis	Adjustable response delay time	Control supply voltage At DC, rated value	<b>Screw terminals</b>	<b>Spring-type terminals</b>
A	A	%	s	V		
0.01 ... 43	0.03 ... 40	0 ... 50	0 ... 999.9	24	<b>Article No.</b>	<b>Article No.</b>
					<b>3UG4825-1CA40</b>	<b>3UG4825-2CA40</b>

For accessories see page 5/53.

3UL23 residual-current transformers and accessories for 3UL23 see page 5/51.

SIRIUS 3UG48 monitoring relays for stand-alone installation for IO-Link  
Residual current monitoring

## 3UL23 residual-current transformers

## Overview



SIRIUS 3UL23 residual-current transformer

The 3UL23 residual-current transformers detect residual currents in machines and plants. They are suitable for pure AC residual currents or AC residual currents with a pulsating DC fault current component (transformer type A in accordance with DIN VDE 0100-530/IEC TR 60755).

Together with the 3UG4625, 3UG4825 residual-current monitoring relays for IO-Link or the SIMOCODE 3UF motor management and control device they enable residual-current and ground-fault monitoring.

The 3UL2302-1A and 3UL2303-1A residual-current transformers with a feed-through opening from 35 to 55 mm can be mounted in conjunction with the 3UL2900 accessories on a TH 35 standard mounting rail according to IEC 60715.

## Selection and ordering data

Diameter of the feed-through opening mm	Connectable cross-section of the connecting terminal mm <sup>2</sup>	Screw terminals Article No.
<i>Residual-current transformer (essential accessory for 3UG4625, 3UG4825 or SIMOCODE 3UF)</i>		
35	2.5	3UL2302-1A
55	2.5	3UL2303-1A
80	2.5	3UL2304-1A
110	2.5	3UL2305-1A
140	2.5	3UL2306-1A
210	4	3UL2307-1A

## Accessories

Version	Article No.
<b>Adapter</b>  <b>Adapter</b> For mounting onto standard rail for 3UL23 to diameter 55 mm	3UL2900

3UL2900

## IO-Link

### SIRIUS 3UG48 monitoring relays for stand-alone installation for IO-Link

#### Speed monitoring

##### Overview



SIRIUS 3UG4851 monitoring relay

3UG4851 monitoring relays are used in combination with a sensor to monitor drives for overspeed and/or underspeed.

Furthermore, the monitoring relays are ideal for all functions where a continuous pulse signal needs to be monitored (e.g. belt travel monitoring, completeness monitoring, passing monitoring, clock-time monitoring).

##### Benefits

- Variably adjustable to overshoot, undershoot or range monitoring
- Freely configurable delay times and RESET response
- Display and transmission of actual value and fault type to controller
- Use of up to 10 sensors per rotation for extremely slowly rotating motors
- 2- or 3-wire sensors and sensors with a mechanical switching output or solid-state-output can be connected
- Auxiliary voltage for sensor integrated
- All versions with removable terminals
- All versions with screw or spring-type terminals

##### Application

- Slip or tear of a belt drive
- Overload monitoring
- Transport monitoring for completeness

5

##### Selection and ordering data

- For speed monitoring in revolutions per minute (rpm)
- Two- or three-wire sensor with mechanical or electronic switching output can be connected
- Two-wire NAMUR sensor can be connected
- Sensor supply 24 V DC/50 mA integrated
- Input frequency 0.1 to 2 200 pulses per minute (0.0017 to 36.7 Hz)
- With or without enable signal for the drive to be monitored
- Adjustable via IO-Link and locally, with illuminated LCD
- Power supply with 24 V DC via IO-Link or external auxiliary voltage
- Overshoot, undershoot or range monitoring adjustable
- Number of pulses per revolution can be adjusted
- Upper and lower limit values can be adjusted separately
- Auto, manual or remote RESET options after tripping
- Permanent display of actual value and tripping state
- 1 CO contact, 1 semiconductor output (in SIO mode)



3UG4851-1AA40



3UG4851-2AA40

Measuring range	Adjustable hysteresis	ON-delay time adjustable onDel	Tripping delay time separately adjustable rpm▲Del/rpm▼Del	Pulses per revolution	Screw terminals	Spring-type terminals
rpm	rpm	s	s		Article No.	Article No.

##### Speed monitoring for overshooting and undershooting



0.1 ... 2 200	OFF 1 ... 99.9	0 ... 999.9	0 ... 999.9	1 ... 10
---------------	-------------------	-------------	-------------	----------

**3UG4851-1AA40**

**3UG4851-2AA40**

For accessories see page 5/53.

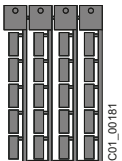
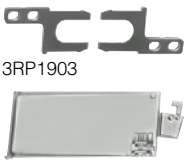
## Selection and ordering data

	Use	Version	Article No.
<b>Blank labels</b>			
 3RT29 00-1SB20	For 3UG48	<b>Unit labeling plates</b> For SIRIUS devices 20 mm x 7 mm, titanium gray <sup>1)</sup>	<b>3RT29 00-1SB20</b>
	For 3UG48	<b>Adhesive labels</b> For SIRIUS devices 19 mm x 6 mm, pastel turquoise 19 mm x 6 mm, zinc yellow	<b>3RT1900-1SB60</b> <b>3RT1900-1SD60</b>
<b>Push-in lugs and covers</b>			
 3RP1903 3RP1902	For 3UG48	<b>Push-in lugs</b> For screw fixing, 2 units are required for each device	<b>3RP1903</b>
	For 3UG48	<b>Sealable covers</b> For securing against unauthorized adjustment of setting knobs	<b>3RP1902</b>
<b>Tools for opening spring-type terminals</b>			
 3RA2908-1A	For auxiliary circuit connections	<b>Screwdrivers</b> For all SIRIUS devices with spring-type terminals 3.0 mm x 0.5 mm, length approx. 200 mm, titanium gray/black, partially insulated	<b>Spring-type terminals</b>  <b>3RA2908-1A</b>

<sup>1)</sup> PC labeling system for individual inscription of unit labeling plates available from: murrplastik Systemtechnik GmbH see Catalog IC 10, Chapter 16, "Appendix" ⇒ "External Partners".

## IO-Link

### SIRIUS 3RS14, 3RS15 temperature monitoring relays for IO-Link

#### General data

#### Overview



SIRIUS 3RS14, 3RS15 temperature monitoring relay

The temperature monitoring relays for IO-Link are used to measure temperatures in solid, liquid and gas media.

The temperature is calculated using a sensor in the medium, evaluated by the device and monitored up to two limit values for overshooting or undershooting a working range (window function).

In addition to warnings and disconnection in case of temperature deviations, the devices can also be used as a temperature controller (one-point, two-point or three-point control).

The devices differ from one another in terms of the type and number of connectable temperature sensors.

- 3RS14: Connection for resistance sensor
- 3RS15: Connection for thermocouples

Function	Temperature monitoring relays		
	3RS1440	3RS1441	3RS1540
<b>Connectable sensor type</b>			
Number of sensors monitored	1	3	1
Resistance sensor	✓	✓	--
Thermocouples	--	--	✓
<b>Temperature monitoring</b>			
Temperature monitoring - overshoot	✓	✓	✓
Temperature monitoring - undershoot	✓	✓	✓
Number of adjustable limit values	2	2	2

✓ Function supported

-- Function not supported

5

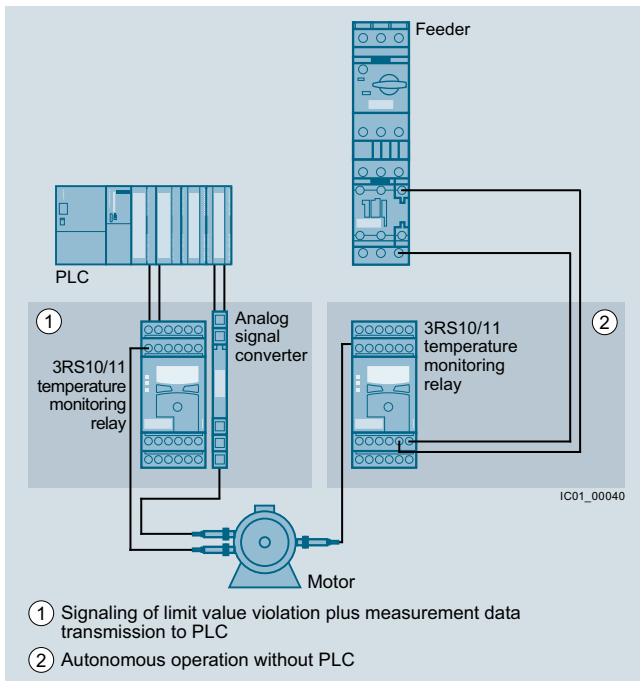

Conventional temperature monitoring relays

#### Notes:

Devices required for the communication via IO-Link:

- Any controller that supports the IO-Link (e.g. ET 200S with CPU or S7-1200), see Catalog ST 70 "Products for Totally Integrated Automation"
- IO-Link master (e.g. 4SI or 4SI IO-Link electronic module for SIMATIC ET 200S or SM 1278 for S7-1200) see Catalog ST 70 "Products for Totally Integrated Automation"

Each monitoring relay requires an IO-Link channel.

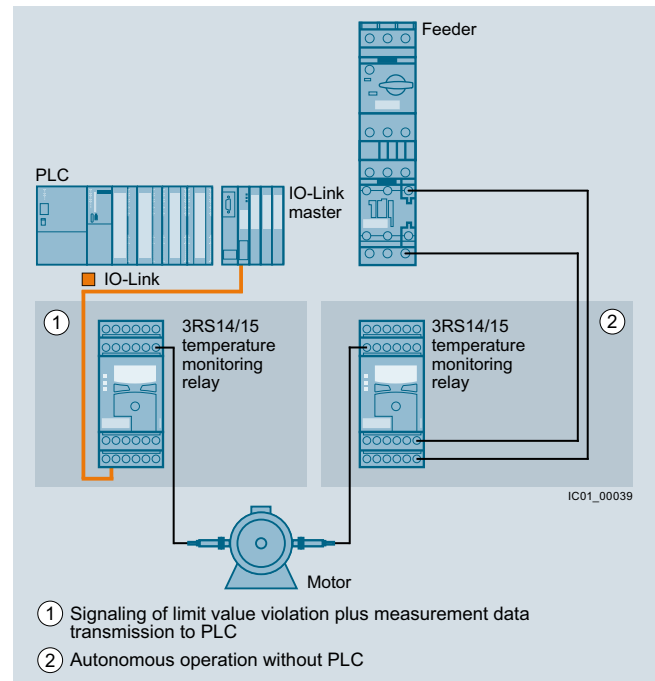

Temperature monitoring relays for IO-Link

#### Notes on safety:



System networking requires suitable protective measures (including network segmentation for IT security) in order to ensure safe plant operation.

More information about the subject of Industrial Security see [www.siemens.com/industrialsecurity](http://www.siemens.com/industrialsecurity).



**Overview** (continued)**Connection methods**

Selection tables for the 3RS14 and 3RS15 monitoring relays can be found on the following pages.

-  Screw terminals
-  Spring-type terminals

**More information****Characteristic curves**

For resistance sensors

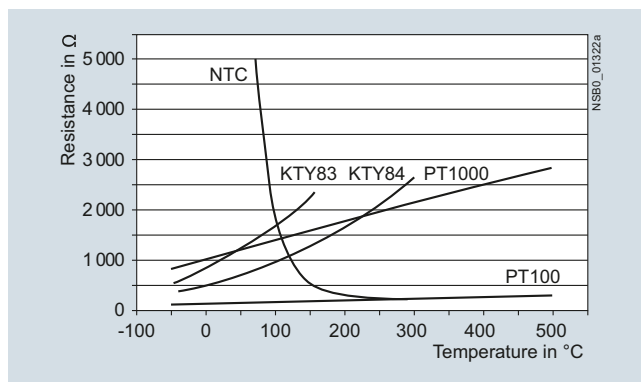

The short-circuit and open-circuit detection as well as the measuring range is limited, depending on the sensor type.

## Measuring ranges for resistance sensors

Sensor type	Short circuit	Open circuit	3RS1440, 3RS1441	
			Measuring range in °C	Measuring range in °F
PT100	✓	✓	-50 ... +750	-58 ... +1 382
PT1000	✓	✓	-50 ... +500	-58 ... +932
KTY83-110	✓	✓	-50 ... +175	-58 ... +347
KTY84	✓	✓	-40 ... +300	-40 ... +572
NTC <sup>1)</sup>	✓	--	+80 ... +160	+176 ... +320

- ✓ Detection possible
- Detection not possible

<sup>1)</sup> NTC type: B57227-K333-A1 (100 °C: 1.8 kΩ; 25 °C: 32.762 kΩ).

For thermocouples

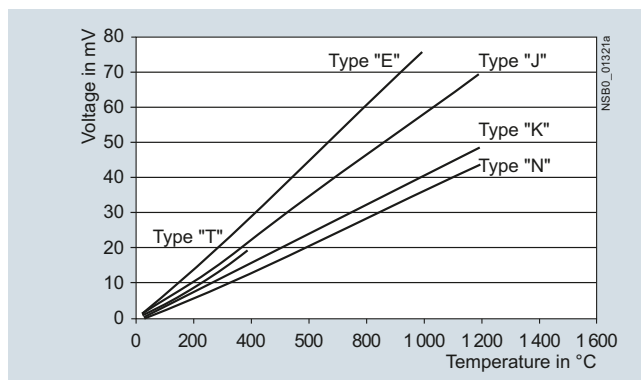

Characteristic curves for sensor types K, N, J, E and T

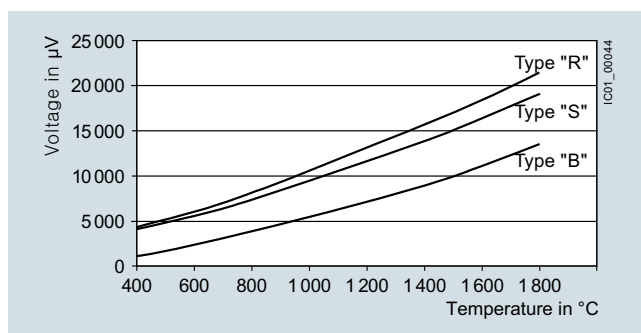

Characteristic curves for sensor types S, R and B

## Measuring ranges for thermocouples

Sensor type	Short circuit	Open circuit	3RS1540	
			Measuring range in °C	Measuring range in °F
K	--	✓	-99 ... +1 350	-146.2 ... +2 462
N	--	✓	-99 ... +1 300	-146.2 ... +2 372
J	--	✓	-99 ... +1 200	-146.2 ... +2 192
E	--	✓	-99 ... +999	-146.2 ... +1 830.2
T	--	✓	-99 ... +400	-146.2 ... +752
S	--	✓	0 ... 1 750	32 ... 3 182
R	--	✓	0 ... 1 750	32 ... 3 182
B	--	✓	400 ... 1 800	752 ... 3 272

- ✓ Detection possible
- Detection not possible

**Note:**

For the manual "3RS14/3RS15 Temperature Monitoring Relays for IO-Link", see <http://support.automation.siemens.com/WW/view/en/54375463>.

## IO-Link

### SIRIUS 3RS14, 3RS15 temperature monitoring relays for IO-Link

#### Relays, digitally adjustable for 1 sensor

#### Overview

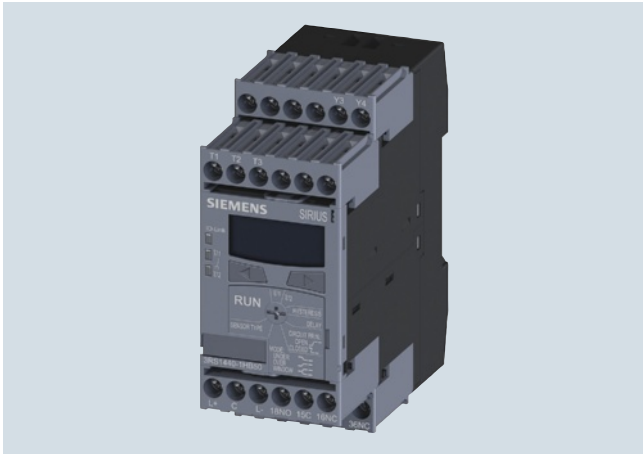

SIRIUS 3RS1440 digital monitoring relay for 1 sensor

The 3RS14 and 3RS15 temperature monitoring relays for IO-Link are used to measure temperatures in solid, liquid and gas media. The temperature is calculated using a sensor in the medium, evaluated by the device and monitored for overshooting or undershooting a working range (window function). The digital temperature monitoring relays have two separately adjustable limit values, are non-volatile and can be operated as desired using the open- or closed-circuit principle.

The devices differ in terms of the number of temperature sensors which can be evaluated. The 3RS1440 and 3RS1540 for IO-Link temperature monitoring relays can be digitally adjusted for one sensor and represent an alternative to temperature controllers in the low-end range (two-point or three-point control).

The devices with two-point control can, for example, be used as a thermostat. The devices with three-point control can, for example, independently switch between heating and cooling.

The 3RS1441 temperature monitoring relays for IO-Link can be digitally adjusted to evaluate up to three resistance sensors at one time. The devices were designed specifically for monitoring motor windings and positions.

The temperature monitoring relays are powered through the control supply voltages IO-Link (L+) and ground (L-) or via an external 24 V DC power supply.

#### Monitoring

When the temperature has reached the  $\vartheta_1$  limit value, the K1 output relay changes its switching state after the configured time  $t$  has expired (output relay K2 reacts accordingly at  $\vartheta_2$ ). The delay time can be adjusted.

The output relays return immediately to their original state once the temperature reaches the respective hysteresis value.

When the temperature has reached the top  $\vartheta_1$  limit value, the K1 output relay changes its switching state after the configured time  $t$  has expired. The output relay returns immediately to its original state once the temperature reaches the respective hysteresis value.

The K2 output relay reacts in the same way at the  $\vartheta_2$  lower threshold. Both limit values  $\vartheta_1$  and  $\vartheta_2$  can be parameterized for overshooting or undershooting the thresholds. This makes it possible to use a limit value for issuing an alarm signal to announce that a limit value is about to be overshoot or undershoot.

#### Note:

The "Temperature monitoring mode" parameter can be used to set the desired type of monitoring (monitoring for overshooting or undershooting or range monitoring).

#### Benefits

- Very simple operation without complicated menu selections
- Two- or three-point control can be parameterized quickly
- All versions with removable terminals
- All versions with screw or spring-type terminals







#### Application

The temperature monitoring relays can be used in almost any application in which temperature overshoot or undershoot is not permitted, e.g. in the monitoring of set temperature limits and the output of alarm messages for:

- Plant and environment protection
- Temperature limits for process variables e.g. in the packaging industry or electroplating
- Temperature limits for district heating plants
- Exhaust temperature monitoring
- Controlling equipment and machines such as heating, climate and ventilation systems, solar collectors, heat pumps or warm water supplies
- Motor, bearing and gear oil monitoring
- Monitoring of coolants

**Selection and ordering data**

- To monitor temperatures with a resistance sensor or thermocouple
- Temperature range dependent on sensor type  
-99 to +1 800 °C or -146.2 to +3 272 °F
- Short-circuit and open-circuit detection in sensor circuit
- Adjustable via IO-Link and locally, with illuminated LCD
- Power supply with 24 V DC via IO-Link or external auxiliary voltage
- Overshoot, undershoot or range monitoring adjustable
- Exact sensor type can be set
- 2 limit values, can be adjusted separately
- Adjustable open/closed-circuit principle
- Can be adjusted by hand or remote RESET (via an external contact)
- Actual value, tripping state for control displayed and conveyed, adjustable in °C or °F
- 1 CO contact per limit value
- 1 CO contact for monitoring sensors and devices

						
3RS1440-1HB50	3RS1540-1HB80	3RS1440-2HB50	3RS1540-2HB80			
Sensors	Measuring range (limit of measuring range dependent on sensor)	Hysteresis adjustable for §1 and §2	Tripping delay time adjustable for §1 and §2 DELAY	Control supply voltage $U_s$	<b>Screw terminals</b> 	<b>Spring-type terminals</b> 
		K	s	V DC	<b>Article No.</b>	<b>Article No.</b>

**Temperature monitoring relay, digitally adjustable for a sensor, non-volatile fault storage can be selected**

PT100/PT1000, KTY83/KTY84, NTC (resistance sensor) <sup>1)</sup>	-50 ... +750 °C or -58 ... +1 382 °F	0 ... 99	0 ... + 999.9	24	<b>3RS1440-1HB50</b>	<b>3RS1440-2HB50</b>
Type B, E, J, K, N, R, S, T (thermocouples)	- 99 ... + 1 800 °C or - 146.2 ... + 3 272 °F	0 ... 99	0 ... + 999.9	24	<b>3RS1540-1HB80</b>	<b>3RS1540-2HB80</b>

<sup>1)</sup> NTC type B57227-K333-A1 (100 °C: 1.8 k $\Omega$ ; 25 °C: 32.762 k $\Omega$ ).

For accessories see page 5/59.

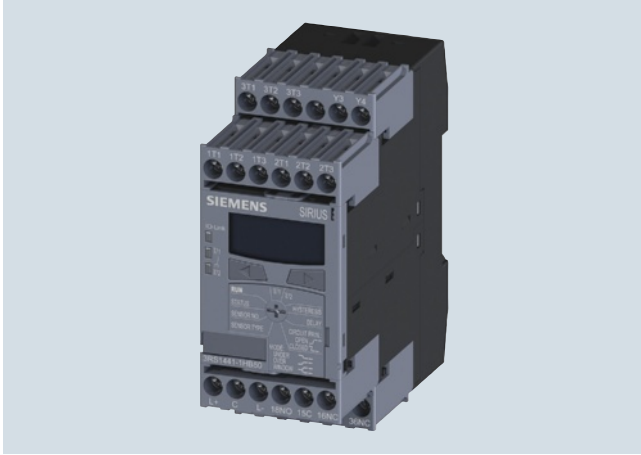
**IO-Link****SIRIUS 3RS14, 3RS15 temperature monitoring relays for IO-Link****Relays, digitally adjustable for up to 3 sensors****Overview**

SIRIUS 3RS1441 digital temperature monitoring relay for up to 3 sensors

The 3RS14 temperature monitoring relays can be used to measure temperatures in solid, liquid and gas media. The temperature is calculated using a sensor in the medium, evaluated by the device and monitored for overshooting or undershooting a working range (window function). The devices can be parameterized to indicate the measured temperature in °C or °F. The 3RS1441 evaluation unit can evaluate up to 3 resistance sensors at the same time.

**Benefits**

- Very simple operation without complicated menu selections
- Space-saving with 45 mm width
- Two- or three-point control can be parameterized quickly
- All versions with removable terminals
- All versions with screw or spring-type terminals

**Application**

The 3RS1441 temperature monitoring relays can be used almost anywhere where several temperatures must be monitored at one time for overshooting, undershooting or staying within a certain range.

Monitoring of set temperature limits and output of alarm messages for:

- Plant and environment protection
- Temperature limits for process variables e.g. in the packaging industry or electroplating
- Controlling equipment and machines such as heating, climate and ventilation systems, solar collectors, heat pumps or warm water supplies
- Motor, bearing and gear oil monitoring
- Monitoring of coolants

**Selection and ordering data**



- For temperature monitoring with up to 3 resistance sensors
- Temperature range dependent on sensor type  
-50 to +750 °C or -58 to +1 382 °F
- Short-circuit and open-circuit detection in sensor circuit
- Adjustable via IO-Link and locally, with illuminated LCD
- Power supply with 24 V DC via IO-Link or external auxiliary voltage
- Overshoot, undershoot or range monitoring adjustable
- Exact sensor type and number of sensors can be set
- 2 limit values, can be adjusted separately
- Adjustable open/closed-circuit principle
- Can be adjusted by hand or remote RESET (via an external contact)
- Actual value, tripping state for control displayed and conveyed, adjustable in °C or °F
- 1 CO contact per limit value
- 1 CO contact for monitoring sensors and devices



3RS1441-1HB50



3RS1441-2HB50

Sensors	Number of sensors that can be set	Measuring range (limit of measuring range dependent on sensor)	Hysteresis adjustable for 91 and 92	Tripping delay time adjustable for 91 and 92 DELAY	Control supply voltage $U_s$	Screw terminals 	Spring-type terminals 
			K	s	V DC	<b>Article No.</b>	<b>Article No.</b>





**Temperature monitoring relay, digitally adjustable for up to 3 sensors, non-volatile fault storage can be selected**

PT100/PT1000, KTY83/KTY84, NTC (resistance sensor) <sup>1)</sup>	1 ... 3 sensors	- 50 ... +750 °C or -58 ... +1 382 °F	0 ... 99	0 ... + 999.9	24	<b>3RS1441-1HB50</b>	<b>3RS1441-2HB50</b>
---	--------------------	--	----------	---------------	----	----------------------	----------------------

<sup>1)</sup> NTC type: B57227-K333-A1 (100 °C: 1.8 kΩ; 25 °C: 32.762 kΩ).

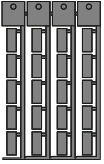
For accessories see page 5/59.

## Selection and ordering data

	Use	Version	Article No.
<b>Blank labels</b>			
 3RT2900-1SB20	For 3RS14 and 3RS15	<b>Unit labeling plates</b> For SIRIUS devices 20 mm x 7 mm, titanium gray <sup>1)</sup>	<b>3RT2900-1SB20</b>
	For 3RS14 and 3RS15	<b>Adhesive labels</b> for SIRIUS devices  19 mm x 6 mm, pastel turquoise 19 mm x 6 mm, zinc yellow	<b>3RT1900-1SB60</b> <b>3RT1900-1SD60</b>
	<b>Push-in lugs and covers</b>		
 3RP1903	For 3RS14 and 3RS15	<b>Push-in lugs</b> For screw fixing, 2 units are required for each device	<b>3RP1903</b>
	For 3RS14 and 3RS15	<b>Sealing foil</b> For securing against unauthorized adjustment of setting knobs	<b>3TK2820-0AA00</b>
<b>Tools for opening spring-type terminals</b>			
 3RA2908-1A	For auxiliary circuit connections	<b>Screwdrivers</b> For all SIRIUS devices with spring-type terminals  3.0 mm x 0.5 mm, length approx. 200 mm, titanium gray/black, partially insulated	<b>Spring-type terminals</b> 
			<b>3RA2908-1A</b>

<sup>1)</sup> PC labeling system for individual inscription of unit labeling plates available from: murrplastik Systemtechnik GmbH see Catalog IC 10, Chapter 16, "Appendix" ⇒ "External Partners".

Matching sensors see [www.siemens.com/temperature](http://www.siemens.com/temperature).

## IO-Link RFID Systems

### Introduction

### Overview



The SIMATIC RF200 is the compact RFID system in accordance with ISO 15693 within the SIMATIC RF product family. This system comprises space-saving HF readers (13.45 MHz), which are especially suitable for applications in intralogistics or in small assembly lines.

The readers SIMATIC RF210R, RF220R and RF260R with the interface variant for IO-Link support very simple identification tasks, such as reading an identification number or any user data ("Read Only"). This standardized interface makes it particularly easy and cost-effective to link the data automatically read by the reader into the automation level.

The comprehensive portfolio of extremely rugged, industry-compatible ISO 15693 data carriers from Siemens is available for a wide range of application areas: low-cost Smart Labels for permanent attachment to the product, screw-type transponders for easy mounting (also by robots), or transponders for flush-mounting in metal, for example, on a workpiece carrier.

**Overview**

SIMATIC RF210R is an M18 reader with integrated antenna. Its extremely compact design makes it ideal for use on small assembly lines.

This reader has either

- an RS-422 interface with transmission procedure 3964R for connection to the RFID communication modules ASM 456, ASM 475, SIMATIC RF160C, RF170C, RF180C and RF182C,
- or a standardized IO-Link interface for connection to IO-Link master modules from Siemens or third parties.

Thanks to its high degree of protection and rugged design, the SIMATIC RF210R reader enables problem-free use even under the toughest industrial conditions. Connection is by means of either an 8-pin M12 plug-in connector (RS422 version) or a 4-pin M12 plug-in connector (IO-Link version).

The reader is operated with ISO 15693-compatible transponders.

**Design****Field data****Minimum distance from reader to reader**

SIMATIC RF210R ≥ 100 mm

**Technical specifications**

<b>Article No.</b>	<b>6GT2821-1AC32</b>
<b>Product-type designation</b>	<b>RF210R reader IO-Link</b>
<b>Suitability for installation</b>	ISO 15693 transponder, for connecting to IO-Link master
<b>Wireless frequencies</b>	
Operating frequency rated value	13.56 MHz
<b>Electrical data</b>	
Range maximum	20 mm
Protocol for radio transmission	ISO 15693, ISO 18000-3
Transfer rate with radio transmission maximum	26.5 kbit/s
Product property multitag-capable	No
Transmission rate at point-to-point connection serial maximum	38.4 kbit/s
Transmission time for user data	-
• for write access per byte typical	-
• for read access per byte typical	40 ms
<b>Interfaces</b>	
Design of the electrical connection	M12, 4-pin
Standard for interfaces for communication	IO-Link
<b>Mechanical data</b>	
Material	Brass, nickel-plated / PBT
Color	Silver/pastel turquoise
Tightening torque of screw for mounting the equipment maximum	20 N·m
Mounting distance for metal surfaces recommended minimum	0 mm
<b>Supply voltage, current consumption, power loss</b>	
Supply voltage for DC	
• rated value	24 V
• minimum	20.4 V
• maximum	28.8 V
Consumed current at 24 V with DC typical	0.05 A
<b>Permitted ambient conditions</b>	
Ambient temperature	
• during operating	-20 ... +70 °C
• during storage	-25 ... +80 °C
• during transport	-25 ... +80 °C
Protection class IP	IP67
Resistance against shock	EN 60721-3-7, Class 7 M2
Resistance against shock	500 m/s <sup>2</sup>
Resistance against vibration	200 m/s <sup>2</sup>

## IO-Link

### RFID Systems

#### SIMATIC RF210R

##### Technical specifications (continued)

<b>Article No.</b>	<b>6GT2821-1AC32</b>
<b>Product-type designation</b>	<b>RF210R reader IO-Link</b>
<b>Design, dimensions and weight</b>	
Height	83 mm
Diameter	18 mm
Net weight	0.065 kg
Mounting type	2 x M18 nuts (included in scope of supply)
Cable length for RS 422 interface maximum	-
Cable length between master and IO-Link device maximum	20 m
<b>Product properties, functions, components general</b>	
Type of display	3-color LED
Product feature silicon-free	Yes
<b>Standards, specifications, approvals</b>	
Verification of suitability	Wireless according to R&TTE guidelines EN300 330 and EN 301489, FCC, UL/CSA

##### Ordering data

##### Article No.

<b>SIMATIC RF210R reader (IO-Link)</b>	<b>6GT2821-1AC32</b>
<b>Accessories</b>	
Note: All connection options can be found in Chapter 6 "Communication Modules".	
<b>IO-Link master</b> For SIMATIC ET 200eco PN, for 4 readers.	<b>6ES7148-6JA00-0AB0</b>
<b>IO-Link Master 4SI</b> For SIMATIC ET 200S, for 4 readers.	<b>6ES7138-4GA50-0AB0</b>
<b>IO-Link connecting cables</b>	
• between IO-Link master and reader, with M12 plug on the IO-Link master, open end, 4-pole, 5 m	<b>6GT2891-4LH50</b>
• between IO-Link master and reader, with M12 plug on the IO-Link master, open end, 4-pole, 10 m	<b>6GT2891-4LN10</b>
• between IO-Link master and reader, with M12 plug at both ends, 4-pole, 5 m	<b>6GT2891-0MH50</b>
• between IO-Link master and reader, with M12 plug at both ends, 4-pole, 10 m	<b>6GT2891-0MN10</b>
<b>DVD "RFID Systems Software &amp; Documentation"</b>	<b>6GT2080-2AA20</b>

##### More information

All current approvals can be found on the Internet at:

<http://www.siemens.com/rfid-approvals>



**Overview**

SIMATIC RF220R is an M30 reader with integrated antenna. Its compact design makes it ideal for use in small assembly lines which require a slightly higher range.

This reader has either

- an RS-422 interface with transmission procedure 3964R for connection to the RFID communication modules ASM 456, ASM 475, SIMATIC RF160C, RF170C, RF180C and RF182C,
- or a standardized IO-Link interface for connection to IO-Link master modules from Siemens or third parties.

Thanks to its high degree of protection and rugged design, the SIMATIC RF220R reader enables problem-free use even under the toughest industrial conditions. Connection is by means of either an 8-pin M12 plug-in connector (RS422 version) or a 4-pin M12 plug-in connector (IO-Link version).

The reader is operated with ISO 15693-compatible transponders.

**Design****Field data****Minimum distance from reader to reader**

SIMATIC RF220R ≥ 150 mm

**Technical specifications**

<b>Article No.</b>	<b>6GT2821-2AC32</b>
<b>Product-type designation</b>	<b>RF220R reader IO-Link</b>
<b>Suitability for installation</b>	ISO 15693 transponder, for connecting to IO-Link master
<b>Wireless frequencies</b>	
Operating frequency rated value	13.56 MHz
<b>Electrical data</b>	
Range maximum	35 mm
Protocol for radio transmission	ISO 15693, ISO 18000-3
Transfer rate with radio transmission maximum	26.5 kbit/s
Product property multitag-capable	No
Transmission rate at point-to-point connection serial maximum	38.4 kbit/s
Transmission time for user data	-
• for write access per byte typical	-
• for read access per byte typical	40 ms
<b>Interfaces</b>	
Design of the electrical connection	M12, 4-pin
Standard for interfaces for communication	IO-Link
<b>Mechanical data</b>	
Material	Brass, nickel-plated / PBT
Color	Silver/pastel turquoise
Tightening torque of screw for mounting the equipment maximum	40 N·m
Mounting distance for metal surfaces recommended minimum	0 mm
<b>Supply voltage, current consumption, power loss</b>	
Supply voltage for DC	
• rated value	24 V
• minimum	20.4 V
• maximum	28.8 V
Consumed current at 24 V with DC typical	0.05 A
<b>Permitted ambient conditions</b>	
Ambient temperature	
• during operating	-20 ... +70 °C
• during storage	-25 ... +80 °C
• during transport	-25 ... +80 °C
Protection class IP	IP67
Resistance against shock	EN 60721-3-7, Class 7 M2
Resistance against shock	500 m/s <sup>2</sup>
Resistance against vibration	200 m/s <sup>2</sup>

# IO-Link

## RFID Systems

### SIMATIC RF220R

#### Technical specifications (continued)

<b>Article No.</b>	<b>6GT2821-2AC32</b>
<b>Product-type designation</b>	<b>RF220R reader IO-Link</b>
<b>Design, dimensions and weight</b>	
Height	83 mm
Diameter	30 mm
Net weight	0.14 kg
Mounting type	2 x M30 nuts (included in scope of supply)
Cable length	-
• for RS 422 interface maximum	-
• between master and IO-Link device maximum	20 m
<b>Product properties, functions, components general</b>	
Type of display	3-color LED
Product feature silicon-free	Yes
<b>Standards, specifications, approvals</b>	
Verification of suitability	Wireless according to R&TTE guidelines EN300 330 and EN 301489, FCC, UL/CSA

#### Ordering data

#### Article No.

<b>SIMATIC RF220R reader (IO-Link)</b>	<b>6GT2821-2AC32</b>
<i>Accessories</i>	
Note: All connection options can be found in Chapter 6 "Communication Modules".	
<b>IO-Link master</b> For SIMATIC ET 200eco PN, for 4 readers.	<b>6ES7148-6JA00-0AB0</b>
<b>IO-Link Master 4SI</b> For SIMATIC ET 200S, for 4 readers.	<b>6ES7138-4GA50-0AB0</b>
<b>IO-Link connecting cables</b>	
• between IO-Link master and reader, with M12 plug on the IO-Link master, open end, 4-pole, 5 m	<b>6GT2891-4LH50</b>
• between IO-Link master and reader, with M12 plug on the IO-Link master, open end, 4-pole, 10 m	<b>6GT2891-4LN10</b>
• between IO-Link master and reader, with M12 plug at both ends, 4-pole, 5 m	<b>6GT2891-0MH50</b>
• between IO-Link master and reader, with M12 plug at both ends, 4-pole, 10 m	<b>6GT2891-0MN10</b>
<b>DVD "RFID Systems Software &amp; Documentation"</b>	<b>6GT2080-2AA20</b>

#### More information

All current approvals can be found on the Internet at:

<http://www.siemens.com/rfid-approvals>

**Overview**

SIMATIC RF260R is a reader with an integrated antenna. Its compact design makes it ideal for use in assembly lines.

This reader has either:

- An RS-422 interface with transmission procedure 3964R for connection to the RFID communication modules ASM 456, ASM 475, SIMATIC RF160C, RF170C, RF180C and RF182C,
- or an RS232 interface with a 3964R transmission procedure or ASCII protocol for connection to S7-1200, PC-based systems or third-party controllers,
- or a standardized IO-Link interface for connection to IO-Link master modules from Siemens or third parties.

Thanks to its high degree of protection and rugged design, the SIMATIC RF260R reader enables problem-free use even under the toughest industrial conditions. Connection is by means of either an 8-pin M12 plug-in connector (RS422/RS232 version) or a 4-pin M12 plug-in connector (IO-Link version).

The reader is operated with ISO 15693-compatible transponders.

**Design****Field data****Minimum distance from reader to reader**

SIMATIC RF260R	≥ 150 mm
----------------	----------

**Technical specifications**

<b>Article No.</b>	<b>6GT2821-6AC32</b>
<b>Product-type designation</b>	<b>RF260R reader IO-Link</b>
<b>Suitability for installation</b>	ISO 15693 transponder, for connecting to IO-Link master
<b>Wireless frequencies</b>	
Operating frequency rated value	13.56 MHz
<b>Electrical data</b>	
Range maximum	135 mm
Protocol for radio transmission	ISO 15693, ISO 18000-3
Transfer rate with radio transmission maximum	26.5 kbit/s
Product property multitag-capable	No
Transmission rate at point-to-point connection serial maximum	38.4 kbit/s
Transmission time for user data	-
• for write access per byte typical	40 ms
• for read access per byte typical	
<b>Interfaces</b>	
Design of the electrical connection	M12, 4-pin
Standard for interfaces for communication	IO-Link
<b>Mechanical data</b>	
Material	PA6.6
Color	Anthracite
Tightening torque of screw for mounting the equipment maximum	1.5 N·m
Mounting distance for metal surfaces recommended minimum	0 mm
<b>Supply voltage, current consumption, power loss</b>	
Supply voltage for DC	
• rated value	24 V
• minimum	20.4 V
• maximum	28.8 V
Consumed current at 24 V with DC typical	0.05 A
<b>Permitted ambient conditions</b>	
Ambient temperature	
• during operating	-20 ... +70 °C
• during storage	-25 ... +80 °C
• during transport	-25 ... +80 °C
Protection class IP	IP67
Resistance against shock	EN 60721-3-7, Class 7 M2
Resistance against shock	500 m/s <sup>2</sup>
Resistance against vibration	200 m/s <sup>2</sup>

## IO-Link RFID Systems

### SIMATIC RF260R

#### Technical specifications (continued)

<b>Article No.</b>	<b>6GT2821-6AC32</b>
<b>Product-type designation</b>	<b>RF260R reader IO-Link</b>
<b>Design, dimensions and weight</b>	
Width	75 mm
Height	41 mm
Depth	75 mm
Diameter	-
Net weight	0.2 kg
Mounting type	2 x M5 screws
Cable length	-
• with RS 232 interface maximum	-
• for RS 422 interface maximum	-
Cable length between master and IO-Link device maximum	20 m
<b>Product properties, functions, components general</b>	
Type of display	3-color LED
Product feature silicon-free	Yes
<b>Standards, specifications, approvals</b>	
Verification of suitability	Wireless according to R&TTE guidelines EN300 330 and EN 301489, FCC, UL/CSA

#### Ordering data

#### Article No.

<b>SIMATIC RF260R reader (IO-Link)</b>	<b>6GT2821-6AC32</b>
<b>Accessories</b>	
Note: All connection options can be found in Chapter 6 "Communication Modules".	
<b>RS232 connecting cables</b>	
Between reader and PC (RS232), 5 m long, material: PUR, CMG approval.	
• 24 V connection with M12 plug	<b>6GT2891-4KH50</b>
• 24 V connection with open ends	<b>6GT2891-4KH50-0AX0</b>
<b>IO-Link master</b>	
For SIMATIC ET 200eco PN, for 4 readers	<b>6ES7148-6JA00-0AB0</b>
<b>IO-Link Master 4SI</b>	
For SIMATIC ET 200S, for 4 readers	<b>6ES7138-4GA50-0AB0</b>
<b>IO-Link connecting cables</b>	
• between IO-Link master and reader, with M12 plug on the IO-Link master, open end, 4-pole, 5 m	<b>6GT2891-4LH50</b>
• between IO-Link master and reader, with M12 plug on the IO-Link master, open end, 4-pole, 10 m	<b>6GT2891-4LN10</b>
• between IO-Link master and reader, with M12 plug at both ends, 4-pole, 5 m	<b>6GT2891-0MH50</b>
• between IO-Link master and reader, with M12 plug at both ends, 4-pole, 10 m	<b>6GT2891-0MN10</b>
<b>DVD "RFID Systems Software &amp; Documentation"</b>	<b>6GT2080-2AA20</b>

#### More information

All current approvals can be found on the Internet at:

<http://www.siemens.com/rfid-approvals>



6/2	<b>Introduction</b>	6/92	<b>IWLAN – Client Modules IEEE 802.11n</b>
6/3	<b>Industrial Wireless LAN (IWLAN)</b>	6/92	Overview
6/3	Introduction	6/95	SCALANCE W748 RJ45 for use in control cabinet
6/6	Application examples	6/100	SCALANCE W748 M12 for indoor use
6/10	Overview of network components	6/105	SCALANCE W734 RJ45 for use in control cabinet
6/13	<b>IWLAN – Access Points IEEE 802.11n</b>	6/110	SCALANCE W722 RJ45 for use in control cabinet
6/13	Overview	6/114	SCALANCE W721 RJ45 for use in control cabinet
6/16	SCALANCE W788 RJ45 for use in control cabinet	6/118	<b>IWLAN – Accessories</b>
6/23	SCALANCE W788 M12 for indoor use	6/118	IWLAN antennas
6/30	SCALANCE W788 M12 EEC for enhanced environmental conditions	6/134	IWLAN RCoax cables
6/35	SCALANCE W786 RJ45 for outdoor use	6/139	IWLAN cabling technology
6/42	SCALANCE W786 SFP for outdoor use	6/148	KEY-PLUG W700
6/47	SCALANCE W774 RJ45 for use in control cabinet	6/150	Power Supply PS791-2DC and PS791-2AC
6/52	SCALANCE W774 M12 EEC for enhanced environmental conditions	6/152	<b>Wireless Devices</b>
6/57	SCALANCE W761 RJ45 for the Control Cabinet	6/152	SIMATIC Mobile Panel 277(F) IWLAN
6/62	<b>IWLAN – Controller and Controller Access Points IEEE 802.11n</b>	6/162	<b>WirelessHART</b>
6/62	Overview	6/162	General
6/66	SCALANCE WLC711 industrial wireless LAN controller	6/163	SITRANS P280 for gauge and absolute pressure
6/70	SCALANCE W788 RJ45 controller access points for use in control cabinet	6/167	SITRANS TF280, WirelessHART
6/74	SCALANCE W788C M12 controller access points for indoor use	6/170	SITRANS AW200 WirelessHART adapter
6/78	SCALANCE W788C M12 EEC for enhanced environmental conditions	6/174	SITRANS AW210 WirelessHART adapter
6/83	SCALANCE W786 RJ45 controller access points for outdoor use	6/178	IE/WSN-PA LINK
6/88	SCALANCE W786C SFP controller access points for outdoor use		

## Industrial Wireless Communication

### Introduction

#### Overview

Wireless communications offer multiple new opportunities to the industry for the development of highly flexible and efficient automation solutions. Whether Wireless Remote Networks, RUGGEDCOM WiN, Industrial Wireless LAN or WirelessHART, the Siemens product line for Industrial Wireless Communications is reliable, robust, and secure. The components are used under the toughest indoors and outdoors conditions. Their multiple applications in crane systems, automatic guided vehicle systems, or in remote operation/remote maintenance systems are a testimonial to their exceptional reliability.

RUGGEDCOM WiN products to the IEEE 802.16e-2005 (WiMax) standard support longer distances and are specially designed for use in critical locations and under demanding environmental conditions.

For more information about RUGGEDCOM WiN, go to <http://www.ruggedcom.com/products/ruggedwireless/>.

Further information on Industrial Wireless Telecontrol can be found under the product entries for GSM, GPRS and UMTS modems and routers in the section on Industrial Remote Communication.

More information on WirelessHART can be found under the product entries for WirelessHART as well as in Catalog FI 01 and at <http://www.siemens.com/wirelesshart>.

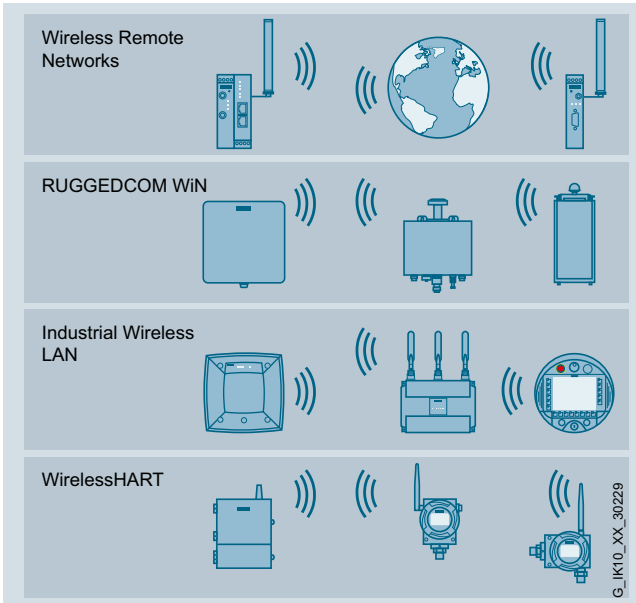

Wireless communication options

### Overview

#### **SCALANCE W – wireless communication with Industrial Wireless LAN**

The SCALANCE W products provide a combination of reliability, ruggedness and security in a single product:

- For use by industrial and automation customers
- For outdoor use under demanding climatic conditions
- For low-cost integration in the control cabinet or in devices

The Industrial Wireless LAN (IWLAN) technology provides an extension to the IEEE 802.11 standard that is particularly suited to demanding industrial applications with real-time and redundancy requirements. This provides customers with a unique wireless network, both for process-critical data and for uncritical communication. SCALANCE W products distinguish themselves by the reliability of their radio channel and the rugged type of construction with high requirements with respect to mechanical durability for which SIMATIC is known. To protect against unauthorized access, the products have modern standard mechanisms for user identification (authentication) and data encryption, and can at the same time be easily integrated into existing security concepts.

#### **Wireless infrastructure**

Instead of copper cables and fiber-optic cables, wireless transmission techniques use radio waves. The propagation characteristics of the electromagnetic waves can differ considerably and depend on the spatial environment with the installed wireless infrastructure.

SCALANCE W modules use techniques such as MIMO, high-quality receivers, and fault-tolerant modulation procedures to improve signal quality and to prevent interruption of wireless communication. Extensions to the IEEE 802.11 standard also permit reliable, wireless transmission from PROFINET, form the basis for wireless safety applications and the transmission of video data with extremely short reply and update data.

#### **Network solution with IWLAN**

Mobile end devices, for example, allow a continuous information flow from the management level down to the production level.

The IE/PB Link PN IO with SCALANCE W client modules (e.g. W722) is available for wireless-based connection of PROFIBUS devices.

This means that information can be provided quickly, reliably and easily at the right place and at the right time by wireless.

#### **Ruggedness and industrial suitability**

The SCALANCE W products can be exposed to fluctuations in the extended temperature range, or to continuous contact with dust and water. Rugged enclosure and mechanical protection against shock and vibration allow use in harsh industrial environments.

EEC (Enhanced Environmental Conditions) series devices are also specially strengthened (coated printed circuit boards resist condensation, increased temperature range) and can also be used in railway applications. Accessories such as antennas, power supply units and cabling are also part of this concept and are suitable for use in industry.

Power and data are transferred over one cable with Power-over-Ethernet (PoE), saving investment and maintenance costs.

The C-PLUG (configuration plug) swap medium stores engineering and configuration data, making device replacement possible in a short time and without specially trained personnel. This minimizes downtimes and saves training costs.

In addition to the functions of the C-PLUG, the KEY-PLUG swap medium allows additional features to be enabled on SCALANCE W78x/W74x and W77x/W73x.

#### **Reliability of data communication**

The international standard IEEE 802.11n makes wireless communication via IWLAN even more robust. The greatest advantage is the use of multiple path propagation (**M**ultiple **I**nput, **M**ultiple **O**utput (MIMO)). This allows the devices parallel use of multiple antennas. A higher data transfer rate is achieved and susceptibility to interference in environments with a lot of reflections is reduced.

SCALANCE W products with IWLAN in accordance with IEEE 802.11n support up to three streams each in both the send and receive directions.

## Industrial Wireless Communication

### Industrial Wireless LAN (IWLAN)

#### Introduction

#### Overview (continued)

Redundant network concepts can also be implemented by wireless. Wireless channels are designed redundantly for this purpose, with a failover time of a few milliseconds, so that the application is not influenced by packet repetitions or interference in the radio channel.

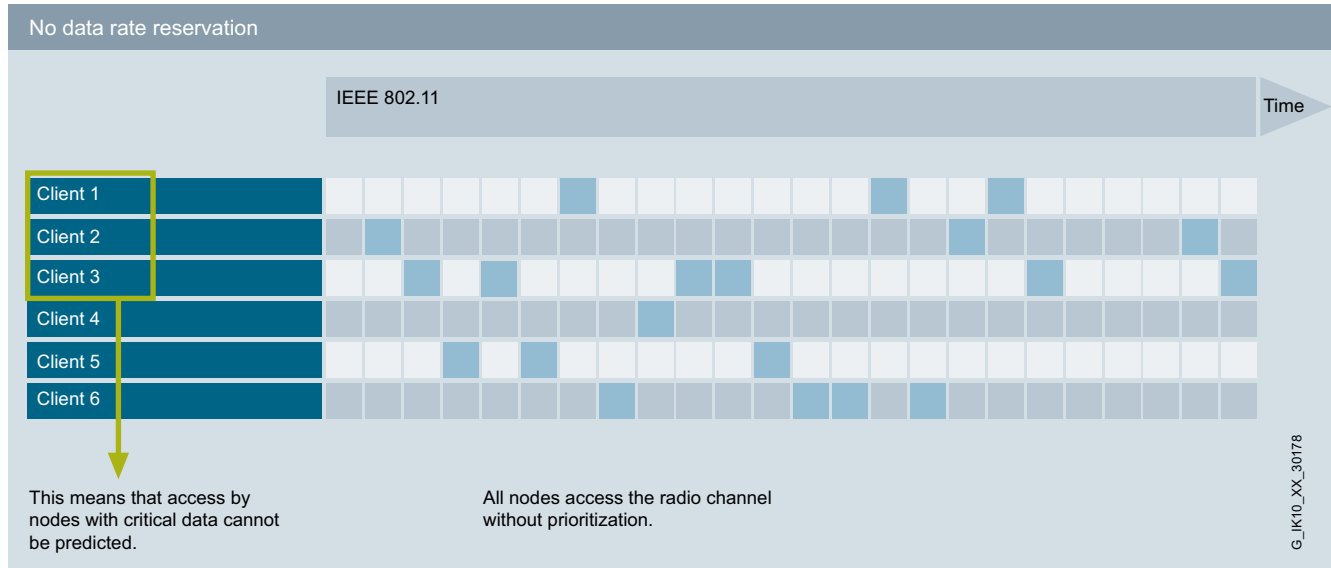

In standard WLAN, access by **all nodes** to the wireless channel is uncoordinated. This means that access by nodes with critical data cannot be predicted.

The iPCF function (supported by device types with iFeatures) permits cyclic data traffic in real time for several PROFINET IO devices connected by wireless. In addition, this allows mobile nodes to be transferred quickly from one wireless field to another (roaming) so that PROFINET IO communication is not interrupted.

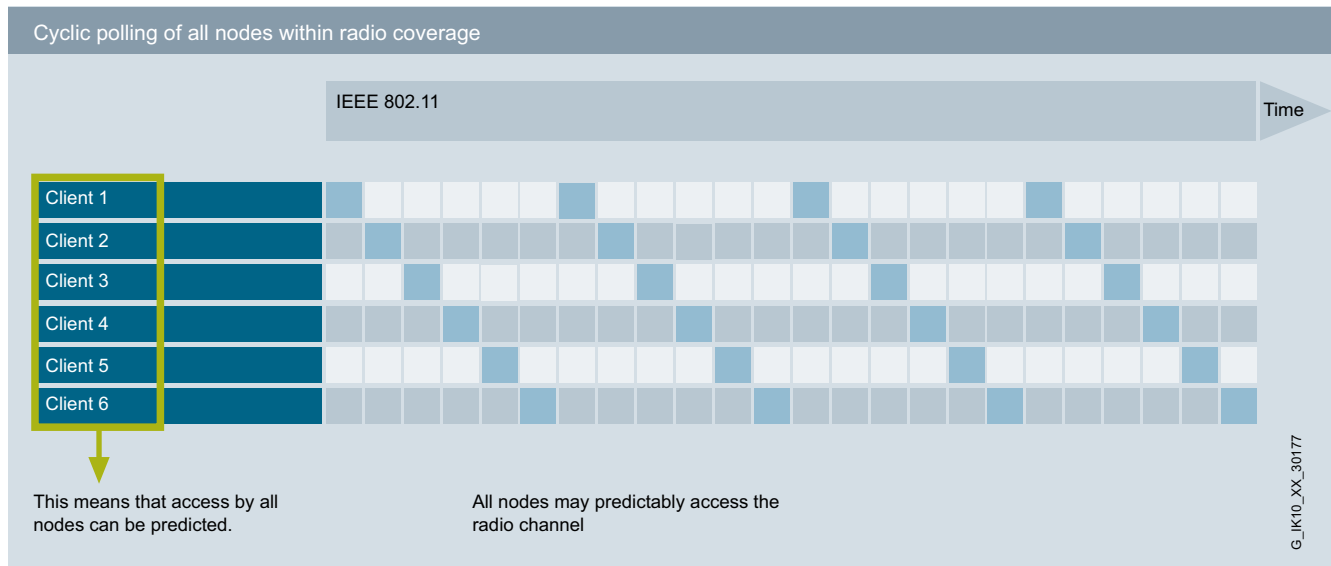



### Overview (continued)

#### Increased data rate

WLAN systems in accordance with IEEE 802.11a/b/g/h use a single channel for sending and receiving data. This achieves a maximum gross data rate of 54 Mbps.

Two channels are used simultaneously with the help of channel bonding. Gross data rates of up to 450 Mbps can be achieved in conjunction with MIMO technology in accordance with IEEE 802.11n.

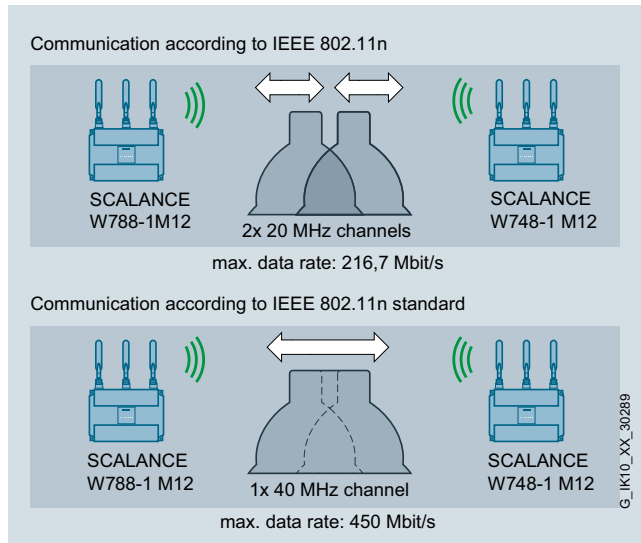

Increased data rate on IWLAN in accordance with IEEE 802.11n with the help of channel bonding

### Benefits

get **Designed for Industry**

- High level of investment protection, as all products comply with the universally recognized IEEE 802.11 standard and are suitable for 2.4 GHz and 5 GHz
- No wear and tear – saves maintenance and repair costs for connectors, trailing cables, sliding contacts or winding devices
- Predictable data traffic (deterministic response) and defined response times on the wireless link
- Wireless transmission of standard and fail-safe signals with PROFINET and PROFI-safe
- Low-cost installation in hazardous areas of Zone 2
- End-to-end wireless network for data, voice and video beyond corporate divisions thanks to interfacing with the SCALANCE WLC IWLAN controller (support by SCALANCE W78xC device types)
- Expansion of certain SCALANCE W products with additional functions is possible using a KEY-PLUG
- KEY-PLUG/C-PLUG permits simple device replacement if an error occurs

## Industrial Wireless Communication

### Industrial Wireless LAN (IWLAN)

#### Application examples

#### Overview

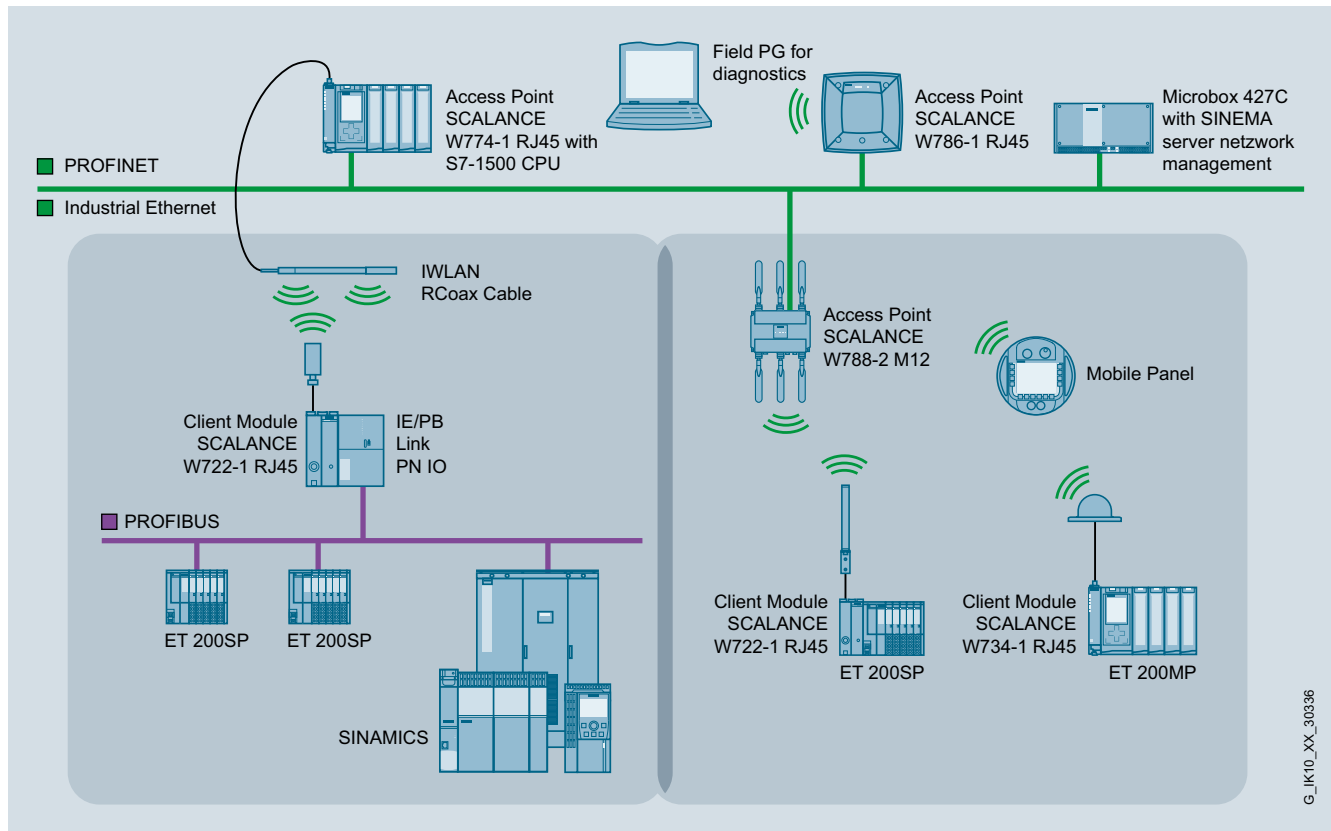

Wireless integration of PROFIBUS segments and PROFINET nodes into an existing Industrial Ethernet network

An existing Ethernet network can be expanded by a wireless network without increased overhead.

This even enables an existing PROFIBUS segment to be connected to an access point.

The wireless link is established to the mobile nodes by connecting a SCALANCE W access point to the Ethernet network. The mobile stations are connected wirelessly, e.g. via the SCALANCE W72x Client Module, to which the mobile station is connected with a cable.

Access to the existing controllers or processes is possible without much additional wiring.

### Overview (continued)

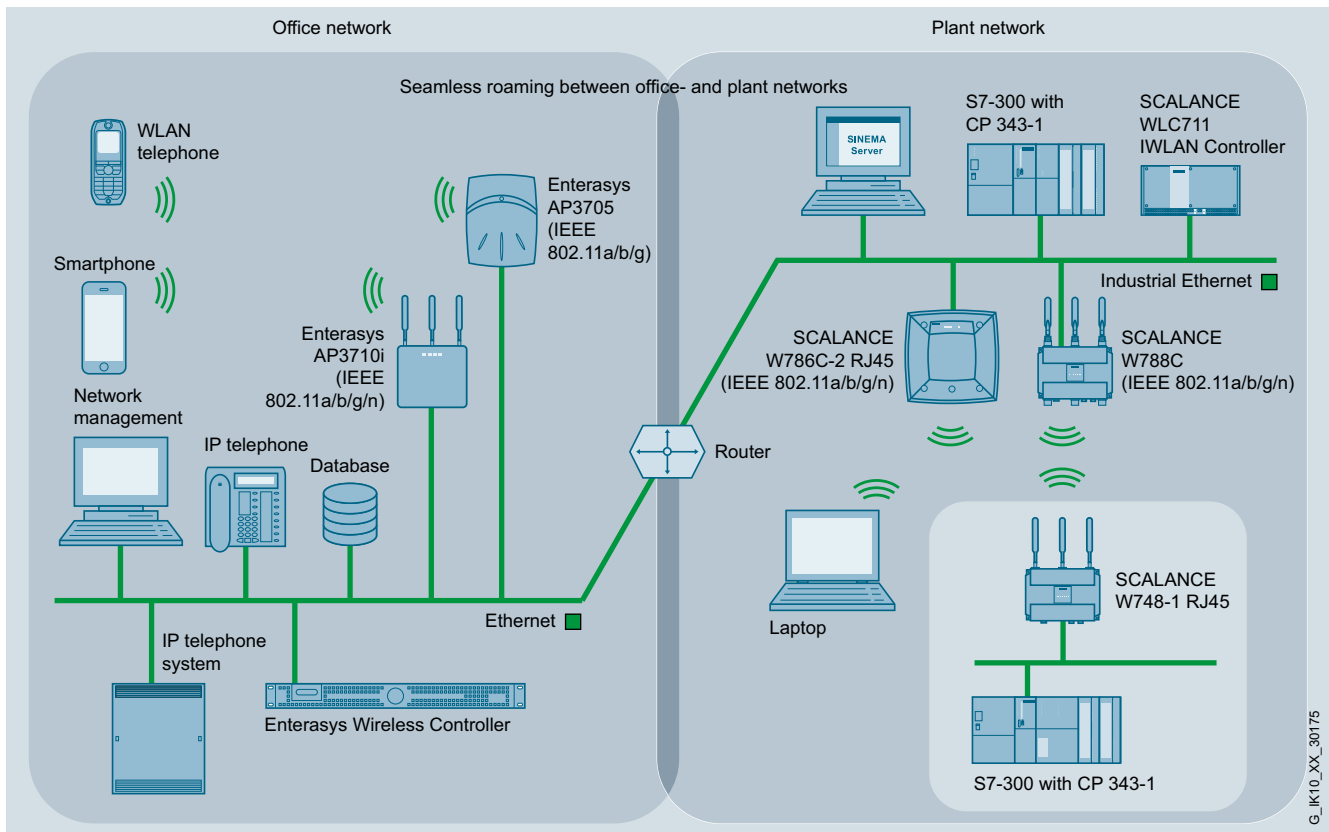

Uninterrupted roaming between the office and automation network by using wireless LAN controllers and Industrial Wireless LAN controllers

By using the SCALANCE WLC Industrial Wireless LAN controller along with controller-based access points, it is possible to establish a single wireless infrastructure for the entire company. This achieves a high level of flexibility, since mobile nodes (e.g. laptop, PDA, WLAN telephone) can move anywhere, roaming seamlessly between the office and automation networks. This allows wireless access to data from any location within the company. Thanks to the use of a centralized security mechanism for each user group (Virtual Network Services VNS), the data is protected against unauthorized access and manipulation.

The SCALANCE W78xC controller-based access points support the WLAN standards IEEE 802.11a/b/g and 802.11n, and they are connected via Gigabit Ethernet to the SCALANCE WLC IWLAN controller.

Operation always requires the SCALANCE WLC711 IWLAN controller that permits the configuration of access points in groups. This significantly increases the manageability of an widespread IWLAN infrastructure. Central management with the IWLAN controller also permits recording of faults/errors as well as monitoring and documentation of statistics.

## Industrial Wireless Communication

### Industrial Wireless LAN (IWLAN)

#### Application examples

#### Overview (continued)

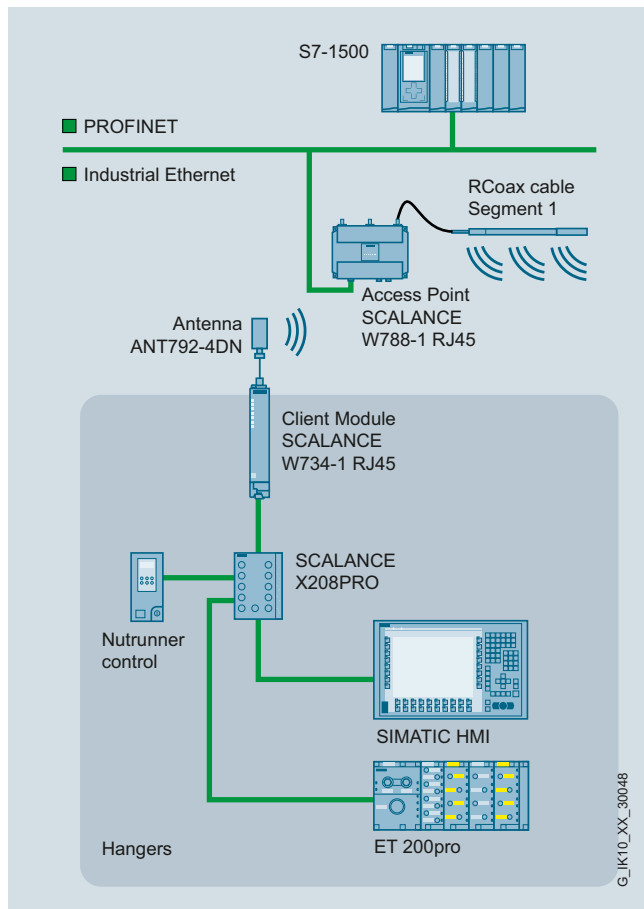

System solution for nutrunner controls with RCoax cable and SCALANCE W788-1 RJ45

Wireless solutions with RCoax cable are typically used in the following applications:

- Crane control
- Overhead monorail conveyors
- Storage and retrieval systems
- Automated guided vehicle systems (AGVS)

An example of an application with a suspended monorail is a nutrunner controller in a car assembly plant.

An RCoax radiating cable is used along the coding rail to establish wireless data transfer between the monorail and the central controller. It generates a reliable wireless field and is easy to lay.

The RCoax cable is connected as an antenna to a stationary SCALANCE W788-1 RJ45 access point with KEY-PLUG W780 i Features. This means that the same mobile unit can be used for all applications so that a mobile nutrunner can be used for several clock cycles resulting in lower investment costs.

Maintenance costs and downtimes are reduced by having reliable wireless data transmission to mobile communications partners without any wear and tear.

Downtimes are reduced because if a fault occurs, devices can be replaced without a programming device or specialist personnel by using the KEY-PLUG/ C-PLUG swap medium.

Overview (continued)

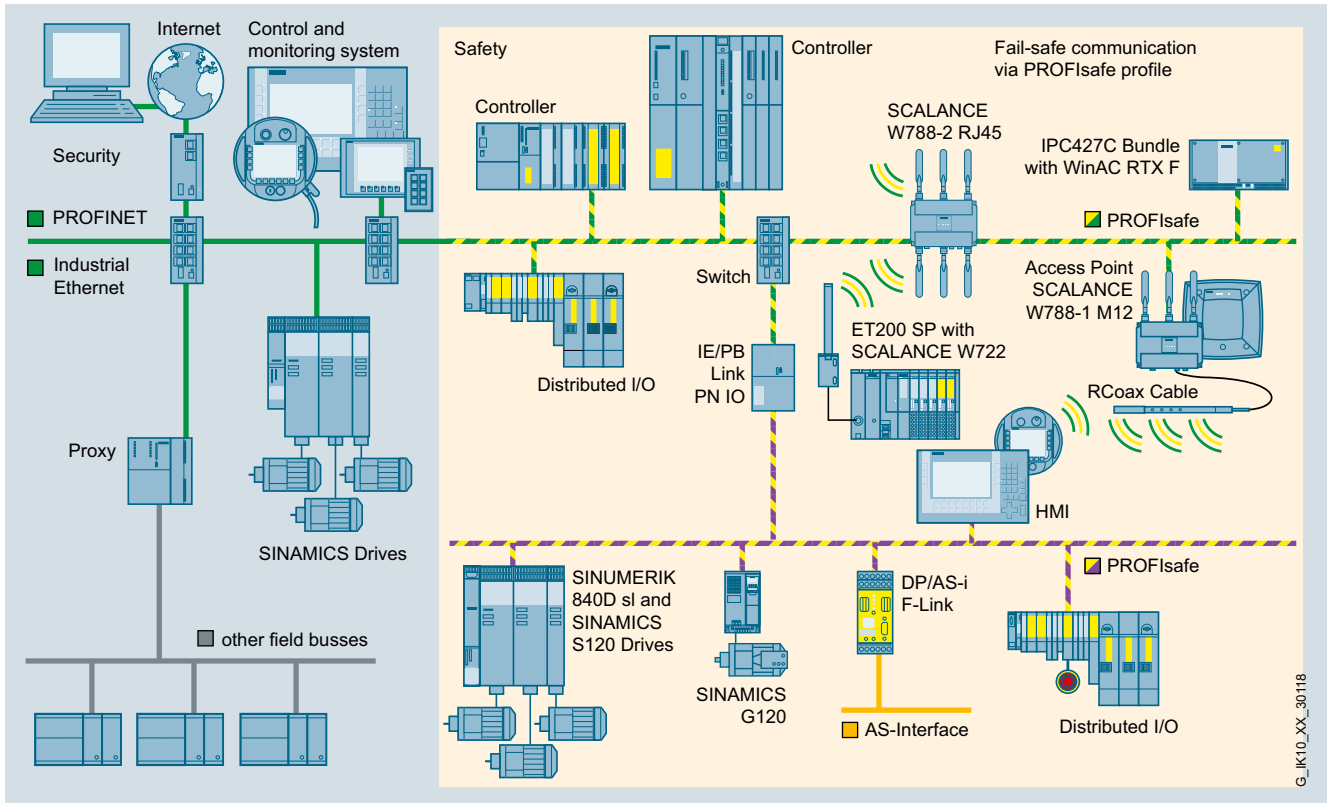

G\_IK10\_XX\_30118

Fail-safe communication with PROFIsafe – via PROFIBUS, PROFINET and even by wireless via Industrial Wireless LAN

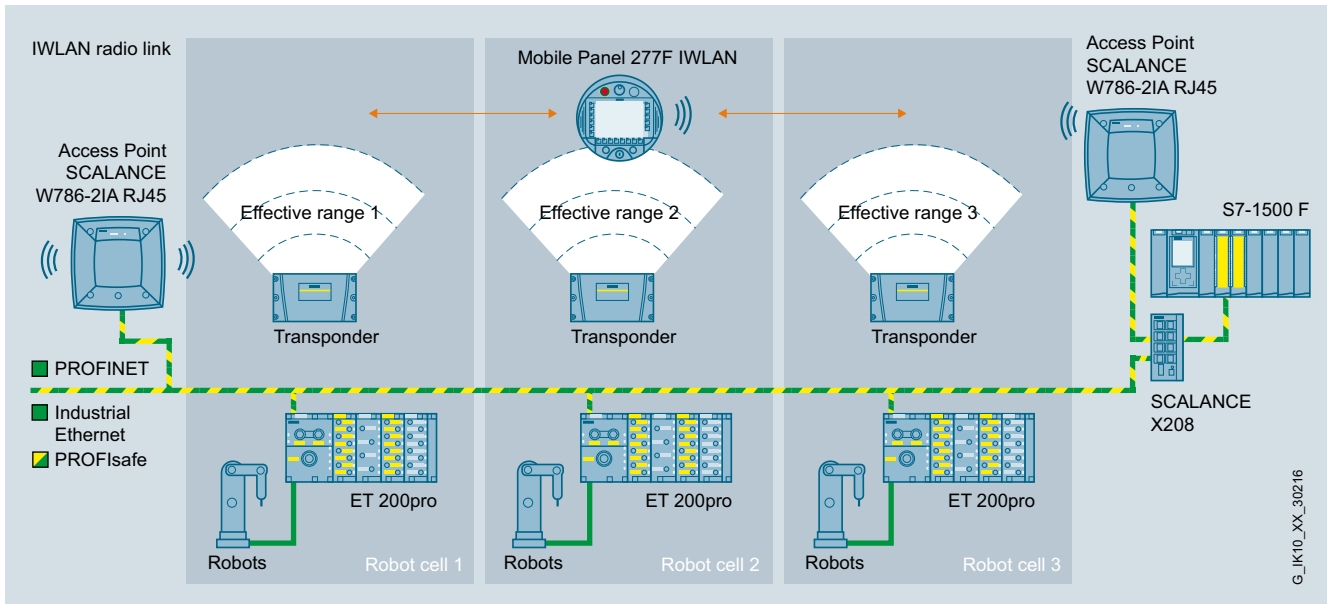

G\_IK10\_XX\_30216

Operation of robots in a safety-related environment

For several years, safety technology has been integrated in standard automation on the basis of SIMATIC S7 controllers, PROFIBUS and PROFIsafe.

This range has been expanded by PROFINET-compliant components, providing a complete product range with fail-safe controllers, fail-safe I/O and a corresponding engineering environment.

PROFIsafe prevents errors such as address corruption, loss, delay, etc. when transmitting messages through continuous numbering of the PROFIsafe data, time monitoring, and authenticity monitoring using passwords and optimized CRC backup.











This means that fail-safe communication is also supported via Industrial Wireless LAN.

# Industrial Wireless Communication

## Industrial Wireless LAN (IWLAN)

### Overview of network components

#### Overview



















	Client Modules			Access Points			
	SCALANCE						
	W720	W730	W740	W760	W770	W780	
For outdoor use						 *	
For indoor use							
For use in control cabinet							
Industrial Wireless LAN Controller	SCALANCE WLC711						G_IK10_XX_30311

\* also configurable as a client module

SCALANCE W access points, controller access points and clients and IWLAN controllers

6

## Overview (continued)

		IEEE 802.11n MIMO (Input x Output Streams)	IEEE 802.11a/ b/ g/ h	Number of radio interfaces	Internal antennas	Connections for external antennas (R-SMA)	Connections for external antennas (N-Connect)	Quantity of LAN ports	Type of LAN ports	PoE (Power-over-Ethernet) IEEE 802.3at Type 1 (previously 802.3af)	Redundant power supply	Slot for removable storage (PLUG)	Digital Input	Digital Output	Minimum operating temperature (°C)	Maximum operating temperature (°C)	IP protection class	Resistant to condensation	Resistant against salt spray	UV-resistant	For use in Ex zone 2 without housing	For use in Ex zone 2 <sup>1)</sup>	Operation with Entereasy WLAN controller	IWLAN client operation possible
	SCALANCE W788-1 M12	3x3	•	1			3	1	M12	•	•	•			-20	+60	65					•	•	
	SCALANCE W788-2 M12	3x3	•	2			6	1	M12	•	•	•			-20	+60	65					•	•	
	SCALANCE W788-2 M12 EEC	3x3	•	2			6	1	M12	•	•	•			-40	+70	65	•				•	•	
	SCALANCE W788-1 RJ45	3x3	•	1		3		1	RJ45	•	•	•	•	•	-20	+60	30					•	•	
	SCALANCE W788-2 RJ45	3x3	•	2		6		1	RJ45	•	•	•	•	•	-20	+60	30					•	•	
	SCALANCE W786-1 RJ45	3x3	•	1		3		1	RJ45	•	•	•			-40	+60	65	•	•	•	•		•	
	SCALANCE W786-2 RJ45	3x3	•	2		6		1	RJ45	•	•	•			-40	+60	65	•	•	•	•		•	
	SCALANCE W786-2IA RJ45	3x3	•	2	6			1	RJ45	•	•	•			-40	+60	65	•	•	•	•		•	
	SCALANCE W786-2 SFP	3x3	•	2		6		2	SFP			•			-40	+60	65	•	•	•	•		•	
	SCALANCE W774-1 RJ45	2x2	•	1		2		2	RJ45	•	•	•			-20	+60	30					•	•	
	SCALANCE W774-1 M12 EEC	2x2	•	1		2		2	M12	•	•	•			-20	+60	30	•				•	•	
	SCALANCE W761-1 RJ45	1x1	•	1		1		1	RJ45						0	+55	20					•	•	
	SCALANCE W788C-2 RJ45	3x3	•	2		6		1	RJ45	•	•				-20	+60	30					•	•	
	SCALANCE W788C-2 M12	3x3	•	2		6		1	M12	•	•				-20	+60	65					•	•	
	SCALANCE W788C-2 M12 EEC	3x3	•	2		6		1	M12	•	•				-40	+70	65	•				•	•	
	SCALANCE W786C-2 RJ45	3x3	•	2		6		1	RJ45	•	•				-40	+60	65	•	•	•	•		•	
	SCALANCE W786C-2IA RJ45	3x3	•	2	6			1	RJ45	•	•				-40	+60	65	•	•	•	•		•	
	SCALANCE W786C-2 SFP	3x3	•	2		6		2	SFP			•			-40	+60	65	•	•	•	•		•	

• suitable

1) please follow installation instructions

G\_IK10\_XX\_30280

Function overview of SCALANCE W access points according to the IEEE 802.11n standard





### Overview



The access points of the SCALANCE W700 product lines are ideally suited for setting up Industrial Wireless LANs (IWLAN) for 2.4 GHz or 5 GHz. They can be used in all applications that require a high degree of operational reliability, even in extremely harsh surroundings.

- High data rates (up to 450 Mbit/s in connection with Channel Bonding) as per IEEE802.11n
- Reliable wireless link by using of MIMO technology (Multiple Input, Multiple Output). For this, SCALANCE W access points use up to three streams for simultaneous sending and receiving.
- SCALANCE W700 Access Points are suitable for any application: for outdoors with high requirements regarding climatic conditions, for installing without a control cabinet indoors, for installing in the control cabinet, and for an extended range of environmental conditions.
- Reliable thanks to a rugged, impact-resistant enclosure, protected from water and dust (up to IP65), resistant to shock, vibration and electromagnetic fields, resistant to condensation thanks to the use of coated PCBs
- Demanding applications with real-time and redundancy requirements, such as PROFINET with PROFINET
- Conformance to standards through supporting IEEE802.11; expanded software functions especially for use where increased reliability is required, e.g. cyclic real-time data traffic and very high-speed roaming (iPCF, iPCF-MC)
- Configuration support by means of wizards and online help; easy management via Web server and SNMP
- Configuration and diagnostics using Web based Management, Command Line Interface, and SNMP. Devices and networks can be configured using STEP 7 (TIA Portal). For cyclic monitoring, diagnostics and documentation (reporting) in network mode, the SINEMA Server software is recommended.
- Enabling of further functions using the KEY-PLUG swap medium (iPCF, iPCF-MC, iREF)
- Fast replacement of devices if a fault occurs thanks to use of optional KEY-PLUG/C-PLUG (Configuration Plug) swap medium

### Benefits

get **Designed for Industry**

- Predictable data traffic (deterministic response) and defined response times on the wireless link
- Reliable wireless link, e.g. by using MIMO technology and monitoring the wireless link
- Cost savings by having only one wireless network both for process-critical data and for non-critical communication
- Future-proof because all products are compatible with the internationally recognized WLAN standard IEEE 802.11n, suitable for license-free 2.4 GHz and 5 GHz frequency bands (ISM bands)
- Implementation of data-intensive applications such as video streaming
- Reduced operating costs, because there is no wear and tear on rotating and moving plant sections
- Cost-effective connection to devices which are remote, difficult to access or installed in hostile environments
- Investment protection because flexible feature expansions (iFeatures) are possible by using the KEY-PLUG

### Application

The access points of the SCALANCE W700 product line are designed for both industrial use and for demanding climatic requirements outdoors. Versions for the inexpensive integration in cabinets or in machines are also available. They provide a reliable wireless link, redundancy mechanisms, and fast handover of nodes from one access point to the next (roaming). This allows processes to be monitored and loss of production due to machine downtimes to be avoided.

Industrial Wireless LAN (IWLAN) can also be used in time-critical applications in factory automation (PROFINET IO) or for safety-related signals (PROFINET).

Due to their high degree of protection (up to IP65) and extended temperature range from -40 °C to +70 °C, the access points are ideally suited for use outdoors. SCALANCE W products are silicone-free and can therefore also be used in paint shops.

When using the RCoax cable (radiating cable), operation is particularly reliable in conveyor systems and all track applications (e.g. storage and retrieval systems, suspended monorail).

## Industrial Wireless Communication

### IWLAN – Access Points IEEE 802.11n

#### Overview

#### Application (continued)

##### Application examples:

- Automated guided vehicle systems and suspended monorails; prevents wear and offers high flexibility for traffic routing thanks to the wireless transfer of data to the vehicles. It is also possible to transfer PROFI-safe via IWLAN.
- Cranes; high flexibility due to access to data communication with the moving unit independent of the location
- Mobile control console; reliable intervention in the process thanks to data communication over IWLAN with mobile units (e.g. Mobile Panel 277(F) IWLAN); the number of operator panels is therefore determined by the number of personnel and no longer by the number of control desks.
- Wireless access to field devices for configuration and testing
- Passenger transportation systems; transmission in passenger information systems, e.g. high-quality video streams between the control center and buses or trains
- Tunnel application; reliable wireless link since the devices can handle multiple path propagation better by using the MIMO technology.
- Communication with moving stations (e.g. mobile controls and devices), container logistics, storage and retrieval machines, conveyor systems, conveyor belts, rotating machines, trucks
- Wireless coupling of communication segments and bridging of large distances for fast commissioning and cost-effective networks in applications where cable routing would be extremely expensive (e.g. on public roads, rivers, lakes, train lines)
- Localization of personnel and machines using WLAN tags and localization software from AeroScout

#### Function

A simple RF field can be established with a single access point (infrastructure mode). The access point provides at least one Industrial Ethernet interface for connection to the wired network. Nodes, such as mobile controllers or a Field PG can move freely within the RF field and exchange data with other nodes via this access point.

If the RF field of a single access point (wireless cell) is insufficient, it can be expanded by further access points. The individual wireless cells must overlap so that moving nodes can be handed over seamlessly from one access point to the next (roaming). This is transparent for the application. The access points must be able to exchange data via Industrial Ethernet or a Wireless Distribution System (WDS).

If the access points are not connected to Industrial Ethernet using a wired connection (e.g. no cable tray available for a data line), the "Wireless Distribution System" mode must be selected. An access point from the SCALANCE W700 product line can communicate via WDS with several other access points that are not connected to the data network by a direct wired connection. Remote directional antennas can be used to achieve ranges of several thousand meters outdoors.

Apart from a reliable radio link, the SCALANCE W700 Access Points are characterized by their support of IT mechanisms:

- IEEE 802.11a/b/g/n for different frequency ranges
- IEEE 802.11e for Wireless Multimedia (WMM)
- IEEE 802.11i for security
- Construction of redundant networks with the Spanning Tree Protocols (RSTP, MSTP)
- Virtual networks (VLAN) for example to logically separate different user groups
- Sending the log entries of the SCALANCE W devices to a Syslog server
- Modern security mechanisms (e.g. network security such as IEEE 802.1x, RADIUS, EAP mechanisms)

#### Security

A high degree of data security is achieved by means of the WPA2/IEEE 802.11i mechanisms. These define modern procedures that control a regular exchange of the complete 128-bit key as well as performing the access check (authentication) of a node. The Advanced Encryption Standard (AES) is available for data encryption.

On top of this, access to the devices (HTTPS) is encrypted and a secure logon (SSH) is possible. If a security concept in combination with SCALANCE S is required, the security requirements can be increased using Virtual Private Networks (VPN).

### Function (continued)

**iFeatures** (only in conjunction with KEY-PLUG)

#### **iPCF (Industrial Point Coordination Function):**

The iPCF mode is a good choice for applications with requirements for real-time and predictable response times (deterministic response), even when mobile nodes are roaming from one access point to the next. This ensures that wireless PROFINET IO is supported and that safety-related signals, e.g. emergency stop, can be linked into the RF field. This means that even video signals from mobile nodes can be transmitted with a high level of quality. The iPCF mechanism expands the IEEE 802.11 standard and must be available on both the client module and the access point. In an RF field in which iPCF is used, no IEEE 802.11-compliant nodes can be operated.

iPCF is recommended for applications where wireless network nodes move along predefined paths (e.g. suspended monorail). RCoax radiating cables or directional antennas must be used for this purpose.

#### **iPCF-MC (iPCF Management Channel)<sup>1)</sup>:**

iPCF-MC is available as a further development of iPCF. This mode should be used if IWLAN stations that also support iPCF-MC move freely about in the coverage area (especially when using omni-directional antennas) and are to exchange data deterministically. This functionality can only be achieved in connection with access points with two wireless interfaces and the KEY PLUG.

#### **iREF (Industrial Range Extension Function):**

The range of an individual access point is very important, e.g. for path-based applications. Using iREF, it is now possible to align the various antennas of a wireless interface in different directions. This allows a longer path or a greater area to be covered using a single access point, which reduces the number of channels used and the number of access points.

#### Note:

These iFeatures cannot be used in parallel.

#### **Diagnostics and management**

- Web-based (HTTP/HTTPS) management tool for configuration and diagnostics using a standard browser
- LEDs for signaling operating status and fault/error states
- Signaling of faults by means of SNMP trap or e-mail to a network management tool
- Configuration and diagnostics using Web based Management, Command Line Interface, and SNMP. Devices and networks can be configured using STEP 7 (TIA Portal). For cyclic monitoring, diagnostics and documentation (reporting) in network mode, the SINEMA Server software is recommended.

<sup>1)</sup> Available soon

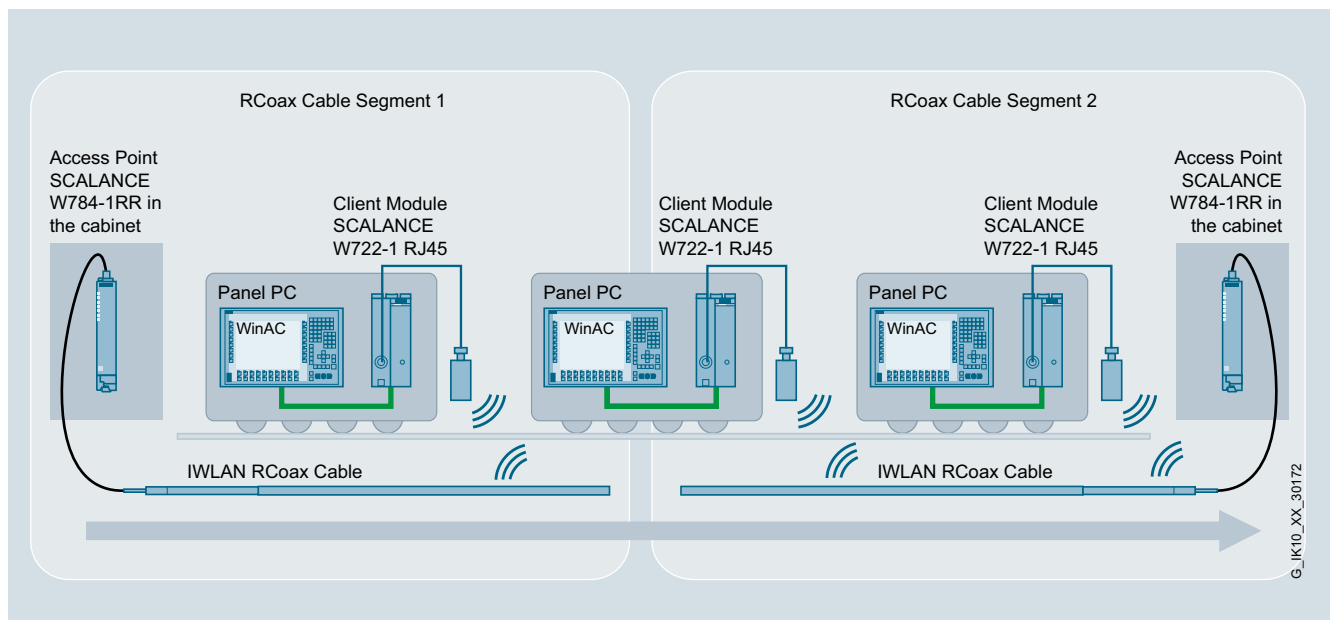

Linking in an automated guided vehicle system using iPCF with the SCALANCE W774-1 RJ45 and KEY-PLUG

## Industrial Wireless Communication

### IWLAN – Access Points IEEE 802.11n

#### SCALANCE W788 RJ45 for use in control cabinet

##### Overview

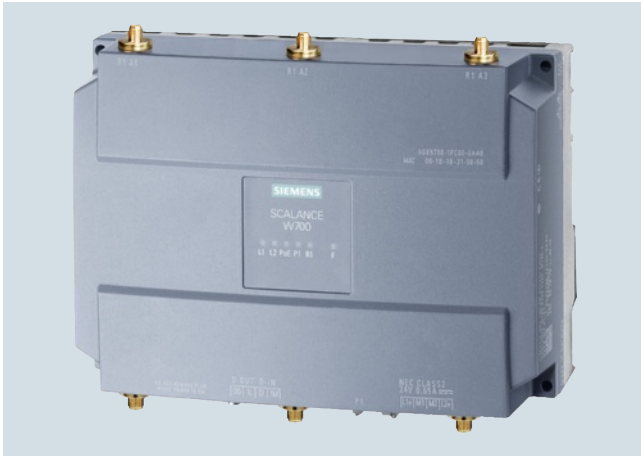

- Suitable for applications where the access point is to be mounted in the control cabinet

##### Design

- Rugged aluminum enclosure, shock and vibration-proof, for high mechanical requirements
- Dust protection with IP30 degree of protection
- For use at ambient temperatures from -20 °C to +60 °C
- 3 x R-SMA sockets for the connection of directly mountable and remote antennas (6 x R-SMA sockets for the variants with two wireless modules)
- Antenna placement optimized for the 3x3 MIMO technology; the antennas do not interfere with each other when they are mounted directly on the device
- Suitable for 2.4 GHz and 5 GHz
- 1 x RJ45 connector for 10/100/1 000 Mbit/s with Power-over-Ethernet according to IEEE 802.3at
- 2 x 24 V DC connection for redundant energy supply
- 1 x PLUG compartment for KEY-PLUG/C-PLUG
- Function LEDs for optical signaling of faults/errors and operating statuses
- Digital input for feeding in a signal from a sensor, for example, to an SNMP-based network management system
- Digital output for converting a command received over SNMP into a signal and switching a hardware function
- Mounting: Wall, S7-1500 mounting rail, S7-300 mounting rail, or on 35 mm standard mounting rail

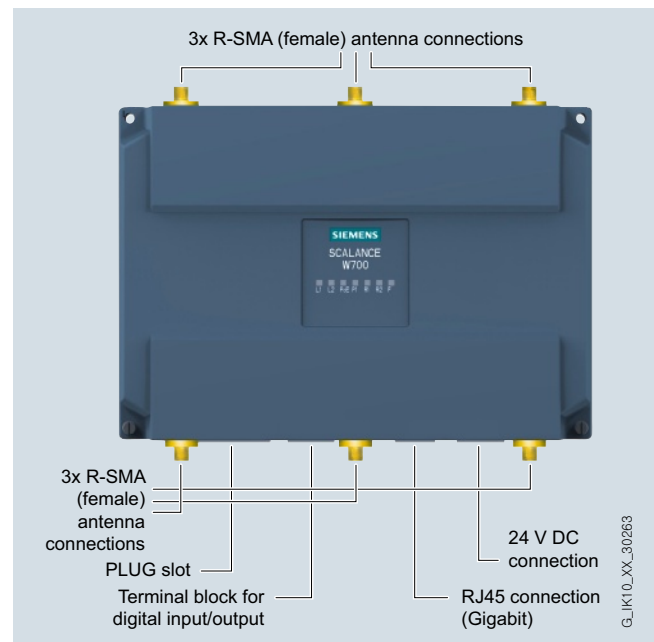

Design and interfaces of the SCALANCE W788-2 RJ45 access points

##### Product versions

###### SCALANCE W788-1 RJ45

- A radio card is permanently installed; functional scope can be expanded by using a KEY-PLUG W780 iFeatures

###### SCALANCE W788-2 RJ45

- Two radio cards are permanently installed; functional scope can be expanded by using a KEY-PLUG W780 iFeatures

#### Function

SCALANCE W788 RJ45 access points can also be operated as client modules. As an alternative, the SCALANCE W748 RJ45 client modules can be used for this mode.

In conjunction with the SCALANCE W748 RJ45 client modules with degree of protection IP30, an infrastructure can be set up in which extreme temperature differences and protection against dust and water tend to be less important.

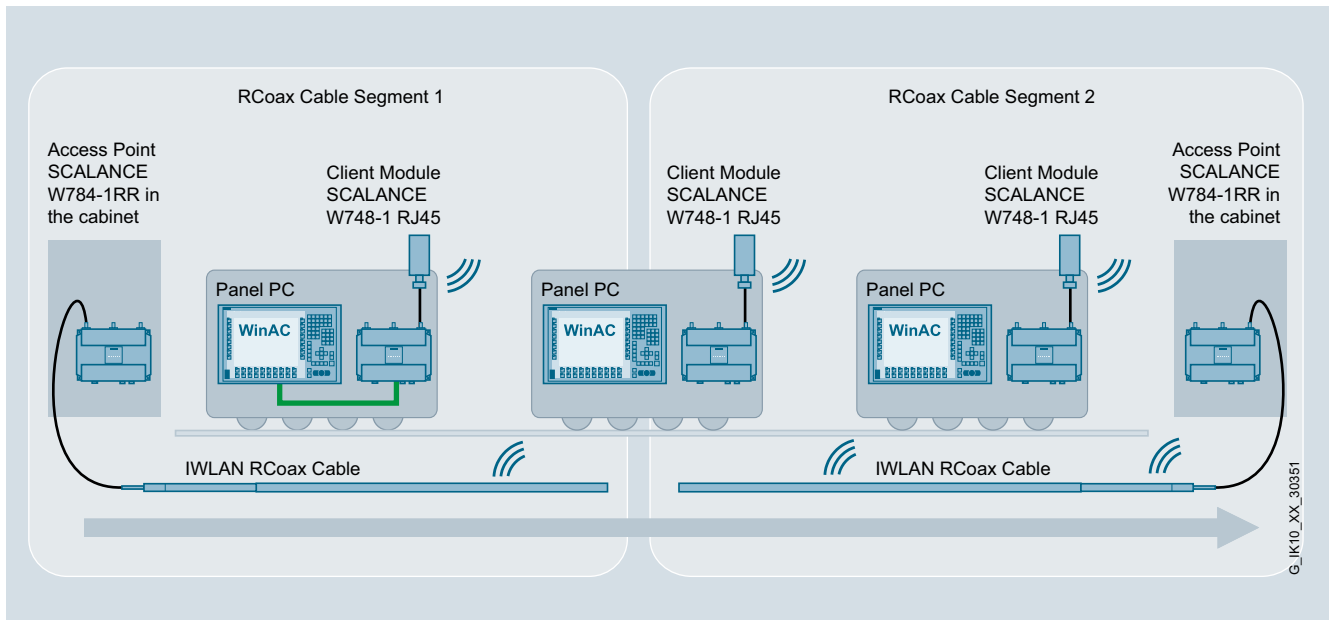

Linking in an automated guided vehicle system using iPCF with the SCALANCE W788-1 RJ45 and KEY-PLUG. The mobile automated guided vehicles are linked into the IWLAN RF field via the SCALANCE W748-1 RJ45 Ethernet client modules with KEY-PLUG. Both the access points and the client modules are in the control cabinet.

## Industrial Wireless Communication

### IWLAN – Access Points IEEE 802.11n

#### SCALANCE W788 RJ45 for use in control cabinet

#### Technical specifications

Article No.	6GK5788-1FC00-0AA0 6GK5788-1FC00-0AB0 <sup>1)</sup>	6GK5788-2FC00-0AA0 6GK5788-2FC00-0AB0 <sup>1)</sup>
Product-type designation	SCALANCE W788-1 RJ45	SCALANCE W788-2 RJ45
<b>Transmission rate</b>		
Transmission rate		
• with W-LAN maximum	450 Mbit/s	450 Mbit/s
• with Industrial Ethernet	10 ... 1 000 Mbit/s	10 ... 1 000 Mbit/s
• note	-	-
<b>Interfaces</b>		
Number of electrical connections		
• for network components and terminal equipment	1	1
• for power supply	1	1
• for redundant power supply	1	1
Design of electrical connection		
• for network components and terminal equipment	RJ45 socket	RJ45 socket
• for power supply	4-pole screw terminal, PoE	4-pole screw terminal, PoE
Number of optical interfaces for optical waveguide at 100 Mbit/s	-	-
Design of optical interface for optical waveguide at 100 Mbit/s	-	-
design of the removable storage C-PLUG	Yes	Yes
<b>Interfaces wireless</b>		
Number of radio cards permanently installed	1	2
Number of internal antennas	-	-
Number of electrical connections for external antenna(s)	3	6
Design of the electrical connection for external antenna(s)	R-SMA (socket)	R-SMA (socket)
Product property external antenna can be mounted directly on device	Yes	Yes
<b>Signal-Inputs/outputs</b>		
Number of digital inputs	1	1
Number of digital outputs	1	1
Design of electrical connection at the digital inputs/outputs	4-pole screw terminal	4-pole screw terminal
Signal range		
• at digital input	24 V DC, safety extra-low voltage	24 V DC, safety extra-low voltage
• at the digital output	24 V DC /1 A	24 V DC /1 A

<sup>1)</sup> Wireless approval in the USA

### Technical specifications (continued)

Article No.	6GK5788-1FC00-0AA0 6GK5788-1FC00-0AB0 <sup>1)</sup>	6GK5788-2FC00-0AA0 6GK5788-2FC00-0AB0 <sup>1)</sup>
Product-type designation	SCALANCE W788-1 RJ45	SCALANCE W788-2 RJ45
<b>Supply voltage, current consumption, power loss</b>		
Type of supply voltage	DC	DC
Supply voltage		
• 1 from terminal block	19.2 V	19.2 V
• 2 from terminal block	28.8 V	28.8 V
• from Power-over-Ethernet according IEEE802.3at for type 1 and IEEE802.3af	48 V	48 V
• from Power-over-Ethernet according IEEE802.3at for type 2	50 V	50 V
Current consumed		
• at 24 V with DC typical	0.45 A	0.63 A
• with Power-over-Ethernet according to IEEE802.3at for type 1 and IEEE802.3af typical	0.22 A	0.22 A
• with Power-over-Ethernet according to IEEE802.3at for type 2 typical	-	0.3 A
Effective power loss		
• at 24V for DC typical	10.7 W	15 W
• with Power-over-Ethernet according to IEEE802.3at for type 1 and IEEE802.3af typical	-	10.7 W
• with Power-over-Ethernet according to IEEE802.3at for type 2 typical	-	15 W
<b>Permitted ambient conditions</b>		
Ambient temperature		
• during operating	-20 ... +60 °C	-20 ... +60 °C
• during storage	-40 ... +70 °C	-40 ... +70 °C
• during transport	-40 ... +70 °C	-40 ... +70 °C
Relative humidity at 25 °C without condensation during operating maximum	90 %	90 %
Protection class IP	IP30	IP30
Ambient condition for (standard) operation mode	When used under hazardous conditions (Zone 2), the SCALANCE W788-xPRO/RR or W74x-1PRO/RR product must be installed in an enclosure. To comply with EN 50021, this enclosure must meet the requirements of at least IP 54 in compliance with EN 60529.	When used under hazardous conditions (Zone 2), the SCALANCE W788-xPRO/RR or W74x-1PRO/RR product must be installed in an enclosure. To comply with EN 50021, this enclosure must meet the requirements of at least IP 54 in compliance with EN 60529.
<b>Design, dimensions and weight</b>		
Width of enclosure without antenna	200 mm	200 mm
Height of enclosure without antenna	158 mm	158 mm
Depth of enclosure without antenna	79 mm	79 mm
Net weight	1.7 kg	1.7 kg
Mounting type wall mounting	Yes	Yes
<b>Wireless frequencies</b>		
Radio frequency		
• for WLAN in 2.4 GHz frequency band	2.41 ... 2.48 GHz	2.41 ... 2.48 GHz
• for WLAN in 5 GHz frequency band	4.9 ... 5.8 GHz	4.9 ... 5.8 GHz

<sup>1)</sup> Wireless approval in the USA

## Industrial Wireless Communication

### IWLAN – Access Points IEEE 802.11n

#### SCALANCE W788 RJ45 for use in control cabinet

#### Technical specifications (continued)

Article No.	6GK5788-1FC00-0AA0 6GK5788-1FC00-0AB0 <sup>1)</sup>	6GK5788-2FC00-0AA0 6GK5788-2FC00-0AB0 <sup>1)</sup>
Product-type designation	SCALANCE W788-1 RJ45	SCALANCE W788-2 RJ45
<b>Product properties, functions, components general</b>		
Product function		
• Access Point Mode	Yes	Yes
• Client Mode	Yes	Yes
Number of SSIDs	8	16
Product function		
• iPCF Access Point	Yes	Yes
• iPCF client	Yes	Yes
• iPCF-MC Access Point	in preparation	in preparation
• iPCF-MC client	in preparation	in preparation
Number of iPCF-capable radio modules	1	2
<b>Product functions management, configuration</b>		
Number of manageable IP addresses in client	8	8
Product function		
• CLI	Yes	Yes
• web-based management	Yes	Yes
• MIB support	Yes	Yes
• TRAPs via email	Yes	Yes
• Configuration with STEP 7	in preparation	in preparation
• configuration with STEP 7 in the TIA Portal	in preparation	in preparation
• operation with IWLAN controller	No	No
• operation with Enterasys WLAN controller	No	No
• forced roaming with IWLAN	Yes	Yes
• WDS	Yes	Yes
Protocol is supported		
• Address Resolution Protocol (ARP)	Yes	Yes
• ICMP	Yes	Yes
• Telnet	Yes	Yes
• HTTP	Yes	Yes
• HTTPS	Yes	Yes
• TFTP	Yes	Yes
• SNMP v1	Yes	Yes
• SNMP v2	Yes	Yes
• SNMP v3	Yes	Yes
• DCP	Yes	Yes
• LLDP	Yes	Yes
Identification & maintenance function		
• I&M0 - device-specific information	Yes	Yes
• I&M1 – higher level designation/ location designation	Yes	Yes
<b>Product functions Diagnosis</b>		
Product function		
• PROFINET IO diagnosis	in preparation	in preparation
• localization via Aeroscout	in preparation	in preparation
• SysLog	Yes	Yes
<b>Product functions VLAN</b>		
Product function function VLAN with IWLAN	Yes	Yes
<b>Product functions DHCP</b>		
Product function		
• DHCP client	Yes	Yes
• in Client Mode DHCP server via LAN	No	No

<sup>1)</sup> Wireless approval in the USA



### Technical specifications (continued)

Article No.	6GK5788-1FC00-0AA0 6GK5788-1FC00-0AB0 <sup>1)</sup>	6GK5788-2FC00-0AA0 6GK5788-2FC00-0AB0 <sup>1)</sup>
Product-type designation	SCALANCE W788-1 RJ45	SCALANCE W788-2 RJ45
<b>Product functions Redundancy</b>		
Protocol is supported STP/RSTP	Yes	Yes
<b>Product functions Security</b>		
Product function		
• ACL - MAC-based	-	-
• Management security, ACL-IP based	Yes	Yes
• IEEE 802.1x (radius)	Yes	Yes
• NAT/NAPT	No	No
• access protection according to IEEE802.11i	Yes	Yes
• WPA/WPA2	Yes	Yes
• TKIP/AES	Yes	Yes
Protocol is supported SSH	Yes	Yes
<b>Product functions Time</b>		
Protocol is supported		
• SNTP	Yes	Yes
• SIMATIC Time	Yes	Yes
<b>Standards, specifications, approvals</b>		
Standard		
• for hazardous zone	EN 60079-15:2005, EN 60079-0:2006, II 3 G Ex nA II T4 KEMA 07 ATEX 0145X	EN 60079-15:2005, EN 60079-0:2006, II 3 G Ex nA II T4 KEMA 07 ATEX 0145X
• for safety of CSA and UL	UL 60950-1 CSA C22.2 No. 60950-1	UL 60950-1 CSA C22.2 No. 60950-1
Verification of suitability		
• CE mark	Yes	Yes
• EC declaration of conformity	Yes	Yes
• C-Tick	Yes	Yes
• CCC	No	No
• Railway application in accordance with EN 50155	No	No
• e1 approval	No	No
• E1 approval	No	No
• NEMA4X	No	No
• Power-over-Ethernet according to IEEE802.3at for type 1 and IEEE802.3af	Yes	Yes
• Power-over-Ethernet according to IEEE802.3at for type 2	Yes	Yes
Standard for wireless communication		
• IEEE 802.11a	Yes	Yes
• IEEE 802.11b	Yes	Yes
• IEEE 802.11e	Yes	Yes
• IEEE 802.11g	Yes	Yes
• IEEE 802.11h	Yes	Yes
• IEEE 802.11i	Yes	Yes
• IEEE 802.11n	Yes	Yes
Wireless approval	You will find the current list of countries at: <a href="http://www.siemens.com/wireless-approvals">www.siemens.com/wireless-approvals</a>	You will find the current list of countries at: <a href="http://www.siemens.com/wireless-approvals">www.siemens.com/wireless-approvals</a>
<b>Accessories</b>		
Accessories	24 V DC screw terminal and screw terminal for digital input and output included in the scope of delivery	24 V DC screw terminal and screw terminal for digital input and output included in the scope of delivery

<sup>1)</sup> Wireless approval in the USA

## Industrial Wireless Communication

### IWLAN – Access Points IEEE 802.11n

#### SCALANCE W788 RJ45 for use in control cabinet

Ordering data	Article No.	Article No.
<b>SCALANCE W788 RJ45 access points</b>		<b>Accessories</b>
IWLAN access points with built-in wireless interfaces; wireless networks IEEE 802.11a/b/g/h/n at 2.4/5 GHz up to 450 Mbps; WPA2/AES; Power over Ethernet (PoE), IP30 degree of protection (-20 °C to +60 °C); scope of supply: Mounting hardware, 4-pin screw terminal for 24 V DC; 4-pin screw terminal for digital input and output; manual on CD-ROM; German/English		<b>KEY-PLUG W780 iFeatures</b> 6GK5907-8PA00 Swap medium for enabling additional iFeatures, for simple device replacement if a fault occurs and for storage of configuration data; Can be used in SCALANCE W access points with PLUG compartment
<b>SCALANCE W788-1 RJ45</b> IWLAN access point with <u>one</u> integrated wireless interface		<b>C-PLUG</b> 6GK1900-0AB00 Swap medium for simple replacement of devices in the event of a fault; for storing configuration data; can be used in SIMATIC NET products with PLUG compartment
• National approvals for operation outside the USA • National approvals for operation within the USA <sup>1)</sup>	<b>6GK5788-1FC00-0AA0</b> <b>6GK5788-1FC00-0AB0</b>	<b>DIN rail mounting adapter</b> 6GK5798-8ML00-0AB3 DIN rail mounting adapter for SCALANCE W788 M12 and SCALANCE W788 RJ45; screw fixing for mounting on a 35 mm DIN rail to EN 50 022; scope of supply: 3 units per pack
<b>SCALANCE W788-2 RJ45</b> IWLAN dual access point with <u>two</u> integrated wireless interfaces		<b>IE FC RJ45 Plug 4 x 2</b> 6GK1901-1BB11-2AA0 6GK1901-1BB11-2AB0 6GK1901-1BB11-2AE0 RJ45 plug-in connector for Industrial Ethernet (10/100/1 000 Mbps) with a rugged metal enclosure and integrated insulation displacement contacts for connecting Industrial Ethernet FC installation cables; 180° cable outlet; for network components and CPs/CPUs with Industrial Ethernet interface
• National approvals for operation outside the USA • National approvals for operation within the USA <sup>1)</sup>	<b>6GK5788-2FC00-0AA0</b> <b>6GK5788-2FC00-0AB0</b>	• 1 pack = 1 unit • 1 pack = 10 units • 1 pack = 50 units
		<b>IE FC Standard Cable GP 4x2</b> 6XV1878-2A 8-core, shielded TP installation cable for connection to IE FC RJ45 Plug 4x2 and IE M12 Plug PRO 4x2; PROFINET-compliant; with UL approval; sold by the meter; max. length 1 000 m, minimum order 20 m
		<b>IE FC Stripping Tool</b> 6GK1901-1GA00 Preadjusted stripping tool for fast stripping of Industrial Ethernet FC cables
		<b>Antennas and miscellaneous IWLAN accessories</b> See Industrial Wireless LAN/ accessories

<sup>1)</sup> Please note national approvals under <http://www.siemens.com/wireless-approvals>

#### More information

##### Selection tools:

To assist in selecting Industrial Ethernet components, the TIA Selection Tool is available at:  
<http://www.siemens.com/tia-selection-tool>

##### Wireless approvals:

Current approvals can be found on the Internet at:  
<http://www.siemens.com/wireless-approvals>

### Overview



- Particularly suitable for industrial applications without control cabinets

### Design

- Rugged aluminum enclosure, shock and vibration-proof, for high mechanical requirements
- High IP65 degree of protection against dust and water jets
- For use at ambient temperatures from -20 °C to +60 °C
- 3 x N-Connect sockets for the connection of directly mountable and remote antennas (6 x N-Connect sockets for the variants with two wireless modules)
- Antenna placement optimized for the 3x3 MIMO technology; the antennas do not interfere with each other when they are mounted directly on the device
- Suitable for 2.4 GHz and 5 GHz
- 1 x M12 connection for 10/100/1 000 Mbit/s with Power-over-Ethernet according to IEEE 802.3at
- 1 x M12 socket for power supply (24 V DC)
- 1 x PLUG compartment (KEY-PLUG/C-PLUG)
- Function LEDs for optical signaling of faults/errors and operating statuses
- Mounting: Wall, S7-1500 mounting rail, S7-300 mounting rail, or on 35 mm standard mounting rail

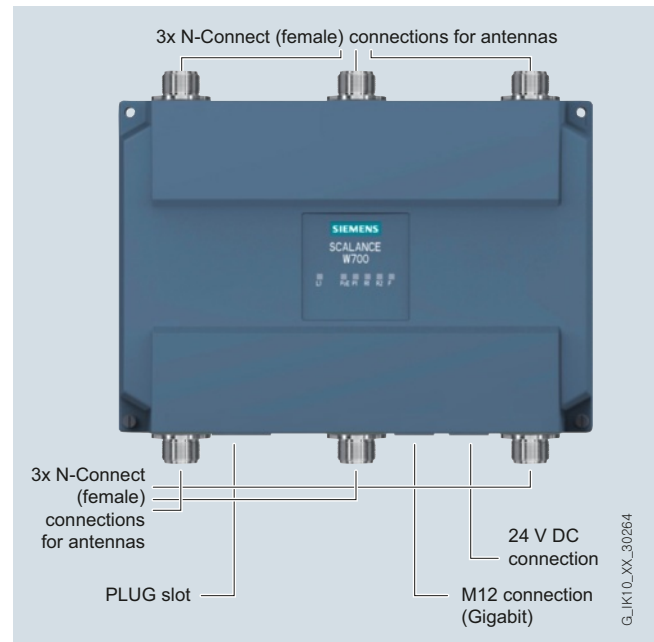

Design and interfaces of the SCALANCE W788-2 M12 access points

### Product versions

#### SCALANCE W788-1 M12

- A radio card is permanently installed; functional scope can be expanded by using a KEY-PLUG W780 iFeatures

#### SCALANCE W788-2 M12

- Two radio cards are permanently installed; functional scope can be expanded by using a KEY-PLUG W780 iFeatures

## Industrial Wireless Communication

### IWLAN – Access Points IEEE 802.11n

#### SCALANCE W788 M12 for indoor use

#### Function

The devices can be installed at the location that is most favorable for the wireless link. The enclosure and the connectors are resistant to high levels of shock and vibration because all the connectors are screwed. SCALANCE W788 M12 with degree of protection IP65 are ideally suited for environments with widely varying temperatures and where protection against dust and water play an important role. To achieve optimal coverage for

special applications, the complete range of SCALANCE W antennas is available.

SCALANCE W788-2 M12 access points can also be operated as client modules. As an alternative, the SCALANCE W748-1 M12 client modules are also available with degree of protection IP65 for this mode.

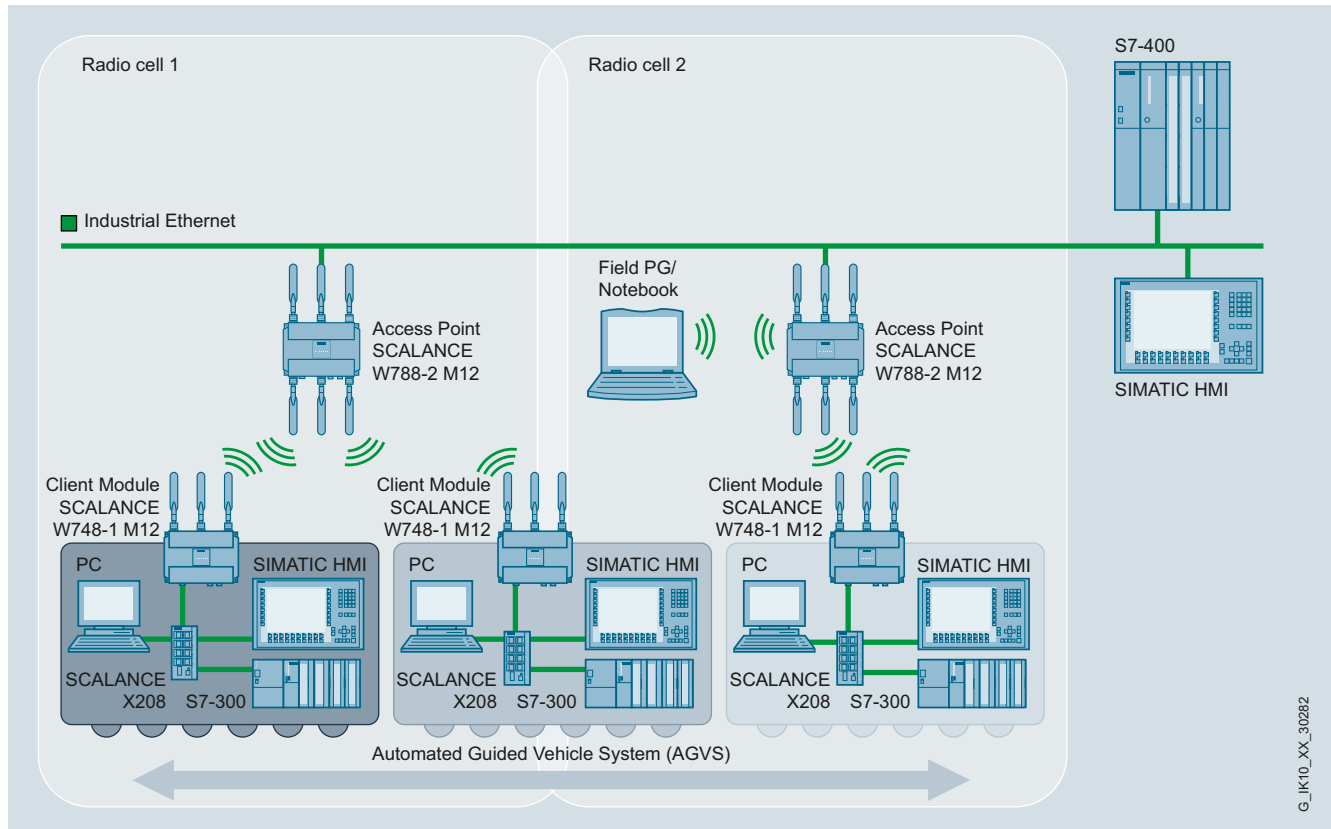

Roaming devices (e.g. Field PG and mobile controller) in a wireless network with two access points

G\_IK10\_XX\_30282

### Technical specifications

Article No.	6GK5788-1GD00-0AA0 6GK5788-1GD00-0AB0 <sup>1)</sup>	6GK5788-2GD00-0AA0 6GK5788-2GD00-0AB0 <sup>1)</sup>
Product-type designation	SCALANCE W788-1 M12	SCALANCE W788-2 M12
<b>Transmission rate</b>		
Transmission rate		
• with W-LAN maximum	450 Mbit/s	450 Mbit/s
• with Industrial Ethernet	10 ... 1 000 Mbit/s	10 ... 1 000 Mbit/s
• note	-	-
<b>Interfaces</b>		
Number of electrical connections		
• for network components and terminal equipment	1	1
• for power supply	1	1
• for redundant power supply	1	1
Design of electrical connection		
• for network components and terminal equipment	M12 interface (8-pole, A-coded)	M12 interface (8-pole, A-coded)
• for power supply	M12 interface (4-pole, A-coded)	M12 interface (4-pole, A-coded)
Number of optical interfaces for optical waveguide at 100 Mbit/s	-	-
Design of optical interface for optical waveguide at 100 Mbit/s	-	-
design of the removable storage C-PLUG	Yes	Yes
<b>Interfaces wireless</b>		
Number of radio cards permanently installed	1	2
Number of internal antennas	-	-
Number of electrical connections for external antenna(s)	3	6
Design of the electrical connection for external antenna(s)	N-Connect (socket)	N-Connect (socket)
Product property external antenna can be mounted directly on device	Yes	Yes
<b>Supply voltage, current consumption, power loss</b>		
Type of supply voltage	DC	DC
Supply voltage		
• 1 from M12 Power Connector (A-coded) for redundant power supply	19.2 V	19.2 V
• 2 from M12 Power Connector (A-coded) for redundant power supply	28.8 V	28.8 V
• from Power-over-Ethernet according IEEE802.3at for type 1 and IEEE802.3af	48 V	48 V
• from Power-over-Ethernet according IEEE802.3at for type 2	50 V	50 V
Current consumed		
• at 24 V with DC typical	0.45 A	0.63 A
• with Power-over-Ethernet according to IEEE802.3at for type 1 and IEEE802.3af typical	0.22 A	0.22 A
• with Power-over-Ethernet according to IEEE802.3at for type 2 typical	-	0.3 A
Effective power loss		
• at 24V for DC typical	10.7 W	15 W
• with Power-over-Ethernet according to IEEE802.3at for type 1 and IEEE802.3af typical	-	10.7 W
• with Power-over-Ethernet according to IEEE802.3at for type 2 typical	-	15 W

<sup>1)</sup> Wireless approval in the USA

## Industrial Wireless Communication

### IWLAN – Access Points IEEE 802.11n

#### SCALANCE W788 M12 for indoor use

#### Technical specifications (continued)

Article No.	6GK5788-1GD00-0AA0 6GK5788-1GD00-0AB0 <sup>1)</sup>	6GK5788-2GD00-0AA0 6GK5788-2GD00-0AB0 <sup>1)</sup>
Product-type designation	SCALANCE W788-1 M12	SCALANCE W788-2 M12
<b>Permitted ambient conditions</b>		
Ambient temperature		
• during operating	-20 ... +60 °C	-20 ... +60 °C
• during storage	-40 ... +70 °C	-40 ... +70 °C
• during transport	-40 ... +70 °C	-40 ... +70 °C
Relative humidity at 25 °C without condensation during operating maximum	90 %	90 %
Protection class IP	IP65	IP65
Ambient condition for (standard) operation mode	When used under hazardous conditions (Zone 2), the SCALANCE W788-xPRO/RR or W74x-1PRO/RR product must be installed in an enclosure. To comply with EN 50021, this enclosure must meet the requirements of at least IP 54 in compliance with EN 60529.	When used under hazardous conditions (Zone 2), the SCALANCE W788-xPRO/RR or W74x-1PRO/RR product must be installed in an enclosure. To comply with EN 50021, this enclosure must meet the requirements of at least IP 54 in compliance with EN 60529.
<b>Design, dimensions and weight</b>		
Width of enclosure without antenna	200 mm	200 mm
Height of enclosure without antenna	176 mm	176 mm
Depth of enclosure without antenna	79 mm	79 mm
Net weight	1.7 kg	1.7 kg
Mounting type wall mounting	Yes	Yes
<b>Wireless frequencies</b>		
Radio frequency		
• for WLAN in 2.4 GHz frequency band	2.41 ... 2.48 GHz	2.41 ... 2.48 GHz
• for WLAN in 5 GHz frequency band	4.9 ... 5.8 GHz	4.9 ... 5.8 GHz
<b>Product properties, functions, components general</b>		
Product function		
• Access Point Mode	Yes	Yes
• Client Mode	Yes	Yes
Number of SSIDs	8	16
Product function		
• iPCF Access Point	Yes	Yes
• iPCF client	Yes	Yes
• iPCF-MC Access Point	in preparation	in preparation
• iPCF-MC client	in preparation	in preparation
Number of iPCF-capable radio modules	1	2

<sup>1)</sup> Wireless approval in the USA

### Technical specifications (continued)

Article No.	6GK5788-1GD00-0AA0 6GK5788-1GD00-0AB0 <sup>1)</sup>	6GK5788-2GD00-0AA0 6GK5788-2GD00-0AB0 <sup>1)</sup>
Product-type designation	SCALANCE W788-1 M12	SCALANCE W788-2 M12
<b>Product functions management, configuration</b>		
Number of manageable IP addresses in client	8	8
Product function		
• CLI	Yes	Yes
• web-based management	Yes	Yes
• MIB support	Yes	Yes
• TRAPs via email	Yes	Yes
• Configuration with STEP 7	in preparation	in preparation
• configuration with STEP 7 in the TIA Portal	in preparation	in preparation
• operation with IWLAN controller	No	No
• operation with Enterasys WLAN controller	No	No
• forced roaming with IWLAN	Yes	Yes
• WDS	Yes	Yes
Protocol is supported		
• Address Resolution Protocol (ARP)	Yes	Yes
• ICMP	Yes	Yes
• Telnet	Yes	Yes
• HTTP	Yes	Yes
• HTTPS	Yes	Yes
• TFTP	Yes	Yes
• SNMP v1	Yes	Yes
• SNMP v2	Yes	Yes
• SNMP v3	Yes	Yes
• DCP	Yes	Yes
• LLDP	Yes	Yes
Identification & maintenance function		
• I&M0 - device-specific information	Yes	Yes
• I&M1 – higher level designation/ location designation	Yes	Yes
<b>Product functions Diagnosis</b>		
Product function		
• PROFINET IO diagnosis	in preparation	in preparation
• localization via Aeroscout	in preparation	in preparation
• SysLog	Yes	Yes
<b>Product functions VLAN</b>		
Product function function VLAN with IWLAN	Yes	Yes
<b>Product functions DHCP</b>		
Product function		
• DHCP client	Yes	Yes
• in Client Mode DHCP server via LAN	No	No
<b>Product functions Redundancy</b>		
Protocol is supported STP/RSTP	Yes	Yes

<sup>1)</sup> Wireless approval in the USA

## Industrial Wireless Communication

### IWLAN – Access Points IEEE 802.11n

#### SCALANCE W788 M12 for indoor use

#### Technical specifications (continued)

Article No.	6GK5788-1GD00-0AA0 6GK5788-1GD00-0AB0 <sup>1)</sup>	6GK5788-2GD00-0AA0 6GK5788-2GD00-0AB0 <sup>1)</sup>
Product-type designation	SCALANCE W788-1 M12	SCALANCE W788-2 M12
<b>Product functions Security</b>		
Product function		
• ACL - MAC-based	-	-
• Management security, ACL-IP based	Yes	Yes
• IEEE 802.1x (radius)	Yes	Yes
• NAT/NAPT	No	No
• access protection according to IEEE802.11i	Yes	Yes
• WPA/WPA2	Yes	Yes
• TKIP/AES	Yes	Yes
Protocol is supported SSH	Yes	Yes
<b>Product functions Time</b>		
Protocol is supported		
• SNTP	Yes	Yes
• SIMATIC Time	Yes	Yes
<b>Standards, specifications, approvals</b>		
Standard		
• for hazardous zone	EN 60079-15:2005, EN 60079-0:2006, II 3 G Ex nA II T4 KEMA 07 ATEX 0145X	EN 60079-15:2005, EN 60079-0:2006, II 3 G Ex nA II T4 KEMA 07 ATEX 0145X
• for safety of CSA and UL	UL 60950-1 CSA C22.2 No. 60950-1	UL 60950-1 CSA C22.2 No. 60950-1
Verification of suitability		
• CE mark	Yes	Yes
• EC declaration of conformity	Yes	Yes
• C-Tick	Yes	Yes
• CCC	No	No
• Railway application in accordance with EN 50155	No	No
• e1 approval		No
• E1 approval	No	No
• NEMA4X	No	No
• Power-over-Ethernet according IEEE802.3at for type 1 and IEEE802.3af	Yes	Yes
• Power-over-Ethernet according to IEEE802.3at for type 2	Yes	Yes
Standard for wireless communication		
• IEEE 802.11a	Yes	Yes
• IEEE 802.11b	Yes	Yes
• IEEE 802.11e	Yes	Yes
• IEEE 802.11g	Yes	Yes
• IEEE 802.11h	Yes	Yes
• IEEE 802.11i	Yes	Yes
• IEEE 802.11n	Yes	Yes
Wireless approval	You will find the current list of countries at: <a href="http://www.siemens.com/wireless-approvals">www.siemens.com/wireless-approvals</a>	You will find the current list of countries at: <a href="http://www.siemens.com/wireless-approvals">www.siemens.com/wireless-approvals</a>
<b>Accessories</b>		
Accessories	-	-

<sup>1)</sup> Wireless approval in the USA



Ordering data	Article No.	Article No.
<b>SCALANCE W788 M12 access points</b>		<b>Accessories</b>
IWLAN access points with built-in wireless interfaces; wireless networks IEEE 802.11a/b/g/h/n at 2.4/5 GHz up to 450 Mbit/s; WPA2/AES; Power over Ethernet (PoE), IP65 degree of protection (-20 °C to +60 °C); scope of delivery: Mounting hardware; manual on CD-ROM, German/English		<b>KEY-PLUG W780 iFeatures</b> 6GK5907-8PA00 Swap medium for enabling additional iFeatures, for simple device replacement if a fault occurs and for storage of configuration data; Can be used in SCALANCE W access points with PLUG compartment
<b>SCALANCE W788-1 M12</b>		<b>C-PLUG</b> 6GK1900-0AB0 Swap medium for simple replacement of devices in the event of a fault; for storing configuration data; can be used in SIMATIC NET products with PLUG compartment
IWLAN access point with <u>one</u> integrated wireless interface	6GK5788-1GD00-0AA0	<b>DIN rail mounting adapter</b> 6GK5798-8ML00-0AB3 DIN rail mounting adapter for SCALANCE W788 M12 and SCALANCE W788 RJ45; screw fixing for mounting on a 35 mm DIN rail to EN 50 022; scope of supply: 3 units per pack
<ul style="list-style-type: none"> <li>National approvals for operation outside the USA</li> <li>National approvals for operation within the USA <sup>1)</sup></li> </ul>	6GK5788-1GD00-0AB0	<b>IE FC M12 Plug PRO 4 x 2</b> M12 plug-in connector suitable for on-site assembly (X-coded, IP65/IP67), metal enclosure, insulation displacement fast connection method, for SCALANCE W
<b>SCALANCE W788-2 M12</b>		<ul style="list-style-type: none"> <li>1 unit</li> <li>8 units</li> </ul>
IWLAN dual access point with <u>two</u> integrated wireless interfaces	6GK5788-2GD00-0AA0	<b>IE FC Standard Cable GP 4 x 2</b> 6XV1878-2A 8-core, shielded TP installation cable for connection to IE FC RJ45 Plug 4 x 2 and IE M12 Plug PRO 4 x 2; PROFINET-compatible; with UL approval; sold by the meter; max. length 1 000 m, minimum order quantity 20 m
<ul style="list-style-type: none"> <li>National approvals for operation outside the USA</li> <li>National approvals for operation within the USA <sup>1)</sup></li> </ul>	6GK5788-2GD00-0AB0	<b>IE FC Stripping Tool</b> 6GK1901-1GA00 Preadjusted stripping tool for fast stripping of the Industrial Ethernet FC cables
		<b>Power M12 Cable Connector PRO</b> 6GK1907-0DC10-6AA3 Terminal socket for connection of SCALANCE W700 for 24 V DC supply voltage; 4-pole, A-coded, with assembly instructions, 3 units
		<b>Power Cable 2 x 0.75</b> 6XV1812-8A Connecting cable for Power M12 Cable Connector PRO, sold by the meter
		<b>Antennas and miscellaneous IWLAN accessories</b> See Industrial Wireless LAN/ accessories

<sup>1)</sup> Please note national approvals under <http://www.siemens.com/wireless-approvals>

### More information

#### Selection tools:

To assist in selecting Industrial Ethernet components, the TIA Selection Tool is available at: <http://www.siemens.com/tia-selection-tool>

#### Wireless approvals:

Current approvals can be found on the Internet at: <http://www.siemens.com/wireless-approvals>

## Industrial Wireless Communication

### IWLAN – Access Points IEEE 802.11n

#### SCALANCE W788 M12 EEC for enhanced environmental conditions

##### Overview



- Suitable for use in the industry and automation area, but especially in the railroad environment

##### Design

- Rugged aluminum enclosure, shock and vibration-proof, for high mechanical requirements
- Special coating of the printed circuit boards (conformal coating)
- Resistant to condensation
- Railway approval in accordance with EN 50155 and NEMA TS2
- High IP65 degree of protection against dust and water jets
- For use at ambient temperatures from -40 °C to +70 °C
- 6 x N-Connect sockets for the connection of direct mountable and remote antennas
- Antenna placement optimized for the 3x3 MIMO technology; the antennas do not interfere with each other when they are mounted directly on the device
- Suitable for 2.4 GHz and 5 GHz
- 1 x M12 connection for 10/100/1 000 Mbit/s with Power-over-Ethernet according to IEEE 802.3at
- 1 x M12 socket for power supply (24 V DC)
- 1 x C-PLUG compartment (KEY-PLUG/C-PLUG)
- Function LEDs for optical signaling of faults/errors and operating statuses
- Mounting: Wall, S7-1500 mounting rail, S7-300 mounting rail, or on 35 mm standard mounting rail

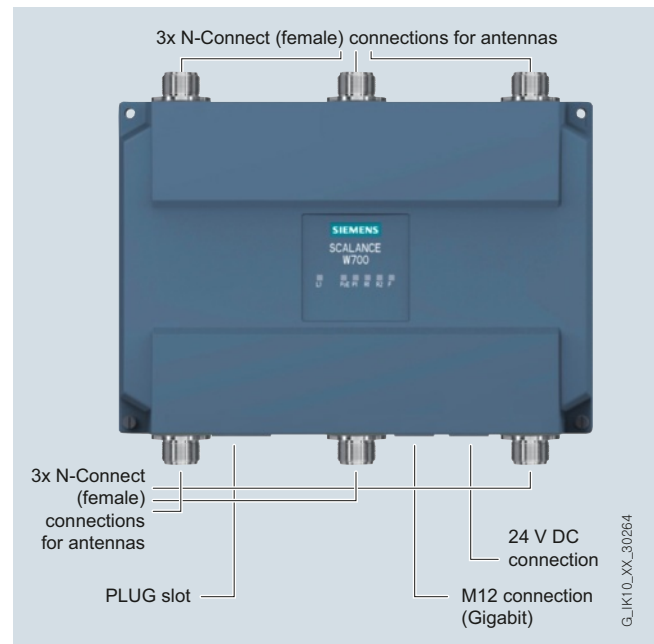

Design and interfaces of the SCALANCE W788-2 M12 EEC access points

##### Product version

##### SCALANCE W788-2 M12 EEC

- Two radio cards are permanently installed; functional scope can be expanded by using a KEY-PLUG W780 iFeatures

#### Function

The SCALANCE W788 M12 EEC (Extended Environmental Conditions) are designed for use in railway applications. The devices satisfy EN 50155, the approval for railway applications, and can thus be used for rail traffic. The devices also have an extended temperature range from -40 °C to +70 °C. Combined with the railway-approved antennas, which are connected via the N-Connect antenna connections (female), these products can establish a reliable IWLAN wireless infrastructure outdoors.

The devices can be installed at the location that is most favorable for the wireless link. The enclosure and the connectors are resistant to high levels of shock and vibration because all the connectors are screwed. Thanks to Conformal Coating and IP65 degree of protection, SCALANCE W788 M12 EEC is ideally suited for environments with widely varying temperatures and where protection against dust and water play an important role. To achieve optimal coverage for special applications, the complete range of SCALANCE W antennas is available. Some antennas even have railway certification.

SCALANCE W788-2 M12 EEC access points can also be operated as client modules.

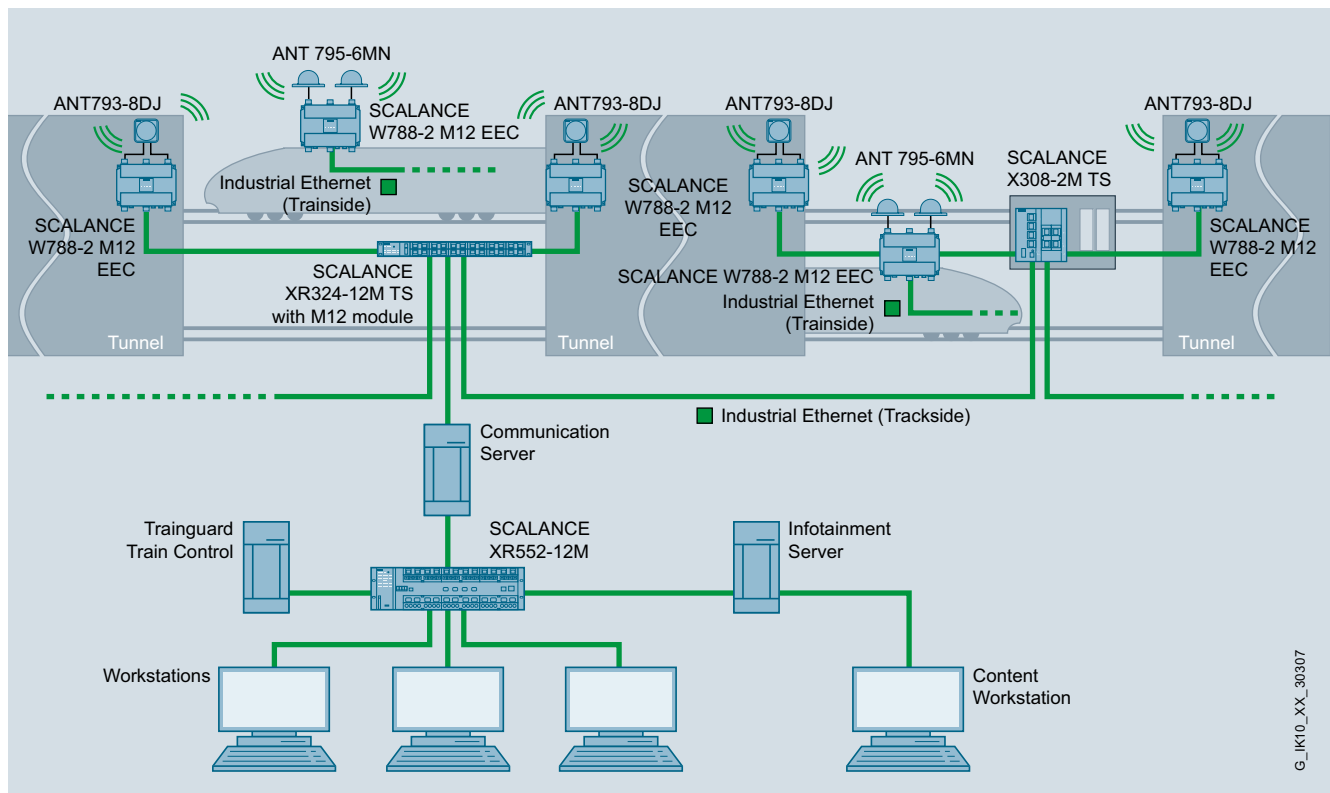

Data transmission on trains using the SCALANCE W788 M12 EEC access points with railway certification

Provided that a delay (several 100 ms) caused by roaming in accordance with IEEE 802.11 is tolerated by all communication stations when switching the radio cells, the communication continues uninterrupted.

For real-time requirements, the SCALANCE W788 M12 EEC can be equipped with KEY-PLUG functionality for activating iFeatures.

# Industrial Wireless Communication

## IWLAN – Access Points IEEE 802.11n

### SCALANCE W788 M12 EEC for enhanced environmental conditions

#### Technical specifications

Article No.	6GK5788-2GD00-0TA0 6GK5788-2GD00-0TB0 <sup>1)</sup>
Product-type designation	SCALANCE W788-2 M12 EEC
<b>Transmission rate</b>	
Transmission rate	450 Mbit/s
• with W-LAN maximum	10 ... 1 000 Mbit/s
• with Industrial Ethernet	-
• note	-
<b>Interfaces</b>	
Number of electrical connections	1
• for network components and terminal equipment	1
• for power supply	1
• for redundant power supply	1
Design of the electrical connection	M12 interface (8-pole, X-coded), PoE
• for network components and terminal equipment	M12 interface (4-pole, A-coded)
• for power supply	
Number of optical interfaces for optical waveguide at 100 Mbit/s	-
Design of optical interface for optical waveguide at 100 Mbit/s	-
Design of the removable storage C-PLUG	Yes
<b>Interfaces wireless</b>	
Number of radio cards permanently installed	2
Number of internal antennas	-
Number of electrical connections for external antenna(s)	6
Design of the electrical connection for external antenna(s)	N-Connect (socket)
Product property external antenna can be mounted directly on device	Yes
<b>Supply voltage, current consumption, power loss</b>	
Type of supply voltage	DC
Supply voltage	19.2 V
• 1 from M12 Power Connector (A-coded) for redundant power supply	28.8 V
• 2 from M12 Power Connector (A-coded) for redundant power supply	48 V
• from Power-over-Ethernet according IEEE802.3at for type 1 and IEEE802.3af	50 V
• from Power-over-Ethernet according IEEE802.3at for type 2	
Current consumed	0.63 A
• at 24 V with DC typical	0.22 A
• with Power-over-Ethernet according to IEEE802.3at for type 1 and IEEE802.3af typical	0.3 A
• with Power-over-Ethernet according to IEEE802.3at for type 2 typical	
Effective power loss	15 W
• at 24V for DC typical	10.7 W
• with Power-over-Ethernet according to IEEE802.3at for type 1 and IEEE802.3af typical	15 W
• with Power-over-Ethernet according to IEEE802.3at for type 2 typical	

Article No.	6GK5788-2GD00-0TA0 6GK5788-2GD00-0TB0 <sup>1)</sup>
Product-type designation	SCALANCE W788-2 M12 EEC
<b>Permitted ambient conditions</b>	
Ambient temperature	-20 ... +60 °C
• during operating	-40 ... +70 °C
• during storage	-40 ... +70 °C
• during transport	
Relative humidity at 25 °C without condensation during operating maximum	90 %
Protection class IP	IP65
Ambient condition for (standard) operation mode	When used under hazardous conditions (Zone 2), the SCALANCE W788-xPRO/RR or W74x-1PRO/RR product must be installed in an enclosure. To comply with EN 50021, this enclosure must meet the requirements of at least IP54 in compliance with EN 60529.
<b>Design, dimensions and weight</b>	
Width of enclosure without antenna	200 mm
Height of enclosure without antenna	176 mm
Depth of enclosure without antenna	79 mm
Net weight	1.7 kg
Mounting type wall mounting	Yes
<b>Wireless frequencies</b>	
Radio frequency	2.41 ... 2.48 GHz
• for WLAN in 2.4 GHz frequency band	4.9 ... 5.8 GHz
• for WLAN in 5 GHz frequency band	
<b>Product properties, functions, components general</b>	
Product function	Yes
• Access Point Mode	Yes
• Client Mode	
Number of SSIDs	16
Product function	Yes
• iPCF Access Point	Yes
• iPCF client	in preparation
• iPCF-MC Access Point	in preparation
• iPCF-MC client	
Number of iPCF-capable radio modules	0

### Technical specifications (continued)

Article No.	6GK5788-2GD00-0TA0 6GK5788-2GD00-0TB0 <sup>1)</sup>	Article No.	6GK5788-2GD00-0TA0 6GK5788-2GD00-0TB0 <sup>1)</sup>
<b>Product-type designation</b>	<b>SCALANCE W788-2 M12 EEC</b>	<b>Product-type designation</b>	<b>SCALANCE W788-2 M12 EEC</b>
<b>Product functions management, configuration</b>		<b>Product functions Security</b>	
Number of manageable IP addresses in client	8	Product function	
Product function		• ACL - MAC-based	-
• CLI	Yes	• Management security, ACL-IP based	Yes
• web-based management	Yes	• IEEE 802.1x (radius)	Yes
• MIB support	Yes	• NAT/NAPT	No
• TRAPs via email	Yes	• access protection according to IEEE802.11i	Yes
• Configuration with STEP 7	in preparation	• WPA/WPA2	Yes
• configuration with STEP 7 in the TIA Portal	in preparation	• TKIP/AES	Yes
• operation with IWLAN controller	No	Protocol is supported SSH	Yes
• operation with Enterasys WLAN controller	No	<b>Product functions Time</b>	
• forced roaming with IWLAN	Yes	Protocol is supported	
• WDS	Yes	• SNTP	Yes
Protocol is supported		• SIMATIC Time	Yes
• Address Resolution Protocol (ARP)	Yes	<b>Standards, specifications, approvals</b>	
• ICMP	Yes	Standard	
• Telnet	Yes	• for hazardous zone	-
• HTTP	Yes	• for safety of CSA and UL	UL 60950-1 CSA C22.2 No. 60950-1
• HTTPS	Yes	Verification of suitability	
• TFTP	Yes	• CE mark	Yes
• SNMP v1	Yes	• EC declaration of conformity	Yes
• SNMP v2	Yes	• C-Tick	Yes
• SNMP v3	Yes	• CCC	-
• DCP	Yes	• Railway application in accordance with EN 50155	Yes
• LLDP	Yes	• e1 approval	No
Identification & maintenance function		• E1 approval	No
• I&M0 - device-specific information	Yes	• NEMA4X	No
• I&M1 – higher level designation/location designation	Yes	• Power-over-Ethernet according IEEE802.3at for type 1 and IEEE802.3af	Yes
<b>Product functions Diagnosis</b>		• Power-over-Ethernet according to IEEE802.3at for type 2	Yes
Product function		Standard for wireless communication	
• PROFINET IO diagnosis	in preparation	• IEEE 802.11a	Yes
• localization via Aeroscout	in preparation	• IEEE 802.11b	Yes
• SysLog	Yes	• IEEE 802.11e	Yes
<b>Product functions VLAN</b>		• IEEE 802.11g	Yes
Product function function VLAN with IWLAN	Yes	• IEEE 802.11h	Yes
<b>Product functions DHCP</b>		• IEEE 802.11i	Yes
Product function		• IEEE 802.11n	Yes
• DHCP client	Yes	Wireless approval	You will find the current list of countries at: <a href="http://www.siemens.com/wireless-approvals">www.siemens.com/wireless-approvals</a>
• in Client Mode DHCP server via LAN	No		
<b>Product functions Redundancy</b>			
Protocol is supported STP/RSTP	Yes		

<sup>1)</sup> Wireless approval in the USA

## Industrial Wireless Communication

### IWLAN – Access Points IEEE 802.11n

#### SCALANCE W788 M12 EEC for enhanced environmental conditions

#### Ordering data

##### SCALANCE W788 M12 EEC access points

IWLAN access points with built-in wireless interfaces; wireless networks IEEE 802.11a/b/g/h/n at 2.4/5 GHz up to 450 Mbit/s; railway approval in accordance with EN 50155 / NEMA TS2; conformal coating; WPA2/AES; Power over Ethernet (PoE), IP65 degree of protection; scope of supply: Mounting hardware; manual on CD-ROM, German/English

##### SCALANCE W788-2 M12 EEC

IWLAN dual access point with two integrated wireless interfaces

- National approvals for operation outside the USA
- National approvals for operation within the USA <sup>1)</sup>

##### Accessories

##### KEY-PLUG W780 iFeatures

Swap medium for enabling additional iFeatures, for simple device replacement if a fault occurs and for storage of configuration data; Can be used in SCALANCE W access points with PLUG compartment

##### C-PLUG

Swap medium for simple replacement of devices in the event of a fault; for storing configuration data; can be used in SIMATIC NET products with PLUG compartment

##### DIN rail mounting adapter

DIN rail mounting adapter for SCALANCE W788 M12 and SCALANCE W788 RJ45; screw fixing for mounting on a 35 mm DIN rail to EN 50 022; scope of supply: 3 units per pack

#### Article No.

6GK5788-2GD00-0TA0

6GK5788-2GD00-0TB0

6GK5907-8PA00

6GK1900-0AB00

6GK5798-8ML00-0AB3

#### Article No.

##### IE FC M12 Plug PRO 4 x 2

M12 plug-in connector suitable for on-site assembly (X-coded, IP65/IP67), metal enclosure, insulation displacement fast connection method, for SCALANCE W

- 1 unit
- 8 units

6GK1901-0DB30-6AA0

6GK1901-0DB30-6AA8

##### IE FC Standard Cable GP 4 x 2

8-core, shielded TP installation cable for connection to IE FC RJ45 Plug 4 x 2 and IE M12 Plug PRO 4 x 2; PROFINET-compatible; with UL approval; sold by the meter; max. length 1 000 m, minimum order quantity 20 m

6XV1878-2A

##### IE FC Stripping Tool

Preadjusted stripping tool for fast stripping of the Industrial Ethernet FC cables

6GK1901-1GA00

##### Power M12 Cable Connector PRO

Terminal socket for connection of SCALANCE W700 for 24 V DC supply voltage; 4-pole, A-coded, with assembly instructions, 3 units

6GK1907-0DC10-6AA3

##### Power Cable 2 x 0.75

Connecting cable for Power M12 Cable Connector PRO, sold by the meter

6XV1812-8A

##### Antennas and miscellaneous IWLAN accessories

See Industrial Wireless LAN/ accessories

<sup>1)</sup> Please note national approvals under <http://www.siemens.com/wireless-approvals>

#### More information

##### Selection tools:

To assist in selecting Industrial Ethernet components, the TIA Selection Tool is available at: <http://www.siemens.com/tia-selection-tool>

##### Wireless approvals:

Current approvals can be found on the Internet at: <http://www.siemens.com/wireless-approvals>

#### Overview



- Particularly well-suited to applications with high climatic requirements when installed outdoors and in areas accessible to the public

#### Design

- Rugged, impact-resistant plastic enclosure, shock and vibration-proof for demanding mechanical requirements
- High IP65 degree of protection against dust and water jets
- For use at ambient temperatures from -40 °C to +60 °C
- Resistant to condensation
- Resistant to UV radiation and saltwater spray
- Design for use outdoors
- 3 x R-SMA sockets for the connection of remote antennas (6 x R-SMA sockets or six internal antennas for the variants with two wireless modules)
- Suitable for 2.4 GHz and 5 GHz
- 1 x RJ45 connector for 10/100/1 000 Mbit/s and Power-over-Ethernet according to IEEE 802.3at
- 1 x 24 V DC connector, optional operation with 12 to 24 V DC or 100 to 240 V AC with power supply that can be integrated in the device
- 1 x PLUG compartment (KEY-PLUG/C-PLUG)
- Function LEDs for optical signaling of faults/errors and operating statuses
- Resistant to destruction through connections within the device
- Mounting: Wall or, with optional mounting set, on S7 mounting rail, 35 mm standard mounting rail, or on a pole

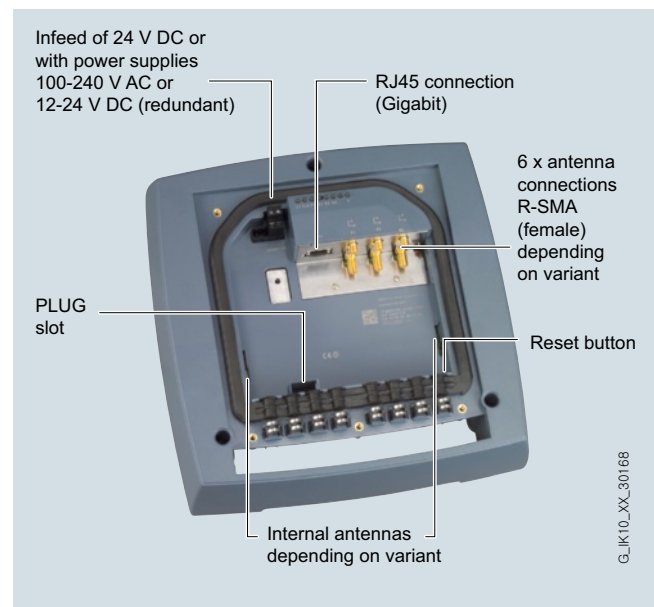

Design and interfaces of the SCALANCE W786 access points

#### Product versions

##### SCALANCE W786-1 RJ45

- A radio card is permanently installed; functional scope can be expanded by using a KEY-PLUG W780 iFeatures

##### SCALANCE W786-2 RJ45

- Two radio cards are permanently installed; functional scope can be expanded by using a KEY-PLUG W780 iFeatures

##### SCALANCE W786-2IA RJ45

- Two radio cards are permanently installed in the device; six internal antennas; functional scope can be expanded by using a KEY-PLUG W780 iFeatures

## Industrial Wireless Communication

### IWLAN – Access Points IEEE 802.11n

#### SCALANCE W786 RJ45 for outdoor use

#### Function

In the case of access points with two wireless modules, one module implements communication of the access points with each other. The radio link for the stations, e.g. a mobile crane system, is established by the second wireless module. Wireless coverage of larger areas can therefore be provided with the same device.

In the case of SCALANCE W786, this only concerns access points which can, however, be configured as client modules through Web-based management. Then, depending on the selected variant, a maximum of one radio module will be available as a client.

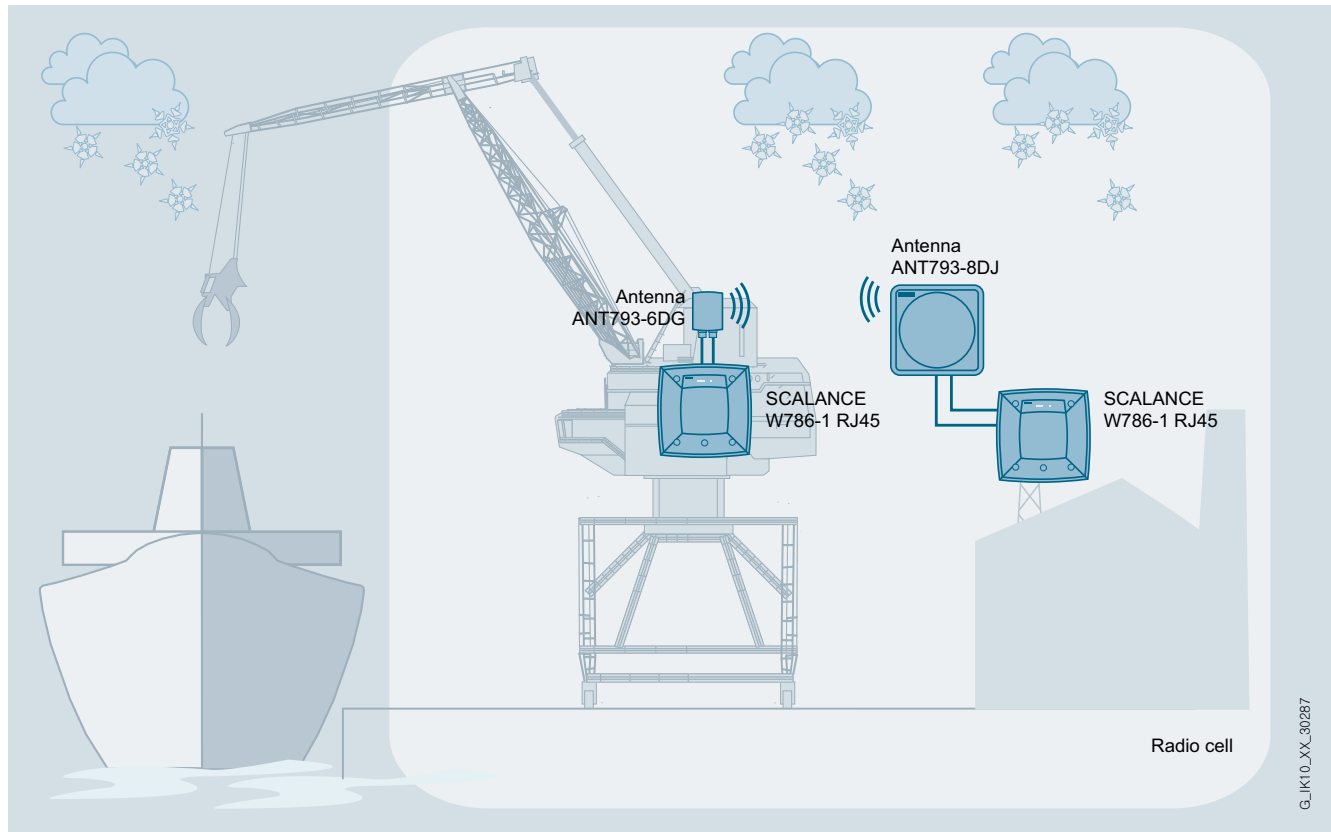

Use of the SCALANCE W786 product line in areas subject to demanding climatic requirements

G.JIK10\_XX\_30287



### Technical specifications

Article No.	6GK5786-1FC00-0AA0 6GK5786-1FC00-0AB0 <sup>1)</sup>	6GK5786-2HC00-0AA0 6GK5786-2HC00-0AB0 <sup>1)</sup>	6GK5786-2FC00-0AA0 6GK5786-2FC00-0AB0 <sup>1)</sup>
Product-type designation	SCALANCE W786-1 RJ45	SCALANCE W786-2IA RJ45	SCALANCE W786-2 RJ45
<b>Transmission rate</b>			
Transmission rate			
• with W-LAN maximum	450 Mbit/s	450 Mbit/s	450 Mbit/s
• with Industrial Ethernet	10 ... 1 000 Mbit/s	10 ... 1 000 Mbit/s	10 ... 1 000 Mbit/s
• note	-	-	-
<b>Interfaces</b>			
Number of electrical connections			
• for network components and terminal equipment	1	1	1
• for power supply	1	1	1
• for redundant power supply	1	1	1
Design of electrical connection			
• for network components and terminal equipment	RJ45 socket	RJ45 socket	RJ45 socket
• for power supply	2-pole connector (24 V DC) or optionally available power supply adapter (4-pole 24 V DC or 3-pole 110 to 230 V AC)	2-pole connector (24 V DC) or optionally available power supply adapter (4-pole 24 V DC or 3-pole 110 to 230 V AC)	2-pole connector (24 V DC) or optionally available power supply adapter (4-pole 24 V DC or 3-pole 110 to 230 V AC)
Number of optical interfaces for optical waveguide at 100 Mbit/s	-	-	-
Design of optical interface for optical waveguide at 100 Mbit/s	-	-	-
Number of optical interfaces for optical waveguide at 1 000 Mbit/s	-	-	-
Design of optical interface for optical waveguide at 1 000 Mbit/s	-	-	-
design of the removable storage C-PLUG	Yes	Yes	Yes
<b>Interfaces wireless</b>			
Number of radio cards permanently installed	1	2	2
Number of internal antennas	-	6	-
Number of electrical connections for external antenna(s)	3	-	6
Design of the electrical connection for external antenna(s)	R-SMA (socket)	-	R-SMA (socket)
Product property external antenna can be mounted directly on device	No	-	No

<sup>1)</sup> Wireless approval in the USA

## Industrial Wireless Communication

### IWLAN – Access Points IEEE 802.11n

#### SCALANCE W786 RJ45 for outdoor use

#### Technical specifications (continued)

Article No.	6GK5786-1FC00-0AA0 6GK5786-1FC00-0AB0 <sup>1)</sup>	6GK5786-2HC00-0AA0 6GK5786-2HC00-0AB0 <sup>1)</sup>	6GK5786-2FC00-0AA0 6GK5786-2FC00-0AB0 <sup>1)</sup>
Product-type designation	SCALANCE W786-1 RJ45	SCALANCE W786-2IA RJ45	SCALANCE W786-2 RJ45
<b>Supply voltage, current consumption, power loss</b>			
Type of supply voltage	DC	DC	DC
Supply voltage			
• 1 from terminal block	19.2 V	19.2 V	19.2 V
• 2 from terminal block	28.8 V	28.8 V	28.8 V
• from Power-over-Ethernet according to IEEE802.3at for type 1 and IEEE802.3af	48 V	48 V	48 V
• from Power-over-Ethernet according to IEEE802.3at for type 2	50 V	50 V	50 V
• from optional integratable power supply			
- with AC	100 ... 240 V	100 ... 240 V	100 ... 240 V
- with DC	12 ... 24 V	12 ... 24 V	12 ... 24 V
Current consumed			
• at 24 V with DC typical	0.45 A	0.63 A	0.63 A
• at 230 V with AC typical	0.05 A	0.07 A	0.07 A
• with Power-over-Ethernet according to IEEE802.3at for type 1 and IEEE802.3af typical	0.22 A	0.22 A	0.22 A
• with Power-over-Ethernet according to IEEE802.3at for type 2 typical	-	-	-
Effective power loss			
• at 24V for DC typical	10.7 W	15 W	15 W
• at 230 V with AC typical	10.7 W	15 W	15 W
• with Power-over-Ethernet according to IEEE802.3at for type 1 and IEEE802.3af typical	10.7 W	15 W	10.7 W
• with Power-over-Ethernet according to IEEE802.3at for type 2 typical	-	-	-
<b>Permitted ambient conditions</b>			
Ambient temperature			
• during operating	-40 ... +60 °C	-40 ... +60 °C	-40 ... +60 °C
• during storage	-40 ... +85 °C	-40 ... +85 °C	-40 ... +85 °C
• during transport	-40 ... +85 °C	-40 ... +85 °C	-40 ... +85 °C
Relative humidity at 25 °C without condensation during operating maximum	100 %	100 %	100 %
Protection class IP	IP65	IP65	IP65
Ambient condition for (standard) operation mode	When using the power supply 100 to 240 V AC, an operating temperature of -40 °C to +60 °C is permissible	When using the power supply 100 to 240 V AC, an operating temperature of -40 °C to +60 °C is permissible	When using the power supply 100 to 240 V AC, an operating temperature of -40 °C to +60 °C is permissible
<b>Design, dimensions and weight</b>			
Width of enclosure without antenna	251 mm	251 mm	251 mm
Height of enclosure without antenna	251 mm	251 mm	251 mm
Depth of enclosure without antenna	72 mm	72 mm	72 mm
Net weight	2.24 kg	2.24 kg	2.24 kg
Mounting type wall mounting	Yes	Yes	Yes
Mounting type	For mast mounting, 35 mm DIN rail mounting and S7-300 rail mounting, an additional support plate is required	For mast mounting, 35 mm DIN rail mounting and S7-300 rail mounting, an additional support plate is required	For mast mounting, 35 mm DIN rail mounting and S7-300 rail mounting, an additional support plate is required
<b>Wireless frequencies</b>			
Radio frequency			
• for WLAN in 2.4 GHz frequency band	2.41 ... 2.48 GHz	2.41 ... 2.48 GHz	2.41 ... 2.48 GHz
• for WLAN in 5 GHz frequency band	4.9 ... 5.8 GHz	4.9 ... 5.8 GHz	4.9 ... 5.8 GHz

<sup>1)</sup> Wireless approval in the USA

### Technical specifications (continued)

Article No.	6GK5786-1FC00-0AA0 6GK5786-1FC00-0AB0 <sup>1)</sup>	6GK5786-2HC00-0AA0 6GK5786-2HC00-0AB0 <sup>1)</sup>	6GK5786-2FC00-0AA0 6GK5786-2FC00-0AB0 <sup>1)</sup>
Product-type designation	SCALANCE W786-1 RJ45	SCALANCE W786-2IA RJ45	SCALANCE W786-2 RJ45
<b>Product properties, functions, components general</b>			
Product function			
• Access Point Mode	Yes	Yes	Yes
• Client Mode	Yes	Yes	Yes
Number of SSIDs	8	16	16
Product function			
• iPCF Access Point	Yes	Yes	Yes
• iPCF client	Yes	Yes	Yes
• iPCF-MC Access Point	in preparation	in preparation	in preparation
• iPCF-MC client	in preparation	in preparation	in preparation
Number of iPCF-capable radio modules	1	2	2
<b>Product functions management, configuration</b>			
Number of manageable IP addresses in client	8	8	8
Product function			
• CLI	Yes	Yes	Yes
• web-based management	Yes	Yes	Yes
• MIB support	Yes	Yes	Yes
• TRAPs via email	Yes	Yes	Yes
• Configuration with STEP 7	in preparation	in preparation	in preparation
• configuration with STEP 7 in the TIA Portal	in preparation	in preparation	in preparation
• operation with IWLAN controller	No	No	No
• operation with Enterasys WLAN controller	No	No	No
• forced roaming with IWLAN	Yes	Yes	Yes
• WDS	Yes	Yes	Yes
Protocol is supported			
• Address Resolution Protocol (ARP)	Yes	Yes	Yes
• ICMP	Yes	Yes	Yes
• Telnet	Yes	Yes	Yes
• HTTP	Yes	Yes	Yes
• HTTPS	Yes	Yes	Yes
• TFTP	Yes	Yes	Yes
• SNMP v1	Yes	Yes	Yes
• SNMP v2	Yes	Yes	Yes
• SNMP v3	Yes	Yes	Yes
• DCP	Yes	Yes	Yes
• LLDP	Yes	Yes	Yes
Identification & maintenance function			
• I&M0 - device-specific information	Yes	Yes	Yes
• I&M1 – higher level designation/ location designation	Yes	Yes	Yes
<b>Product functions Diagnosis</b>			
Product function			
• PROFINET IO diagnosis	in preparation	in preparation	in preparation
• localization via Aeroscout	in preparation	in preparation	in preparation
• SysLog	Yes	Yes	Yes
<b>Product functions VLAN</b>			
Product function function VLAN with IWLAN	Yes	Yes	Yes
<b>Product functions DHCP</b>			
Product function			
• DHCP client	Yes	Yes	Yes
• in Client Mode DHCP server via LAN	No	No	No

<sup>1)</sup> Wireless approval in the USA

## Industrial Wireless Communication

### IWLAN – Access Points IEEE 802.11n

#### SCALANCE W786 RJ45 for outdoor use

#### Technical specifications (continued)

Article No.	6GK5786-1FC00-0AA0 6GK5786-1FC00-0AB0 <sup>1)</sup>	6GK5786-2HC00-0AA0 6GK5786-2HC00-0AB0 <sup>1)</sup>	6GK5786-2FC00-0AA0 6GK5786-2FC00-0AB0 <sup>1)</sup>
Product-type designation	SCALANCE W786-1 RJ45	SCALANCE W786-2IA RJ45	SCALANCE W786-2 RJ45
<b>Product functions Redundancy</b>			
Protocol is supported STP/RSTP	Yes	Yes	Yes
<b>Product functions Security</b>			
Product function			
• ACL - MAC-based	-	-	-
• Management security, ACL-IP based	-	Yes	Yes
• IEEE 802.1x (radius)	Yes	Yes	Yes
• NAT/NAPT	No	No	No
• access protection according to IEEE802.11i	Yes	Yes	Yes
• WPA/WPA2	Yes	Yes	Yes
• TKIP/AES	Yes	Yes	Yes
Protocol is supported SSH	Yes	Yes	Yes
<b>Product functions Time</b>			
Protocol is supported			
• SNTP	Yes	Yes	Yes
• SIMATIC Time	Yes	Yes	Yes
<b>Standards, specifications, approvals</b>			
Standard			
• for EMC from FM	-	-	-
• for hazardous zone	EN 60079-15:2005, EN 60079-0:2006, II 3 G Ex nA II T4 KEMA 07 ATEX 0145X	EN 60079-15:2005, EN 60079-0:2006, II 3 G Ex nA II T4 KEMA 07 ATEX 0145X	EN 60079-15:2005, EN 60079-0:2006, II 3 G Ex nA II T4 KEMA 07 ATEX 0145X
• for safety of CSA and UL	UL 60950-1 CSA C22.2 No. 60950-1	UL 60950-1 CSA C22.2 No. 60950-1	UL 60950-1 CSA C22.2 No. 60950-1
• for hazardous area of CSA and UL	-	-	-
Verification of suitability			
• CE mark	Yes	Yes	Yes
• EC declaration of conformity	Yes	Yes	Yes
• C-Tick	Yes	Yes	Yes
• CCC	No	No	No
• Railway application in accordance with EN 50155	No	No	No
• e1 approval	No	No	No
• E1 approval	No	No	No
• NEMA4X	Yes	Yes	Yes
• Power-over-Ethernet according IEEE802.3at for type 1 and IEEE802.3af	Yes	Yes	Yes
• Power-over-Ethernet according to IEEE802.3at for type 2	Yes	Yes	Yes
Standard for wireless communication			
• IEEE 802.11a	Yes	Yes	Yes
• IEEE 802.11b	Yes	Yes	Yes
• IEEE 802.11e	Yes	Yes	Yes
• IEEE 802.11g	Yes	Yes	Yes
• IEEE 802.11h	Yes	Yes	Yes
• IEEE 802.11i	Yes	Yes	Yes
• IEEE 802.11n	Yes	Yes	Yes
Wireless approval	You will find the current list of countries at: <a href="http://www.siemens.com/wireless-approvals">www.siemens.com/wireless-approvals</a>	You will find the current list of countries at: <a href="http://www.siemens.com/wireless-approvals">www.siemens.com/wireless-approvals</a>	You will find the current list of countries at: <a href="http://www.siemens.com/wireless-approvals">www.siemens.com/wireless-approvals</a>
<b>Accessories</b>			
Accessories	24 V DC screw terminal included in scope of delivery	24 V DC screw terminal included in scope of delivery	24 V DC screw terminal included in scope of delivery

<sup>1)</sup> Wireless approval in the USA

Ordering data	Article No.	Article No.
<b>SCALANCE W786 access points</b>		<b>Accessories</b>
IWLAN access points with built-in wireless interfaces; wireless networks IEEE 802.11a/b/g/h/n at 2.4/5 GHz up to 450 Mbps; WPA2/AES; Power over Ethernet (PoE), IP65 degree of protection (-40 °C to +60 °C); scope of delivery: Mounting hardware, 2-pin screw terminal for 24 V DC; manual on CD-ROM; German/English		<b>KEY-PLUG W780 iFeatures</b> 6GK5907-8PA00 Swap medium for enabling additional iFeatures, for simple device replacement if a fault occurs and for storage of configuration data; Can be used in SCALANCE W access points with PLUG compartment
<b>SCALANCE W786-1 RJ45</b> IWLAN access points with <u>one</u> integrated wireless interface and RJ45 connector • Connections for three external antennas - National approvals for operation outside the USA - National approvals for operation within the USA <sup>1)</sup>	6GK5786-1FC00-0AA0 6GK5786-1FC00-0AB0	<b>C-PLUG</b> 6GK1900-0AB00 Swap medium for simple replacement of devices in the event of a fault; for storing configuration data; can be used in SIMATIC NET products with PLUG compartment
<b>SCALANCE W786-2 RJ45</b> IWLAN access points with <u>two</u> integrated wireless interfaces and RJ45 connection • Six connections for external antennas - National approvals for operation outside the USA - National approvals for operation within the USA <sup>1)</sup>	6GK5786-2FC00-0AA0 6GK5786-2FC00-0AB0	<b>Power supply PS791-2DC</b> 6GK5791-2DC00-0AA0 24 V DC power supply for installation in SCALANCE W786 products; operating instructions in German/English
<b>SCALANCE W786-2IA RJ45</b> IWLAN access points with <u>two</u> integrated wireless interfaces and RJ45 connection • Six internal antennas - National approvals for operation outside the USA - National approvals for operation within the USA <sup>1)</sup>	6GK5786-2HC00-0AA0 6GK5786-2HC00-0AB0	<b>Power supply PS791-2AC</b> 6GK5791-2AC00-0AA0 110 V AC to 230 V AC power supply for installation in the SCALANCE W786 products; operating instructions in German/English
		<b>MS1 mounting set</b> 6GK5798-8MG00-0AA0 Mounting set for fixing SCALANCE W786 products to an S7-300 mounting rail or a 35 mm standard DIN rail
		<b>IE FC RJ45 Plug 4 x 2</b> RJ45 plug connector for Industrial Ethernet (10/100/1 000 Mbit/s) with a sturdy metal enclosure and integrated insulation displacement contacts for connecting Industrial Ethernet FC installation cables; 180° cable outlet; for network components and CPs/CPU's with Industrial Ethernet interface • 1 pack = 1 unit • 1 pack = 10 units • 1 pack = 50 units 6GK1901-1BB11-2AA0 6GK1901-1BB11-2AB0 6GK1901-1BB11-2AE0
		<b>IE FC Standard Cable GP 4 x 2</b> 6XV1878-2A 8-core, shielded TP installation cable for connection to IE FC RJ45 Plug 4 x 2 and IE M12 Plug PRO 4 x 2; PROFINET-compatible; with UL approval; sold by the meter; max. length 1 000 m, minimum order quantity 20 m
		<b>IE FC Stripping Tool</b> 6GK1901-1GA00 Preadjusted stripping tool for fast stripping of the Industrial Ethernet FC cables
		<b>Antennas and miscellaneous IWLAN accessories</b> See Industrial Wireless LAN/ accessories

<sup>1)</sup> Please note national approvals under <http://www.siemens.com/wireless-approvals>

### More information

#### Selection tools:

To assist in selecting Industrial Ethernet components, the TIA Selection Tool is available at:  
<http://www.siemens.com/tia-selection-tool>

#### Wireless approvals:

Current approvals can be found on the Internet at:  
<http://www.siemens.com/wireless-approvals>

## Industrial Wireless Communication

### IWLAN – Access Points IEEE 802.11n

#### SCALANCE W786 SFP for outdoor use

##### Overview



- Particularly well-suited to applications with high climatic requirements when installed outdoors and in areas accessible to the public

##### Design

- Rugged, impact-resistant plastic enclosure, shock and vibration-proof for demanding mechanical requirements
- Two slots for SFP plug-in transceivers (optical 2-port switch)
- High IP65 degree of protection against dust and water jets
- For use at ambient temperatures from -40 °C to +60 °C (depending on the SFP plug-in transceiver used)
- Resistant to condensation
- Resistant to UV radiation and saltwater spray
- Design for use outdoors
- 6 x R-SMA sockets for the connection of remote antennas
- 1 x 24 V DC connector, optional operation with 12 to 24 V DC or 100 to 240 V AC with power supply that can be integrated in the device
- 1 x PLUG compartment (KEY-PLUG/C-PLUG)
- Function LEDs for optical signaling of faults/errors and operating statuses
- Mounting: Wall or, with optional mounting set, on S7 mounting rail, 35 mm standard mounting rail, or on a pole

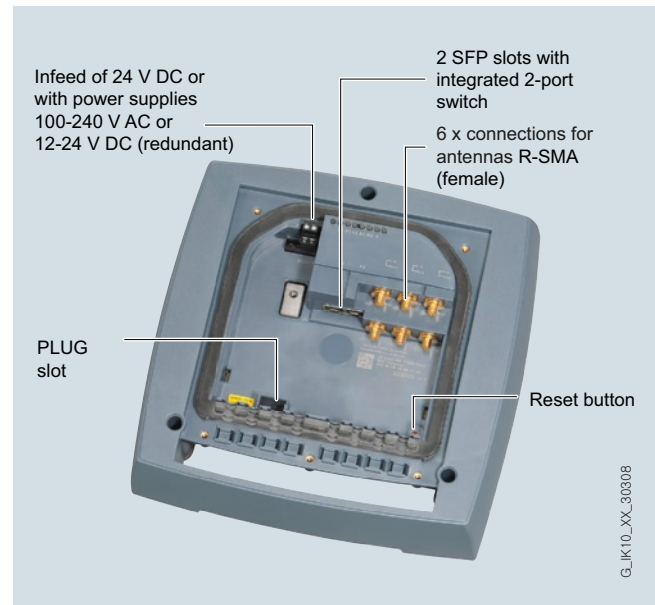

Design and interfaces of the SCALANCE W786-2 SFP access points

##### Product versions

###### SCALANCE W786-2 SFP

- Two wireless cards permanently installed in the device; can be expanded to establish wireless connections with KEY-PLUG W780 iFeatures

#### Function

In the case of access points with two wireless modules, one module implements communication of the access points with each other. The radio link for the stations, e.g. a mobile crane system, is established by the second wireless module. Wireless coverage of larger areas can therefore be provided with the same device.

If the minimum length of standard Ethernet cables is insufficient due to the large distance of the access points from the wired

network, SCALANCE W786-2 SFP with SFP plug-in transceivers can be used. Depending on the optical plug-in transceivers used, ranges of up to 70 km can then be achieved.

In the case of SCALANCE W786, this only concerns access points which can, however, be configured as client modules through Web-based management. Then, depending on the selected variant, a maximum of one radio module will be available as a client.

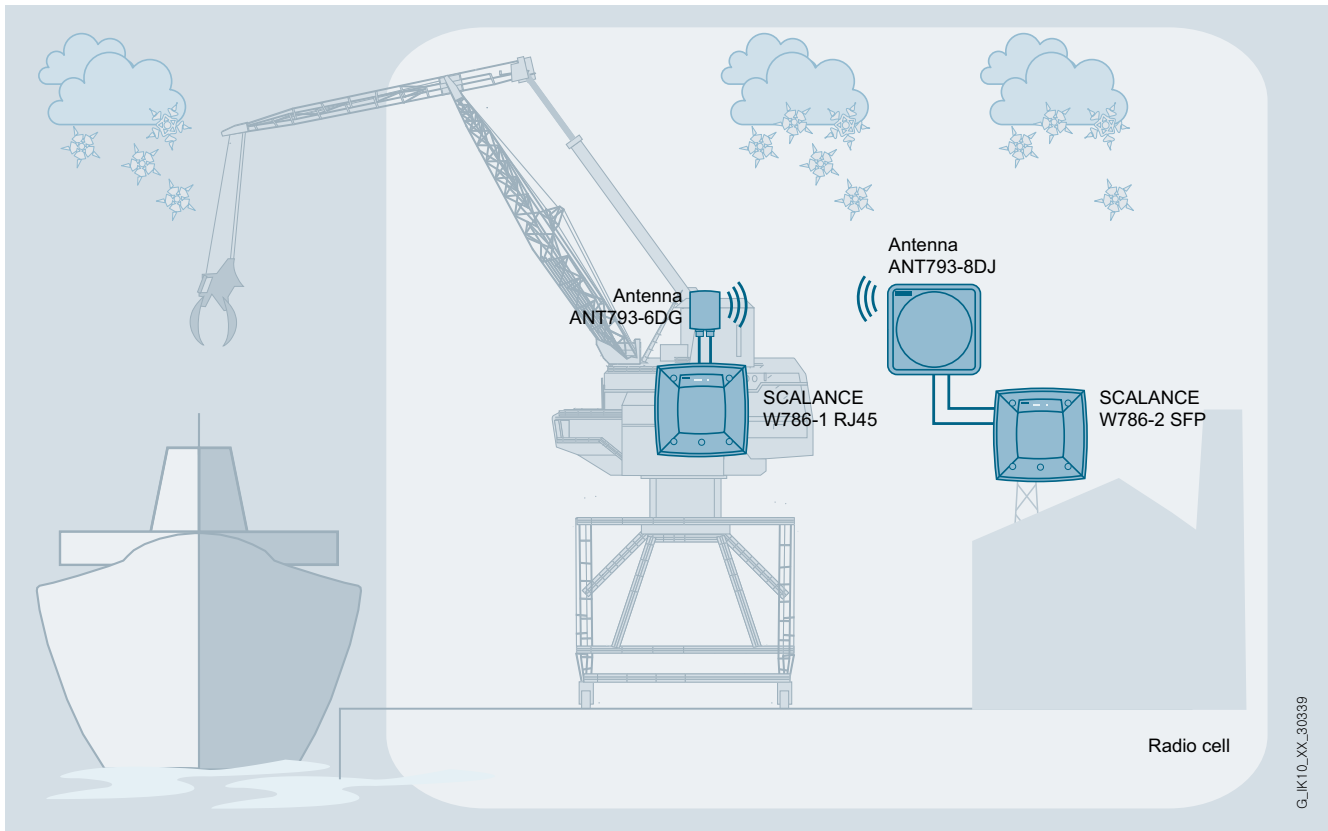

Use of the SCALANCE W786-2 SFP product line in areas subject to demanding climatic requirements

# Industrial Wireless Communication

## IWLAN – Access Points IEEE 802.11n

### SCALANCE W786 SFP for outdoor use

#### Technical specifications

Article No.	6GK5786-2FE00-0AA0	Article No.	6GK5786-2FE00-0AA0
Product-type designation	SCALANCE W786-2 SFP	Product-type designation	SCALANCE W786-2 SFP
<b>Transmission rate</b>		<b>Current consumed</b>	
Transfer rate		• at 24 V with DC typical	-
• with W-LAN maximum	450 Mbit/s	• at 230 V with AC typical	-
• with Industrial Ethernet	1 000 Mbit/s	• with Power-over-Ethernet according to IEEE802.3at for type 1 and IEEE802.3af typical	-
• note	-	• with Power-over-Ethernet according to IEEE802.3at for type 2 typical	-
<b>Interfaces</b>		<b>Effective power loss</b>	
Number of electrical connections		• at 24V for DC typical	-
• for network components and terminal equipment	-	• at 230 V with AC typical	-
• for power supply	1	• with Power-over-Ethernet according to IEEE802.3at for type 1 and IEEE802.3af typical	-
• for redundant power supply	0	• with Power-over-Ethernet according to IEEE802.3at for type 2 typical	-
Design of the electrical connection		<b>Permitted ambient conditions</b>	
• for network components and terminal equipment	-	Ambient temperature	
• for power supply	2-pole connector (24 V DC) or optionally available power supply adapter (4-pole 24 V DC or 3-pole 110 to 230 V AC)	• during operating	-40 ... +60 °C
Number of optical interfaces for optical waveguide at 100 Mbit/s	2	• during storage	-40 ... +85 °C
Design of optical interface for optical waveguide at 100 Mbit/s	SFP slot	• during transport	-40 ... +85 °C
Number of optical interfaces for optical waveguide at 1 000 Mbit/s	2	Relative humidity at 25 °C without condensation during operating maximum	100 %
Design of optical interface for optical waveguide at 1 000 Mbit/s	SFP slot	Protection class IP	IP65
design of the removable storage C-PLUG	Yes	Ambient condition for (standard) operation mode	When using the power supply 100 to 240 V AC, an operating temperature of -40 °C to +60 °C is permissible
<b>Interfaces wireless</b>		<b>Design, dimensions and weight</b>	
Number of radio cards permanently installed	2	Width of enclosure without antenna	251 mm
Number of internal antennas	-	Height of enclosure without antenna	251 mm
Number of electrical connections for external antenna(s)	6	Depth of enclosure without antenna	72 mm
Design of the electrical connection for external antenna(s)	R-SMA (socket)	Net weight	2.24 kg
Product property external antenna can be mounted directly on device	No	Mounting type wall mounting	Yes
<b>Supply voltage, current consumption, power loss</b>		Mounting type	For mast mounting, 35 mm DIN rail mounting and S7-300 rail mounting, an additional support plate is required
Type of supply voltage	DC	<b>Wireless frequencies</b>	
Supply voltage		Radio frequency	
• 1 from terminal block	19.2 V	• for WLAN in 2.4 GHz frequency band	2.41 ... 2.48 GHz
• 2 from terminal block	28.8 V	• for WLAN in 5 GHz frequency band	4.9 ... 5.8 GHz
• from Power-over-Ethernet according IEEE802.3at for type 1 and IEEE802.3af	-	<b>Product properties, functions, components general</b>	
• from Power-over-Ethernet according IEEE802.3at for type 2	-	Product function	
• from optional integratable power supply		• Access Point Mode	Yes
- with AC	100 ... 240 V	• Client Mode	Yes
- with DC	12 ... 24 V	Number of SSIDs	16
		Product function	
		• iPCF Access Point	Yes
		• iPCF client	Yes
		• iPCF-MC Access Point	in preparation
		• iPCF-MC client	in preparation
		Number of iPCF-capable radio modules	2



### Technical specifications (continued)

Article No.	6GK5786-2FE00-0AA0	Article No.	6GK5786-2FE00-0AA0
<b>Product-type designation</b>	<b>SCALANCE W786-2 SFP</b>	<b>Product-type designation</b>	<b>SCALANCE W786-2 SFP</b>
<b>Product functions management, configuration</b>		<b>Product functions Time</b>	
Number of manageable IP addresses in client	8	Protocol is supported	
Product function		• SNTP	Yes
• CLI	Yes	• SIMATIC Time	Yes
• web-based management	Yes	<b>Standards, specifications, approvals</b>	
• MIB support	Yes	Standard	
• TRAPs via email	Yes	• for hazardous zone	EN 60079-15:2005, EN 60079-0:2006, II 3 G Ex nA II T4 KEMA 07 ATEX 0145X
• Configuration with STEP 7	in preparation	• for safety of CSA and UL	UL 60950-1 CSA C22.2 No. 60950-1
• configuration with STEP 7 in the TIA Portal	in preparation	Verification of suitability	
• operation with IWLAN controller	No	• CE mark	Yes
• operation with Enterasys WLAN controller	No	• EC declaration of conformity	Yes
• forced roaming with IWLAN	Yes	• C-Tick	Yes
• WDS	Yes	• CCC	-
Protocol is supported		• Railway application in accordance with EN 50155	No
• Address Resolution Protocol (ARP)	Yes	• e1 approval	No
• ICMP	Yes	• E1 approval	Yes
• Telnet	Yes	• NEMA4X	Yes
• HTTP	Yes	• Power-over-Ethernet according to IEEE802.3at for type 1 and IEEE802.3af	No
• HTTPS	Yes	• Power-over-Ethernet according to IEEE802.3at for type 2	No
• TFTP	Yes	Standard for wireless communication	
• SNMP v1	Yes	• IEEE 802.11a	Yes
• SNMP v2	Yes	• IEEE 802.11b	Yes
• SNMP v3	Yes	• IEEE 802.11e	Yes
• DCP	Yes	• IEEE 802.11g	Yes
• LLDP	Yes	• IEEE 802.11h	Yes
Identification & maintenance function		• IEEE 802.11i	Yes
• I&M0 - device-specific information	Yes	• IEEE 802.11n	Yes
• I&M1 – higher level designation/location designation	Yes	Wireless approval	You will find the current list of countries at: <a href="http://www.siemens.com/wireless-approvals">www.siemens.com/wireless-approvals</a>
<b>Product functions Diagnosis</b>		<b>Accessories</b>	
Product function		Accessories	24 V DC screw terminal included in scope of delivery
• PROFINET IO diagnosis	in preparation		
• localization via Aeroscout	in preparation		
• SysLog	Yes		
<b>Product functions VLAN</b>			
Product function function VLAN with IWLAN	Yes		
<b>Product functions DHCP</b>			
Product function			
• DHCP client	Yes		
• in Client Mode DHCP server via LAN	No		
<b>Product functions Redundancy</b>			
Protocol is supported STP/RSTP	Yes		
<b>Product functions Security</b>			
Product function			
• ACL - MAC-based	-		
• Management security, ACL-IP based	Yes		
• IEEE 802.1x (radius)	Yes		
• NAT/NAPT	No		
• access protection according to IEEE802.11i	Yes		
• WPA/WPA2	Yes		
• TKIP/AES	Yes		
Protocol is supported SSH	Yes		

## Industrial Wireless Communication

### IWLAN – Access Points IEEE 802.11n

#### SCALANCE W786 SFP for outdoor use

Ordering data	Article No.
<b>SCALANCE W786 access points</b>	
IWLAN access points with built-in wireless interfaces; wireless networks IEEE 802.11a/b/g/h/n at 2.4/5 GHz up to 450 Mbit/s; WPA2/AES; Power over Ethernet (PoE), IP65 degree of protection (-40 °C to +60 °C); scope of delivery: Mounting hardware, 2-pin screw terminal for 24 V DC; manual on CD-ROM; German/English	
<b>SCALANCE W786-2 SFP</b>	
IWLAN access points with <u>two</u> integrated wireless interfaces and RJ45 connection	
<ul style="list-style-type: none"> <li>• Six external antennas</li> <li>- National approvals for operation outside the USA</li> <li>- National approvals for operation within the USA <sup>1)</sup></li> </ul>	<p><b>6GK5786-2FE00-0AA0</b></p> <p><b>6GK5786-2FE00-0AB0</b></p>
<b>Accessories</b>	
<b>KEY-PLUG W780 iFeatures</b>	<b>6GK5907-8PA00</b>
Swap medium for enabling additional iFeatures, for simple device replacement if a fault occurs and for storage of configuration data; Can be used in SCALANCE W access points with PLUG compartment	
<b>C-PLUG</b>	<b>6GK1900-0AB00</b>
Swap medium for simple replacement of devices in the event of a fault; for storing configuration data; can be used in SIMATIC NET products with PLUG compartment	
<b>Power supply PS791-2DC</b>	<b>6GK5791-2DC00-0AA0</b>
24 V DC power supply for installation in SCALANCE W786 products; operating instructions in German/English	
<b>Power supply PS791-2AC</b>	<b>6GK5791-2AC00-0AA0</b>
110 V AC to 230 V AC power supply for installation in the SCALANCE W786 products; operating instructions in German/English	
<b>MS1 mounting set</b>	<b>6GK5798-8MG00-0AA0</b>
Mounting set for fixing SCALANCE W786 products onto an S7-300 mounting rail or a 35 mm standard DIN rail	
<b>Antennas and miscellaneous IWLAN accessories</b>	See Industrial Wireless LAN/ accessories
<b>SFP plug-in transceiver</b>	
<b>SFP992-1</b> Gigabit, multimode, 750 m	<b>6GK5992-1AL00-8AA0</b>
<b>SFP992-1LD</b> Gigabit, singlemode, 10 km	<b>6GK5992-1AM00-8AA0</b>
<b>SFP992-1LH</b> Gigabit, singlemode, 40 km	<b>6GK5992-1AN00-8AA0</b>
<b>SFP992-1LH+</b> Gigabit, singlemode, 70 km	<b>6GK5992-1AP00-8AA0</b>
<b>Fiber-optic cables</b>	see Glass fiber-optic cables

<sup>1)</sup> Please note national approvals under <http://www.siemens.com/wireless-approvals>

#### More information

##### Selection tools:

To assist in selecting Industrial Ethernet components, the TIA Selection Tool is available at:

<http://www.siemens.com/tia-selection-tool>

##### Wireless approvals:

Current approvals can be found on the Internet at:

<http://www.siemens.com/wireless-approvals>

#### Overview

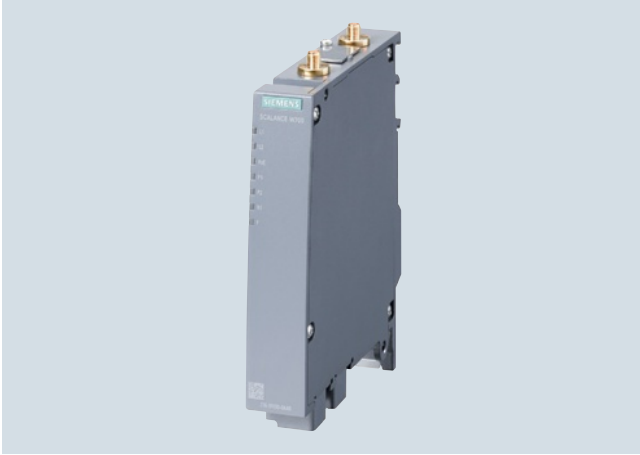

- Access points in SIMATIC design suitable for applications where the device is to be mounted in the control cabinet

#### Design

- Low-profile, compact aluminum enclosure, shock and vibration-proof for high mechanical requirements
- Implementation of simple and cost-effective wireless machine networking
- Support of the 2.4 and 5 GHz frequency band
- IP30 protection
- For use at ambient temperatures from -20 °C to +60 °C
- 2 x R-SMA sockets for the connection of direct mountable and remote antennas
- Antenna placement optimized for the 2x2 MIMO technology; the antennas do not interfere with each other when they are mounted directly on the device
- 2 x RJ45 connector for 10/100 Mbit/s, of which one connector has Power-over-Ethernet compliant with IEEE 802.3at
- 2 x 24 V DC connection for redundant energy supply
- 1 x PLUG compartment for KEY-PLUG/C-PLUG
- Function LEDs for optical signaling of faults/errors and operating statuses
- Mounting: Wall, S7-1500 mounting rail, S7-300 mounting rail, or on 35 mm standard mounting rail
- SIMATIC design matches existing components in the control cabinet (e.g. S7-1500, ...)

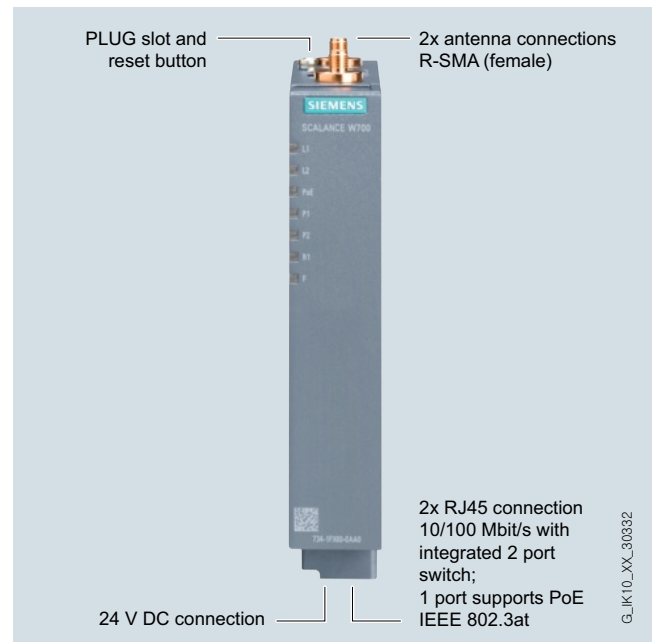

Design and interfaces of the SCALANCE W774 RJ45 access points

#### Product versions

##### SCALANCE W774-1 RJ45

- A radio card is permanently installed; functional scope can be expanded by using a KEY-PLUG W780 iFeatures

# Industrial Wireless Communication IWLAN – Access Points IEEE 802.11n

## SCALANCE W774 RJ45 for use in control cabinet

### Function

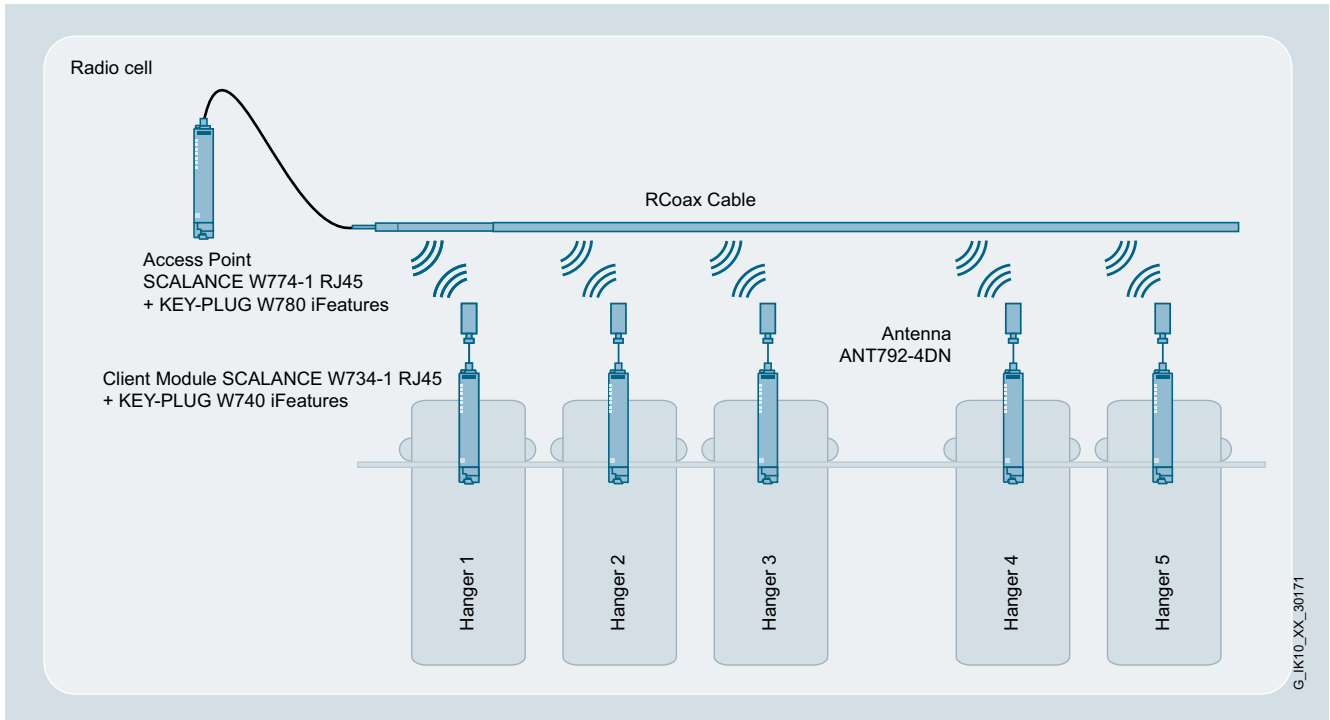

Integration of an automated guided vehicle system using iPCF with SCALANCE W774-1 RJ45 and KEY-PLUG W780 iFeatures

### Technical specifications

Article No.	6GK5774-1FX00-0AA0 6GK5774-1FX00-0AB0 <sup>1)</sup>	Article No.	6GK5774-1FX00-0AA0 6GK5774-1FX00-0AB0 <sup>1)</sup>
Product-type designation	SCALANCE W774-1 RJ45	Product-type designation	SCALANCE W774-1 RJ45
<b>Transmission rate</b>		<b>Supply voltage, current consumption, power loss</b>	
Transmission rate		Type of supply voltage	DC
• with W-LAN maximum	300 Mbit/s	Supply voltage	
• with Industrial Ethernet	10 ... 100 Mbit/s	• 1 from terminal block	19.2 V
• note	-	• 2 from terminal block	28.8 V
<b>Interfaces</b>		• from Power-over-Ethernet according IEEE802.3at for type 1 and IEEE802.3af	48 V
Number of electrical connections	2	• from Power-over-Ethernet according IEEE802.3at for type 2	-
• for network components and terminal equipment	1	Current consumed	
• for power supply	1	• at 24 V with DC typical	0.25 A
• for redundant power supply	1	• with Power-over-Ethernet according to IEEE802.3at for type 1 and IEEE802.3af typical	0.125 A
Design of the electrical connection		• with Power-over-Ethernet according to IEEE802.3at for type 2 typical	-
• for network components and terminal equipment	RJ45 socket	Effective power loss	
• for power supply	4-pole screw terminal, PoE	• at 24V for DC typical	6 W
Number of optical interfaces for optical waveguide at 100 Mbit/s	-	• with Power-over-Ethernet according to IEEE802.3at for type 1 and IEEE802.3af typical	6 W
Design of optical interface for optical waveguide at 100 Mbit/s	-	• with Power-over-Ethernet according to IEEE802.3at for type 2 typical	-
design of the removable storage C-PLUG	Yes	<b>Permitted ambient conditions</b>	
<b>Interfaces wireless</b>		Ambient temperature	
Number of radio cards permanently installed	1	• during operating	-20 ... +60 °C
Number of internal antennas	-	• during storage	-40 ... +85 °C
Number of electrical connections for external antenna(s)	2	• during transport	-40 ... +85 °C
Design of the electrical connection for external antenna(s)	R-SMA (socket)	Relative humidity at 25 °C without condensation during operating maximum	97 %
Product property external antenna can be mounted directly on device	Yes	Protection class IP	IP30
<b>Signal-Inputs/outputs</b>		Ambient condition for (standard) operation mode	When used under hazardous conditions (Zone 2), the SCALANCE W774-1 RJ45 or W734-1 RJ45 product must be installed in an enclosure. To comply with EN 50021, this enclosure must meet the requirements of at least IP54 in compliance with EN 60529.
Number of digital inputs	-	<b>Design, dimensions and weight</b>	
Number of digital outputs	-	Width of enclosure without antenna	26 mm
Design of electrical connection at the digital inputs/outputs	-	Height of enclosure without antenna	147 mm
Signal range		Depth of enclosure without antenna	127 mm
• at digital input	-	Net weight	0.52 kg
• at the digital output	-	Mounting type wall mounting	Yes
		Mounting type	Wall mounting only if flat mounted
		<b>Wireless frequencies</b>	
		Radio frequency	
		• for WLAN in 2.4 GHz frequency band	2.41 ... 2.48 GHz
		• for WLAN in 5 GHz frequency band	4.9 ... 5.8 GHz

## Industrial Wireless Communication

### IWLAN – Access Points IEEE 802.11n

#### SCALANCE W774 RJ45 for use in control cabinet

##### Technical specifications (continued)

Article No.	6GK5774-1FX00-0AA0 6GK5774-1FX00-0AB0 <sup>1)</sup>	Article No.	6GK5774-1FX00-0AA0 6GK5774-1FX00-0AB0 <sup>1)</sup>
<b>Product-type designation</b>	<b>SCALANCE W774-1 RJ45</b>	<b>Product-type designation</b>	<b>SCALANCE W774-1 RJ45</b>
<b>Product properties, functions, components general</b>		<b>Product functions DHCP</b>	
Product function		Product function	
• Access Point Mode	Yes	• DHCP client	Yes
• Client Mode	Yes	• in Client Mode DHCP server via LAN	No
Number of SSIDs	4	<b>Product functions Redundancy</b>	
Product function		Protocol is supported STP/RSTP	-
• iPCF Access Point	in preparation	<b>Product functions Security</b>	
• iPCF client	in preparation	Product function	
• iPCF-MC Access Point	-	• ACL - MAC-based	No
• iPCF-MC client	in preparation	• Management security, ACL-IP based	Yes
Number of iPCF-capable radio modules	1	• IEEE 802.1x (radius)	Yes
<b>Product functions management, configuration</b>		• NAT/NAPT	No
Number of manageable IP addresses in client	8	• access protection according to IEEE802.11i	Yes
Product function		• WPA/WPA2	Yes
• CLI	Yes	• TKIP/AES	Yes
• web-based management	Yes	Protocol is supported SSH	Yes
• MIB support	Yes	<b>Product functions Time</b>	
• TRAPs via email	Yes	Protocol is supported	
• Configuration with STEP 7	in preparation	• SNMP	Yes
• configuration with STEP 7 in the TIA Portal	in preparation	• SIMATIC Time	Yes
• operation with IWLAN controller	-	<b>Standards, specifications, approvals</b>	
• operation with Enterasys WLAN controller	-	Standard	
• forced roaming with IWLAN	No	• for EMC from FM	-
• WDS	Yes	• for hazardous zone	in preparation
Protocol is supported		• for safety of CSA and UL	-
• Address Resolution Protocol (ARP)	Yes	• for hazardous area of CSA and UL	-
• ICMP	Yes	Verification of suitability	
• Telnet	Yes	• CE mark	Yes
• HTTP	Yes	• EC declaration of conformity	Yes
• HTTPS	Yes	• C-Tick	Yes
• TFTP	Yes	• CCC	-
• SNMP v1	Yes	• Railway application in accordance with EN 50155	-
• SNMP v2	Yes	• e1 approval	-
• SNMP v3	Yes	• E1 approval	-
• DCP	Yes	• NEMA4X	-
• LLDP	Yes	• Power-over-Ethernet according IEEE802.3at for type 1 and IEEE802.3af	Yes
Identification & maintenance function		• Power-over-Ethernet according to IEEE802.3at for type 2	Yes
• I&M0 - device-specific information	Yes	Standard for wireless communication	
• I&M1 – higher level designation/ location designation	Yes	• IEEE 802.11a	Yes
<b>Product functions Diagnosis</b>		• IEEE 802.11b	Yes
Product function		• IEEE 802.11e	Yes
• PROFINET IO diagnosis	in preparation	• IEEE 802.11g	Yes
• localization via Aeroscout	in preparation	• IEEE 802.11h	Yes
• SysLog	Yes	• IEEE 802.11i	Yes
<b>Product functions VLAN</b>		• IEEE 802.11n	Yes
Product function function VLAN with IWLAN	Yes	Wireless approval	You will find the current list of countries at: <a href="http://www.siemens.com/wireless-approvals">www.siemens.com/wireless-approvals</a>
		<b>Accessories</b>	
		Accessories	24 V DC screw terminal included in scope of delivery

<sup>1)</sup> Wireless approval in the USA

Ordering data	Article No.	More information
<p><b>SCALANCE W774 access points</b></p> <p>IWLAN access points with built-in wireless interface for establishing wireless connections with iFeatures; wireless networks IEEE 802.11a/b/g/h/n at 2.4/5 GHz up to 300 Mbit/s; WPA2/AES; integrated 2-port switch; Power over Ethernet (PoE), IP30 degree of protection (-20 °C to +60 °C); scope of delivery: Mounting hardware, 4-pin screw terminal for 24V DC; manual on CD-ROM; German/English</p>		<p><b>Selection tools:</b></p> <p>To assist in selecting Industrial Ethernet components, the TIA Selection Tool is available at: <a href="http://www.siemens.com/tia-selection-tool">http://www.siemens.com/tia-selection-tool</a></p>
<p><b>SCALANCE W774-1 RJ45</b></p> <p>IWLAN Access Point with one built-in wireless interface</p> <ul style="list-style-type: none"> <li>National approvals for operation outside the USA</li> <li>National approvals for operation within the USA <sup>1)</sup></li> </ul>	<p><b>6GK5774-1FX00-0AA0</b></p> <p><b>6GK5774-1FX00-0AB0</b></p>	<p><b>Wireless approvals:</b></p> <p>Current approvals can be found on the Internet at: <a href="http://www.siemens.com/wireless-approvals">http://www.siemens.com/wireless-approvals</a></p>
<p><b>Accessories</b></p> <p><b>KEY-PLUG W780 iFeatures</b></p> <p>Swap medium for enabling additional iFeatures, for simple device replacement if a fault occurs and for storage of configuration data; can be used in SCALANCE W access points with PLUG compartment</p>	<p><b>6GK5907-8PA00</b></p>	
<p><b>C-PLUG</b></p> <p>Swap medium for simple replacement of devices if a fault occurs; for storing configuration data; can be used in SIMATIC NET products with PLUG compartment</p>	<p><b>6GK1900-0AB00</b></p>	
<p><b>IE FC RJ45 Plug 180 2 x 2</b></p> <p>RJ45 plug connector for Industrial Ethernet with a rugged metal enclosure and integrated insulation-displacement contacts for connecting Industrial Ethernet FC installation cables; with a 180° cable outlet; for network components and CPs/CPU's with Industrial Ethernet interface</p> <ul style="list-style-type: none"> <li>1 pack = 1 unit</li> <li>1 pack = 10 units</li> <li>1 pack = 50 units</li> </ul>	<p><b>6GK1901-1BB10-2AA0</b></p> <p><b>6GK1901-1BB10-2AB0</b></p> <p><b>6GK1901-1BB10-2AE0</b></p>	
<p><b>IE FC Standard Cable GP 2 x 2</b></p> <p>4-core, shielded TP installation cable for connection to IE FC outlet RJ45 plug / IE FC RJ45 plug; PROFINET-compliant; with UL approval; sold by the meter; max. quantity 1 000 m, minimum order 20 m</p>	<p><b>6XV1840-2AH10</b></p>	
<p><b>IE FC Stripping Tool</b></p> <p>Preadjusted stripping tool for fast stripping of the Industrial Ethernet FC cables</p>	<p><b>6GK1901-1GA00</b></p>	
<p><b>Antennas and miscellaneous IWLAN accessories</b></p>	<p>See Industrial Wireless LAN/accessories</p>	

<sup>1)</sup> Please note national approvals under <http://www.siemens.com/wireless-approvals>

## Industrial Wireless Communication

### IWLAN – Access Points IEEE 802.11n

#### SCALANCE W774 M12 EEC for enhanced environmental conditions

##### Overview



- Suitable for use in industrial and automation applications in general, but especially in railway applications where the device is to be mounted in the control cabinet

##### Design

- Low-profile, compact aluminum enclosure, shock and vibration-proof for high mechanical requirements
- Special coating of the printed circuit boards (conformal coating)
- Resistant to condensation
- Railroad approval in accordance with EN 50155
- IP30 degree of protection
- For use at ambient temperatures from -20 °C to +60 °C
- Support of the 2.4 and 5 GHz frequency band
- 2 x R-SMA sockets for the connection of direct mountable and remote antennas
- Antenna placement optimized for the 2x2 MIMO technology; the antennas do not interfere with each other when they are mounted directly on the device
- 2 x M12 connection for 10/100 Mbit/s, of which one connection with Power-over-Ethernet according to IEEE 802.3at
- 1 x M12 socket for power supply (24 V DC)
- 1 x PLUG compartment (KEY-PLUG/C-PLUG)
- Function LEDs for optical signaling of faults/errors and operating statuses
- Mounting: Wall, S7-1500 mounting rail, S7-300 mounting rail, or on 35 mm standard mounting rail

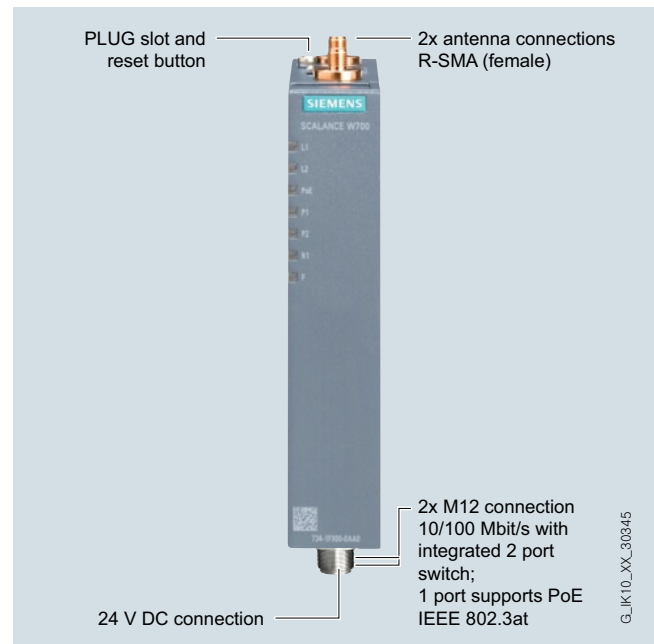

Design and interfaces of the SCALANCE W774 M12 EEC access points

##### Product version

##### SCALANCE W774-1 M12 EEC

- A radio card is permanently installed; functional scope can be expanded by using a KEY-PLUG W780 iFeatures



#### Function

The SCALANCE W774 M12 EEC (Extended Environmental Conditions) are designed for use in railway applications. The devices satisfy EN 50155, the approval for railway applications, and can thus be used for rail traffic. Combined with the antennas approved for railway applications, which are connected via R-SMA antenna connectors (female), these products can set up a reliable IWLAN wireless infrastructure.

The devices can be installed at the location that is most favorable for the wireless link. The enclosure and the connectors are resistant to high levels of shock and vibration because all the connectors are screwed or locked. The SCALANCE W774 M12 EEC is well suited to environments in which a compact design plays a large role. Through its coated printed-circuit

boards (Conformal Coating), the module is resistant to condensation caused by use in environments with large temperature variations.

SCALANCE W774-1 M12 EEC access points can also be operated as client modules.

Provided that a delay (several 100 ms) caused by roaming in accordance with IEEE 802.11 is tolerated by all communication stations when switching the radio cells, the communication continues uninterrupted.

For real-time requirements, the SCALANCE W774-1 M12 EEC can be equipped with KEY-PLUG functionality for activating iFeatures.

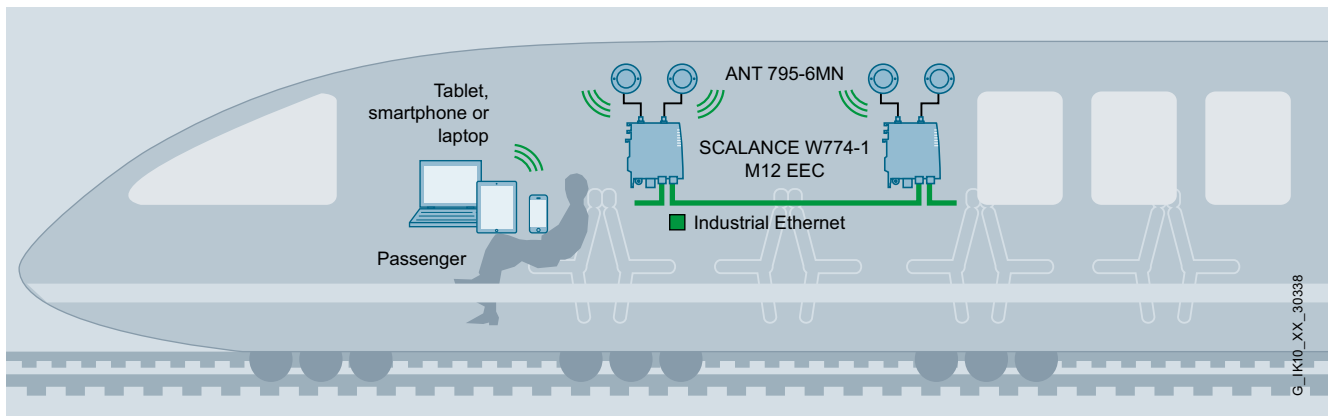

Data transfer in trains with SCALANCE W774-1 M12 EEC

# Industrial Wireless Communication

## IWLAN – Access Points IEEE 802.11n

### SCALANCE W774 M12 EEC for enhanced environmental conditions

#### Technical specifications

Article No.	6GK5774-1FY00-0TA0 6GK5774-1FY00-0TB0 <sup>1)</sup>	Article No.	6GK5774-1FY00-0TA0 6GK5774-1FY00-0TB0 <sup>1)</sup>
Product-type designation	SCALANCE W774-1 M12 EEC	Product-type designation	SCALANCE W774-1 M12 EEC
<b>Transmission rate</b>		<b>Effective power loss</b>	
Transmission rate		• at 24V for DC typical	-
• with W-LAN maximum	300 Mbit/s	• with Power-over-Ethernet according to IEEE802.3at for type 1 and IEEE802.3af typical	-
• with Industrial Ethernet	10 ... 100 Mbit/s	• with Power-over-Ethernet according to IEEE802.3at for type 2 typical	-
• note	-		
<b>Interfaces</b>		<b>Permitted ambient conditions</b>	
Number of electrical connections	2	Ambient temperature	
• for network components and terminal equipment		• during operating	-20 ... +60 °C
• for power supply	1	• during storage	-40 ... +85 °C
• for redundant power supply	1	• during transport	-40 ... +85 °C
Design of electrical connection		Relative humidity at 25 °C without condensation during operating maximum	100 %
• for network components and terminal equipment	M12 interface (4-pole, D-coded), PoE	Protection class IP	
• for power supply	M12 interface (4-pole, A-coded)	Ambient condition for (standard) operation mode	When used under hazardous conditions (Zone 2), the SCALANCE W774-1 M12 EEC product must be installed in an enclosure. To comply with EN 50021, this enclosure must meet the requirements of at least IP54 in compliance with EN 60529.
Number of optical interfaces for optical waveguide at 100 Mbit/s	-		
Design of optical interface for optical waveguide at 100 Mbit/s	-		
design of the removable storage C-PLUG	Yes		
<b>Interfaces wireless</b>		<b>Design, dimensions and weight</b>	
Number of radio cards permanently installed	1	Width of enclosure without antenna	26 mm
Number of internal antennas	-	Height of enclosure without antenna	147 mm
Number of electrical connections for external antenna(s)	2	Depth of enclosure without antenna	127 mm
Design of the electrical connection for external antenna(s)	R-SMA (socket)	Net weight	
Product property external antenna can be mounted directly on device	Yes	Mounting type wall mounting	Yes
		Mounting type	Wall mounting only if flat mounted
<b>Signal-Inputs/outputs</b>		<b>Wireless frequencies</b>	
Number of digital inputs	-	Radio frequency	
Number of digital outputs	-	• for WLAN in 2.4 GHz frequency band	2.41 ... 2.48 GHz
Design of electrical connection at the digital inputs/outputs	-	• for WLAN in 5 GHz frequency band	4.9 ... 5.8 GHz
Signal range			
• at digital input	-		
• at the digital output	-		
<b>Supply voltage, current consumption, power loss</b>		<b>Product properties, functions, components general</b>	
Type of supply voltage	DC	Product function	
Supply voltage		• Access Point Mode	Yes
• 1 from terminal block	19.2 V	• Client Mode	Yes
• 2 from terminal block	28.8 V	Number of SSIDs	4
• from Power-over-Ethernet according IEEE802.3at for type 1 and IEEE802.3af	48 V	Product function	
• from Power-over-Ethernet according IEEE802.3at for type 2	-	• iPCF Access Point	in preparation
Current consumed		• iPCF client	in preparation
• at 24 V with DC typical	-	• iPCF-MC Access Point	-
• with Power-over-Ethernet according to IEEE802.3at for type 1 and IEEE802.3af typical	-	• iPCF-MC client	in preparation
• with Power-over-Ethernet according to IEEE802.3at for type 2 typical	-	Number of iPCF-capable radio modules	1

### Technical specifications (continued)

Article No.	6GK5774-1FY00-0TA0 6GK5774-1FY00-0TB0 <sup>1)</sup>	Article No.	6GK5774-1FY00-0TA0 6GK5774-1FY00-0TB0 <sup>1)</sup>
Product-type designation	SCALANCE W774-1 M12 EEC	Product-type designation	SCALANCE W774-1 M12 EEC
<b>Product functions management, configuration</b>		<b>Product functions Time</b>	
Number of manageable IP addresses in client	8	Protocol is supported	
Product function		• SNMP	Yes
• CLI	Yes	• SIMATIC Time	Yes
• web-based management	Yes	<b>Standards, specifications, approvals</b>	
• MIB support	Yes	Standard	
• TRAPs via email	Yes	• for EMC from FM	in preparation
• Configuration with STEP 7	in preparation	• for hazardous zone	in preparation
• configuration with STEP 7 in the TIA Portal	in preparation	• for safety of CSA and UL	in preparation
• operation with IWLAN controller	-	• for hazardous area of CSA and UL	
• operation with Enterasys WLAN controller	-	Verification of suitability	
• forced roaming with IWLAN	No	• CE mark	Yes
• WDS	Yes	• EC declaration of conformity	Yes
Protocol is supported		• C-Tick	Yes
• Address Resolution Protocol (ARP)	Yes	• CCC	-
• ICMP	Yes	• Railway application in accordance with EN 50155	in preparation
• Telnet	Yes	• e1 approval	
• HTTP	Yes	• E1 approval	-
• HTTPS	Yes	• NEMA4X	-
• TFTP	Yes	• Power-over-Ethernet according to IEEE802.3at for type 1 and IEEE802.3af	Yes
• SNMP v1	Yes	• Power-over-Ethernet according to IEEE802.3at for type 2	Yes
• SNMP v2	Yes	Standard for wireless communication	
• SNMP v3	Yes	• IEEE 802.11a	Yes
• DCP	Yes	• IEEE 802.11b	Yes
• LLDP	Yes	• IEEE 802.11e	Yes
Identification & maintenance function		• IEEE 802.11g	Yes
• I&M0 - device-specific information	Yes	• IEEE 802.11h	Yes
• I&M1 – higher level designation/ location designation	Yes	• IEEE 802.11i	Yes
<b>Product functions Diagnosis</b>		• IEEE 802.11n	Yes
Product function		Wireless approval	You will find the current list of countries at: <a href="http://www.siemens.com/wireless-approvals">www.siemens.com/wireless-approvals</a>
• PROFINET IO diagnosis	in preparation	<b>Accessories</b>	
• localization via Aeroscout	in preparation	Accessories	-
• SysLog	Yes		
<b>Product functions VLAN</b>			
Product function function VLAN with IWLAN	Yes		
<b>Product functions DHCP</b>			
Product function			
• DHCP client	Yes		
• in Client Mode DHCP server via LAN	No		
<b>Product functions Redundancy</b>			
Protocol is supported STP/RSTP	Yes		
<b>Product functions Security</b>			
Product function			
• ACL - MAC-based	No		
• Management security, ACL-IP based	Yes		
• IEEE 802.1x (radius)	Yes		
• NAT/NAPT	No		
• access protection according to IEEE802.11i	Yes		
• WPA/WPA2	Yes		
• TKIP/AES	Yes		
Protocol is supported SSH	Yes		

<sup>1)</sup> Wireless approval in the USA

## Industrial Wireless Communication

### IWLAN – Access Points IEEE 802.11n

#### SCALANCE W774 M12 EEC for enhanced environmental conditions

##### Ordering data

##### Article No.

###### SCALANCE W774 M12 EEC Access Points

IWLAN Access Points with built-in wireless interface; wireless networks IEEE 802.11a/b/g/h/n at 2.4/5 GHz up to 300 Mbit/s; railway approval in accordance with EN 50155; conformal coating; WPA2/AES; Power over Ethernet (PoE), IP20 degree of protection; scope of delivery: Mounting hardware; manual on CD-ROM, German/English

###### SCALANCE W774-1 M12 EEC

IWLAN Access Point with one integrated wireless interface

- National approvals for operation outside the USA
- National approvals for operation within the USA <sup>1)</sup>

**6GK5774-1FY00-0TA0**

**6GK5774-1FY00-0TB0**

###### Accessories

###### KEY-PLUG W780 iFeatures

Swap medium for enabling additional iFeatures, for simple device replacement if a fault occurs and for storage of configuration data; Can be used in SCALANCE W access points with PLUG compartment

**6GK5907-8PA00**

###### C-PLUG

Swap medium for simple replacement of devices in the event of a fault; for storing configuration data; can be used in SIMATIC NET products with PLUG compartment

**6GK1900-0AB00**

###### IE FC M12 Plug PRO 2 x 2

M12 plug-in connector (D-coded, IP65/IP67) that can be assembled in the field, metal enclosure, FastConnect connection method, for SCALANCE W774-1 M12 EEC

- 1 unit
- 8 units

**6GK1901-0DB20-6AA0**  
**6GK1901-0DB30-6AA8**

###### IE FC Standard Cable GP 2 x 2 / Type A

4-core, shielded TP installation cable for connection to IE FC Outlet RJ45/ IE FC RJ45 Plug; PROFINET-compatible; with UL approval; sold by the meter; max. length 1 000 m, minimum order 20 m

**6XV1840-2AH10**

###### IE FC Stripping Tool

Preadjusted stripping tool for fast stripping of the Industrial Ethernet FC cables

**6GK1901-1GA00**

###### Power M12 Cable Connector PRO

Terminal socket for connection of SCALANCE W700 for 24 V DC supply voltage; 4-pole, A-coded, with assembly instructions, 3 units

**6GK1907-0DC10-6AA3**

###### Power Cable 2 x 0.75

Connecting cable for Power M12 Cable Connector PRO, sold by the meter

**6XV1812-8A**

###### Antennas and miscellaneous IWLAN accessories

See Industrial Wireless LAN/ accessories

##### More information

###### Selection tools:

To assist in selecting Industrial Ethernet components, the TIA Selection Tool is available at:  
<http://www.siemens.com/tia-selection-tool>

###### Wireless approvals:

Current approvals can be found on the Internet at:  
<http://www.siemens.com/wireless-approvals>

#### Overview



- Low-cost Access Point, suitable for applications where the device is to be mounted in the control cabinet

#### Design

- Compact design for space-saving installation in control cabinets or boxes on a standard mounting rail
- Implementation of simple and cost-effective wireless machine networking
- Support of the 2.4 and 5 GHz frequency band
- Degree of protection IP20
- For use at ambient temperatures from 0 °C to +55 °C
- 1 x R-SMA socket for the connection of a remote antenna
- 1 x RJ45 port for 10/100 Mbit/s
- 1 x 24 V DC connection
- Function LEDs for optical signaling of faults/errors and operating statuses
- SIMATIC design matches existing components in the control cabinet (e.g. ET 200SP, etc.)

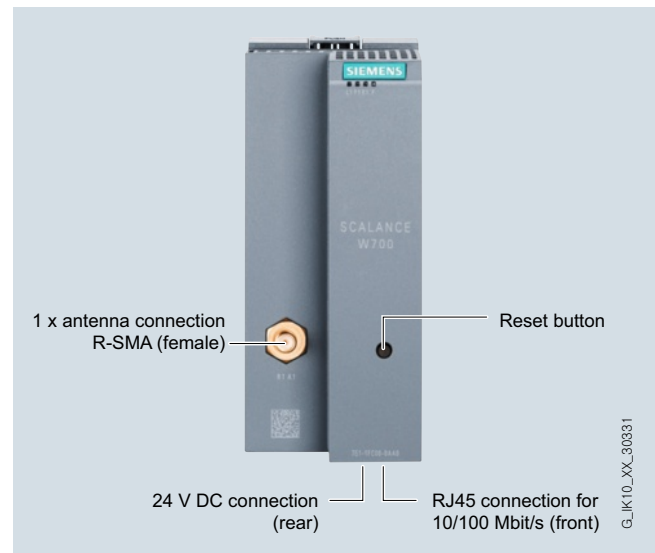

Design and interfaces of the SCALANCE W761 RJ45 access points

#### Product versions

##### SCALANCE W761-1 RJ45

- A wireless card permanently installed in the device

# Industrial Wireless Communication

## IWLAN – Access Points IEEE 802.11n

### SCALANCE W761 RJ45 for the Control Cabinet

#### Integration

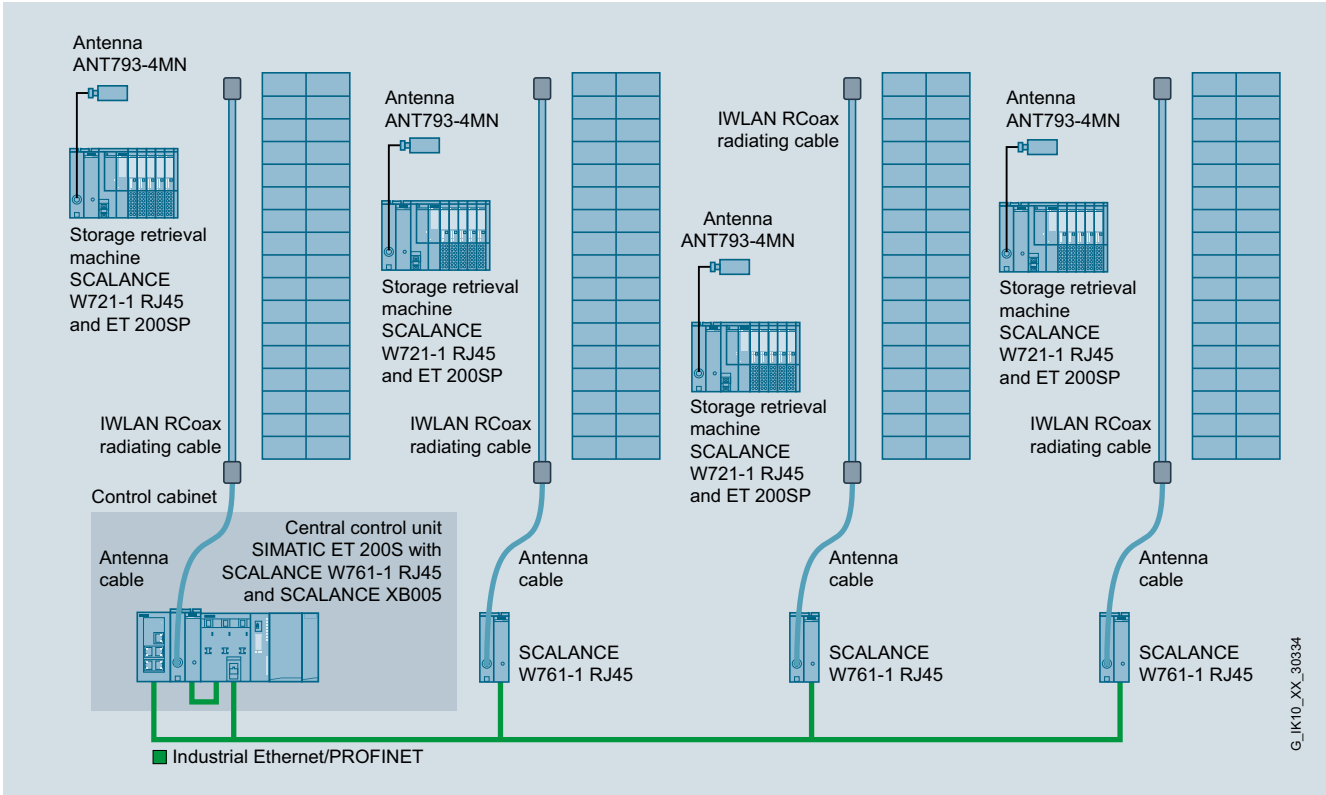

Storage and retrieval machines in high-bay warehouses automated with SCALANCE W721-1 RJ45, W761-1 RJ45 and RCoax

### Technical specifications

Article no.	6GK5761-1FC00-0AA0 6GK5761-1FC00-0AB0 <sup>1)</sup>
Product-type designation	SCALANCE W761-1 RJ45
<b>Transmission rate</b>	
Transmission rate	
• with W-LAN maximum	150 Mbit/s
• for Industrial Ethernet	10 ... 100 Mbit/s
<b>Interfaces</b>	
Number of electrical connections	1
• for network components and terminal equipment	
• for power supply	1
• for redundant power supply	0
Design of electrical connection	
• for network components and terminal equipment	RJ45 socket
• for power supply	3-pole screw terminal
Number of optical interfaces for optical waveguide at 100 Mbit/s	-
Design of optical interface for optical waveguide at 100 Mbit/s	-
design of the removable storage C-PLUG	No
<b>Interfaces wireless</b>	
Number of radio cards permanently installed	1
Number of internal antennas	-
Number of electrical connections for external antenna(s)	1
Design of the electrical connection for external antenna(s)	R-SMA (socket)
Product property external antenna can be mounted directly on device	Yes
<b>Supply voltage, current consumption, power loss</b>	
Type of supply voltage	DC
Supply voltage	
• 1 from terminal block	19.2 V
• 2 from terminal block	28.8 V
• from Power-over-Ethernet according to IEEE802.3at for type 1 and IEEE802.3af	-
• from Power-over-Ethernet according to IEEE802.3at for type 2	-
Current consumed	
• at 24 V with DC typical	0.15 A
• with Power-over-Ethernet according to IEEE802.3at for type 1 and IEEE802.3af typical	-
• with Power-over-Ethernet according to IEEE802.3at for type 2 typical	-
Effective power loss	
• at 24V for DC typical	3.6 W
• with Power-over-Ethernet according to IEEE802.3at for type 1 and IEEE802.3af typical	-
• with Power-over-Ethernet according to IEEE802.3at for type 2 typical	-

Article no.	6GK5761-1FC00-0AA0 6GK5761-1FC00-0AB0 <sup>1)</sup>
Product-type designation	SCALANCE W761-1 RJ45
<b>Permitted ambient conditions</b>	
Ambient temperature	
• during operating	0 ... 55 °C
• during storage	-40 ... +85 °C
• during transport	-40 ... +85 °C
Relative humidity at 25 °C without condensation during operating maximum	95 %
Protection class IP	IP20
Ambient condition for (standard) operation mode	When used under hazardous conditions (Zone 2), the SCALANCE W761-1 RJ45 or W72x-1 RJ45 product must be installed in an enclosure. To comply with EN 50021, this enclosure must meet the requirements of at least IP54 in compliance with EN 60529.
<b>Design, dimensions and weight</b>	
Width of enclosure without antenna	50 mm
Height of enclosure without antenna	114 mm
Depth of enclosure without antenna	74 mm
Net weight	0.13 kg
Mounting type wall mounting	No
<b>Wireless frequencies</b>	
Radio frequency	
• for WLAN in 2.4 GHz frequency band	2.41 ... 2.48 GHz
• for WLAN in 5 GHz frequency band	4.9 ... 5.8 GHz
<b>Product properties, functions, components general</b>	
Product function	
• Access Point Mode	Yes
• Client Mode	Yes
Number of SSIDs	1
Product function	
• iPCF Access Point	No
• iPCF client	No
• iPCF-MC Access Point	No
• iPCF-MC client	No
Number of iPCF-capable radio modules	0

# Industrial Wireless Communication

## IWLAN – Access Points IEEE 802.11n

### SCALANCE W761 RJ45 for the Control Cabinet

#### Technical specifications (continued)

Article no.	6GK5761-1FC00-0AA0 6GK5761-1FC00-0AB0 <sup>1)</sup>	Article no.	6GK5761-1FC00-0AA0 6GK5761-1FC00-0AB0 <sup>1)</sup>
<b>Product-type designation</b>	<b>SCALANCE W761-1 RJ45</b>	<b>Product-type designation</b>	<b>SCALANCE W761-1 RJ45</b>
<b>Product functions management, configuration</b>		<b>Product functions Security</b>	
Number of manageable IP addresses in client	4	Product function	
Product function		• ACL - MAC-based	No
• CLI	Yes	• Management security, ACL-IP based	Yes
• web-based management	Yes	• IEEE 802.1x (radius)	Yes
• MIB support	Yes	• NAT/NAPT	No
• TRAPs via email	Yes	• access protection according to IEEE802.11i	Yes
• Configuration with STEP 7	in preparation	• WPA/WPA2	Yes
• configuration with STEP 7 in the TIA Portal	in preparation	• TKIP/AES	Yes
• operation with IWLAN controller	-	Protocol is supported SSH	Yes
• operation with Enterasys WLAN controller	-	<b>Product functions Time</b>	
• forced roaming with IWLAN	No	Protocol is supported	
• WDS	Yes	• SNMP	Yes
Protocol is supported		• SIMATIC Time	Yes
• Address Resolution Protocol (ARP)	Yes	<b>Standards, specifications, approvals</b>	
• ICMP	Yes	Standard	
• Telnet	Yes	• for EMC from FM	-
• HTTP	Yes	• for hazardous zone	in preparation
• HTTPS	Yes	• for safety of CSA and UL	-
• TFTP	Yes	• for hazardous area of CSA and UL	-
• SNMP v1	Yes	Verification of suitability	
• SNMP v2	Yes	• CE mark	Yes
• SNMP v3	Yes	• EC declaration of conformity	Yes
• DCP	Yes	• C-Tick	Yes
• LLDP	Yes	• CCC	-
Identification & maintenance function		• Railway application in accordance with EN 50155	-
• I&M0 - device-specific information	Yes	• e1 approval	-
• I&M1 – higher level designation/ location designation	Yes	• E1 approval	-
<b>Product functions Diagnosis</b>		• NEMA4X	-
Product function		• Power-over-Ethernet according IEEE802.3at for type 1 and IEEE802.3af	No
• PROFINET IO diagnosis	in preparation	• Power-over-Ethernet according to IEEE802.3at for type 2	No
• localization via Aeroscout	No	Standard for wireless communication	
• SysLog	Yes	• IEEE 802.11a	Yes
<b>Product functions VLAN</b>		• IEEE 802.11b	Yes
Product function function VLAN with IWLAN	Yes	• IEEE 802.11e	Yes
<b>Product functions DHCP</b>		• IEEE 802.11g	Yes
Product function		• IEEE 802.11h	Yes
• DHCP client	Yes	• IEEE 802.11i	Yes
• in Client Mode DHCP server via LAN	No	• IEEE 802.11n	Yes
<b>Product functions Redundancy</b>		Wireless approval	You will find the current list of countries at: <a href="http://www.siemens.com/wireless-approvals">www.siemens.com/wireless-approvals</a>
Protocol is supported STP/RSTP	-	<b>Accessories</b>	
		Accessories	24 V DC screw terminal included in scope of delivery

<sup>1)</sup> Wireless approval in the USA



Ordering data	Article No.	More information
<b>SCALANCE W761 Access Points</b>		
IWLAN Access Point with built-in wireless interface; wireless networks IEEE 802.11a/b/g/h/n at 2.4/5 GHz up to 150 Mbit/s; WPA2/AES; IP20 degree of protection (0 °C to +55 °C); scope of delivery: Mounting hardware, 3-pin screw terminal for 24V DC; manual on CD-ROM; German/English		<b>Selection tools:</b> To assist in selecting Industrial Ethernet components, the TIA Selection Tool is available at: <a href="http://www.siemens.com/tia-selection-tool">http://www.siemens.com/tia-selection-tool</a>  <b>Wireless approvals:</b> Current approvals can be found on the Internet at: <a href="http://www.siemens.com/wireless-approvals">http://www.siemens.com/wireless-approvals</a>
<b>SCALANCE W761-1 RJ45</b>		
IWLAN Access Point with one built-in wireless interface <ul style="list-style-type: none"> <li>National approvals for operation outside the USA</li> <li>National approvals for operation within the USA <sup>1)</sup></li> </ul>	<b>6GK5761-1FC00-0AA0</b>  <b>6GK5761-1FC00-0AB0</b>	
<b>Accessories</b>		
<b>IE FC RJ45 Plug 180 2 x 2</b>		
RJ45 plug connector for Industrial Ethernet with a rugged metal enclosure and integrated insulation-displacement contacts for connecting Industrial Ethernet FC installation cables; with a 180° cable outlet; for network components and CPs/CPU's with Industrial Ethernet interface <ul style="list-style-type: none"> <li>1 pack = 1 unit</li> <li>1 pack = 10 units</li> <li>1 pack = 50 units</li> </ul>	<b>6GK1901-1BB10-2AA0</b> <b>6GK1901-1BB10-2AB0</b> <b>6GK1901-1BB10-2AE0</b>	
<b>IE FC Standard Cable GP 2 x 2</b>		
4-core, shielded TP installation cable for connection to IE FC outlet RJ45 plug / IE FC RJ45 plug; PROFINET-compliant; with UL approval; sold by the meter; max. quantity 1 000 m, minimum order 20 m	<b>6XV1840-2AH10</b>	
<b>IE FC stripping tool</b>		
Preadjusted stripping tool for fast stripping of the Industrial Ethernet FC cables	<b>6GK1901-1GA00</b>	
<b>Antennas and miscellaneous IWLAN accessories</b>	See Industrial Wireless LAN/ accessories	

<sup>1)</sup> Please note national approvals under <http://www.siemens.com/wireless-approvals>

## Industrial Wireless Communication

### IWLAN – Controller and Controller Access Points IEEE 802.11n

#### Overview

#### Overview



The network infrastructures in the industrial and office areas are coming ever-closer together. This applies also in the area of wireless communication, causing a constant increase in the number of access points and WLAN clients to be managed. If such networks are established with a large number of stand-alone access points, with each one having to be configured separately, this results in huge costs for initial configuration and operation.

Central wireless LAN controllers enable low-cost, user-friendly and secure operation of large WLAN infrastructures here. Management of the WLAN clients connected to such WLANs is significantly simplified thanks to their division into user groups with different security policies.

The SCALANCE WLC711 IWLAN Controller is a device for centralized management (configuration, diagnostics, firmware updates, access control, security settings, coordination) of a wireless LAN in the industrial environment.

- Fast establishment of a new WLAN or expansion of an existing WLAN with the help of the SCALANCE W786C and SCALANCE W788C controller-based access points
- Parallel operation of different services (e.g. communication between programmable controllers, Internet access, Voice-over-IP telephony and video transmission) on the same controller-based WLAN infrastructure without requiring additional SSIDs for this purpose.
- Seamless transition between production WLAN and corporate WLAN
- Simplified commissioning as well as increased reliability and security thanks to the central management functions of the IWLAN controller in comparison to a WLAN comprising stand-alone access points that have to be configured individually

#### Benefits



- Reduced commissioning overhead and operation of larger IWLAN installations (up to 48 access points or 96 access points in redundant mode) thanks to configuring from a central location
- Investment protection thanks to seamless integration into existing IWLAN installations or into an existing corporate WLAN
- Saving on redundant infrastructures (e.g. separate network for Internet access and voice transmission) thanks to multiple use of the same infrastructure for different services
- Avoidance of a single point of failure thanks to optional parallel operation of two controllers; the WLAN remains functional even if the controller(s) fail(s)
- Increased reliability when operating the IWLAN through complete, coordinated portfolio of IWLAN Controller SCALANCE WLC711, industrial access points and SCALANCE W client modules, as well as the suitable accessories (antennas, connecting cables, power supplies)
- Flexible configuration of networks thanks to the use of an integrated wireless mesh solution
- Dynamic Radio Management supports the optimal alignment of the entire WLAN network
- In the controller-based WLAN, the bandwidth or the assignment of the access points can be automatically influenced by the IWLAN Controller SCALANCE WLC711 depending on the requirements. This ensures optimal utilization of the WLAN by the IWLAN client modules.

### Application

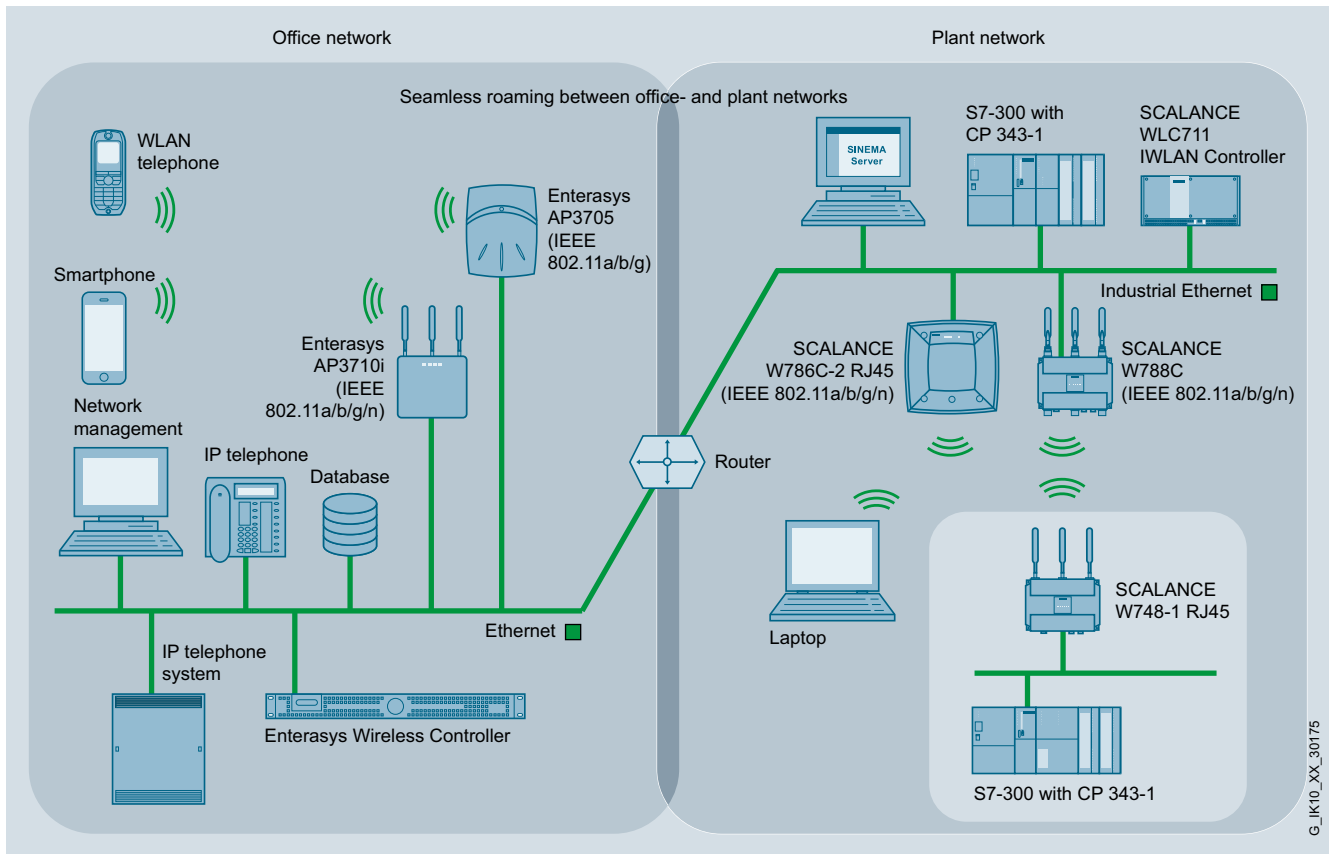

Company-wide WLAN based on Extreme Networks (Enterasys) Wireless Controller and SCALANCE WLC711 IWLAN controller

The SCALANCE WLC711 IWLAN controller is the optimum solution for IWLAN installations with up to 48 access points (in redundant mode even up to 96 access points). By using SCALANCE W access points and client modules, different applications in the industrial environment or a comparable environment can communicate via a centrally managed IWLAN. SCALANCE W access points for controller operation are available for use both outdoors and for cabinet-free use in an industrial environment (e.g. on the shop floor).

The SCALANCE WLC711 IWLAN controller can be integrated in the corporate WLAN and allows the implementation of a WLAN throughout the office, outdoor and industrial areas. This allows use of mobile WLAN phones, laptops, smart phones and tablets in the same wireless network, while complying with security policies for different user groups, and guaranteeing defined quality of service (QoS) for different devices.

## Industrial Wireless Communication

### IWLAN – Controller and Controller Access Points IEEE 802.11n

#### Overview

#### Application (continued)

##### Application examples

With the SCALANCE WLC711 IWLAN controller, the benefits of a controller solution, long-familiar in corporate networks, now also become available for typical industrial and industry-related applications:

- Plant-wide wireless infrastructures in factory automation and process automation, e.g. for mobile operator control or logistics applications
- Industry-related applications, e.g. container terminals, road or underground rail tunnels, where IWLAN is required for transmitting visualization, video, and voice data

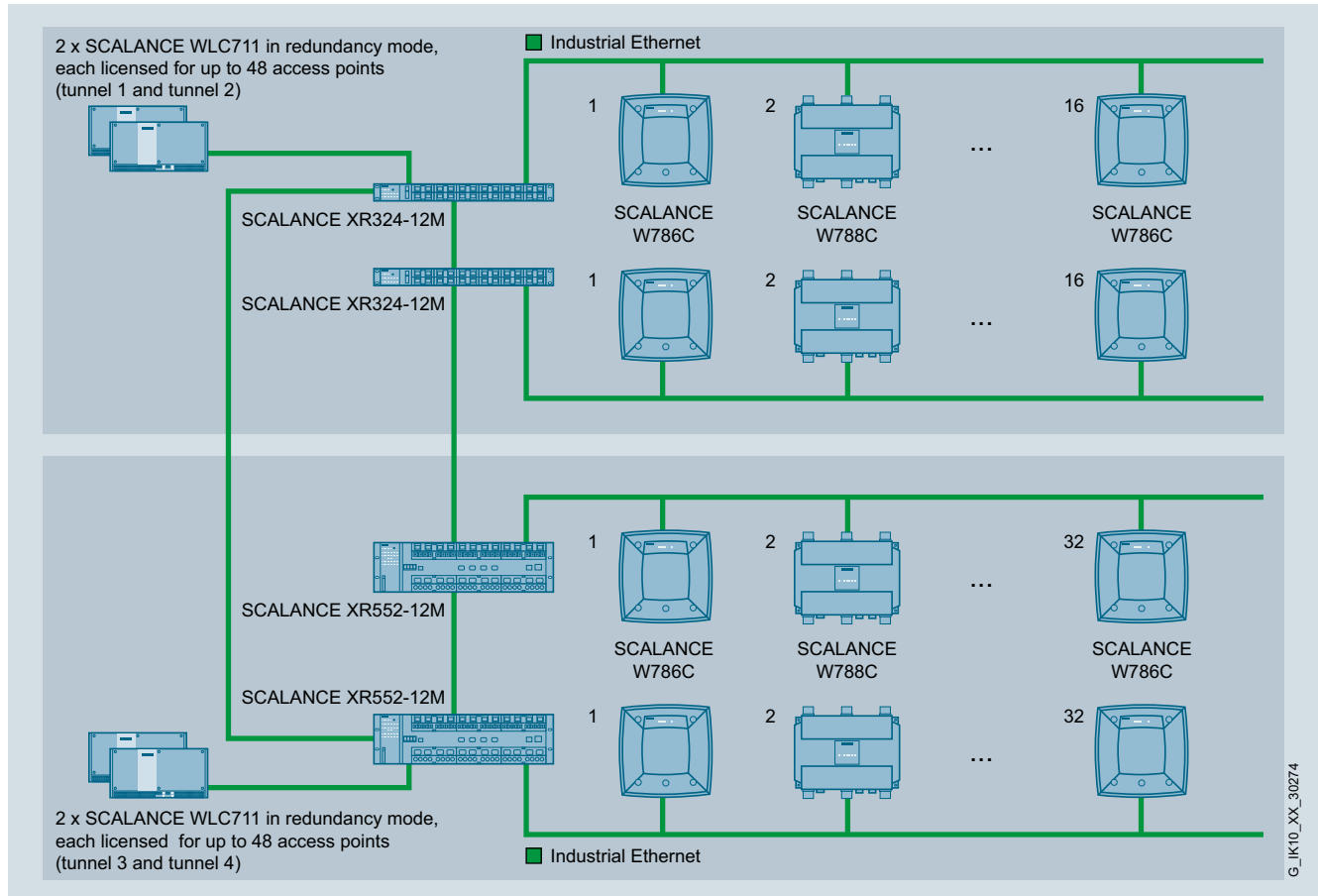

SCALANCE WLC711 IWLAN controller in redundancy mode

### Function

#### ***Fundamental principles of the controller-based Industrial Wireless LAN***

The SCALANCE WLC711 IWLAN controller enables centralized management of an Industrial Wireless LAN. It automatically detects new access points, establishes a connection to them, and manages and coordinates access points and clients. Thanks to the Layer 3 architecture, access points located in different Layer 2 subnets can also be managed. This function allows wireless expansion of an existing Ethernet network without having to make changes to the existing network topology.

With the IWLAN controller, the IWLAN wireless infrastructure can be divided into logical, service-based networks (**V**irtual **N**etwork **S**ervices). Different services, security requirements and access criteria can thus be reliably managed, and different user groups such as administrators, commissioning engineers, or visitors can use the same wireless network.

In the same way, different applications such as Voice-over-IP (VoIP), video and Internet access can use the same infrastructure. The result is optimal capacity utilization of the IWLAN network.

If applications with high reliability and availability requirements are to communicate wirelessly, either two IWLAN controllers can be operated redundantly or the access points can be set up redundantly (overlapping of the radio links due to two wireless cards in the device).

In applications where cable connections are not possible or are only possible with difficulty, the controller-based access points can be reliably integrated into the network even without a cable connection. Thanks to the mesh algorithms, the access points can resume communication in the event of a network error.

The controller-based access points of the SCALANCE W780C series can only be used with the SCALANCE WLC711 IWLAN controller and can only be configured using this IWLAN controller.

The IWLAN controller connects, manages and coordinates all access point and clients such that the WLAN environment appears like several IP subnets with central management. The individual connections are additionally managed here, and the stations can therefore move securely and reliably throughout the entire radio network.

#### ***Diagnostics and management functions***

As well as centralized management and wireless network configuration, the SCALANCE WLC711 IWLAN controller also offers error recording, wireless network monitoring, and documentation of network statistics.

### More information

Supplementary WLAN solutions for office environments can be found on the Internet at:  
<http://www.extremenetworks.com>

## Industrial Wireless Communication

### IWLAN – Controller and Controller Access Points IEEE 802.11n

#### SCALANCE WLC711 industrial wireless LAN controller

#### Overview

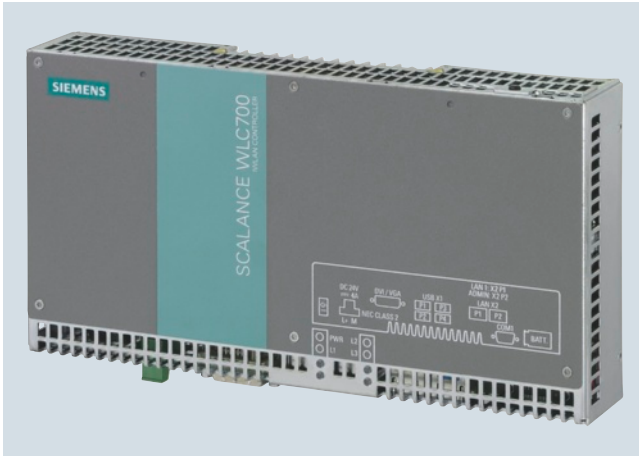

- Support for up to 48 access points in standard operation
- Support for up to 96 access points in redundant mode with two IWLAN controllers
- Supplied with license for 16 access points; expandable with license for 48 access points in standard mode
- Simultaneous support for up to 512 WLAN clients
- Support for up to 8 VNS segments
- Automatic detection of new access points
- Support for the SCALANCE W780C controller-based access points (IEEE 802.11a/b/g/n)

#### Application

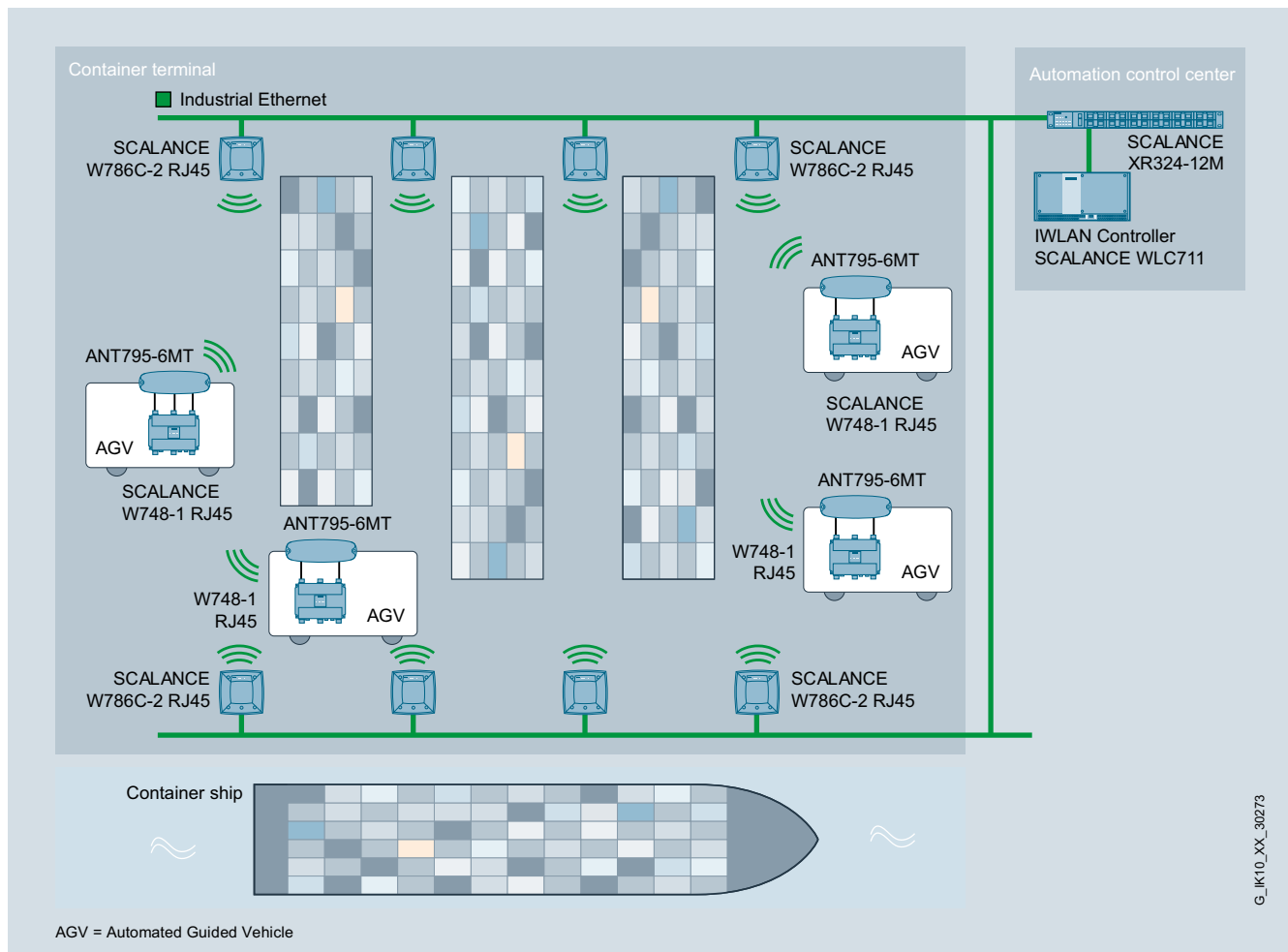

Controller-based IWLAN for applications with a large number of access points, e.g. in a container terminal

# Industrial Wireless Communication

## IWLAN – Controller and Controller Access Points IEEE 802.11n

### SCALANCE WLC711 industrial wireless LAN controller

#### Design

- 24 DC power supply
- Enclosure in the design of the SIMATIC Microbox IPC, in degree or protection IP20 for installation in the control cabinet
- Two 10/100/1 000 Mbit/s electrical RJ45 ports
- DIN rail and wall mounting possible
- Ambient temperature in operation 5 °C to 40 °C

#### Product versions

##### SCALANCE WLC711 IWLAN controller

- IWLAN controller licensed for the connection of up to 16 SCALANCE W780C controller-based access points

##### License key WLC-700

- Capacity upgrade for SCALANCE WLC711 for supporting up to 16 SCALANCE W780C controller-based access points for a total of up to 48 controller-based access points.

#### Technical specifications

Article No.	6GK5711-0XC00-1AA0 6GK5711-0XC00-1AB0 <sup>1)</sup> 6GK5711-0XC00-1AD0 <sup>2)</sup>
Product-type designation	SCALANCE WLC711 (RoW)
<b>Product description</b>	Supports SCALANCE W786C, W788C, W786-2HPW access points
Acceptability for application	Basic license for 16 access points pre-installed, expandable with 1 capacity upgrade license key WLC-700
<b>Transmission rate</b>	
Transmission rate with Industrial Ethernet	10 ... 1 000 Mbit/s
<b>Interfaces</b>	
Number of electrical connections	2
• for network components and terminal equipment	
• for power supply	1
Design of electrical connection	
• for network components and terminal equipment	RJ45 socket
• for power supply	2-pole screw terminal
<b>Supply voltage, current consumption, power loss</b>	
Type of supply voltage	DC
Supply voltage 1 from terminal block	24 V
Consumed current at 24 V with DC typical	4 A
Active power loss at 24V for DC typical	20 W
<b>Permitted ambient conditions</b>	
Ambient temperature	
• during operating	5 ... 40 °C
• during storage	-40 ... +60 °C
• during transport	-40 ... +60 °C
Relative humidity at 25 °C without condensation during operating maximum	95 %
Protection class IP	IP20
Ambient condition for (standard) operation mode	-

<sup>1)</sup> Wireless approval in the USA

<sup>2)</sup> Wireless approval in the JAPAN

Article No.	6GK5711-0XC00-1AA0 6GK5711-0XC00-1AB0 <sup>1)</sup> 6GK5711-0XC00-1AD0 <sup>2)</sup>
Product-type designation	SCALANCE WLC711 (RoW)
<b>Design, dimensions and weight</b>	
Width	262 mm
Height	142 mm
Depth	47 mm
Net weight	2 kg
Mounting type	
• 35 mm DIN rail mounting	
• wall mounting	Yes
Mounting type	Wall mounting using the supplied mounting brackets
<b>Product functions management, configuration</b>	
Product function	
• CLI	Yes
• web-based management	Yes
• MIB support	Yes
• WDS	Yes
Protocol is supported	
• Address Resolution Protocol (ARP)	No
• ICMP	Yes
• Telnet	Yes
• HTTP	Yes
• HTTPS	Yes
• TFTP	Yes
• SNMP v1	-
• SNMP v2	Yes
• SNMP v3	Yes
• DCP	No
• LLDP	No
<b>Product functions Diagnosis</b>	
Product function SysLog	Yes
<b>Product functions VLAN</b>	
Product function function VLAN with IWLAN	Yes
<b>Product functions DHCP</b>	
Product function	
• DHCP client	No
• in Client Mode DHCP server via LAN	-

## Industrial Wireless Communication

### IWLAN – Controller and Controller Access Points IEEE 802.11n

#### SCALANCE WLC711 industrial wireless LAN controller

#### Technical specifications (continued)

Article No.	6GK5711-0XC00-1AA0 6GK5711-0XC00-1AB0 <sup>1)</sup> 6GK5711-0XC00-1AD0 <sup>2)</sup>	Article No.	6GK5711-0XC00-1AA0 6GK5711-0XC00-1AB0 <sup>1)</sup> 6GK5711-0XC00-1AD0 <sup>2)</sup>
Product-type designation	SCALANCE WLC711 (RoW)	Product-type designation	SCALANCE WLC711 (RoW)
<b>Product functions Security</b>		<b>Standards, specifications, approvals</b>	
Product function		Standard	
• ACL - MAC-based	-	• for EMC from FM	-
• Management security, ACL-IP based	-	• for hazardous zone	-
• IEEE 802.1x (radius)	Yes	• for safety of CSA and UL	UL 60950-1 CSA C22.2 No. 60950-1, UL 508 CAN/CSA C22.2 No. 142
• NAT/NAPT	No	• for hazardous area of CSA and UL	-
• access protection according to IEEE802.11i	Yes	Verification of suitability	
• WPA/WPA2	Yes	• CE mark	Yes
• TKIP/AES	Yes	• EC declaration of conformity	Yes
Protocol is supported SSH	Yes	• C-Tick	Yes
<b>Product functions Time</b>		• CCC	-
Protocol is supported		• Railway application in accordance with EN 50155	No
• NTP	Yes	• e1 approval	No
• SNTP	No	• E1 approval	No
• SIMATIC Time	No	• NEMA4X	No
<b>Product functions IWLAN controller</b>		• Power-over-Ethernet according to IEEE802.3at for type 1 and IEEE802.3af	No
Number of supported access points		• Power-over-Ethernet according to IEEE802.3at for type 2	No
• in standard mode with one IWLAN controller	32	Standard for wireless communication	
• in redundancy mode with two IWLAN controllers	64	• IEEE 802.11a	Yes
Number of supported WLAN clients per IWLAN controller	512	• IEEE 802.11b	Yes
Number of VNS segments per IWLAN controller	8	• IEEE 802.11e	Yes
Product function		• IEEE 802.11g	Yes
• of the IWLAN controller	If delivered with basic license, 16 access points can operate in standard mode and 32 access points can operate in redundant mode. A capacity upgrade permits 32 access points in standard mode and 64 access points in redundant mode.	• IEEE 802.11h	Yes
• Pre-standard (CAPWAP)	Yes	• IEEE 802.11i	Yes
• integrated VLAN-VNS	Yes	• IEEE 802.11n	Yes
• auto-detection of new access points	Yes	Wireless approval	You will find the current list of countries at: <a href="http://www.siemens.com/wireless-approvals">www.siemens.com/wireless-approvals</a>
• CDR/RADIUS accounting	Yes	<b>Accessories</b>	
• Dynamic Radio Management	Yes	Accessories	24 V DC screw terminal and 2 mounting brackets included in the scope of delivery
• VoIP QoS mapping (DSCP/TCP-on-WMM)	Yes		
• VoIP roaming between IP subnets	Yes		
• VoIP roaming between several IWLAN controllers	Yes		
Load distribution function	DRM (Dynamic Radio/ RF Management), Packet Fairness, Flexible Client Access (Airtime Fairness), Load Balancing, Band-Steering		
Backup function for IWLAN controller	Redundancy mode with two IWLAN controllers (with capacity upgrade for both controllers, both controllers can be operated with 32 access points each. If one controller fails, the remaining controller can handle 64 access points.)		
Switching function	Traffic bridged at controller/traffic bridged locally at wireless access point		
Design of interface for public network access	Internal captive portal (web redirection)		

<sup>1)</sup> Wireless approval in the USA

<sup>2)</sup> Wireless approval in the JAPAN



## Industrial Wireless Communication

### IWLAN – Controller and Controller Access Points IEEE 802.11n

#### SCALANCE WLC711 industrial wireless LAN controller

Ordering data	Article No.	More information
<p><b>SCALANCE WLC711 IWLAN controller</b></p> <p>IWLAN controller licensed for the connection of up to 16 SCALANCE W78xC controller-based access points</p> <ul style="list-style-type: none"> <li>• National approvals for operation outside North America, Canada, and Japan (RoW)</li> <li>• National approvals for operation in North America, including Canada (NAM)<sup>1)</sup></li> <li>• National approvals for operation in Japan (JP)<sup>1)</sup></li> </ul>	<p><b>6GK5711-0XC00-1AA0</b></p> <p><b>6GK5711-0XC00-1AB0</b></p> <p><b>6GK5711-0XC00-1AD0</b></p>	<p><b>Selection tools:</b></p> <p>To assist in selecting Industrial Ethernet components, the TIA Selection Tool is available at:  <a href="http://www.siemens.com/tia-selection-tool">http://www.siemens.com/tia-selection-tool</a></p> <p><b>Wireless approvals:</b></p> <p>Current approvals can be found on the Internet at:  <a href="http://www.siemens.com/wireless-approvals">http://www.siemens.com/wireless-approvals</a></p>
<p><b>License key WLC700</b></p> <p>Capacity upgrade for SCALANCE WLC711 for support of up to 48 SCALANCE W78xC controller-based access points</p>	<p><b>6GK5907-1SB00</b></p>	
<p><b>Accessories</b></p>		
<p><b>IE TP Cord RJ45/RJ45</b></p> <p>TP cable 4 x 2 with 2 RJ45 connectors</p> <ul style="list-style-type: none"> <li>• 0.5 m</li> <li>• 1 m</li> <li>• 2 m</li> <li>• 6 m</li> <li>• 10 m</li> </ul>	<p><b>6XV1870-3QE50</b></p> <p><b>6XV1870-3QH10</b></p> <p><b>6XV1870-3QH20</b></p> <p><b>6XV1870-3QH60</b></p> <p><b>6XV1870-3QN10</b></p>	
<p><b>LOGO!Power 24 V/4 A</b></p> <p>Stabilized power supply; Input: 100 ... 240 V AC, output: 24 V DC/4 A</p>	<p><b>6EP1332-1SH52</b></p>	

<sup>1)</sup> Please note national approvals under  
<http://www.siemens.com/wireless-approvals>

## Industrial Wireless Communication

### IWLAN – Controller and Controller Access Points IEEE 802.11n

#### SCALANCE W788 RJ45 controller access points for use in control cabinet

##### Overview



- SCALANCE W788C-2 RJ45 controller-based access points can only be operated on the SCALANCE WLC711 IWLAN Controller
- Suitable for applications where the access point is to be mounted in the control cabinet

##### Design

- Rugged aluminum enclosure, shock and vibration-proof, for high mechanical requirements
- Dust protection with IP30 degree of protection
- For use at ambient temperatures from -20 °C to +60 °C
- 6 x R-SMA sockets for the connection of direct mountable and remote antennas
- Antenna placement optimized for the 3x3 MIMO technology; the antennas do not interfere with each other when they are mounted directly on the device
- Suitable for 2.4 GHz and 5 GHz
- 1 x RJ45 connector for 10/100/1 000 Mbit/s with Power-over-Ethernet according to IEEE 802.3at
- 2 x 24 V DC connection for redundant energy supply
- Function LEDs for optical signaling of faults and operating states
- Mounting: Wall, S7-1500 mounting rail, S7-300 mounting rail, or on 35 mm standard mounting rail

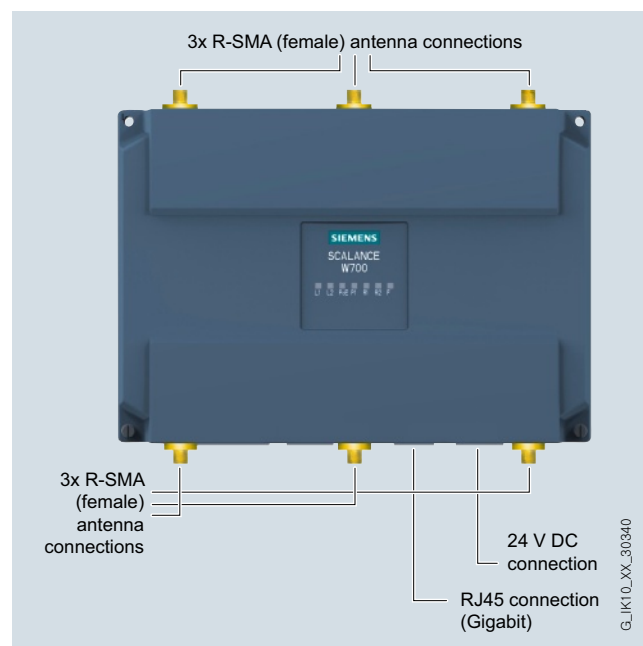

Design and interfaces of the SCALANCE W788C-2 RJ45 controller-based access points

##### Product versions

###### SCALANCE W788C-2 RJ45 (controller-based)

- Two wireless cards permanently installed in the device

## Industrial Wireless Communication

### IWLAN – Controller and Controller Access Points IEEE 802.11n

#### SCALANCE W788 RJ45 controller access points for use in control cabinet

#### Technical specifications

Article No.	6GK5788-2FC00-1AA0	Article No.	6GK5788-2FC00-1AA0
Product-type designation	SCALANCE W788C-2 RJ45	Product-type designation	SCALANCE W788C-2 RJ45
<b>Transmission rate</b>		<b>Supply voltage, current consumption, power loss</b>	
Transmission rate		Type of supply voltage	DC
• with W-LAN maximum	450 Mbit/s	Supply voltage	
• with Industrial Ethernet	10 ... 1 000 Mbit/s	• 1 from terminal block	19.2 V
• note	-	• 2 from terminal block	28.8 V
<b>Interfaces</b>		• from Power-over-Ethernet according IEEE802.3at for type 1 and IEEE802.3af	48 V
Number of electrical connections	1	• from Power-over-Ethernet according IEEE802.3at for type 2	50 V
• for network components and terminal equipment	1	Current consumed	
• for power supply	1	• at 24 V with DC typical	0.63 A
• for redundant power supply	1	• with Power-over-Ethernet according to IEEE802.3at for type 1 and IEEE802.3af typical	0.22 A
Design of electrical connection		• with Power-over-Ethernet according to IEEE802.3at for type 2 typical	0.3 A
• for network components and terminal equipment	RJ45 socket	Effective power loss	
• for power supply	4-pole screw terminal, PoE	• at 24V for DC typical	15 W
Number of optical interfaces for optical waveguide at 100 Mbit/s	-	• with Power-over-Ethernet according to IEEE802.3at for type 1 and IEEE802.3af typical	10.7 W
Design of optical interface for optical waveguide at 100 Mbit/s	-	• with Power-over-Ethernet according to IEEE802.3at for type 2 typical	15 W
Design of the removable storage C-PLUG	No	<b>Permitted ambient conditions</b>	
<b>Interfaces wireless</b>		Ambient temperature	
Number of radio cards permanently installed	2	• during operating	-20 ... +60 °C
Number of internal antennas	-	• during storage	-40 ... +70 °C
Number of electrical connections for external antenna(s)	6	• during transport	-40 ... +70 °C
Design of the electrical connection for external antenna(s)	N-Connect (socket)	Relative humidity at 25 °C without condensation during operating maximum	90 %
Product property external antenna can be mounted directly on device	Yes	Protection class IP	IP30
		Ambient condition for (standard) operation mode	When used under hazardous conditions (Zone 2), the SCALANCE W788-xPRO/RR or W74x-1PRO/RR product must be installed in an enclosure. To comply with EN 50021, this enclosure must meet the requirements of at least IP54 in compliance with EN 60529.

## Industrial Wireless Communication

### IWLAN – Controller and Controller Access Points IEEE 802.11n

#### SCALANCE W788 RJ45 controller access points for use in control cabinet

##### Technical specifications (continued)

Article No.	6GK5788-2FC00-1AA0	Article No.	6GK5788-2FC00-1AA0
Product-type designation	SCALANCE W788C-2 RJ45	Product-type designation	SCALANCE W788C-2 RJ45
<b>Design, dimensions and weight</b>		<b>Standards, specifications, approvals</b>	
Width of enclosure without antenna	200 mm	Standard	
Height of enclosure without antenna	158 mm	• for EMC from FM	FM 3611: Class I, Division 2, Groups A,B,C,D, T4 / Class 1, Zone 2, Group IIC, T4
Depth of enclosure without antenna	79 mm	• for hazardous zone	EN 60079-15:2005, EN 60079-0:2006, II 3 G Ex nA II T4 KEMA 07 ATEX 0145X
Net weight	1.7 kg	• for safety of CSA and UL	UL 60950-1 CSA C22.2 No. 60950-1
Mounting type wall mounting	Yes	Verification of suitability	
<b>Wireless frequencies</b>		• CE mark	Yes
Radio frequency		• EC declaration of conformity	Yes
• for WLAN in 2.4 GHz frequency band	2.41 ... 2.48 GHz	• C-Tick	Yes
• for WLAN in 5 GHz frequency band	4.9 ... 5.8 GHz	• CCC	No
<b>Product properties, functions, components general</b>		• Railway application in accordance with EN 50155	No
Product function		• e1 approval	No
• Access Point Mode	Yes	• E1 approval	No
• Client Mode	No	• NEMA4X	No
Number of SSIDs	16	• Power-over-Ethernet according IEEE802.3at for type 1 and IEEE802.3af	Yes
<b>Product functions management, configuration</b>		• Power-over-Ethernet according to IEEE802.3at for type 2	Yes
Product function		Standard for wireless communication	
• operation with IWLAN controller	Yes	• IEEE 802.11a	Yes
• operation with Enterasys WLAN controller	Yes	• IEEE 802.11b	Yes
		• IEEE 802.11g	Yes
		• IEEE 802.11h	Yes
		• IEEE 802.11n	Yes
		Wireless approval	You will find the current list of countries at: <a href="http://www.siemens.com/wireless-approvals">www.siemens.com/wireless-approvals</a>
		<b>Accessories</b>	
		Accessories	24 V DC screw terminal and screw terminal for digital input and output included in the scope of delivery

## Industrial Wireless Communication

### IWLAN – Controller and Controller Access Points IEEE 802.11n

#### SCALANCE W788 RJ45 controller access points for use in control cabinet

Ordering data	Article No.	More information
<b>SCALANCE W788C RJ45 Controller access points</b>		
IWLAN access points for operating with the SCALANCE WLC IWLAN Controller; with two built-in wireless interfaces; wireless networks IEEE 802.11a/b/g/h/n at 2.4/5 GHz up to 450 Mbit/s; WPA2/AES; Power over Ethernet (PoE), IP30 degree of protection (-20 °C to +60 °C); scope of delivery: Mounting hardware; manual on CD-ROM, German/English <b>• SCALANCE W788C-2 RJ45</b> with R-SMA female connections for six external antennas	<b>6GK5788-2FC00-1AA0</b>	<b>Selection tools:</b> To assist in selecting Industrial Ethernet components, the TIA Selection Tool is available at: <a href="http://www.siemens.com/tia-selection-tool">http://www.siemens.com/tia-selection-tool</a>  <b>Wireless approvals:</b> Current approvals can be found on the Internet at: <a href="http://www.siemens.com/wireless-approvals">http://www.siemens.com/wireless-approvals</a>
<b>Accessories</b>		
<b>DIN rail mounting adapter</b> DIN rail mounting adapter for SCALANCE W788 M12 and SCALANCE W788 RJ45; screw fixing for mounting on a 35 mm DIN rail to EN 50 022; scope of supply: 3 units per pack	<b>6GK5798-8ML00-0AB3</b>	
<b>IE FC RJ45 Plug 4 x 2</b> RJ45 plug connector for Industrial Ethernet (10/100/1 000 Mbit/s) with a sturdy metal enclosure and integrated insulation displacement contacts for connecting Industrial Ethernet FC installation cables; 180° cable outlet; for network components and CPs/CPU with Industrial Ethernet interface <ul style="list-style-type: none"> <li>• 1 pack = 1 unit</li> <li>• 1 pack = 10 units</li> <li>• 1 pack = 50 units</li> </ul>	<b>6GK1901-1BB11-2AA0</b> <b>6GK1901-1BB11-2AB0</b> <b>6GK1901-1BB11-2AE0</b>	
<b>IE FC Standard Cable GP 4 x 2</b> 8-core, shielded TP installation cable for connection to IE FC RJ45 Plug 4 x 2 and IE M12 Plug PRO 4 x 2; PROFINET-compatible; with UL approval; sold by the meter; max. length 1 000 m, minimum order quantity 20 m	<b>6XV1878-2A</b>	
<b>IE FC Stripping Tool</b> Preadjusted stripping tool for fast stripping of the Industrial Ethernet FC cables	<b>6GK1901-1GA00</b>	
<b>Antennas and miscellaneous IWLAN accessories</b>	See Industrial Wireless LAN/ accessories	

## Industrial Wireless Communication

### IWLAN – Controller and Controller Access Points IEEE 802.11n

#### SCALANCE W788C M12 controller access points for indoor use

##### Overview



- SCALANCE W788C-2 M12 controller-based access points can only be operated on the SCALANCE WLC IWLAN Controller
- Particularly suitable for industrial applications without control cabinets

##### Design

- Rugged aluminum enclosure, shock and vibration-proof, for high mechanical requirements
- High IP65 degree of protection against dust and water jets
- For use at ambient temperatures from -20 °C to +60 °C
- 6 x N-Connect sockets for the connection of direct mountable and remote antennas
- Antenna placement optimized for the 3x3 MIMO technology; the antennas do not interfere with each other when they are mounted directly on the device
- Suitable for 2.4 GHz and 5 GHz
- 1 x M12 connection for 10/100/1 000 Mbit/s with Power-over-Ethernet according to IEEE 802.3at
- 1 x M12 socket for power supply (24 V DC)
- Function LEDs for optical signaling of faults and operating states
- Mounting: Wall, S7-1500 mounting rail, S7-300 mounting rail, or on 35 mm standard mounting rail

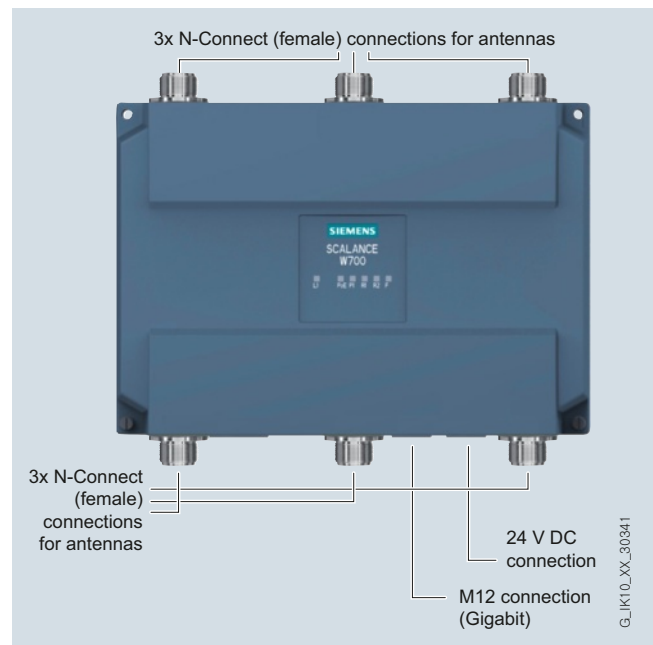

Design and interfaces of the SCALANCE W788C-2 M12 controller-based access points

##### Product versions

#### SCALANCE W788C-2 M12 (controller-based)

- Two wireless cards permanently installed in the device

## Industrial Wireless Communication

### IWLAN – Controller and Controller Access Points IEEE 802.11n

#### SCALANCE W788C M12 controller access points for indoor use

#### Technical specifications

Article No.	6GK5788-2GD00-1AA0	Article No.	6GK5788-2GD00-1AA0
Product-type designation	SCALANCE W788C-2 M12	Product-type designation	SCALANCE W788C-2 M12
<b>Transmission rate</b>		<b>Supply voltage, current consumption, power loss</b>	
Transmission rate		Type of supply voltage	DC
• with W-LAN maximum	450 Mbit/s	Supply voltage	
• with Industrial Ethernet	10 ... 1 000 Mbit/s	• 1 from M12 Power Connector (A-coded) for redundant power supply	19.2 V
• note	-	• 2 from M12 Power Connector (A-coded) for redundant power supply	28.8 V
<b>Interfaces</b>		• from Power-over-Ethernet according to IEEE802.3af for type 1 and IEEE802.3af	48 V
Number of electrical connections		• from Power-over-Ethernet according to IEEE802.3af for type 2	50 V
• for network components and terminal equipment	1	Current consumed	
• for power supply	1	• at 24 V with DC typical	0.63 A
• for redundant power supply	1	• with Power-over-Ethernet according to IEEE802.3af for type 1 and IEEE802.3af typical	0.22 A
Design of electrical connection		• with Power-over-Ethernet according to IEEE802.3af for type 2 typical	0.3 A
• for network components and terminal equipment	M12 interface (8-pole, X-coded) PoE	Effective power loss	
• for power supply	M12 interface (4-pole, A-coded) PoE	• at 24V for DC typical	15 W
Number of optical interfaces for optical waveguide at 100 Mbit/s	-	• with Power-over-Ethernet according to IEEE802.3af for type 1 and IEEE802.3af typical	10.7 W
Design of optical interface for optical waveguide at 100 Mbit/s	-	• with Power-over-Ethernet according to IEEE802.3af for type 2 typical	15 W
design of the removable storage C-PLUG	No	<b>Permitted ambient conditions</b>	
<b>Interfaces wireless</b>		Ambient temperature	
Number of radio cards permanently installed	2	• during operating	-20 ... +60 °C
Number of internal antennas	-	• during storage	-40 ... +70 °C
Number of electrical connections for external antenna(s)	6	• during transport	-40 ... +70 °C
Design of the electrical connection for external antenna(s)	N-Connect (socket)	Relative humidity at 25 °C without condensation during operating maximum	90 %
Product property external antenna can be mounted directly on device	Yes	Protection class IP	IP65
		Ambient condition for (standard) operation mode	When used under hazardous conditions (Zone 2), the SCALANCE W788-xPRO/RR or W74x-1PRO/RR product must be installed in an enclosure. To comply with EN 50021, this enclosure must meet the requirements of at least IP54 in compliance with EN 60529.

## Industrial Wireless Communication

### IWLAN – Controller and Controller Access Points IEEE 802.11n

#### SCALANCE W788C M12 controller access points for indoor use

##### Technical specifications (continued)

Article No.	6GK5788-2GD00-1AA0	Article No.	6GK5788-2GD00-1AA0
Product-type designation	SCALANCE W788C-2 M12	Product-type designation	SCALANCE W788C-2 M12
<b>Design, dimensions and weight</b>		<b>Standards, specifications, approvals</b>	
Width of enclosure without antenna	200 mm	Standard	
Height of enclosure without antenna	176 mm	• for hazardous zone	EN 60079-15:2005, EN 60079-0:2006, II 3 G Ex nA II T4 KEMA 07 ATEX 0145X
Depth of enclosure without antenna	79 mm	• for safety of CSA and UL	UL 60950-1 CSA C22.2 No. 60950-1
Net weight	1.7 kg	Verification of suitability	
Mounting type wall mounting	Yes	• CE mark	Yes
<b>Wireless frequencies</b>		• EC declaration of conformity	Yes
Radio frequency		• C-Tick	Yes
• for WLAN in 2.4 GHz frequency band	2.41 ... 2.48 GHz	• Railway application in accordance with EN 50155	No
• for WLAN in 5 GHz frequency band	4.9 ... 5.8 GHz	• e1 approval	No
<b>Product properties, functions, components general</b>		• E1 approval	No
Product function		• NEMA4X	No
• Access Point Mode	Yes	• Power-over-Ethernet according to IEEE802.3at for type 1 and IEEE802.3af	Yes
• Client Mode	No	• Power-over-Ethernet according to IEEE802.3at for type 2	Yes
Number of SSIDs	16	Standard for wireless communication	
<b>Product functions management, configuration</b>		• IEEE 802.11a	Yes
Product function		• IEEE 802.11b	Yes
• operation with IWLAN controller	Yes	• IEEE 802.11g	Yes
• operation with Enterasys WLAN controller	Yes	• IEEE 802.11h	Yes
		• IEEE 802.11n	Yes
		Wireless approval	You will find the current list of countries at: <a href="http://www.siemens.com/wireless-approvals">www.siemens.com/wireless-approvals</a>
<b>Accessories</b>		<b>Accessories</b>	
Accessories		-	



## Industrial Wireless Communication

### IWLAN – Controller and Controller Access Points IEEE 802.11n

#### SCALANCE W788C M12 controller access points for indoor use

Ordering data	Article No.	More information
<b>SCALANCE W788C M12 Controller Access Points</b>		
IWLAN access points for operating with the SCALANCE WLC IWLAN Controller; with two built-in wireless interfaces; wireless networks IEEE 802.11a/b/g/h/n at 2.4/5 GHz up to 450 Mbit/s; WPA2/AES; Power over Ethernet (PoE), IP65 degree of protection (-20 °C to +60 °C); scope of delivery: Mounting hardware; manual on CD-ROM, German/English <b>• SCALANCE W788C-2 M12</b> with N-Connect female connections for six external antennas	<b>6GK5788-2GD00-1AA0</b>	<b>Selection tools:</b> To assist in selecting Industrial Ethernet components, the TIA Selection Tool is available at: <a href="http://www.siemens.com/tia-selection-tool">http://www.siemens.com/tia-selection-tool</a>  <b>Wireless approvals:</b> Current approvals can be found on the Internet at: <a href="http://www.siemens.com/wireless-approvals">http://www.siemens.com/wireless-approvals</a>
<b>Accessories</b>		
<b>IE FC M12 Plug PRO 4 x 2</b>  M12 plug-in connector suitable for on-site assembly (X-coded, IP65/IP67), metal enclosure, insulation/displacement fast connection method, for SCALANCE W <b>• 1 unit</b> <b>• 8 units</b>	<b>6GK1901-0DB30-6AA0</b> <b>6GK1901-0DB30-6AA8</b>	
<b>DIN rail mounting adapter</b>  DIN rail mounting adapter for SCALANCE W788 M12 and SCALANCE W788 RJ45; screw fixing for mounting on a 35 mm DIN rail to EN 50 022; scope of supply: 3 units per pack	<b>6GK5798-8ML00-0AB3</b>	
<b>IE FC Standard Cable GP 4 x 2</b>  8-core, shielded TP installation cable for connection to IE FC RJ45 Plug 4 x 2 and IE M12 Plug PRO 4 x 2; PROFINET-compatible; with UL approval; sold by the meter; max. length 1 000 m, minimum order quantity 20 m	<b>6XV1878-2A</b>	
<b>IE FC Flexible Cable GP 4 x 2</b>  8-core, shielded TP installation cable for connection to IE FC RJ45 Plug 4 x 2 and IE M12 Plug PRO 4 x 2 for occasional movement; PROFINET-compliant; with UL approval; sold by the meter; max. length 1 000 m, minimum order 20 m	<b>6XV1878-2B</b>	
<b>IE FC Stripping Tool</b>  Preadjusted stripping tool for fast stripping of the Industrial Ethernet FC cables	<b>6GK1901-1GA00</b>	
<b>Power M12 Cable Connector PRO</b>  Terminal socket for connection of SCALANCE W700 for 24 V DC supply voltage; 4-pole, A-coded, with assembly instructions, 3 units	<b>6GK1907-0DC10-6AA3</b>	
<b>Power Cable 2 x 0.75</b>  Connecting cable for Power M12 Cable Connector PRO, sold by the meter	<b>6XV1812-8A</b>	
<b>Antennas and miscellaneous IWLAN accessories</b>	See Industrial Wireless LAN/ accessories	

## Industrial Wireless Communication

### IWLAN – Controller and Controller Access Points IEEE 802.11n

#### SCALANCE W788C M12 EEC for enhanced environmental conditions

##### Overview



- SCALANCE W788C-2 M12 controller-based access points can only be operated on the SCALANCE WLC711 IWLAN Controller
- Suitable for use in the industry and automation area, but especially in the rail transport environment

##### Design

- Rugged aluminum enclosure, shock and vibration-proof, for high mechanical requirements
- Special coating of the printed circuit boards (conformal coating)
- Resistant to condensation
- Railroad approval in accordance with EN 50155
- High IP65 degree of protection against dust and water jets
- For use at ambient temperatures from -40 °C to +70 °C
- 6 x N-Connect sockets for the connection of direct mountable and remote antennas
- Antenna placement optimized for the 3x3 MIMO technology; the antennas do not interfere with each other when they are mounted directly on the device
- 1 x M12 connection for 10/100/1 000 Mbit/s with Power-over-Ethernet according to IEEE 802.3at
- 1 x M12 socket for power supply (24 V DC)
- Function LEDs for optical signaling of faults/errors and operating statuses
- Mounting: Wall, S7-1500 mounting rail, S7-300 mounting rail, or on 35 mm standard mounting rail

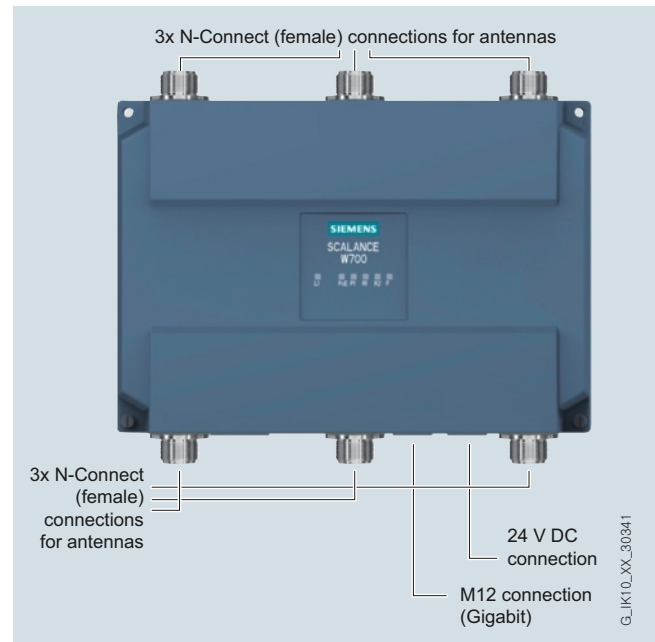

Design and interfaces of the SCALANCE W788C-2 M12 EEC controller-based access points

##### Product version

#### SCALANCE W788C-2 M12 EEC (controller-based)

- Two wireless cards permanently installed in the device; six connections for external antennas

# Industrial Wireless Communication IWLAN – Controller and Controller Access Points IEEE 802.11n

## SCALANCE W788C M12 EEC for enhanced environmental conditions

### Integration

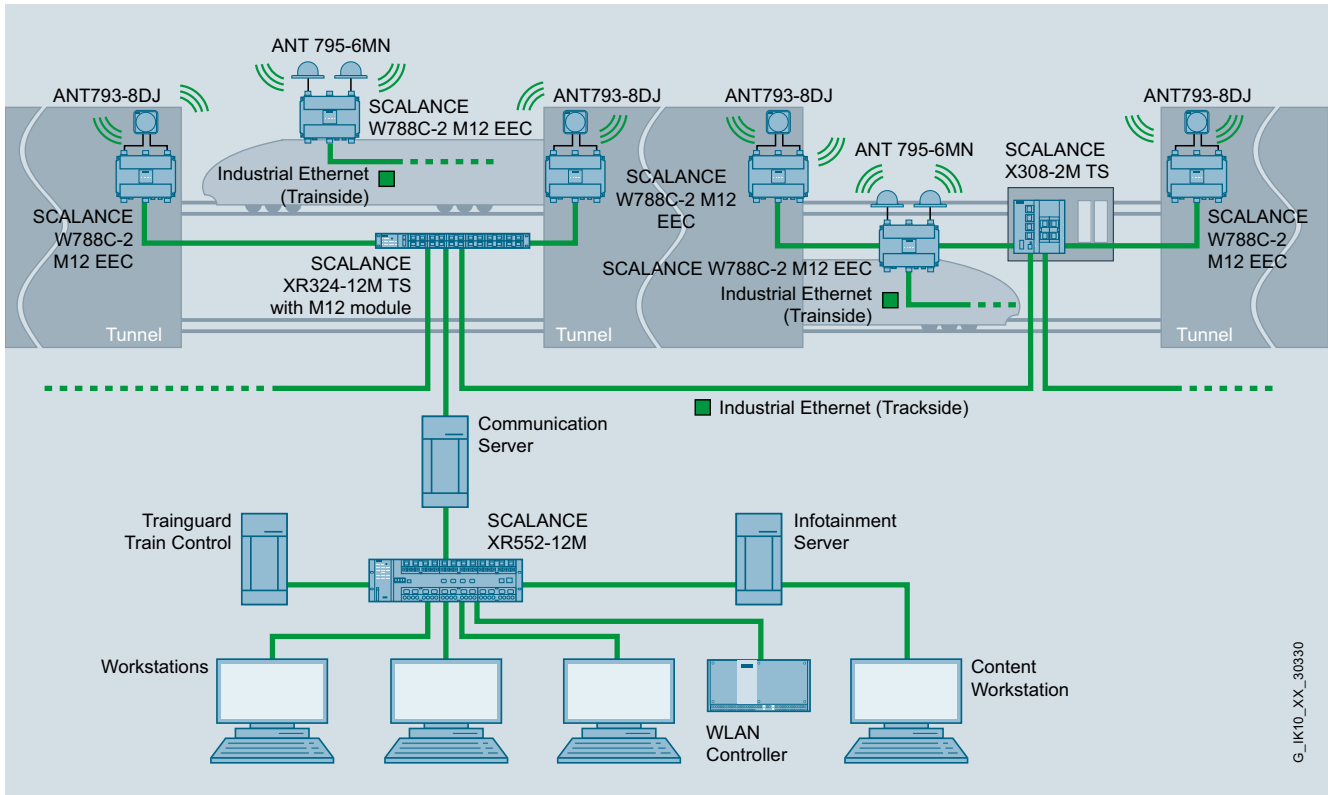

Data transfer on trains using SCALANCE Controller-based access points

G\_IK10\_XX\_30330

## Industrial Wireless Communication

### IWLAN – Controller and Controller Access Points IEEE 802.11n

#### SCALANCE W788C M12 EEC for enhanced environmental conditions

#### Technical specifications

Article No.	6GK5788-2GD00-1TA0	Article No.	6GK5788-2GD00-1TA0
Product-type designation	SCALANCE W788C-2 M12 EEC	Product-type designation	SCALANCE W788C-2 M12 EEC
<b>Transmission rate</b>		<b>Supply voltage, current consumption, power loss</b>	
Transmission rate		Type of supply voltage	DC
• with W-LAN maximum	450 Mbit/s	Supply voltage	
• with Industrial Ethernet	10 ... 1 000 Mbit/s	• 1 from M12 Power Connector (A-coded) for redundant power supply	19.2 V
• note	-	• 2 from M12 Power Connector (A-coded) for redundant power supply	28.8 V
<b>Interfaces</b>		• from Power-over-Ethernet according IEEEE802.3at for type 1 and IEEEE802.3af	48 V
Number of electrical connections		• from Power-over-Ethernet according IEEEE802.3at for type 2	50 V
• for network components and terminal equipment	1	Current consumed	
• for power supply	1	• at 24 V with DC typical	0.63 A
• for redundant power supply	1	• with Power-over-Ethernet according to IEEEE802.3at for type 1 and IEEEE802.3af typical	0.22 A
Design of the electrical connection		• with Power-over-Ethernet according to IEEEE802.3at for type 2 typical	0.3 A
• for network components and terminal equipment	M12 interface (8-pole, X-coded) PoE	Effective power loss	
• for power supply	M12 interface (4-pole, A-coded)	• at 24V for DC typical	15 W
Number of optical interfaces for optical waveguide at 100 Mbit/s	-	• with Power-over-Ethernet according to IEEEE802.3at for type 1 and IEEEE802.3af typical	10.7 W
Design of optical interface for optical waveguide at 100 Mbit/s	-	• with Power-over-Ethernet according to IEEEE802.3at for type 2 typical	15 W
Design of the removable storage C-PLUG	No		
<b>Interfaces wireless</b>			
Number of radio cards permanently installed	2		
Number of internal antennas	-		
Number of electrical connections for external antenna(s)	6		
Design of the electrical connection for external antenna(s)	N-Connect (socket)		
Product property external antenna can be mounted directly on device	Yes		

# Industrial Wireless Communication

## IWLAN – Controller and Controller Access Points IEEE 802.11n

### SCALANCE W788C M12 EEC for enhanced environmental conditions

#### Technical specifications (continued)

Article No.	6GK5788-2GD00-1TA0	Article No.	6GK5788-2GD00-1TA0
Product-type designation	SCALANCE W788C-2 M12 EEC	Product-type designation	SCALANCE W788C-2 M12 EEC
<b>Permitted ambient conditions</b>		<b>Product functions management, configuration</b>	
Ambient temperature		• operation with IWLAN controller	Yes
• during operating	-20 ... +60 °C	• operation with Enterasys WLAN controller	Yes
• during storage	-40 ... +70 °C		
• during transport	-40 ... +70 °C	<b>Standards, specifications, approvals</b>	
Relative humidity at 25 °C without condensation during operating maximum	90 %	Standard	
Protection class IP	IP65	• for EMC from FM	FM 3611: Class I, Division 2, Groups A,B,C,D, T4 / Class 1, Zone 2, Group IIC, T4
Ambient condition for (standard) operation mode	When used under hazardous conditions (Zone 2), the SCALANCE W788-xPRO/RR or W74x-1PRO/RR product must be installed in an enclosure. To comply with EN 50021, this enclosure must meet the requirements of at least IP 54 in compliance with EN 60529.	• for hazardous zone	-
		• for safety of CSA and UL	UL 60950-1 CSA C22.2 No. 60950-1
<b>Design, dimensions and weight</b>		Verification of suitability	
Width of enclosure without antenna	200 mm	• CE mark	Yes
Height of enclosure without antenna	176 mm	• EC declaration of conformity	Yes
Depth of enclosure without antenna	79 mm	• C-Tick	Yes
Net weight	1.7 kg	• CCC	-
Mounting type wall mounting	Yes	• Railway application in accordance with EN 50155	Yes
<b>Wireless frequencies</b>		• e1 approval	No
Radio frequency		• E1 approval	No
• for WLAN in 2.4 GHz frequency band	2.41 ... 2.48 GHz	• NEMA4X	No
• for WLAN in 5 GHz frequency band	4.9 ... 5.8 GHz	• Power-over-Ethernet according IEEE802.3af for type 1 and IEEE802.3af	Yes
<b>Product properties, functions, components general</b>		• Power-over-Ethernet according to IEEE802.3at for type 2	Yes
Product function		Standard for wireless communication	
• Access Point Mode	Yes	• IEEE 802.11a	Yes
• Client Mode	No	• IEEE 802.11b	Yes
Number of SSIDs	16	• IEEE 802.11e	Yes
		• IEEE 802.11g	Yes
		• IEEE 802.11h	Yes
		• IEEE 802.11i	Yes
		• IEEE 802.11n	Yes
		Wireless approval	You will find the current list of countries at: <a href="http://www.siemens.com/wireless-approvals">www.siemens.com/wireless-approvals</a>
		<b>Accessories</b>	
		Accessories	-

## Industrial Wireless Communication

### IWLAN – Controller and Controller Access Points IEEE 802.11n

#### SCALANCE W788C M12 EEC for enhanced environmental conditions

##### Ordering data

##### Article No.

###### SCALANCE W788C M12 EEC Controller Access Points

IWLAN access points for operation with the SCALANCE WLC IWLAN controller; with built-in wireless interfaces; wireless networks IEEE 802.11a/b/g/h/n at 2.4/5 GHz up to 450 Mbit/s; railroad approval in accordance with EN 50155; conformal coating; WPA2/AES; Power over Ethernet (PoE), IP65 degree of protection; scope of supply: Mounting hardware; manual on CD-ROM, German/English

- **SCALANCE W788C-2 M12 EEC** with N-Connect female connections for six external antennas

**6GK5788-2GD00-1TA0**

###### Accessories

##### IE FC M12 Plug PRO 4 x 2

M12 plug-in connector suitable for on-site assembly (X-coded, IP65/IP67), metal enclosure, insulation displacement fast connection method, for SCALANCE W

- 1 unit
- 2 units

**6GK1901-0DB30-6AA0**  
**6GK1901-0DB30-6AA8**

##### DIN rail mounting adapter

DIN rail mounting adapter for SCALANCE W788 M12 and SCALANCE W788 RJ45; screw fixing for mounting on a 35 mm DIN rail to EN 50 022; scope of supply: 3 units per pack

**6GK5798-8ML00-0AB3**

##### IE FC standard cable GP 4 x 2

8-core, shielded TP installation cable for connection to IE FC RJ45 Plug 4 x 2 and IE M12 Plug PRO 4 x 2; PROFINET-compliant; with UL approval; sold by the meter; max. length 1 000 m, minimum order quantity 20 m

**6XV1878-2A**

##### IE FC flexible cable GP 4 x 2

8-core, shielded TP installation cable for connection to IE FC RJ45 Plug 4 x 2 and IE M12 Plug PRO 4 x 2 for occasional movement; PROFINET-compliant; with UL approval; sold by the meter; max. length 1 000 m, minimum order 20 m

**6XV1878-2B**

##### IE FC Stripping Tool

Preadjusted stripping tool for fast stripping of the Industrial Ethernet FC cables

**6GK1901-1GA00**

##### Power M12 cable connector PRO

Terminal socket for connection of SCALANCE W700 for 24 V DC supply voltage; 4-pole, A-coded, with assembly instructions, 3 units

**6GK1907-0DC10-6AA3**

##### Power Cable 2 x 0.75

Connecting cable for Power M12 cable connector PRO, sold by the meter

**6XV1812-8A**

##### Antennas and miscellaneous IWLAN accessories

See Industrial Wireless LAN/ accessories

##### More information

###### Selection tools:

To assist in selecting Industrial Ethernet components, the TIA Selection Tool is available at:  
<http://www.siemens.com/tia-selection-tool>

###### Wireless approvals:

Current approvals can be found on the Internet at:  
<http://www.siemens.com/wireless-approvals>

## Industrial Wireless Communication

### IWLAN – Controller and Controller Access Points IEEE 802.11n

#### SCALANCE W786 RJ45 controller access points for outdoor use

#### Overview



- SCALANCE W786C-2 controller-based access points can only be operated on the SCALANCE WLC IWLAN Controller
- Particularly well-suited to applications with demanding climatic requirements when installed outdoors and in areas accessible to the public

#### Design

- Rugged, impact-resistant plastic enclosure, shock and vibration-proof for demanding mechanical requirements
- High IP65 degree of protection against dust and water jets
- For use at ambient temperatures from -40 °C to +60 °C
- Resistant to condensation
- Resistant to UV radiation and saltwater spray
- Design for use outdoors
- 6 x R-SMA sockets for the connection of remote antennas
- Suitable for 2.4 GHz and 5 GHz
- 1 x RJ45 connector for 10/100/1 000 Mbit/s and Power-over-Ethernet according to IEEE 802.3at
- 1 x 24 V DC connector, optional operation with 12 to 24 V DC or 100 to 240 V AC with power supply that can be integrated in the device
- Function LEDs for optical signaling of faults and operating states
- Mounting: Wall or, with optional mounting set, on S7 mounting rail, 35 mm standard mounting rail, or on a pole

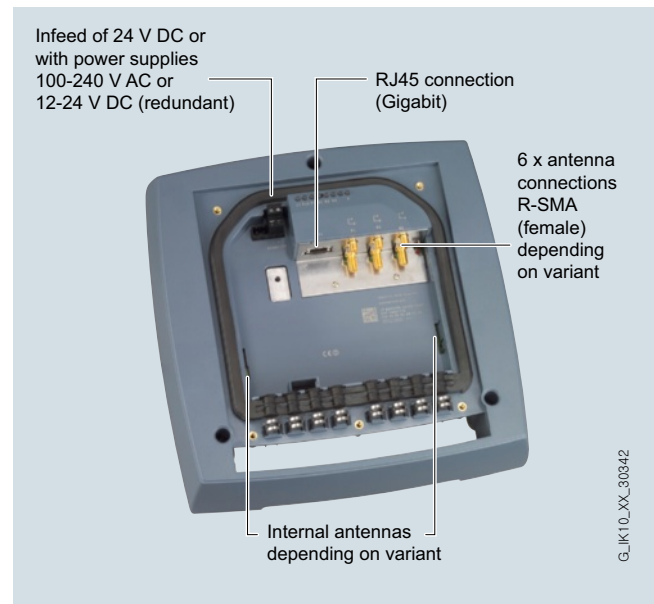

Design and interfaces of the SCALANCE W786C-2 controller-based access points

#### Product versions

##### **SCALANCE W786C-2 RJ45 (controller-based)**

- Two wireless cards permanently installed in the device; six connections for external antennas

##### **SCALANCE W786C-2IA RJ45 (controller-based)**

- Two wireless cards permanently installed in the device; six internal antennas

## Industrial Wireless Communication

### IWLAN – Controller and Controller Access Points IEEE 802.11n

#### SCALANCE W786 RJ45 controller access points for outdoor use

#### Technical specifications

Article No.	6GK5786-2HC00-1AA0	6GK5 786-2FC00-1AA0
Product-type designation	SCALANCE W786C-2IA RJ45	SCALANCE W786C-2 RJ45
<b>Transmission rate</b>		
Transmission rate		
• with W-LAN maximum	450 Mbit/s	450 Mbit/s
• with Industrial Ethernet	10 ... 1 000 Mbit/s	10 ... 1 000 Mbit/s
• note	-	-
<b>Interfaces</b>		
Number of electrical connections		
• for network components and terminal equipment	1	1
• for power supply	1	1
• for redundant power supply	1	1
Design of electrical connection		
• for network components and terminal equipment	RJ45 socket	RJ45 socket
• for power supply	2-pole connector (24 V DC) or optionally available power supply adapter (4-pole 24 V DC or 3-pole 110 to 230 V AC)	2-pole connector (24 V DC) or optionally available power supply adapter (4-pole 24 V DC or 3-pole 110 to 230 V AC)
Number of optical interfaces for optical waveguide at 100 Mbit/s	-	-
Design of optical interface for optical waveguide at 100 Mbit/s	-	-
Number of optical interfaces for optical waveguide at 1 000 Mbit/s	-	-
Design of optical interface for optical waveguide at 1 000 Mbit/s	-	-
Design of the removable storage C-PLUG	No	No
<b>Interfaces wireless</b>		
Number of radio cards permanently installed	2	2
Number of internal antennas	6	-
Number of electrical connections for external antenna(s)	-	6
Design of the electrical connection for external antenna(s)	-	R-SMA (socket)
Product property external antenna can be mounted directly on device	-	No
<b>Supply voltage, current consumption, power loss</b>		
Type of supply voltage	DC	DC
Supply voltage		
• 1 from terminal block	19.2 V	19.2 V
• 2 from terminal block	28.8 V	28.8 V
• from Power-over-Ethernet according IEEE802.3at for type 1 and IEEE802.3af	48 V	48 V
• from Power-over-Ethernet according IEEE802.3at for type 2	50 V	50 V
• from optional integratable power supply		
- with AC	100 ... 240 V	100 ... 240 V
- with DC	12 ... 24 V	12 ... 24 V
Current consumed		
• at 24 V with DC typical	0.63 A	0.63 A
• at 230 V with AC typical	0.07 A	0.07 A
• with Power-over-Ethernet according to IEEE802.3at for type 1 and IEEE802.3af typical	0.22 A	0.22 A
• with Power-over-Ethernet according to IEEE802.3at for type 2 typical	-	-



## Industrial Wireless Communication

### IWLAN – Controller and Controller Access Points IEEE 802.11n

#### SCALANCE W786 RJ45 controller access points for outdoor use

#### Technical specifications (continued)

Article No.	6GK5786-2HC00-1AA0	6GK5 786-2FC00-1AA0
Product-type designation	SCALANCE W786C-2IA RJ45	SCALANCE W786C-2 RJ45
Effective power loss		
• at 24V for DC typical	15 W	15 W
• at 230 V with AC typical	15 W	15 W
• with Power-over-Ethernet according to IEEE802.3at for type 1 and IEEE802.3af typical	15 W	10.7 W
• with Power-over-Ethernet according to IEEE802.3at for type 2 typical	-	-
<b>Permitted ambient conditions</b>		
Ambient temperature		
• during operating	-40 ... +60 °C	-40 ... +60 °C
• during storage	-40 ... +85 °C	-40 ... +85 °C
• during transport	-40 ... +85 °C	-40 ... +85 °C
Relative humidity at 25 °C without condensation during operating maximum	100 %	100 %
Protection class IP	IP65	IP65
Ambient condition for (standard) operation mode	When using the power supply 100 to 240 V AC, an operating temperature of -40 °C to +60 °C is permissible	When using the power supply 100 to 240 V AC, an operating temperature of -40 °C to +60 °C is permissible
<b>Design, dimensions and weight</b>		
Width of enclosure without antenna	251 mm	251 mm
Height of enclosure without antenna	251 mm	251 mm
Depth of enclosure without antenna	72 mm	72 mm
Net weight	2.24 kg	2.24 kg
Mounting type wall mounting	Yes	Yes
Mounting type	For mast mounting, 35 mm DIN rail mounting and S7-300 rail mounting, an additional support plate is required	For mast mounting, 35 mm DIN rail mounting and S7-300 rail mounting, an additional support plate is required
<b>Wireless frequencies</b>		
Radio frequency		
• for WLAN in 2.4 GHz frequency band	2.41 ... 2.48 GHz	2.41 ... 2.48 GHz
• for WLAN in 5 GHz frequency band	4.9 ... 5.8 GHz	4.9 ... 5.8 GHz
<b>Product properties, functions, components general</b>		
Product function		
• Access Point Mode	Yes	Yes
• Client Mode	No	No
Number of SSIDs	16	16
<b>Product functions management, configuration</b>		
Product function		
• operation with IWLAN controller	Yes	Yes
• operation with Enterasys WLAN controller	Yes	Yes

## Industrial Wireless Communication

### IWLAN – Controller and Controller Access Points IEEE 802.11n

#### SCALANCE W786 RJ45 controller access points for outdoor use

##### Technical specifications (continued)

Article No.	6GK5786-2HC00-1AA0	6GK5 786-2FC00-1AA0
Product-type designation	SCALANCE W786C-2IA RJ45	SCALANCE W786C-2 RJ45
<b>Standards, specifications, approvals</b>		
Standard		
• for hazardous zone	EN 60079-15:2005, EN 60079-0:2006, II 3 G Ex nA II T4 KEMA 07 ATEX 0145X	EN 60079-15:2005, EN 60079-0:2006, II 3 G Ex nA II T4 KEMA 07 ATEX 0145X
• for safety of CSA and UL	UL 60950-1 CSA C22.2 No. 60950-1	UL 60950-1 CSA C22.2 No. 60950-1
Verification of suitability		
• CE mark	Yes	Yes
• EC declaration of conformity	Yes	Yes
• C-Tick	Yes	Yes
• CCC	No	No
• Railway application in accordance with EN 50155	No	No
• e1 approval		
• E1 approval	No	No
• NEMA4X	Yes	Yes
• Power-over-Ethernet according IEEE802.3at for type 1 and IEEE802.3af	Yes	Yes
• Power-over-Ethernet according to IEEE802.3at for type 2	Yes	Yes
Standard for wireless communication		
• IEEE 802.11a	Yes	Yes
• IEEE 802.11b	Yes	Yes
• IEEE 802.11g	Yes	Yes
• IEEE 802.11h	Yes	Yes
• IEEE 802.11n	Yes	Yes
Wireless approval	You will find the current list of countries at: <a href="http://www.siemens.com/wireless-approvals">www.siemens.com/wireless-approvals</a>	You will find the current list of countries at: <a href="http://www.siemens.com/wireless-approvals">www.siemens.com/wireless-approvals</a>
<b>Accessories</b>		
Accessories	24 V DC screw terminal included in scope of delivery	24 V DC screw terminal included in scope of delivery

## Industrial Wireless Communication

### IWLAN – Controller and Controller Access Points IEEE 802.11n

#### SCALANCE W786 RJ45 controller access points for outdoor use

Ordering data	Article No.	More information
<b>SCALANCE W786C Controller access points</b>		
IWLAN access points for operating with the SCALANCE WLC IWLAN Controller; with two built-in wireless interfaces; wireless networks IEEE 802.11a/b/g/h/n at 2.4/5 GHz up to 450 Mbit/s; WPA2/AES; Power over Ethernet (PoE), IP65 degree of protection (-40 °C to +60 °C); scope of delivery: Mounting hardware, 2-pin screw terminal for 24 V DC; manual on CD-ROM; German/English <ul style="list-style-type: none"> <li>• <b>SCALANCE W786C-2IA RJ45</b> with six internal antennas</li> <li>• <b>SCALANCE W786C-2 RJ45</b> with R-SMA female connections for six external antennas</li> </ul>	<ul style="list-style-type: none"> <li><b>6GK5786-2HC00-1AA0</b></li> <li><b>6GK5786-2FC00-1AA0</b></li> </ul>	<b>Selection tools:</b> To assist in selecting Industrial Ethernet components, the TIA Selection Tool is available at: <a href="http://www.siemens.com/tia-selection-tool">http://www.siemens.com/tia-selection-tool</a>  <b>Wireless approvals:</b> Current approvals can be found on the Internet at: <a href="http://www.siemens.com/wireless-approvals">http://www.siemens.com/wireless-approvals</a>
<b>Accessories</b>		
<b>Power supply PS791-2DC</b> 12 to 24 V DC power supply for installation in SCALANCE W786C-2 products; operating instructions in German/English	<b>6GK5791-2DC00-0AA0</b>	
<b>Power supply PS791-2AC</b> 110 to 230 V DC power supply for installation in SCALANCE W786C-2 products; operating instructions in German/English	<b>6GK5791-2AC00-0AA0</b>	
<b>MS1 mounting set</b> Mounting set for fixing the SCALANCE W786C-2 products onto an S7-300 mounting rail or a 35 mm standard mounting rail	<b>6GK5798-8MG00-0AA0</b>	
<b>IE FC RJ-45 Plug 4 x 2</b> RJ45 plug connector for Industrial Ethernet (10/100/1 000 Mbit/s) with a rugged metal enclosure and integrated insulation displacement contacts for connecting Industrial Ethernet FC installation cables; 180° cable outlet; for network components and CPs/CPU's with Industrial Ethernet interface <ul style="list-style-type: none"> <li>• 1 pack = 1 unit</li> <li>• 1 pack = 10 units</li> <li>• 1 pack = 50 units</li> </ul>	<ul style="list-style-type: none"> <li><b>6GK1901-1BB11-2AA0</b></li> <li><b>6GK1901-1BB11-2AB0</b></li> <li><b>6GK1901-1BB11-2AE0</b></li> </ul>	
<b>IE FC Standard Cable GP 4 x 2</b> 8-core, shielded TP installation cable for connection to IE FC RJ45 Plug 4 x 2 and IE M12 Plug PRO 4 x 2; PROFINET-compatible; with UL approval; sold by the meter; max. length 1 000 m, minimum order quantity 20 m	<b>6XV1878-2A</b>	
<b>IE FC Stripping Tool</b> Preadjusted stripping tool for fast stripping of the Industrial Ethernet FC cables	<b>6GK1901-1GA00</b>	
<b>Antennas and miscellaneous IWLAN accessories</b>	See Industrial Wireless LAN/ accessories	

## Industrial Wireless Communication

### IWLAN – Controller and Controller Access Points IEEE 802.11n

#### SCALANCE W786C SFP controller access points for outdoor use

##### Overview



- SCALANCE W786C-2 SFP controller-based access points can only be operated on the SCALANCE WLC711 IWLAN Controller
- Particularly well-suited to applications with demanding climatic requirements when installed outdoors and in areas accessible to the public

##### Design

- Rugged, impact-resistant plastic enclosure, shock and vibration-proof for demanding mechanical requirements
- Two slots for SFP plug-in transceivers (optical 2-port switch)
- High IP65 degree of protection against dust and water jets
- For use at ambient temperatures from -40 °C to +60 °C (depending on the SFP plug-in transceiver used)
- Resistant to condensation
- Resistant to UV radiation and saltwater spray
- Design for use outdoors
- 6 x R-SMA sockets for the connection of remote antennas
- 1 x 24 V DC connector, optional operation with 12 to 24 V DC or 100 to 240 V AC with power supply that can be integrated in the device
- Function LEDs for optical signaling of faults/errors and operating statuses
- Mounting: Wall or, with optional mounting set, on S7 mounting rail, 35 mm standard mounting rail, or on a pole

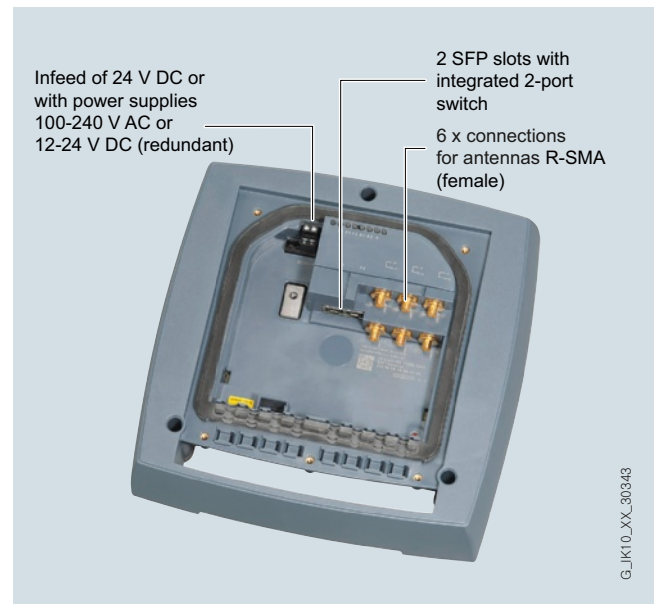

Design and interfaces of the SCALANCE W786C-2 controller-based access points

##### Product versions

###### SCALANCE W786C-2 SFP (controller-based)

- Two wireless cards permanently installed in the device; six connections for external antennas

## Industrial Wireless Communication

### IWLAN – Controller and Controller Access Points IEEE 802.11n

#### SCALANCE W786C SFP controller access points for outdoor use

#### Technical specifications

Article No.	6GK5786-2FE00-1AA0	Article No.	6GK5786-2FE00-1AA0
Product-type designation	SCALANCE W786C-2 SFP	Product-type designation	SCALANCE W786C-2 SFP
<b>Transmission rate</b>		<b>Supply voltage, current consumption, power loss</b>	
Transfer rate		Type of supply voltage	DC
• with W-LAN maximum	450 Mbit/s	Supply voltage	
• with Industrial Ethernet	1 000 Mbit/s	• 1 from terminal block	19.2 V
• note	-	• 2 from terminal block	28.8 V
<b>Interfaces</b>		• from Power-over-Ethernet according IEEE802.3at for type 1 and IEEE802.3af	-
Number of electrical connections		• from Power-over-Ethernet according IEEE802.3at for type 2	-
• for network components and terminal equipment	-	• from optional integratable power supply	
• for power supply	1	- with AC	100 ... 240 V
• for redundant power supply	0	- with DC	12 ... 24 V
Design of the electrical connection		Current consumed	
• for network components and terminal equipment	-	• at 24 V with DC typical	-
• for power supply	2-pole connector (24 V DC) or optionally available power supply adapter (4-pole 24 V DC or 3-pole 110 to 230 V AC)	• at 230 V with AC typical	-
Number of optical interfaces for optical waveguide at 100 Mbit/s	2	• with Power-over-Ethernet according to IEEE802.3at for type 1 and IEEE802.3af typical	-
Design of optical interface for optical waveguide at 100 Mbit/s	SFP slot	• with Power-over-Ethernet according to IEEE802.3at for type 2 typical	-
Number of optical interfaces for optical waveguide at 1000 Mbit/s	2	Effective power loss	
Design of optical interface for optical waveguide at 1000 Mbit/s	SFP slot	• at 24V for DC typical	-
Design of the removable storage C-PLUG	No	• at 230 V with AC typical	-
<b>Interfaces wireless</b>		• with Power-over-Ethernet according to IEEE802.3at for type 1 and IEEE802.3af typical	-
Number of radio cards permanently installed	2	• with Power-over-Ethernet according to IEEE802.3at for type 2 typical	-
Number of internal antennas	-		
Number of electrical connections for external antenna(s)	6		
Design of the electrical connection for external antenna(s)	R-SMA (socket)		
Product property external antenna can be mounted directly on device	No		

## Industrial Wireless Communication

### IWLAN – Controller and Controller Access Points IEEE 802.11n

#### SCALANCE W786C SFP controller access points for outdoor use

##### Technical specifications (continued)

Article No.	6GK5786-2FE00-1AA0	Article No.	6GK5786-2FE00-1AA0
Product-type designation	SCALANCE W786C-2 SFP	Product-type designation	SCALANCE W786C-2 SFP
<b>Permitted ambient conditions</b>		<b>Standards, specifications, approvals</b>	
Ambient temperature		Standard	
• during operating	-40 ... +60 °C	• for EMC from FM	FM 3611: Class I, Division 2, Groups A,B,C,D, T4 / Class 1, Zone 2, Group IIC, T4
• during storage	-40 ... +85 °C	• for hazardous zone	EN 60079-15:2005, EN 60079-0:2006, II 3 G Ex nA II T4 KEMA 07 ATEX 0145X
• during transport	-40 ... +85 °C	• for safety of CSA and UL	UL 60950-1 CSA C22.2 No. 60950-1
Relative humidity at 25 °C without condensation during operating maximum	100 %	Verification of suitability	
Protection class IP	IP65	• CE mark	Yes
Ambient condition for (standard) operation mode	When using the power supply 100 to 240 V AC, an operating temperature of -40 °C to +60 °C is permissible	• EC declaration of conformity	Yes
<b>Design, dimensions and weight</b>		• C-Tick	Yes
Width of enclosure without antenna	251 mm	• CCC	No
Height of enclosure without antenna	251 mm	• Railway application in accordance with EN 50155	No
Depth of enclosure without antenna	72 mm	• e1 approval	No
Net weight	2.24 kg	• E1 approval	No
Mounting type wall mounting	Yes	• NEMA4X	Yes
Mounting type	For mast mounting, 35 mm DIN rail mounting and S7-300 rail mounting, an additional support plate is required	• Power-over-Ethernet according to IEEE802.3at for type 1 and IEEE802.3af	No
<b>Wireless frequencies</b>		• Power-over-Ethernet according to IEEE802.3at for type 2	No
Radio frequency		Standard for wireless communication	
• for WLAN in 2.4 GHz frequency band	2.41 ... 2.48 GHz	• IEEE 802.11a	Yes
• for WLAN in 5 GHz frequency band	4.9 ... 5.8 GHz	• IEEE 802.11b	Yes
<b>Product properties, functions, components general</b>		• IEEE 802.11g	Yes
Product function		• IEEE 802.11h	Yes
• Access Point Mode	Yes	• IEEE 802.11n	Yes
• Client Mode	No	Wireless approval	You will find the current list of countries at: <a href="http://www.siemens.com/wireless-approvals">www.siemens.com/wireless-approvals</a>
Number of SSIDs	16	<b>Accessories</b>	
<b>Product functions management, configuration</b>		Accessories	24 V DC screw terminal included in scope of delivery
Product function			
• operation with IWLAN controller	Yes		
• operation with Enterasys WLAN controller	Yes		

## Industrial Wireless Communication

### IWLAN – Controller and Controller Access Points IEEE 802.11n

#### SCALANCE W786C SFP controller access points for outdoor use

Ordering data	Article No.	More information
<b>SCALANCE W786C-2 SFP controller access points</b>		
IWLAN access points for operating with the SCALANCE WLC IWLAN Controller; with two built-in wireless interfaces and one integral 2-port switch (SFP slots); wireless networks IEEE 802.11a/b/g/h/n at 2.4/5 GHz up to 450 Mbit/s; WPA2/AES; IP65 degree of protection (-40 °C to +60 °C); scope of delivery: Mounting hardware, 2-pin screw terminal for 24 V DC; manual on CD-ROM; German/English <b>• SCALANCE W786C-2 SFP with six internal antennas</b>	<b>6GK5786-2FE00-1AA0</b>	<b>Selection tools:</b> To assist in selecting Industrial Ethernet components, the TIA Selection Tool is available at: <a href="http://www.siemens.com/tia-selection-tool">http://www.siemens.com/tia-selection-tool</a>  <b>Wireless approvals:</b> Current approvals can be found on the Internet at: <a href="http://www.siemens.com/wireless-approvals">http://www.siemens.com/wireless-approvals</a>
<b>Accessories</b>		
<b>Power supply PS791-2DC</b> 12 to 24 V DC power supply for installation in SCALANCE W786C-2 products; operating instructions in German/English	<b>6GK5791-2DC00-0AA0</b>	
<b>Power supply PS791-2AC</b> 110 to 230 V DC power supply for installation in SCALANCE W786C-2 products; operating instructions in German/English	<b>6GK5791-2AC00-0AA0</b>	
<b>MS1 mounting set</b> Mounting set for fixing the SCALANCE W786C-2 products onto an S7-300 mounting rail or a 35 mm standard mounting rail	<b>6GK5798-8MG00-0AA0</b>	
<b>Antennas and miscellaneous IWLAN accessories</b>	See Industrial Wireless LAN/ accessories	
<b>SFP plug-in transceiver</b>		
<b>SFP992-1</b> Gigabit, multimode, 750 m	<b>6GK5992-1AL00-8AA0</b>	
<b>SFP992-1LD</b> Gigabit, singlemode, 10 km	<b>6GK5992-1AM00-8AA0</b>	
<b>SFP992-1LH</b> Gigabit, singlemode, 40 km	<b>6GK5992-1AN00-8AA0</b>	
<b>SFP992-1LH+</b> Gigabit, singlemode, 70 km	<b>6GK5992-1AP00-8AA0</b>	
<b>Fiber-optic cables</b>	See glass fiber-optic cables	

## Industrial Wireless Communication

### IWLAN – Client Modules IEEE 802.11n

#### Overview

#### Overview



The client modules from the SCALANCE W700 product lines are optimal for integrating Industrial Ethernet stations into Industrial Wireless LANs (IWLANS) for 2.4 GHz and 5 GHz.

- High data rates (up to 450 Mbit/s in connection with Channel Bonding) as per IEEE802.11n
- Reliable wireless link by using of MIMO technology (Multiple Input, Multiple Output). For this, SCALANCE W Client Modules use up to three streams for simultaneous sending and receiving.
- SCALANCE W700 Client Modules are suitable for any application: for installation indoors without a control cabinet and for installation in a control cabinet
- Reliable thanks to a rugged enclosure, protected from water and dust (up to IP65), resistant to shock, vibration and electro-magnetic fields
- Demanding applications with real-time and redundancy requirements, such as PROFINET with PROFINET with PROFINET
- Conformant to standards through supporting IEEE802.11; expanded software functions especially for use where increased reliability is required, e.g. cyclic real-time data traffic and very high-speed roaming (iPCF, iPCF-MC)
- Configuration support by means of wizards and online help; easy management via Web server and SNMP
- Configuration and diagnostics using Web based Management, Command Line Interface, and SNMP. Devices and networks can be configured using STEP 7 (TIA Portal). For cyclic monitoring, diagnostics and documentation (reporting) in network mode, the SINEMA Server software is recommended.
- Enabling of further functions using the KEY-PLUG swap medium (iPCF, iPCF-MC)
- Fast replacement of devices if a fault occurs thanks to use of optional KEY-PLUG/C-PLUG (Configuration Plug) swap medium

#### Benefits



- Predictable data traffic (deterministic response) and defined response times on the wireless link
- Reliable wireless link, e.g. by using MIMO technology and monitoring the wireless link
- Cost savings due to one single wireless network both for process-critical data and for non-critical communication
- Future-proof because all products are compatible with the internationally recognized WLAN standard IEEE 802.11, suitable for license-free 2.4 GHz and 5 GHz frequency bands (ISM bands)
- Implementation of data-intensive applications such as video streaming
- Reduced operating costs, because there is no wear and tear on rotating and moving plant sections
- Cost-effective connection to devices which are remote, difficult to access or installed in hostile environments
- Investment protection because flexible feature expansions (iFeatures) are possible by using the KEY-PLUG



### Application

The client modules of the SCALANCE W700 product line are designed for indoor and outdoor industrial applications as well as for low-cost integration in control cabinets or mobile machines. They provide a reliable wireless link with fast handover from one access point to the next (roaming). This allows processes to be monitored and loss of production due to machine downtimes to be avoided. Industrial Wireless LAN (IWLAN) can also be used in time-critical applications in factory automation (PROFINET IO) or for safety-related signals (PROFIsafe).

SCALANCE W products are silicone-free and can therefore also be used in paint shops. The client modules with high IP65 degree of protection and extended temperature range from -20 to +60 °C are especially suitable for industrial applications.

The client modules are especially suitable for use in automated guided vehicle systems or suspended monorails.

When using the RCoax cable (radiating cable), operation is particularly reliable in conveyor systems and all track applications (e.g. storage and retrieval systems, suspended monorail).

#### Application examples:

- Automated guided vehicle systems and suspended monorails; prevents wear and offers high flexibility for traffic routing thanks to the wireless transfer of data to the vehicles. It is also possible to transfer PROFIsafe via IWLAN.
- Cranes; high flexibility due to access to data communication with the moving unit independent of the location
- Tunnel application; reliable wireless link since the devices can handle multiple path propagation better by using the MIMO technology
- Communication with moving stations (e.g. mobile controls and devices), container logistics, storage and retrieval machines, conveyor systems, conveyor belts, rotating machines, trucks
- Wireless coupling of communication segments and bridging of large distances for fast commissioning and cost-effective networks in applications where cable routing would be extremely expensive (e.g. on public roads, rivers, lakes, train lines)

### Function

SCALANCE W700 client modules make it possible for a node with an Industrial Ethernet interface (e.g. a controller) to move seamlessly and with no wear and tear in an Industrial Wireless LAN RF field. The node logs on in the RF field via the client module and can exchange information with the entire data network. If the client module moves, for example, on an automated guided vehicle system, it is automatically and transparently handed over from one access point to the next (roaming).

This is possible over distances of up to 30 m indoors (approx. 100 m outdoors). Additional directional antennas can be used outdoors to achieve ranges of several thousand meters.

Apart from a reliable wireless link, a major feature of the SCALANCE W700 client modules is their support of IT mechanisms:

- IEEE 802.11a/b/g/n for different frequency ranges
- IEEE802.11e for wireless multimedia (WMM)
- IEEE802.11i for security
- Sending the log entries of the SCALANCE W devices to a Syslog server
- Modern security mechanisms (e.g. network security such as IEEE 802.1x, RADIUS, EAP mechanisms)

#### Security

A high degree of data security is achieved by means of the WPA2/IEEE 802.11i mechanisms. These define modern procedures that control a regular exchange of the complete 128-bit key as well as performing the access check (authentication) of a node. The Advanced Encryption Standard (AES) is available for data encryption.

On top of this, access to the devices (HTTPS) is encrypted and a secure logon (SSH) is possible. If a security concept in combination with SCALANCE S is required, the security requirements can be increased using Virtual Private Networks (VPN).

#### Functional scope

Depending on the product version, the SCALANCE W700 client modules can manage the wireless connection for up to eight connected devices with Ethernet interface. It is possible for mobile units with a small Ethernet network (up to eight devices) to be linked into an IWLAN RF field.

## Industrial Wireless Communication

### IWLAN – Client Modules IEEE 802.11n

#### Overview

#### Function (continued)

**iFeatures** (only in conjunction with KEY-PLUG or SCALANCE W722-1 RJ45))

#### iPCF (Industrial Point Coordination Function):

The iPCF mode is a good choice for applications with requirements for real-time and predictable response times (deterministic response), even when mobile nodes are roaming from one access point to the next. This ensures that wireless PROFINET IO is supported and that safety-related signals, e.g. emergency stop, can be linked into the RF field.

The iPCF mechanism expands the IEEE 802.11 standard and must be available on both the client module and the access point. In an RF field in which iPCF is used, no IEEE 802.11-compliant nodes can be operated.

iPCF is recommended for applications where wireless network nodes move along predefined paths (e.g. suspended monorail). RCoax radiating cables or directional antennas must be used for this purpose.

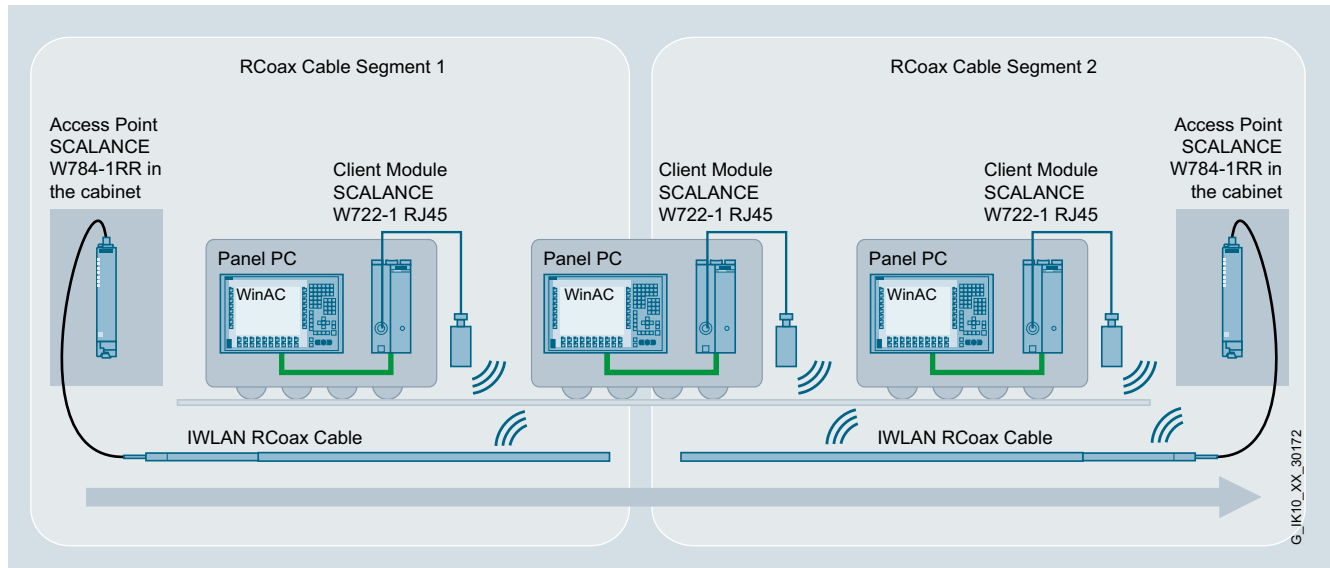

Linking in an automated guided vehicle system using iPCF with the SCALANCE W722-1 RJ45

#### iPCF-MC (iPCF Management Channel) <sup>1)</sup>:

iPCF-MC is available as a further development of iPCF. This mode should be used if IWLAN stations that also support iPCF-MC move freely about in the coverage area (especially when using omni-directional antennas) and are to exchange data deterministically. This functionality can only be achieved in connection with access points with two wireless interfaces and the KEY PLUG.

#### Note:

These iFeatures cannot be used in parallel.

<sup>1)</sup> Available soon

#### Diagnostics and management

- Web-based (HTTP/HTTPS) management tool for configuration and diagnostics using a standard browser
- LEDs for signaling operating status and fault/error states
- Signaling of faults by means of SNMP trap or e-mail to a network management tool
- Configuration and diagnostics using Web based Management, Command Line Interface, and SNMP. Devices and networks can be configured using STEP 7 (TIA Portal). For cyclic monitoring, diagnostics and documentation (reporting) in network mode, the SINEMA Server software is recommended.

## Industrial Wireless Communication IWLAN – Client Modules IEEE 802.11n

### SCALANCE W748 RJ45 for use in control cabinet

#### Overview



- Suitable for applications where the client module is to be mounted in the control cabinet

#### Design

- Rugged aluminum enclosure, shock and vibration-proof, for high mechanical requirements
- Dust protection with IP30 degree of protection
- For use at ambient temperatures from -20 °C to +60 °C
- 3 x R-SMA sockets for the connection of directly mountable and remote antennas (6 x R-SMA sockets for the variants with two wireless modules)
- Antenna placement optimized for the 3x3 MIMO technology; the antennas do not interfere with each other when they are mounted directly on the device
- 1 x RJ45 connector for 10/100/1 000 Mbit/s with Power-over-Ethernet according to IEEE 802.3at
- 2 x 24 V DC connection for redundant energy supply
- 1 x PLUG compartment for KEY-PLUG/C-PLUG
- Function LEDs for optical signaling of faults/errors and operating statuses
- Digital input for feeding in a signal from a sensor, for example, to an SNMP-based network management system
- Digital output for converting a command received over SNMP into a signal and switching a hardware function
- Mounting: Wall, S7-1500 mounting rail, S7-300 mounting rail, or on 35 mm standard mounting rail

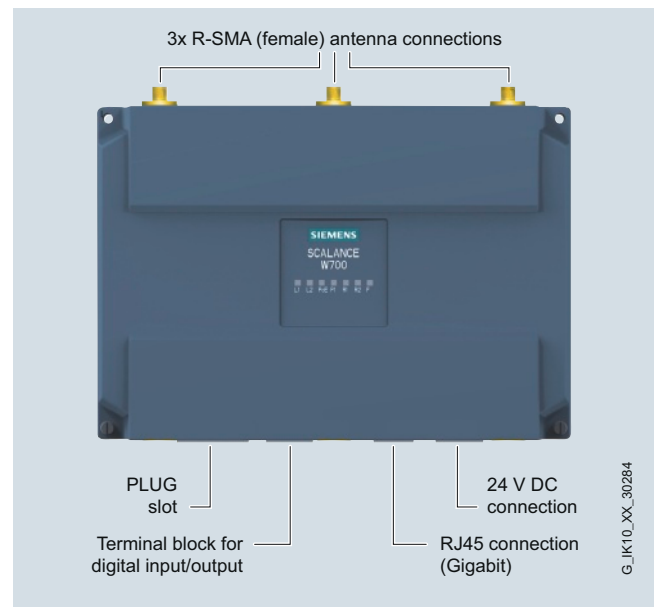

Design and interfaces of the SCALANCE W748-1 RJ45 client modules

#### Product versions

##### SCALANCE W748-1 RJ45

- A radio card is permanently installed; functional scope can be expanded by using a KEY-PLUG W780 iFeatures

## Industrial Wireless Communication

### IWLAN – Client Modules IEEE 802.11n

#### SCALANCE W748 RJ45 for use in control cabinet

#### Function

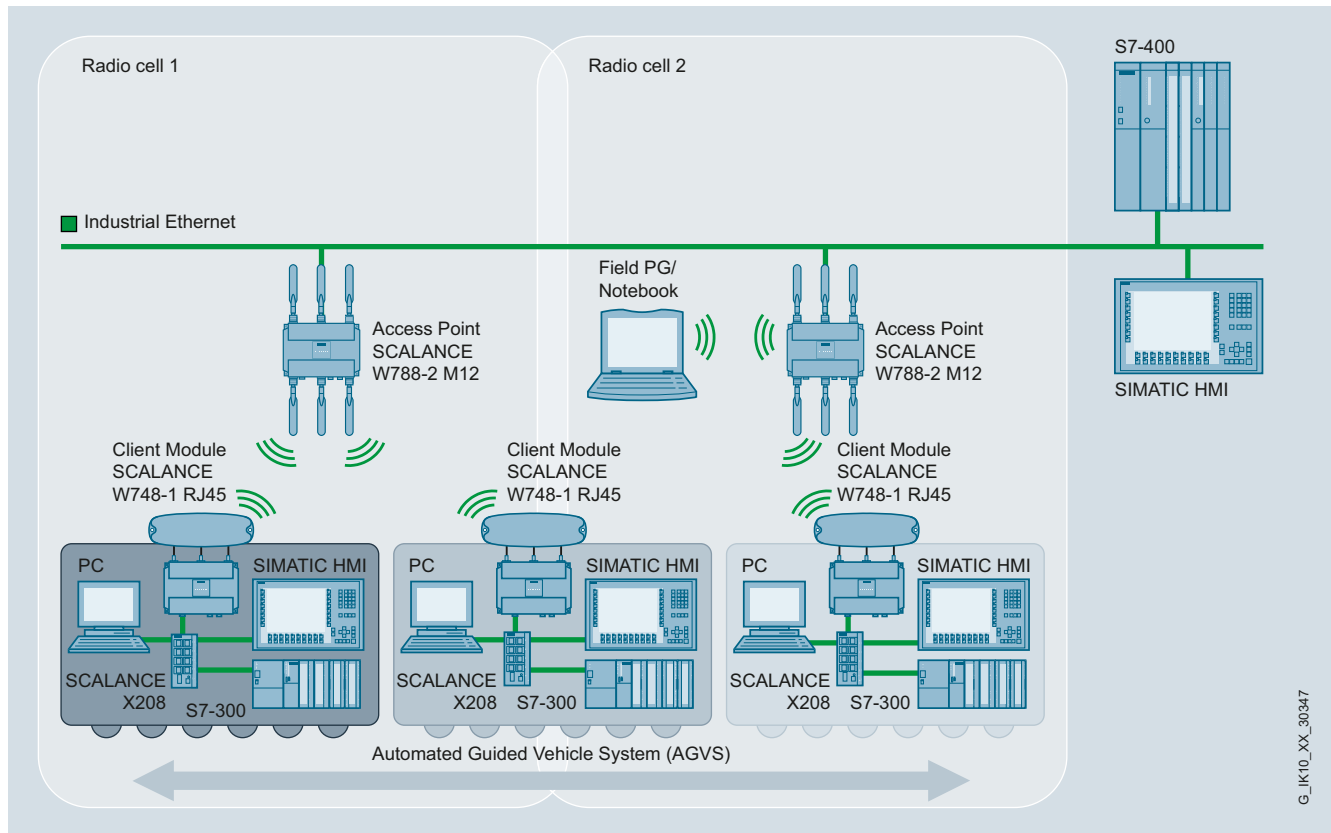

Mobile controls in an automated guided vehicle system

The controllers log on via the Ethernet client modules W748-1 RJ45 in the RF field and can move around freely there. This, for example, makes it possible to operate an automated guided vehicle system.

### Technical specifications

Article No.	6GK5748-1FC00-0AA0 6GK5748-1FC00-0AB0 <sup>1)</sup>
Product-type designation	SCALANCE W748-1 RJ45
<b>Transmission rate</b>	
Transmission rate	
• with W-LAN maximum	450 Mbit/s
• with Industrial Ethernet	10 ... 1 000 Mbit/s
• note	-
<b>Interfaces</b>	
Number of electrical connections	
• for network components	1
• and terminal equipment	
• for power supply	1
• for redundant power supply	1
Design of electrical connection	
• for network components and terminal equipment	RJ45 socket
• for power supply	4-pole screw terminal, PoE
Design of the removable storage C-PLUG	Yes
<b>Interfaces wireless</b>	
Number of radio cards permanently installed	1
Number of internal antennas	-
Number of electrical connections for external antenna(s)	3
Design of the electrical connection for external antenna(s)	R-SMA (socket)
Product property external antenna can be mounted directly on device	Yes
<b>Signal-Inputs/outputs</b>	
Number of digital inputs	1
Number of digital outputs	1
Design of electrical connection at the digital inputs/outputs	4-pole screw terminal
Signal range	
• at digital input	24 V DC, safety extra-low voltage
• at the digital output	24 V DC / 1 A
<b>Supply voltage, current consumption, power loss</b>	
Type of supply voltage	DC
Supply voltage	
• 1 from terminal block	19.2 V
• 2 from terminal block	28.8 V
• from Power-over-Ethernet according IEEE802.3at for type 1 and IEEE802.3af	48 V
• from Power-over-Ethernet according IEEE802.3at for type 2	50 V
Current consumed	
• at 24 V with DC typical	0.45 A
• with Power-over-Ethernet according to IEEE802.3at for type 1 and IEEE802.3af typical	0.22 A
• with Power-over-Ethernet according to IEEE802.3at for type 2 typical	0.21 A

<sup>1)</sup> Wireless approval in the USA

Article No.	6GK5748-1FC00-0AA0 6GK5748-1FC00-0AB0 <sup>1)</sup>
Product-type designation	SCALANCE W748-1 RJ45
Effective power loss	
• at 24V for DC typical	10.7 W
• with Power-over-Ethernet according to IEEE802.3at for type 1 and IEEE802.3af typical	10.7 W
• with Power-over-Ethernet according to IEEE802.3at for type 2 typical	10.7 W
<b>Permitted ambient conditions</b>	
Ambient temperature	
• during operating	-20 ... +60 °C
• during storage	-40 ... +70 °C
• during transport	-40 ... +70 °C
Relative humidity at 25 °C without condensation during operating maximum	90 %
Protection class IP	IP30
Ambient condition for (standard) operation mode	When used under hazardous conditions (Zone 2), the product must be installed in an enclosure. To comply with EN 50021, this enclosure must meet the requirements of at least IP54 in compliance with EN 60529.
<b>Design, dimensions and weight</b>	
Width of enclosure without antenna	200 mm
Height of enclosure without antenna	158 mm
Depth of enclosure without antenna	79 mm
Net weight	1.7 kg
Mounting type wall mounting	Yes
Mounting type	S7-300 rail mounting
<b>Wireless frequencies</b>	
Radio frequency	
• for WLAN in 2.4 GHz frequency band	2.41 ... 2.48 GHz
• for WLAN in 5 GHz frequency band	4.9 ... 5.8 GHz
<b>Product properties, functions, components general</b>	
Product function	
• Access Point Mode	No
• Client Mode	Yes
Number of SSIDs	-
Product function	
• iPCF Access Point	-
• iPCF client	Yes
• iPCF-MC Access Point	-
• iPCF-MC client	in preparation
Number of iPCF-capable radio modules	1

## Industrial Wireless Communication

### IWLAN – Client Modules IEEE 802.11n

#### SCALANCE W748 RJ45 for use in control cabinet

#### Technical specifications (continued)

Article No.	6GK5748-1FC00-0AA0 6GK5748-1FC00-0AB0 <sup>1)</sup>	Article No.	6GK5748-1FC00-0AA0 6GK5748-1FC00-0AB0 <sup>1)</sup>
<b>Product-type designation</b>	<b>SCALANCE W748-1 RJ45</b>	<b>Product-type designation</b>	<b>SCALANCE W748-1 RJ45</b>
<b>Product functions management, configuration</b>		<b>Product functions Security</b>	
Number of manageable IP addresses in client	8	Product function	
Product function		• ACL - MAC-based	-
• CLI	Yes	• Management security, ACL-IP based	Yes
• web-based management	Yes	• IEEE 802.1x (radius)	Yes
• MIB support	Yes	• NAT/NAPT	No
• TRAPs via email	Yes	• access protection according to IEEE802.11i	Yes
• Configuration with STEP 7	in preparation	• WPA/WPA2	Yes
• configuration with STEP 7 in the TIA Portal	in preparation	• TKIP/AES	Yes
• operation with IWLAN controller	-	Protocol is supported SSH	Yes
• operation with Enterasys WLAN controller	-	<b>Product functions Time</b>	
• forced roaming with IWLAN	No	Protocol is supported	
• WDS	No	• SNMP	Yes
Protocol is supported		• SIMATIC Time	Yes
• Address Resolution Protocol (ARP)	Yes	<b>Standards, specifications, approvals</b>	
• ICMP	Yes	Standard	
• Telnet	Yes	• for hazardous zone	EN 60079-15:2005, EN 60079-0:2006, II 3 G Ex nA II T4 KEMA 07 ATEX 0145X
• HTTP	Yes	• for safety of CSA and UL	UL 60950-1 CSA C22.2 No. 60950-1
• HTTPS	Yes	Verification of suitability	
• TFTP	Yes	• CE mark	Yes
• SNMP v1	Yes	• EC declaration of conformity	Yes
• SNMP v2	Yes	• C-Tick	Yes
• SNMP v3	Yes	• CCC	No
• DCP	Yes	• Railway application in accordance with EN 50155	No
• LLDP	Yes	• e1 approval	No
Identification & maintenance function		• E1 approval	No
• I&M0 - device-specific information	Yes	• NEMA4X	No
• I&M1 – higher level designation/location designation	Yes	• Power-over-Ethernet according to IEEE802.3at for type 1 and IEEE802.3af	Yes
<b>Product functions Diagnosis</b>		• Power-over-Ethernet according to IEEE802.3at for type 2	Yes
Product function		Standard for wireless communication	
• PROFINET IO diagnosis	in preparation	• IEEE 802.11a	Yes
• localization via Aeroscout	-	• IEEE 802.11b	Yes
• SysLog	Yes	• IEEE 802.11e	Yes
<b>Product functions VLAN</b>		• IEEE 802.11g	Yes
Product function function VLAN with IWLAN	No	• IEEE 802.11h	Yes
<b>Product functions DHCP</b>		• IEEE 802.11i	Yes
Product function		• IEEE 802.11n	Yes
• DHCP client	Yes	Wireless approval	You will find the current list of countries at: <a href="http://www.siemens.com/wireless-approvals">www.siemens.com/wireless-approvals</a>
• in Client Mode DHCP server via LAN	No	<b>Accessories</b>	
<b>Product functions Redundancy</b>		Accessories	24 V DC screw terminal and screw terminal for digital input and output included in the scope of delivery
Protocol is supported STP/RSTP	-		

<sup>1)</sup> Wireless approval in the USA

## Industrial Wireless Communication

### IWLAN – Client Modules IEEE 802.11n

#### SCALANCE W748 RJ45 for use in control cabinet

Ordering data	Article No.	Article No.
<b>SCALANCE W748 client modules</b>		<b>Accessories</b>
IWLAN Ethernet client modules with built-in wireless interface; wireless networks IEEE 802.11a/b/g/h/n at 2.4/5 GHz up to 450 Mbps; WPA2/AES; Power over Ethernet (PoE), IP30 degree of protection (-20 °C to +60 °C); scope of supply: Mounting hardware, 4-pin screw terminal for 24 V DC; 4-pin screw terminal for digital input and output; manual on CD-ROM; German/English		<b>KEY-PLUG W740 iFeatures</b> 6GK5907-4PA00 Swap medium for enabling additional iFeatures, for simple device replacement if a fault occurs and for storage of configuration data; Can be used in SCALANCE W client modules with PLUG compartment
<b>SCALANCE W748-1 RJ45</b>		<b>C-PLUG</b> 6GK1900-0AB00 Swap medium for simple replacement of devices if a fault occurs; for storing configuration data; can be used in SIMATIC NET products with PLUG compartment
For managing the wireless connection of up to eight linked devices with Industrial Ethernet connection; degree of protection IP30		<b>DIN rail mounting adapter</b> 6GK5798-8ML00-0AB3 DIN rail mounting adapter for SCALANCE W788 M12 and SCALANCE W788 RJ45; screw fixing for mounting on a 35 mm DIN rail to EN 50 022; scope of supply: 3 units per pack
<ul style="list-style-type: none"> <li>National approvals for operation outside the USA</li> <li>National approvals for operation within the USA<sup>1)</sup></li> </ul>	6GK5748-1FC00-0AA0 6GK5748-1FC00-0AB0	<b>IE FC RJ45 Plug 4 x 2</b> RJ45 plug-in connector for Industrial Ethernet (10/100/1 000 Mbps) with a rugged metal enclosure and integrated insulation displacement contacts for connecting Industrial Ethernet FC installation cables; 180° cable outlet; for network components and CPs/CPUs with Industrial Ethernet interface <ul style="list-style-type: none"> <li>1 pack = 1 unit</li> <li>1 pack = 10 units</li> <li>1 pack = 50 units</li> </ul> 6GK1901-1BB11-2AA0 6GK1901-1BB11-2AB0 6GK1901-1BB11-2AE0
		<b>IE FC Standard Cable GP 4 x 2</b> 6XV1878-2A 8-core, shielded TP installation cable for connection to IE FC RJ45 Plug 4 x 2 and IE M12 Plug PRO 4 x 2; PROFINET-compliant; with UL approval; sold by the meter; max. length 1 000 m, minimum order quantity 20 m
		<b>IE FC Stripping Tool</b> 6GK1901-1GA00 Preadjusted stripping tool for fast stripping of Industrial Ethernet FC cables
		<b>Antennas and miscellaneous IWLAN accessories</b> See Industrial Wireless LAN/ accessories

<sup>1)</sup> Please note national approvals under <http://www.siemens.com/wireless-approvals>

#### More information

##### Selection tools:

To assist in selecting Industrial Ethernet components, the TIA Selection Tool is available at:  
<http://www.siemens.com/tia-selection-tool>

##### Wireless approvals:

Current approvals can be found on the Internet at:  
<http://www.siemens.com/wireless-approvals>

## Industrial Wireless Communication

### IWLAN – Client Modules IEEE 802.11n

#### SCALANCE W748 M12 for indoor use

##### Overview



- Particularly suitable for industrial applications without control cabinets

##### Design

- Rugged aluminum enclosure, shock and vibration-proof, for high mechanical requirements
- High IP65 degree of protection against dust and water jets
- For use at ambient temperatures from -20 °C to +60 °C
- 3 x N-Connect sockets for the connection of directly mountable and remote antennas (6 x N-Connect sockets for the variants with two wireless modules)
- Antenna placement optimized for the 3x3 MIMO technology; the antennas do not interfere with each other when they are mounted directly on the device
- 1 x M12 connection for 10/100/1 000 Mbit/s with Power-over-Ethernet according to IEEE 802.3at
- 1 x M12 socket for power supply (24 V DC)
- 1 x PLUG slot (for KEY-PLUG/C-PLUG)
- Function LEDs for optical signaling of faults/errors and operating statuses
- Mounting: Wall, S7-1500 mounting rail, S7-300 mounting rail, or on 35 mm standard mounting rail

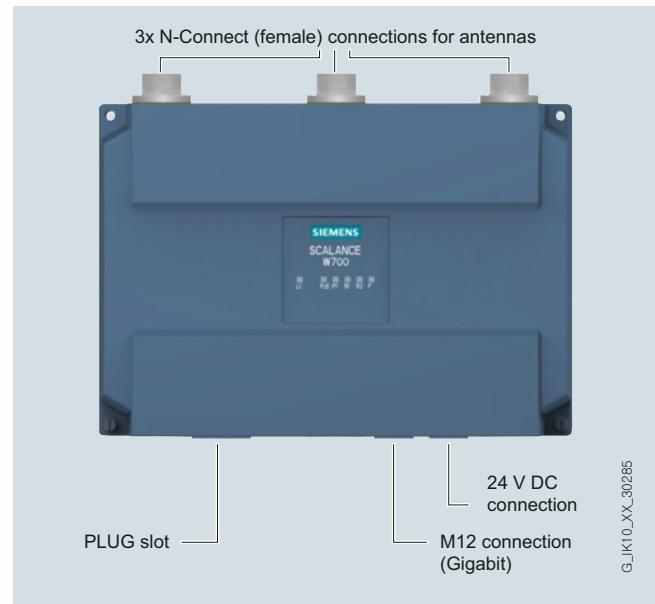

Design and interfaces of the SCALANCE W748-1 M12 client modules

##### Product versions

###### SCALANCE W748-1 M12

- A radio card is permanently installed; functional scope can be expanded by using a KEY-PLUG W780 iFeatures



**Function**

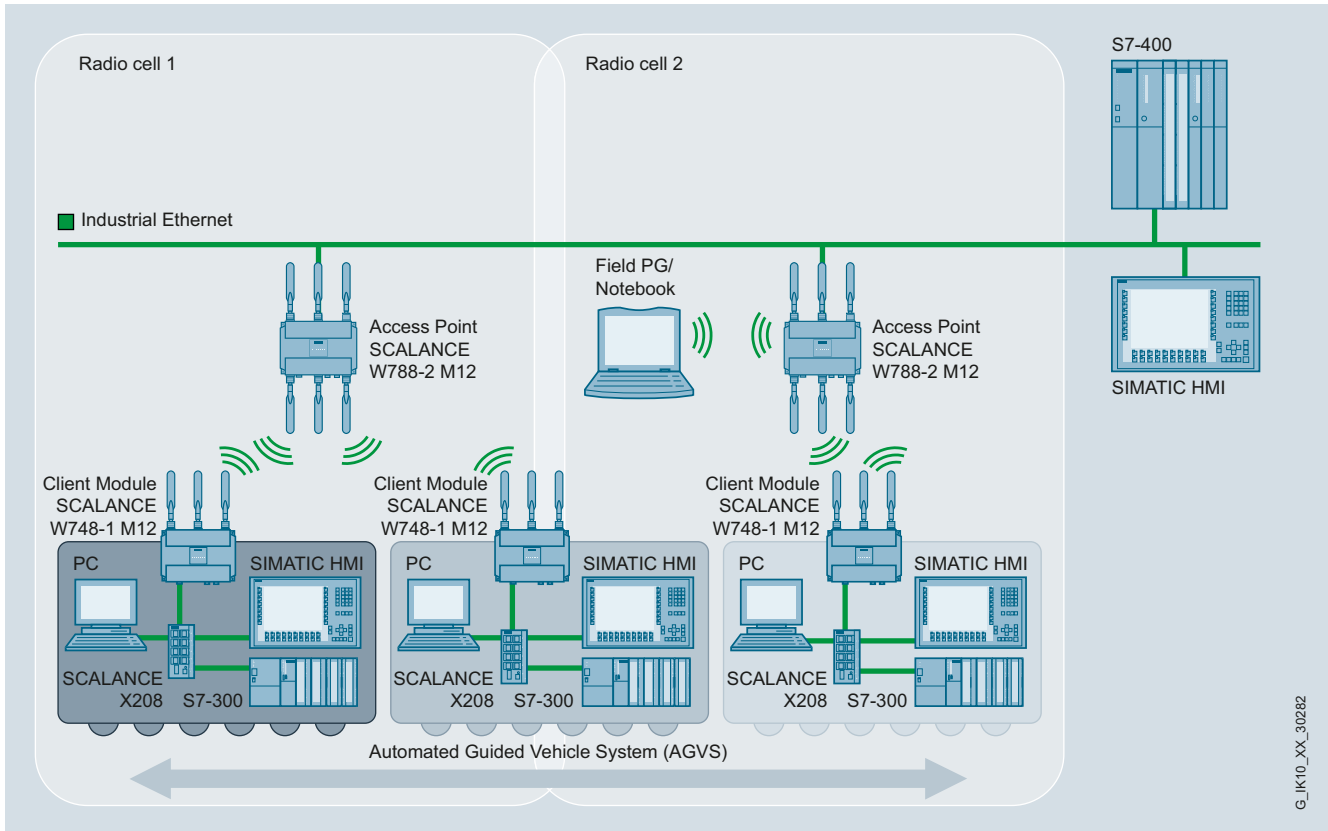

G\_IK10\_XX\_30282

Mobile controls in an automated guided vehicle system

The controllers log on in the RF field via the Ethernet client modules W748-1 M12, which are mounted directly on the vehicle, and can move around freely within this field. This, for example, makes it possible to operate an automated guided vehicle system.

# Industrial Wireless Communication

## IWLAN – Client Modules IEEE 802.11n

### SCALANCE W748 M12 for indoor use

#### Technical specifications

Article No.	6GK5748-1GD00-0AA0 6GK5748-1GD00-0AB0 <sup>1)</sup>
Product-type designation	SCALANCE W748-1 M12
<b>Transmission rate</b>	
Transmission rate	450 Mbit/s
• with W-LAN maximum	10 ... 1 000 Mbit/s
• with Industrial Ethernet	-
• note	-
<b>Interfaces</b>	
Number of electrical connections	1
• for network components and terminal equipment	1
• for power supply	1
• for redundant power supply	1
Design of electrical connection	M12 interface (8-pole, A-coded), PoE
• for network components and terminal equipment	M12 interface (4-pole, A-coded), PoE
• for power supply	M12 interface (4-pole, A-coded), PoE
Number of optical interfaces for optical waveguide at 100 Mbit/s	-
Design of optical interface for optical waveguide at 100 Mbit/s	-
Design of the removable storage C-PLUG	Yes
<b>Interfaces wireless</b>	
Number of radio cards permanently installed	1
Number of internal antennas	-
Number of electrical connections for external antenna(s)	3
Design of the electrical connection for external antenna(s)	N-Connect (socket)
Product property external antenna can be mounted directly on device	Yes
<b>Supply voltage, current consumption, power loss</b>	
Type of supply voltage	DC
Supply voltage	19.2 V
• 1 from M12 Power Connector (A-coded) for redundant power supply	28.8 V
• 2 from M12 Power Connector (A-coded) for redundant power supply	48 V
• from Power-over-Ethernet according IEEE802.3at for type 1 and IEEE802.3af	50 V
• from Power-over-Ethernet according IEEE802.3at for type 2	50 V
Current consumed	0.45 A
• at 24 V with DC typical	0.22 A
• with Power-over-Ethernet according to IEEE802.3at for type 1 and IEEE802.3af typical	0.21 A
• with Power-over-Ethernet according to IEEE802.3at for type 2 typical	0.21 A
Active power loss	10.7 W
• at 24V for DC typical	10.7 W
• with Power-over-Ethernet according to IEEE802.3at for type 1 and IEEE802.3af typical	10.7 W
• with Power-over-Ethernet according to IEEE802.3at for type 2 typical	10.7 W

Article No.	6GK5748-1GD00-0AA0 6GK5748-1GD00-0AB0 <sup>1)</sup>
Product-type designation	SCALANCE W748-1 M12
<b>Permitted ambient conditions</b>	
Ambient temperature	-20 ... +60 °C
• during operating	-40 ... +70 °C
• during storage	-40 ... +70 °C
• during transport	-40 ... +70 °C
Relative humidity at 25 °C without condensation during operating maximum	100 %
Protection class IP	IP65
Ambient condition for (standard) operation mode	When used under hazardous conditions (Zone 2), the product must be installed in an enclosure. To comply with EN 50021, this enclosure must meet the requirements of at least IP54 in compliance with EN 60529.
<b>Design, dimensions and weight</b>	
Width of enclosure without antenna	200 mm
Height of enclosure without antenna	176 mm
Depth of enclosure without antenna	79 mm
Net weight	1.7 kg
Mounting type wall mounting	Yes
Mounting type	S7-300 rail mounting
<b>Wireless frequencies</b>	
Radio frequency	2.41 ... 2.48 GHz
• for WLAN in 2.4 GHz frequency band	4.9 ... 5.8 GHz
• for WLAN in 5 GHz frequency band	4.9 ... 5.8 GHz
<b>Product properties, functions, components general</b>	
Product function	No
• Access Point Mode	Yes
• Client Mode	1
Number of SSIDs	1
Product function	-
• iPCF Access Point	Yes
• iPCF client	-
• iPCF-MC Access Point	in preparation
• iPCF-MC client	1
Number of iPCF-capable radio modules	1

<sup>1)</sup> Wireless approval in the USA

#### Technical specifications (continued)

Article No.	6GK5748-1GD00-0AA0 6GK5748-1GD00-0AB0 <sup>1)</sup>
Product-type designation	SCALANCE W748-1 M12
<b>Product functions management, configuration</b>	
Number of manageable IP addresses in client	8
Product function	
• CLI	Yes
• web-based management	Yes
• MIB support	Yes
• TRAPs via email	Yes
• Configuration with STEP 7	in preparation
• configuration with STEP 7 in the TIA Portal	in preparation
• operation with IWLAN controller	-
• operation with Enterasys WLAN controller	-
• forced roaming with IWLAN	No
• WDS	No
Protocol is supported	
• Address Resolution Protocol (ARP)	Yes
• ICMP	Yes
• Telnet	Yes
• HTTP	Yes
• HTTPS	Yes
• TFTP	Yes
• SNMP v1	Yes
• SNMP v2	Yes
• SNMP v3	Yes
• DCP	Yes
• LLDP	Yes
Identification & maintenance function	
• I&M0 - device-specific information	Yes
• I&M1 – higher level designation/ location designation	Yes
<b>Product functions Diagnosis</b>	
Product function	
• PROFINET IO diagnosis	in preparation
• localization via Aeroscout	-
• SysLog	Yes
<b>Product functions VLAN</b>	
Product function function VLAN with IWLAN	No
<b>Product functions DHCP</b>	
Product function	
• DHCP client	Yes
• in Client Mode DHCP server via LAN	No
<b>Product functions Redundancy</b>	
Protocol is supported STP/RSTP	-
<b>Product functions Security</b>	
Product function	
• ACL - MAC-based	-
• Management security, ACL-IP based	Yes
• IEEE 802.1x (radius)	Yes
• NAT/NAPT	No
• access protection according to IEEE802.11i	Yes
• WPA/WPA2	Yes
• TKIP/AES	Yes
Protocol is supported SSH	Yes

<sup>1)</sup> Wireless approval in the USA

Article No.	6GK5748-1GD00-0AA0 6GK5748-1GD00-0AB0 <sup>1)</sup>
Product-type designation	SCALANCE W748-1 M12
<b>Product functions Time</b>	
Protocol is supported	
• SNTP	Yes
• SIMATIC Time	Yes
<b>Standards, specifications, approvals</b>	
Standard	
• for hazardous zone	EN 60079-15:2005, EN 60079-0:2006, II 3 G Ex nA II T4 KEMA 07 ATEX 0145X
• for safety of CSA and UL	UL 60950-1 CSA C22.2 No. 60950-1
Verification of suitability	
• CE mark	Yes
• EC declaration of conformity	Yes
• C-Tick	Yes
• CCC	No
• Railway application in accordance with EN 50155	No
• e1 approval	No
• E1 approval	No
• NEMA4X	No
• Power-over-Ethernet according IEEE802.3at for type 1 and IEEE802.3af	Yes
• Power-over-Ethernet according to IEEE802.3at for type 2	Yes
Standard for wireless communication	
• IEEE 802.11a	Yes
• IEEE 802.11b	Yes
• IEEE 802.11e	Yes
• IEEE 802.11g	Yes
• IEEE 802.11h	Yes
• IEEE 802.11i	Yes
• IEEE 802.11n	Yes
Wireless approval	You will find the current list of countries at: <a href="http://www.siemens.com/wireless-approvals">www.siemens.com/wireless-approvals</a>
<b>Accessories</b>	
Accessories	-

# Industrial Wireless Communication

## IWLAN – Client Modules IEEE 802.11n

### SCALANCE W748 M12 for indoor use

Ordering data	Article No.	Article No.
<b>SCALANCE W748 client modules</b>		<b>Accessories</b>
IWLAN Ethernet client modules with built-in wireless interface; wireless networks IEEE 802.11a/b/g/h/n at 2.4/5 GHz up to 450 Mbps; WPA2/AES; Power over Ethernet (PoE), IP65 degree of protection (-20 °C to +60 °C); scope of supply: Mounting hardware; manual on CD-ROM, German/English		<b>KEY-PLUG W740 iFeatures</b> 6GK5907-4PA00 Swap medium for enabling additional iFeatures, for simple device replacement if a fault occurs and for storage of configuration data; Can be used in SCALANCE W client modules with PLUG compartment
<b>SCALANCE W748-1 M12</b>		<b>C-PLUG</b> 6GK1900-0AB00 Swap medium for simple replacement of devices in the event of a fault; for storing configuration data; can be used in SIMATIC NET products with PLUG compartment
For managing the wireless connection of up to eight linked devices with Industrial Ethernet connection		<b>DIN rail mounting adapter</b> 6GK5798-8ML00-0AB3 DIN rail mounting adapter for SCALANCE W788 M12 and SCALANCE W788 RJ45; screw fixing for mounting on a 35 mm DIN rail to EN 50 022; scope of supply: 3 units per pack
<ul style="list-style-type: none"> <li>National approvals for operation outside the USA</li> <li>National approvals for operation within the USA <sup>1)</sup></li> </ul>	6GK5748-1GD00-0AA0 6GK5748-1GD00-0AB0	<b>IE FC M12 Plug PRO 4 x 2</b> M12 plug-in connector suitable for on-site assembly (X-coded, IP65/IP67), metal enclosure, insulation displacement fast connection method, for SCALANCE W <ul style="list-style-type: none"> <li>1 unit</li> <li>8 units</li> </ul> 6GK1901-0DB30-6AA0 6GK1901-0DB30-6AA8
		<b>IE FC Standard Cable GP 4 x 2</b> 6XV1878-2A 8-core, shielded TP installation cable for connection to IE FC RJ45 Plug 4 x 2 and IE M12 Plug PRO 4 x 2; PROFINET-compliant; with UL approval; sold by the meter; max. length 1 000 m, minimum order quantity 20 m
		<b>IE FC Stripping Tool</b> 6GK1901-1GA00 Preadjusted stripping tool for fast stripping of the Industrial Ethernet FC cables
		<b>Power M12 Cable Connector PRO</b> 6GK1 907-0DC10-6AA3 Terminal socket for connection of SCALANCE W700 for 24 V DC supply voltage; 4-pole, A-coded, with assembly instructions, 3 units
		<b>Power Cable 2 x 0.75</b> 6XV1 812-8A Connecting cable for Power M12 Cable Connector PRO, sold by the meter
		<b>Antennas and miscellaneous IWLAN accessories</b> See Industrial Wireless LAN/ accessories

<sup>1)</sup> Please note national approvals under <http://www.siemens.com/wireless-approvals>

#### More information

##### Selection tools:

To assist in selecting Industrial Ethernet components, the TIA Selection Tool is available at:  
<http://www.siemens.com/tia-selection-tool>

##### Wireless approvals:

Current approvals can be found on the Internet at:  
<http://www.siemens.com/wireless-approvals>

## Industrial Wireless Communication IWLAN – Client Modules IEEE 802.11n

### SCALANCE W734 RJ45 for use in control cabinet

#### Overview

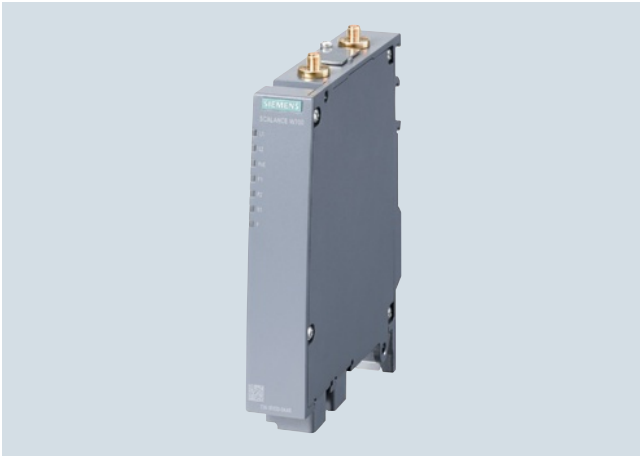

- Client modules in SIMATIC design suitable for applications where the device is to be mounted in the control cabinet



SIMATIC ET 200MP station with SCALANCE W734 RJ45

#### Design

- Low-profile, compact aluminum enclosure, shock and vibration-proof for high mechanical requirements
- Implementation of simple and cost-effective wireless machine networking
- Support of the 2.4 and 5 GHz frequency band
- IP30 degree of protection
- For use at ambient temperatures from -20 °C to +60 °C
- 2 x R-SMA sockets for the connection of direct mountable and remote antennas
- Antenna placement optimized for the 2x2 MIMO technology; the antennas do not interfere with each other when they are mounted directly on the device
- 2 x RJ45 connector for 10/100 Mbit/s, of which one connector has Power-over-Ethernet compliant with IEEE 802.3at
- 2 x 24 V DC connection for redundant energy supply
- 1 x PLUG compartment for KEY-PLUG/C-PLUG
- Function LEDs for optical signaling of faults/errors and operating statuses
- Mounting: Wall, S7-1500 mounting rail, S7-300 mounting rail, or on 35 mm standard mounting rail
- SIMATIC design matches existing components in the control cabinet (e.g. ET 200MP, etc.)

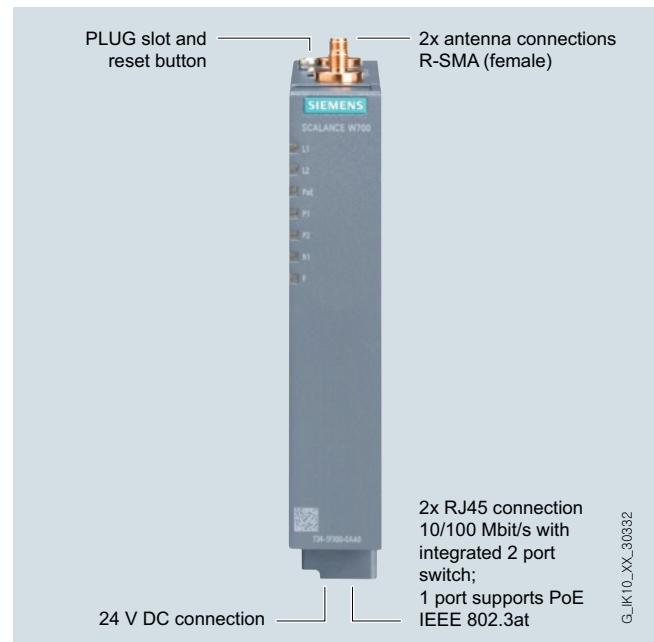

Design and interfaces of the SCALANCE W734 RJ45 client modules

#### Product versions

##### SCALANCE W734-1 RJ45

- A radio card is permanently installed; functional scope can be expanded by using a KEY-PLUG W740 iFeatures

# Industrial Wireless Communication IWLAN – Client Modules IEEE 802.11n

## SCALANCE W734 RJ45 for use in control cabinet

### Function

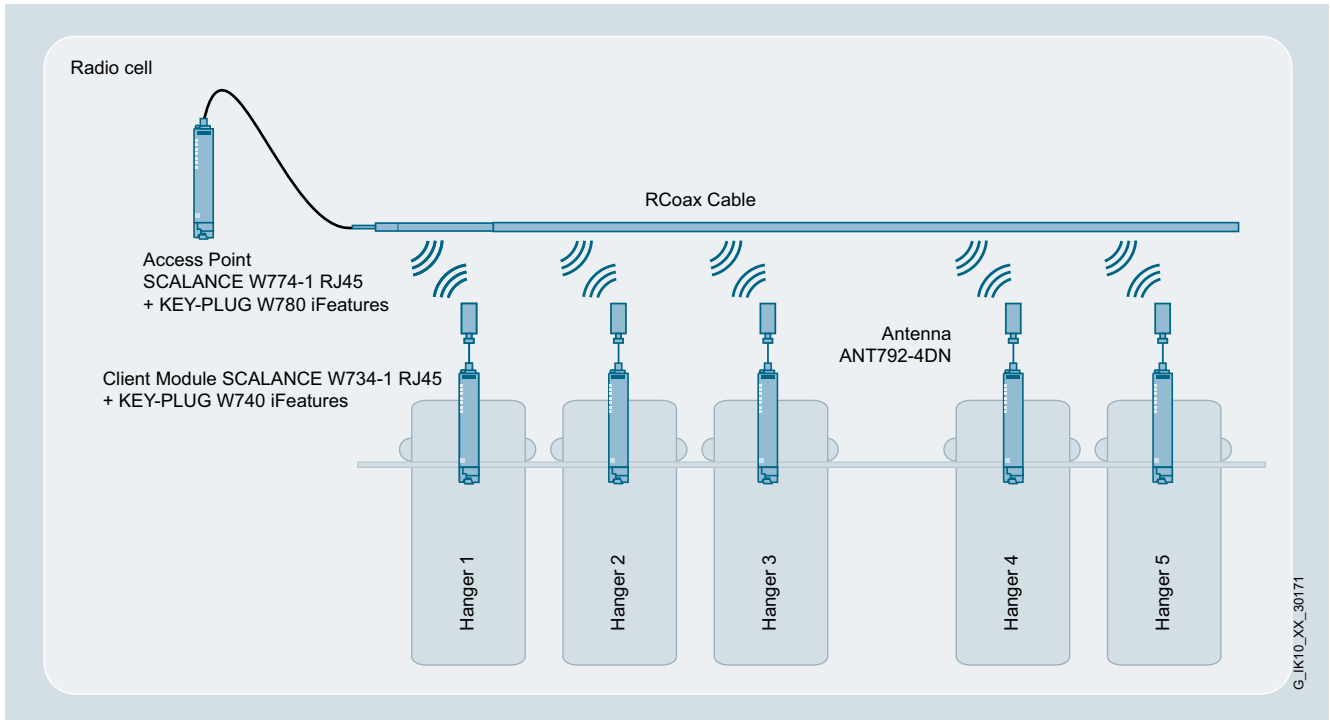

6

Use of the SCALANCE W734-1 RJ45 in a suspended monorail

#### Technical specifications

<b>Article No.</b>	<b>6GK5734-1FX00-0AA0 6GK5734-1FX00-0AB0<sup>1)</sup></b>
<b>Product-type designation</b>	<b>SCALANCE W734-1 RJ45</b>
<b>Transmission rate</b>	
Transmission rate	
• with W-LAN maximum	300 Mbit/s
• with Industrial Ethernet	10 ... 100 Mbit/s
• note	-
<b>Interfaces</b>	
Number of electrical connections	2
• for network components and terminal equipment	
• for power supply	1
• for redundant power supply	1
Design of the electrical connection	
• for network components and terminal equipment	RJ45 socket
• for power supply	4-pole screw terminal, PoE
Number of optical interfaces for optical waveguide at 100 Mbit/s	-
Design of optical interface for optical waveguide at 100 Mbit/s	-
Design of the removable storage C-PLUG	Yes
<b>Interfaces wireless</b>	
Number of radio cards permanently installed	1
Number of internal antennas	-
Number of electrical connections for external antenna(s)	2
Design of the electrical connection for external antenna(s)	R-SMA (socket)
Product property external antenna can be mounted directly on device	Yes
<b>Supply voltage, current consumption, power loss</b>	
Type of supply voltage	DC
Supply voltage	
• 1 from terminal block	19.2 V
• 2 from terminal block	28.8 V
• from Power-over-Ethernet according IEEE802.3at for type 1 and IEEE802.3af	48 V
• from Power-over-Ethernet according IEEE802.3at for type 2	-
Current consumed	
• at 24 V with DC typical	0.25 A
• with Power-over-Ethernet according to IEEE802.3at for type 1 and IEEE802.3af typical	0.125 A
• with Power-over-Ethernet according to IEEE802.3at for type 2 typical	-
Effective power loss	
• at 24V for DC typical	6 W
• with Power-over-Ethernet according to IEEE802.3at for type 1 and IEEE802.3af typical	6 W
• with Power-over-Ethernet according to IEEE802.3at for type 2 typical	-

<sup>1)</sup> Wireless approval in the USA

<b>Article No.</b>	<b>6GK5734-1FX00-0AA0 6GK5734-1FX00-0AB0<sup>1)</sup></b>
<b>Product-type designation</b>	<b>SCALANCE W734-1 RJ45</b>
<b>Permitted ambient conditions</b>	
Ambient temperature	
• during operating	-20 ... +60 °C
• during storage	-40 ... +85 °C
• during transport	-40 ... +85 °C
Relative humidity at 25 °C without condensation during operating maximum	97 %
Protection class IP	IP30
Ambient condition for (standard) operation mode	When used under hazardous conditions (Zone 2), the SCALANCE W774-1 RJ45 or W734-1 RJ45 product must be installed in an enclosure. To comply with EN 50021, this enclosure must meet the requirements of at least IP5 in compliance with EN 60529.
<b>Design, dimensions and weight</b>	
Width of enclosure without antenna	26 mm
Height of enclosure without antenna	147 mm
Depth of enclosure without antenna	127 mm
Net weight	0.52 kg
Mounting type wall mounting	Yes
Mounting type	Wall mounting only if flat mounted
<b>Wireless frequencies</b>	
Radio frequency	
• for WLAN in 2.4 GHz frequency band	2.41 ... 2.48 GHz
• for WLAN in 5 GHz frequency band	4.9 ... 5.8 GHz
<b>Product properties, functions, components general</b>	
Product function	
• Access Point Mode	No
• Client Mode	Yes
Number of SSIDs	-
Product function	
• iPCF Access Point	-
• iPCF client	Yes
• iPCF-MC Access Point	-
• iPCF-MC client	Yes
Number of iPCF-capable radio modules	1

## Industrial Wireless Communication

### IWLAN – Client Modules IEEE 802.11n

#### SCALANCE W734 RJ45 for use in control cabinet

#### Technical specifications (continued)

Article No.	6GK5734-1FX00-0AA0 6GK5734-1FX00-0AB0 <sup>1)</sup>	Article No.	6GK5734-1FX00-0AA0 6GK5734-1FX00-0AB0 <sup>1)</sup>
<b>Product-type designation</b>	<b>SCALANCE W734-1 RJ45</b>	<b>Product-type designation</b>	<b>SCALANCE W734-1 RJ45</b>
<b>Product functions management, configuration</b>		<b>Product functions Security</b>	
Number of manageable IP addresses in client	8	Product function	
Product function		• ACL - MAC-based	No
• CLI	Yes	• Management security, ACL-IP based	Yes
• web-based management	Yes	• IEEE 802.1x (radius)	Yes
• MIB support	Yes	• NAT/NAPT	No
• TRAPs via email	Yes	• access protection according to IEEE802.11i	Yes
• Configuration with STEP 7	in preparation	• WPA/WPA2	Yes
• configuration with STEP 7 in the TIA Portal	in preparation	• TKIP/AES	Yes
• operation with IWLAN controller	-	Protocol is supported SSH	Yes
• operation with Enterasys WLAN controller	-	<b>Product functions Time</b>	
• forced roaming with IWLAN	No	Protocol is supported	
• WDS	No	• SNMP	Yes
Protocol is supported		• SIMATIC Time	Yes
• Address Resolution Protocol (ARP)	Yes	<b>Standards, specifications, approvals</b>	
• ICMP	Yes	Standard	
• Telnet	Yes	• for hazardous zone	in preparation
• HTTP	Yes	• for safety of CSA and UL	-
• HTTPS	Yes	Verification of suitability	
• TFTP	Yes	• CE mark	Yes
• SNMP v1	Yes	• EC declaration of conformity	Yes
• SNMP v2	Yes	• C-Tick	Yes
• SNMP v3	Yes	• CCC	-
• DCP	Yes	• Railway application in accordance with EN 50155	-
• LLDP	Yes	• e1 approval	-
Identification & maintenance function		• E1 approval	-
• I&M0 - device-specific information	Yes	• NEMA4X	-
• I&M1 – higher level designation/location designation	Yes	• Power-over-Ethernet according IEEE802.3at for type 1 and IEEE802.3af	Yes
<b>Product functions Diagnosis</b>		• Power-over-Ethernet according to IEEE802.3at for type 2	Yes
Product function		Standard for wireless communication	
• PROFINET IO diagnosis	in preparation	• IEEE 802.11a	Yes
• localization via Aeroscout	No	• IEEE 802.11b	Yes
• SysLog	Yes	• IEEE 802.11e	Yes
<b>Product functions VLAN</b>		• IEEE 802.11g	Yes
Product function function VLAN with IWLAN	No	• IEEE 802.11h	Yes
<b>Product functions DHCP</b>		• IEEE 802.11i	Yes
Product function		• IEEE 802.11n	Yes
• DHCP client	Yes	Wireless approval	You will find the current list of countries at: <a href="http://www.siemens.com/wireless-approvals">www.siemens.com/wireless-approvals</a>
• in Client Mode DHCP server via LAN	No	<b>Accessories</b>	
		Accessories	24 V DC screw terminal included in scope of delivery

<sup>1)</sup> Wireless approval in the USA



Ordering data	Article No.	More information
<b>SCALANCE W734 Client Modules</b>		
IWLAN Ethernet client modules with built-in wireless interface; wireless networks IEEE 802.11a/b/g/h/n at 2.4/5 GHz up to 300 Mbit/s; WPA2/AES; integrated 2-port switch; Power over Ethernet (PoE), IP30 degree of protection (-20 °C to +60 °C); scope of delivery: Mounting hardware, 4-pin screw terminal for 24V DC; manual on CD-ROM; German/English		
<b>SCALANCE W734-1 RJ45</b>		
for managing the wireless connection of up to eight linked devices with Industrial Ethernet connection		
<ul style="list-style-type: none"> <li>National approvals for operation outside the USA</li> </ul>	<b>6GK5734-1FX00-0AA0</b>	<b>Selection tools:</b> To assist in selecting Industrial Ethernet components, the TIA Selection Tool is available at: <a href="http://www.siemens.com/tia-selection-tool">http://www.siemens.com/tia-selection-tool</a>
<ul style="list-style-type: none"> <li>National approvals for operation within the USA <sup>1)</sup></li> </ul>	<b>6GK5734-1FX00-0AB0</b>	<b>Wireless approvals:</b> Current approvals can be found on the Internet at: <a href="http://www.siemens.com/wireless-approvals">http://www.siemens.com/wireless-approvals</a>
<b>Accessories</b>		
<b>KEY-PLUG W740 iFeatures</b>		
Swap medium for enabling additional iFeatures, for simple device replacement if a fault occurs and for storage of configuration data; can be used in SCALANCE W client modules with PLUG compartment	<b>6GK5907-4PA00</b>	
<b>C-PLUG</b>		
Swap medium for simple replacement of devices if a fault occurs; for storing configuration data; can be used in SIMATIC NET products with PLUG compartment	<b>6GK1900-0AB00</b>	
<b>IE FC RJ45 Plug 180 x 2</b>		
RJ45 plug connector for Industrial Ethernet with a rugged metal enclosure and integrated insulation-displacement contacts for connecting Industrial Ethernet FC installation cables; with a 180° cable outlet; for network components and CPs/CPUs with Industrial Ethernet interface		
<ul style="list-style-type: none"> <li>1 pack = 1 unit</li> </ul>	<b>6GK1901-1BB10-2AA0</b>	
<ul style="list-style-type: none"> <li>1 pack = 10 units</li> </ul>	<b>6GK1901-1BB10-2AB0</b>	
<ul style="list-style-type: none"> <li>1 pack = 50 units</li> </ul>	<b>6GK1901-1BB10-2AE0</b>	
<b>IE FC Standard Cable GP 2 x 2</b>		
4-core, shielded TP installation cable for connection to IE FC outlet RJ45 plug / IE FC RJ45 plug; PROFINET-compliant; with UL approval Sold by the meter max. quantity 1 000 m minimum order 20 m	<b>6XV1840-2AH10</b>	
<b>IE FC Stripping Tool</b>		
Preadjusted stripping tool for fast stripping of the Industrial Ethernet FC cables	<b>6GK1901-1GA00</b>	
<b>Antennas and miscellaneous IWLAN accessories</b>	See Industrial Wireless LAN/accessories	

<sup>1)</sup> Please note national approvals under  
<http://www.siemens.com/wireless-approvals>

## Industrial Wireless Communication

### IWLAN – Client Modules IEEE 802.11n

#### SCALANCE W722 RJ45 for use in control cabinet

##### Overview



- Low-cost Client Module, suitable for applications where the device is to be mounted in the control cabinet
- Equipped with iFeatures



SIMATIC ET 200SP station with SCALANCE W722 RJ45

##### Design

- Compact design for space-saving installation in control cabinets or boxes on a standard mounting rail
- Implementation of simple and cost-effective wireless machine networking
- Support of the 2.4 and 5 GHz frequency band
- Degree of protection IP20
- For use at ambient temperatures from 0 °C to +55 °C
- 1 x R-SMA socket for the connection of a remote antenna
- 1 x RJ45 port for 10/100 Mbit/s
- 1 x 24 V DC connection
- Function LEDs for optical signaling of faults/errors and operating statuses
- SIMATIC design matches existing components in the control cabinet (e.g. ET 200SP, etc.)

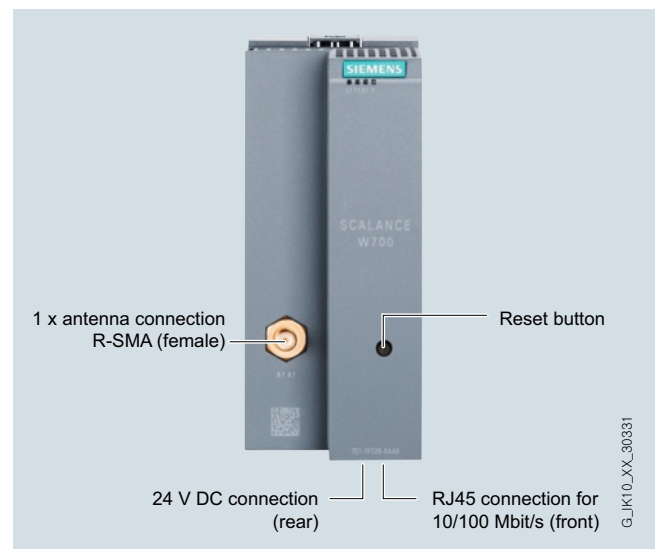

Design and interfaces of the SCALANCE W722 RJ45 client modules

##### Product versions

###### SCALANCE W722-1 RJ45

- A wireless card permanently installed in the device; suitable for establishing wireless connections with iFeatures

### Function

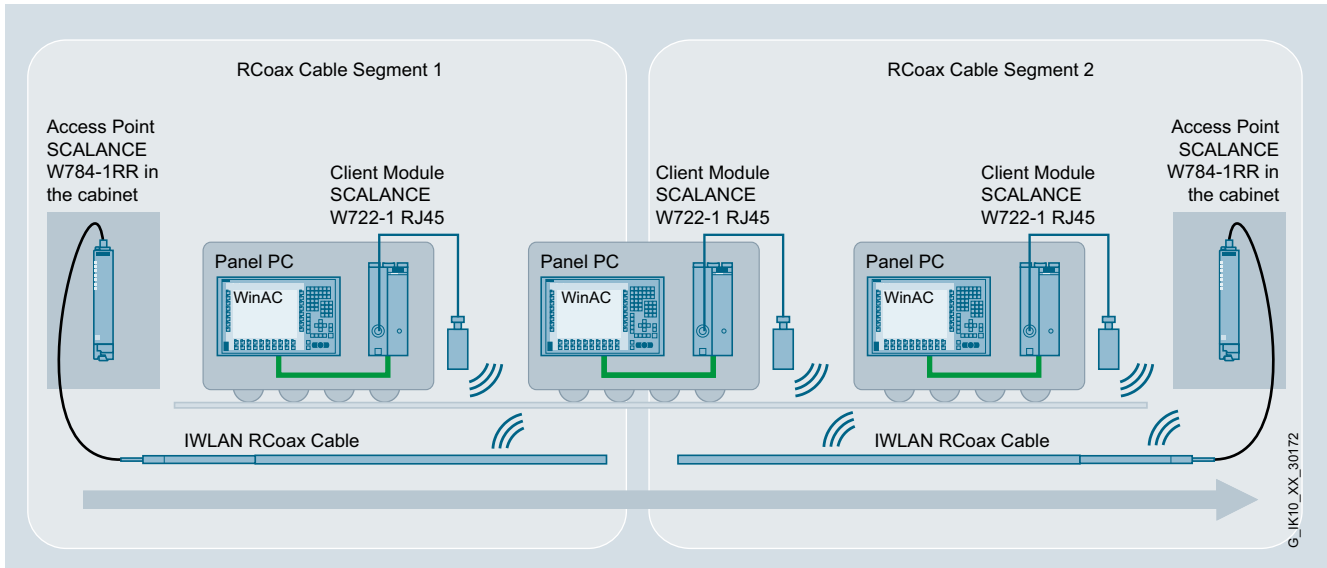

Integration of an automated guided vehicle system using iPCF with the SCALANCE W722-1 RJ45

### Technical specifications

Article No.	6GK5722-1FC00-0AA0 6GK5722-1FC00-0AB0 <sup>1)</sup>	Article No.	6GK5722-1FC00-0AA0 6GK5722-1FC00-0AB0 <sup>1)</sup>
<b>Product-type designation</b>	<b>SCALANCE W722-1 RJ45</b>	<b>Product-type designation</b>	<b>SCALANCE W722-1 RJ45</b>
<b>Transmission rate</b>		<b>Supply voltage, current consumption, power loss</b>	
Transmission rate		Type of supply voltage	DC
• with W-LAN maximum	150 Mbit/s	Supply voltage	
• with Industrial Ethernet	10 ... 100 Mbit/s	• 1 from terminal block	19.2 V
• note	-	• 2 from terminal block	28.8 V
<b>Interfaces</b>		• from Power-over-Ethernet according to IEEE802.3at for type 1 and IEEE802.3af	-
Number of electrical connections	1	• from Power-over-Ethernet according to IEEE802.3at for type 2	-
• for network components and terminal equipment	1	Current consumed	
• for power supply	1	• at 24 V with DC typical	0.15 A
• for redundant power supply	0	• with Power-over-Ethernet according to IEEE802.3at for type 1 and IEEE802.3af typical	-
Design of the electrical connection		• with Power-over-Ethernet according to IEEE802.3at for type 2 typical	-
• for network components and terminal equipment	RJ45 socket	Effective power loss	
• for power supply	3-pole screw terminal	• at 24V for DC typical	3.6 W
Number of optical interfaces for optical waveguide at 100 Mbit/s	-	• with Power-over-Ethernet according to IEEE802.3at for type 1 and IEEE802.3af typical	-
Design of optical interface for optical waveguide at 100 Mbit/s	-	• with Power-over-Ethernet according to IEEE802.3at for type 2 typical	-
Design of the removable storage C-PLUG	No		
<b>Interfaces wireless</b>			
Number of radio cards permanently installed	1		
Number of internal antennas	-		
Number of electrical connections for external antenna(s)	1		
Design of the electrical connection for external antenna(s)	R-SMA (socket)		
Product property external antenna can be mounted directly on device	Yes		

<sup>1)</sup> Wireless approval in the USA

## Industrial Wireless Communication

### IWLAN – Client Modules IEEE 802.11n

#### SCALANCE W722 RJ45 for use in control cabinet

##### Technical specifications (continued)

Article No.	6GK5722-1FC00-0AA0 6GK5722-1FC00-0AB0 <sup>1)</sup>	Article No.	6GK5722-1FC00-0AA0 6GK5722-1FC00-0AB0 <sup>1)</sup>
<b>Product-type designation</b>	<b>SCALANCE W722-1 RJ45</b>	<b>Product-type designation</b>	<b>SCALANCE W722-1 RJ45</b>
<b>Permitted ambient conditions</b>		<b>Product functions management, configuration</b>	
Ambient temperature		Number of manageable IP addresses in client	4
• during operating	0 ... 55 °C	Product function	
• during storage	-40 ... +85 °C	• CLI	Yes
• during transport	-40 ... +85 °C	• web-based management	Yes
Relative humidity at 25 °C without condensation during operating maximum	95 %	• MIB support	Yes
Protection class IP	IP20	• TRAPs via email	Yes
Ambient condition for (standard) operation mode	When used under hazardous conditions (Zone 2), the SCALANCE W761-1 RJ45 or W72x-1 RJ45 product must be installed in an enclosure. To comply with EN 50021, this enclosure must meet the requirements of at least IP54 in compliance with EN 60529.	• Configuration with STEP 7	in preparation
		• configuration with STEP 7 in the TIA Portal	in preparation
		• operation with IWLAN controller	-
		• operation with Enterasys WLAN controller	-
		• forced roaming with IWLAN	No
		• WDS	No
		Protocol is supported	
		• Address Resolution Protocol (ARP)	Yes
		• ICMP	Yes
		• Telnet	Yes
		• HTTP	Yes
		• HTTPS	Yes
		• TFTP	Yes
		• SNMP v1	Yes
		• SNMP v2	Yes
		• SNMP v3	Yes
		• DCP	Yes
		• LLDP	No
		Identification & maintenance function	
		• I&M0 - device-specific information	Yes
		• I&M1 – higher level designation/ location designation	Yes
		<b>Product functions Diagnosis</b>	
		Product function	
		• PROFINET IO diagnosis	No
		• Link Check	No
		• connection monitoring IP-Alive	No
		• localization via Aeroscout	No
		• SysLog	Yes
		<b>Product functions VLAN</b>	
		Product function function VLAN with IWLAN	No
		<b>Product functions DHCP</b>	
		Product function	
		• DHCP client	Yes
		• in Client Mode DHCP server via LAN	No
<b>Design, dimensions and weight</b>			
Width of enclosure without antenna	50 mm		
Height of enclosure without antenna	114 mm		
Depth of enclosure without antenna	74 mm		
Net weight	0.13 kg		
Mounting type wall mounting	No		
<b>Wireless frequencies</b>			
Radio frequency			
• for WLAN in 2.4 GHz frequency band	2.41 ... 2.48 GHz		
• for WLAN in 5 GHz frequency band	4.9 ... 5.8 GHz		
<b>Product properties, functions, components general</b>			
Product function			
• Access Point Mode	No		
• Client Mode	Yes		
Number of SSIDs	-		
Product function			
• iPCF Access Point	-		
• iPCF client	Yes		
• iPCF-MC Access Point	-		
• iPCF-MC client	Yes		
Number of iPCF-capable radio modules	1		

### Technical specifications (continued)

<b>Article No.</b>	<b>6GK5722-1FC00-0AA0</b> <b>6GK5722-1FC00-0AB0<sup>1)</sup></b>
<b>Product-type designation</b>	<b>SCALANCE W722-1 RJ45</b>
<b>Product functions Security</b>	
Product function	
• ACL - MAC-based	No
• Management security, ACL-IP based	Yes
• IEEE 802.1x (radius)	Yes
• NAT/NAPT	No
• access protection according to IEEE802.11i	Yes
• WPA/WPA2	Yes
• TKIP/AES	Yes
Protocol is supported SSH	Yes
<b>Product functions Time</b>	
Protocol is supported	
• SNTP	Yes
• SIMATIC Time	Yes
<b>Standards, specifications, approvals</b>	
Standard	
• for hazardous zone	in preparation
• for safety of CSA and UL	-
Verification of suitability	
• CE mark	Yes
• EC declaration of conformity	Yes
• C-Tick	Yes
• CCC	-
• Railway application in accordance with EN 50155	-
• e1 approval	-
• E1 approval	-
• NEMA4X	-
• Power-over-Ethernet according IEEE802.3at for type 1 and IEEE802.3af	No
• Power-over-Ethernet according to IEEE802.3at for type 2	No
Standard for wireless communication	
• IEEE 802.11a	Yes
• IEEE 802.11b	Yes
• IEEE 802.11e	Yes
• IEEE 802.11g	Yes
• IEEE 802.11h	Yes
• IEEE 802.11i	Yes
• IEEE 802.11n	Yes
Wireless approval	You will find the current list of countries at: <a href="http://www.siemens.com/wireless-approvals">www.siemens.com/wireless-approvals</a>
<b>Accessories</b>	
Accessories	24 V DC screw terminal included in scope of delivery

<sup>1)</sup> Wireless approval in the USA

### Ordering data

#### SCALANCE W722 Client Modules

IWLAN Ethernet Client Modules with iFeatures support and built-in wireless interface; wireless networks IEEE 802.11a/b/g/h/n at 2.4/5 GHz up to 150 Mbit/s; WPA2/AES; IP20 degree of protection (0 °C to +55 °C); scope of delivery: Mounting hardware, 3-pin screw terminal for 24V DC; manual on CD-ROM; German/English

#### SCALANCE W722-1 RJ45

for administration of the wireless connection with iFeatures from a connected device with Industrial Ethernet connection

- National approvals for operation outside the USA
- National approvals for operation within the USA <sup>1)</sup>

**6GK5722-1FC00-0AA0**

**6GK5722-1FC00-0AB0**

#### Accessories

#### IE FC RJ45 Plug 180 2 x 2

RJ45 plug connector for Industrial Ethernet with a rugged metal enclosure and integrated insulation-displacement contacts for connecting Industrial Ethernet FC installation cables; with a 180° cable outlet; for network components and CPs/CPU's with Industrial Ethernet interface

- 1 pack = 1 unit
- 1 pack = 10 units
- 1 pack = 50 units

**6GK1901-1BB10-2AA0**

**6GK1901-1BB10-2AB0**

**6GK1901-1BB10-2AE0**

#### IE FC Standard Cable GP 2 x 2

**6XV1840-2AH10**

4-core, shielded TP installation cable for connection to IE FC outlet RJ45 plug / IE FC RJ45 plug; PROFINET-compliant; with UL approval  
Sold by the meter  
max. quantity 1 000 m  
minimum order 20 m

#### IE FC Stripping Tool

**6GK1901-1GA00**

Preadjusted stripping tool for fast stripping of the Industrial Ethernet FC cables

#### Antennas and miscellaneous IWLAN accessories

See Industrial Wireless LAN/ accessories

<sup>1)</sup> Please note national approvals under <http://www.siemens.com/wireless-approvals>

### More information

#### Selection tools:

To assist in selecting Industrial Ethernet components, the TIA Selection Tool is available at:

<http://www.siemens.com/tia-selection-tool>

#### Wireless approvals:

Current approvals can be found on the Internet at:

<http://www.siemens.com/wireless-approvals>

## Industrial Wireless Communication

### IWLAN – Client Modules IEEE 802.11n

#### SCALANCE W721 RJ45 for use in control cabinet

##### Overview



- Low-cost Client Module, suitable for applications where the device is to be mounted in the control cabinet

##### Design

- Compact design for space-saving installation in control cabinets or boxes on a standard mounting rail
- Implementation of simple and cost-effective wireless machine networking
- Support of the 2.4 and 5 GHz frequency band
- Degree of protection IP20
- For use at ambient temperatures from 0 °C to +55 °C
- 1 x R-SMA socket for the connection of a remote antenna
- 1 x RJ45 port for 10/100 Mbit/s
- 1 x 24 V DC connection
- Function LEDs for optical signaling of faults/errors and operating statuses
- SIMATIC design matches existing components in the control cabinet (e.g. ET 200SP, etc.)

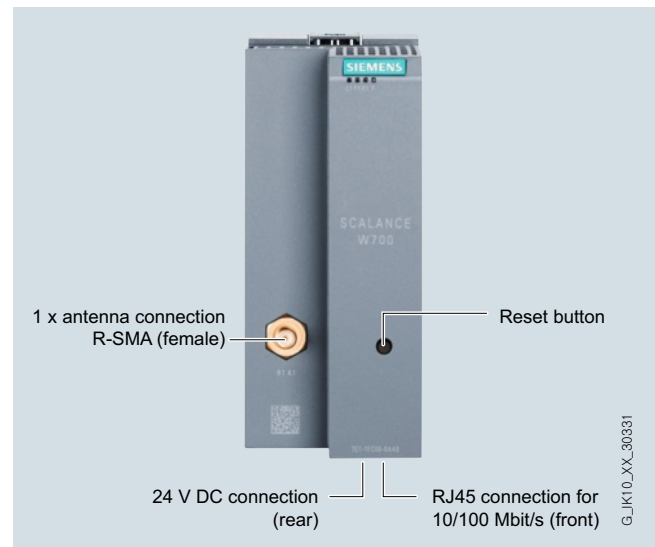

Design and interfaces of the SCALANCE W721 RJ45 client modules

##### Product versions

###### SCALANCE W721-1 RJ45

- A wireless card permanently installed in the device;

### Integration

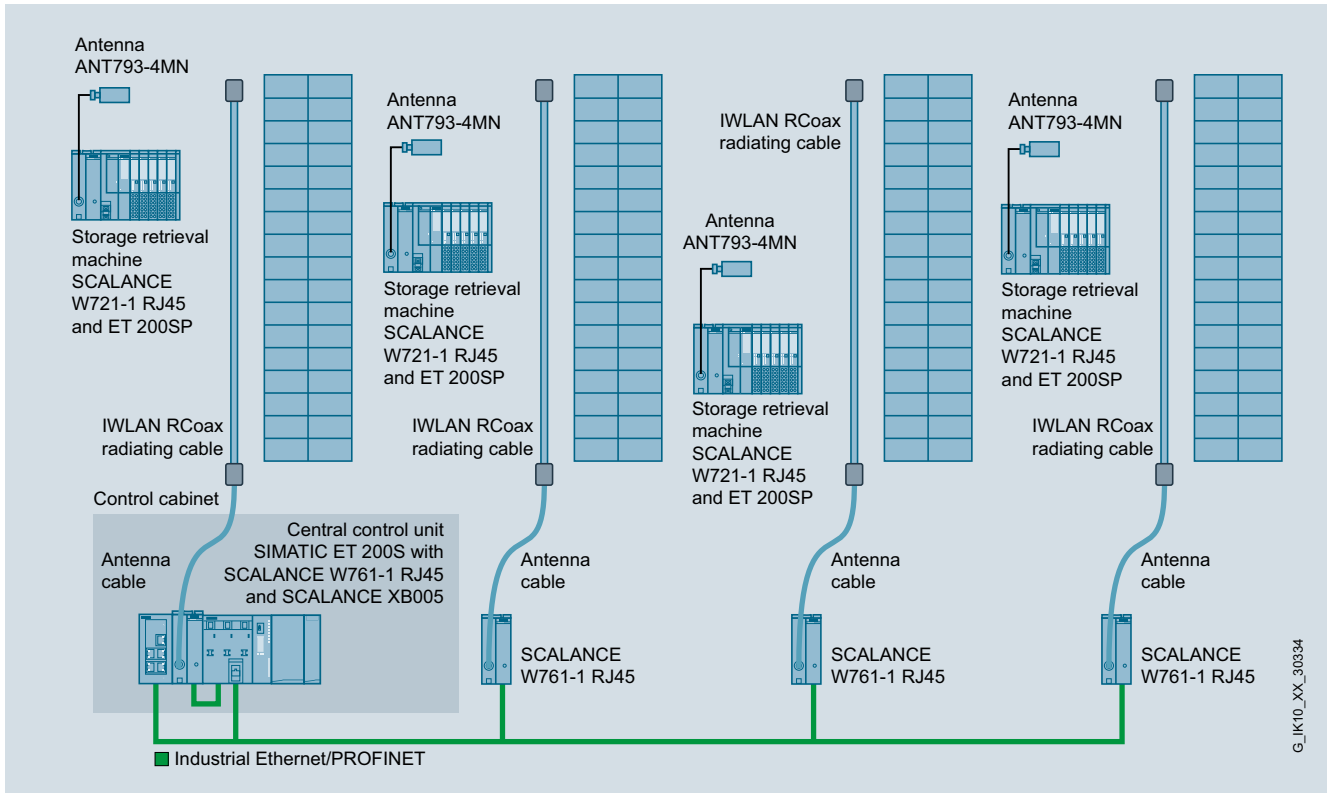

Storage and retrieval systems in high-bay warehouses automated with SCALANCE W721-1 RJ45, W761-1 RJ45 and RCoax

### Technical specifications

Article No.	6GK5721-1FC00-0AA0 6GK5721-1FC00-0AB0 <sup>1)</sup>	Article No.	6GK5721-1FC00-0AA0 6GK5721-1FC00-0AB0 <sup>1)</sup>
<b>Product-type designation</b>	SCALANCE W721-1 RJ45	<b>Product-type designation</b>	SCALANCE W721-1 RJ45
<b>Transmission rate</b>		<b>Interfaces wireless</b>	
Transmission rate		Number of radio cards permanently installed	1
• with W-LAN maximum	150 Mbit/s	Number of internal antennas	-
• with Industrial Ethernet	10 ... 100 Mbit/s	Number of electrical connections for external antenna(s)	1
• note	-	Design of the electrical connection for external antenna(s)	R-SMA (socket)
<b>Interfaces</b>		Product property external antenna can be mounted directly on device	Yes
Number of electrical connections			
• for network components and terminal equipment	1		
• for power supply	1		
• for redundant power supply	0		
Design of the electrical connection			
• for network components and terminal equipment	RJ45 socket		
• for power supply	3-pole screw terminal		
Number of optical interfaces for optical waveguide at 100 Mbit/s	-		
Design of optical interface for optical waveguide at 100 Mbit/s	-		
Design of the removable storage C-PLUG	No		

<sup>1)</sup> Wireless approval in the USA

## Industrial Wireless Communication

### IWLAN – Client Modules IEEE 802.11n

#### SCALANCE W721 RJ45 for use in control cabinet

#### Technical specifications (continued)

Article No.	6GK5721-1FC00-0AA0 6GK5721-1FC00-0AB0 <sup>1)</sup>	Article No.	6GK5721-1FC00-0AA0 6GK5721-1FC00-0AB0 <sup>1)</sup>
<b>Product-type designation</b>	<b>SCALANCE W721-1 RJ45</b>	<b>Product-type designation</b>	<b>SCALANCE W721-1 RJ45</b>
<b>Supply voltage, current consumption, power loss</b>		<b>Product properties, functions, components general</b>	
Type of supply voltage	DC	Product function	
Supply voltage		• Access Point Mode	No
• 1 from terminal block	19.2 V	• Client Mode	Yes
• 2 from terminal block	28.8 V	Number of SSIDs	-
• from Power-over-Ethernet according IEEE802.3at for type 1 and IEEE802.3af	-	Product function	
• from Power-over-Ethernet according IEEE802.3at for type 2	-	• iPCF Access Point	-
Current consumed		• iPCF client	-
• at 24 V with DC typical	0.15 A	• iPCF-MC Access Point	-
• with Power-over-Ethernet according to IEEE802.3at for type 1 and IEEE802.3af typical	-	• iPCF-MC client	-
• with Power-over-Ethernet according to IEEE802.3at for type 2 typical	-	Number of iPCF-capable radio modules	-
Effective power loss		<b>Product functions management, configuration</b>	
• at 24V for DC typical	3.6 W	Number of manageable IP addresses in client	4
• with Power-over-Ethernet according to IEEE802.3at for type 1 and IEEE802.3af typical	-	Product function	
• with Power-over-Ethernet according to IEEE802.3at for type 2 typical	-	• CLI	Yes
<b>Permitted ambient conditions</b>		• web-based management	Yes
Ambient temperature		• MIB support	Yes
• during operating	0 ... 55 °C	• TRAPs via email	Yes
• during storage	-40 ... +85 °C	• Configuration with STEP 7	in preparation
• during transport	-40 ... +85 °C	• configuration with STEP 7 in the TIA Portal	in preparation
Relative humidity at 25 °C without condensation during operating maximum	95 %	• operation with IWLAN controller	-
Protection class IP	IP20	• operation with Enterasys WLAN controller	-
Ambient condition for (standard) operation mode	When used under hazardous conditions (Zone 2), the SCALANCE W761-1 RJ45 or W72x-1 RJ45 product must be installed in an enclosure. To comply with EN 50021, this enclosure must meet the requirements of at least IP54 in compliance with EN 60529.	• forced roaming with IWLAN	No
<b>Design, dimensions and weight</b>		• WDS	No
Width of enclosure without antenna	50 mm	Protocol is supported	
Height of enclosure without antenna	114 mm	• Address Resolution Protocol (ARP)	Yes
Depth of enclosure without antenna	74 mm	• ICMP	Yes
Net weight	0.13 kg	• Telnet	Yes
Mounting type wall mounting	No	• HTTP	Yes
<b>Wireless frequencies</b>		• HTTPS	Yes
Radio frequency		• TFTP	Yes
• for WLAN in 2.4 GHz frequency band	2.41 ... 2.48 GHz	• SNMP v1	Yes
• for WLAN in 5 GHz frequency band	4.9 ... 5.8 GHz	• SNMP v2	Yes
		• SNMP v3	Yes
		• DCP	Yes
		• LLDP	No
		Identification & maintenance function	
		• I&M0 - device-specific information	Yes
		• I&M1 – higher level designation/ location designation	Yes
		<b>Product functions Diagnosis</b>	
		Product function	
		• PROFINET IO diagnosis	No
		• localization via Aeroscout	No
		• SysLog	Yes
		<b>Product functions VLAN</b>	
		Product function function VLAN with IWLAN	No
		<b>Product functions DHCP</b>	
		Product function	
		• DHCP client	Yes
		• in Client Mode DHCP server via LAN	No



# Industrial Wireless Communication

## IWLAN – Client Modules IEEE 802.11n

### SCALANCE W721 RJ45 for use in control cabinet

#### Technical specifications (continued)

<b>Article No.</b>	<b>6GK5721-1FC00-0AA0</b> <b>6GK5721-1FC00-0AB0<sup>1)</sup></b>
<b>Product-type designation</b>	<b>SCALANCE W721-1 RJ45</b>
<b>Product functions Security</b>	
Product function	
• ACL - MAC-based	No
• Management security, ACL-IP based	Yes
• IEEE 802.1x (radius)	Yes
• NAT/NAPT	No
• access protection according to IEEE802.11i	Yes
• WPA/WPA2	Yes
• TKIP/AES	Yes
Protocol is supported SSH	Yes
<b>Product functions Time</b>	
Protocol is supported	
• SNTP	Yes
• SIMATIC Time	Yes
<b>Standards, specifications, approvals</b>	
Standard	
• for hazardous zone	in preparation
• for safety of CSA and UL	-
Verification of suitability	
• CE mark	Yes
• EC declaration of conformity	Yes
• C-Tick	Yes
• CCC	-
• Railway application in accordance with EN 50155	-
• e1 approval	-
• E1 approval	-
• NEMA4X	-
• Power-over-Ethernet according IEEE802.3at for type 1 and IEEE802.3af	No
• Power-over-Ethernet according to IEEE802.3at for type 2	No
Standard for wireless communication	
• IEEE 802.11a	Yes
• IEEE 802.11b	Yes
• IEEE 802.11e	Yes
• IEEE 802.11g	Yes
• IEEE 802.11h	Yes
• IEEE 802.11i	Yes
• IEEE 802.11n	Yes
Wireless approval	You will find the current list of countries at: <a href="http://www.siemens.com/wireless-approvals">www.siemens.com/wireless-approvals</a>
<b>Accessories</b>	
Accessories	24 V DC screw terminal included in scope of delivery

<sup>1)</sup> Wireless approval in the USA

#### Ordering data

#### Article No.

##### SCALANCE W721 Client Modules

IWLAN Ethernet Client Modules with built-in wireless interface; wireless networks IEEE 802.11a/b/g/h/n at 2.4/5 GHz up to 150 Mbit/s; WPA2/AES; IP20 degree of protection (0 °C to +55 °C); scope of delivery: Mounting hardware, 3-pin screw terminal for 24V DC; manual on CD-ROM; German/English

##### SCALANCE W721-1 RJ45

For administration of the wireless connection from a connected device with Industrial Ethernet connection

- National approvals for operation outside the USA
- National approvals for operation within the USA <sup>1)</sup>

**6GK5721-1FC00-0AA0**

**6GK5721-1FC00-0AB0**

##### Accessories

##### IE FC RJ45 Plug 180 2 x 2

RJ45 plug connector for Industrial Ethernet with a rugged metal enclosure and integrated insulation-displacement contacts for connecting Industrial Ethernet FC installation cables; with a 180° cable outlet; for network components and CPs/CPUs with Industrial Ethernet interface

- 1 pack = 1 unit
- 1 pack = 10 units
- 1 pack = 50 units

**6GK1901-1BB10-2AA0**

**6GK1901-1BB10-2AB0**

**6GK1901-1BB10-2AE0**

##### IE FC Standard Cable GP 2 x 2

**6XV1840-2AH10**

4-core, shielded TP installation cable for connection to IE FC outlet RJ45 plug / IE FC RJ45 plug; PROFINET-compliant; with UL approval; sold by the meter; max. quantity 1 000 m, minimum order 20 m

##### IE FC Stripping Tool

**6GK1901-1GA00**

Preadjusted stripping tool for fast stripping of the Industrial Ethernet FC cables

##### Antennas and miscellaneous IWLAN accessories

See Industrial Wireless LAN/ accessories

<sup>1)</sup> Please note national approvals under <http://www.siemens.com/wireless-approvals>

#### More information

##### Selection tools:

To assist in selecting Industrial Ethernet components, the TIA Selection Tool is available at:  
<http://www.siemens.com/tia-selection-tool>

##### Wireless approvals:

Current approvals can be found on the Internet at:  
<http://www.siemens.com/wireless-approvals>

## Industrial Wireless Communication

### IWLAN – Accessories

#### IWLAN antennas

##### Overview



Remote antennas increase the reliability of wireless links by optimizing the receiving and emission of signals.

- Use in Industrial Wireless LAN (IWLAN) and WLAN in accordance with IEEE 802.11 at 2.4 GHz and 5 GHz with transmission rates of up to 450 Mbit/s
- Coordinated range of antennas for the most diverse applications both indoors and outdoors
- Antennas with two (dual-slant) or three (MIMO) connections for increased data throughput and increased reliability of the wireless connection thanks to selective use of multiple path propagation
- Suitable for use in hazardous areas (Zone 2); no special approvals necessary

##### Benefits

**get** Designed for Industry

- Investment protection thanks to compliance with the globally recognized standard IEEE 802.11 and – depending on the version – suitability for 2.4 GHz and/or 5 GHz
- Cost-effective connection to devices in remote, difficult-to-access, or hostile environments
- Establishment of a reliable IWLAN wireless infrastructure through the use of remote antennas, even if the access points and client modules are installed in the cabinet, for example

##### Application

Separate antennas optimize the transmission and receiving conditions and support the use of IWLAN products in a number of industrial applications.

With sector antennas, for example, conveyor lines or corridors can be specifically covered with radio links, or strongly directional antennas can be used to implement point-to-point connections over distances of up to several 1 000 meters.

Alternatively, an omnidirectional antenna concentrates the radio field around the antenna in the shape of a disc, which enhances the quality of the connection.

Antennas with two or three connections enable transmission of the two to three streams usual with IEEE 802.11n, using just one antenna. They are available both with omnidirectional and directional characteristics.

##### **Application examples:**

###### *Omnidirectional antennas*

- Coverage of an area which has at its center a pole for mounting the antenna
- Installation of the antenna on the roof in the case of automated guided vehicle systems for reliable data exchange with the vehicles
- Wide-area coverage of a production cell or robot station











###### *Sector antennas*

- Selective coverage of warehouse/high-bay warehouse aisles with the help of a wide-angle antenna prevents interference with neighboring wireless fields

###### *Directional antennas*









- Communication between buildings over long distances with the help of an antenna with narrow opening angle and high gain

**Design**

Type of antenna	Frequency range (GHz)	Antennas	SCALANCE W780/W740	SCALANCE W770/W730	SCALANCE W760/W720
omnidirectional	2.4	 ANT792-6MN	●	●	●
	2.4 and 5	 ANT795-4MA	●	●	●
		 ANT795-4MC	●		
		 ANT795-4MD	●		
		 ANT795-6MN	●	●	●
	 ANT795-6MT	●			
	5	 ANT793-6MN	●	●	●
Sector	2.4 and 5	 ANT795-6DC	●	●	
	5	 ANT793-6DG	●	●	
		 ANT793-6DT	●		

G\_IK10\_XX\_30318

Omnidirectional and sector antennas

Type of antenna	Frequency range (GHz)	Antennas	SCALANCE W780/W740	SCALANCE W770/W730	SCALANCE W760/W720
directional	2.4	 ANT792-8DN	●		
	5	 ANT793-8DP	●		
		 ANT793-8DJ	●		
		 ANT793-8DK	●		
RCoax	2.4	 RCoax radiating cables 2.4 GHz	●	●	●
		 ANT792-4DN	●	●	●
	5	 RCoax radiating cables 5 GHz	●	●	●
		 ANT793-4MN	●	●	●

G\_IK10\_XX\_30317

IWLAN directional antennas and RCoax radiating cable

## Industrial Wireless Communication

### IWLAN – Accessories

#### IWLAN antennas

##### Function

Separate antennas are used to optimize the radio field for the application. In industrial applications, this permits a reliable radio link.

##### **Antennas with multiple connections (dual or MIMO antennas)**

Antennas with two connections combine two individual antennas, at 90° to each other, in a single antenna enclosure. With these antennas, two data streams can be transferred simultaneously thanks to the two different polarization levels. Depending on the alignment of the polarization levels, these antennas are referred to as dual-slant (rotated through +/-45°) or vertical-horizontal.

Antennas with three connections contain three individual emitters that can be combined in a single enclosure, either on different polarization levels (0°, +/-45°) or at a suitable distance from each other. The MIMO antennas can transmit or receive three data streams simultaneously using multiple path propagation.

Transmission of several data streams results in increased data throughput and simultaneously a more reliable data transfer.

##### **Directional effect**

The suitable antenna is selected first by means of the wireless field characteristic. A distinction is made between omnidirectional antennas and directional antennas.

##### **Omnidirectional antennas**

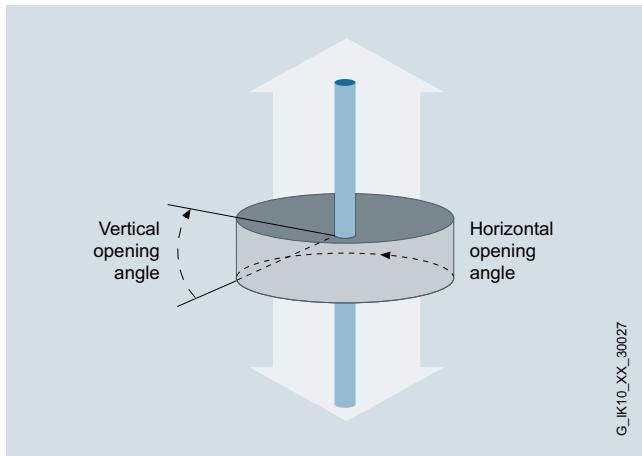

Omnidirectional antenna

With omnidirectional antennas, the radio field is emitted in every direction surrounding the antenna (horizontal opening angle: 360°), but it weakens as the distance increases. There is a concentration in the vertical direction which creates passive amplification of the radio field. Many omnidirectional antennas have extremely weak radiation directly below the antenna due to their type of construction. This property can be seen in the associated antenna diagram.

##### **ANT795-4Mx**

With these omnidirectional antennas, the radio field is concentrated at 2.4 GHz and 5 GHz in the vertical plane of the antenna. All antennas of this type have an opening angle of 30° in the vertical direction and an antenna gain of 3/5 dBi. They are directly mounted on the R-SMA or N connector of the SCALANCE W enclosure.

##### **ANT795-4MA, ANT795-4MC and ANT795-4MD**

The ANT795-4MC and ANT 795-4MD antennas can be rotated around only one axis, they have N-Connect connectors and degree of protection IP65 and are used with the SCALANCE W788 M12 Access Points and the SCALANCE W748 M12 Client Modules.

The ANT795-4MA antenna features an additional joint, an R-SMA connector, and degree of protection IP30. It is therefore optimally suitable for the SCALANCE W788 RJ45, W770 and W760 Access Points and the SCALANCE W748 RJ45, W730 and W720 Client Modules.

##### **ANT792-6MN, ANT793-6MN**

With these omnidirectional antennas, the radio field is concentrated at 2.4 GHz (ANT792-6MN) and 5 GHz (ANT793-6MN) in the vertical plane of the antenna. The antennas have a gain of 6 dBi and 5 dBi respectively.

N-Connect is used as the connection plug and can be connected to SCALANCE W over an antenna connection cable from the range of IWLAN cabling. Both antennas are supplied with a mounting aid (metal bracket) that supports wall or mast mounting. The antennas are therefore ideally suited, for example, to providing radio coverage for a place that has a mast at its center on which they can be mounted.

##### **ANT795-6MN, antenna mounting tool for ANT795-6MN**

With this omnidirectional antenna, the radio field is concentrated at 2.4 GHz and 5 GHz in the vertical plane of the antenna. The antenna has a gain of 6 dBi and 8 dBi respectively.

N-Connect is used as connection plug. The antenna can be connected to SCALANCE W over an antenna connection cable from the IWLAN cabling systems range. The antenna characteristic is such that good transmission properties also exist directly above and below the antenna. It is designed for mounting on a control cabinet or roof, but it can also be mounted under a roof, so it is suitable, for example, for the mobile units of an automated guided vehicle system. If it needs to be installed on a ceiling under a roof, the optional antenna mounting tool for ANT795-6MN is used.

##### **ANT795-6MT**

This antenna is an omnidirectional MIMO antenna with three QMA connections. The wireless field is concentrated at 2.4 GHz and 5 GHz in the vertical plane of the antenna. The antenna has a gain of 6 dBi.

The antenna characteristic is such that good transmission properties also exist directly above and below the antenna. It is designed for mounting on a roof or (together with the supplied mounting bracket) under a ceiling, and it is thus suitable, for example, for the mobile units of automated guided vehicle systems.

The ANT795-6MT is connected to the SCALANCE W-780/W740 Access Points via QMA/N-Connect male/female IWLAN adapter cables and the IWLAN flexible antenna connection cables in the relevant length and connector version.

**Function** (continued)

**Directional antennas**

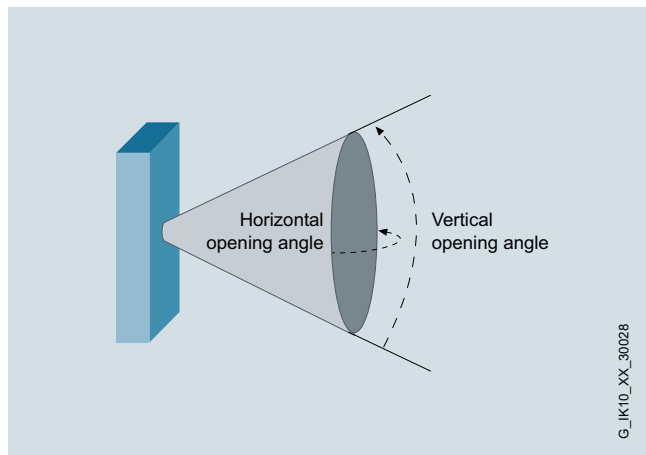

Directional antenna

With directional antennas, the radio field is emitted both in the horizontal and vertical plane in the range of the opening angle. It is concentrated in these areas and generates passive amplification. Based on the opening angle, directional antennas are divided into sector or wide-angle antennas (opening angle > approx. 30°) and strongly directional antennas. Directional antennas are ideally suited to wall or mast mounting. The supplied mounting aid is used for a targeted adjustment. N-Connect is generally used as connection plug. The antenna can be connected to SCALANCE W over an antenna connection cable from the IWLAN cabling systems range.

**ANT795-6DC, ANT793-6DG and ANT793-6DT**

The radio field can be aligned at 2.4 GHz and 5 GHz using these sector antennas. Each has an antenna gain of 9 dBi.

Thanks to their characteristics, they are suitable, for example, for providing wireless coverage for an area in front of a wall.

The ANT795-6DC antenna is suitable for both frequency bands 2.4 and 5 GHz. It has an N-Connect connection. Together with a SCALANCE W780 or W770, two or three antennas of this type can also be used for covering multiple sectors.

ANT793-6DG is a dual-slant antenna with two N-Connect connections for the 5 GHz frequency band.

ANT793-6DT is a MIMO antenna with three QMA connections for the 5 GHz band.

The ANT795-6DT is connected to the SCALANCE W-780/W740 Access Points via QMA/N-Connect male/female IWLAN adapter cables and the IWLAN flexible antenna connection cables in the relevant length and connector version.

**ANT792-8DN, ANT793-8DP, ANT 793-8DJ and ANT793-8DK**

These strongly directional antennas enable genuine amplification of the radio field. The radio field is concentrated in a narrow cone due to the narrow opening angle. High passive gains and long ranges are therefore achieved.

Due to the high passive gain, the antennas are ideally suited to bridging large distances.

The ANT792-8DN antenna is suitable for the 2.4 GHz frequency band and has an antenna gain of 14 dBi.

ANT793-8DP is an antenna with a high gain (13.5 dBi) in a compact enclosure. It is suitable for the frequency band from 4.9 to 5.35 GHz and therefore preferably for applications in Japan.

ANT793-8DJ (18 dBi) and ANT793-8DK (23 dBi) are strongly directional antennas with vertical-horizontal polarization. They each have two N-Connect connections.

Antenna for SCALANCE W-700								
ANT79	2	–	4	–	D	x		
	↑		↑		↑			
Frequency	2	2,4 GHz	Gain	4	medium gain	Directivity	D	directional antenna
	3	5 GHz		6	high gain		M	omni-directional antenna
	5	2,4 + 5 GHz		8	very high gain			
							G_IK10_XX_30288	

The antenna name indicates the properties of the IWLAN antennas

## Industrial Wireless Communication

### IWLAN – Accessories

#### IWLAN antennas

##### Function (continued)

##### Antennas especially for use with RCoax radiating cables

These antennas have been specially developed for use with the RCoax radiating cable. They are preferably used in environments in which nodes move within limited areas or exclusively along predefined paths. Typical applications are suspended monorails or high-bay racking systems where the antenna is within the near field of the radiating cable.

##### ANT793-4MN

With this omni-directional antenna, the radio field is concentrated at 5 GHz in the vertical plane of the antenna. The antenna has a gain of 6 dBi at 5.2 GHz and 5 dBi at 5.7 GHz. The polarization of the antenna is vertical ( $\lambda/8$  characteristic). N-Connect is used as connection plug. The antenna can be connected to SCALANCE W by means of an antenna connection cable from the IWLAN cabling systems range.

##### ANT792-4DN

The radio field is aligned at 2.4 GHz for this antenna. The antenna has a gain of 4 dBi. The polarization of the antenna is circular, i.e. the receive path of the signals of both polarizations is amplified equally well. Signal strength fluctuations are weaker at 2.4 GHz.

N-Connect is used as connection plug. The antenna can be connected to SCALANCE W by means of an antenna connection cable from the IWLAN cabling systems range.

##### Integration

SCALANCE W774-1RJ45 with detached antenna (frontal)

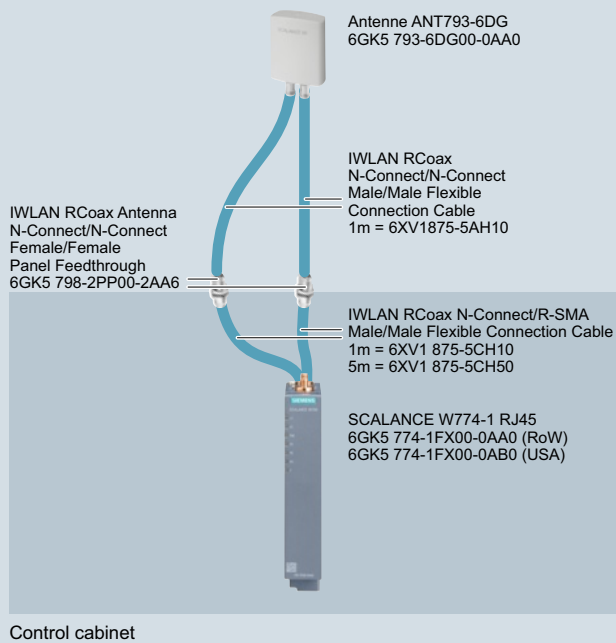

SCALANCE W774-1RJ45 with detached antenna (lateral)

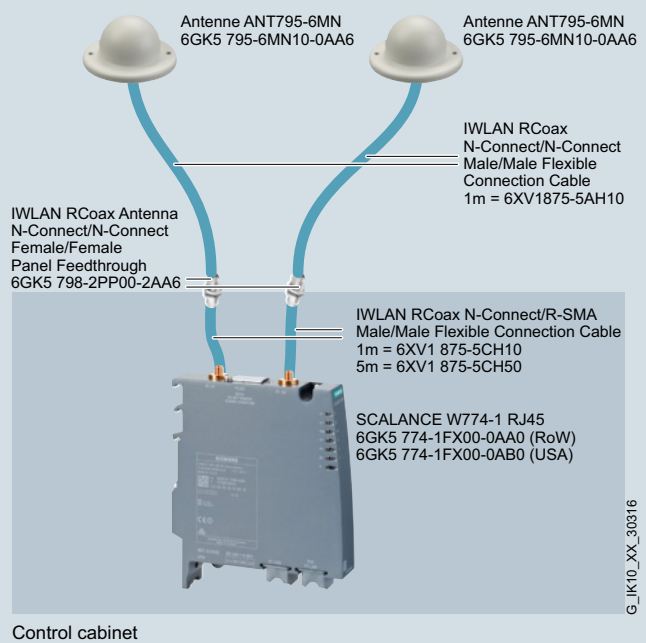

W774-1 RJ45 with remote antennas

G\_IK10\_XX\_30316

**Integration** (continued)

Antenna ANT793-6MN connected to SCALANCE W761-1 RJ45 (frontal)

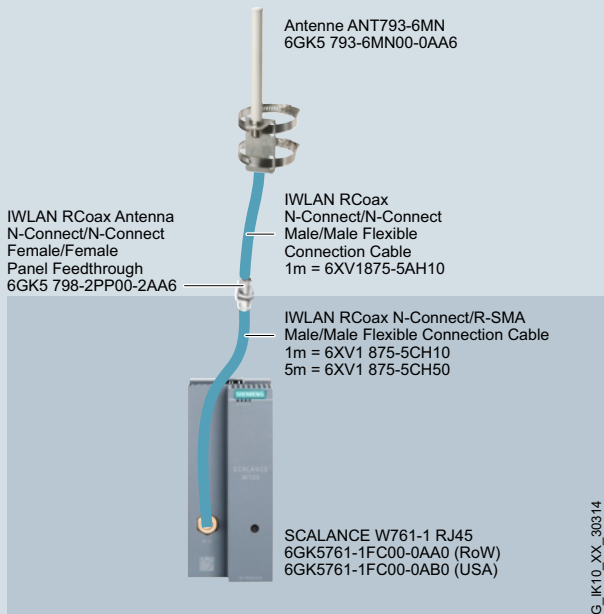

Control cabinet

MIMO antenna ANT795-6MT connected to SCALANCE W788-2 M12 with N-Connect ports

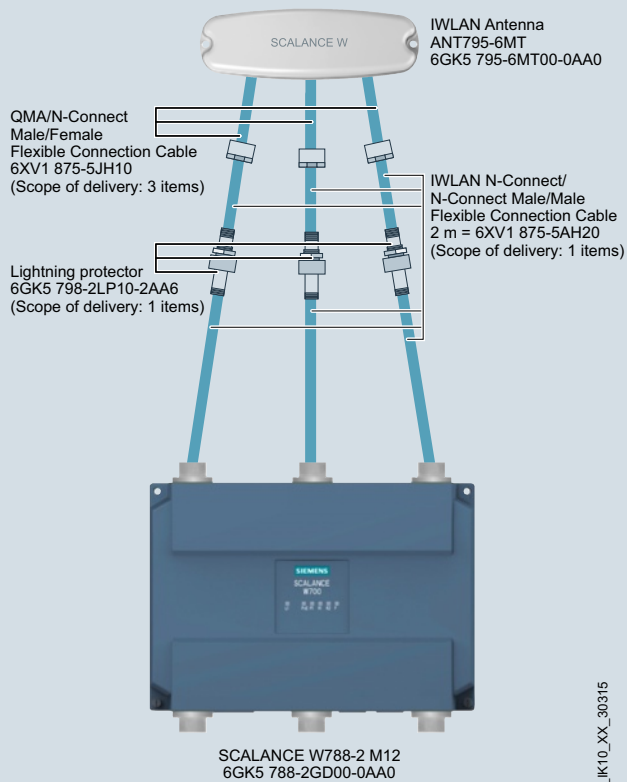

SCALANCE W761-1 RJ45 and SCALANCE W788-2 M12 with remote antennas

# Industrial Wireless Communication

## IWLAN – Accessories

### IWLAN antennas

#### Integration (continued)

Dual Slant antenna ANT793-6DG connected to SCALANCE W788-2 RJ45 with R-SMA ports

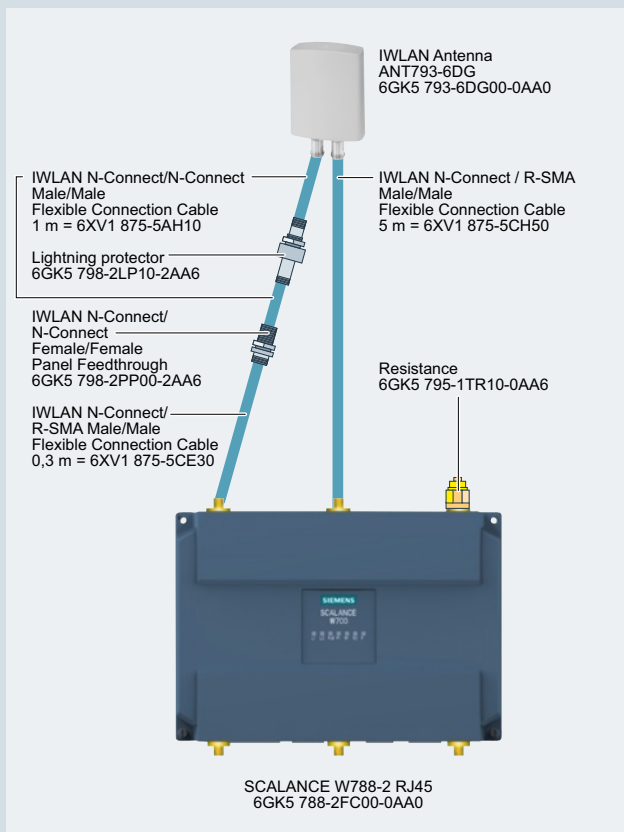

Dual Slant antenna ANT793-6DG connected to SCALANCE W788-2 M12 with N-Connect ports

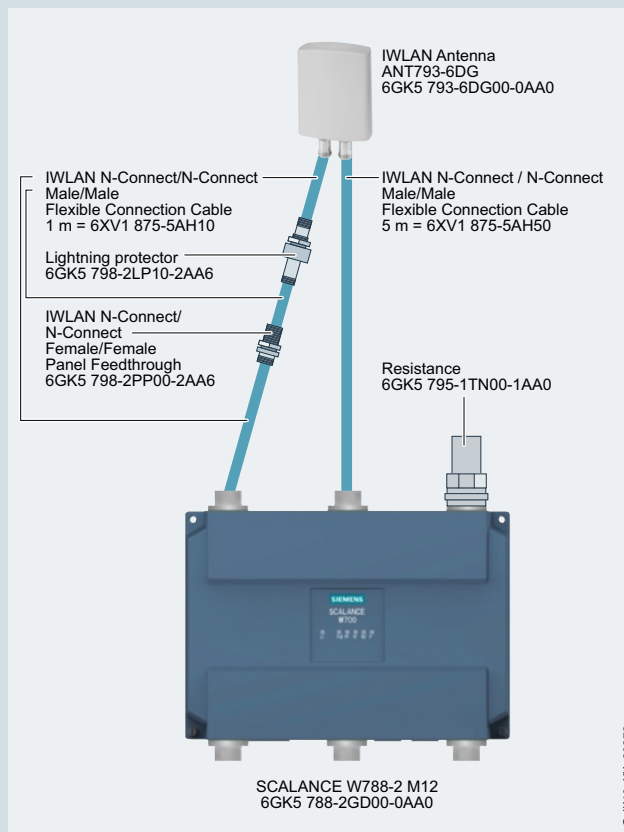

G\_IK10\_XX\_30272

SCALANCE W788-1 RJ45 access points with dual slant antenna and SCALANCE W788-1 M12 with N-Connect connection

All antennas can be used with an N-Connect female connector.



## Technical specifications

Article No.	6GK5795-4MC00-0AA3	6GK5795-4MD00-0AA3	6GK5795-4MA00-0AA3
Product-type designation	Antenna ANT795-4MC	Antenna ANT795-4MD	Antenna ANT795-4MA
<b>Wireless frequencies</b>			
Radio frequency			
• for WLAN in 2.4 GHz frequency band	2.4 ... 2.4835 GHz	2.4 ... 2.4835 GHz	2.4 ... 2.4835 GHz
• for WLAN in 5 GHz frequency band 1	5.15 ... 5.35 GHz	5.15 ... 5.35 GHz	5.15 ... 5.35 GHz
• for WLAN in 5 GHz frequency band 2	5.725 ... 5.85 GHz	5.725 ... 5.85 GHz	5.725 ... 5.85 GHz
<b>Electrical data</b>			
Impedance	50 Ω	50 Ω	50 Ω
Polarization	linear vertical	linear vertical	linear vertical
Radiation characteristic	omnidirectional	omnidirectional	omnidirectional
Antenna gain compared to spherical radiator with linear radiation	-	-	-
Antenna gain compared to spherical radiator with circular radiation	-	-	-
Antenna gain compared to spherical radiator of the WLAN antenna in the 2.4 GHz frequency band	3 dB	3 dB	3 dB
Antenna gain compared to spherical radiator of the WLAN antenna in the 5 GHz frequency band	5 dB	5 dB	5 dB
Standing wave ratio VSWR maximum	2	2	2
Beam angle of antenna			
• in the 2.4 GHz frequency band			
- horizontal	360°	360°	360°
- vertical	-	-	-
• in the 5 GHz frequency band			
- horizontal	360°	360°	360°
- vertical	-	-	-
Opening angle Note	-	-	-
Number of electrical connections of antenna	1	1	1
Design of electrical connection of antenna	N connector	N connector	R-SMA connector
Angle of inclination downward maximum	0°	0°	0°
Crosstalk attenuation between the antenna connections	-	-	-
Front-to-back ratio	-	-	-
Transmit power maximum	-	-	-
Transmit power Note	-	-	-
Range with clear line of sight without disturbance	-	-	-
Range Note	-	-	-
<b>Permitted ambient conditions</b>			
Ambient temperature			
• during operating	-20 ... +65 °C	-20 ... +65 °C	-20 ... +65 °C
• during storage	-20 ... +65 °C	-20 ... +65 °C	-20 ... +65 °C
• during transport	-20 ... +65 °C	-20 ... +65 °C	-20 ... +65 °C
• during installation	-	-	-
Protection class IP	IP65	IP65	IP30
Wind load maximum	-	-	-
Wind load Note	-	-	-

# Industrial Wireless Communication

## IWLAN – Accessories

### IWLAN antennas

#### Technical specifications (continued)

Article No.	6GK5795-4MC00-0AA3	6GK5795-4MD00-0AA3	6GK5795-4MA00-0AA3
Product-type designation	Antenna ANT795-4MC	Antenna ANT795-4MD	Antenna ANT795-4MA
<b>Design, dimensions and weight</b>			
Width	35 mm	35 mm	35 mm
Height	160 mm	160 mm	160 mm
Depth	13 mm	13 mm	13 mm
Diameter	-	-	-
Net weight	26 g	26 g	26 g
Mounting type			
• mast mounting	No	No	No
• wall mounting	No	No	No
• roof mounting	No	No	No
Mounting type/ directly on the device	Yes	Yes	Yes
<b>Product properties, functions, components general</b>			
Product feature silicon-free	Yes	Yes	Yes
Material of outer shell	Polycarbonate	Polycarbonate	Polycarbonate
<b>Standards, specifications, approvals</b>			
Standard for hazardous zone	-	-	-
Verification of suitability	-	-	-
• RoHS conformity	-	-	-
• Railway application in accordance with EN 50124-1	-	-	-
• Railway application in accordance with EN 50155	-	-	-
• fire protection in accordance with EN 45545-2	-	-	-
• UL approval	-	-	-
- note	-	-	-
Wireless approval	Current national approvals can be found on the Internet under <a href="http://www.siemens.com/wireless-approvals">www.siemens.com/wireless-approvals</a>	Current national approvals can be found on the Internet under <a href="http://www.siemens.com/wireless-approvals">www.siemens.com/wireless-approvals</a>	Current national approvals can be found on the Internet under <a href="http://www.siemens.com/wireless-approvals">www.siemens.com/wireless-approvals</a>

Article No.	6GK5792-6MN00-0AA6	6GK5793-6MN00-0AA6	6GK5795-6MN10-0AA6	6GK5795-6MT00-0AA0
Product-type designation	Antenna ANT792-6MN	Antenna ANT793-6MN	Antenna ANT795-6MN	Antenna ANT795-6MT
<b>Wireless frequencies</b>				
Radio frequency				
• for WLAN in 2.4 GHz frequency band	2.4 ... 2.5 GHz	-	2.4 ... 2.7 GHz	2.4 ... 2.69 GHz
• for WLAN in 5 GHz frequency band 1	-	5.15 ... 5.875 GHz	3.4 ... 3.7 GHz	5.15 ... 5.35 GHz
• for WLAN in 5 GHz frequency band 2	-	-	4.9 ... 5.935 GHz	5.47 ... 5.935 GHz
<b>Electrical data</b>				
Impedance	50 Ω	50 Ω	50 Ω	50 Ω
Polarization	linear vertical	linear vertical	linear vertical	3 ports: linear vertical
Radiation characteristic	omnidirectional	omnidirectional	omnidirectional	omnidirectional
Antenna gain compared to spherical radiator with linear radiation	-	-	-	-
Antenna gain compared to spherical radiator with circular radiation	-	-	-	-
Antenna gain compared to spherical radiator of the WLAN antenna in the 2.4 GHz frequency band	6 dB	-	6 dB	5 dB
Antenna gain compared to spherical radiator of the WLAN antenna in the 5 GHz frequency band	-	5 dB	8 dB	7 dB
Standing wave ratio VSWR maximum	1.8	1.5	1.8	1.5

### Technical specifications (continued)

Article No.	6GK5792-6MN00-0AA6	6GK5793-6MN00-0AA6	6GK5795-6MN10-0AA6	6GK5795-6MT00-0AA0
Product-type designation	Antenna ANT792-6MN	Antenna ANT793-6MN	Antenna ANT795-6MN	Antenna ANT795-6MT
Beam angle of antenna				
• in the 2.4 GHz frequency band				
- horizontal	360°	-	360°	360°
- vertical	30°	-	-	-
• in the 5 GHz frequency band				
- horizontal	-	360°	150°	360°
- vertical	-	25°	-	-
Opening angle Note	-	-	Note the antenna diagram regarding horizontal beam angle	-
Number of electrical connections of antenna				
Design of electrical connection of antenna				
Angle of inclination downward maximum	0°	0°	0°	0°
Crosstalk attenuation between the antenna connections	-	-	-	20 dB
Front-to-back ratio	-	-	-	-
Transmit power maximum	25 W	6 W	75 W	10 W
Transmit power Note	-	at 25° ambient temperature	at 25° ambient temperature	at 25° ambient temperature
Range with clear line of sight without disturbance	200 m	200 m	200 m	-
Range Note	Note: The range can be considerably less, depending on spatial factors, the wireless standard used, the data rate, and the antennas at the other end	Note: The range can be considerably less, depending on spatial factors, the wireless standard used, the data rate, and the antennas at the other end	Note: The range can be considerably less, depending on spatial factors, the wireless standard used, the data rate, and the antennas at the other end	-
<b>Permitted ambient conditions</b>				
Ambient temperature				
• during operating	-40 ... +80 °C	-45 ... +70 °C	-40 ... +80 °C	-40 ... +85 °C
• during storage	-40 ... +80 °C	-45 ... +70 °C	-40 ... +80 °C	-40 ... +85 °C
• during transport	-40 ... +80 °C	-45 ... +70 °C	-40 ... +80 °C	-40 ... +85 °C
• during installation	-	-	-	-
Protection class IP	IP65	IP65	IP65	IP65
Wind load maximum	3 N	3.9 N	10 N	-
Wind load Note	at 160 km/h	at 160 km/h	at 160 km/h	-
<b>Design, dimensions and weight</b>				
Width	50 mm	16 mm	86 mm	282 mm
Height	40 mm	160 mm	43 mm	32 mm
Depth	370 mm	16 mm	86 mm	92 mm
Diameter	-	-	-	-
Net weight	300 g	300 g	300 g	320 g
Mounting type	-	-	-	-
• mast mounting	Yes	Yes	No	No
• wall mounting	Yes	Yes	Yes	Yes
• roof mounting	No	No	Yes	Yes
Mounting type/ directly on the device	No	No	No	No
<b>Product properties, functions, components general</b>				
Product feature silicon-free	Yes	Yes	Yes	Yes
Material of outer shell	Glass fiber	Polypropylene	Polycarbonate	Polycarbonate

## Industrial Wireless Communication

### IWLAN – Accessories

#### IWLAN antennas

##### Technical specifications (continued)

Article No.	6GK5792-6MN00-0AA6	6GK5793-6MN00-0AA6	6GK5795-6MN10-0AA6	6GK5795-6MT00-0AA0
Product-type designation	Antenna ANT792-6MN	Antenna ANT793-6MN	Antenna ANT795-6MN	Antenna ANT795-6MT
<b>Standards, specifications, approvals</b>				
Standard for hazardous zone	-	-	-	-
Verification of suitability	-	-	Railway application in accordance with NF-F-16-101, NF-F-16-102	-
• RoHS conformity	Yes	Yes	Yes	Yes
• Railway application in accordance with EN 50124-1	-	-	Yes	-
• Railway application in accordance with EN 50155	-	-	Yes	-
• fire protection in accordance with EN 45545-2	-	-	-	-
• UL approval	-	-	-	-
- note	-	-	-	-
Wireless approval	Current national approvals can be found on the Internet under <a href="http://www.siemens.com/wireless-approvals">www.siemens.com/wireless-approvals</a>	Current national approvals can be found on the Internet under <a href="http://www.siemens.com/wireless-approvals">www.siemens.com/wireless-approvals</a>	Current national approvals can be found on the Internet under <a href="http://www.siemens.com/wireless-approvals">www.siemens.com/wireless-approvals</a>	Current national approvals can be found on the Internet under <a href="http://www.siemens.com/wireless-approvals">www.siemens.com/wireless-approvals</a>

Article No.	6GK5795-6DC00-0AA0	6GK5793-6DG00-0AA0	6GK5793-6DT00-0AA0
Product-type designation	Antenna ANT795-6DC	Antenna ANT793-6DG	Antenna ANT793-6DT
<b>Wireless frequencies</b>			
Radio frequency			
• for WLAN in 2.4 GHz frequency band	2.4 ... 2.5 GHz	-	-
• for WLAN in 5 GHz frequency band 1	5.15 ... 5.875 GHz	5.15 ... 5.875 GHz	5.15 ... 5.875 GHz
• for WLAN in 5 GHz frequency band 2	-	-	-
<b>Electrical data</b>			
Impedance	50 Ω	50 Ω	50 Ω
Polarization	linear vertical	dual linear +/- 45° slant	3 ports: vertical, +/- 45° slant
Radiation characteristic	directional	directional	directional
Antenna gain compared to spherical radiator with linear radiation	-	-	-
Antenna gain compared to spherical radiator with circular radiation	-	-	-
Antenna gain compared to spherical radiator of the WLAN antenna in the 2.4 GHz frequency band	9 dB	-	-
Antenna gain compared to spherical radiator of the WLAN antenna in the 5 GHz frequency band	9 dB	9 dB	8 dB
Standing wave ratio VSWR maximum	2	2	1.7
Beam angle of antenna			
• in the 2.4 GHz frequency band	75 ... 55°	-	-
Beam angle of antenna in the 5 GHz frequency band horizontal	55°	70°	65°
Beam angle of antenna in the 5 GHz frequency band vertical	55°	60°	65°
Opening angle Note	-	-	-
Number of electrical connections of antenna	1	2	3
Design of electrical connection of antenna	N connector	N connector	QMA connector
Angle of inclination downward max.	0°	0°	0°
Crosstalk attenuation between the antenna connections	25 dB	20 dB	17 dB
Front-to-back ratio	15 dB	20 dB	-
Transmit power maximum	10 W	10 W	2 W
Transmit power Note	at 25° ambient temperature	at 25° ambient temperature	at 25° ambient temperature
Range with clear line of sight without disturbance	-	-	-
Range Note	-	-	-

## Technical specifications (continued)

Article No.	6GK5795-6DC00-0AA0	6GK5793-6DG00-0AA0	6GK5793-6DT00-0AA0
Product-type designation	Antenna ANT795-6DC	Antenna ANT793-6DG	Antenna ANT793-6DT
<b>Permitted ambient conditions</b>			
Ambient temperature			
• during operating	-40 ... +80 °C	-40 ... +80 °C	-40 ... +85 °C
• during storage	-40 ... +80 °C	-40 ... +80 °C	-40 ... +85 °C
• during transport	-40 ... +80 °C	-40 ... +80 °C	-40 ... +85 °C
• during installation	-	-	-
Protection class IP	IP67	IP67	IP67
Wind load maximum	15 N	15 N	15 N
Wind load Note	at 160 km/h	frontal at 160 km/h	frontal at 160 km/h
<b>Design, dimensions and weight</b>			
Width	80 mm	80 mm	80 mm
Height	101 mm	101 mm	101 mm
Depth	35 mm	35 mm	35 mm
Diameter	-	-	-
Net weight	110 g	110 g	270 g
Mounting type	-	-	-
• mast mounting	Yes	Yes	Yes
• wall mounting	Yes	Yes	Yes
• roof mounting	No	No	No
Mounting type/ directly on the device	No	No	No
<b>Product properties, functions, components general</b>			
Product feature silicon-free	-	-	-
Material of outer shell	Lexan EXL 9330	Lexan EXL 9330	Lexan EXL 9330
<b>Standards, specifications, approvals</b>			
Standard for hazardous zone	-	-	-
Verification of suitability	-	-	-
• RoHS conformity	Yes	Yes	Yes
• Railway application in accordance with EN 50124-1	-	-	-
• Railway application in accordance with EN 50155	-	Yes	-
• fire protection in accordance with EN 45545-2	-	Yes	-
• UL approval	-	-	-
- note	-	-	UL94-V0, UL746C F1
Wireless approval	Current national approvals can be found on the Internet under <a href="http://www.siemens.com/wireless-approvals">www.siemens.com/wireless-approvals</a>	Current national approvals can be found on the Internet under <a href="http://www.siemens.com/wireless-approvals">www.siemens.com/wireless-approvals</a>	Current national approvals can be found on the Internet under <a href="http://www.siemens.com/wireless-approvals">www.siemens.com/wireless-approvals</a>

# Industrial Wireless Communication

## IWLAN – Accessories

### IWLAN antennas

#### Technical specifications (continued)

Article No.	6GK5792-8DN00-0AA6	6GK5793-8DJ00-0AA0	6GK5793-8DK00-0AA0	6GK5793-8DP00-0AA0
Product-type designation	Antenna ANT792-8DN	Antenna ANT793-6DJ	Antenna ANT793-6DK	Antenna ANT793-8DP
<b>Wireless frequencies</b>				
Radio frequency				
• for WLAN in 2.4 GHz frequency band	2.4 ... 2.7 GHz	-	-	-
• for WLAN in 5 GHz frequency band 1	-	5.25 ... 5.875 GHz	5.15 ... 5.875 GHz	4.9 ... 5.35 GHz
• for WLAN in 5 GHz frequency band 2	-	-	-	-
<b>Electrical data</b>				
Impedance	50 Ω	50 Ω	50 Ω	50 Ω
Polarization	linear vertical	dual linear vertical-horizontal	dual linear vertical-horizontal	linear vertical
Radiation characteristic	directional	directional	directional	directional
Antenna gain compared to spherical radiator with linear radiation	-	-	-	-
Antenna gain compared to spherical radiator with circular radiation	-	-	-	-
Antenna gain compared to spherical radiator of the WLAN antenna in the 2.4 GHz frequency band	14 dB	-	-	-
Antenna gain compared to spherical radiator of the WLAN antenna in the 5 GHz frequency band	-	18 dB	23 dB	13.5 dB
Standing wave ratio VSWR maximum	1.5	1.7	1.7	1.5
Beam angle of antenna				
• in the 2.4 GHz frequency band				
- horizontal	35°	-	-	-
- vertical	30°	-	-	-
• in the 5 GHz frequency band				
- horizontal	-	17°	9°	40°
- vertical	-	17°	9°	35°
Opening angle Note	-	-	-	-
Number of electrical connections of antenna	1	2	2	1
Design of electrical connection of antenna	N connector	N connector	N connector	N connector
Angle of inclination downward maximum	0°	0°	0°	0°
Crosstalk attenuation between the antenna connections	-	30 dB	40 dB	-
Front-to-back ratio	20 dB	30 dB	35 dB	20 dB
Transmit power				
• maximum	75 W	6 W	6 W	10 W
• Note	at 25° ambient temperature	at 25° ambient temperature	at 25° ambient temperature	at 25° ambient temperature
Range with clear line of sight without disturbance	1 000 m	-	-	-
Range Note	Note: The range can be considerably less, depending on spatial factors, the wireless standard used, the data rate, and the antennas at the other end	-	-	-
<b>Permitted ambient conditions</b>				
Ambient temperature				
• during operating	-40 ... +80 °C	-45 ... +70 °C	-45 ... +70 °C	-40 ... +80 °C
• during storage	-40 ... +80 °C	-45 ... +70 °C	-45 ... +70 °C	-40 ... +80 °C
• during transport	-40 ... +80 °C	-45 ... +70 °C	-45 ... +70 °C	-40 ... +80 °C
• during installation	-	-	-	-
Protection class IP	IP23	IP67	IP67	IP67
Wind load maximum	57 N	104 N	389 N	15 N
Wind load Note	at 160 km/h	frontal at 220 km/h	frontal at 220 km/h	frontal at 160 km/h

## Technical specifications (continued)

Article No.	6GK5792-8DN00-0AA6	6GK5793-8DJ00-0AA0	6GK5793-8DK00-0AA0	6GK5793-8DP00-0AA0
Product-type designation	Antenna ANT792-8DN	Antenna ANT793-6DJ	Antenna ANT793-6DK	Antenna ANT793-8DP
<b>Design, dimensions and weight</b>				
Width	200 mm	190 mm	371 mm	80 mm
Height	200 mm	190 mm	371 mm	101 mm
Depth	43 mm	30.5 mm	40 mm	35 mm
Diameter	-	-	-	-
Net weight	500 g	700 g	2.5 kg	110 g
Mounting type	-	-	-	-
• mast mounting	Yes	Yes	Yes	Yes
• wall mounting	Yes	Yes	Yes	Yes
• roof mounting	No	No	No	No
Mounting type/ directly on the device	No	No	No	No
<b>Product properties, functions, components general</b>				
Product feature silicon-free	Yes	-	-	-
Material of outer shell	ASA	Polycarbonate / aluminum	Polycarbonate	Lexan EXL 9330
<b>Standards, specifications, approvals</b>				
Standard for hazardous zone	-	-	-	-
Verification of suitability	-	-	-	-
• RoHS conformity	Yes	Yes	Yes	Yes
• Railway application in accordance with EN 50124-1	-	-	-	-
• Railway application in accordance with EN 50155	-	-	-	-
• fire protection	-	-	-	-
• in accordance with EN 45545-2	-	-	-	-
• UL approval	-	-	-	-
- note	-	-	-	UL94-V0
Wireless approval	Current national approvals can be found on the Internet under <a href="http://www.siemens.com/wireless-approvals">www.siemens.com/wireless-approvals</a>	Current national approvals can be found on the Internet under <a href="http://www.siemens.com/wireless-approvals">www.siemens.com/wireless-approvals</a>	Current national approvals can be found on the Internet under <a href="http://www.siemens.com/wireless-approvals">www.siemens.com/wireless-approvals</a>	Current national approvals can be found on the Internet under <a href="http://www.siemens.com/wireless-approvals">www.siemens.com/wireless-approvals</a>

Article No.	6GK5792-4DN00-0AA6	6GK5793-4MN00-0AA6
Product-type designation	RCoax antenna ANT792-4DN	RCoax antenna ANT793-4MN
<b>Wireless frequencies</b>		
Radio frequency	2.4 ... 2.4835 GHz	-
• for WLAN in 2.4 GHz frequency band	-	5.15 ... 5.85 GHz
• for WLAN in 5 GHz frequency band 1	-	-
• for WLAN in 5 GHz frequency band 2	-	-
<b>Electrical data</b>		
Impedance	50 Ω	50 Ω
Polarization	circular, clockwise	vertical (lambda 5/8 characteristic)
Radiation characteristic	directional	omnidirectional
Antenna gain compared to spherical radiator with linear radiation	-	-
Antenna gain compared to spherical radiator with circular radiation	-	-
Antenna gain compared to spherical radiator of the WLAN antenna in the 2.4 GHz frequency band	4 dB	-
Antenna gain compared to spherical radiator of the WLAN antenna in the 5 GHz frequency band	-	6 dB
Standing wave ratio VSWR maximum	1.8	2

# Industrial Wireless Communication

## IWLAN – Accessories

### IWLAN antennas

#### Technical specifications (continued)

Article No.	6GK5792-4DN00-0AA6	6GK5793-4MN00-0AA6
Product-type designation	RCoax antenna ANT792-4DN	RCoax antenna ANT793-4MN
Beam angle of antenna		
• in the 2.4 GHz frequency band		
- horizontal	90°	-
- vertical	-	-
• in the 5 GHz frequency band		
- horizontal	-	360°
- vertical	-	40°
Opening angle Note	-	-
Number of electrical connections of antenna	1	1
Design of electrical connection of antenna	N connector	N connector
Angle of inclination downward maximum	0°	0°
Crosstalk attenuation between the antenna connections	-	-
Front-to-back ratio	2.5 dB	-
Transmit power maximum	1 W	1 W
Transmit power Note	-	-
Range with clear line of sight without disturbance	-	-
Range Note	-	-
<b>Permitted ambient conditions</b>		
Ambient temperature		
• during operating	-40 ... +70 °C	-40 ... +70 °C
• during storage	-40 ... +70 °C	-40 ... +70 °C
• during transport	-40 ... +70 °C	-40 ... +70 °C
• during installation	-	-
Protection class IP	IP65	IP65
Wind load maximum	-	-
Wind load Note	-	-
<b>Design, dimensions and weight</b>		
Width	-	-
Height	78.7 mm	78.7 mm
Depth	-	-
Diameter	30 mm	30 mm
Net weight	114 g	65 g
<b>Product properties, functions, components general</b>		
Product feature silicon-free	Yes	Yes
Material of outer shell	Polycarbonate	Polycarbonate
<b>Standards, specifications, approvals</b>		
Standard for hazardous zone	-	-
Verification of suitability	-	-
• RoHS conformity	-	-
• Railway application in accordance with EN 50124-1	-	-
• Railway application in accordance with EN 50155	-	Yes
• fire protection in accordance with EN 45545-2	-	Yes
• UL approval	-	-
- note	-	UL94-V1
Wireless approval	Current national approvals can be found on the Internet under <a href="http://www.siemens.com/wireless-approvals">www.siemens.com/wireless-approvals</a>	Current national approvals can be found on the Internet under <a href="http://www.siemens.com/wireless-approvals">www.siemens.com/wireless-approvals</a>



Ordering data	Article No.	Article No.
<b>Antennas with omnidirectional characteristics;</b>		
National approvals, compact instructions on paper, German/English		
For mounting directly onto <u>SCALANCE W</u>		
Antenna gain incl. connector 3/5 dBi, 2.4/5 GHz;		
<ul style="list-style-type: none"> <li>• <b>ANT795-4MC antenna;</b> IP65 (-20 to +65 °C), straight connection, N-Connect male, scope of delivery: 1 antenna</li> <li>• <b>ANT795-4MD antenna;</b> IP65 (-20 to +65 °C), connection with fixed 90° angle, N-Connect male, scope of delivery: 1 antenna</li> <li>• <b>ANT795-4MA antenna;</b> IP30 (-20 to +65 °C); radial rotation possible</li> <li>• with additional joint; R-SMA male Scope of delivery: 1 antenna</li> </ul>	<p><b>6GK5795-4MC00-0AA3</b></p> <p><b>6GK5795-4MD00-0AA3</b></p> <p><b>6GK5 795-4MA00-0AA3</b></p>	
Wall or mast mounting		
<ul style="list-style-type: none"> <li>• <b>ANT792-6MN antenna</b> Antenna gain incl. N-Connect connector 6 dBi, 2.4 GHz; IP65 (-40 to +80°C), with terminating resistor 1 x TI795-1R; incl. mounting hardware</li> <li>• <b>ANT793-6MN antenna</b> Antenna gain incl. N-Connect connector 5 dBi, 5 GHz; IP65 (-45 to +70 °C), with terminating resistor 1 x TI795-1R;</li> <li>• incl. mounting hardware</li> </ul>	<p><b>6GK5792-6MN00-0AA6</b></p> <p><b>6GK5793-6MN00-0AA6</b></p>	
For mounting on a roof		
<ul style="list-style-type: none"> <li>• <b>ANT795-6MN antenna</b> Antenna gain incl. N-Connect connector 6/8 dBi, 2.4/5 GHz; IP65 (-40 to +80 °C), with terminating resistor 1 x TI795-1R</li> <li>• <b>ANT795-6MT antenna</b> MIMO antenna with 3 QMA sockets, antenna gain 6 dBi, 2.4/5 GHz; (-40 to +85 °C), incl. mounting bracket</li> <li>• <b>Antenna mounting tool (ANT795-6MN)</b> Mounting aid for installing ANT795-6MN below a roof</li> </ul>	<p><b>6GK5795-6MN10-0AA6</b></p> <p><b>6GK5795-6MT00-0AA0</b></p> <p><b>6GK5795-6MN01-0AA6</b></p>	
<b>Directional antennas;</b>		
including mounting hardware for wall or mast mounting		
Sector antennas		
<ul style="list-style-type: none"> <li>• <b>ANT795-6DC antenna</b> Antenna gain incl. N-Connect connector 9/9 dBi, 2.4/5 GHz, -40 to +80 °C</li> <li>• <b>ANT793-6DG antenna</b> Dual-slant; antenna gain</li> <li>• incl. two N-Connect connectors 9 dBi, 5 GHz, -40 to +80 °C</li> <li>• <b>ANT793-6DT antenna</b> MIMO antenna with 3 QMA sockets; antenna gain 9 dBi, 5 GHz, -40 to +85 °C</li> </ul>		<p><b>6GK5795-6DC00-0AA0</b></p> <p><b>6GK5793-6DG00-0AA0</b></p> <p><b>6GK5793-6DT00-0AA0</b></p>
Strongly directional antennas		
<ul style="list-style-type: none"> <li>• <b>ANT793-8DN antenna</b> Antenna gain 13.5 dBi incl. N-Connect connector, 4.9 GHz, -40 to +85 °C, preferably for use in Japan</li> <li>• <b>ANT792-8DN antenna</b> Antenna gain incl. N-Connect connector 14 dBi, 2.4 GHz; -40 to +80 °C; with terminating resistor 1 x TI795-1R</li> <li>• <b>ANT793-8DJ antenna</b> Vertically-horizontally polarized antenna; antenna gain incl. two N-Connect connectors 18 dBi, 5 GHz; -45 to +70 °C</li> <li>• <b>ANT793-8DK antenna</b> Vertically-horizontally polarized antenna; antenna gain incl. two N-Connect connectors 23 dBi, 5 GHz; -45 to +70 °C</li> </ul>		<p><b>6GK5793-8DP00-0AA0</b></p> <p><b>6GK5792-8DN00-0AA6</b></p> <p><b>6GK5793-8DJ00-0AA0</b></p> <p><b>6GK5793-8DK00-0AA0</b></p>
<b>Antennas for RCoax systems</b>		
<ul style="list-style-type: none"> <li>• <b>ANT792-4DN antenna</b> Circularly polarized RCoax helix antenna for RCoax systems; N-Connect female connection; antenna gain at 2.4 GHz 4 dBi</li> <li>• <b>ANT793-4MN antenna</b> Vertically polarized RCoax 5/8 antenna for RCoax systems; N-Connect female connection; antenna gain at 5.2 GHz/5.7 GHz 6/5 dBi</li> </ul>		<p><b>6GK5792-4DN00-0AA6</b></p> <p><b>6GK5793-4MN00-0AA6</b></p>

**More information****Selection tools:**

To assist in the selection of industrial Ethernet components, the TIA Selection Tool is available at:

<http://www.siemens.com/tia-selection-tool>

**Cabling range:**

You can order components supplementary to the SIMATIC NET cabling range from your local contact. Technical advice on this subject is available from:

J. Hertlein  
I IA SC CI PRM 4  
Phone +49 (911) 750-4465  
E-mail: [juergen.hertlein@siemens.com](mailto:juergen.hertlein@siemens.com)

## Industrial Wireless Communication

### IWLAN – Accessories

#### IWLAN RCoax cables

##### Overview



The RCoax cables are radiating cables that function as special antennas for the SCALANCE W Access Points in environments with complex radio coverage. Its design means that a defined, cone-shaped radio field is generated along the RCoax cable. The radiating cables are therefore perfectly suitable for use in all types of applications with track-bound vehicles.

- Rugged coaxial cable which can be easily installed
- Two cables for use in the frequency bands 2.4 GHz and 5 GHz
- Connection as external antenna to SCALANCE W700 Access Points
- Connection of mobile nodes via SCALANCE W700 Client Modules using an antenna aligned to the RCoax
- Suitable for use in hazardous areas (Zone 2); no special approvals necessary

##### Benefits

**get** Designed for Industry

- Reliable coverage in areas problematic for radio
- Avoidance of greater than desired WLAN expansion by means of defined emission of the radio waves
- Cost savings thanks to direct substitution of sliding contacts, trailing cables, and data light barriers
- Highly flexible laying

##### Design

The RCoax cables were specially designed for the frequency band around 2.4 GHz or 5 GHz respectively.

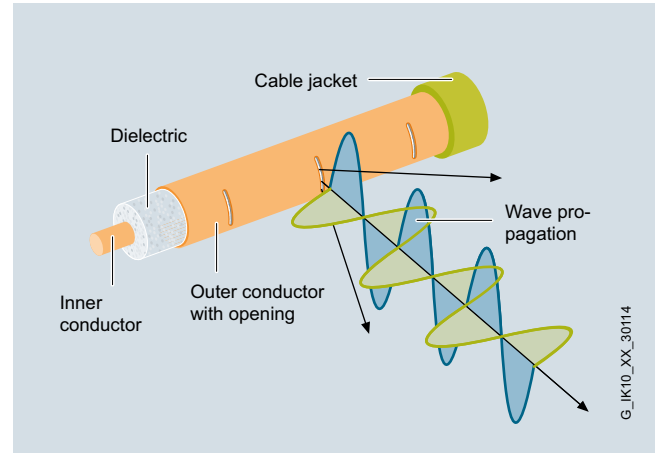

Openings are present in the outer conductor of the coaxial cable which permit the penetration and emission of radio waves. A defined radio field is then developed around the RCoax cables. Longitudinal damping and extraction loss are in a balanced relationship, which permits a long segment length of RCoax cable per SCALANCE W700 Access Point and an appropriate distance from the mobile station (SCALANCE W700) to the RCoax cable.

Coordinated accessories are available for assembly:

- IWLAN RCoax cable clip 1/2"
- IWLAN RCoax spacer 85 mm
- IWLAN RCoax threaded washer M6



### Application

- Areas with demanding conditions for wireless coverage (e.g. in tunnels, channels and elevator shafts) where "unlimited" mobility is not of decisive importance, but where a mechanically wear-free and thus maintenance-free solution is required to ensure reliable data transmission: this is made possible by the defined radio field along the RCoax cable.
- The RCoax cables offer a wear-free and reliable wireless link, particularly for conveyor systems and all types of rail-mounted vehicle (suspended monorails, AGV systems).
- Suspended monorail
- Automated guided vehicle systems (AGVS)
- Cranes
- Stacker cranes
- Transfer lines
- Tool-changing trolleys
- Tunnels
- Lifts

### Application examples

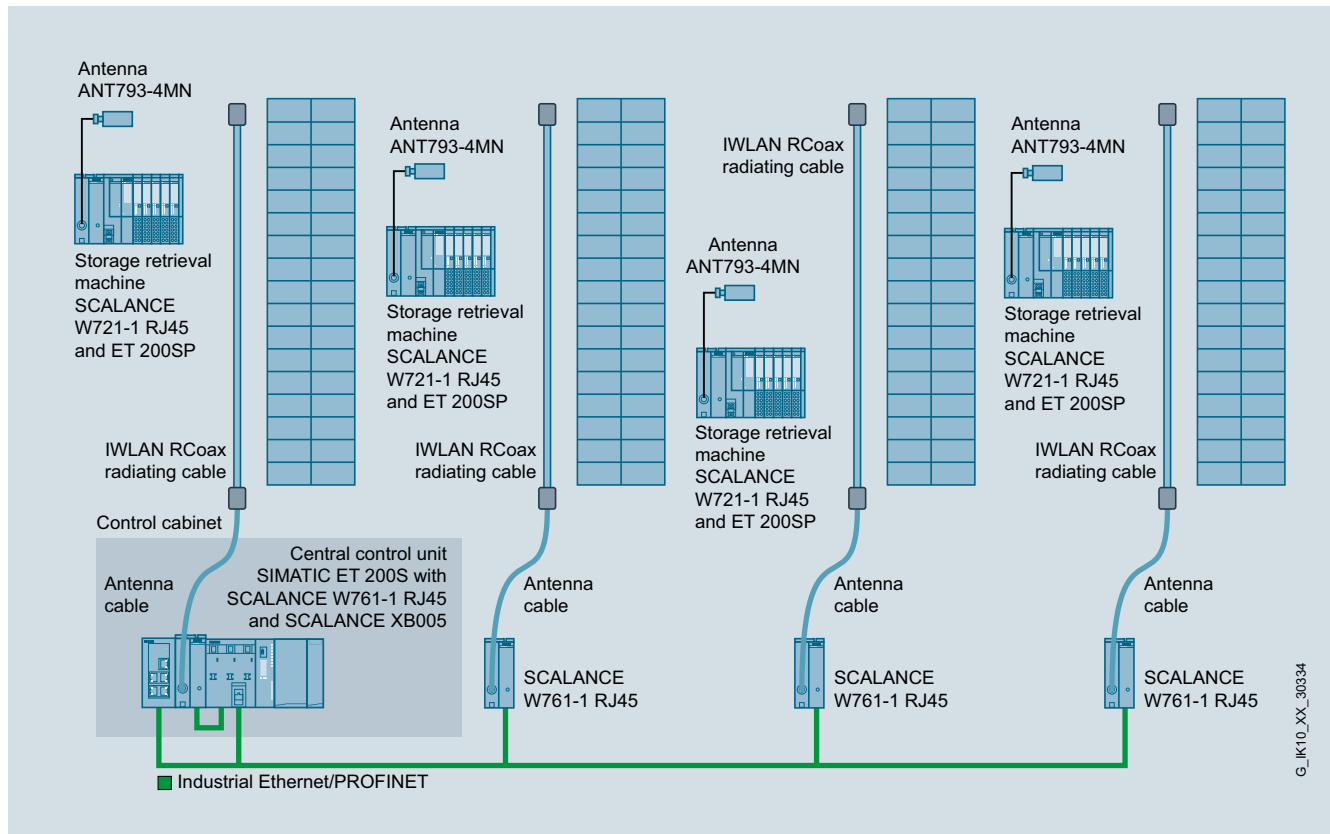

Storage and retrieval systems in high-bay warehouses automated with SCALANCE W721-1 RJ45, W761-1 RJ45 and RCoax

# Industrial Wireless Communication

## IWLAN – Accessories

### IWLAN RCoax cables

#### Integration

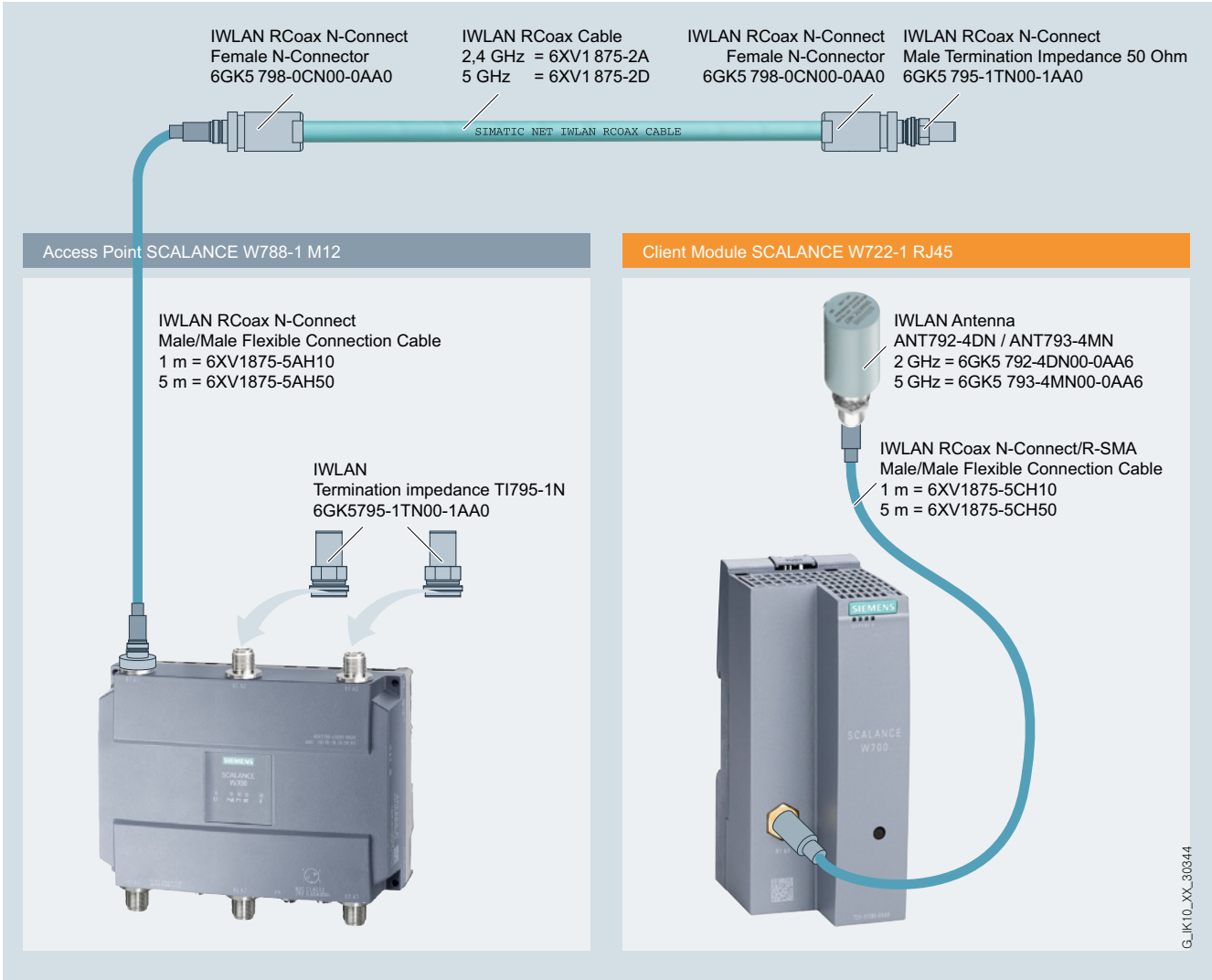

Connection example for an IWLAN RCoax system with connection to Industrial Ethernet

**Technical specifications**

Article No.	6XV1875-2A	6XV1875-2D
Product-type designation	IWLAN RCoax Cable 2 GHz	IWLAN RCoax Cable 5 GHz
Suitability for installation	Suspended monorails, cranes, stacker cranes, or similar	Suspended monorails, cranes, stacker cranes, or similar
<b>Wireless frequencies</b>		
Radio frequency		
• for WLAN in 2.4 GHz frequency band	2.4 ... 2.485 GHz	-
• for WLAN in 5 GHz frequency band 1	-	5.15 ... 5.85 GHz
• for WLAN in 5 GHz frequency band 2	-	-
<b>Electrical data</b>		
Impedance	50 Ω	50 Ω
Damping ratio per length		
• at 2.4 GHz		
- with cable mounted 10 mm above concrete at 20 °C	0.15 dB/m	-
- with cable mounted 15 mm above the aluminum rail at 20 °C	0.17 dB/m	-
• at 5.15 GHz		
- with cable mounted 10 mm above concrete at 20 °C	-	0.23 dB/m
- with cable mounted 15 mm above the aluminum rail at 20 °C	-	0.24 dB/m
• at 5.85 GHz		
- with cable mounted 10 mm above concrete at 20 °C	-	0.24 dB/m
- with cable mounted 15 mm above the aluminum rail at 20 °C	-	0.27 dB/m
Damping ratio per length note	-	-
Coupling attenuation		
• at 2.4 GHz at 20 °C	35 dB	-
• at 5.15 GHz at 20 °C	-	42 dB
• at 5.85 GHz at 20 °C	-	40 dB
• note	c(50) for distance of 10 cm between antenna and cable	c(50) for distance of 10 cm between antenna and cable
Capacitance per length	76 pF/m	76 pF/m
DC resistance per length		
• of inner conductor at 20 °C	1.48 Ω/km	1.48 Ω/km
• of coaxial outer conductor at 20 °C	2.8 Ω/km	2.8 Ω/km
Relative speed	88 %	88 %
<b>Mechanical data</b>		
Outer diameter		
• of the inner conductor	4.8 mm	4.8 mm
• of dielectric	12.4 mm	12.4 mm
• of the cable sheath	15.5 mm	15.5 mm
Thickness of the cable sheath	1.3 mm	1.3 mm
Material		
• of the cable sheath	Halogen-free polyolefine AM3	Halogen-free polyolefine AM3
• of inner conductor	Copper clad aluminum	Copper clad aluminum
• of dielectric	Polyethylene foam	Polyethylene foam
• of coaxial outer conductor	Overlapping copper foil with the slot groups bonded to cable jacket	Overlapping copper foil with the slot groups bonded to cable jacket
Color of the cable sheath	pastel turquoise	pastel turquoise
Bending radius		
• with single bend minimum permissible	200 mm	200 mm
• with multiple bends minimum permissible	-	-
Number of bending cycles	1	1
• Note	-	-
Traction stress maximum	1 100 N	1 100 N
Weight per length	0.232 kg/m	0.232 kg/m
Mounting distance recommended	0.5 m	0.5 m

# Industrial Wireless Communication

## IWLAN – Accessories

### IWLAN RCoax cables

#### Technical specifications (continued)

Article No.	6XV1875-2A	6XV1875-2D
<b>Product-type designation</b>	<b>IWLAN RCoax Cable 2 GHz</b>	<b>IWLAN RCoax Cable 5 GHz</b>
<b>Permitted ambient conditions</b>		
Ambient temperature		
• during operating	-40 ... +85 °C	-40 ... +85 °C
• during storage	-70 ... +85 °C	-70 ... +85 °C
• during installation	-25 ... +60 °C	-25 ... +60 °C
Protection class IP	-	-
<b>Product properties, functions, components general</b>		
Product feature silicon-free	-	-
<b>Standards, specifications, approvals</b>		
Verification of suitability		
• RoHS conformity	-	-
• UL approval	Yes	Yes
- note	-	-
Wireless approval	Current national approvals can be found on the Internet under <a href="http://www.siemens.com/wireless-approvals">www.siemens.com/wireless-approvals</a>	Current national approvals can be found on the Internet under <a href="http://www.siemens.com/wireless-approvals">www.siemens.com/wireless-approvals</a>
Standard		
• for behavior in fire: corrosive gas emission	IEC 60754-2	IEC 60754-2
• for behavior in fire: smoke emission	IEC 60332-1 and IEC 60332-3 Cat. C	IEC 60332-1 and IEC 60332-3 Cat. C
• for behavior in fire: flame resistance	IEC 61034	IEC 61034

#### Ordering data

	Article No.		Article No.
<b>IWLAN RCoax cables</b>		<b>RCoax N-Connect male/male Coupler</b>	<b>6GK5798-0CP00-1AA0</b>
Radiating cable for complex radio environments as special antenna for SCALANCE W Access Points; for extended temperature range (-40 °C to + 85 °C); sold by the meter minimum order quantity 20 m		RF coupling for connecting an RCoax antenna to an RCoax cable; two N-Connect male connectors	
• 2.4 GHz	<b>6XV1875-2A</b>	<b>IWLAN RCoax cable clip 1/2"</b>	
• 5 GHz	<b>6XV1875-2D</b>	Cable holder for RCoax cable	
		• 10 items	<b>6GK5798-8MB00-0AC1</b>
<b>Accessories</b>		• 100 items	<b>6GK5798-8MB00-0AM1</b>
<b>IWLAN RCoax N-Connect stripping tool</b>	<b>6GK1901-1PH00</b>	<b>IWLAN RCoax threaded washer M6</b>	
Stripping tool for fast stripping of RCoax cable on site		Threaded washer M6 for RCoax cable clip 1/2", for assembly with M6 threaded bolts	
<b>RCoax N-Connect female N-connector</b>	<b>6GK5798-0CN00-0AA0</b>	• 10 items	<b>6GK5798-8MC00-0AC1</b>
Plug connector for assembly on site; connection unit of RCoax cable for connection of further components, N-female connection.		• 100 items	<b>6GK5798-8MC00-0AM1</b>
		<b>IWLAN RCoax spacer 85 mm</b>	
		Spacer 85 mm for RCoax cable clip 1/2"	
		• 10 items	<b>6GK5798-8MD00-0AC1</b>
		• 100 items	<b>6GK5798-8MD00-0AM1</b>

#### More information

##### Selection tools:

To assist in selecting Industrial Ethernet components, the TIA Selection Tool is available at:  
<http://www.siemens.com/tia-selection-tool>

##### Wireless approvals:

Current approvals can be found on the Internet at:  
<http://www.siemens.com/wireless-approvals>

### Overview

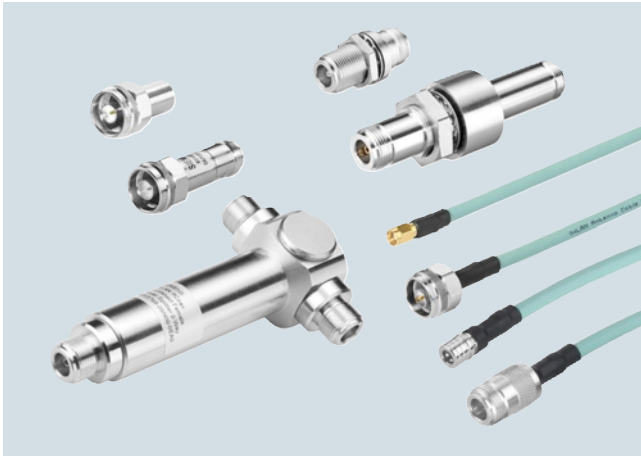

A comprehensive, coordinated range of coaxial accessories is offered for flexible combination and installation of the individual IWLAN components indoors and outdoors.

This range encompasses connecting cables as well as diverse connectors, lightning protection elements, a power splitter and an attenuator.

### Benefits

**get** Designed for Industry

- Flexible use thanks to extensive, coordinated range
- Operation also outdoors with extended temperature range and protection against water and dust thanks to degree of protection IP65
- Components are suitable for use with SCALANCE W700 including national approvals

### Application

#### **RCoax/antenna connecting cables**

- The flexible IWLAN RCoax/antenna connecting cables are required for connecting RCoax segments or antennas with active devices.
- The cables offer low attenuation so that the quality of the radio signal is only reduced to a minimal extent.
- All antenna cables are flame-resistant, chemical-resistant and silicone-free.

#### **Terminating resistors**

- Terminating resistors are required for wireless termination of unused antenna connections at the access points and clients.
- RCoax segments must be terminated at the end with a terminating resistor.

#### **Lightning protection elements**

- When separate antennas are used outdoors, there is a risk of lightning strikes.
- A lightning protector can be used to prevent damage.

#### **Cabinet feedthroughs**

Together with the antenna connecting cables, the cabinet feedthroughs enable simple connection of remote antennas to the active components located in the control cabinet/box.

#### **Attenuator**

The 10 dB attenuator is always used when the transmitted power has to be reduced both in the send and receive directions. Typical application areas include short RCoax segments or directional wireless links, which are to be limited in extent.

#### **Power splitter**

- With the help of the power splitter, the transmission power of an access point is divided between two RCoax or antenna segments.
- This enables wireless coverage in two areas using just one access point.

#### **Product versions**

##### **RCoax/antenna connecting cables**

- Pre-assembled cable lengths (0.3 m to 10 m)
- Different connector types and combinations (N-Connect, R-SMA, SMA, QMA)

##### **Terminating resistors**

- TI795-1R: Terminating resistor 50 ohms for R-SMA antenna sockets
- TI795-1N: Terminating resistor 50 ohms for N-Connect antenna sockets or RCoax segments

##### **Lightning protection elements**

- LP798-2N: Maintenance-free lightning protection element for N-Connect connections
  - Quarter-wave system (lambda-quarter) for the frequency range 2 to 6 GHz
  - Represents a short-circuit for DC voltages so that all types of overvoltage can be reliably diverted
  - Not suitable for DC infeed via the antenna cable
- LP798-1N: Lightning protection element for N-Connect connections
  - With gas discharge arrester for the frequency range 0 to 6 GHz for N-Connect connections
  - Suitable for DC infeed via the antenna cable

##### **Cabinet feedthroughs**

- N-Connect female/SMA female with fastening flange for panel thicknesses up to 5.5 mm
- N-Connect female/N-Connect female without flange for panel thicknesses up to 4.5 mm
  - Can also be used to connect two antenna connecting cables

# Industrial Wireless Communication

## IWLAN – Accessories

### IWLAN cabling technology

#### Technical specifications

Article No.	6XV1875-5AH10	6XV1875-5AH20	6XV1875-5AH50	6XV1875-5AN10
Product-type designation	IWLAN RCoax/Antenna Connection Cable N-Connect Male/ Male	IWLAN RCoax/Antenna Connection Cable N-Connect Male/ Male	IWLAN RCoax/Antenna Connection Cable N-Connect Male/ Male	IWLAN RCoax/Antenna Connection Cable N-Connect Male/ Male
Acceptability for application	Flexible connecting cable for connecting an antenna or RCoax cable to an access point/client	Flexible connecting cable for connecting an antenna or RCoax cable to an access point/client	Flexible connecting cable for connecting an antenna or RCoax cable to an access point/client	Flexible connecting cable for connecting an antenna or RCoax cable to an access point/client
Cable length	1 m	2 m	5 m	10 m
<b>Electrical data</b>				
Number of electrical connections	2	2	2	2
Design of the electrical connection	N-Connect/N-Connect male/male	N-Connect/N-Connect male/male	N-Connect/N-Connect male/male	N-Connect/N-Connect male/male
Transmission frequency	0 ... 6 GHz	0 ... 6 GHz	0 ... 6 GHz	0 ... 6 GHz
<b>Attenuation per length</b>				
• at 2.4 GHz typical	0.53 dB/m	0.53 dB/m	0.53 dB/m	0.53 dB/m
• at 5.2 GHz typical	0.83 dB/m	0.83 dB/m	0.83 dB/m	0.83 dB/m
• at 5.85 GHz typical	0.89 dB/m	0.89 dB/m	0.89 dB/m	0.89 dB/m
Return loss minimum	23 dB	23 dB	23 dB	23 dB
Impedance Nominal value	50 Ω	50 Ω	50 Ω	50 Ω
Capacity per length at 1 kHz	82 pF/m	82 pF/m	82 pF/m	82 pF/m
Relative speed	82 %	82 %	82 %	82 %
<b>Mechanical data</b>				
Design of shield	Braided shield made of tin-plated copper wires	Braided shield made of tin-plated copper wires	Braided shield made of tin-plated copper wires	Braided shield made of tin-plated copper wires
Outer diameter				
• of the inner conductor	1.4 mm	1.4 mm	1.4 mm	1.4 mm
• of dielectric	3.8 mm	3.8 mm	3.8 mm	3.8 mm
• of the cable sheath	6.3 mm	6.3 mm	6.3 mm	6.3 mm
Symmetrical tolerance of outer diameter of cable sheath	0.2 mm	0.2 mm	0.2 mm	0.2 mm
Thickness of the cable sheath	0.76 mm	0.76 mm	0.76 mm	0.76 mm
Material				
• of inner conductor	Cu	Cu	Cu	Cu
• of dielectric	polyethylene foam	polyethylene foam	polyethylene foam	polyethylene foam
• of the cable sheath	FRNC	FRNC	FRNC	FRNC
Color of the cable sheath	Pastel turquoise	Pastel turquoise	Pastel turquoise	Pastel turquoise
Bending radius				
• with single bend minimum permissible	32 mm	32 mm	32 mm	32 mm
• with multiple bends minimum permissible	45 mm	45 mm	45 mm	45 mm
Traction stress maximum	80 N	80 N	80 N	80 N
Weight per length	75 kg/km	75 kg/km	75 kg/km	75 kg/km
<b>Permitted ambient conditions</b>				
Ambient temperature				
• during operating	-40 ... +80 °C	-40 ... +80 °C	-40 ... +80 °C	-40 ... +80 °C
• during storage	-40 ... +80 °C	-40 ... +80 °C	-40 ... +80 °C	-40 ... +80 °C
• during transport	-40 ... +80 °C	-40 ... +80 °C	-40 ... +80 °C	-40 ... +80 °C
• during installation	-25 ... +80 °C	-25 ... +80 °C	-25 ... +80 °C	-25 ... +80 °C
Protection class IP	IP68	IP68	IP68	IP68
Protection class IP note	when plugged in	when plugged in	when plugged in	when plugged in
Burning behaviour	UL 1685 (Vertical tray) and UL 1581, Sec. 1090 (H)	UL 1685 (Vertical tray) and UL 1581, Sec. 1090 (H)	UL 1685 (Vertical tray) and UL 1581, Sec. 1090 (H)	UL 1685 (Vertical tray) and UL 1581, Sec. 1090 (H)
Chemical resistance to mineral oil	Conditional resistance	Conditional resistance	Conditional resistance	Conditional resistance
Radiological resistance to UV radiation	Resistant	Resistant	Resistant	Resistant



### Technical specifications (continued)

Article No.	6XV1875-5AH10	6XV1875-5AH20	6XV1875-5AH50	6XV1875-5AN10
<b>Product-type designation</b>	<b>IWLAN RCoax/Antenna Connection Cable N-Connect Male/ Male</b>	<b>IWLAN RCoax/Antenna Connection Cable N-Connect Male/ Male</b>	<b>IWLAN RCoax/Antenna Connection Cable N-Connect Male/ Male</b>	<b>IWLAN RCoax/Antenna Connection Cable N-Connect Male/ Male</b>
<b>Product properties, functions, components general</b>				
Product feature				
• halogen-free	Yes	Yes	Yes	Yes
• silicon-free	Yes	Yes	Yes	Yes
<b>Standards, specifications, approvals</b>				
Verification of suitability				
• UL-registration	-	-	-	-
• RoHS conformity	Yes	Yes	Yes	Yes

Article No.	6XV1875-5CE30	6XV1875-5CH10	6XV1875-5CH20	6XV1875-5CH50	6XV1875-5CN10
<b>Product-type designation</b>	<b>IWLAN RCoax/Antenna Connection Cable N-Connect RSMA Male/Male</b>	<b>IWLAN RCoax/Antenna Connection Cable N-Connect/RSMA Male/ Male</b>	<b>IWLAN RCoax/Antenna Connection Cable N-Connect/RSMA Male/ Male</b>	<b>IWLAN RCoax/Antenna Connection Cable N-Connect/RSMA Male/ Male</b>	<b>IWLAN RCoax/Antenna Connection Cable N-Connect/RSMA Male/ Male</b>
Acceptability for application	Flexible connecting cable for connecting an antenna or RCoax cable to an access point/client	Flexible connecting cable for connecting an antenna or RCoax cable to an access point/client	Flexible connecting cable for connecting an antenna or RCoax cable to an access point/client	Flexible connecting cable for connecting an antenna or RCoax cable to an access point/client	Flexible connecting cable for connecting an antenna or RCoax cable to an access point/client
Cable length	0.3 m	1 m	2 m	5 m	10 m
<b>Electrical data</b>					
Number of electrical connections	2	2	2	2	2
Design of the electrical connection	N-Connect/RSMA male/male	N-Connect/RSMA male/male	N-Connect/RSMA male/male	N-Connect/RSMA male/male	N-Connect/RSMA male/male
Transmission frequency	0 ... 6 GHz	0 ... 6 GHz	0 ... 6GHz	0 ... 6 GHz	0 ... 6 GHz
<b>Attenuation per length</b>					
• at 2.4 GHz typical	0.53 dB/m	0.53 dB/m	0.53 dB/m	0.53 dB/m	0.53 dB/m
• at 5.2 GHz typical	0.83 dB/m	0.83 dB/m	0.83 dB/m	0.83 dB/m	0.83 dB/m
• at 5.85 GHz typical	0.89 dB/m	0.89 dB/m	0.89 dB/m	0.89 dB/m	0.89 dB/m
Return loss minimum	23 dB	23 dB	23 dB	23 dB	23 dB
Impedance Nominal value	50 Ω	50 Ω	50 Ω	50 Ω	50 Ω
Capacity per length at 1 kHz	82 pF/m	82 pF/m	82 pF/m	82 pF/m	82 pF/m
Relative speed	82 %	82 %	82 %	82 %	82 %
<b>Mechanical data</b>					
Design of shield	Braided shield made of tin-plated copper wires	Braided shield made of tin-plated copper wires	Braided shield made of tin-plated copper wires	Braided shield made of tin-plated copper wires	Braided shield made of tin-plated copper wires
Outer diameter					
• of the inner conductor	1.4 mm	1.4 mm	1.4 mm	1.4 mm	1.4 mm
• of dielectric	3.8 mm	3.8 mm	3.8 mm	3.8 mm	3.8 mm
• of the cable sheath	6.3 mm	6.3 mm	6.3 mm	6.3 mm	6.3 mm
Symmetrical tolerance of outer diameter of cable sheath	0.2 mm	0.2 mm	0.2 mm	0.2 mm	0.2 mm
Thickness of the cable sheath	0.76 mm	0.76 mm	0.76 mm	0.76 mm	0.76 mm
Material					
• of inner conductor	Cu	Cu	Cu	Cu	Cu
• of dielectric	polyethylene foam	polyethylene foam	polyethylene foam	polyethylene foam	polyethylene foam
• of the cable sheath	FRNC	FRNC	FRNC	FRNC	FRNC
Color of the cable sheath	Pastel turquoise	Pastel turquoise	Pastel turquoise	Pastel turquoise	Pastel turquoise

# Industrial Wireless Communication

## IWLAN – Accessories

### IWLAN cabling technology

#### Technical specifications (continued)

Article No.	6XV1875-5CE30	6XV1875-5CH10	6XV1875-5CH20	6XV1875-5CH50	6XV1875-5CN10
<b>Product-type designation</b>	<b>IWLAN RCoax/ Antenna Connection Cable N-Connect RSMA Male/Male</b>	<b>IWLAN RCoax/ Antenna Connection Cable N-Connect/ RSMA Male/ Male</b>	<b>IWLAN RCoax/ Antenna Connection Cable N-Connect/ RSMA Male/ Male</b>	<b>IWLAN RCoax/ Antenna Connection Cable N-Connect/ RSMA Male/ Male</b>	<b>IWLAN RCoax/ Antenna Connection Cable N-Connect/ RSMA Male/ Male</b>
Bending radius					
• with single bend minimum permissible	32 mm	32 mm	32 mm	32 mm	32 mm
• with multiple bends minimum permissible	45 mm	45 mm	45 mm	45 mm	45 mm
Traction stress maximum	80 N	80 N	80 N	80 N	80 N
Weight per length	75 kg/km	75 kg/km	75 kg/km	75 kg/km	75 kg/km
<b>Permitted ambient conditions</b>					
Ambient temperature					
• during operating	-40 ... +80 °C	-40 ... +80 °C	-40 ... +80 °C	-40 ... +80 °C	-40 ... +80 °C
• during storage	-40 ... +80 °C	-40 ... +80 °C	-40 ... +80 °C	-40 ... +80 °C	-40 ... +80 °C
• during transport	-40 ... +80 °C	-40 ... +80 °C	-40 ... +80 °C	-40 ... +80 °C	-40 ... +80 °C
• during installation	-25 ... +80 °C	-25 ... +80 °C	-25 ... +80 °C	-25 ... +80 °C	-25 ... +80 °C
Protection class IP	IP68	IP68	IP68	IP68	IP68
Protection class IP note	when plugged in	when plugged in	when plugged in	when plugged in	when plugged in
Burning behaviour	UL 1685 (Vertical tray) and UL 1581, Sec. 1090 (H)	UL 1685 (Vertical tray) and UL 1581, Sec. 1090 (H)	UL 1685 (Vertical tray) and UL 1581, Sec. 1090 (H)	UL 1685 (Vertical tray) and UL 1581, Sec. 1090 (H)	UL 1685 (Vertical tray) and UL 1581, Sec. 1090 (H)
Chemical resistance to mineral oil	Conditional resistance	Conditional resistance	Conditional resistance	Conditional resistance	Conditional resistance
Radiological resistance to UV radiation	Resistant	Resistant	Resistant	Resistant	Resistant
<b>Product properties, functions, components general</b>					
Product feature					
• halogen-free	Yes	Yes	Yes	Yes	Yes
• silicon-free	Yes	Yes	Yes	Yes	Yes
<b>Standards, specifications, approvals</b>					
Verification of suitability					
• UL-registration	-	-	-	-	-
• RoHS conformity	Yes	Yes	Yes	Yes	Yes

Article No.	6XV1875-5DE30	6XV1875-5DH20	6XV1875-5JH10
<b>Product-type designation</b>	<b>IWLAN RCoax/Antenna Connection Cable RSMA/SMA Male/ Male</b>	<b>IWLAN RCoax/Antenna Connection Cable RSMA/SMA Male/ Male</b>	<b>IWLAN Cable QMA / N-Connect Male/Female</b>
Acceptability for application	Flexible connecting cable for connecting a cabinet bushing with SMA connection to an access point/client	Flexible connecting cable for connecting a cabinet bushing with SMA connection to an access point/client	Adapter cable for connecting an antenna with QMA connection to the flexible connecting cables
Cable length	0.3 m	2 m	1 m
<b>Electrical data</b>			
Number of electrical connections	2	2	2
Design of the electrical connection	RSMA/ SMA male/male	RSMA/ SMA male/male	QMA/N-Connect male/female
Transmission frequency	0 ... 6 GHz	0 ... 6 GHz	0 ... 6 GHz
<b>Attenuation per length</b>			
• at 2.4 GHz typical	0.53 dB/m	0.53 dB/m	0.53 dB/m
• at 5.2 GHz typical	0.83 dB/m	0.83 dB/m	0.83 dB/m
• at 5.85 GHz typical	0.89 dB/m	0.89 dB/m	0.89 dB/m
Return loss minimum	23 dB	23 dB	23 dB
Impedance Nominal value	50 Ω	50 Ω	50 Ω
Capacity per length at 1 kHz	82 pF/m	82 pF/m	82 pF/m
Relative speed	82 %	82 %	82 %

### Technical specifications (continued)

Article No.	6XV1875-5DE30	6XV1875-5DH20	6XV1875-5JH10
Product-type designation	IWLAN RCoax/Antenna Connection Cable RSMA/SMA Male/ Male	IWLAN RCoax/Antenna Connection Cable RSMA/SMA Male/ Male	IWLAN Cable QMA / N-Connect Male/Female
<b>Mechanical data</b>			
Design of shield	Braided shield made of tin-plated copper wires	Braided shield made of tin-plated copper wires	Braided shield made of tin-plated copper wires
Outer diameter			
• of the inner conductor	1.4 mm	1.4 mm	1.4 mm
• of dielectric	3.8 mm	3.8 mm	3.8 mm
• of the cable sheath	6.3 mm	6.3 mm	6.3 mm
Symmetrical tolerance of outer diameter of cable sheath	0.2 mm	0.2 mm	0.2 mm
Thickness of the cable sheath	0.76 mm	0.76 mm	0.76 mm
Material			
• of inner conductor	Cu	Cu	Cu
• of dielectric	polyethylene foam	polyethylene foam	polyethylene foam
• of the cable sheath	FRNC	FRNC	FRNC
Color of the cable sheath	Pastel turquoise	Pastel turquoise	Pastel turquoise
Bending radius			
• with single bend minimum permissible	32 mm	32 mm	32 mm
• with multiple bends minimum permissible	45 mm	45 mm	45 mm
Traction stress maximum	80 N	80 N	80 N
Weight per length	75 kg/km	75 kg/km	75 kg/km
<b>Permitted ambient conditions</b>			
Ambient temperature			
• during operating	-40 ... +80 °C	-40 ... +80 °C	-40 ... +80 °C
• during storage	-40 ... +80 °C	-40 ... +80 °C	-40 ... +80 °C
• during transport	-40 ... +80 °C	-40 ... +80 °C	-40 ... +80 °C
• during installation	-25 ... +80 °C	-25 ... +80 °C	-25 ... +80 °C
Protection class IP	IP68	IP68	IP67
Protection class IP note	when plugged in	when plugged in	when plugged in
Burning behaviour	UL 1685 (Vertical tray) and UL 1581, Sec. 1090 (H)	UL 1685 (Vertical tray) and UL 1581, Sec. 1090 (H)	UL 1685 (Vertical tray) and UL 1581, Sec. 1090 (H)
Chemical resistance to mineral oil	Conditional resistance	Conditional resistance	Conditional resistance
Radiological resistance to UV radiation	Resistant	Resistant	Resistant
<b>Product properties, functions, components general</b>			
Product feature			
• halogen-free	Yes	Yes	Yes
• silicon-free	Yes	Yes	Yes
<b>Standards, specifications, approvals</b>			
Verification of suitability			
• UL-registration	-	-	-
• RoHS conformity	Yes	Yes	Yes

## Industrial Wireless Communication

### IWLAN – Accessories

#### IWLAN cabling technology

#### Technical specifications (continued)

Article No.	6GK5795-1TN00-1AA0	6GK5795-1TR10-0AA6	6GK5798-0AP00-4CA0	6GK5798-0SN00-0EA0
Product-type designation	IWLAN termination impedance TI795-1N N-Connect Male	IWLAN termination impedance TI795-1R RSMA Male	IWLAN attenuator N-Connect Male/Female	IWLAN Power Splitter N-Connect Female
<b>Supply voltage, current consumption, power loss</b>				
Type of supply voltage	-	-	-	-
Supply voltage for DC	-	-	-	-
Consumed current maximum	-	-	-	-
Active power loss maximum	-	-	-	-
<b>Electrical data</b>				
Number of electrical connections	1	1	2	3
Design of the electrical connection	N-Connect male	R-SMA male	N-Connect male/ N-Connect female	N-Connect female
Transmission frequency	0 ... 6 GHz	0 ... 6 GHz	0 ... 6 GHz	2 400 ... 6 GHz
Impedance	50 Ω	50 Ω	50 Ω	50 Ω
Return loss minimum	25 dB	25 dB	-	24 dB
Insertion loss maximum	-	-	10 dB	3.05 dB
<b>Permitted ambient conditions</b>				
Ambient temperature				
• during operating	-40 ... +70 °C	-40 ... +70 °C	-40 ... +70 °C	-25 ... +110 °C
• during storage	-40 ... +70 °C	-40 ... +70 °C	-40 ... +70 °C	-25 ... +110 °C
• during transport	-40 ... +70 °C	-40 ... +70 °C	-40 ... +70 °C	-25 ... +110 °C
Relative humidity at 25 °C without condensation during operating maximum				
Protection class IP	IP 65	IP 65	-	IP 67
<b>Design, dimensions and weight</b>				
Design	-	-	-	-
Width	-	-	-	71.4 mm
Height	-	-	-	-
Depth	-	-	-	34 mm
Diameter	21 mm	9 mm	21 mm	-
Length	34.5 mm	15 mm	45.7 mm	131.4 mm
Net weight	45 g	5 g	64 g	937 g
Installation	-	-	-	-
Version of the swap medium				
• C-PLUG	-	-	-	-
• KEY-PLUG	-	-	-	-

## Technical specifications (continued)

Article No.	6GK5798-2LP00-2AA6	6GK5798-2LP10-2AA6
<b>Product-type designation</b>	<b>Lightning Protector LP798-1N</b>	<b>Lightning Protector LP798-2N</b>
<b>Electrical data</b>		
Impedance	50 Ω	50 Ω
<b>Mechanical data</b>		
Design of the plug-in connection	female / female	female / female
Ambient temperature		
• during operating	-40 ... +85 °C	-40 ... +85 °C
• during storage	-40 ... +85 °C	-40 ... +85 °C
• during transport	-40 ... +85 °C	-40 ... +85 °C
Protection class IP	IP67	IP68
<b>Design, dimensions and weight</b>		
Width	54.8 mm	89.6 mm
Height	-	-
Depth	-	-
Diameter	22.8 mm	29 mm
Net weight	50 g	80 g

Article No.	6GK5798-0PT00-2AA0	6GK5798-2PP00-2AA6	6GK5798-0CP00-1AA0	6GK5798-1CS00-4AA0
<b>Product-type designation</b>	<b>IWLAN panel feedthrough N-Connect/SMA Female/Female</b>	<b>IWLAN panel feedthrough N-Connect/N-Connect Female/Female</b>	<b>IWLAN coupler N-Connect-Male/Male</b>	<b>IWLAN angled adapter RSMA/RSMA male/female</b>
<b>Electrical data</b>				
Number of electrical connections	2	2	2	2
Design of the electrical connection	N-Connect female/SMA female	N-Connect female/N-Connect female	N-Connect male/N-Connect male	R-SMA male / R-SMA female
Transmission frequency	0 ... 6 GHz	0 ... 11 000 MHz	0 ... 6 GHz	0 ... 6 GHz
Impedance	50 Ω	50 Ω	50 Ω	50 Ω
Return loss minimum	-	-	0.1 dB	-
Insertion loss maximum	-	-	-	-
<b>Permitted ambient conditions</b>				
Ambient temperature				
• during operating	-40 ... +70 °C	-30 ... +100 °C	-40 ... +70 °C	-
• during storage	-40 ... +70 °C	-30 ... +100 °C	-40 ... +70 °C	-
• during transport	-40 ... +70 °C	-30 ... +100 °C	-40 ... +70 °C	-
Relative humidity at 25 °C without condensation during operating maximum				-
Protection class IP	-	IP 68	-	-
<b>Design, dimensions and weight</b>				
Design	-	-	-	-
Width	25.4 mm	-	-	17 mm
Height	25.4 mm	-	-	15 mm
Depth	-	-	-	-
Diameter	-	20.7 mm	20.8 mm	-
Length	31.3 mm	38 mm	36.4 mm	-
Net weight	35 g	55 g	60 g	-
Installation	for wall thickness max. 5.5 mm	for wall thickness max. 4.5 mm	-	-

# Industrial Wireless Communication

## IWLAN – Accessories

### IWLAN cabling technology

Ordering data	Article No.	Article No.	
<b>IWLAN RCoax/antenna N-Connect/R-SMA Male/male flexible connection cable</b> Flexible connecting cable for connecting an RCoax cable or antenna to a SCALANCE W-700 access point with R-SMA connections; pre-assembled with two connections, N-Connect male and R-SMA male <ul style="list-style-type: none"> <li>• 0.3 m</li> <li>• 1 m</li> <li>• 2 m</li> <li>• 5 m</li> <li>• 10 m</li> </ul>	<b>6XV1875-SCE30</b> <b>6XV1875-SCH10</b> <b>6XV1875-SCH20</b> <b>6XV1875-SCH50</b> <b>6XV1875-SCN10</b>	<b>IWLAN RCoax/antenna RSMA male termination impedance TI795-1R</b> Terminating resistor for open wireless interfaces on SCALANCE W-700 devices with RSMA connections, impedance 50 ohms, RSMA male connection; IP65 (-40 to +70 °C); 3 units	<b>6GK5795-1TR10-0AA6</b>
<b>IWLAN RCoax/antenna N-Connect male/male Flexible connection cable</b> Flexible connecting cable for connecting an RCoax cable or antenna to a SCALANCE W-700 access point with N-Connect connections; pre-assembled with two N-Connect male connections <ul style="list-style-type: none"> <li>• 1 m</li> <li>• 2 m</li> <li>• 5 m</li> <li>• 10 m</li> </ul>	<b>6XV1875-5AH10</b> <b>6XV1875-5AH20</b> <b>6XV1875-5AH50</b> <b>6XV1875-5AN10</b>	<b>Lightning protector LP798-1N</b> Lightning protector with N/N female/female connection, IP67 (-40 to +85 °C), frequency range: 0 to 6 GHz	<b>6GK5798-2LP00-2AA6</b>
<b>IWLAN RCoax/antenna N-Connect male/female Flexible connection cable</b> Adapter cable for connecting a MIMO antenna with QMA connections to the flexible connecting cables; assembled with two connections QMA male and N-Connect female; scope of delivery: 3 units <ul style="list-style-type: none"> <li>• 1 m</li> </ul>	<b>6XV1875-5JH10</b>	<b>Lightning protector LP798-2N</b> Lightning protector with N/N female/female connection, IP68 (-40 to +85 °C), Quarter Wave technology, frequency range: 2 to 6 GHz	<b>6GK5798-2LP10-2AA6</b>
<b>IWLAN RCoax/antenna QMA/N-Connect male/female Flexible connection cable</b> Adapter cable for connecting a MIMO antenna with QMA connections to the flexible connecting cables; assembled with two connections QMA male and N-Connect female; scope of delivery: 3 units <ul style="list-style-type: none"> <li>• 1 m</li> </ul>	<b>6XV1875-5JH10</b>	<b>IWLAN RCoax/antenna N-Connect female power splitter</b> 2-way cable splitter, Y-element for splitting the RCoax cable or for using two antennas on one wireless interface	<b>6GK5798-0SN00-0EA0</b>
<b>IWLAN RCoax/antenna R-SMA/SMA male/male Flexible connection cable</b> Flexible cable for connecting an active device to components with RSMA and SMA connections, e.g. cabinet bushing; pre-assembled with two R-SMA male to SMA male connectors <ul style="list-style-type: none"> <li>• 0.3 m</li> <li>• 2 m</li> </ul>	<b>6XV1875-5DE30</b> <b>6XV1875-5DH20</b>	<b>IWLAN RCoax/antenna N-Connect male/male coupler</b> HF coupling for connecting two RCoax cables; two N-Connect male connectors	<b>6GK5798-0CP00-1AA0</b>
<b>IWLAN RCoax/antenna N-Connect male termination impedance TI795-1N</b> Terminating resistor for RCoax cable and open wireless interfaces on SCALANCE W-700 devices with N-Connect connections, impedance 50 ohms, N-male connection; IP65 (-40 to +70 °C)	<b>6GK5795-1TN00-1AA0</b>	<b>IWLAN angled adapter RSMA/RSMA male/female</b> HF angled adapter 90 for connecting antennas or antenna connection cables to devices with an RSMA connector	<b>6GK5798-1CS00-4AA0</b>
		<b>IWLAN RCoax/antenna N-Connect male/female attenuator</b> Attenuator with N-Connect male/N-Connect female connectors <ul style="list-style-type: none"> <li>• 10 dB</li> </ul>	<b>6GK5798-0AP00-4CA0</b>
		<b>IWLAN RCoax/antenna N-Connect/SMA female/female panel bushing</b> Cabinet bushing with fastening flange for wall thicknesses up to 5.5 mm, SMA female and N-Connect female connections	<b>6GK5798-0PT00-2AA0</b>
		<b>IWLAN RCoax/antenna N-Connect/N-Connect female/female panel bushing</b> Cabinet bushing for wall thicknesses up to 4.5 mm, two N-Connect female connections	<b>6GK5798-2PP00-2AA6</b>

**More information**

**Selection tools:**

To assist in selecting Industrial Ethernet components, the TIA Selection Tool is available at:  
<http://www.siemens.com/tia-selection-tool>

**Cabling range:**

You can order components supplementary to the SIMATIC NET cabling range from your local contact. Technical advice on this subject is available from:

J. Hertlein  
I IA SC CI PRM 4  
Phone +49 (911) 750-4465  
E-mail: [juergen.hertlein@siemens.com](mailto:juergen.hertlein@siemens.com)

## Industrial Wireless Communication

### IWLAN – Accessories

#### KEY-PLUG W700

##### Overview



- Swap medium with which iFeatures are enabled
- If a fault occurs, it allows fast and simple device replacement of SCALANCE W components without a PG
- Can be used in all SCALANCE W700 IEEE 802.11n products with a PLUG compartment
- For the automatic backup of configuration data

##### Benefits

- Fast and simple replacement of SCALANCE W components without reconfiguration of the spare part.
- The device can be replaced without the need for specially trained personnel or a programming device or PC.
- The downtimes of network segments and connected Industrial Ethernet nodes can therefore be minimized if a fault occurs.

##### Application

The KEY-PLUG stores the configuration data of a SCALANCE W component. In addition, the iFeatures are enabled.

In addition to this, if there is a fault on a module, the module can be replaced simply and quickly without needing to reconfigure the replacement device and without specially trained personnel. If a device needs to be replaced, the KEY-PLUG is simply removed from the failed component and plugged into the replacement device. The replacement device installed in the network now starts up automatically with the same device configuration as the failed device.

##### Design

The KEY-PLUG has degree of protection IP20. The degree of protection of IP65 components is ensured by the design of the target device. The KEY-PLUG is inserted in the PLUG compartment of the SCALANCE W component.

##### Mode of operation

During startup, the device automatically backs up the configuration data on a KEY-PLUG (as-supplied from the factory) plugged into a SCALANCE W component. Changes to the configuration during operation are also saved on the KEY-PLUG without any additional operator intervention being necessary.

During startup, an unconfigured device automatically loads the configuration data from an inserted KEY-PLUG that has been written to provided the data was written by a compatible device type.

##### Diagnostics

Incorrect use of the KEY-PLUG, such as inserting a KEY-PLUG containing the configuration of a different device group or general malfunctions of the KEY-PLUG are indicated by diagnostics mechanisms of the host device (LEDs, SNMP, Web based Management, etc.).



**Integration****Supported products****IWLAN access points**

- SCALANCE W780
- SCALANCE W780 EEC
- SCALANCE W770
- SCALANCE W770 EEC

**IWLAN client modules**

- SCALANCE W740
- SCALANCE W730

Device type	iPCF AP mode	iPCF Client mode	iPCF-MC AP mode	iPCF-MC Client mode	iREF AP mode
<b>SCALANCE W730</b>		W740/W780		W740/W780	
<b>SCALANCE W740</b>		W740/W780		W740/W780	
<b>SCALANCE W770</b>	W780	W740/W780		W740/W780	W780
<b>SCALANCE W780</b>	W780	W740/W780	W780 <sup>1)</sup>	W740/W780	W780

<sup>1)</sup> only if a dual access point is used

Which KEY-PLUG do I use for which device?

- W780 = KEY-PLUG W780 iFeatures
- W740 = KEY-PLUG W740 iFeatures

**Technical specifications****KEY-PLUG**

Power supply	via terminal device
Power loss	0.015 mW
Installation	Can be plugged into C-PLUG slot
Constructional design	
• Dimensions (W x H x D) in mm	24.3 x 17 x 8.1
• Approx. weight	5 g
Memory capacity	256 MB
Degree of protection	IP20

**Ordering data****Article No.****KEY-PLUG W780 iFeatures**

Swap medium for enabling additional iFeatures, for simple device replacement if a fault occurs, and for storing configuration data. Can be used in SCALANCE W access points with a PLUG compartment

**6GK5907-8PA00****KEY-PLUG W740 iFeatures**

Swap medium for enabling additional iFeatures, for simple device replacement if a fault occurs, and for storing configuration data. Can be used in SCALANCE W client modules with a PLUG compartment

**6GK5907-4PA00**

## Industrial Wireless Communication IWLAN – Accessories

### Power Supply PS791-2DC and PS791-2AC

#### Overview



#### **PS791-2DC power supply adapter**

- DC/DC power supply unit for input voltages from 12 to 24 V DC and an output voltage of 18 V DC for all SCALANCE W786 devices

#### **PS791-2AC power supply adapter**

- AC/DC power supply unit for input voltages from 100 to 240 V AC and an output voltage of 18 V DC for all SCALANCE W786 devices

#### Benefits

get **Designed for Industry**

- The PS791-2DC and PS791-2AC power supply adapters are designed specially for the SCALANCE W786 access points and are integrated direct into these
- Global application due to wide input voltage range
- High reliability as power supply is short-circuit proof, secure against no-load operation and is able to bridge short breaks in the mains power
- When the power supply adapter and Power-over-Ethernet (PoE) are used, redundant power supply of the access points can be achieved

#### Design



- Integral power supply adapter for SCALANCE W786
- Fan-free design
- Operating temperatures from -40 °C to +60 °C
- Resistant to condensation

#### Technical specifications

Article No.	6GK5791-2DC00-0AA0	6GK5791-2AC00-0AA0
Product type designation	Power supply PS791-2DC	Power supply PS791-2AC
Interfaces	<ul style="list-style-type: none"> <li>Infeed: 4-pin screw terminal for DC Power</li> <li>Output voltage: 4-pin connector</li> </ul>	<ul style="list-style-type: none"> <li>Infeed: 3-pin screw terminal for AC Power</li> <li>Output voltage: 4-pin connector</li> </ul>
Input voltage	12 ... 24 V DC (min. 9 V DC, max. 32 V DC) safety extra-low voltage (SELV)	100 ... 240 V AC, 45 ... 65 Hz
Output voltage	18 V DC	18 V DC
Output power	14.4 W	14.4 W
Mains buffering	–	> 20 ms
Permissible ambient conditions		
• Operating temperature	-40 °C ... +70 °C	-40 °C ... +60 °C
Approvals	EMC: EN 61000-6-2:2005, EN 61000-6-3:2007	EMC: EN 61000-6-2:2005, EN 61000-6-3:2007
Safety regulations	EN 60950, UL 60950-1	EN 60950, UL 60950-1
Protection class	VDE 0805, VDE 0100	VDE 0805, VDE 0100
Degree of protection	IP65	IP65
Dimensions (W x H x D) in mm	133 x 45 x 30 mm	133 x 45 x 30 mm
Assembly	Installation in SCALANCE W786 and HiPath Wireless Outdoor Access Points	Installation in SCALANCE W786 and HiPath Wireless Outdoor Access Points
Weight	223 g	209 g

#### Ordering data

#### Article No.

##### Power supply PS791-2DC

24 V DC power supply for installation in SCALANCE W-786 products; operating instructions in German/English

**6GK5791-2DC00-0AA0**

##### Power supply PS791-2AC

110 V AC to 230 V AC power supply for installation in the SCALANCE W-786 products; operating instructions German/English

**6GK5791-2AC00-0AA0**

## Industrial Wireless Communication

### Wireless Devices

#### SIMATIC Mobile Panel 277(F) IWLAN

##### Overview



SIMATIC Mobile Panel 277(F) IWLAN

##### Function

- Input/output fields for displaying and changing of process values.
- Function keys are used for directly triggering functions and actions. Up to 16 functions can be configured simultaneously on function keys. The function keys can also be used directly as PROFINET IO. The function keys can also be reconfigured as system keys. A frequently used function such as "Acknowledge alarm" can thus be assigned to a function key.
- Auxiliary operator controls such as handwheels, key switches and illuminated pushbuttons can be assigned with a variable or as a direct actuation via PROFINET IO (direct keys).
- Buttons are used for direct triggering of functions and actions. Up to 16 functions can be configured simultaneously on buttons.
- Graphics can be used as symbols instead of text for "labeling" function keys or buttons. They can also be used as full-screen background images. In the configuration software, a comprehensive library is available containing graphics and a wide variety of objects. All editors with an OLE interface can be used as graphics editors (such as PaintShop, Designer or CorelDraw).
- Vector graphics; simple geometric basic forms (e.g. lines, circles and rectangles) can be created directly in the configuration software.
- Text fields for labeling function keys, process displays, and process values in any font size.
- Trend views and bars are used for the graphic display of dynamic values.
- Display selection from the controller permits operator prompting from the controller.
- Presentation of HTML documents with MS Pocket Internet Explorer.
- Visual Basic Script, flexibility thanks to the implementation of new functions including linking to variables (comparison operations, loops, etc.).
- Language switching
  - 16 online languages, 32 configuration languages incl. Asiatic and Cyrillic character sets
  - Language-dependent texts and graphics
- User administration (security)
  - User-oriented access protection according to requirements of specific sectors
  - Authentication with user name and password
  - User-group-specific rights
- Signaling system
  - Discrete and analog alarms (edge alarms) as well as the ALARM\_S message frame procedure for SIMATIC S7
  - Freely definable message classes (e.g. status/fault messages) for definition of acknowledgment response and display of alarm events
- Message buffer
  - Non-volatile, maintenance-free and battery-free message buffer. The messages remain stored when the mobile panel has the battery removed as well
- Recipe management
  - With additional data storage (on optional MultiMedia Card/SD Card)
  - Online/offline processing on the panel
  - Storage of recipe data in standard Windows format (CSV)
  - External processing using standard tools such as Excel and Access is possible
- Help texts for process images, messages and variables.
- Arithmetic functions
- Limit value monitoring for reliable process control of inputs and outputs.
- Indicator light for machine and plant status indication.
- Scheduler for cyclic function processing.
- Dynamic positioning of objects and dynamic showing/hiding of objects
- Permanent window and template concept
  - Creation of screen templates
- Simple maintenance and configuration thanks to:
  - Backup and restore of the project, operating system, recipe data records and firmware on the optional standard Multimedia Card/SD Card
  - Backup and restoration of configuration, operating system, recipe data sets and firmware on a PC using ProSave
  - Project transfer/return transfer via PROFINET/WLAN
  - Automatic transfer detection
  - Individual brightness setting
  - Project simulation directly on the configuration computer
- WinCC flexible options
  - Sm@rtService for remote operator control and monitoring of SIMATIC HMI systems based on TCP/IP networks
  - Sm@rtAccess for communication between HMI systems based on TCP/IP networks. Remote access to recipe data records, passwords and HMI system-specific information, and much more. (Mobile Panel 277F IWLAN as server: View only)
  - OPC server: Communication with applications (e.g. MES, ERP, or applications in the office sector) from various manufacturers (see HMI software/runtime software SIMATIC WinCC flexible/WinCC flexible RT options)
  - Audit

### Function (continued)

#### Configuration

Configuration is carried out with the SIMATIC WinCC flexible Standard or Advanced configuration software (see SIMATIC WinCC flexible HMI software/engineering software). SIMATIC WinCC flexible is the logical further development of the field-proven ProTool family. Projects generated using ProTool can be easily migrated to WinCC flexible. If WinCC flexible is started directly from SIMATIC Manager, data in STEP 7 can be accessed directly when the panel is configured. Duplicated data input and data management is, therefore, avoided.

#### IWLAN infrastructure

The required IWLAN infrastructure is set up using the SCALANCE W-700 IWLAN Access Points, preferably with the SCALANCE W-700 variant that has two wireless cards built into the device (Dual Access Point) and KEY-PLUG W700 iFeatures which supports the application options of the Mobile Panel 277(F) IWLAN.

The iPCF-MC functionality (rapid roaming = fast, uninterrupted switchover between multiple access points) is only available with panels in version V2 or higher.

The Access Point provides an Industrial Ethernet interface for connection to the wired network.

In addition to a reliable radio link, the SCALANCE W-700 Access Points stand out due to their optimum support of standardized IT mechanisms:

- IEEE 802.11b/ g/ a/ h for different frequency ranges
- IEEE 802.11e for multimedia, wireless multimedia (WMM) <sup>1)</sup>
- IEEE 802.11i for security <sup>1)</sup>
- Construction of redundant networks with the Rapid Spanning Tree Protocol (RSTP)
- Virtual networks (VLAN) to logically separate, for example, different user groups
- Sending the log entries of the SCALANCE W devices to a Syslog server

Only **the wireless** approvals printed on the **Mobile Panel** are binding. The RF approvals planned for all SIMATIC products can be viewed at <http://www.siemens.com/wireless-approvals>.

<sup>1)</sup> Not supported by Mobile Panel Wireless

### Integration

The SIMATIC Mobile Panel 277(F) IWLAN communicates via the WLAN Standard IEEE 802.11 a(b/g) via PROFINET. The Mobile Panel 277F IWLAN devices also support PROFIsafe communication.

There are five device variants with V2:

For mobile operation and monitoring via WLAN:

- Mobile Panel 277 IWLAN V2
- Mobile Panel 277 IWLAN V2 with handwheel, key switch and illuminated pushbuttons

As fail-safe device for safety-oriented operation as well:

- Mobile Panel 277F IWLAN V2 with acknowledgement button and emergency stop button
- Mobile Panel 277F IWLAN V2 with acknowledgement button, emergency stop button, handwheel, key switch and illuminated pushbuttons
- Mobile Panel 277F IWLAN RFID Tag (for V2 only)

For the versions Mobile Panel 277F IWLAN (PROFIsafe), the following system prerequisites apply:

- The Mobile Panel must be connected as a safe device (PROFIsafe, Distributed Safety)
- Use of a SIMATIC F-CPU

SIMATIC Mobile Panel		5 GHz frequency band (IEEE 802.11a)	SIMATIC F-CPU (Distributed Safety)
277 IWLAN	Only WLAN utilization (HMI)	●	–
	When using transponders	!	–
	When using Profinet IO	●	–
277F IWLAN (fail-safe)	–	!	!
277F IWLAN (RFID Tag) (fail-safe)	–	●	!

● = Recommended

! = Requirement

– = Not required

The Mobile Panel 277(F) IWLAN can be connected to:

- SIMATIC S7-200/300/400 (one F-CPU required for integrating the Mobile Panel 277F IWLAN and SIMOTION (Mobile Panel 277 IWLAN V2 or higher, or Mobile Panel 277F IWLAN V2 or higher (WinCC flexible 2008 SP3 or higher))

#### Note:

Further information can be found under "System interfaces". The Function Manuals "Fail-Safe Operation of the Mobile Panel 277F IWLAN" are available for downloading in English, German, and Japanese.

<http://support.automation.siemens.com/WW/view/en/31255853>

## Industrial Wireless Communication

### Wireless Devices

#### SIMATIC Mobile Panel 277(F) IWLAN

#### Technical specifications

	6AV6645-0DD01-0AX1	6AV6645-0DE01-0AX1	6AV6645-0EB01-0AX1	6AV6645-0EC01-0AX1	6AV6645-0EF01-0AX1
		With handwheel key switch and two illuminated pushbutton	With integrated enabling- and emergency-stop button	With integrated enabling- and emergency-stop button, handwheel, key switch and two illuminated pushbuttons	RFID with integrated enabling- and emergency-stop button, handwheel, key switch and two illuminated pushbuttons
<b>Display</b>					
Size	7.5"	7.5"	7.5"	7.5"	7.5"
Display type	TFT, 65536 colors	TFT, 65536 colors	TFT, 65536 colors	TFT, 65536 colors	TFT, 65536 colors
Resolution (pixels)					
• Resolution (WxH in pixel)	640 x 480	640 x 480	640 x 480	640 x 480	640 x 480
Backlighting					
• MTBF backlighting (at 25 °C)	50 000 h	50 000 h	50 000 h	50 000 h	50 000 h
<b>Control elements</b>					
Operating options	Keys and Touch	Keys and Touch	Keys and Touch	Keys and Touch	Keys and Touch
Function keys, programmable	18 function keys, 18 with LEDs	18 function keys, 18 with LEDs	18 function keys, 18 with LEDs	18 function keys, 18 with LEDs	18 function keys, 18 with LEDs
Connection for mouse/keyboard/barcode reader	USB / USB / USB	USB / USB / USB	USB / USB / USB	USB / USB / USB	USB / USB / USB
Touch operation					
• Touch screen	Analog, resistive	Analog, resistive	Analog, resistive	Analog, resistive	Analog, resistive
Special operator controls					
• Stop button	No	No			
• Emergency stop button (forced blocking)			Yes	Yes	Yes
• Acknowledgement button	No	No	Yes	Yes	Yes
• Key-operated switch	No	Yes	No	Yes	Yes
• Illuminated pushbutton	No	Yes	No	Yes	Yes
• Handwheel	No	Yes	No	Yes	Yes
<b>Supply voltage</b>					
Supply voltage	DC	DC	DC	DC	DC
Via charging station	Yes	Yes	Yes	Yes	Yes
Via table power supply	Yes	Yes	Yes	Yes	Yes
<b>Processor</b>					
Processor	ARM, 520 MHz	ARM, 520 MHz	ARM, 520 MHz	ARM, 520 MHz	ARM, 520 MHz
<b>Memory</b>					
Type	Flash / RAM	Flash / RAM	Flash / RAM	Flash / RAM	Flash / RAM
Usable memory for user data	6 MB usable memory for user data	6 MB usable memory for user data	6 MB usable memory for user data	6 MB usable memory for user data	6 MB usable memory for user data
<b>Battery</b>					
Main battery					
• Rated voltage	7.2 V	7.2 V	7.2 V	7.2 V	7.2 V
• Capacity	5 100 mA·h	5 100 mA·h	5 100 mA·h	5 100 mA·h	5 100 mA·h
• Number of loading cycles, min	500	500	500	500	500
• Charging time, typ.	4 h	4 h	4 h	4 h	4 h
• Operating time, typ.	4 h	4 h	4 h	4 h	4 h
• Display for battery capacity	Yes	Yes	Yes	Yes	Yes
• Energy-saving mode	Yes	Yes	Yes	Yes	Yes
• Battery replacement during operation	Yes	Yes	Yes	Yes	Yes
<b>Type of output</b>					
Status LEDs	Yes	Yes	Yes	Yes	Yes
LED for safe			Yes	Yes	Yes
LED for communication	Yes	Yes	Yes	Yes	Yes
LED for battery	Yes	Yes	Yes	Yes	Yes
Vibrations	Yes	Yes	Yes	Yes	Yes
<b>Time of day</b>					
Clock					
• Type	Hardware clock, battery backup, synchronizable	Hardware clock, battery backup, synchronizable	Hardware clock, battery backup, synchronizable	Hardware clock, battery backup, synchronizable	Hardware clock, battery backup, synchronizable
• Hardware clock (real-time clock)	Yes	Yes	Yes	Yes	Yes
• Battery-backed	Yes	Yes	Yes	Yes	Yes
• Synchronizable	Yes	Yes	Yes	Yes	Yes

### Technical specifications (continued)

	6AV6645-0DD01-0AX1	6AV6645-0DE01-0AX1	6AV6645-0EB01-0AX1	6AV6645-0EC01-0AX1	6AV6645-0EF01-0AX1
		With handwheel key switch and two illuminated pushbutton	With integrated enabling- and emergency-stop button	With integrated enabling- and emergency-stop button, handwheel, key switch and two illuminated pushbuttons	RFID with integrated enabling- and emergency-stop button, handwheel, key switch and two illuminated pushbuttons
<b>Interfaces</b>					
Interfaces	1 x Ethernet (RJ45)	1 x Ethernet (RJ45)	1 x Ethernet (RJ45)	1 x Ethernet (RJ45)	1 x Ethernet (RJ45)
Number of USB interfaces	1	1	1	1	1
USB port	1 x USB	1 x USB	1 x USB	1 x USB	1 x USB
Multi Media Card slot	1 MMC/SD card slot	1 MMC/SD card slot	1 MMC/SD card slot	1 MMC/SD card slot	1 MMC/SD card slot
Industrial Ethernet					
• Industrial Ethernet interface	1 x Ethernet (RJ45)	1 x Ethernet (RJ45)	1 x Ethernet (RJ45)	1 x Ethernet (RJ45)	1 x Ethernet (RJ45)
WLAN					
• Wireless LAN	Yes	Yes	Yes	Yes	Yes
• Supports rapid roaming	Yes	Yes	Yes	Yes	Yes
<b>Protocols</b>					
PROFINET	Yes	Yes	Yes	Yes	Yes
Supports protocol for PROFINET IO	Yes	Yes	Yes	Yes	Yes
Supports protocol for PROFIsafe	No	No	Yes	Yes	Yes
<b>EMC</b>					
Emission of radio interference acc. to EN 55 011					
• Emission of radio interferences acc. to EN 55 011 (limit class A)	Yes; The product is designed for use in industrial environments. When used in residential areas, the emission of radio interference according to limit class B of EN 55011 must be ensured. For further information refer to the user documentation	Yes; The product is designed for use in industrial environments. When used in residential areas, the emission of radio interference according to limit class B of EN 55011 must be ensured. For further information refer to the user documentation	Yes; The product is designed for use in industrial environments. When used in residential areas, the emission of radio interference according to limit class B of EN 55011 must be ensured. For further information refer to the user documentation	Yes; The product is designed for use in industrial environments. When used in residential areas, the emission of radio interference according to limit class B of EN 55011 must be ensured. For further information refer to the user documentation	Yes; The product is designed for use in industrial environments. When used in residential areas, the emission of radio interference according to limit class B of EN 55011 must be ensured. For further information refer to the user documentation
<b>Degree and class of protection</b>					
IP65 enclosure	Yes	Yes	Yes	Yes	Yes
<b>Standards, approvals, certificates</b>					
Certifications	CE, cULus, C-TICK	CE, cULus, C-TICK	CE, cULus, C-TICK	CE, cULus, C-TICK	CE, cULus, C-TICK
CE mark	Yes	Yes	Yes	Yes	Yes
cULus	Yes	Yes	Yes	Yes	Yes
RCM (former C-TICK)	Yes	Yes	Yes	Yes	Yes
TÜV safety certification			Yes	Yes	Yes
Highest safety class achievable in safety mode					
• Performance level according to EN ISO 13849-1:2008			e	e	e
• SIL according to IEC 61508:2010			SIL 3	SIL 3	SIL 3
<b>Ambient conditions</b>					
Drop height	1.2 m	1.2 m	1.2 m	1.2 m	1.2 m
Operating temperature					
• Operation	0 °C to +40 °C	0 °C to +40 °C	0 °C to +40 °C	0 °C to +40 °C	0 °C to +40 °C
Storage/transport temperature					
• Transport, storage	-20 °C to +60 °C	-20 °C to +60 °C	-20 °C to +60 °C	-20 °C to +60 °C	-20 °C to +60 °C
Relative humidity					
• max. relative humidity	80 %	80 %	80 %	80 %	80 %
<b>Operating systems</b>					
Operating system	Windows CE	Windows CE	Windows CE	Windows CE	Windows CE
<b>Languages</b>					
Online languages					
• Number of online/runtime languages	16	16	16	16	16

## Industrial Wireless Communication

### Wireless Devices

#### SIMATIC Mobile Panel 277(F) IWLAN

#### Technical specifications (continued)

	6AV6645-0DD01-0AX1	6AV6645-0DE01-0AX1	6AV6645-0EB01-0AX1	6AV6645-0EC01-0AX1	6AV6645-0EF01-0AX1
		With handwheel key switch and two illuminated pushbutton	With integrated enabling- and emergency-stop button	With integrated enabling- and emergency-stop button, handwheel, key switch and two illuminated pushbuttons	RFID with integrated enabling- and emergency-stop button, handwheel, key switch and two illuminated pushbuttons
<b>Functionality under WinCC (TIA Portal)</b>					
Libraries	Yes	Yes	Yes	Yes	Yes
Task planner	Yes	Yes	Yes	Yes	Yes
Message system					
• Number of messages	4 000	4 000	4 000	4 000	4 000
• Bit messages	Yes	Yes	Yes	Yes	Yes
• Analog messages	Yes	Yes	Yes	Yes	Yes
Recipe administration					
• Number of recipes	300	300	300	300	300
• Data records per recipe	500	500	500	500	500
• Entries per data record	1 000	1 000	1 000	1 000	1 000
• Recipe memory	64 KB integrated Flash, expandable	64 KB integrated Flash, expandable	64 KB integrated Flash, expandable	64 KB integrated Flash, expandable	64 KB integrated Flash, expandable
Variables					
• Number of variables per device	2 048	2 048	2 048	2 048	2 048
• Limit values	Yes	Yes	Yes	Yes	Yes
• Multiplexing	Yes	Yes	Yes	Yes	Yes
Images					
• Number of configurable images	500	500	500	500	500
Image objects					
• Text objects	10 000 text elements	10 000 text elements	10 000 text elements	10 000 text elements	10 000 text elements
• Graphics object	Bit maps, icons, vector graphics	Bit maps, icons, vector graphics	Bit maps, icons, vector graphics	Bit maps, icons, vector graphics	Bit maps, icons, vector graphics
Complex image objects					
• Status/control	With SIMATIC S7	With SIMATIC S7	With SIMATIC S7	With SIMATIC S7	With SIMATIC S7
• dynamic objects	Diagrams, bar graphs, sliders, analog display, invisible buttons	Diagrams, bar graphs, sliders, analog display, invisible buttons	Diagrams, bar graphs, sliders, analog display, invisible buttons	Diagrams, bar graphs, sliders, analog display, invisible buttons	Diagrams, bar graphs, sliders, analog display, invisible buttons
Lists					
• Number of text lists per project	500	500	500	500	500
• Number of graphics lists per project	400	400	400	400	400
Archiving					
• Number of archives per device	20	20	20	20	20
• Number of measuring points per project	20	20	20	20	20
• Number of entries per archive	10 000	10 000	10 000	10 000	10 000
Security					
• Number of user groups	50	50	50	50	50
• Number of user rights	32	32	32	32	32
• Password export/import	Yes	Yes	Yes	Yes	Yes
Logging through printer					
• Recording/Printing	Alarms, report (shift report), PROFINET	Alarms, report (shift report), PROFINET	Alarms, report (shift report), PROFINET	Alarms, report (shift report), PROFINET	Alarms, report (shift report), PROFINET
Transfer (upload/download)					
• Transfer of configuration	USB, Ethernet, automatic transfer recognition	USB, Ethernet, automatic transfer recognition	USB, Ethernet, automatic transfer recognition	USB, Ethernet, automatic transfer recognition	USB, Ethernet, automatic transfer recognition
• Wireless LAN	Yes	Yes	Yes	Yes	Yes



### Technical specifications (continued)

	6AV6645-0DD01-0AX1	6AV6645-0DE01-0AX1	6AV6645-0EB01-0AX1	6AV6645-0EC01-0AX1	6AV6645-0EF01-0AX1
		With handwheel key switch and two illuminated pushbutton	With integrated enabling- and emergency-stop button	With integrated enabling- and emergency-stop button, handwheel, key switch and two illuminated pushbuttons	RFID with integrated enabling- and emergency-stop button, handwheel, key switch and two illuminated pushbuttons
<b>Process coupling</b>					
• Connection to controller	S7-200, S7- 300/400 see section on "System interfaces"	S7-200, S7- 300/400 see section on "System interfaces"	S7-200, S7- 300/400 see section on "System interfaces"	S7-200, S7- 300/400 see section on "System interfaces"	S7-200, S7- 300/400 see section on "System interfaces"
• S7-1200	Yes	Yes	No	No	No
• S7-1500	Yes	Yes	No; Available soon	No; Available soon	No; Available soon
• Zones	Yes	Yes	Yes	Yes	Yes
- Number of zones per project, max.	254	254	254	254	254
- Number of transponders for zones per project, max.	255	255	255	255	255
• Effective range			Yes	Yes	Yes
- Number of effective ranges per project, max.			127	127	127
- Number of transponders for effective ranges per project, max.			127	127	127
• Transponder	Yes	Yes	Yes	Yes	Yes
- Number of transponders per project, max.	256	256	256	256	256
- Adjustable distance range	Yes	Yes	Yes	Yes	Yes
- Adjustable distance, min.	2 m	2 m	2 m	2 m	2 m
- Adjustable distance, max.	8 m	8 m	8 m	8 m	8 m
<b>I/O/Options</b>					
I/O devices	Barcode reader	Barcode reader	Barcode reader	Barcode reader	Barcode reader
• Multi Media Card	Yes	Yes	Yes	Yes	Yes
<b>Mechanics/material</b>					
Type of housing (front)	Plastic	Plastic	Plastic	Plastic	Plastic
<b>Dimensions</b>					
Housing diameter/depth (mm)	Dia 290 mm / D 103 mm	Dia 290 mm / D 103 mm	Dia 290 mm / D 103 mm	Dia 290 mm / D 103 mm	Dia 290 mm / D 103 mm
<b>Weights</b>					
Weight (without packaging)	2.2 kg	2.2 kg	2.2 kg	2.2 kg	2.2 kg
	6AV6645-0FD01-0AX1	6AV6645-0FE01-0AX1	6AV6645-0GB01-0AX1	6AV6645-0GC01-0AX1	6AV6645-0GF01-0AX1
	USA version	USA version With handwheel key switch and two illuminated pushbutton	USA version With integrated enabling- and emergency-stop button	USA version With integrated enabling- and emergency-stop button, handwheel, key switch and two illuminated pushbuttons	USA version RFID with integrated enabling- and emergency-stop button, handwheel, key switch and two illuminated pushbuttons
<b>Display</b>					
Size	7.5"	7.5"	7.5"	7.5"	7.5"
Display type	TFT, 65536 colors	TFT, 65536 colors	TFT, 65536 colors	TFT, 65536 colors	TFT, 65536 colors
Resolution (pixels)					
• Resolution (WxH in pixel)	640 x 480	640 x 480	640 x 480	640 x 480	640 x 480
Backlighting					
• MTBF backlighting (at 25 °C)	50 000 h	50 000 h	50 000 h	50 000 h	50 000 h
<b>Control elements</b>					
Operating options	Keys and Touch	Keys and Touch	Keys and Touch	Keys and Touch	Keys and Touch
Function keys, programmable	18 function keys, 18 with LEDs	18 function keys, 18 with LEDs	18 function keys, 18 with LEDs	18 function keys, 18 with LEDs	18 function keys, 18 with LEDs
Connection for mouse/keyboard/barcode reader	USB / USB / USB	USB / USB / USB	USB / USB / USB	USB / USB / USB	USB / USB / USB
Touch operation					
• Touch screen	Analog, resistive	Analog, resistive	Analog, resistive	Analog, resistive	Analog, resistive

## Industrial Wireless Communication

### Wireless Devices

#### SIMATIC Mobile Panel 277(F) IWLAN

#### Technical specifications (continued)

	6AV6645-0FD01-0AX1	6AV6645-0FE01-0AX1	6AV6645-0GB01-0AX1	6AV6645-0GC01-0AX1	6AV6645-0GF01-0AX1
	USA version	USA version With handwheel key switch and two illuminated pushbutton	USA version With integrated enabling- and emergency-stop button	USA version With integrated enabling- and emergency-stop button, handwheel, key switch and two illuminated pushbuttons	USA version RFID with integrated enabling- and emergency-stop button, handwheel, key switch and two illuminated pushbuttons
<b>Special operator controls</b>					
• Stop button	No	No		Yes	Yes
• Emergency stop button (forced blocking)			Yes	Yes	Yes
• Acknowledgement button	No	No	Yes	Yes	Yes
• Key-operated switch	No	Yes	No	Yes	Yes
• Illuminated pushbutton	No	Yes	No	Yes	Yes
• Handwheel	No	Yes	No	Yes	Yes
<b>Supply voltage</b>					
Supply voltage	DC	DC	DC	DC	DC
Via charging station	Yes	Yes	Yes	Yes	Yes
Via table power supply	Yes	Yes	Yes	Yes	Yes
<b>Processor</b>					
Processor	ARM, 520 MHz	ARM, 520 MHz	ARM, 520 MHz	ARM, 520 MHz	ARM, 520 MHz
<b>Memory</b>					
Type	Flash / RAM	Flash / RAM	Flash / RAM	Flash / RAM	Flash / RAM
Usable memory for user data	6 MB usable memory for user data	6 MB usable memory for user data	6 MB usable memory for user data	6 MB usable memory for user data	6 MB usable memory for user data
<b>Battery</b>					
Main battery					
• Rated voltage	7.2 V	7.2 V	7.2 V	7.2 V	7.2 V
• Capacity	5 100 mA·h	5 100 mA·h	5 100 mA·h	5 100 mA·h	5 100 mA·h
• Number of loading cycles, min	500	500	500	500	500
• Charging time, typ.	4 h	4 h	4 h	4 h	4 h
• Operating time, typ.	4 h	4 h	4 h	4 h	4 h
• Display for battery capacity	Yes	Yes	Yes	Yes	Yes
• Energy-saving mode	Yes	Yes	Yes	Yes	Yes
• Battery replacement during operation	Yes	Yes	Yes	Yes	Yes
<b>Type of output</b>					
Status LEDs	Yes	Yes	Yes	Yes	Yes
LED for safe			Yes	Yes	Yes
LED for communication	Yes	Yes	Yes	Yes	Yes
LED for battery	Yes	Yes	Yes	Yes	Yes
Vibrations	Yes	Yes	Yes	Yes	Yes
<b>Time of day</b>					
Clock					
• Type	Hardware clock, battery backup, synchronizable	Hardware clock, battery backup, synchronizable	Hardware clock, battery backup, synchronizable	Hardware clock, battery backup, synchronizable	Hardware clock, battery backup, synchronizable
• Hardware clock (real-time clock)	Yes	Yes	Yes	Yes	Yes
• Battery-backed	Yes	Yes	Yes	Yes	Yes; Via bypass battery
• Synchronizable	Yes	Yes	Yes	Yes	Yes
<b>Interfaces</b>					
Interfaces	1 x Ethernet (RJ45)	1 x Ethernet (RJ45)	1 x Ethernet (RJ45)	1 x Ethernet (RJ45)	1 x Ethernet (RJ45)
Number of USB interfaces	1	1	1	1	1
USB port	1 x USB	1 x USB	1 x USB	1 x USB	1 x USB
Multi Media Card slot	1 MMC/SD card slot	1 MMC/SD card slot	1 MMC/SD card slot	1 MMC/SD card slot	1 MMC/SD card slot
Industrial Ethernet					
• Industrial Ethernet interface	1 x Ethernet (RJ45)	1 x Ethernet (RJ45)	1 x Ethernet (RJ45)	1 x Ethernet (RJ45)	1 x Ethernet (RJ45)
WLAN					
• Wireless LAN	Yes	Yes	Yes	Yes	Yes
• Supports rapid roaming	Yes	Yes	Yes	Yes	Yes
<b>Protocols</b>					
PROFINET	Yes	Yes	Yes	Yes	Yes
Supports protocol for PROFINET IO	Yes	Yes	Yes	Yes	Yes
Supports protocol for PROFIsafe	No	No	Yes	Yes	Yes

### Technical specifications (continued)

	6AV6645-0FD01-0AX1	6AV6645-0FE01-0AX1	6AV6645-0GB01-0AX1	6AV6645-0GC01-0AX1	6AV6645-0GF01-0AX1
	USA version	USA version With handwheel key switch and two illuminated pushbutton	USA version With integrated enabling- and emergency-stop button	USA version With integrated enabling- and emergency-stop button, handwheel, key switch and two illuminated pushbuttons	USA version RFID with integrated enabling- and emergency-stop button, handwheel, key switch and two illuminated pushbuttons
<b>EMC</b>					
Emission of radio interference acc. to EN 55 011					
• Emission of radio interferences acc. to EN 55 011 (limit class A)	Yes; The product is designed for use in industrial environments. When used in residential areas, the emission of radio interference according to limit class B of EN 55011 must be ensured. For further information refer to the user documentation	Yes; The product is designed for use in industrial environments. When used in residential areas, the emission of radio interference according to limit class B of EN 55011 must be ensured. For further information refer to the user documentation	Yes; The product is designed for use in industrial environments. When used in residential areas, the emission of radio interference according to limit class B of EN 55011 must be ensured. For further information refer to the user documentation	Yes; The product is designed for use in industrial environments. When used in residential areas, the emission of radio interference according to limit class B of EN 55011 must be ensured. For further information refer to the user documentation	Yes; The product is designed for use in industrial environments. When used in residential areas, the emission of radio interference according to limit class B of EN 55011 must be ensured. For further information refer to the user documentation
<b>Degree and class of protection</b>					
IP65 enclosure	Yes	Yes	Yes	Yes	Yes
<b>Standards, approvals, certificates</b>					
Certifications	CE, cULus, C-TICK	CE, cULus, C-TICK	CE, cULus, C-TICK	CE, cULus, C-TICK	CE, cULus, C-TICK
CE mark	Yes	Yes	Yes	Yes	Yes
cULus	Yes	Yes	Yes	Yes	Yes
RCM (former C-TICK)	Yes	Yes	Yes	Yes	Yes
TÜV safety certification			Yes	Yes	Yes
Highest safety class achievable in safety mode			e	e	e
• Performance level according to EN ISO 13849-1:2008			SIL 3	SIL 3	SIL 3
• SIL according to IEC 61508:2010					
<b>Ambient conditions</b>					
Drop height	1.2 m	1.2 m	1.2 m	1.2 m	1.2 m
Operating temperature					
• Operation	0 °C to +40 °C	0 °C to +40 °C	0 °C to +40 °C	0 °C to +40 °C	0 °C to +40 °C
Storage/transport temperature					
• Transport, storage	-20 °C to +60 °C	-20 °C to +60 °C	-20 °C to +60 °C	-20 °C to +60 °C	-20 °C to +60 °C
Relative humidity					
• max. relative humidity	80 %	80 %	80 %	80 %	80 %
<b>Operating systems</b>					
Operating system	Windows CE	Windows CE	Windows CE	Windows CE	Windows CE
<b>Languages</b>					
Online languages					
• Number of online/runtime languages	16	16	16	16	16
<b>Functionality under WinCC (TIA Portal)</b>					
Libraries	Yes	Yes	Yes	Yes	Yes
Task planner	Yes	Yes	Yes	Yes	Yes
Message system					
• Number of messages	4 000	4 000	4 000	4 000	4 000
• Bit messages	Yes	Yes	Yes	Yes	Yes
• Analog messages	Yes	Yes	Yes	Yes	Yes
Recipe administration					
• Number of recipes	300	300	300	300	300
• Data records per recipe	500	500	500	500	500
• Entries per data record	1 000	1 000	1 000	1 000	1 000
• Recipe memory	64 KB integrated Flash, expandable	64 KB integrated Flash, expandable	64 KB integrated Flash, expandable	64 KB integrated Flash, expandable	64 KB integrated Flash, expandable
Variables					
• Number of variables per device	2 048	2 048	2 048	2 048	2 048
• Limit values	Yes	Yes	Yes	Yes	Yes
• Multiplexing	Yes	Yes	Yes	Yes	Yes

# Industrial Wireless Communication

## Wireless Devices

### SIMATIC Mobile Panel 277(F) IWLAN

#### Technical specifications (continued)

	6AV6645-0FD01-0AX1	6AV6645-0FE01-0AX1	6AV6645-0GB01-0AX1	6AV6645-0GC01-0AX1	6AV6645-0GF01-0AX1
	USA version	USA version With handwheel key switch and two illuminated pushbutton	USA version With integrated enabling- and emergency-stop button	USA version With integrated enabling- and emergency-stop button, handwheel, key switch and two illuminated pushbuttons	USA version RFID with integrated enabling- and emergency-stop button, handwheel, key switch and two illuminated pushbuttons
<b>Images</b>					
• Number of configurable images	500	500	500	500	500
<b>Image objects</b>					
• Text objects	10 000 text elements	10 000 text elements	10 000 text elements	10 000 text elements	10 000 text elements
• Graphics object	Bit maps, icons, vector graphics	Bit maps, icons, vector graphics	Bit maps, icons, vector graphics	Bit maps, icons, vector graphics	Bit maps, icons, vector graphics
<b>Complex image objects</b>					
• Status/control	With SIMATIC S7	With SIMATIC S7	With SIMATIC S7	With SIMATIC S7	With SIMATIC S7
• dynamic objects	Diagrams, bar graphs, sliders, analog display, invisible buttons	Diagrams, bar graphs, sliders, analog display, invisible buttons	Diagrams, bar graphs, sliders, analog display, invisible buttons	Diagrams, bar graphs, sliders, analog display, invisible buttons	Diagrams, bar graphs, sliders, analog display, invisible buttons
<b>Lists</b>					
• Number of text lists per project	500	500	500	500	500
• Number of graphics lists per project	400	400	400	400	400
<b>Archiving</b>					
• Number of archives per device	20	20	20	20	20
• Number of measuring points per project	20	20	20	20	20
• Number of entries per archive	10 000	10 000	10 000	10 000	10 000
<b>Security</b>					
• Number of user groups	50	50	50	50	50
• Number of user rights	32	32	32	32	32
• Password export/import	Yes	Yes	Yes	Yes	Yes
<b>Logging through printer</b>					
• Recording/Printing	Alarms, report (shift report), PROFINET	Alarms, report (shift report), PROFINET	Alarms, report (shift report), PROFINET	Alarms, report (shift report), PROFINET	Alarms, report (shift report), PROFINET
<b>Transfer (upload/download)</b>					
• Transfer of configuration	USB, Ethernet, automatic transfer recognition	USB, Ethernet, automatic transfer recognition	USB, Ethernet, automatic transfer recognition	USB, Ethernet, automatic transfer recognition	USB, Ethernet, automatic transfer recognition
• Wireless LAN	Yes	Yes	Yes	Yes	Yes
<b>Process coupling</b>					
• Connection to controller	S7-200, S7- 300/400 see section on "System interfaces"	S7-200, S7- 300/400 see section on "System interfaces"	S7-200, S7- 300/400 see section on "System interfaces"	S7-200, S7- 300/400 see section on "System interfaces"	S7-200, S7- 300/400 see section on "System interfaces"
• S7-1200	Yes	Yes	No	No	No
• S7-1500	Yes	Yes	No; Available soon	No; Available soon	No; Available soon
• Zones	Yes	Yes	Yes	Yes	Yes
- Number of zones per project, max.	254	254	254	254	254
- Number of transponders for zones per project, max.	255	255	255	255	255
• Effective range			Yes	Yes	Yes
- Number of effective ranges per project, max.			127	127	127
- Number of transponders for effective ranges per project, max.			127	127	127
• Transponder	Yes	Yes	Yes	Yes	Yes
- Number of transponders per project, max.	256	256	256	256	256
- Adjustable distance range	Yes	Yes	Yes	Yes	Yes
- Adjustable distance, min.	2 m	2 m	2 m	2 m	2 m
- Adjustable distance, max.	8 m	8 m	8 m	8 m	8 m
<b>I/O/Options</b>					
I/O devices	Barcode reader	Barcode reader	Barcode reader	Barcode reader	Barcode reader
• Multi Media Card	Yes	Yes	Yes	Yes	Yes
<b>Mechanics/material</b>					
Type of housing (front)	Plastic	Plastic	Plastic	Plastic	Plastic
<b>Dimensions</b>					
Housing diameter/depth (mm)	Dia 290 mm / D 103 mm	Dia 290 mm / D 103 mm	Dia 290 mm / D 103 mm	Dia 290 mm / D 103 mm	Dia 290 mm / D 103 mm
<b>Weights</b>					
Weight (without packaging)	2.2 kg	2.2 kg	2.2 kg	2.2 kg	2.2 kg

Ordering data	Article No.	Article No.
<b>SIMATIC Mobile Panel 277 IWLAN V2 (RoW version <sup>1)</sup>)</b> <ul style="list-style-type: none"> <li>• Communication via WLAN (PROFINET)</li> <li>• Communication via WLAN (PROFINET) with integrated handwheel, key-operated switch and two illuminated pushbuttons</li> </ul>	<b>6AV6645-0DD01-0AX1</b> <b>6AV6645-0DE01-0AX1</b>	<b>Accessories</b> See HMI accessories  Note: Please order the table-top power supply or charging station as well. Required for charging the battery.
<b>SIMATIC Mobile Panel 277F IWLAN V2 PROFIsafe (RoW version <sup>1)</sup>)</b> <ul style="list-style-type: none"> <li>• Communication via WLAN (PROFINET) with acknowledgement button and emergency stop button</li> <li>• Communication via WLAN (PROFINET) with acknowledgement button and emergency stop button with integrated handwheel, key-operated switch, and two illuminated pushbuttons</li> <li>• RFID tag version: Communication via WLAN (PROFINET) with acknowledgement button and emergency stop button with integrated handwheel, key-operated switch, and two illuminated pushbuttons</li> </ul>	<b>6AV6645-0EB01-0AX1</b> <b>6AV6645-0EC01-0AX1</b> <b>6AV6645-0EF01-0AX1</b>	<b>Documentation (to be ordered separately)</b>  You can find the manuals for the Mobile Panels on the Internet at: <a href="http://support.automation.siemens.com/WW/view/en/11599011/133300">http://support.automation.siemens.com/WW/view/en/11599011/133300</a>
<b>SIMATIC Mobile Panel 277 IWLAN V2 (USA version)</b> <ul style="list-style-type: none"> <li>• Communication via WLAN (PROFINET)</li> <li>• Communication via WLAN (PROFINET) with integrated handwheel, key-operated switch and two illuminated pushbuttons</li> </ul>	<b>6AV6645-0FD01-0AX1</b> <b>6AV6645-0FE01-0AX1</b>	1) RoW version: "Rest of World" version: Version for worldwide sales except in the U.S.
<b>SIMATIC Mobile Panel 277F IWLAN V2 PROFIsafe (USA version)</b> <ul style="list-style-type: none"> <li>• with acknowledgement button and emergency stop button</li> <li>• with acknowledgement button and emergency stop button with integrated handwheel, key-operated switch, and two illuminated pushbuttons</li> <li>• with acknowledgement button and emergency stop button with integrated handwheel, key-operated switch, and two illuminated pushbuttons (tag version)</li> </ul>	<b>6AV6645-0GB01-0AX1</b> <b>6AV6645-0GC01-0AX1</b> <b>6AV6645-0GF01-0AX1</b>	<b>Note:</b> The Function Manuals "Fail-Safe Operation of the Mobile Panel 277F IWLAN V1" are available for downloading in English, German, and Japanese. <a href="http://support.automation.siemens.com/WW/view/en/31255853">http://support.automation.siemens.com/WW/view/en/31255853</a>
<b>Starter kit SIMATIC Mobile Panel 277(F) IWLAN (RoW version<sup>1</sup>)</b>  for <ul style="list-style-type: none"> <li>• Mobile Panel 277 IWLAN V2</li> <li>• Mobile Panel 277F IWLAN V2</li> </ul>	<b>6AV6651-5GA01-0AA1</b> <b>6AV6651-5HA01-0AA1</b>	

### More information

Additional information is available in the Internet under:

<http://www.siemens.com/simatic-mobile-panels>

#### Note:

Do you need a specific modification or addition to the products described here? Then take a look under "Customer-specific products". There, you will find information on ordering additional and standard industry products as well as possibilities for customer-specific modifications and adjustments.

## Industrial Wireless Communication

### WirelessHART

#### General

#### Overview

HART (**H**ighway **A**ddressable **R**emote **T**ransducer) is the protocol for bus-addressed field devices. It is not a fieldbus, but a version of the digital field communication that contains many of the functionalities of fieldbuses.

**WirelessHART** is the wireless HART communication to fieldbuses in the process industry. The HART Communication Foundation (HCF) specified WirelessHART and published it as part of the HART standard V7.1. The radio transmission is based on the wireless communications standard IEEE 802.15.4. High availability is achieved by means of the meshed network architecture (each field device is simultaneously a repeater) with redundant communication paths and constantly changing frequency channels (channel hopping). 128-bit encryption in conjunction with authentication and validation of each data packet ensures secure data transfer and prevents unauthorized access to the field devices.

As a basic principle, a WirelessHART network consists of WirelessHART field devices and a WirelessHART gateway that receives the data from the field devices and forwards it to the automation system.

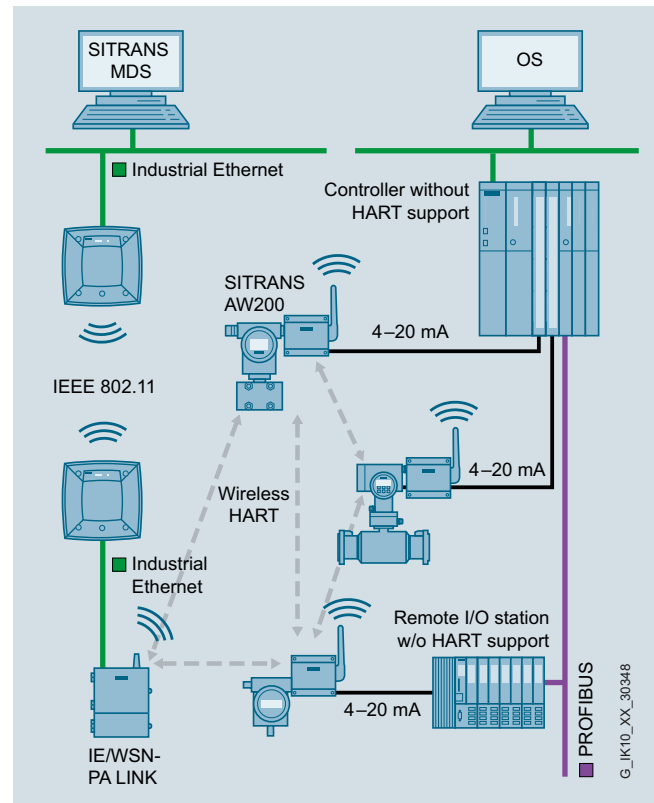

Wireless communication with WirelessHART

### Overview



SITRANS P280 for flexible and cost-effective applications in pressure monitoring

- Supports the WirelessHART standard (HART V 7.1)
- Very high security level for wireless data transmission
- Built-in local user interface (LUI) with 3-button operation
- Optimum display and readability using graphics display (104 x 80 pixels) with integrated background illumination
- Stand-by (deep sleep phase) can be activated and deactivated on the device with a push of a button
- Battery power supply
- Battery service life up to 5 years
- Extend battery service life with HART modem interface which can be shut off
- Optimized power consumption through new design, and increase in battery service life
- Simple configuration thanks to SIMATIC PDM
- Device meets IP65 degree of protection
- Can be used for absolute and gauge pressure measurements

### Benefits

The SITRANS P280 is a pressure transmitter that features Wireless HART as the standard communication interface.

Also available is a wired interface to connect a HART modem:

- Flexible pressure measurements
- Save costs on wiring for difficult installation conditions. Wireless technology offers cost advantages in cases where extensive wiring costs would normally apply.
- It enables additional hitherto unfeasible measuring points, particularly for monitoring purposes.
- Easy installation on moveable equipment parts
- Enables cost-effective temporary measurements, for example for process optimizations.
- Optimum addition to wired communication and expansion of solution options for system solutions in process automation

### Application

The SITRANS P280 is a WirelessHART field device for measuring absolute and gauge pressure.

The measuring ranges for absolute and gauge pressure measurements are 0 to 1.6, 10, 50, 200 and 320 bar (0 to 23, 145, 725, 2900 and 4641 psi).

The sensor is integrated into the transmitter casing.

On the wireless communication side, the transmitter supports the WirelessHART standard. For initial commissioning in particular, a HART modem can be connected to the transmitter. You can alternatively opt for simple and easy local operation using the pushbuttons w/o any additional handset devices.

It can be used in all industries and applications in non-explosive areas.

### Design

The SITRANS P280 has a robust aluminum enclosure and is suitable for outside use. It conforms with the IP65 safety class.

The operating temperature range is -40 to +80 °C (-40 to +176 °F). Power supply is provided through an integrated battery, which is available as an accessory. The device is only approved for operation with this battery.

The aerial features a rotatable joint which can be used for directional alignment. Wireless signals can thus be optimally received and transmitted.

A special highlight is the option for direct operation on the device. The operating strategy used in this case seamlessly integrates into the strategy of all new Siemens field devices.

Using the device's control buttons, it is easy to turn the HART modem interface of the device on and off. The device can be put to passive status and reactivated at any time. This helps to extend the service life of the battery.

The SITRANS P280 transmitter features a ceramic measuring cell for gauge and absolute pressure measurements.

### Function

The SITRANS P280 can integrate itself into a WirelessHART network. It can be parameterized and operated through this network. Measured process values are transported via the network to the SIEMENS IE/WSN-PA link.

Field device data received by the IE/WSN-PA LINK is transmitted to the connected systems, for example the process control system SIMATIC PCS 7. For an introduction to the mode of operation of WirelessHART, please see the FI 01 catalogue, section 9 or <http://www.siemens.com/wirelesshart>.

Detailed information on IE/WSN-PA can be found in the FI 01 catalogue, section 8 or <http://www.siemens.com/wirelesshart>.

## Industrial Wireless Communication

### WirelessHART

#### SITRANS P280 for gauge and absolute pressure

##### Integration

###### Connecting to SIMATIC PCS 7

The integration of field devices in SIMATIC PCS 7 and other process control systems can now be done seamlessly and cost-effectively with wireless technology, especially in situations where high wiring costs may be expected. Of particular interest are measuring points which are to be added and for which no MSR wiring is available.

Siemens WirelessHART devices are designed for optimum compatibility with products in the SCALANC W range.

Where larger distances between the IW/WSN-PA LINK and control systems need to be overcome, this connection can also be implemented on a wireless and cost-effective basis using the products of the SCALANCE W family.

##### Configuration

Configuration of the SITRANS P280 may be carried out as follows:

- Initial start-up for the SITRANS P280 with SIMATIC PDM is generally carried out via a HART modem or the integrated local user interface, since the network ID and Join key must be set up on the device before it can be accepted and integrated into the WirelessHART network.
- Once it is integrated into the network, the device can be conveniently operated with the WirelessHART network, the onsite HART modem or via the local user interface.

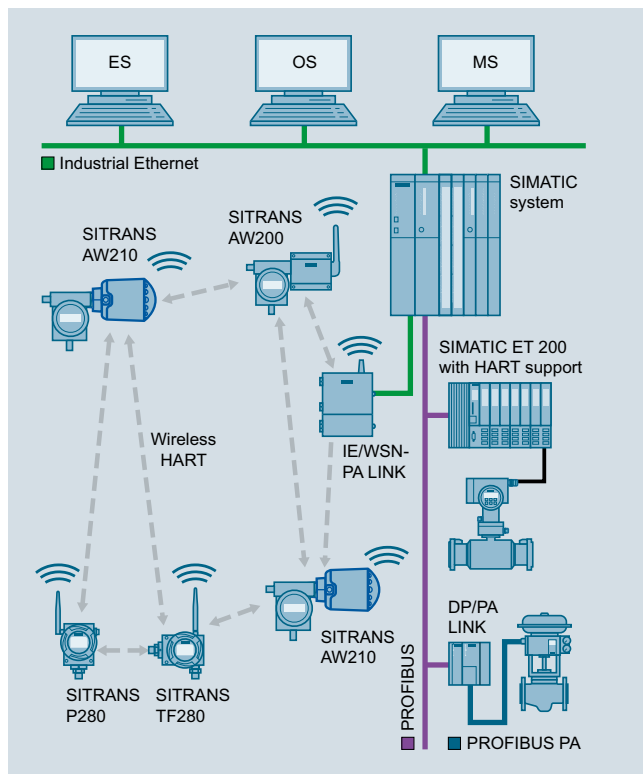

Integration of a meshed network in SIMATIC PCS7



### Technical specifications

SITRANS P280 WirelessHART Pressure Transmitter	
<b>Mode of operation</b>	
Measuring principle	piezo-resistive
Measured variable	Gauge and absolute pressure
<b>Gauge pressure input</b>	
Measuring range	Overload limit/Burst pressure
0 ... 1.6 bar (0 ... 23 psi)	4 bar (58 psi)
0 ... 10 bar (0 ... 145 psi)	20 bar (290 psi)
0 ... 50 bar (0 ... 725 psi)	100 bar (1 450 psi)
0 ... 200 bar (0 ... 2900 psi)	400 bar (5 801 psi)
0 ... 320 bar (0 ... 4641 psi)	640 bar (9 282 psi)
Units	mbar, bar, m4H <sub>2</sub> O, i4H <sub>2</sub> O, atm, Torr, gcm <sup>2</sup> , kgcm <sup>2</sup> , Pa, kPa, MPa, psi, mmHG, mmH <sub>2</sub> O, ftH <sub>2</sub> O, inHG, inH <sub>2</sub> O
<b>Absolute pressure input</b>	
Measuring range	Overload limit/Burst pressure
0 ... 1.6 bar a (0 ... 23 psi a)	4 bar a (58 psi a)
0 ... 10 bar a (0 ... 145 psi a)	20 bar a (290 psi a)
0 ... 50 bar a (0 ... 725 psi a)	100 bar a (1450 psi a)
0 ... 200 bar a (0 ... 2900 psi a)	400 bar a (5801 psi a)
0 ... 320 bar a (0 ... 4641 psi a)	640 bar a (9282 psi a)
Units	mbar, bar, m4H <sub>2</sub> O, i4H <sub>2</sub> O, atm, Torr, gcm <sup>2</sup> , kgcm <sup>2</sup> , Pa, kPa, MPa, psi, mmHG, mmH <sub>2</sub> O, ftH <sub>2</sub> O, inHG, inH <sub>2</sub> O
<b>Output</b>	
Output signal	2.4 GHz Wireless signal with TSMP (Time Synchronized Mesh Protocol)
<b>Measuring accuracy</b>	
	According to IEC 60770-1
Error in measurement at limit setting including hysteresis and reproducibility	typically 0.17 % of span, max. 0.25 % of sensor span
Long-term stability	max. ± 0.25 % of sensor/year span
Influence of ambient temperature	max. ± 0.2 %/10 K of sensor span
<b>Rated conditions</b>	
Ambient conditions	
• Ambient temperature	-40 ... +80 °C (-40 ... +176 °F) (in ambient temperatures below -20 °C (-4 °F) and above +70 °C (158 °F), readability of the display is limited.)
• Storage temperature	-40 ... +85 °C (-40 ... +185 °F)
• Relative humidity	< 95 %
Climatic class	4K4H in accordance with EN 60721-3-4(stationary use at locations not protected against weather)
Degree of protection	IP65/NEMA 4
Permissible medium temperature	-40 ... 85 °C (-40 ... +185 °F)

SITRANS P280 WirelessHART Pressure Transmitter	
<b>Design</b>	
Enclosure material	low-copper die-cast aluminum, GD-AlSi12 (Fe)
Shock resistance	in accordance with DIN EN 60068-2-29 / 03.95
Resistance to vibration	in accordance with EN 60068-2-6/ 12.07
Weight	
• without battery	1.5 kg (3.31 lb)
• With battery	1.6 kg (3.53 lb)
Dimensions (W x H x D)	See Dimensional drawing
Process connection	• G½B male thread to EN 837-1 • ½-14 NPT
Sensor break	Is recognized
<b>Displays and controls</b>	
Display (with illumination)	
• Size of display	104 x 80 pixels adjustable
• Number of digits	adjustable
• Number of spaces after comma	adjustable
Setting options	• on site with 3 buttons • with SIMATIC PDM or HART Communicator
<b>Auxiliary power</b>	
Battery	3.6 V DC
<b>Communication</b>	
Radio	WirelessHART V7.1 conforming
Transmission frequency band	2.4 GHz (ISM-Band)
Transmission range under reference conditions	Up to 250 m (line of sight) in outside areas Up to 50 m (greatly dependent on obstacles) in inside areas
Communication interfaces	• HART communication with HART modem • WirelessHART
<b>Certificates and approvals</b>	
Wireless communication approvals	R&TTE, FCC
General product safety	CSA <sub>US/C</sub> , CE, UL
Classification according to pressure equipment directive (PED 97/23/EC)	Gases: Fluid group 1 Liquids: Fluid group 1; meets requirements as per Section 3, Subsection 3 (good engineering practice)

# Industrial Wireless Communication

## WirelessHART

### SITRANS P280 for gauge and absolute pressure

#### Ordering data

Article No.

Article No.

#### Configuration

##### SITRANS P280 WirelessHART pressure transmitter

(Required battery not included with delivery, see accessories)

7MP1120 - ■ ■ ■ ■ ■ - ■ ■ ■ ■ 0

#### Measuring cell filling

Dry measuring cell

0

#### Measuring span

Gauge pressure

- 0 ... 1.6 bar (0 ... 23 psi)
- 0 ... 10 bar (0 ... 145 psi)
- 0 ... 50 bar (0 ... 725 psi)
- 0 ... 200 bar (0 ... 2900 psi)
- 0 ... 320 bar (0 ... 4641 psi)

D

E

F

G

H

Absolute pressure

- 0 ... 1.6 bar a (0 ... 3 psia)
- 0 ... 10 bar a (0 ... 145 psia)
- 0 ... 50 bar a (0 ... 725 psia)
- 0 ... 200 bar a (0 ... 2900 psia)
- 0 ... 320 bar a (0 ... 4641 psia)

M

N

P

Q

R

#### Wetted parts

Ceramic

K

#### Display

Display, visible

1

#### Enclosure

Die-cast aluminum

1

#### Process connection

G $\frac{1}{2}$  as per EN 837-1

0

$\frac{1}{2}$ -14 NPT

1

#### Explosion protection

Without

A

#### Antenna

Variable, attached to device

A

#### Further designs

Please add "-Z" to Article No. and specify Order code(s) and plain text.

#### Stainless steel tag plate

- Measuring point description  
max. 16 digits entered  
in plain text  
Y15: .....
- Measuring point message  
max. 27 characters entered in  
plain text:  
Y16: .....

Order code

Y15

Y16

#### Accessories

Lithium battery  
for SITRANS TF280/P280

7MP1990-0AA00

Mounting bracket, steel

7MF4997-1AC

Mounting bracket, stainless steel

7MF4997-1AJ

Cover, die-cast aluminum,  
without window

7MF4997-1BB

Cover, die-cast aluminum,  
with window

7MF4997-1BE

IE/WSN-PA LINK  
with integral,  
non-detachable antenna

6GK1411-6CA40-0AA0

IE/WSN-PA LINK

6GK1411-6CA40-0BA0

HART modem with USB interface

7MF4997-1DB

SIMATIC PDM

see Catalog FI 01, Chap. 8

### Overview



SITRANS TF280 for flexible and cost-effective temperature measurements

- Supports the WirelessHART standard (HART V 7.1)
- Very high security level for wireless data transmission
- Built-in local user interface (LUI) with 3-button operation
- Optimum display and readability using graphics display (104 x 80 pixels) with integrated background lighting
- Stand-by (deep sleep phase) on device can be turned on and off with a push of a button
- Battery power supply
- Battery service life up to 5 years
- Extend battery service life with HART modem interface which can be shut off
- Optimized power consumption through new design, and increase in battery service life
- Simple configuration thanks to SIMATIC PDM
- Housing meets IP65 degree of protection
- Supports all Pt100 sensors as per IEC 751/DIN EN 60751

### Benefits

The SITRANS TF280 is a temperature transmitter that features Wireless HART as the standard communication interface.

Also available is a wired interface to connect a HART modem:

- Flexible temperature measurement
- Save costs on wiring for difficult installation conditions. Wireless technology offers cost advantages in cases where extensive wiring costs would normally apply.
- It enables additional hitherto unfeasible measuring points, particularly for monitoring purposes
- Easy installation also on moveable equipment parts
- Enables cost-effective temporary measurements, for example for process optimizations.
- Optimum addition to wired communication and expansion of solution options for system solutions in process automation

### Application

The SITRANS TF280 is a WirelessHART field device for measuring temperature with a Pt100 sensor.

This sensor can be installed directly on the field device, or connected at an offset with a cable connection. On the wireless communication side, the transmitter supports the WirelessHART standard. A HART modem can be connected to the transmitter particularly for initial parameterization.

It can be used in all industries and applications in non-explosive areas.

### Design

The SITRANS TF280 has a robust aluminum enclosure and is suitable for outside use. It conforms with the IP65 safety class.

The operating temperature range is -40 to +80 °C (-40 to +176 °F). Power supply is provided through an integrated battery, which is available as an accessory. The device is only approved for operation with this battery.

The aerial features a rotatable joint which can be used for directional alignment. Wireless signals can thus be optimally received and transmitted.

A special highlight is the option for direct operation on the device. The operating strategy used in this case seamlessly integrates into the strategy of all new SIEMENS field devices.

Using the device's control buttons, it is easy to turn the HART modem interface of the device on and off. The device can be put to passive status and reactivated at any time. This helps to extend the service life of the battery.

The SITRANS TF280 transmitter features a cable gland or a Pt100 sensor including protective piping.

### Function

The SITRANS TF280 can integrate itself into a WirelessHART network. It can be parameterized and operated through this network. Measured process values are transported via the network to the SIEMENS IE/WSN-PA LINK.

Field device data received by the IE/WSN-PA LINK is transmitted to the connected systems, for example the process control system SIMATIC PCS 7. For an introduction to the mode of operation of WirelessHART, please see the FI 01 catalog chapter 8 or at <http://www.siemens.com/wirelesshart>.

Detailed information on IE/WSN-PA LINK can be found in the FI 01 catalog chapter 8 or at <http://www.siemens.com/wirelesshart>.

## Industrial Wireless Communication

### WirelessHART

#### SITRANS TF280, WirelessHART

#### Integration

##### Connecting to SIMATIC PCS 7

The integration of field devices in SIMATIC PCS 7 and other process control systems can now be done seamlessly and cost-effectively with wireless technology, especially in situations where high wiring costs may be expected. Of particular interest are measuring points which are to be added and for which no MSR wiring is available.

Where larger distances between the IW/WSN-PA LINK and control systems need to be overcome, this connection can also be implemented on a wireless and cost-effective basis using the products of the SCALANCE W family.

The Siemens WirelessHART devices are designed for optimum compatibility with products of the SCALANCE W family.

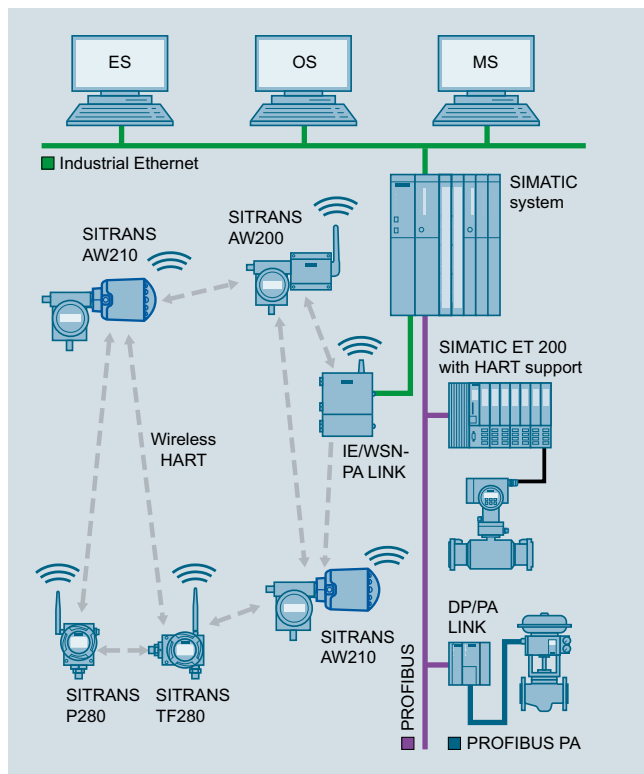

Integration of a meshed network into SIMATIC PCS 7

#### Configuration

Configuration of the SITRANS TF280 transmitter may be carried out as follows:

- Initial start-up for the SITRANS TF280 with SIMATIC PDM is generally carried out via a HART modem or the integrated local user interface, since the network ID and join key must be set up on the device before it can be accepted and integrated into the WirelessHART network.
- Once it is integrated into the network, the device can be conveniently operated with the WirelessHART network, the onsite HART modem or via the local user interface.

#### Technical specifications

The SITRANS TF280 can be mechanically installed in two ways:

- direct at the measuring point with a M20x1.5 thread  
Connection to other threads can be done via the adapter.
- offset from Pt100 sensor, which is connected to the transmitter via a cable

The details in the table below relate to the transmitter without taking into account a connected sensor, unless otherwise specified.

SITRANS TF280 WirelessHART temperature transmitter	
<b>Input</b>	
Sensor	Pt100 as per IEC 751/EN 60751 <sup>1)</sup>
• Sensor type	Pt100 as per IEC 751/EN 60751 <sup>1)</sup>
• Connection	Two, three or four-wire system
• Measuring range	-200 ... +850 °C (-328 ... +1560 °F)
Cable length SITRANS TF280 and Pt100 sensor element	≤ 3 m
<b>Measuring accuracy<sup>2)</sup></b>	
Accuracy	< 0.4 % of the measured value
Long-term drift	< 0.035 % of the measuring range in first year
Temperature drift	max. ±0.01 °C/10 K
<b>Conditions of use</b>	
Ambient temperature	-40 ... +80 °C (-40 ... +176 °F)
Storage temperature	-40 ... +85 °C (-40 ... +185 °F)
Relative humidity	< 95%
Climatic class	4K4H in accordance with EN 60721-3-4 (stationary use at locations not protected against weather)
Degree of protection	IP65/NEMA 4
Max. permissible temperature at transmitter for directly mounted Pt100	80 °C (176 °F)
<b>Design</b>	
Enclosure	Die-cast aluminum
Shock resistance	in accordance with DIN EN 60068-2-29 / 03.95
Resistance to vibration	DIN EN 60068-2-6/12.07
Weight	
• without battery	1.5 kg (3.3 lb)
• With battery	1.6 kg (3.5 lb)
Dimensions (W x H x D)	See "Catalog FI 01"
Thread for cable gland/sensor connection	M20x1.5 other threads via adapter
Cable between transmitter and sensor element	≤ 3 m for two-, three- or four-wire connections Cable resistance < 1 Ω (setting range in mΩ 0...9999)
Sensor break	Is recognized

## Technical specifications (continued)

SITRANS TF280 WirelessHART temperature transmitter	
<b>Displays and controls</b>	
Display (with illumination)	
• Size of display	104 x 80 pixels adjustable
• Number of digits	adjustable
• Number of spaces after comma	adjustable
Setting options	<ul style="list-style-type: none"> <li>• on site with 3 buttons</li> <li>• with SIMATIC PDM or HART Communicator</li> </ul>
<b>Auxiliary power</b>	
Battery	3.6 V DC
<b>Communication</b>	
Wireless standard	WirelessHART V7.1 conforming
Transmission frequency band	2.4 GHz (ISM-Band)
Range under reference conditions)	Up to 250 m (line of sight) in outside areas Up to 50 m (greatly dependent on obstacles) in inside areas
Communication interfaces	<ul style="list-style-type: none"> <li>• HART communication with HART modem</li> <li>• WirelessHART</li> </ul>
<b>Certificates and approvals</b>	
Wireless communication approvals	R&TTE, FCC
Pressure equipment directive	This device does not fall under the pressure equipment directive.

<sup>1)</sup> Preassembled Pt100: Class A (maximum MES:  $0.15 + 0.002 \cdot |t|$  °C)

<sup>2)</sup> Error calculation:

- Probable overall error =  $\ddot{O}(\text{MES2} + \text{AET2} + \text{LTD2} + \text{ATE2})$
- Maximum overall error =  $\text{MES} + \text{AET} + \text{LTD} + \text{ATE}$
- $|t|$ : Absolute total of the measured temperature
- MES: Measuring error of the sensor
- AET: Measuring error of the transmitter (A/D conversion)
- LTD: Long-term drift
- ATE: Drift via ambient temperature

## Ordering data

## Article No.

## Configuration

**SITRANS TF280 WirelessHART Temperature transmitter**  
(Required battery not included with delivery, see accessories)

**7MP1110 - 0 A** 

**Connections/cable entry**

Cable gland M20x1.5 <sup>1)</sup>  
Sensor pipe with Pt100, G½" male thread, pre-mounted and connected

**C**

**D**

**Display**

Digital display, visible

**1**

**Enclosure**

Die-cast aluminum

**1**

**Explosion protection**

Not included

**A**

**Antenna**

Variable, attached to device

**A**

## Further designs

Please add "-Z" to Article No. and specify Order code(s) and plain text.

Order code

- Measuring point number (TAG No.) max. 16 digits entered in plain text  
Y15: .....

**Y15**

- Measuring point message max. 27 characters entered in plain text:  
Y16: .....

**Y16**

## Accessories

Lithium battery for SITRANS TF280/P280

**7MP1990-0AA00**

Mounting bracket, steel

**7MF4997-1AC**

Mounting bracket, stainless steel

**7MF4997-1AJ**

Cover, die-cast aluminum, without window

**7MF4997-1BB**

Cover, die-cast aluminum, with window

**7MF4997-1BE**

Thread adapter M20x1.5 (male thread) on ½-14 NP (female thread)

**7MP1990-0BA00**

Thread adapter M20x1.5 (male thread) on G½B (female thread)

**7MP1990-0BB00**

IE/WSN-PA LINK with integral, non-detachable antenna

**6GK1411-6CA40-0AA0**

IE/WSN-PA LINK N connector for connection of external antennas

**6GK1411-6CA40-0BA0**

HART modem with USB interface

**7MF4997-1DB**

<sup>1)</sup> Please order sensor separately.

## Industrial Wireless Communication

### WirelessHART

#### SITRANS AW200 WirelessHART adapter

##### Overview



SITRANS AW200 WirelessHART Adapter

The SITRANS AW200 WirelessHART adapter is a battery-powered communication component, which integrates HART and 4 ... 20 mA field devices into a WirelessHART network. On the wireless communication side, the adapter supports the WirelessHART standard. HART and 4 ... 20 mA field devices are connected on the field device side.

The SITRANS AW200 WirelessHART adapter

- support the WirelessHART standard (HART V 7.1)
- features a very high degree of security for wireless data transmission
- integrates one 4 ... 20 mA field device or up to four HART field devices (in multidrop mode) into a WirelessHART network
- features intelligent energy management for the power supply of connected field devices
- can be easily parameterized using SIMATIC PDM

##### Benefits

- High quality and service life
- Save on wiring costs in difficult installation conditions (e.g. for moveable components) and for temporary installations.
- Subsequent integration of an installed field device with a HART interface into maintenance and diagnostic systems if the control system does not feature the required communication mechanisms. See page 9/3.
- Proven HART devices can continue to be used for wireless communication without any limitations.
- Field devices with a 4 ... 20 mA interface (without HART) can also be connected.
- Intelligent energy management to achieve the best possible service life for the installed battery unit
- Optimum addition to wired communication and expansion of solution options for system solutions in process automation
- Burst mode and event notification configuration for the adapter and connected field devices.

##### Application

The WirelessHART adapter can be used in a number of different applications:

- Access to installed basis  
Diagnostic information is obtained from existing wired HART devices thanks to the permanent electrical connection of a WirelessHART adapter, and is sent to system-based asset management software such as SITRANS MDS.
- Status monitoring of system  
Wireless devices are mounted at critical points in the system, which are not usually connected to the control room due to difficult accessibility or extensive costs for wiring. Better data flow and diagnostics increase plant reliability, transparency and safety.
- Process optimization  
Temporary installation of a 4 ... 20mA or standard HART device together with a SITRANS AW200 WirelessHART adapter allows easier, flexible monitoring and plant optimization at lower costs.
- Process monitoring  
Measured values, for example from tanks or silos, are transmitted to a higher-level system at regular intervals, together with the device and battery status.

### Design

SITRANS AW200 WirelessHART Adapter consists of

- An enclosure with a fitted aerial
- Electronics
- A high-performance lithium battery unit

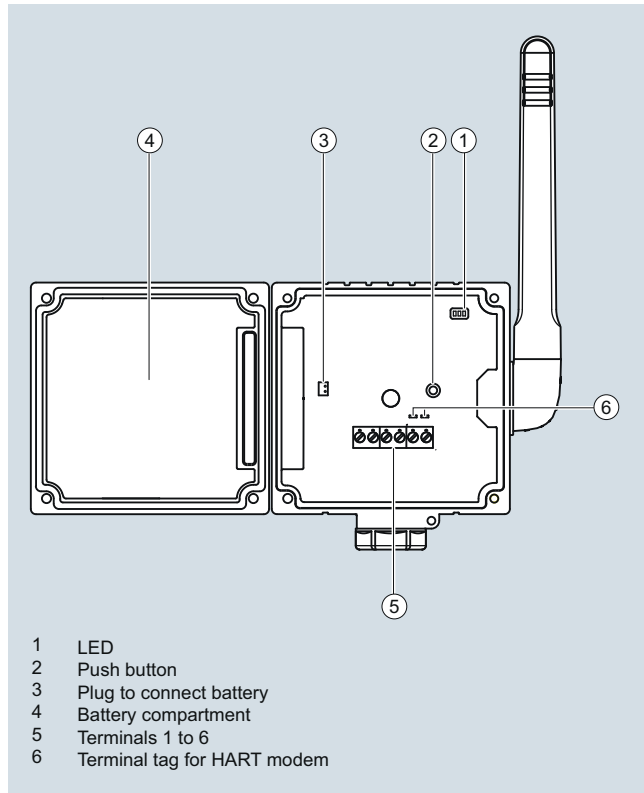

- 1 LED
- 2 Push button
- 3 Plug to connect battery
- 4 Battery compartment
- 5 Terminals 1 to 6
- 6 Terminal tag for HART modem

SITRANS AW200 Wireless-HART Adapter, assembly

The enclosure can be opened by loosening 4 screws. This enables you to access the electronics and battery unit. The battery unit is removed without the use of tools, since it is connected to the housing with clips.

On the back of the enclosure is the connector with a fixing nut onto which various different replaceable connecting pieces can be screwed to mount the adapter straight onto a field device.

On the base of the enclosure is an optional cable inlet which can be used for a cable gland. Up to 2 cables can be inserted for off-set adapter installation.

### Function

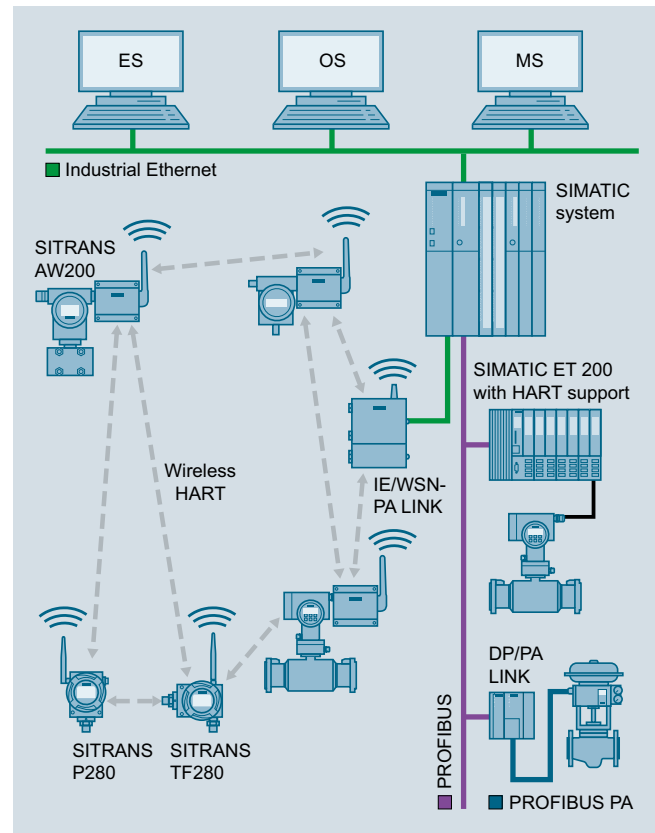

SITRANS AW200 WirelessHART Adapter. functional diagram

Measured values and diagnostic information of connected field devices with HART communication are transmitted via a wired connection to the WirelessHART adapter. The adapter transmits this information in the form of wireless signals to the IE/WSN-PA link, the Siemens WirelessHART gateway. From here, the information is available to the network of the system.

If a field device with a 4 ... 20 mA output signal is connected to the adapter, only the measured value will be transmitted.

Following configuration and integration into a WirelessHART network, each WirelessHART adapter is able to recognize its neighbors. It notes the strength of the wireless signal, synchronizes itself, receives network information and then establishes connections to its neighbors in the wireless network. A WirelessHART network organizes itself. Manual settings for organization are not required.

Two and four-wire field devices can be connected to a WirelessHART adapter. In the case of a connected two-wire field device, voltage can be supplied by the adapter. Where multiple two-wire field devices are connected (multi drop operation), the adapter must be connected to an external power supply.

The WirelessHART adapter may also be connected in parallel to an already existing installation which consists of a power supply and a HART field device.

## Industrial Wireless Communication

### WirelessHART

#### SITRANS AW200 WirelessHART adapter

##### Function (continued)

Interface	Connection	Function
1	—	Power supply for the field device
2	—	HART/4 ... 20 mA
3	—●	External supply/Dimensions
4	●—	High-resistance HART connection
5, 7	●—	High-resistance HART connection
6, 8	—●	Mass, high-resistance connection

Terminal block with 6 screw connection clamps

##### Parameterization

SITRANS AW200 configured via HART. Configuration can be carried out using a handheld communicator or, more conveniently, with a HART modem and the SIMATIC PDM configuration software.

Initial startup of the adapter is usually carried out via SIMATIC PDM and a HART modem or a handheld communicator. During initial startup, the network ID and join key are set in the adapter. These parameters are used to integrate the adapter into an existing WirelessHART network.

Following integration into the network, the adapter and HART devices connected can be conveniently operated via the WirelessHART network or with the local HART modem.

##### Siemens HART field devices for the adapter

HART and 4...20mA field devices can be connected to the SITRANS AW200 WirelessHART adapter. Depending on the electrical data of the field devices, they can receive their power supply from the WirelessHART adapter or will require an external power supply.

See <http://www.siemens.com/automation/service&support> for FAQ with the latest information on connectivity for Siemens field devices.

##### Note:

Siemens has only approved the Siemens HART field devices listed there for the adapter, and will only provide technical support for these devices.

Based on HART specifications, it is generally possible to connect devices that are not listed, however with the following limitations:

- All warranties and liability will be excluded
- No technical support

##### Technical specifications

Input	
Input	Point-to-Point connection to a HART field device or Point-to-Point connection to a 4 ... 20 mA field device or up to four HART field devices with external power supply which are integrated using the multidrop method
Communication	HART communication using multidrop method, 4 ... 20 mA power signal with Point-to-Point connection
Protocol	HART V7 (compatible with previous HART versions)
Transfer rate	1200 bits/s using HART multidrop method
Output	
Communication	WirelessHART V7
Transfer rate	Nominal 250 kBits/s
Transmission frequency band	2.4 GHz (ISM band)
Range (under reference conditions)	Outside areas up to 250 m, within buildings up to 50 m
RF signal strength	Can be configured: 0 dBm and 10 dBm
Output signals	Measured voltage and up to three other variables may be selected from the following: adapter temperature, battery voltage, energy consumed, expected battery service life
<ul style="list-style-type: none"> <li>• WirelessHART Adapter</li> <li>• 4 ... 20 mA field device</li> <li>• HART field device</li> </ul>	Scaled or linearized process values up to four process variables, can be configured via PDM or gateway
Measuring accuracy (as per reference conditions IEC 61298-2)	
Max. measuring error (4 ... 20 mA circuit)	0.125 % re: measuring range
Effect of ambient temperature (4 ... 20 mA circuit)	5 $\mu$ A/0°K
Rated conditions	
Location	Outside/Inside
Ambient conditions	
<ul style="list-style-type: none"> <li>• Ambient temperature</li> </ul>	-40 ... +80 °C (-40 ... +176 °F)
<ul style="list-style-type: none"> <li>• Storage temperature</li> </ul>	The capacity of the battery decreases rapidly if ambient temperature falls below -30 °C. -40 ... +85 °C (-40 ... +185 °F) without batteries < 21 °C with batteries
<ul style="list-style-type: none"> <li>• Relative humidity</li> </ul>	Max 90 % at 25 °C (non-condensating)
<ul style="list-style-type: none"> <li>• Resistance to vibration</li> </ul>	20 ≤ f ≤ 2000 Hz: 0.01 g <sup>2</sup> /Hz as per IEC 68-2-64
<ul style="list-style-type: none"> <li>• Shock resistance</li> </ul>	15 g, 11 ms as per IEC 68-2-27
Electromagnetic compatibility	As per EN 61326, EN 301 489-1/17 and NAMUR NE 21



### Technical specifications (continued)

Design	
Weight	0.5 kg without battery, 0.75 kg with battery
Enclosure	
• Material	Polyester (PBT FR)
• Cable entry	2x M20x1.5
Degree of protection	IP65, IP66; NEMA 4
Aerial	Omnidirectional dipolar aerial, vertical rotation
Mounting adapter	M20x1.5 on M20x1.5, M20x1.5 on G½, M20x1.5 on ½ - 14 NPT, M20x1.5 on ¾ - 14 NPT
Auxiliary power	
Battery	Lithium thionylchlorid high-performance battery unit
Power supply	5 V DC ... 7.2 V DC
Capacity	19 AH at 20 °C
Service life	5 ... 7 years, depending on update rate, connected field device and ambient conditions
Field device voltage supply (not in multidrop mode)	
• No-load voltage	8 ... 23 V DC
• Current	4 ... 20mA (in accordance with NAMUR Recommendation NE 43)
• Fault current (not with multidrop)	$I \leq 3.6 \text{ mA}$ or $I \geq 21 \text{ mA}$
• Protection	Short-circuit proof, activated at voltages > 25 mA
Voltage supply for one or more field devices (in multidrop mode)	
• Power	< 30 V direct current
• Current	< 25 mA
Certificates and approvals	
Wireless communication approvals	ETSI (R&TTE) FCC Part 15.247 for wireless applications in the 2.4 GHz transmission frequency band EN 300 328

### Ordering data

### Article No.

#### Configuration

Configuration	Article No.
<b>SITRANS AW200 adapter for Wireless HART Communication</b>	<b>7MP3112 - 0 - 0 A A 0</b>
<b>WirelessHART adapter AW200 with 4 ... 20 mA- or HART interface</b>	
Without battery	1
<b>Power supply</b>	
Battery powered	A
<b>Certificates and approvals<sup>1)</sup></b>	
Without	A
<b>Enclosure</b>	
Polyester	0

#### Accessories

Lithium battery for SITRANS AW200	<b>7MP3990-0AA00</b>
Thread adapter for direct mounting of the adapter to a field device	
• M20 thread adapter	<b>7MP3990-0BA00</b>
• Thread adapter G½	<b>7MP3990-0BB00</b>
• Thread adapter ½" - 14 NPT	<b>7MP3990-0BC00</b>
• Thread adapter ¾" - 14 NPT	<b>7MP3990-0BD00</b>
Mounting bracket for attaching to wall/pipe, material: stainless steel SS304, including cable gland	<b>7MP3990-0CA00</b>

<sup>1)</sup> Additional approvals in process

#### Note:

Circuit diagrams and dimensional drawings can be found in Catalog FI 01.

## Industrial Wireless Communication

### WirelessHART

#### SITRANS AW210 WirelessHART adapter

##### Overview



SITRANS AW210 WirelessHART adapter

The WirelessHART adapter SITRANS AW210 is a communication component which can integrate a wide range of field devices into a WirelessHART network. On the wireless communication side, the adapter supports the WirelessHART standard. HART and 4 to 20 mA field devices are connected on the field device side.

The WirelessHART adapter SITRANS AW210

- Supports the WirelessHART standard (HART V 7.1)
- Features an extremely high degree of security for wireless data transmission.
- Integrates a 4 to 20 mA field device into a WirelessHART network
- Integrates up to eight HART field devices (in multidrop mode) into a WirelessHART network
- Can be powered with the 4 to 20 mA loop or an external power supply
- Power management can be activated to minimize energy consumption
- Easy to configure with SIMATIC PDM, AMS, Handheld 475.

##### Benefits

- "Intrinsically safe" or "Explosion proof"
- High quality and service life
- Extremely rugged enclosure
- No additional cabling required with loop power supply
- Subsequent integration of an installed field device with HART interface into maintenance and diagnostic systems if the control system does not feature the required communication mechanisms
- Proven HART devices can continue to be used for wireless communication without any limitations
- Field devices with a 4 to 20 mA interface (without HART) can also be connected
- Ideal addition to wired communication and to the range of system solutions in process automation
- Burst mode and event notification configuration for the adapter and connected field devices

##### Application

The WirelessHART adapter can be used in a number of different applications:

- Access to installed basis  
Diagnostic information is obtained from existing wired HART devices thanks to the permanent electrical connection of a WirelessHART adapter and power from the 4 to 20 mA loop. This information is sent to central system-based asset management software such as SITRANS MDS.
- Status monitoring of the plant  
Wireless devices are mounted at critical points in the plant which are not usually connected to the control room due to difficult access or high wiring costs. Better data flow and diagnostics increase plant reliability, transparency and safety.
- Process optimization  
Temporary installation of a 4 to 20mA or standard HART device together with a SITRANS AW210 WirelessHART adapter allows easier, flexible monitoring and plant optimization at lower costs. SITRANS AW210 can also be usefully used where there is already an external power supply, or one is needed anyway.
- Process monitoring  
Measured values, for example from tanks or silos, are transmitted to a higher-level system at regular intervals together with the device status. SITRANS AW210 is particularly easy to use with 4-wire devices, as they have an external power supply.

##### Design

SITRANS AW210 WirelessHART Adapter consists of:

- An enclosure with a fitted aerial
- Electronics

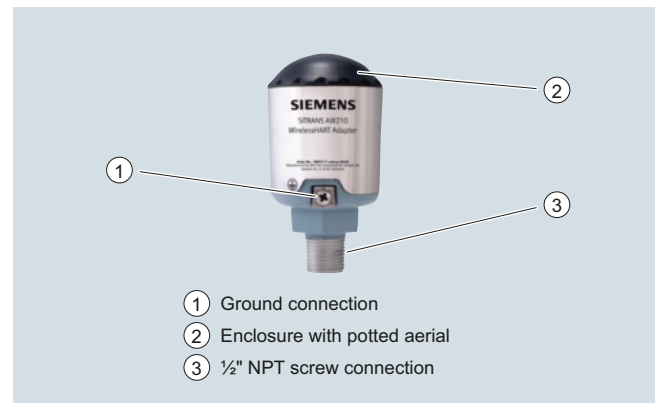

SITRANS AW210 Wireless-HART Adapter, assembly

The enclosure contains the potted electronics and the wireless module. The aerial is fitted at the top in the enclosure.

On the base of the enclosure is the connector with a 1/2" NPT female thread. Six cables run from this connector to connect the adapter.

### Function

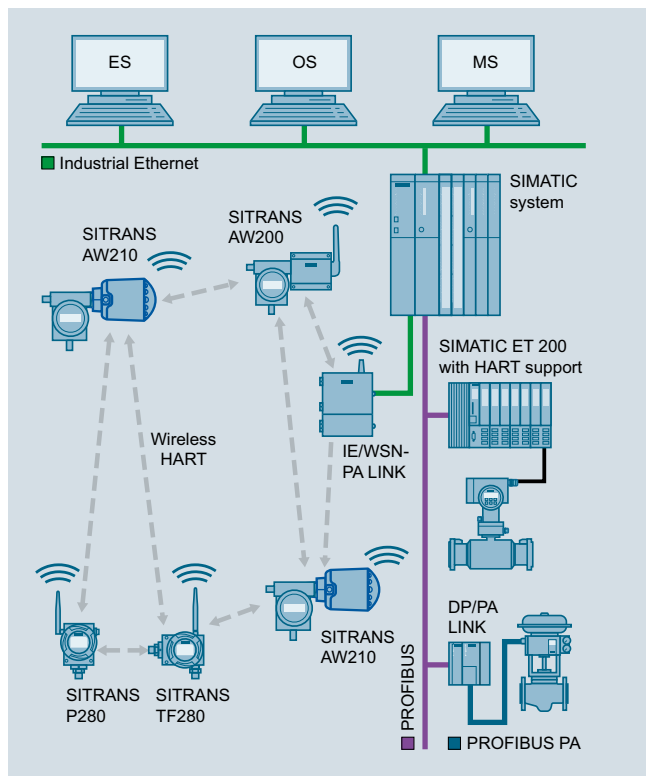

SITRANS AW210 WirelessHART Adapter, functional diagram

The measured values and diagnostic information from the connected field devices with HART communication are transmitted to the WirelessHART adapter over wired connections. The adapter transmits this information as wireless signals to the IE/WSN-PA link, the Siemens WirelessHART gateway. The measured values, all parameters and diagnostic information about the plant network can be accessed from this gateway.

If a field device with a 4 to 20 mA output signal is connected to the adapter, the current will be converted to a digital measured value and transmitted on the basis of a measuring range specified in SITRANS AW210.

Following configuration and integration into a WirelessHART network, each WirelessHART adapter is able to recognize its neighbors. It notes the strength of the wireless signal, synchronizes itself, receives network information and then establishes connections to its neighbors in the wireless network. A WirelessHART network organizes itself. Manual settings for organization are not required.

Two-wire and four-wire field devices can be connected to a WirelessHART adapter. Either up to 2 or up to 8 HART field devices can be connected to the adapter, depending on the selected product version. The adapter either has an external voltage supply or is loop-powered. The WirelessHART adapter can therefore also be connected in parallel to an existing installation consisting of a voltage supply and a HART field device.

### Parameter assignment

SITRANS AW210 is configured via HART. Configuration can be carried out using handheld communicator 475 or, more conveniently, with a HART modem and the SIMATIC PDM configuration software.

Initial startup of the adapter is usually carried out via SIMATIC PDM and a HART modem or a handheld communicator. During initial startup, the network ID and join key are set in the adapter. These parameters are used to integrate the adapter into an existing WirelessHART network.

Following integration into the network, the adapter and HART devices connected can be conveniently operated via the WirelessHART network or locally, as detailed above.

### Siemens HART field devices for the adapter

In principle, all HART devices certified by the HART Communication Foundation (HCF) can be operated with the SITRANS AW210 WirelessHART adapter. See <http://www.siemens.com/automation/service&support> for FAQ with the latest information on connectivity for Siemens field devices.

### Note:

Siemens has only approved the Siemens HART field devices listed there for the adapter, and will only provide technical support for these devices.

Based on HART specifications, it is generally possible to connect devices that are not listed, however with the following restrictions:

- All warranties and liability will be excluded
- No technical support

# Industrial Wireless Communication

## WirelessHART

### SITRANS AW210 WirelessHART adapter

#### Technical specifications

<b>Input</b>	Point-to-point connection to a HART field device or Point-to-point connection to a 4 ... 20 mA field device or Up to eight HART field devices with an external voltage supply integrated using multidrop	<b>Update time for output signals</b>	You can set the update times separately for the adapter and the connected devices. The possible settings are: • 1, 2, 4, 8, 16, 32 s • 1, 2, 5, 10, 30, 60 min (times also depend on the gateway)
Communication	<ul style="list-style-type: none"> <li>• HART communication with multidrop, as primary or secondary HART master (can be specified)</li> <li>• 4 ... 20 mA current signal with a point-to-point connection scaling in user-defined measuring range in SITRANS AW210               <ul style="list-style-type: none"> <li>- Linear</li> <li>- User-defined scaling with up to 32 points</li> </ul> </li> </ul>	<b>Measuring accuracy</b>	Max. measuring error (4 ... 20 mA circuit) 1 % of measuring range, 40 ... 85 °C (104 ... 185 °F)
Protocol	HART V7 (compatible with previous HART versions)	<b>Rated conditions</b>	<b>Location</b> Outside/inside  <b>Ambient conditions</b> <ul style="list-style-type: none"> <li>• Ambient temperature -40 ... +85 °C (-40 ... +185 °F) In hazardous areas up to 75 °C (167 °F)</li> <li>• Storage temperature -40 ... +85 °C (-40 ... +185 °F)</li> </ul> <b>Electromagnetic compatibility</b> To EN 301 489-17 and EN 300 328-1
<b>Output</b>		<b>Design</b>	
Communication	WirelessHART V7	Weight	0.46 kg (1.01 lb)
Transmission frequency band	2.4 ... 2.4835 GHz (ISM band), 16-channel frequency hopping spread spectrum	Enclosure	Enclosure: Aluminum alloy, RoHS-compliant polyurethane corrosion-resistant coating Cap: Resin
Range (under reference conditions)	Outside up to 235 m (771.00 ft)	• Material	½" NPT female thread
RF signal strength	10 dBm	• Cable entry	IP68
<u>Output signals</u>		Degree of protection	IP68
• WirelessHART adapter	<ul style="list-style-type: none"> <li>• HART Cmd 3 Measured current and up to 4 other dynamic variables (measured values, derived values) or device variables</li> <li>• HART Cmd 9 Up to 8 dynamic variables with status</li> <li>• HART Cmd 48 Additional status information</li> </ul>	Aerial	Potted in enclosure
• 4 ... 20 mA field device	Scaled or linearized process values	<b>Auxiliary power</b>	
• HART field device	<ul style="list-style-type: none"> <li>• HART Cmd 3 Measured current and up to 4 other dynamic variables (measured values, derived values) or device variables</li> <li>• HART Cmd 9 Up to 8 dynamic variables with status</li> <li>• HART Cmd 48 Additional status information</li> </ul>	Power supply	Loop power 1 ... DC 2.5 V, can be set by user in 0.5 V DC increments
		Loop-powered, operating current	DC 3.2 ... 25 mA operating current; overvoltage, surge and reverse polarity protection
		<b>Certificates and approvals</b>	
		Wireless communication approvals	<ul style="list-style-type: none"> <li>• CE (R&amp;TTE, EMC)</li> <li>• FCC Part 15.247 for wireless applications in the 2.4 GHz transmission frequency band</li> <li>• IC</li> </ul>

#### Technical specifications (continued)

Explosion protection	
Intrinsic safe "i" gases and vapors	II 1G Ex ia IIC T*; IP68 T* = T5 for Ta = -40 ... +85 °C T* = T6 for Ta = -40 ... +75 °C
Intrinsic safe dust	II 1 D Ex iaD 20 IP68 T95C; Ta = -40 ... +85 °C
Non-sparking (zone 2)	II 3 G Ex nA nC IIC T* Gc; IP68 T* = T5 for Ta = -40 ... +85 °C T* = T6 for Ta = -40 ... +75 °C
Explosion protection to FM for US Intrinsic safe, Non-sparking	IS/I,II,III/1/ABCDEFGH/ T5 Ta = -40 ... +85 °C, T6 Ta = -40 ... +75 °C NI/I/2/ABCD/ T5 Ta = -40 ... +85 °C, T6 Ta = -40 ... +75 °C S/II,III/2/EFG/ T5 Ta = -40 ... +85 °C, T6 Ta = -40 ... +75 °C I/0/AEx ia/IIC/ T5 Ta = -40 ... +85 °C, T6 Ta = -40 ... +75 °C; 20/AEx iaD/T95°C; Ta = -40 ... 85°C I/2/AEx nA nC/IIC/ T5 Ta = -40 ... +85 °C, T6 Ta = -40 ... +75 °C; IP68
Explosion protection to FM for CA Intrinsic safe, Non-sparking	IS/I,II,III/1/ABCDEFGH/ T5 Ta = -40 ... +85 °C, T6 Ta = -40 ... +75 °C; NI/I/2/ABCD/ T5 Ta = -40 ... +85 °C, T6 Ta = -40 ... +75 °C; S/II,III/2/EFG/ T5 Ta = -40 ... +85 °C, T6 Ta = -40 ... +75 °C; I/0/Ex ia/IIC/ T5 Ta = -40 ... +85 °C, T6 Ta = -40 ... +75 °C; I/2/Ex nA nC/IIC/ T5 Ta = -40 ... +85 °C, T6 Ta = -40 ... +75 °C II/1/EFG Ta = -40 ... +85°C; IP68
Flameproof gases and vapors	II 2 G Ex d IIC T* Gb; IP68 T* = T5 for Ta = -40 ... +85 °C T* = T6 for Ta = -40 ... +75 °C
Protection by enclosure dust	II 2 D Ex tb IIIC T95°C Ta = -40 ... +85°C; IP68
Explosion protection to FM for US Explosionproof, flameproof, gas, dust	XP/II/1/ABCD I/1 AEx d IIC T5, T6 Gb DIP/II,III/1/EFG 21/AEx tb IIIC T95°C T5 Ta = -40 ... +85°C, T6 Ta = -40 ... +75°C Type 6P, IP68
Explosion protection to FM for CA Explosionproof, flameproof, gas, dust	XP/II/1/ABCD I/1 Ex d IIC T5, T6 Gb DIP/II,III/1/EFG T5 Ta = -40 ... +85°C, T6 Ta = -40 ... +75°C

#### Ordering data

#### Article No.

##### Configuration

**SITRANS AW210 Adapter for WirelessHART Communication**      **7MP3111 - ■ ■ ■ ■ 0 - 0 A A 0**

##### WirelessHART-Adapter AW210 with 4 ... 20 mA- or HART-interface

- 2 devices      **1**
- 8 devices      **2**

##### Auxiliary power

Loop powered or 24 VDC (external)      **A**

##### Certificates and approvals

Intrinsically safe gas, vapors and dust (ATEX), Intrinsic Safe (FM)      **B**

Explosionproof gas, vapour and dust (ATEX), Explosionproof (FM)      **C**

##### Enclosure

Aluminum      **0**

#### Note:

Circuit diagrams and dimensional drawings can be found in Catalog FI 01.

## Industrial Wireless Communication

### WirelessHART

#### IE/WSN-PA LINK

#### Overview



- The IE/WSN-PA LINK is a network transition for the connection of WirelessHART field devices (HART V7.1) to Industrial Ethernet, as an alternative or supplement to the wired connection.
- Connection of up to 100 WirelessHART devices
- Approved for operation in hazardous areas in Zone 2
- Open TCP/IP communication and Modbus TCP via the Ethernet interface
- Can be used with HART-OPC servers of the HART Communication Foundation

#### Note:

A general introduction to WirelessHART and information on the WirelessHART adapter and the WirelessHART field devices can be found in Catalog FI 01 or on the Internet at <http://www.siemens.com/wirelesshart>

#### Benefits



- Extended possible solutions for connecting process industry field devices by means of alternative or supplementary WirelessHART communication
- Reliable data transmission using intermeshed network technology; the self-organizing network with alternative paths enables radio obstacles to be bypassed
- Reduction of cabling costs under difficult installation conditions, e.g. if the field devices are located on inaccessible plant components or are only required temporarily
- To improve process monitoring and for maintenance tasks, sensors can be retrofitted
- Existing transmitters can be integrated wirelessly into maintenance and diagnostics systems by means of WirelessHART adapters
- Without additional software, restricted monitoring is possible via web services and the integrated web server of the IE/WSN-PA LINK.

#### Application

The IE/WSN-PA LINK connects wireless HART field devices by radio to the Ethernet. On the radio side, the IE/WSN-PA LINK supports the WirelessHART standard and on the Ethernet side the TCP/IP and Modbus TCP communication.

The IE/WSN-PA LINK thus enables wireless diagnostics, maintenance and process monitoring.

#### Monitoring

WirelessHART is particularly suitable for use in plant sections that are to be included in monitoring, but which do not have any existing MSR cabling, e.g. external tank stores or other installations where high cabling costs are anticipated. Data for the visualization can be retrieved from the IE/WSN-PA link via Industrial Ethernet or Modbus TCP.

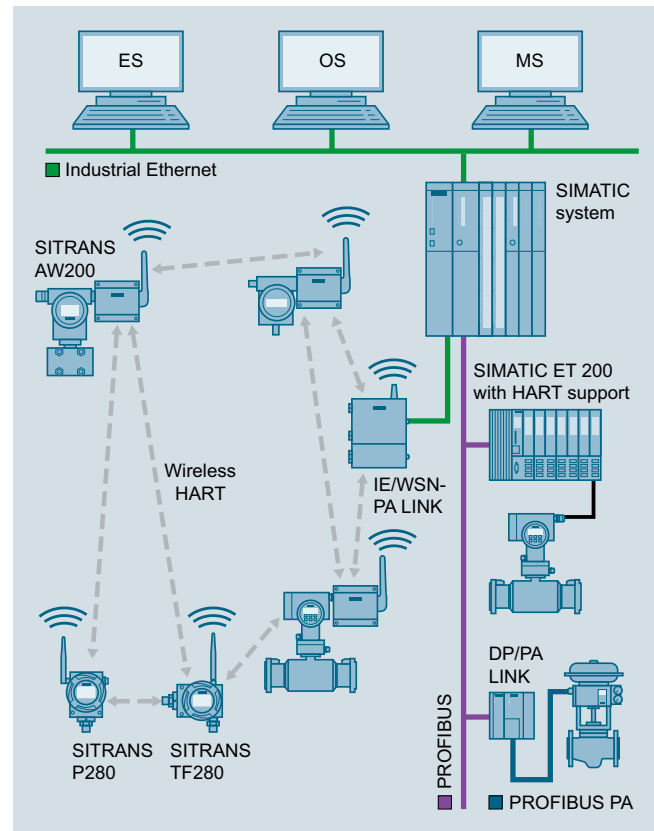

Monitoring of process states via WirelessHART

**Application** (continued)**Retrofitting for diagnostics and maintenance**

For this application, wireless adapters are looped into the 4-20 mA interface or screwed directly onto the HART device. The acyclic HART message frames are transmitted by radio between IE/WSN-PA LINK and a wireless adapter. Without affecting the operation of the plant, the wireless adapter modulates the acyclic HART message frames to the 4-20 mA interface or extracts them from the 4-20 mA interface.

The IE/WSN-PA LINK collects the data of all wireless adapters and transfers it via Industrial Ethernet to the diagnostics and maintenance station.

If greater distances between the IE/WSN-PA LINK and the monitoring station are to be spanned without cabling, this can be implemented by means of Industrial Wireless LAN with the access points and client modules of the SCALANCE W family.

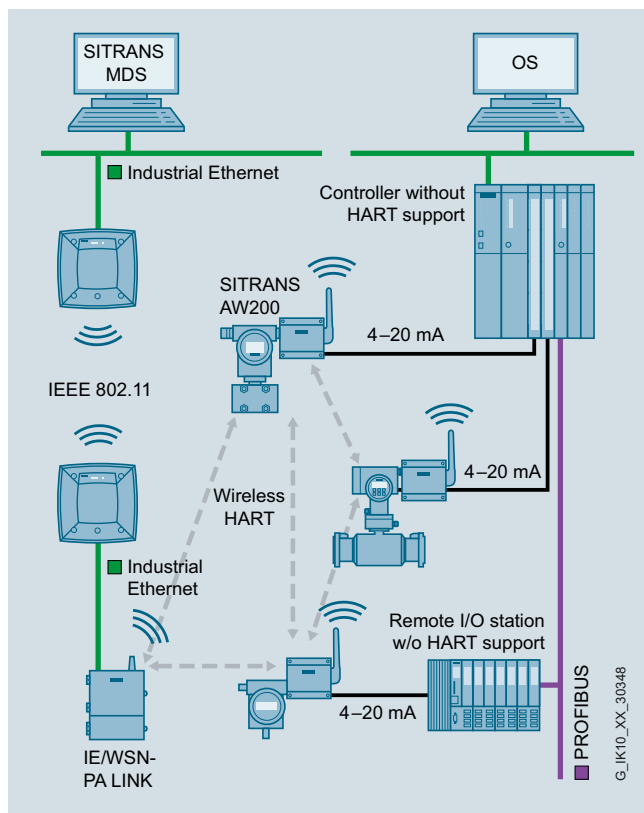

Retrofitting of plants for diagnostics and maintenance

**Design**

- 2 x 10/100/1 000 Mbit/s RJ45 ports, electrical (no integral switch; interfaces can be used, for example, for continuous connection to the plant network as well as the temporary connection of a PC)
- 1 x screw terminal for connection to Modbus RTU via RS485
- 1 x screw terminal for the 24 V DC connection
- Rugged metal enclosure with IP65 protection for use outdoors, also in hazardous zone 2
- Mounting: wall or mast mounting (vertical); U-bolts for mast mounting are included in the scope of delivery.

**Product versions**

- With integral, non-detachable antenna
- Redundancy function and with N connector for connection of an external antenna

**Function****WirelessHART**

The IE/WSN-PA LINK establishes on the radio side an inter-meshed wireless sensor network for communication with wireless field devices (e.g. transmitters). The data from the wireless field devices is received by the IE/WSN-PA LINK and transmitted via Industrial Ethernet to the connected systems. The supported wireless network is an open wireless network specified by the HART Communication Foundation (HCF) in accordance with the WirelessHART (HART V7.1) standard.

On the field device side, the IE/WSN-PA LINK requires field devices that support WirelessHART (HART). Existing field devices can be integrated by means of wireless adapters into the WirelessHART communication. To this end, the adapters are looped into the 4-20 mA interface. In addition, as many as four standard HART field devices with external power supply can be connected to the adapter in multidrop mode. Individually connected devices can be operated with the battery of the adapter.

The adapter wirelessly transmits all data and process values of the connected devices. The advantage of this solution is that tried and tested devices can continue to be used.

**Industrial Ethernet**

Via the Ethernet interface the IE/WSN-PA LINK supports the use of the HART OPC server and the Modbus TCP protocol.

**Configuration**

The configuration is web-based, without additional software, and performed from the PC. By means of the web user interface it is also possible to display the device states and measured values of the WirelessHART devices.

## Industrial Wireless Communication

### WirelessHART

#### IE/WSN-PA LINK

##### Function (continued)

##### **Increased availability of WirelessHART application due to redundancy mode**

For increased availability requirements, the link can be used redundantly. The redundancy function is only available for the device variant with a connection for an external antenna.

Two links are connected to the same Ethernet subnet via a switch to provide the redundancy. The two links are connected to each other via an Ethernet cable (management coupling). One of the two links is configured as the active device. It carries out the communication between the control center and the WirelessHART wireless network under normal conditions. The second link is configured identically. It is used as a standby device. In a redundancy scenario, the standby device becomes the active device.

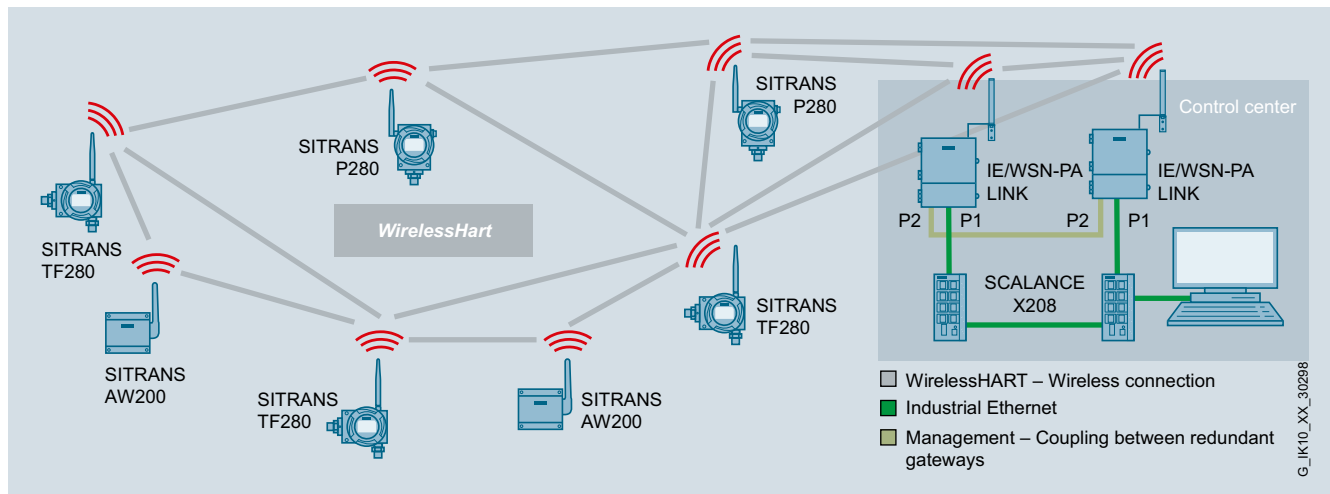

##### Integration

##### **Integration into automation systems**

The IE/WSN-PA LINK can be integrated into automation systems via Ethernet or Modbus TCP. Communication modules (CP 343-1 or CP 443-1) are required to connect the IE/WSN-PA LINK to SIMATIC S7-300/400. Function blocks and technical support can be found at:

[www.siemens.com/simatic-net/ik-info](http://www.siemens.com/simatic-net/ik-info)

##### **Integration in PCS 7**

For integration of the IE/WSN-PA LINK into PCS 7 you can obtain function blocks and technical support at:

[www.siemens.com/simatic-net/ik-info](http://www.siemens.com/simatic-net/ik-info)



## Technical specifications

Article No.	6GK1411-6CA40-0AA0	6GK1411-6CA40-0BA0
Product-type designation	IE/WSN-PA LINK	IE/WSN-PA LINK
<b>Transfer rate</b>		
• at the interface 1	10 ... 100 Mbit/s	10 ... 100 Mbit/s
• at the interface 2	10 ... 100 Mbit/s	10 ... 100 Mbit/s
• at interface 3	9.6 ... 57.6 kbit/s	9.6 ... 57.6 kbit/s
<b>Interfaces</b>		
Number of electrical connections		
• at interface 1 in accordance with Industrial Ethernet	1	1
• at interface 2 in accordance with Industrial Ethernet	1	1
• at interface 3 in accordance with RS 485	1	1
• for power supply	1	1
Design of electrical connection		
• at interface 1 in accordance with Industrial Ethernet	RJ 45 port	RJ 45 port
• at interface 2 in accordance with Industrial Ethernet	RJ 45 port	RJ 45 port
• at interface 3 in accordance with RS 485	2-pole terminal strip	2-pole terminal strip
• for power supply	3-pole terminal strip	3-pole terminal strip
<b>Interfaces wireless</b>		
Number of radio cards permanently installed	1	1
Number of internal antennas	1	0
Number of electrical connections for external antenna(s)	0	1
Design of the electrical connection for external antenna(s)	-	N-Connector
<b>Supply voltage, current consumption, power loss</b>		
Type of voltage supply	DC	DC
Supply voltage external	24 V	24 V
• minimum	20 V	20 V
• maximum	28 V	28 V
Consumed current from external supply voltage at 24 V with DC maximum	0.5 A	0.5 A
Active power loss maximum	12 W	12 W
<b>Permitted ambient conditions</b>		
Ambient temperature		
• during operating	-40 ... +70 °C	-40 ... +70 °C
• during storage	-40 ... +85 °C	-40 ... +85 °C
• during transport	-40 ... +85 °C	-40 ... +85 °C
Relative humidity at 25 °C without condensation during operating maximum	90 %	90 %
Protection class IP	IP 65	IP 65
<b>Design, dimensions and weight</b>		
Width of the housing	229 mm	229 mm
Height of the enclosure		
• without antenna	306 mm	306 mm
• with antenna	354 mm	354 mm
Depth of the housing	89 mm	89 mm
Net weight	4.54 kg	4.54 kg
Mounting type		
• wall mounting	Yes	Yes
• mast mounting	Yes	Yes
Mounting type	Material for mast mounting included in scope of delivery	Material for mast mounting included in scope of delivery

# Industrial Wireless Communication

## WirelessHART

### IE/WSN-PA LINK

#### Technical specifications (continued)

Article No.	6GK1411-6CA40-0AA0	6GK1411-6CA40-0BA0
Product-type designation	IE/WSN-PA LINK	IE/WSN-PA LINK
<b>Wireless frequencies</b>		
Radio frequency for WirelessHART in 2.4 GHz frequency band		
• initial value	2.4 GHz	2.4 GHz
• end value	2.5 GHz	2.5 GHz
<b>Performance data WirelessHART</b>		
Number of WirelessHART devices can be operated	100	100
Network latency		
• for 100 field devices for WirelessHART network maximum	10 s	10 s
• for 50 field devices for WirelessHART network maximum	5 s	5 s
Transmission link between two devices for WirelessHART network		
• maximum	100 m	100 m
• note	Values may vary in the case of radio obstacles	Values may vary in the case of radio obstacles
Protocol is supported HARD	Yes	Yes
<b>Product properties, functions, components general</b>		
Protocol is supported		
• Address Resolution Protocol (ARP)	Yes	Yes
• HTTP	Yes	Yes
• HTTPS	Yes	Yes
• Modbus TCP	Yes	Yes
• Modbus TCP secure	Yes	Yes
• Modbus RTU	Yes	Yes
<b>Product functions management, configuration</b>		
Product function		
• web-based management	Yes	Yes
• DHCP client	Yes	Yes
<b>Product functions Diagnosis</b>		
Product function		
• Web-based diagnostics	Yes	Yes
• WirelessHART diagnostics via Modbus	Yes	Yes
<b>Product functions Redundancy</b>		
Product function device redundancy	No	Yes
<b>Product functions Security</b>		
Product function		
• Password protection - multi-level	Yes	Yes
• WirelessHART Join Key	Yes	Yes
• ACL - MAC-based	Yes	Yes
• WirelessHART Network ID	Yes	Yes
Protocol is supported SSL	Yes	Yes
Principle of encryption	AES 128 bit	AES 128 bit
<b>Product functions Time</b>		
Protocol is supported NTP	Yes	Yes

## Technical specifications (continued)

Article No.	6GK1411-6CA40-0AA0	6GK1411-6CA40-0BA0
Product-type designation	IE/WSN-PA LINK	IE/WSN-PA LINK
<b>Standards, specifications, approvals</b>		
Standard for WirelessHART	HART V 7.1	HART V 7.1
Standard for wireless communication IEEE 802.15.4	Yes	Yes
Verification of suitability		
• CE mark	Yes	Yes
• concerning CSA	CSA Division 2 & Dust Ignition-proof for Class I, Division 2, Groups A, B, C, and D. Dust Ignition-proof for Class II, Groups E, F, and G / Suitable for Class III Hazardous Locations. / Install per Siemens drawing A5E02467236A. Temperature Code: T4 (-40°C < Ta < 60°C) CSA Enclosure Type 4X	CSA Division 2 & Dust Ignition-proof for Class I, Division 2, Groups A, B, C, and D. Dust Ignition-proof for Class II, Groups E, F, and G / Suitable for Class III Hazardous Locations. / Install per Siemens drawing A5E02467236A. Temperature Code: T4 (-40°C < Ta < 60°C) CSA Enclosure Type 4X
• concerning FM	FM Division 2, Non-Incendive for Class I, Division 2, Groups A, B, C, and D. Dust Ignition-proof for Class II, III, Division 1, Groups E, F, and G / Indoor and outdoor locations / NEMA Type 4X Temperature Code: T4 (-40°C < Ta < 60°C)	FM Division 2, Non-Incendive for Class I, Division 2, Groups A, B, C, and D. Dust Ignition-proof for Class II, III, Division 1, Groups E, F, and G / Indoor and outdoor locations / NEMA Type 4X Temperature Code: T4 (-40°C < Ta < 60°C)
• concerning ATEX	ATEX type n, see note: certificate number: Baseefa10ATEX0044X, ATEX marking: Ex II 3 G, Ex nA nL IIC T4 (-40°C <= Ta <= 60°C), rated voltage: 28 V, ATEX dust ignition-proof: certificate number: Baseefa10ATEX0045X, ATEX marking: II 3D, Ex tD A22 IP66 T135 (-40°C <= Ta <= 60°C), rated voltage: 28 V. Note on type n: conditions for safe handling during installation. The device does not pass the 500 V insulation test in accordance with paragraph 6.8.1 of EN 60079-15:2005. This must be taken into account when the device is mounted.	ATEX type n, see note: certificate number: Baseefa10ATEX0044X, ATEX marking: Ex II 3 G, Ex nA nL IIC T4 (-40°C <= Ta <= 60°C), rated voltage: 28 V, ATEX dust ignition-proof: certificate number: Baseefa10ATEX0045X, ATEX marking: II 3D, Ex tD A22 IP66 T135 (-40°C <= Ta <= 60°C), rated voltage: 28 V. Note on type n: conditions for safe handling during installation. The device does not pass the 500 V insulation test in accordance with paragraph 6.8.1 of EN 60079-15:2005. This must be taken into account when the device is mounted.
• regarding IECEx	IECEx type n, see note: certificate number: IECEx BAS 10.0014X, Ex nA nL IIC T4 (-40°C <= Ta <= 60°C), rated voltage: 28 V, IECEx dust ignition-proof, see note: certificate number: IECEx BAS 10.0015X, Ex tD A22 IP66 T135 (-40°C <= Ta <= 60°C), rated voltage: 28 V. Note on type n: conditions for safe handling during installation. The device does not pass the 500 V insulation test in accordance with paragraph 6.8.1 of EN 60079-15:2005. This must be taken into account when the device is mounted.	IECEx type n, see note: certificate number: IECEx BAS 10.0014X, Ex nA nL IIC T4 (-40°C <= Ta <= 60°C), rated voltage: 28 V, IECEx dust ignition-proof, see note: certificate number: IECEx BAS 10.0015X, Ex tD A22 IP66 T135 (-40°C <= Ta <= 60°C), rated voltage: 28 V. Note on type n: conditions for safe handling during installation. The device does not pass the 500 V insulation test in accordance with paragraph 6.8.1 of EN 60079-15:2005. This must be taken into account when the device is mounted.
• regarding NEMA	-	-
Wireless approval	FCC and IC approval	IC approval

# Industrial Wireless Communication

## WirelessHART

### IE/WSN-PA LINK

#### Ordering data

##### IE/WSN-PA LINK

Gateway between WirelessHART and Industrial Ethernet; transmission frequency: 2.4 GHz

- With integral, non-detachable antenna
- N connector for connection of external antennas

**6GK1411-6CA40-0AA0**

**6GK1411-6CA40-0BA0**

##### Antennas

**Antennas with omni-directional characteristics;** country permits, compact instructions (hard copy), German/English

##### Wall or mast-mounting

- **Antenna ANT792-6MN**  
Antenna gain including N-Connect connector 6 dBi, 2.4 GHz

**6GK5792-6MN00-0AA6**

##### Roof mounting

- **ANT795-6MN antenna**  
Antenna gain incl. N-Connect connector 6/8 dBi, 2.4/5 GHz

**6GK5795-6MN00-0AA6**

- **Antenna mounting tool (ANT795-6MN)**  
Mounting tool for installation of ANT795-6MN under a roof

**6GK5795-6MN01-0AA6**

##### LP798-1N Lightning Protector

Lightning protector with N/N female/female connector, IP65 (-40 to +100 °C)

**6GK5798-2LP00-2AA6**

##### Antenna cables

##### IWLAN N-Connect male/male flexible connection cable

Flexible connecting cable for connecting an external antenna; assembled with two N-Connect male connectors

- 1 m
- 2 m
- 5 m
- 10 m

**6XV1875-5AH10**

**6XV1875-5AH20**

**6XV1875-5AH50**

**6XV1875-5AN10**

##### HF coupling

N-Connect male/male connector for connecting the LP798-1N lightning protector

**6GK5798-0CP00-1AA0**

##### Accessories

##### IE FC M12 Plug PRO

M12 plug-in connector suitable for on-site assembly (D-coded, IP65/IP67), metal housing, FastConnect connection system, for connecting HARTING adapter cables to the Industrial Ethernet

- 1 unit

**6GK1901-0DB20-6AA0**

##### IE FC TP Standard Cable GP 2 x 2 (Type A)

4-core, shielded TP installation cable for connection to IE FC Outlet RJ45/IE FC RJ45 Plug; PROFINET-compatible; with UL approval; sold by the meter; max. length 1 000 m, minimum order quantity 20 m

**6XV1840-2AH10**

##### IE FC Stripping Tool

Preadjusted stripping tool for fast stripping of the Industrial Ethernet FC cables

**6GK1901-1GA00**

##### Network components for IWLAN

see "Industrial Wireless Communication"

##### HARTING adapter cable <sup>1)</sup>

M12 female NPT 1/2 thread to RJ45 11cm, (minimum order quantity: 10); The adapter is provided for easy connection of the link to the Industrial Ethernet;

**21036836420**

Not included in the scope of delivery of the IE/WSN-PA link; You can find ordering information on the Internet at: <http://www.harting.com/en/contact/>

##### SITOP compact 24 V/ 0.6 A

1-phase power supply with wide-range input 85 – 264 V AC/110 – 300 V DC, stabilized output voltage 24 V, rated output current value 0.6 A, slim design

**6EP1331-5BA00**

<sup>1)</sup> When using the Harting adapter cable for the Ethernet connection, the requirements for intrinsic safety approval are not applicable. When used in an application relevant to intrinsic safety guidelines, it requires acceptance by the appropriate approval agency.

#### More information

Current approvals can be found on the Internet at:

<http://support.automation.siemens.com/WW/view/en/46374734>



<b>7/2</b>	<b>Introduction</b>	<b>7/106</b>	<b>Teleservice</b>
<b>7/3</b>	<b>Telecontrol</b>	7/107	<u>SIMATIC Teleservice</u>
<b>7/4</b>	<b>TeleControl Basic</b>	7/107	TeleService
7/6	<u>TeleControl Basic for the control center</u>	7/115	<u>IPC Remote Manager</u>
7/6	Telecontrol Server Basic	7/115	SIMATIC IPC Remote Manager
7/11	<u>TeleControl Basic for the stations</u>	<b>7/117</b>	<b>Remote Networks</b>
7/11	CP 1242-7 GPRS module	7/118	<u>IP-based modems and routers</u>
7/16	CP 1243-1	7/118	SCALANCE M874
7/20	MD720 MODEM		mobile wireless router
<b>7/25</b>	<b>TeleControl Professional</b>	7/127	SCALANCE M875
7/31	<u>TeleControl Professional for the control center</u>		mobile wireless router
7/33	SINAUT engineering software	7/134	SCALANCE M812-1 and
7/36	SINAUT ST7cc, Add-on for WinCC		SCALANCE M816-1 ADSL routers
7/39	WinCC/TeleControl	7/140	SCALANCE M826-2 SHDSL router
7/43	PCS 7 TeleControl	7/144	<u>Modems for the conventional telephone network</u>
7/48	PCS 7 TeleControl Engineering Station	7/146	MD2 dedicated line modem
7/50	PCS 7 TeleControl Operator System	7/150	MD3 telephone modem
7/52	SINAUT ST7sc SCADA Connect Software	7/20	MD720 modem
7/55	<u>TeleControl Professional for the stations</u>	<b>7/153</b>	<b>Accessories for remote networks</b>
7/58	<u>Stations for ST7 protocol</u>	7/153	LTOP overvoltage protection
7/60	TIM 3V-IE for WAN and Ethernet	7/156	ANT794-4MR 2G / 3G / 4G antenna
7/67	TIM 3V-IE Advanced	7/158	ANT794-3M GSM/GPRS antenna
7/74	TIM 4R-IE for WAN and Ethernet	7/160	PPI modem cable
7/82	<u>Stations for DNP3 protocol</u>	7/161	Connecting cables
7/84	CP 1243-1 DNP3		
7/88	TIM 3V-IE DNP3		
7/93	TIM 4R-IE DNP3		
7/100	<u>Stations for IEC protocol</u>		
7/102	CP 1243-1 IEC		
	<u>TeleControl Professional for the network</u>		
7/118	IP-based modems and routers		
7/144	Modems for the conventional telephone network		
Ch. 8	Industrial Security components		
Ch. 2	Industrial Ethernet network components		

# Industrial Remote Communication

## Introduction

### Overview

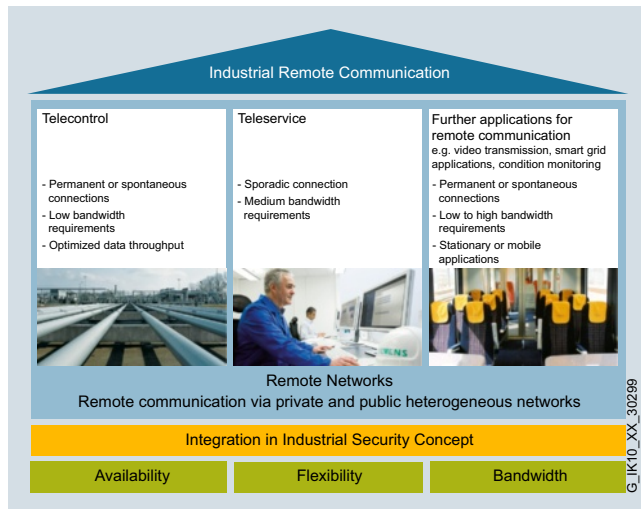

Industrial Remote Communication offers efficient remote access to machines and plants with SIMATIC. Global remote access to far-flung plants, remote machines and mobile applications is gaining in significance – both in industry and in industry-related areas. With a comprehensive range of solutions for industrial remote access, Siemens offers the ideal basis for efficient and reliable monitoring and control of widely distributed plants and processes of any size, thereby addressing the growing importance of the networking of industrial, process engineering and production engineering plant sections.

In addition to efficient remote access (Remote Access), Industrial Remote Communication also offers with the network components the option of transparent data links to remote networks via public or private wide area networks (WAN).

In this way, for example, a video transmission in real time via mobile radio from the passenger compartment of trains serves to increase passenger safety (video surveillance). In addition, applications such as data interfacing for ticket machines, information services and Internet on board, or proactive monitoring of vehicle engineering (telemetry) are also possible.

#### Secure and flexible access worldwide

Industrial plants are often distributed over large areas – sometimes even across national borders. Siemens offers proven solutions for industrial remote access, such as flexible telecontrol systems and efficient remote maintenance. Whether in public infrastructure or in the manufacturing or process industries: With the components for Industrial Remote Access, Siemens offers comprehensive solutions for telecontrol and teleservice.

This includes, for example, the monitoring of all interfaces between the control center and the distributed machines and systems or the remote maintenance accesses via the Internet, including firewalls. Data transmission is encrypted by means of a VPN and is thus protected from data espionage and manipulation. Communication stations are securely authenticated. Using the components for remote networks, remote access can be set up securely and reliably.

#### Telecontrol

Telecontrol involves the connection of distant process stations to one or more central control systems. Various different public or private networks can be used for communication for the purposes of monitoring and control. Event-driven or cyclic exchange of process data is performed with special telecontrol protocols and enables the operating personnel to manage the overall process effectively.

The telecontrol systems are based on SIMATIC. They supplement the SIMATIC system with corresponding hardware and software, and thus permit individual components to be networked over a wide area network (WAN). The data for this is transmitted via conventional WANs, e.g. dedicated cables, telephone network, wireless, but also via IP-based networks such as mobile networks or the Internet.

#### Teleservice

Teleservice is data exchange with physically remote technical plants (machines, plants, computers, etc.) for the purpose of error detection, diagnostics, maintenance, repair, or optimization.

Remote diagnostics and remote maintenance of production plants are indispensable in modern automation technology. They are more efficient and more cost-effective than an on-site service employee. This allows faults to be detected and cleared much faster, downtimes of machines are reduced and their availability is increased.

#### Siemens Remote Services

The service concept of "Siemens Remote Services" provides a powerful, secure platform for remote access to machines and plants. The inclusion of "shared experts" ensures effective support, not only from Siemens but also from the company's own specialists.

#### Remote networks

Any type of remote communication is based on the public and private networks used for this purpose (e.g. mobile radio or fixed network), referred to as "remote networks".

Under the name SCALANCE M, Siemens offers a comprehensive range of high-performance transmission components, routers and modems that are tailored to the specific properties of the respective remote networks or their transmission media and therefore combine the maximum possible security with reliability.

Regardless of whether spontaneous or permanent transmission, whether high or moderate bandwidth, whether mobile or stationary – with the SCALANCE M products for IP-based connectivity, users have a comprehensive spectrum of components at their disposal for remote access – flexible, optimized for industrial use and integrated into the TIA environment and into the Industrial Security concept.

SCALANCE M devices can be used universally in the fields of telecontrol, teleservice (remote diagnosis and maintenance), and any other application for industrial remote communication.

## Overview

Industrial plants or plants in public infrastructure areas are often spread across wide areas, sometimes even across national borders. The range of telecontrol products offers complete solutions with the following features:

- Connection of distributed process stations to one or more control centers
- Use of different public or private communication networks for monitoring and controlling the telecontrol substations
- Event-driven or cyclic exchange of the process data including time stamp via special telecontrol protocols
- Effective control of the overall process by the operating personnel
- Online access to the substations for diagnostics, remote programming and maintenance

### TeleControl Basic

TeleControl Basic is a simple remote control and remote maintenance system optimized for the use of public communication networks such as mobile radio and internet for connection to the substations.

It comprises the TeleControl Server Basic control center software and substations of the type SIMATIC S7-1200 or S7-200. In addition to communication between the control center and the substations, the system also enables internode communication between the substations.

Small-scale applications with few outstations can be implemented, as well as large-scale plants comprising up to 5 000 outstations.

### TeleControl Professional

TeleControl Professional includes telecontrol systems for extensive, expanded applications of the process industry. From SIMATIC PCS 7, SIMATIC WinCC or non-Siemens control systems using OPC, outstations based on SIMATIC S7-1200, S7-300 and S7-400 can be monitored and controlled. The outstations and substations can communicate with each other as well as with one or more control centers. TeleControl Professional has a modular design throughout and can be used with extreme flexibility.

Both telecontrol systems can be connected to a non-Siemens control center system (OPC client) via OPC.

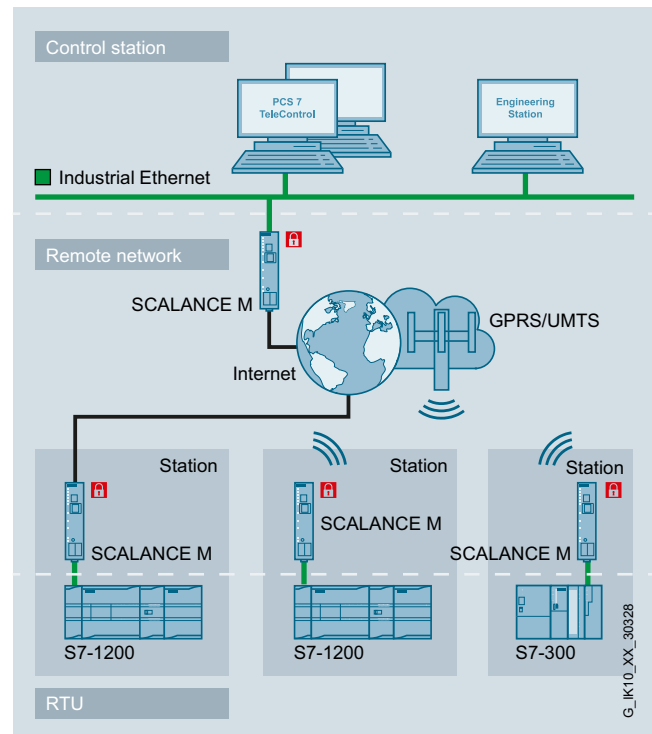

Setup of a telecontrol application based on an example configuration

## Benefits

- Secure and economic remote monitoring and control of process stations
- Global remote access to widely distributed machines and plants
- Quick and easy commissioning due to perfectly matched system components

## More information

You can find more information on the Internet at:  
<http://www.siemens.com/telecontrol>

# Industrial Remote Communication

## TeleControl Basic

### Introduction

#### Overview

TeleControl Basic is based on SIMATIC S7-1200/S7-200 and is the low-cost solution for monitoring and controlling simple telecontrol stations.

With TeleControl Basic, up to 5 000 substations can easily and securely communicate with one another and with the control center using GPRS (**G**eneral **P**acket **R**adio **S**ervice) mobile radio or the internet. They typically remain permanently online.

#### Benefits



- Saving of costs for design and maintenance of own radio system through use of existing mobile radio networks or the internet
- Cost-effective connection of outstations via Ethernet / Internet
- Low-cost GPRS volume tariffs reduce the monthly connection charges
- A GPRS connection is permanently online, i.e. it offers the advantages of a dedicated line
- Secure connection over public networks thanks to encrypted data transfer
- Support for bidirectional connections
  - Between station and control center
  - Between station and station
- Remote maintenance and remote programming of the substations during process operation

#### Application

TeleControl Basic is based on SIMATIC S7-1200/S7-200 and secure transmission via mobile radio or the internet. It is particularly suitable wherever small data quantities have to be transmitted over wireless connections or via the Internet.

TeleControl Basic can be used as a low-cost fault signaling system, but thanks to the bidirectional communications facility, it is also suitable for simple telecontrol tasks for monitoring and control.

Depending on the performance power of the CPU in the substations, local automation tasks can be handled in addition to communication.

Main applications are the monitoring and control of non-mobile stations in the following sectors:

- Water and wastewater
- Drinking water purification and distribution
- Irrigation systems
- Oil and gas supplies
- District heating networks
- Automatic machines
- Traffic control systems
- Building monitoring
- Weather stations
- Lighthouses and buoys
- Wind farms
- Photovoltaic plants
- Environmental monitoring equipment
- Intelligent advertising panels

In addition, TeleControl Basic can also be used to link mobile stations if central monitoring and/or control is required for these:

- Railway vehicles
- Special vehicles
- Local public transport
- Complex building machines
- Ships on rivers and in coastal areas

#### Design

TeleControl Basic consists of the following components:

- **CP 1242-7 GPRS communication module;** communications processor for GPRS and GSM communication for setting up substations of the type S7-1200
- **CP 1243-1 communications module;** communications processor for setting up substations of the type S7-1200 for connection to the Internet by means of external routers e.g. SCALANCE M812-1.
- **MODEM MD720;** modem for GPRS and GSM communication for setting up SIMATIC S7 substations e.g. S7-200
- **Telecontrol Server Basic** software package consisting of:
  - OPC server software for the PC control center; for data exchange with an OPC client, e.g. WinCC, PCS 7 or WinCC flexible
  - Connection manager for the PC control center; for establishing a secure GPRS connection with CP 1242-7/ MODEM MD720 or via Ethernet/Internet, for monitoring these connections, and for data routing with internode communication between substations of the same type (S7-1200 or S7-200)

The CP is plugged straight into the S7-1200, and is connected to the CPU via the backplane bus. The substation is programmed and configured with STEP 7 Basic/Professional V12 (TIA Portal) or higher.

The MODEM MD720 has an RS232 interface and is connected to the S7-200 controller using the Siemens PPI adapter.



### Function

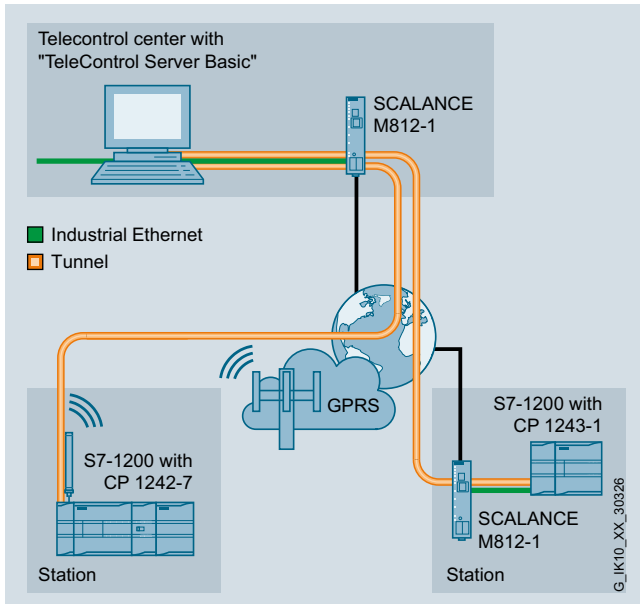

Communication options with TeleControl Basic

### Process data communication

The TeleControl Server Basic software enables the connection of up to 5 000 telecontrol stations to the control center via the OPC interface using GPRS mobile radio or Ethernet/Internet.

TeleControl Server Basic is an OPC server software with special communications functions, which permit it to support connections to remote telecontrol substations. These controls are equipped with the CP 1242-7, CP 1243-1, or the MODEM MD720. The GPRS service (**G**eneral **P**acket **R**adio **S**ervice) of a GSM network (**G**lobal **S**ystem for **M**obile Communication = mobile radio network) or standard IP services via Ethernet are used for the connections.

Via these GPRS connections or Ethernet/Internet, the remote telecontrol substations can communicate with the TeleControl Server Basic software or with other S7 controllers connected with TeleControl Server Basic.

The PC on which TeleControl Server Basic is installed must be permanently accessible from the GPRS network. It must therefore be directly connected to the GPRS provider using a dedicated line, and permanently to the Internet, e.g. by means of DSL.

The TeleControl Basic software package includes a block library for the SIMATIC S7-200 controller. With the help of these blocks, users can implement data exchange with S7-200 substations.

For substations of type S7-1200, the blocks for the CP 1242-7 are included directly in STEP 7 Basic/Professional V11 (TIA Portal) or higher.

### Alarm output per text message

The CP 1242-7 can receive and send text messages. A mobile phone or S7-1200 can be the communication partner.

### Wake-up function

"Wake-up" of stations that change from standby mode to online mode for diagnostics purposes. The CP is woken up by its communication partner (e.g. TeleControl Server Basic) by means of a wake-up call or a wake-up text message to establish the connection between them.

For security reasons, the communication partner must identify itself appropriately for the wake-up function, e.g. using the CLIP function.

### Access to the substations using Teleservice

TeleControl Server Basic contains the teleservice function directly in STEP 7 Basic V13.0 for S7-1200 CP. This gives internationally active plant and machine manufacturers worldwide access to the S7-1200 stations.

Up to three telephone numbers can be saved on MODEM MD720, from which a teleservice connection is permissible. If a call is made from one of the approved numbers, the MODEM MD720 interrupts the GPRS connection and switches through the teleservice connection to the PLC. The GPRS connection is reestablished at the end of the teleservice session.

# Industrial Remote Communication

## TeleControl Basic for the control center

### Telecontrol Server Basic

#### Overview

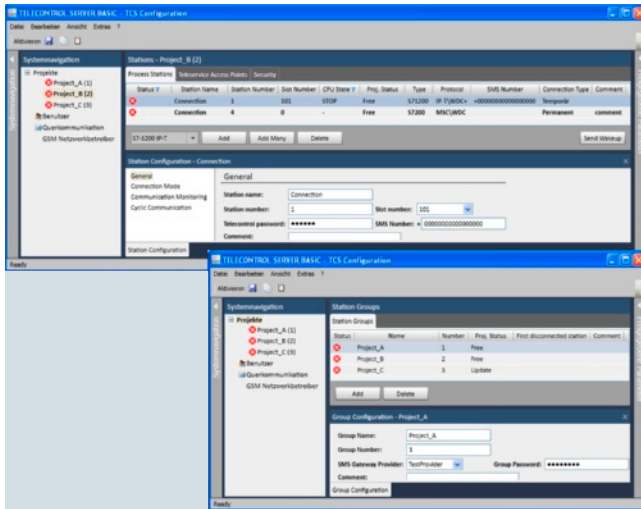

- Software package for the PC, comprising:
  - OPC (UA) server and connection manager for telecontrol and teleservice tasks (diagnostics with STEP 7 for the S7-1200)
  - OPC (UA) configuring software for the S7-1200 and S7-200
  - PLC block library for the S7-200
- Operation in mobile radio network / via Ethernet
  - SIMATIC S7-1200 with CP 1242-7 via dynamic IP addresses with a standard mobile phone flat-rate contract in the 2G cellular network (GPRS mode)
  - SIMATIC S7-1200 with CP 1242-7 via fixed IP addresses in the 2G mobile cellular network (GPRS network)
  - SIMATIC S7-200 with SINAUT MD720 modem via dynamic IP addresses with a standard mobile phone flat-rate contract in the 2G cellular network (GPRS mode)
  - SIMATIC S7-1200 with CP 1243-1 via connection to Ethernet and by means of external DSL routers, e.g. SCALANCE M812-1
- Connection of up to 5 000 telecontrol stations to the control center via the OPC (UA) interface
- Operation and diagnostics of S7-1200 and S7-200 stations on an OPC (UA) server with different STEP 7 projects and separate users with user administration
- Integral teleservice gateway for diagnostics of S7-1200 stations with STEP 7 via the Internet, also with dynamic IP addresses. This works on every PC with STEP 7 and standard internet access without parameterizing firewalls or routers.
- Communication between S7-1200 or S7-200 stations by means of routing function (in the case of GPRS also when using dynamic IP addresses)
- Encrypted transmission for protection against data manipulation and tapping
- Import of SINAUT MICRO SC projects

#### Benefits



- Setup of low-cost alarm signaling systems, monitoring systems, and telecontrol systems with SIMATIC S7-1200, S7-200 and HMI software with OPC (UA) interface (e.g. with WinCC)
- Low-cost connection of widely distributed plants by operating SIMATIC S7 via public APNs (mobile wireless Internet gateway) with standard mobile phone flat-rate contracts, independently of individual mobile wireless operators
- Alternatively, GPRS mode of the SIMATIC S7 via private APNs of the mobile wireless operators for maximum security
- Optimized communication modes for GPRS save on data volumes and thus costs:
  - with permanent connection by means of optimized communication with effective frame format
  - Support for GPRS connections that are built up as required
- Redundancy mode of the TeleControl Server Basic for improving data security
- Low-cost connection of widely distributed SIMATIC S7-1200 systems through connection to Ethernet / Internet by means of external routers
- The multi-user capability and multi-project capability of the OPC (UA) server allow it to be used by system integrators who can allow their customers to use their own server for telecontrol applications. This achieves savings for customers (power costs, server maintenance).
- Teleservice:
  - TeleControl Server Basic provides internationally active plant and mechanical equipment manufacturers with global access to the S7-1200 via STEP 7 using the CP 1242-7 / CP 1243-1. Only GPRS/Internet access to the S7 controller and a PC with STEP 7 and Internet access are required.
- The central control station can be located anywhere thanks to use of the Internet
- Protection of investment thanks to migration of existing projects with SINAUT MICRO SC into TeleControl Server Basic
- Greater protection against tapping and manipulation of data transmitted between the S7-1200/S7-200 station and the OPC (UA) server of the TeleControl Server by means of improved encryption algorithms in the TeleControl Server Version 3
- Fast detection of faults thanks to clearly structured connection and station monitoring of all connected S7-1200 and S7-200 stations
- Fast creation of projects thanks to off-the-shelf sample applications

### Application

- Establishment of small to extremely extensive systems for monitoring and control with simple telecontrol stations
- Energy-saving concepts, e.g. through status-dependent speed control of pumps in remote stations
- Monitoring and control of non-mobile stations in the following sectors:
  - Sewage plants
  - Drinking water purification and distribution
  - Irrigation systems
  - Oil and gas supplies
  - District heating networks
  - Automatic machines
  - Traffic control systems
  - Building monitoring
  - Weather stations
  - Lighthouses and buoys
  - Wind farms
  - Photovoltaic plants
  - Environmental monitoring equipment
  - Intelligent advertising panels
- Connection of mobile stations if central monitoring and/or control is required for these, in the following areas:
  - Railway vehicles
  - Control of special vehicles
  - Local public transport
  - Complex building machines
- Ships on rivers and in coastal areas
- Recording of environmental data
- Remote diagnosing of the SIMATIC S7-1200 with STEP 7 via the mobile wireless network and the Internet

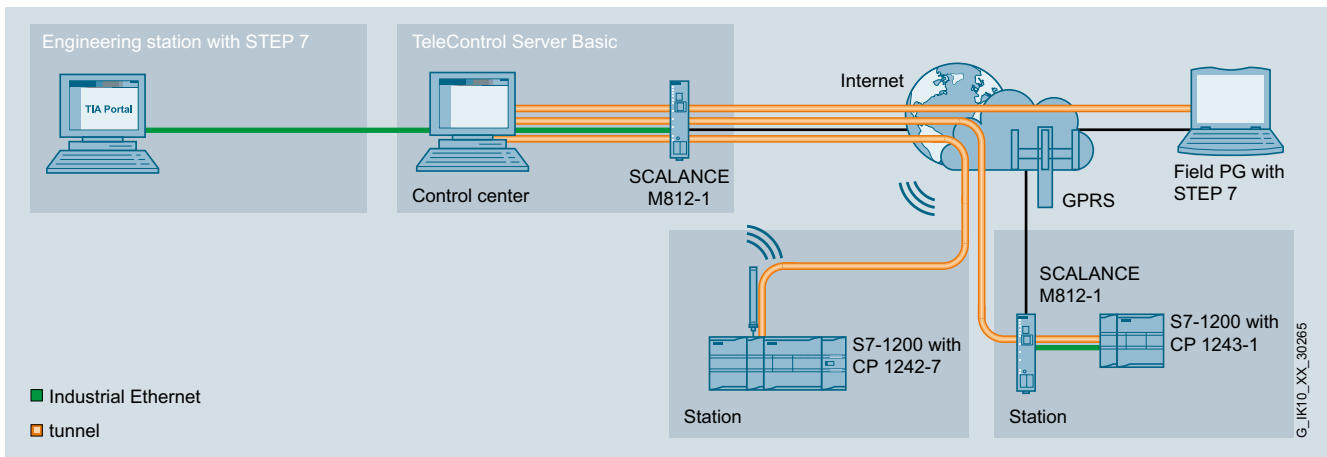

TeleControl Server Basic: Diagnosing an S7-1200 with dynamic or fixed IP address via the Internet and mobile wireless network

### Design

The TeleControl Server Basic software package consists of:

- Block library for the SIMATIC S7-200 CPU
- OPC (UA) server software for the PC control center; for data exchange with an OPC (UA) client, e.g. WinCC
- Connection manager software for the PC control center
  - for establishing a secure connection between an S7 station plus a CP 1242-7 (GPRS mode), CP 1243-1 (Ethernet) or an MD720 (GPRS mode) modem, and the OPC (UA) server
  - for monitoring these connections
  - for data routing in the case of slave-to-slave communication between SIMATIC S7-1200 and S7-1200, and S7-200 and S7-200

# Industrial Remote Communication

## TeleControl Basic for the control center

### Telecontrol Server Basic

#### Function

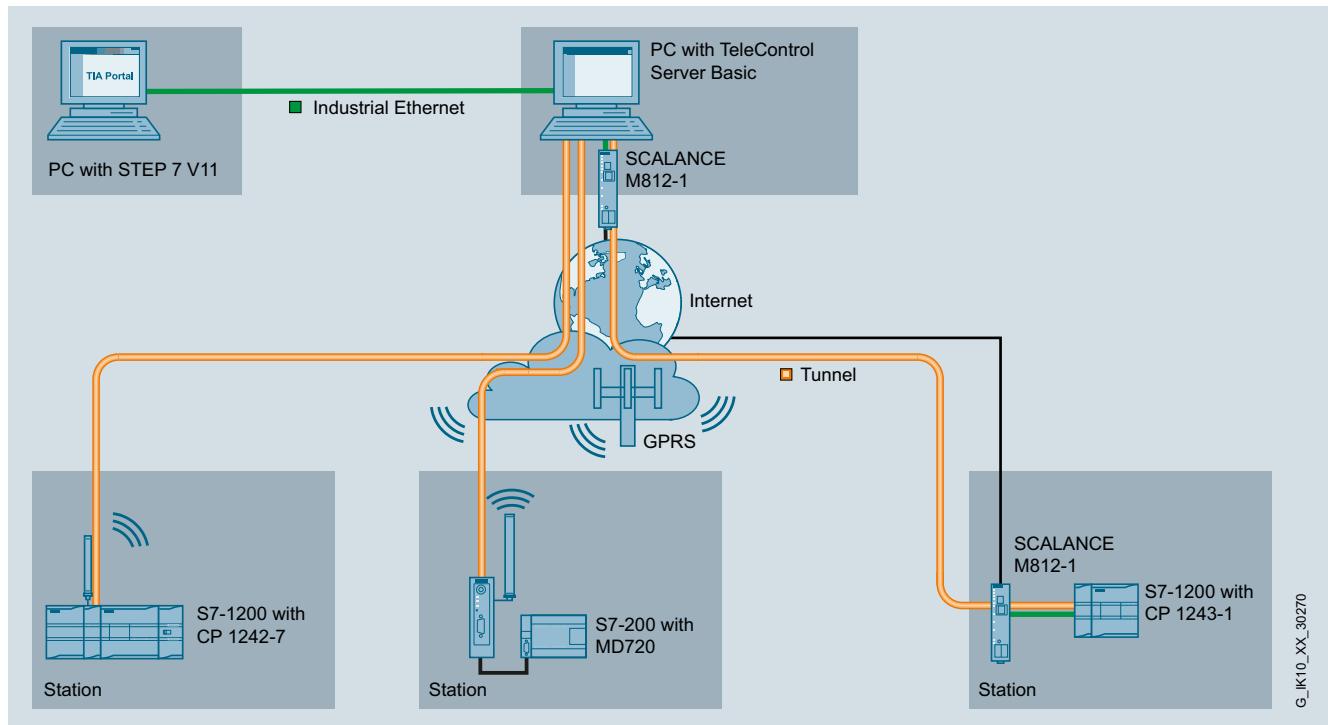

Operation of the CP 1242-7, CP 1243-1 and MD720 modem on the TeleControl Server Basic

- Connection of up to 5 000 stations to one TeleControl Server Basic OPC (UA) server; by connecting several TeleControl Server Basic 5000 OPC (UA) servers to one OPC client, more than 5 000 stations can be connected to a single control center
- Support for large projects:
  - Multi-project-capable: Several STEP 7 telecontrol projects can be organized in up to 2 000 groups
  - Multi-user-capable engineering: Simultaneous configuring by several users is possible
  - Support for configuring similar S7 stations
  - Step-by-step commissioning of stations and station groups
  - Expansions during runtime without interrupting operation
  - Shared operation of stations that are connected via private (M2M contract) or public APNs, or directly via Ethernet/Internet
- Access to variables of the SIMATIC S7-1200 and S7-200 via the OPC (UA) interface by means of WinCC or standard OPC (UA) clients for control systems
- Communication between S7-1200 stations and S7-200 stations using the integral routing function via TeleControl Server Basic even with dynamic IP addresses
- Adjustable communication options:
  - Teleservice: STEP 7 diagnostics (V11 or higher) over the Internet; the S7-1200 GPRS Internet connection can be activated for teleservice either by the machine or plant operator, or via an authorized wake-up function by the programmer or maintenance technician (if this function has been enabled).
  - Permanent GPRS connection for cyclic or event-oriented data transfer (S7-200 and S7-1200)
  - Establishment of the GPRS connection if required by the OPC (UA) client (automatic wake-up via text message) or by the S7-1200 (S7-1200 only)
  - Configuration of monitoring time and time synchronization of S7 stations
- The PC on which the TeleControl Server Basic software is installed must be permanently accessible via a fixed IP address over the Internet, using DSL, for example, or it must have a dedicated line direct to the GPRS provider.
- Redundancy mode:
  - The TeleControl Server Basic can be operated redundantly in order to increase the availability of the automation data.
  - If both PCs are located in the same LAN no additional cabling is necessary for the synchronization of the redundant software packages.
  - The redundancy mode is possible under Windows Server 2008 R2.

#### Security

- Password authentication for incoming connection setup by a SIMATIC S7-200/S7-1200 station
- Optional double user authentication in the case of diagnostics via the teleservice gateway function of TeleControl Server Basic and the CP 1242-7 / CP 1243-1
- Secured data traffic between S7, the Internet and TeleControl Server Basic by means of encryption algorithms

### Function (continued)

#### Diagnostics

- Integrated diagnostic functions for
  - Group status signal of a project in a tree structure
  - Status of each station (GSM diagnostics information, PLC status)
  - Monitoring of temporary GPRS connections
  - "Wake-up" of stations that change from standby mode to online mode for diagnostics purposes
  - STEP 7 diagnostics of the S7-1200 via the CP 1242-7 / CP 1243-1 module (with dynamic or fixed IP address) from any PC with Internet access. The connection between the S7 and the STEP 7 PC to the TeleControl Server Basic is established here. The connection between STEP 7 and the S7 is established automatically via the Teleservice gateway function.
  - Establishment of the connection between the S7 and TeleControl Server Basic can also be optionally initiated via cell phone (authenticated).

#### Operation of TeleControl Server Basic together with TeleControl Professional

TeleControl Server Basic and TeleControl Professional operate with different protocols during data transmission. It is possible to combine a TeleControl Server Basic system with a TeleControl Professional system in a single SCADA system. This is carried out in the PC of the control center via the OPC (UA) server of TeleControl Server Basic.

### Technical specifications

Article No.	6NH9910-0AA21-0..
Product-type designation	TeleControl Server Basic V3
Supported controllers	S7-1200 with CP1242-7 S7-1200 with CP1243-1 S7-200 with MD720 modem (block library included in the scope of supply)
Number of connections (stations) that can be operated (depending on the order version)	8, 32, 64, 256, 1 000, or 5 000 connections
Number of STEP 7 projects that can be operated in parallel	2 000 projects (structured representation, separation of the projects via programmable user rights)
Number of STEP 7 Teleservice connections that can be operated in parallel	5 connections per project (separation of the projects via programmable user rights)
Interfaces to the client	<ul style="list-style-type: none"> <li>• OPC DCOM</li> <li>• OPC UA</li> <li>• Synchronous and asynchronous reading of variables</li> </ul>
Interfaces and functions between the OPC server and SIMATIC S7	<ul style="list-style-type: none"> <li>• Writing of variables in the SIMATIC S7 in the case of value changes to OPC (UA) variables</li> <li>• Transfer of SIMATIC S7 data to OPC (UA) variables (for event-driven communication from the SIMATIC S7)</li> <li>• Activatable cyclic reading of variables; adjustable time interval</li> <li>• Monitoring of connected SIMATIC S7 with time-of-day synchronization</li> <li>• Routing of data packets between connected SIMATIC S7-1200 stations or between S7-200 stations</li> <li>• Permanent GPRS connection; the tunnel is established from the GPRS modem</li> <li>• Temporary GPRS connection (as required); the tunnel is established from the GPRS modem and can be initiated by a text message sent automatically by the OPC (UA) server ("wake-up"). Manual "wake-up" using a mobile phone is also possible.</li> <li>• Via Internet access as server with public IP address (recommendation: fixed public Internet address)</li> <li>• Permanent Ethernet connection between the station and control center</li> </ul>

Article No.	6NH9910-0AA21-0..
Product-type designation	TeleControl Server Basic V3
Operating systems	Windows 7 Professional 32/64 bit + Service Pack 1 Windows 7 Enterprise 32/64 bit + Service Pack 1 Windows 7 Ultimate 32/64 bit + Service Pack 1 Windows Server 2008 32 bit + Service Pack 2 Windows Server 2008 R2 Standard 64-bit Service Pack 1
Diagnostics	Station group monitoring Station monitoring Connection monitoring STEP 7 Teleservice across Internet and router boundaries – S7-1200 only
Configuration	Integral configuration tool Multi-project-capable Multi-user-capable with user management Configurations can be expanded at runtime

# Industrial Remote Communication

## TeleControl Basic for the control center

### Telecontrol Server Basic

#### Ordering data

#### Article No.

#### Article No.

##### TeleControl Server Basic V3.0

Software for 8 to 5 000 stations; Single License for one installation; OPC (UA) server for GPRS and Ethernet/Internet communication with SIMATIC S7-1200 and SIMATIC S7-200 (GPRS only); connection management to remote stations; routing for connections between S7 stations; German and English operator interface; for Windows 7 Professional 32/64 bit + Service Pack 1  
Windows 7 Enterprise 32/64 bit + Service Pack 1  
Windows 7 Ultimate 32/64 bit + Service Pack 1  
Windows Server 2008 32 bit + Service Pack 2  
Windows Server 2008 R2 Standard 64 bit Service Pack 1

- |   |                           |
|---|---------------------------|
| • <b>TeleControl Server Basic 8 V3</b><br>Connection management for 8 SIMATIC S7-1200 or S7-200 stations        | <b>6NH9910-0AA21-0AA0</b> |
| • <b>TeleControl Server Basic 32 V3</b><br>Connection management for 32 SIMATIC S7-1200 or S7-200 stations      | <b>6NH9910-0AA21-0AF0</b> |
| • <b>TeleControl Server Basic 64 V3</b><br>Connection management for 64 SIMATIC S7-1200 or S7-200 stations      | <b>6NH9910-0AA21-0AB0</b> |
| • <b>TeleControl Server Basic 256 V3</b><br>Connection management for 256 SIMATIC S7-1200 or S7-200 stations    | <b>6NH9910-0AA21-0AC0</b> |
| • <b>TeleControl Server Basic 1000 V3</b><br>Connection management for 1 000 SIMATIC S7-1200 or S7-200 stations | <b>6NH9910-0AA21-0AD0</b> |
| • <b>TeleControl Server Basic 5000 V3</b><br>Connection management for 5 000 SIMATIC S7-1200 or S7-200 stations | <b>6NH9910-0AA21-0AE0</b> |
| • <b>TeleControl Server Basic UPRG V3</b><br>Upgrade package from Version V2.x to V3 for all license sizes      | <b>6NH9910-0AA21-0GA0</b> |

##### PowerPacks for TeleControl Server Basic

- |  |                           |
|--|---------------------------|
| • <b>PP TCSB 8 to 32 V3</b><br>for expansion from 8 to 32 stations             | <b>6NH9910-0AA21-0AB1</b> |
| • <b>PP TCSB 32 to 64 V3</b><br>for expansion from 32 to 64 stations           | <b>6NH9910-0AA21-0AF1</b> |
| • <b>PP TCSB 64 to 256 V3</b><br>for expansion from 64 to 256 stations         | <b>6NH9910-0AA21-0AC1</b> |
| • <b>PP TCSB 256 to 1000 V3</b><br>for expansion from 256 to 1 000 stations    | <b>6NH9910-0AA21-0AD1</b> |
| • <b>PP TCSB 1000 to 5000 V3</b><br>for expansion from 1 000 to 5 000 stations | <b>6NH9910-0AA21-0AE1</b> |

##### Accessories

##### CP 1242-7 communications processor

Communications processor for connecting SIMATIC S7-1200 to TeleControl Server Basic via a 2G mobile wireless network (GSM/GPRS)

**6GK7242-7KX30-0XE0**

##### CP 1243-1 communications processor

Communications processor for connection of SIMATIC S7-1200 to Telecontrol Server Basic or for secure connection to an Industrial Ethernet network via firewall and VPN mechanisms

**6GK7243-1BX30-0XE0**

##### MD720 MODEM

GPRS modem for IP-based data transmission over 2G mobile radio network, quad band, AT command interface, automatic establishment of GPRS connection, switchable to CSD mode, RS232, including gender changer for RS232/PPI adapter

**6NH9720-3AA01-0XX0**

##### ANT794-4MR antenna

Omnidirectional antenna for GSM (2G), UMTS (3G) and LTE (4G) networks; weather-resistant for indoor and outdoor use; 5 m cable with fixed connection to antenna; SMA connector; including mounting bracket, screws, wall plugs

**6NH9860-1AA00**

##### ANT794-3M antenna

Flat panel antenna for GSM (2G) networks, for triband with 900/1 800/1 900 MHz; weather-resistant for indoor/outdoor use, 1.2 m cable with fixed connection to antenna; SMA connector, incl. assembly adhesive tape

**6NH9870-1AA00**

#### Note:

Industrial Ethernet routers and wireless routers can be found under "Remote networks"

### Overview



The CP 1242-7 communications processor is used to connect a SIMATIC S7-1200 to the globally widespread GSM/GPRS mobile radio network and has the following characteristics:

- Worldwide wireless exchange of data between S7-1200 controllers and/or between S7-1200 controllers and control centers with an Internet connection
- Communication based on the GPRS (**G**eneral **P**acket **R**adio **S**ervice) mobile wireless service with data transmission speeds of up to 86 Kbit/s in the downlink and 43 Kbit/s in the uplink
- GPRS mode with fixed IP addresses and dynamic IP addresses with standard mobile phone contract
- Time synchronization on the basis of NTP (**N**etwork **T**ime **P**rotocol)
- On-demand connection buildup via voice call or text message
- Sending and receiving of text messages
- Clearly laid out LED signaling for fast and easy diagnostics
- Compact industrial enclosure in S7-1200 design for mounting on a standard mounting rail
- Fast commissioning thanks to easy configuration using STEP 7

In conjunction with the TeleControl Server Basic software, the CP 1242-7 forms a telecontrol system with additional properties:

- Connection of up to 5 000 telecontrol stations to the control center via an OPC interface
- Data buffering in the substations in the event of connection failures
- Central status monitoring of the substations
- No special provider services required for fixed IP addresses
- Teleservice access with STEP 7 to the substations via the Internet

### Benefits



Connection of the S7-1200 to a mobile wireless network turns the controller into a telecontrol substation (RTU - Remote Terminal Unit) suitable for universal use.

- Data connection of difficult-to-access areas without high network infrastructure costs since the existing mobile wireless network can be used
- Machine maintenance without complicated integration into the end customer's IT networks
- Reduced maintenance and travel costs thanks to centralized management of remote automation solutions

The CP 1242-7 has been specially developed to meet the requirements of telecontrol systems in automation solutions:

- Avoidance of data loss thanks to rugged connection to the control center and buffering of the data
- Fast commissioning thanks to direct configuring using STEP 7

### Application

- Data exchange and centralized data monitoring for automation solutions spread over large geographical areas
- Establishment of permanent or temporary communication link for mobile machines/vehicles without permanent location
- Global remote access to the end customer's machinery in compliance with IT security requirements
- Connection of difficult-to-access external stations without a network infrastructure

These applications can be found in the most diverse sectors:

- Water/wastewater treatment plants – pump/valve controllers
- Traffic and transportation – traffic light controls, lighting controls
- Power engineering – monitoring of transformer stations, meter readout
- Mechanical engineering – centralized remote maintenance of machines used around the world
- Wind energy – condition monitoring of wind turbines
- Vending machine manufacturers – monitoring, control of beverage vending machines

# Industrial Remote Communication

## TeleControl Basic for the stations

### CP 1242-7 GPRS module

#### Design



The CP 1242-7 offers all the advantages of the S7-1200 design:

- Rugged, compact plastic enclosure
- Easily accessible connection and diagnostics elements, protected by front flaps
- Removable connecting terminals
- Simple mounting on the mounting rail of the S7-1200
- 3-pin plug-in terminal strip for connection of the 24 V DC external supply voltage
- SMA connection for GSM/GPRS antennas

The CP 1242-7 is plugged into the left-hand system bus interface of the S7-1200. The power is supplied via a 3-pin terminal strip on top of the module. The antenna socket and the SIM card slot are located on the underside of the module, protected by the lower front flap.

#### Function

In conjunction with the TeleControl Server Basic software, the CP 1242-7 forms a telecontrol system on the basis of mobile wireless communication.

The external stations can be connected to the control center either continuously or as required. A higher-level control center system can exchange data with all stations via OPC. A service PC with STEP 7 can connect to any station via the control center for maintenance purposes.

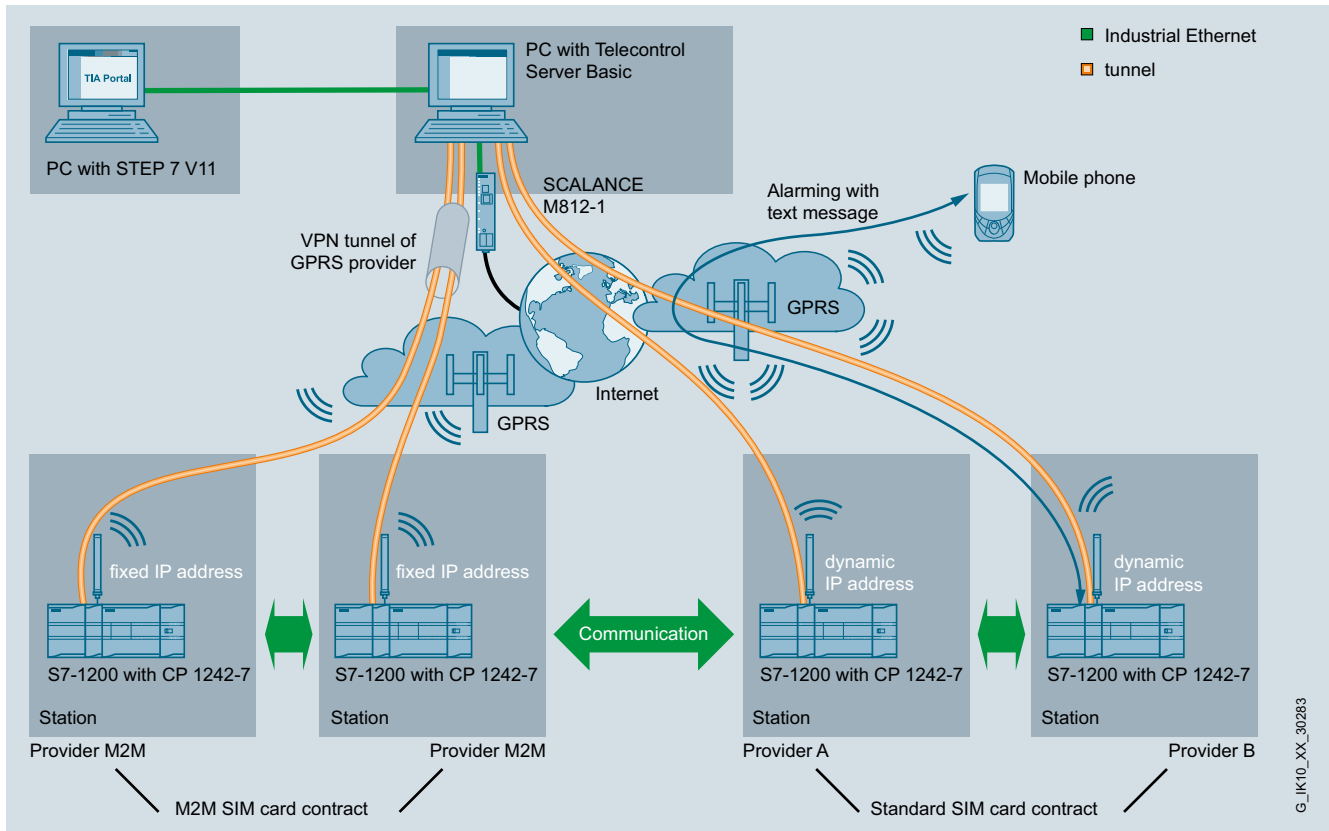

GSM/GPRS communication with CP 1242-7 / Alerting by means of SMS

7



**Function** (continued)**Operating modes**

The CP 1242-7 can be used in two different operating modes:

**TeleControl server**

In this mode, communication with the control center and other telecontrol stations is handled via a central TeleControl server. The CP 1242-7 is connected to the TeleControl server. The TeleControl Server Basic software both forwards the data to the control station or other telecontrol stations and monitors it.

**GPRS Direct**

In this mode, the CP 1242-7 communicates direct with a control center or other telecontrol stations. In contrast to TeleControl mode, this requires no TeleControl server or additional software. This mode can be selected if there is a guarantee that the communication partners of the station can be reached using a unique address. To ensure this, special network operator services, frequently referred to as machine-to-machine (M2M), have to be used in normal cases.

**Configuration**

All the necessary information (provider data, access rights, operating modes) is configured with STEP 7. STEP 7 Basic V11 or higher is required for configuring the CP 1242-7.

The data can also be reconfigured during runtime. A special library function is available for this purpose.

**Data buffering**

Brief connection failures in the mobile wireless network are bridged by data buffering. When the connection has been restored, the buffered data is time-stamped and sent.

**Time synchronization**

The mechanism for time-of-day synchronization of the CP 1242-7 can be set dependent on the operating mode.

If a TeleControl server is used in the control center, the control center forwards the time of day to all substations. If TeleControl Server Basic is not used, synchronization can take place via an NTP server.

The CPU program can use this time to set the internal time-of-day for the station.

**Function library**

A function library for the following functions is available for the CP 1242-7:

- Data exchange: Send and receive functions enable data exchange with other stations or with the control center.
- Sending/receiving text messages
- Configuration: Reconfiguring can take place during operation with the help of a function block

**Diagnostics/remote maintenance**

An online connection to a remote S7-1200 station with CP 1242-7 can be established from STEP 7 via GPRS/Internet. After the connection has been established, all the familiar online functions for remote maintenance (download, diagnostics) are available.

**Technical specifications**

Article No.	6GK7242-7KX30-0XE0
Product-type designation	CP 1242-7
<b>Transmission rate</b>	
Transfer rate with GPRS transmission	
• with uplink maximum	43 kbit/s
• with downlink maximum	86 kbit/s
<b>Wireless technology</b>	
Type of mobile wireless service	
• is supported	
- SMS	Yes
- GPRS	Yes
• note	GPRS (multislot Class 10)
Type of mobile wireless network is supported	
• GSM	Yes
• UMTS	No
Operating frequency	
• 850 MHz	Yes
• 900 MHz	Yes
• 1800 MHz	Yes
• 1900 MHz	Yes
Transmit power	
• at operating frequency 850 MHz	2 W
• at operating frequency 900 MHz	2 W
• at operating frequency 1 800 MHz	1 W
• at operating frequency 1 900 MHz	1 W

Article No.	6GK7242-7KX30-0XE0
Product-type designation	CP 1242-7
<b>Interfaces</b>	
Number of electrical connections	
• for external antenna(s)	1
• for power supply	1
Number of slots for SIM cards	1
Design of the electrical connection	
• for external antenna(s)	SMA socket (50 ohms)
• for power supply	3-pin terminal strip
Design of slot for SIM card	Slot under front flap
<b>Supply voltage, current consumption, power loss</b>	
Type of supply voltage	DC
Supply voltage external	24 V
Relative positive tolerance at 24 V with DC	20 %
Relative negative tolerance at 24 V with DC	20 %
Consumed current from external supply voltage at 24 V with DC	
• typical	0.1 A
• maximum	0.22 A
Resistive loss	2.4 W

# Industrial Remote Communication

## TeleControl Basic for the stations

### CP 1242-7 GPRS module

#### Technical specifications (continued)

Article No.	6GK7242-7KX30-0XE0	Article No.	6GK7242-7KX30-0XE0
Product-type designation	CP 1242-7	Product-type designation	CP 1242-7
<b>Permitted ambient conditions</b>		<b>Performance data telecontrol</b>	
Ambient temperature		Suitability for use	
• for vertical installation during operating phase	0 ... 45 °C	• node station	-
• for horizontal installation during operating phase	0 ... 55 °C	• substation	-
• during storage	-40 ... +70 °C	• control center	-
• during transport	-40 ... +70 °C	• note	-
• Comment	-	Connection to the control center	TeleControl Server Basic
Relative humidity at 25 °C without condensation during operating maximum	95 %	• note	Connection to Scada system using OPC interface supported
Protection class IP	IP20	• by means of a permanent connection	supported
<b>Design, dimensions and weight</b>		• by means of demand-oriented connection	supported
Module format	Compact module S7-1200 single width	Protocol is supported	
Width	30 mm	• DNP3	No
Height	100 mm	• IEC 60870-5	No
Depth	75 mm	Product function data buffering if connection is aborted	Yes
Net weight	0.133 kg	• note	up to 1 000 message frames
<b>Product properties, functions, components general</b>		Data volume as user data per station in telecontrol mode maximum	2 048 byte
Number of modules		Number of data points per station maximum	-
• per CPU maximum	3	<u>Performance data</u>	
• note	-	<u>Teleservice</u>	
<b>Performance data</b>		Diagnostic function online diagnostics with SIMATIC STEP 7	Yes
<u>Performance data open communication</u>		Product function program download with SIMATIC STEP 7	Yes
Number of possible connections for open communication by means of TC blocks maximum	5	Product function remote firmware update	No
Data volume as user data per polling maximum	1 024 byte	<b>Product functions management, configuration</b>	
<u>Performance data S7 communication</u>		Configuration software required	STEP 7 Basic/Professional V11 + HSP (TIA Portal) or higher
Number of possible connections for S7 communication		<b>Product functions Security</b>	
• maximum	-	Product function password protection for teleservice access	Yes
• with PG connections maximum	-	Product function encrypted data transmission	Yes
• with PG/OP connections maximum	-	<b>Product functions Time</b>	
• note	-	Protocol is supported NTP	Yes

Ordering data	Article No.	Article No.
<b>Communications processor CP 1242-7<sup>1)</sup></b> Communications processor for connecting SIMATIC S7-1200 to GSM/GPRS mobile wireless network	<b>6GK7242-7KX30-0XE0</b>	
<i>Accessories</i>		
<b>TeleControl Server Basic V3.0</b> Software for 8 to 5 000 stations; Single License for one installation; OPC (UA) server for GPRS and Ethernet/Internet communication with SIMATIC S7-1200 and SIMATIC S7-200 (GPRS only); connection management to remote stations; routing for connections between S7 stations; German and English operator interface; for Windows 7 Professional 32/64-bit + Service Pack 1 Windows 7 Enterprise 32/64-bit + Service Pack 1 Windows 7 Ultimate 32/64-bit + Service Pack 1 Windows Server 2008 32-bit + Service Pack 2 Windows Server 2008 R2 Standard 64-bit Service Pack 1 <ul style="list-style-type: none"> <li>• <b>TeleControl Server Basic 8 V3</b> Connection management for 8 SIMATIC S7-1200 or S7-200 stations</li> <li>• <b>TeleControl Server Basic 32 V3</b> Connection management for 32 SIMATIC S7-1200 or S7-200 stations</li> <li>• <b>TeleControl Server Basic 64 V3</b> Connection management for 64 SIMATIC S7-1200 or S7-200 stations</li> <li>• <b>TeleControl Server Basic 256 V3</b> Connection management for 256 SIMATIC S7-1200 or S7-200 stations</li> <li>• <b>TeleControl Server Basic 1000 V3</b> Connection management for 1 000 SIMATIC S7-1200 or S7-200 stations</li> <li>• <b>TeleControl Server Basic 5000 V3</b> Connection management for 5 000 SIMATIC S7-1200 or S7-200 stations</li> <li>• <b>TeleControl Server Basic UPRG V3</b> Upgrade package from Version V2.x to V3 for all license sizes</li> </ul>		<i>Accessories (continued)</i> <b>ANT794-4MR antenna</b> Omnidirectional antenna for GSM (2G), UMTS (3G) and LTE (4G) networks; weather-resistant for indoor and outdoor use; 5 m cable with fixed connection to antenna; SMA connector; including mounting bracket, screws, wall plugs <b>ANT794-3M antenna</b> Flat panel antenna for GSM (2G) networks, for triband with 900/1 800/1 900 MHz; weather-resistant for indoor/outdoor use, 1.2 m cable with fixed connection to antenna; SMA connector, incl. assembly adhesive tape <b>STEP 7 Basic Engineering Software V13 (TIA Portal)</b> <i>Target system:</i> SIMATIC S7-1200, S7-1500, S7-300, S7-400, WinAC <i>Requirement:</i> Windows 7 Professional (64 bit), Windows 7 Enterprise (64 bit), Windows 7 Ultimate SP1 (64 bit), Windows 8.1 (64 bit), Windows 8.1 Professional (64 bit), Windows 8.1 Enterprise (64 bit), Windows Server 2008 R2 StdE (full installation), Windows Server 2012 StdE (full installation) <i>Form of delivery:</i> German, English, Chinese, Italian, French, Spanish <ul style="list-style-type: none"> <li>• STEP 7 Basic V13, Floating License</li> <li>• STEP 7 Basic V13, Trial License</li> <li>• Upgrade STEP 7 Basic V12 to STEP 7 Professional Basic V13, Floating License</li> </ul> <b>Software Update Service</b> For a period of 12 months and for a fixed price, the customer is automatically provided with all upgrades and service packs for each installed software package. The contract is automatically extended by a further year unless canceled at least 12 weeks prior to expiration. Requires the current software version. <ul style="list-style-type: none"> <li>• STEP 7 Basic V1x, Software Update Service Standard, 1 year</li> <li>• STEP 7 Basic V1x, Software Update Service Compact, 1 year;</li> </ul>
		<b>6NH9860-1AA00</b>
		<b>6NH9870-1AA00</b>
		<b>6ES7822-0AA03-0YA5</b>
		<b>6ES7822-0AA03-0YA7</b>
		<b>6ES7822-0AA03-0YE5</b>
		<b>6NH9910-0AA21-0AA0</b>
		<b>6NH9910-0AA21-0AF0</b>
		<b>6NH9910-0AA21-0AB0</b>
		<b>6NH9910-0AA21-0AC0</b>
		<b>6NH9910-0AA21-0AD0</b>
		<b>6NH9910-0AA21-0AE0</b>
		<b>6NH9910-0AA21-0GA0</b>

<sup>1)</sup> Please note national approvals under <http://www.siemens.com/mobilenetwork-approvals>

## More information

### Selection tools:

To assist in selecting the right Industrial Wireless Communication, the SIMATIC NET Selection Tool is available at:

- Online version  
<http://www.siemens.com/snst>
- Offline version:  
<http://www.siemens.com/snst-download>

### Radio approvals:

Current approvals can be found on the Internet at: <http://www.siemens.com/mobilenetwork-approvals>

## Industrial Remote Communication

### TeleControl Basic for the stations

#### CP 1243-1

#### Overview



The CP 1243-1 communications processor is used for connecting a SIMATIC S7-1200 to the TeleControl Server Basic control center software via Ethernet, and for secure communication via IP-based networks.

The CP has the following features:

- Ethernet-based connection to TeleControl Server basic, e.g. via Internet
- Data transfer of measured values, control variables, or alarms optimized for telecontrol systems
- Automatic sending of alert emails
- Data buffering of up to 64 000 values ensures a secure database even with temporary connection failures
- Secure communication via VPN connections based on IPsec
- Access protection by means of Stateful Inspection Firewall
- Clearly laid out LED signaling for fast and easy diagnostics
- Compact industrial enclosure in S7-1200 design for mounting on a standard mounting rail
- Fast commissioning thanks to easy configuration using STEP 7

#### Benefits



- **Data security**  
The CP 1243-1 has a large buffer for several thousand data values. Downtimes in the transmission link can then be bridged.
- **Fully automatic time stamp**  
To enable subsequent and correct archiving of process data in the control system, all data frames are assigned with a time stamp at their place of origin.
- **Fast and flexible data communication**  
Operators are therefore quickly provided with alarms, statuses and values from the process, and they can influence process control by entering commands or setpoints at any time.
- **Simple and low-cost engineering**  
The cyclic or event-controller transfer of measurements, setpoints or alarms can be implemented in only a few operations and without programming effort.
- **Remote diagnostics**  
Saving of traveling and maintenance costs due to cost-effective remote programming, diagnostics, control and monitoring via the Internet
- **Industrial Security**  
Securing the system against unauthorized access by means of
  - Central access protection for any devices within an automation cell, e.g. by means of authentication of the network stations
  - Secure remote access via the Internet by means of data encryption (VPN) and data integrity checking

#### Application

By using the CP 1243-1, the S7-1200 can be used as a remote terminal unit (substation) in telecontrol applications. Typical uses include the collection of measured values in geographically widely distributed outdoor areas (level measurement for water tanks) or centralized opening and closing of valves (oil/gas transport in pipelines).

- Plants in water, wastewater or environmental sectors:
  - Irrigation systems
  - Drinking water supply
- Monitoring of power networks for consumption metering and cost control
  - District heating networks
  - Wind farms
- Plants in the oil and gas sector
  - Oilfield water injection
  - Pipelines
- Transportation systems
  - Ventilation control in tunnel systems
  - Traffic control

Regardless of the telecontrol features of the CP, it can also be used for purely security applications if the automation system is to be connected securely to a higher-level IT network. This protects the SIMATIC S7-1200 against unauthorized access from an Ethernet network. The CP 1243-1 allows secure access via a LAN and allows data transfer between devices or network segments to be protected from data manipulation/espionage.

### Application (continued)

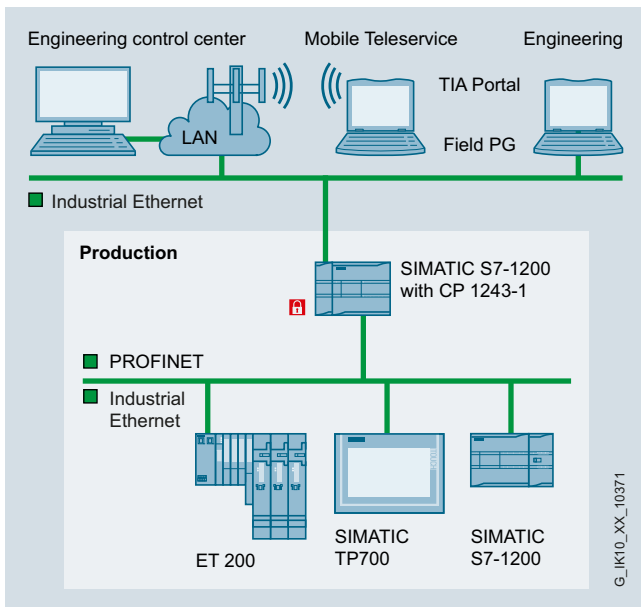

Cell protection for SIMATIC S7-1200 with CP 1243-1 (Security Integrated)

### Design

The CP 1243-1 offers all the advantages of the S7-1200 design:

- Rugged, compact plastic enclosure
- Easily accessible connection and diagnostics elements, protected by front flaps
- Simple mounting on the mounting rail of the S7-1200

The CP 1243-1 DNP3 is plugged into the left-hand system bus interface of the S7-1200. Power is supplied directly via the S7-1200. No additional wiring is necessary. Any required modems or routers are connected via the Ethernet interface on the underside of the module.

### Function

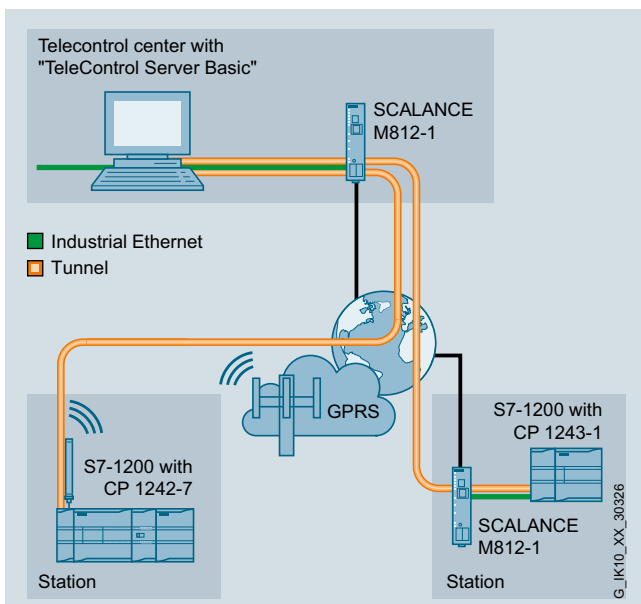

Connection of the S7-1200 to TeleControl Servers via mobile wireless and DSL Internet access

The CP 1243-1 is a communication module for the S7-1200. The module allows the S7-1200 to be connected as a remote station to TeleControl Server basic in just a few steps.

### Completely configurable application through "data point configuration"

The introduction of the "data point configuration" in STEP 7 dispenses with all programming effort for transfer of data to the control center.

The data of the CPU relevant to the control center is selected via user-friendly "item browsing" in STEP 7. In a clearly-arranged menu, the data transfer parameters are then assigned to the data points selected in this way. The cyclic or event-controller transfer of measurements, setpoints or alarms can thus be implemented in only a few operations and without programming effort.

### Data backup

Data losses are prevented by the data buffering mechanisms integrated in the product.

In the event of a connection failure, up to 64 000 time-stamped values are buffered. When the connection returns, the buffered values are automatically transferred to the control center in the right order.

### E-mail alerting

Alert e-mails can be configured for timely provision of stations' states to service or maintenance personnel. If previously defined events (such as threshold violation) should occur, application-specific information is sent automatically by e-mail.

### Diagnostics

The CP 1243-1 offers comprehensive diagnostic options for a quick and informative analysis of the station status. Elementary diagnostic information about the connection to the control center is signaled directly via LEDs at the CP.

Using STEP 7, comprehensive information can be retrieved, such as connection history, buffer status, and the transferred measured values.

### Remote maintenance

For remote access from the control center to the substation, the CP provides a remote maintenance port in parallel with process operation. This ensures access for monitoring and program changes.

### Interfaces

The CP 1243-1 has an Ethernet interface to connection to the control center. The S7-1200 can be connected via an existing network or via other media by using additional routers (e.g. SCALANCE M for Internet connection via DSL).

### Power supply

Extra wiring for the CP power supply is not required. Power is supplied directly via the backplane bus of the S7-1200.

# Industrial Remote Communication

## TeleControl Basic for the stations

CP 1243-1

### Technical specifications

Article No.	6GK7243-1BX30-0XE0
Product-type designation	CP 1243-1
<b>Transmission rate</b>	
Transfer rate • at the interface 1	10 ... 100 Mbit/s
<b>Interfaces</b>	
Number of electrical connections • at interface 1 in accordance with Industrial Ethernet	1
Design of electrical connection • at interface 1 in accordance with Industrial Ethernet	RJ45 port
<b>Supply voltage, current consumption, power loss</b>	
Type of supply voltage	DC
Supply voltage 1 from backplane bus	5 V
Resistive loss	1.25 W
<b>Permitted ambient conditions</b>	
Ambient temperature • for vertical installation during operating phase	-20 ... +60 °C
• for horizontal installation during operating phase	-20 ... +70 °C
• during storage	-40 ... +70 °C
• during transport	-40 ... +70 °C
• Comment	-
Relative humidity at 25 °C without condensation during operating maximum	95 %
Protection class IP	IP20
<b>Design, dimensions and weight</b>	
Module format	Compact module S7-1200 single width
Width	30 mm
Height	110 mm
Depth	75 mm
Net weight	0.122 kg
<b>Product properties, functions, components general</b>	
Number of modules • per CPU maximum	3
<b>Performance data</b>	
<u>Performance data open communication</u> • note	like CPU
<u>Performance data S7 communication</u> Number of possible connections for S7 communication • note	like CPU

Article No.	6GK7243-1BX30-0XE0
Product-type designation	CP 1243-1
<u>Performance data telecontrol</u>	
Suitability for use • node station • substation • control center	No Yes No
Connection to the control center • note • by means of a permanent connection	supported
Protocol is supported • DNP3 • IEC 60870-5	No No
Product function data buffering if connection is aborted • note	Yes 64 000 values
Number of data points per station maximum	200
<u>Performance data Teleservice</u>	
Diagnostic function online diagnostics with SIMATIC STEP 7	Yes
Product function • program download with SIMATIC STEP 7 • remote firmware update	Yes Yes
<b>Product functions management, configuration</b>	
Configuration software required	STEP 7 Basic/Professional V13 (TIAPortal) or higher + HSP
<b>Product functions Security</b>	
Design of the firewall	stateful inspection
Product function with VPN connection	IPSec
Type of encryption algorithms with VPN connection	
Type of authentication procedure with VPN connection	Preshared key (PSK), X.509v3 certificates
Type of hashing algorithms with VPN connection	MD5, SHA-1
Number of possible connections for VPN connection	8
Product function • password protection for Web applications • ACL - IP-based • ACL - IP-based for PLC/routing • switchoff of non-required services • blocking of communication via physical ports • log file for unauthorized access	No No No Yes No No
<b>Product functions Time</b>	
Protocol is supported NTP	No

Ordering data	Article No.	Article No.
<b>Communications processor CP 1243-1</b> Communications processor for connection of SIMATIC S7-1200 to TeleControl Server Basic or for secure connection via IP-based networks	6GK7243-1BX30-0XE0	
<i>Accessories</i>		
<b>TeleControl Server Basic V3.0</b> Software for 8 to 5 000 stations; Single License for one installation; OPC (UA) server for GPRS and Ethernet/Internet communication with SIMATIC S7-1200 and SIMATIC S7-200 (GPRS only); connection management to remote stations; routing for connections between S7 stations; German and English operator interface; for Windows 7 Professional 32/64-bit + Service Pack 1 Windows 7 Enterprise 32/64-bit + Service Pack 1 Windows 7 Ultimate 32/64-bit + Service Pack 1 Windows Server 2008 32-bit + Service Pack 2 Windows Server 2008 R2 Standard 64-bit Service Pack 1		
<ul style="list-style-type: none"> <li>• <b>TeleControl Server Basic 8 V3</b> Connection management for 8 SIMATIC S7-1200 or S7-200 stations</li> <li>• <b>TeleControl Server Basic 32 V3</b> Connection management for 32 SIMATIC S7-1200 or S7-200 stations</li> <li>• <b>TeleControl Server Basic 64 V3</b> Connection management for 64 SIMATIC S7-1200 or S7-200 stations</li> <li>• <b>TeleControl Server Basic 256 V3</b> Connection management for 256 SIMATIC S7-1200 or S7-200 stations</li> <li>• <b>TeleControl Server Basic 1000 V3</b> Connection management for 1 000 SIMATIC S7-1200 or S7-200 stations</li> <li>• <b>TeleControl Server Basic 5000 V3</b> Connection management for 5 000 SIMATIC S7-1200 or S7-200 stations</li> <li>• <b>TeleControl Server Basic UPGR V3</b> Upgrade package from Version V2.x to V3 for all license sizes</li> </ul>	6NH9910-0AA21-0AA0  6NH9910-0AA21-0AF0  6NH9910-0AA21-0AB0  6NH9910-0AA21-0AC0  6NH9910-0AA21-0AD0  6NH9910-0AA21-0AE0  6NH9910-0AA21-0GA0	
<b>CSM 1277 Compact Switch Module</b> Unmanaged switch for connecting a SIMATIC S7-1200 and up to three further nodes to Industrial Ethernet with 10/100 Mbit/s; 4 x RJ45 ports; external 24 V DC power supply, diagnostics on LEDs, S7-1200 module including electronic manual on CD-ROM	6GK7277-1AA10-0AA0	
<i>Accessories (continued)</i>		
<b>IE FC RJ45 Plugs</b> RJ45 plug connector for Industrial Ethernet with a rugged metal housing and integrated insulation displacement contacts for connecting Industrial Ethernet FC installation cables; 180° cable outlet; for network components and CPs/CPU with Industrial Ethernet interface		6GK1901-1BB10-2AA0 6GK1901-1BB10-2AB0 6GK1901-1BB10-2AE0
<ul style="list-style-type: none"> <li>• 1 pack = 1 unit</li> <li>• 1 pack = 10 units</li> <li>• 1 pack = 50 units</li> </ul>		
<b>IE FC TP Standard Cable GP 2 x 2 (Type A)</b> 4-core, shielded TP installation cable for connection to IE FC Outlet RJ45/ IE FC RJ45 Plug; PROFINET-compatible; with UL approval; Sold by the meter; max. length 1 000 m; minimum order 20 m		6XV1840-2AH10
<b>IE FC Stripping Tool</b> Preadjusted stripping tool for fast stripping of Industrial Ethernet FC cables		6GK1901-1GA00
<b>STEP 7 Basic Engineering Software V13 (TIA Portal)</b> <i>Target system:</i> SIMATIC S7-1200, S7-1500, S7-300, S7-400, WinAC <i>Requirement:</i> Windows 7 Professional (64 bit), Windows 7 Enterprise (64 bit), Windows 7 Ultimate SP1 (64 bit), Windows 8.1 (64 bit), Windows 8.1 Professional (64 bit), Windows 8.1 Enterprise (64 bit), Windows Server 2008 R2 StdE (full installation), Windows Server 2012 StdE (full installation) <i>Form of delivery:</i> German, English, Chinese, Italian, French, Spanish		6ES7822-0AA03-0YA5  6ES7822-0AA03-0YA7 6ES7822-0AA03-0YE5
<ul style="list-style-type: none"> <li>• STEP 7 Basic V13, Floating License</li> <li>• STEP 7 Basic V13, Trial License</li> <li>• Upgrade STEP 7 Basic V12 to STEP 7 Professional Basic V13, Floating License</li> </ul>		
<b>Software Update Service</b> For a period of 12 months and for a fixed price, the customer is automatically provided with all upgrades and service packs for each installed software package. The contract is automatically extended by a further year unless canceled at least 12 weeks prior to expiration. Requires the current software version.		6ES7822-0AA00-0YL0  6ES7822-0AA00-0YMO
<ul style="list-style-type: none"> <li>• STEP 7 Basic V1x, Software Update Service Standard, 1 year</li> <li>• STEP 7 Basic V1x, Software Update Service Compact, 1 year;</li> </ul>		

**More information****Technical requirements/compatibility**

An S7-1200 CPU with firmware version 3 is required for operating the CP 1243-1 DNP3.

The CP 1243-1 DNP3 is configured using STEP 7 Basic/Professional V13 (TIA Portal) and higher.

To connect to PCS 7/WinCC control center systems, the TeleControl Server Basic V3 software package is required.

## Industrial Remote Communication

### TeleControl Basic for the stations

#### MD720 MODEM

##### Overview



- The MODEM MD720 is the successor of the SINAUT modem MD720-3. All functions of the replaced SINAUT modem MD720-3 are also supported by the MODEM MD720.
- GSM/GPRS mobile radio modem MD720 with RS 232 interface for IP-based communication in industrial applications
- DIN rail mounting
- 24 VDC power supply
- Supports the GSM services CSD <sup>1)</sup>, SMS and GPRS
- Use with Telecontrol Basic:  
Data transmission over tunneled GPRS connection with SIMATIC S7
- Use with SINAUT ST7:  
Data transmission via CSD, GPRS, transmission of text messages
- AT command interface: for remote maintenance or sending text messages

<sup>1)</sup> CSD – **C**ircuit **S**witched **D**ata (data transmission via GSM dialup connection)

##### Benefits



- Can be used worldwide due to quad band technology (observe national regulations)
  - Quick assembly due to standard rail mounting
- For GPRS operation in combination with TeleControl Server Basic:
- Low operating costs for a permanent wireless online connection due to optimized communication with efficient message format
  - The location of the central control station is irrelevant due to the Internet connection between the mobile phone provider and the OPC (UA) server (TeleControl Server Basic)
  - Secure connection over public networks through encrypted data transmission plus additional measures of the GPRS provider
  - Simple configuration of wireless connected plants without specialist radio knowledge
  - Modem replacement is possible by non-specialists since parameterization is carried out through the S7-200
  - Cost savings thanks to remote servicing and remote programming
  - Various different example applications are available in Customer Service under the heading "Application & Tools" to enable applications to be created quickly using combinations of perfectly interacting automation components.



### Application

- GSM modem for the SINAUT ST7 telecontrol system for data transmission via dialup connection (CSD service)
- GSM modem for the TeleControl Basic system for data transmission via GPRS
- Construction of systems for monitoring and controlling of simple telecontrol stations
- Energy-saving concepts for plants, e.g. by means of status-dependent speed control of pumps in remote stations
- Control and monitoring of, for example:
  - Sewage treatment plants, water treatment
  - Oil and gas supplies
  - District heating networks
  - Power distribution
  - Pumping stations
  - Automatic machines
  - Traffic control systems
  - Buildings
  - Intelligent advertising panels
  - Weather stations
  - Lighthouses and buoys
  - Wind energy and photovoltaic plants
- Linking of mobile stations, with central monitoring/control of track vehicles, special vehicles, local public transport, complex building machines, ships on rivers and in coastal areas
- Remote programming and maintenance of the SIMATIC S7-200 via a GSM dialup connection (CSD service)

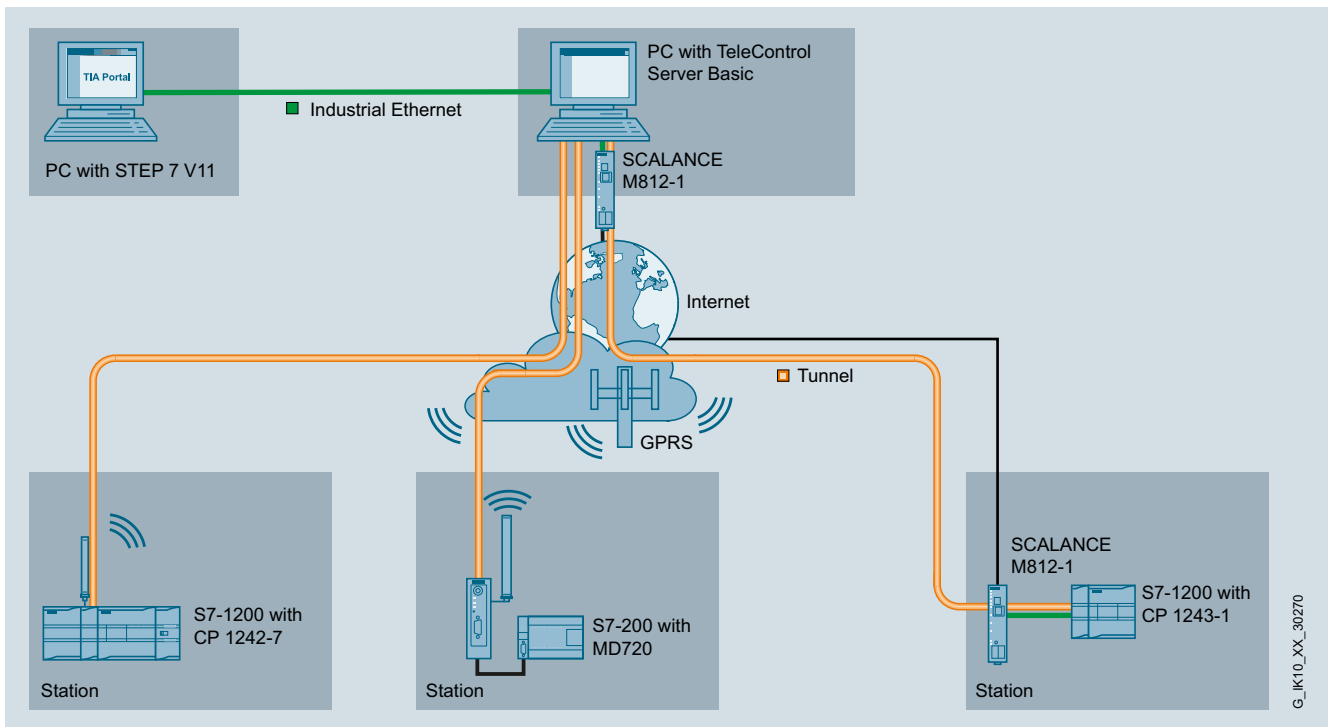

GPRS communication between SIMATIC S7-200 with MODEM MD720 and TeleControl Server Basic

## Industrial Remote Communication

### TeleControl Basic for the stations

#### MD720 MODEM

##### Design

- Rugged plastic enclosure for DIN rail mounting
- 9-pin Sub-D socket with RS232 interface (PPI adapter for SIMATIC S7-200 necessary)
- Diagnostics LEDs for modem status, field strength and connection check
- SET service key
- 4-pin screw terminal for connection to the 24 V DC supply voltage
- SMA connection for GSM/GPRS antennas

##### Function

- Quad band GSM with the frequency bands 850/900/1 800/1 900 MHz
- GPRS Multislot Class 10 (gross: max. 42 Kbit/s upload, max. 54 Kbit/s download).
- Automatic establishment and holding of IP-based online connection over GPRS to the Internet
- Data exchange with PC-based TeleControl Server Basic (router and OPC (UA) server) application; data exchange with further MD720 modems possible over routing of TeleControl Server Basic
- Hot switchover between GPRS and CSD (modem operation)
- CSD and GPRS connection controllable using AT commands
- Sending of SMS and fax (via SMS) using GSM services
- Remote programming of S7-200 with MicroWin in GSM modem mode (CSD mode)
- Secure access to SIMATIC S7-200 data, also over mobile radio provider networks which do not provide public and fixed IP addresses for the modem

##### Configuration

- Parameterization using PLC blocks with the Micro/Win programming tool for SIMATIC S7-200
- PLC blocks are part of TeleControl Server Basic
- AT command interface

##### Security

- Approval of up to 3 call numbers for incoming GSM connections (CLIP function) for teleservice
- User name and password for GSM connection
- Unlimited client and server operation even in protected GPRS networks with private IP addresses of the mobile radio providers
- Secure data transfer in GPRS mode between modem, the Internet, and TeleControl Server Basic using encryption algorithms

##### Diagnostics / maintenance

- Status of establishment of connection, and of an existing connection on front LED display
- Reading of configuration data over the RS232 interface
- Connection status to modem and to PLC can be monitored in Telecontrol Basic
- Direct, additional access over GSM (modem operation) for teleservice (remote programming, remote diagnostics)

### Technical specifications

Article No.	6NH9720-3AA01-0XX0	Article No.	6NH9720-3AA01-0XX0
<b>Product-type designation</b>	<b>MODEM MD720 GSM/GPRS, 2G</b>	<b>Product-type designation</b>	<b>MODEM MD720 GSM/GPRS, 2G</b>
<b>Transfer rate</b>		<b>Permitted ambient conditions</b>	
• for GSM transmission	9 600 bit/s	Ambient temperature	
• with GPRS transmission		• during operating	-20 ... +60 °C
- with downlink maximum	54 kbit/s	• during storage	-25 ... +85 °C
- with uplink maximum	42 kbit/s	Relative humidity at 25 °C during operating maximum	95 %
<b>Interfaces</b>		Protection class IP	IP30
Number of electrical connections		<b>Design, dimensions and weight</b>	
• for internal network	1	Design	compact
• for external network	1	Depth	90 mm
• for power supply	1	Height	100 mm
Design of the electrical connection		Width	30 mm
• for internal network	9 pin Sub D	Net weight	150 g
• for external network	SMA antenna socket (50 ohms)	Mounting type	Yes
• for power supply	4-pole terminal strip	35 mm DIN rail mounting	
<b>WAN connection</b>		<b>Product functions management, configuration</b>	
Type of mobile wireless network is supported GSM	Yes	Product function	
Type of mobile wireless service is supported		• CLI	No
• GPRS	Yes	• web-based management	No
Operating frequency for GSM transmission		• MIB support	No
• 850 MHz	Yes	Protocol is supported	
• 900 MHz	Yes	• Telnet	No
• 1800 MHz	Yes	• HTTP	No
• 1900 MHz	Yes	Type of configuration	AT commands
Type of GPRS time slot method Multislot Class 10	Yes	<b>Standards, specifications, approvals</b>	
<b>Supply voltage, current consumption, power loss</b>		Standard	
Type of supply voltage	DC	• for EMC	EN 61000-6-2, EN 61000-6-4, EN 55022, EN 55024, EN 301 489-1, EN 301 489-7
Supply voltage	24 V	• for hazardous zone	II 3 G Ex nA IIC T4 Gc
Supply voltage		• for safety of CSA and UL	UL 60950
• minimum	12 V	• for emitted interference	EN 55022, EN 61000-6-4
• maximum	30 V	• for interference immunity	EN 55024, EN 61000-6-2
Consumed current maximum	355 mA	Verification of suitability	
Active power loss typical	3.4 W	• CE mark	Yes

# Industrial Remote Communication

## TeleControl Basic for the stations

### MD720 MODEM

#### Ordering data

##### MODEM MD720 <sup>1)</sup>

GPRS modem for IP-based data transmission over 2G mobile network, quad band, AT command interface, automatic establishment of GPRS connection, switchable to CSD mode, RS 232; including gender changer for RS 232/PPI adapter; manual in German, English, French, Italian, Spanish, Portuguese, Chinese, Russian

#### Article No.

6NH9720-3AA01-0XX0

#### Accessories

##### TeleControl Server Basic

Software for 8 to 5 000 stations; Single License for one installation; OPC (UA) server for GPRS/Ethernet communication with SIMATIC S7-1200 and SIMATIC S7-200 (GPRS only); connection management to max. 5 000 remote stations; routing for connections between S7 stations; German and English user interface; for Windows 7 Professional 32/64-bit, Windows 7 Enterprise 32/64-bit, Windows 7 Ultimate 32/64-bit, Windows Server 2008 32-bit, Windows Server 2008 R2 Standard 64-bit; documentation on CD-ROM in German and English

- **TeleControl Server Basic 8 V3**      **6NH9910-0AA21-0AA0**  
Connection management for 8 SIMATIC S7-1200 or S7-200 stations
- **TeleControl Server Basic 32 V3**      **6NH9910-0AA21-0AF0**  
Connection management for 32 SIMATIC S7-1200 or S7-200 stations
- **TeleControl Server Basic 64 V3**      **6NH9910-0AA21-0AB0**  
Connection management for 64 SIMATIC S7-1200 or S7-200 stations
- **TeleControl Server Basic 256 V3**      **6NH9910-0AA21-0AC0**  
Connection management for 256 SIMATIC S7-1200 or S7-200 stations
- **TeleControl Server Basic 1000 V3**      **6NH9910-0AA21-0AD0**  
Connection management for 1 000 SIMATIC S7-1200 or S7-200 stations
- **TeleControl Server Basic 5000 V3**      **6NH9910-0AA21-0AE0**  
Connection management for 5 000 SIMATIC S7-1200 or S7-200 stations
- **TeleControl Server Basic UPRG V3**      **6NH9910-0AA21-0GA0**  
Upgrade package from Version V2.x to V3 for all license sizes

<sup>1)</sup> Please note national approvals under <http://www.siemens.com/mobilenetwork-approvals>

#### More information

##### Radio approvals

Current approvals can be found on the Internet at: <http://www.siemens.com/mobilenetwork-approvals>

#### Article No.

#### Accessories (continued)

##### ANT794-4MR antenna

Omnidirectional antenna for GSM (2G), UMTS (3G) and LTE (4G) networks; weather-resistant for indoor and outdoor use; 5 m cable with fixed connection to antenna; SMA connector; including mounting bracket, screws, wall plugs

6NH9860-1AA00

##### ANT794-3M antenna

Flat panel antenna for GSM (2G) networks, for triband with 900/1 800/1 900 MHz; weather-resistant for indoor/outdoor use, 1.2 m cable with fixed connection to antenna; SMA connector, incl. assembly adhesive tape

6NH9870-1AA00

##### SIMATIC S7-200 PPI modem cable

For connecting the S7-200 to the MD720 MODEM

6NH9701-0AD

##### Connecting cable

For connecting a TIM3V-IE/TIM4 (RS 232) with the MD720 MODEM (access to GSM network). Also suitable for third-party modems or radio equipment with RS 232 standard; cable length 2.5 m.

6NH7701-5AN

##### SITOP compact 24 V/0.6 A

1-phase power supply with wide-range input 85 ... 264 V AC/110 ... 300 V DC, stabilized output voltage 24 V, rated output current value 0.6 A, slim design

6EP1331-5BA00

### Overview

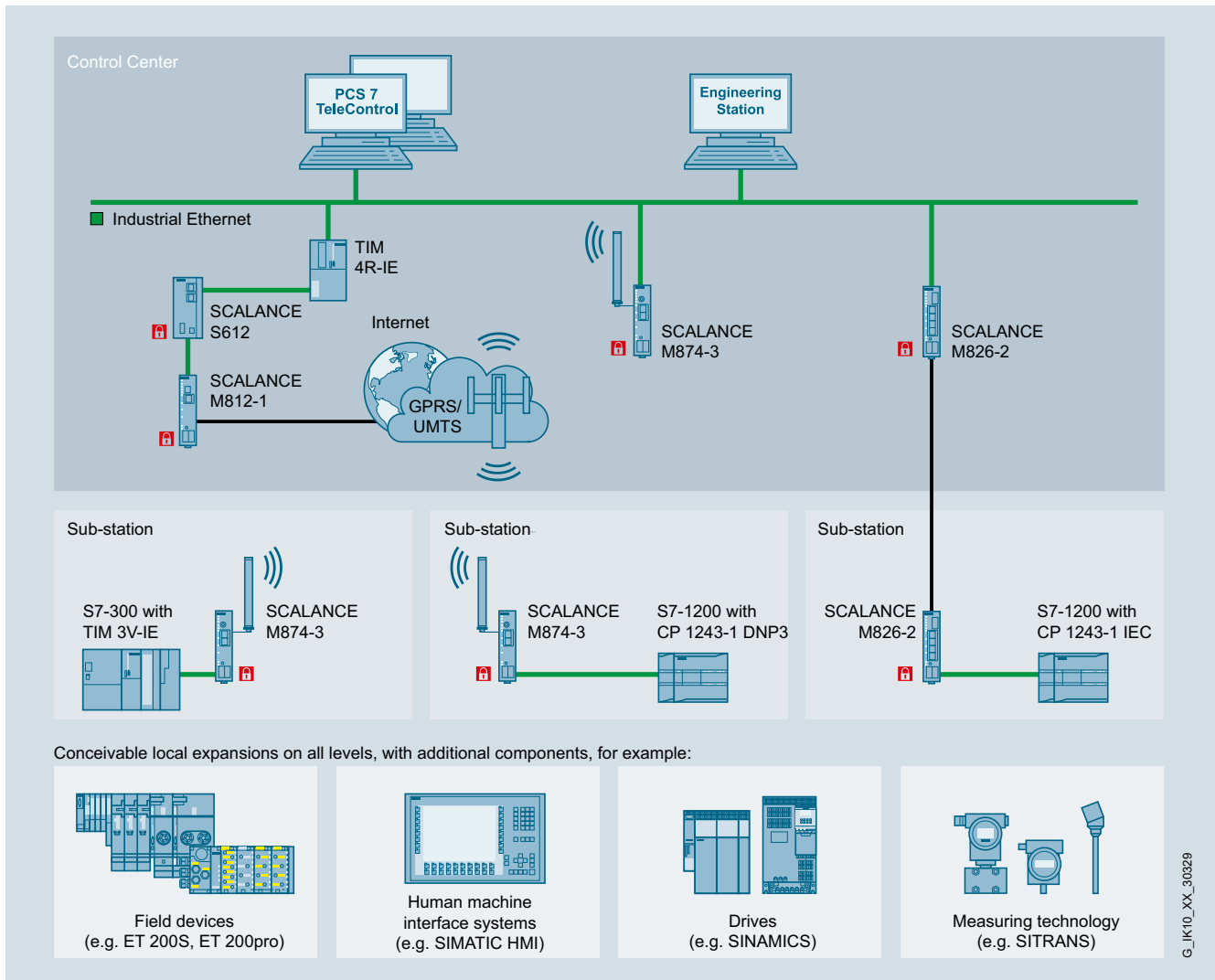

Sample configuration: TeleControl Professional

TeleControl Professional is a telecontrol system based on SIMATIC S7 (S7-1200, S7-300, S7-400, and WinCC/PCS 7) for fully-automatic monitoring and control of substations which exchange data with one or more control centers or with each other using a wide variety of WAN media.

TeleControl Professional facilitates an integrated communications concept (TIA) and complete integration into the SIMATIC environment. The modular design and the support of a huge variety of network forms and operating modes including IP-based networks permit the design of flexible network structures that can also contain redundant links.

By using all forms of transmission media (e.g. dedicated line, wireless, dial-up networks, mobile wireless, DSL), the networks can be optimally adapted to the respective local conditions.

The SINAUT Engineering Software and STEP 7 permit simple and cost-effective configuration even of highly complex networks and their extensions.

The system also supports data exchange with devices of the previous system SINAUT ST1 (based on SIMATIC S5).

# Industrial Remote Communication

## TeleControl Professional

### Introduction

#### Benefits

**get** Designed for Industry

- All conventional and IP-based WAN media can be combined as required, including path redundancy
- Event-driven data transmission incl. time-stamping
- Local data storage
- Remote programming and remote diagnostics
- Integrated operator control and monitoring concept for WinCC/PCS7 or connection to non-Siemens systems via OPC

#### Application

The TeleControl Professional system has proven itself in the smallest plants with only a few process stations, but also in complex networks with many hundreds of stations.

Examples of the range of uses:

- Safe supply of drinking water, gas or district heating for private and industrial consumers via branched networks
- Economical transportation of gas, oil or oil products through pipelines
- Reliable recording and transmission of process data from environmental monitoring systems
- Remote monitoring of wastewater systems
- Control of beacons, unit-type district heating power stations, conveyor systems or transportation systems

#### Design

The TeleControl Professional system is based on the SIMATIC systems S7-1200, S7-300 and S7-400 as well as on WinCC/PCS 7. It supplements these systems with the special communications processors for S7-1200 and SINAUT components listed below, comprising hardware as well as software.

#### Hardware Components

- Communications processors (CPs) for S7-1200
- TIM communications modules
- MD modem modules
- Mobile wireless components (GSM/GPRS/UMTS)
- Industrial modems and routers (SCALANCE M)
- Dedicated line accessories (overvoltage protection)
- Connecting cables

#### Software components

##### SINAUT Engineering Software

- SINAUT TD7 library; contains blocks for the SIMATIC S7 CPU
- SINAUT configuring and diagnostics software for the programming device

##### Software for the central control center

- SINAUT ST7cc; the SINAUT add-on for WinCC
- WinCC TeleControl; add-on for SIMATIC WinCC for telecontrol applications
- PCS 7 TeleControl; add-on for SIMATIC PCS 7 for telecontrol applications
- SINAUT ST7sc; software for interfacing ST7 with control centers that can operate as OPC clients

#### Function

##### Network configurations and operating modes

The telecontrol components support the set-up of complete hierarchical communication networks comprising terminals, node stations and control center.

For the exchange of information between the individual devices, conventional WANs can be used, such as dedicated-line, wireless and dialup networks as well as IP-based WANs such as DSL, GPRS, UMTS, Internet, etc.

There are no restrictions on the combination of WAN types in a project. Point-to-point, line and node network topologies can be set up. Hybrid configurations of these basic structures are also possible.

A station can be linked using two transmission paths to permit redundant data transmission. The two paths can be of the same type or different, e.g. dedicated line plus GPRS, or ISDN plus wireless.

The following network topologies are possible in the WAN:

- "Point-to-point"
- "Line"
- "Star"
- "Tree"
- "Ring"

The graphics below show examples of different network topologies that can be implemented with the components listed above.

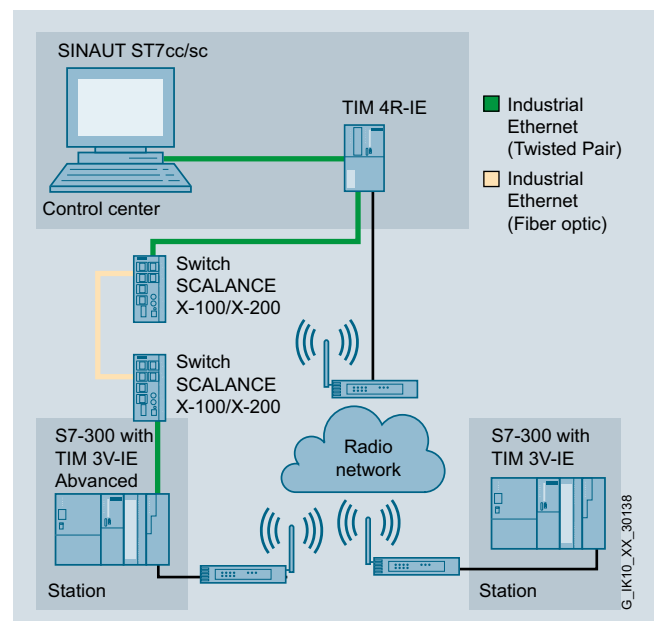

SINAUT ST7cc/sc control station with redundant WAN connection

## Function (continued)

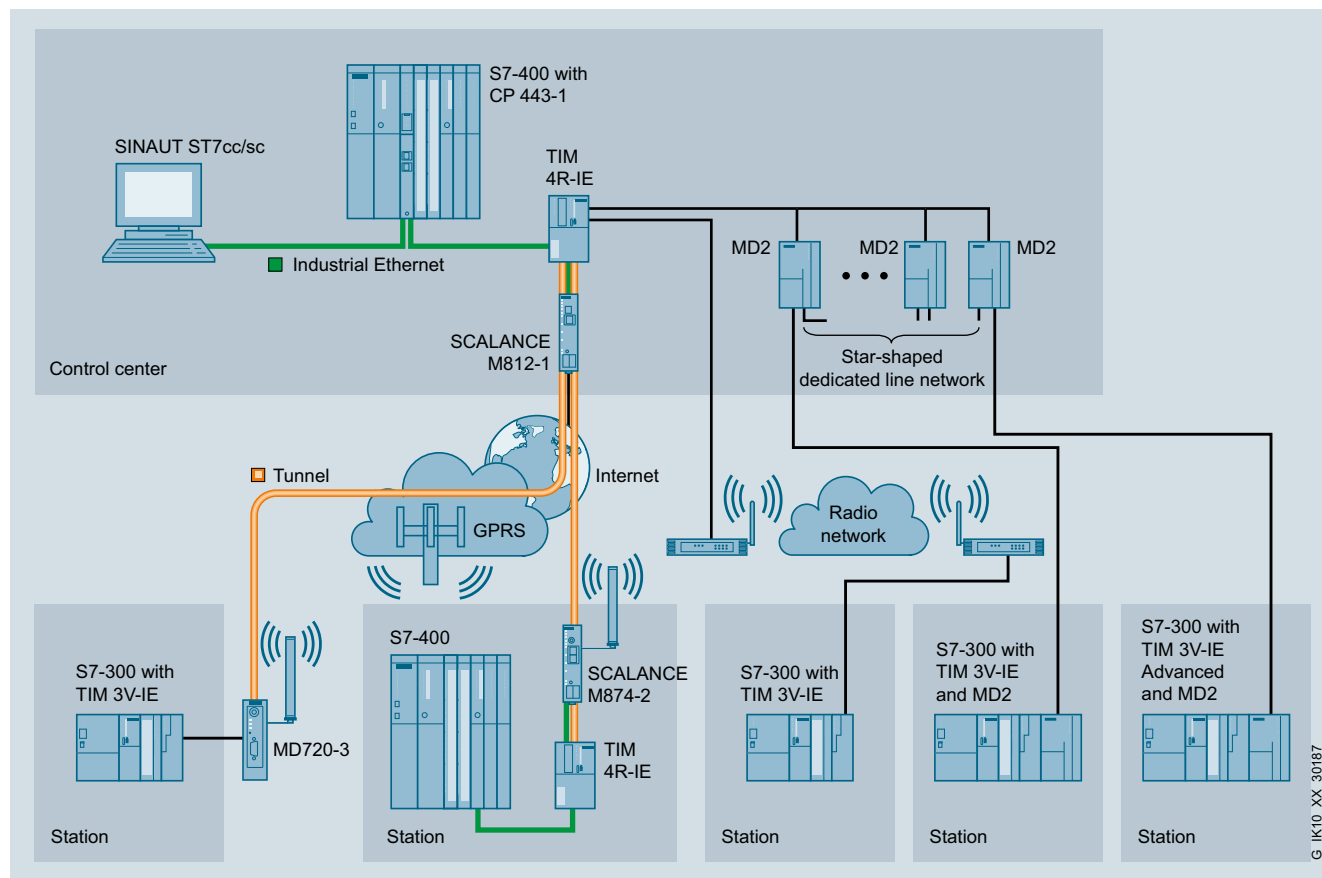

Different communication media in a SINAUT ST7 system

**The control center**

A number of different variants can be selected as components of the central control center:

**SINAUT ST7cc;**

PC control center based on WinCC; this is the ideal control center system for both SINAUT ST7 and SINAUT ST1. It has been designed specifically for event-driven and time-stamped data transmission on the SINAUT system and can be set up as a non-redundant or redundant system (to supplement the WinCC/PCS 7 redundancy package).

**PCS 7 with PCS 7 TeleControl;**

this is the ideal control center system for plants in which larger local automation tasks have to be combined with telecontrol connections. In addition to SINAUT ST7, remote stations with other communication protocols can be connected, e.g. over DNP3 or IEC -60870-5-101/-104. <sup>1)</sup>

**WinCC TeleControl;**

control center system for plants with the WinCC HMI software, expanded with telecontrol connections. WinCC TeleControl offers connection of SIMATIC substations with TIM 3V-IE DNP3, TIM 4R-IE DNP3 or non-Siemens stations with DNP3 protocol, as well as telecontrol stations with IEC-60870-5-101/-104.

**SINAUT ST7sc;**

OPC server for interfacing control centers from other vendors via the OPC Client function; the SINAUT telecontrol technology can also be connected to control center systems from other vendors via the "Data Access Interface". ST7sc features extensive buffer mechanisms which prevent data from being lost even if the OPC client fails. It can be connected to non-redundant or redundant clients.

Like the substations, the control center comprises a SIMATIC S7-300 or S7-400 PLC.

This solution is suitable for simpler control centers in which only an up-to-date process image of the process data available in the stations is required. The station process control can be influenced by entering commands, setpoints or parameters. This S7-300 or S7-400 control center can also be used to extend a PC control center (SINAUT ST7cc or ST7sc), e.g. for data output on a panel and/or as an emergency operating system.

<sup>1)</sup> For further information, see Catalog ST PCS 7.1

# Industrial Remote Communication

## TeleControl Professional

### Introduction

#### Function (continued)

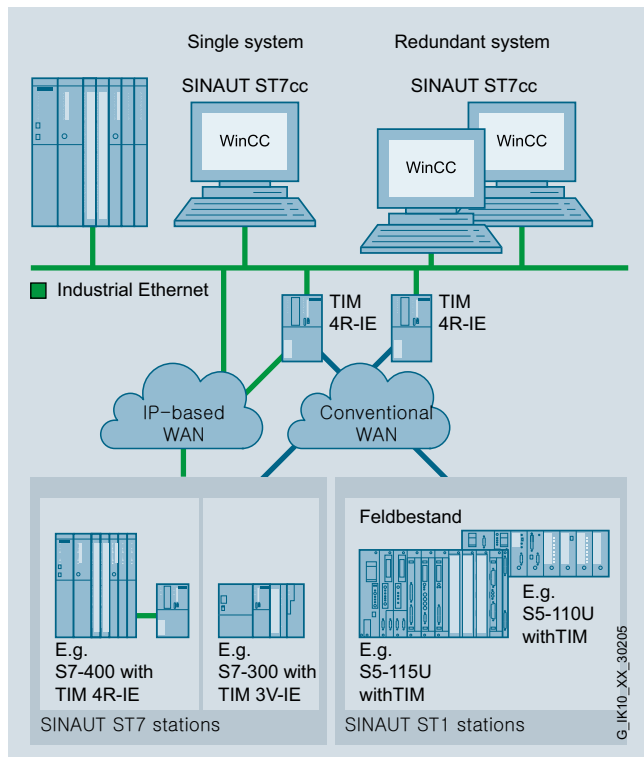

SINAUT ST7cc control center system with connected substations (RTU)

#### Classic WANs

The following conventional WANs can be used for data transmission:

- Copper dedicated lines, private or leased
- Private wireless networks (optionally with time slot procedure)/ TETRA
- Dial-up networks (analog/ISDN/GSM)

#### IP-based WANs

SINAUT communication, however, is also possible via IP-based networks:

- Wirelessly, by using special wireless systems optimized for Ethernet, e.g. the components of the SCALANCE W IWLAN system
- Via fiber-optic conductors, e.g. through use of SCALANCE X switches with optical ports; distances of up to 120 km can then be covered
- Via public networks and the Internet using DSL or GPRS/UMTS
- Copper dedicated lines, private or leased

#### Change-driven data transmission

In the stations, the SINAUT software ensures that process data is transmitted between CPU and control center, e.g. ST7cc, and from CPU to CPU in the event of changes. Connection, CPU or control center failures are displayed. A data update for all participating communication partners is performed automatically following debugging or startup of a CPU or of the control center.

#### Permanently correct time

To enable subsequent and correct archiving of process data in the control system, all data frames are already assigned a time tag at their place of origin. The entire network is synchronized automatically – including daylight saving time changeover.

#### Local data storage

A special property of the TIM communications module used in the SINAUT ST7 system is the capability for saving data which must not be lost in the event of a connection fault or if the partner fails. A memory capacity is provided for up to 56 000 message frames.

The memory capacity helps to save money on dial-up networks. Various priorities can be assigned to the data to be transmitted. At high priority, a dial-up connection is established immediately. At low priority, data is initially saved in the TIM. This data is transmitted on the next connection that is made with the partner for any reason, for example if an item of information with a high priority is to be transmitted, or if the partner sets up a connection in order to exchange data.

It is precisely because the TIM module can save data and transmit it at a later point in time with a time stamp that the use of a suitable control center system must be ensured. It must also be possible to continue to process this data, specifically as regards subsequent archiving, if the data is received in the control center delayed by a number of hours or even days. Also archive compressions such as the creation of mean, hourly and daily values cannot be performed until all data for the relevant period has been received. The standard SINAUT control center on the basis of WinCC, when supplemented with the SINAUT software ST7cc, is ideal for this task.

#### SINAUT remote programming and remote diagnostics

In industries in which SINAUT is used, the terminals are distributed across wide areas and are often situated in locations that are difficult to access. Faults which require a visit to be made to a terminal of this type are associated with long journeys. SINAUT ST7 can provide the ideal solution for such circumstances: Remote programming and diagnostics via the telecontrol network. All diagnostics and programming functions provided by SIMATIC and SINAUT for station automation and WAN communication can be used via the telecontrol path – without interrupting process data transmission.

#### Alarm messaging via text message

In order to alert standby service personnel, event-driven text messages can be sent to mobile phones from the CPUs. An acknowledgment that a message of this type has been received can be sent back to the sender CPU from the mobile phone. A text message can also be output as e-mail, fax or voice mail if the mobile service provider offers these options.



## Integration

### Protocols

#### SINAUT ST1 protocol

This protocol is used in the SINAUT ST1 system, which is based on the SIMATIC S5 system. However, the SINAUT ST7 system also supports this protocol. Existing SINAUT ST1 systems can be further expanded with the SINAUT ST7 system, or existing system components can be replaced with ST7 devices.

Possible operating modes:

- Polling
- Polling with time slot procedure
- Spontaneous operation (for dialup networks)

Please note that only modems/transmission devices suitable for 11-bit asynchronous characters may be used in both polling modes. However, "spontaneous" mode supports transmission with both 11-bit and 10-bit asynchronous characters.

#### SINAUT ST7 protocol

This protocol is a more advanced version of the ST1 protocol. It enables SINAUT communication via both conventional and IP-based WANs. In addition, the addressing options have been extended:

- Up to 10 000 stations can be addressed (maximum of 254 for ST1)
- Message frames contain a source and a target address, (ST1 message frames only contain a source or a target address).

The ST7 protocol also supports "PG routing", i.e. remote programming and remote diagnostics via the WAN without interrupting SINAUT data traffic. PG routing and data traffic share the available bandwidth on the transmission path; PG routing is simply allocated a higher priority.

Possible operating mode in the IP-based WAN:

- Spontaneous mode

Possible operating modes in the conventional WAN:

- Polling,
- Polling with time-slot procedure,
- Spontaneous operation (for dialup networks)

#### DNP3 protocol

The DNP3 protocol (Distributed Network Protocol) is a standardized telecontrol protocol, independent of any manufacturer. It enables remote communication via both conventional and IP-based WANs.

Possible operating mode in the IP-based WAN:

- Spontaneous mode

Possible operating modes in the conventional WAN:

- Polling,
- Polling with time-slot procedure,
- Spontaneous operation (for dialup networks)

#### IEC protocol

The IEC 60870-5-101, -103, -104 are standardized vendor-independent protocols. They enable remote communication via both conventional and IP-based WANs. For implementing an RTU with IEC 60870-5 on the basis of SIMATIC, the CP 1243-1 IEC for SIMATIC S7-1200 and the SIPLUS RIC software bundle are offered.

Possible operating mode in the IP-based WAN:

- Spontaneous mode

### Modes

- In **polling** mode, data exchange is controlled from the controller. It calls the connected terminals (including node terminals) in sequence. Terminals with modified data send this data as soon as they are called. Terminals with no modified data at the present time simply acknowledge the call. Data from the CPU to the terminals can be transferred at any time between the individual calls.

The ST7 protocol supports direct data transmission between substations. During this type of communication, data is always exchanged via the polling control center TIM.

- **Polling with time-slot procedure** mode is used on a radio network on which the use of the radio frequency assigned by the registration authorities has to be shared with other operators. Typically, each operator has six seconds per minute to exchange data with its terminals. Once this time has elapsed, the frequency must be enabled for the next operator. During the allocated time slot, this type of polling operates in the same way as standard polling.

The ST7 protocol supports direct data transmission between substations. During this type of communication, data is always exchanged via the polling control center TIM.

In order to exactly observe the time slot, the polling control center TIM must be directly supplied with the DCF77 or GPS time.

- **Spontaneous mode** for data exchange on dial-up networks: Different priorities (normal, high or interrupt) can be assigned to the data of the station or node station for transmission in the dial-up network. Data to be sent by the control center always have the high priority. If data with a high or alarm priority is awaiting transmission, a dial-up connection is established immediately. At normal priority, data is initially saved in the terminals. This data is transmitted on the next connection that is made with the partner for any reason, for example if an item of information with a high or alarm priority is to be transmitted, or if the partner sets up a connection in order to exchange data.

The message frames saved in the TIM are transmitted according to the FIFO principle, i.e. in the original chronological sequence, providing they are message frames with high or normal priority. If alarm message frames are present in the TIM buffer, these are always transmitted before the other message frames.

Direct data transmission between substations is possible with the ST7 protocol.

# Industrial Remote Communication

## TeleControl Professional

### Introduction

#### Integration (continued)

##### • Spontaneous operation in the IP-based WAN

For transmission via an IP-based network, a permanent S7 connection is established in each case between two TIMs or between one TIM and the ST7cc/ST7sc. The two TIMs or the TIM and ST7cc/ST7sc exchange the data packages specific to SINAUT ST7 with application of the TCP/IP transport protocol. The transmission is performed with the resources of the S7 communication, in which the processing of the spontaneous data exchange depends on whether the transmitted volume of data is chargeable or not in the IP-based network.

##### *Networks without volume tariff:*

When data is transmitted, it is transferred immediately to the respective partner regardless of any priority. Data is transferred in accordance with the FIFO principle. This does not apply to message frames with "interrupt" priority. These are transferred before any other message frames that are available in the buffer.

##### *Networks with volume tariff:*

In an IP-based network such as the GPRS network, the priority of the individual data frames (normal, high or interrupt) is taken into consideration, as in the case of a dialup network. Data with normal priority is collected and transmitted in larger blocks, as soon as a specific size of block is achieved or, at the latest, when the specified TCP/IP Keep-alive interval has expired. This saves transmission volume because a reduced message frame overhead and fewer acknowledgment message frames are required. Important data with high or interrupt priority is transmitted immediately. Normal message frames that are buffered at this point are sent at the same time. Message frames with normal or high priority are transmitted in accordance with the FIFO principle.

#### Network configurations and topologies

All networks and all transmission media can be combined in any way in a telecontrol project – both with each other in "node structures", as well as in parallel in star topologies or in redundant configurations.

The graphics below show a selection of different topologies that can be implemented with the telecontrol components.

##### Basic topologies

Differently structured telecontrol networks can be implemented in the wide area network (WAN) based on the following four basic topologies.

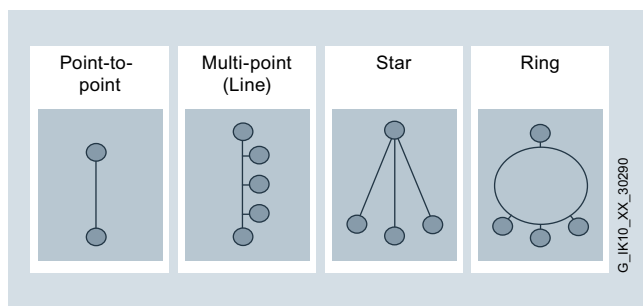

##### Media versions

Depending on the support provided by the selected telecontrol protocol, various transmission media are available for these basic topologies, for example, dedicated line, private wireless networks, mobile wireless networks, dial-up networks (wireless/landline), DSL over Internet.

Some of these media versions are shown in the example of the star topology.

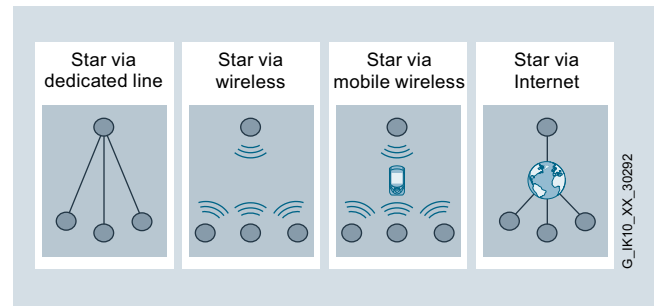

##### Combinations of basic topologies and media versions

Through a combination of several basic topologies of the same or different media versions, it is additionally possible to design more complex network topologies, even with redundant communication paths. This allows optimum adaptation to process requirements and to the existing infrastructure.

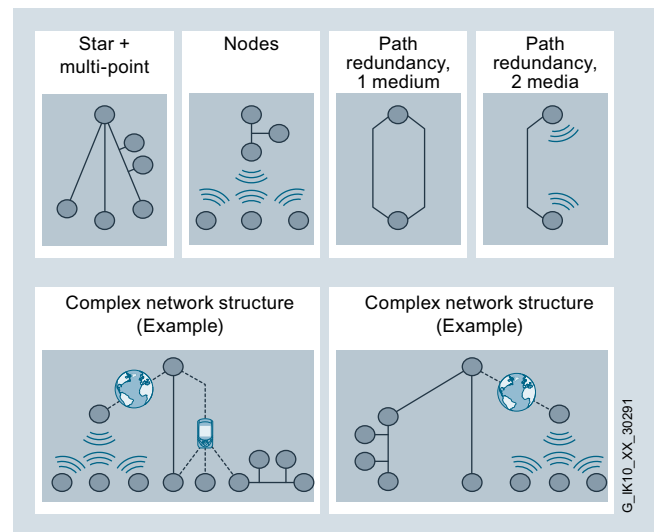

##### More information

You can find more information on the Internet at:  
<http://www.siemens.com/telecontrol>

### Overview



#### Design principle of a telecontrol system and plants with SIMATIC

Telecontrol involves the connection of distant process stations to one or more central control systems. A telecontrol system can be subdivided into the following components:

- The service or control center
- The communication network
- The substations

Various different public or private networks can be used for communication for the purposes of monitoring and control. The event-controlled or cyclic exchange of the process data takes place via special telecontrol protocols such as SINAUT ST1, SINAUT ST7, DNP3 or IEC 60870-5-101/-104.

#### The control center

A number of different variants can be selected as components of the central control center:

##### **SINAUT ST7cc;**

PC control center based on WinCC; this is the ideal control center system for both SINAUT ST7 and SINAUT ST1. It has been designed specifically for event-driven and time-stamped data transmission on the SINAUT system and can be set up as a non-redundant or redundant system (to supplement the WinCC redundancy package).

Control station software	Telecontrol protocols						
	IP T (IP-Telemetry)	ST7	DNP3	Modbus	IEC 60870-5-101	IEC 60870-5-104	IEC 61850
PCS 7 TeleControl	-	●	●	●	●	●	
PCS 7 PowerControl	-	-	-	-	-	-	●
WinCC 7 TeleControl	-	●	●	-	●	●	-
WinCC ST7cc	-	●	-	-	-	-	-
WinCC OA	-	-	●	●	●	●	-
SCADA with ST7sc	-	●	-	-	-	-	-
SCADA with TeleControl Server Basic	●	-	-	-	-	-	-
Third-party SCADA	-	-	●	●	●	●	●

G\_IK10\_XX\_30327

# Industrial Remote Communication

## TeleControl Professional for the control center

### Introduction

#### Overview (continued)

##### *PCS 7 with PCS 7 TeleControl;*

this is the ideal control center system for plants in which larger local automation tasks have to be connected to telecontrol interfaces. In addition to SINAUT ST7, remote stations with other communication protocols can be connected, e.g. over DNP3 or IEC 60870-5-101/-104.

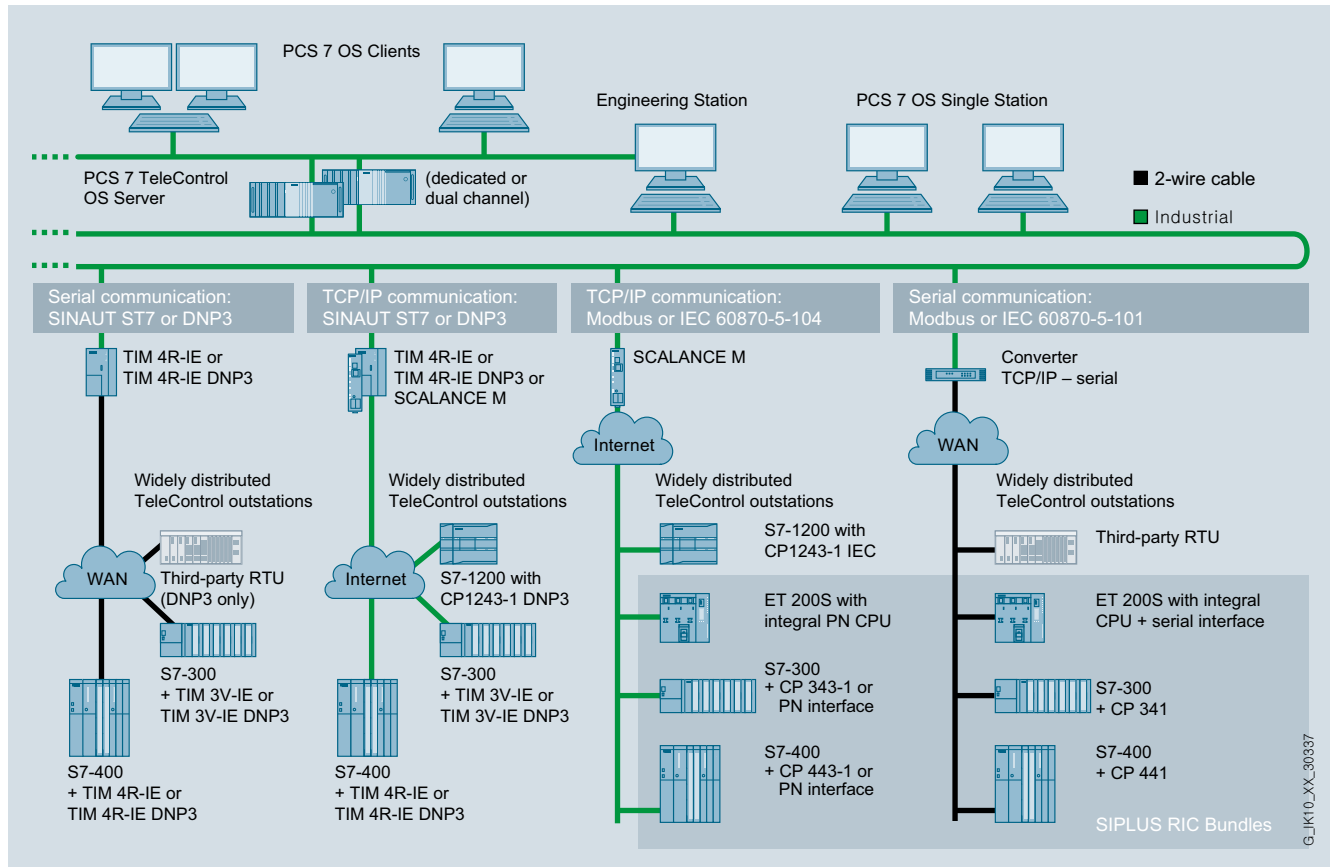

##### *WinCC TeleControl;*

control center system for plants with the WinCC HMI software, expanded with telecontrol connections. WinCC TeleControl offer connection of SIMATIC substations with TIM 3V-IE DNP3, TIM 4R-IE DNP3 or non-Siemens stations with DNP3 protocol, as well as telecontrol stations with IEC 60870-5-101/-104.

##### *SINAUT ST7sc;*

OPC server for interfacing control centers from other vendors via the OPC Client function; the SINAUT telecontrol technology can also be connected to control center systems from other vendors via the "Data Access Interface". ST7sc features extensive buffer mechanisms which prevent data from being lost even if the OPC client fails. It can be connected to non-redundant or redundant clients.

##### *SIMATIC S7 PLC as control center*

Like the substations, the control center comprises a SIMATIC S7-300 or S7-400 PLC. This solution is suitable for simpler control centers in which only an up-to-date process image of the process data available in the stations is required. The station process control can be influenced by entering commands, setpoints or parameters. This S7-300 or S7-400 control center can also be used to extend a PC control center (SINAUT ST7cc or ST7sc), e.g. for data output on a panel and/or as an emergency operating system.

## Application

The SINAUT engineering software with the following components is required for configuring, diagnosing and operating a telecontrol system with the ST7 or DNP3 protocol:

- SINAUT ST7 configuration and diagnostics software
- SINAUT TD7 Library

The software package is a work package which can be used for any number of SINAUT projects without a licensing process.

Apart from ST1 and ST7 connections, the SINAUT ST7 engineering software Version V5.1 or higher also supports the DNP3-compliant TIM modules TIM 3V-IE DNP3 and TIM 4R-IE DNP3. The current version V5.4 is released for STEP 7 V5.5 incl. SP2.

## Function

### SINAUT ST7 configuration and diagnostics software for STEP 7

- Executable under Windows 7, Windows Server 2008, Windows Server 2008 R2, Windows XP SP3, Windows Server 2003 R2 SP2; a STEP 7 software must also be installed.
- Includes:
  - Module manager to supplement the HW Config STEP 7 tool; it displays and sets the parameters of the TIM modules in HW Config.
  - WAN Manager to supplement the NetPro STEP 7 tool; it displays and sets the parameters of the SINAUT WAN networks and network nodes in NetPro
  - The SINAUT ST7 configuration software is used for project-wide functions such as SINAUT connection configuration and SINAUT station management
  - SINAUT ST7 diagnostics and service tool; in addition to the diagnostics functions familiar to users of STEP 7, it also provides access to SINAUT-specific diagnostic information. The service tool can be used, for example, to upload new software to the TIM.

### Module manager for SINAUT systems

A SINAUT ST7 folder is added to the SIMATIC 300 directory. This folder contains a list of all available TIM modules. The TIM module required in each case can be selected from this directory and installed in the S7 rack. A corresponding Properties dialog box can be called up to set the module parameters.

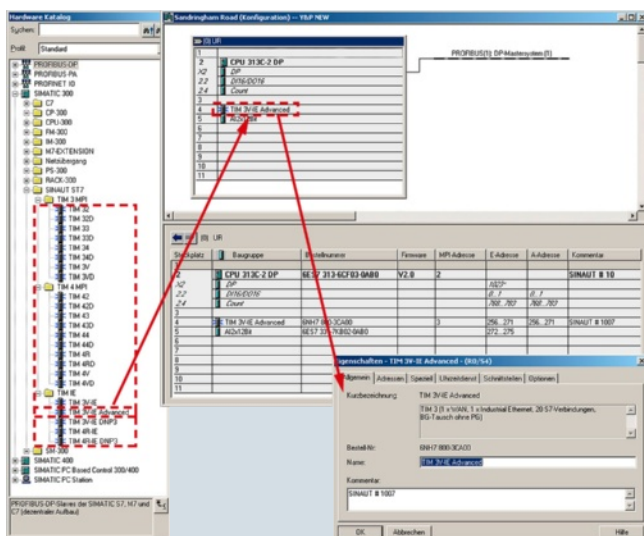

### WAN Manager for SINAUT systems

In the catalog for the STEP 7 network configuration tool NetPro, the SINAUT "dedicated line" and "dial-up" networks are added to the "Subnets" directory. The SINAUT networks required in each case can be selected from this directory and installed in the NetPro window. With the SINAUT ST7 engineering software V5.0 and higher, the MSC-VPN tunnel protocol can also be used under the "Industrial Ethernet" network type for configuring the SINAUT data transmission via the Internet and GPRS.

The TIM modules can be assigned to these networks using the mouse or dialog boxes. Any erroneous connections are rejected immediately.

A corresponding Properties dialog box is called up to define the generally valid parameters for a network, e.g. ST7 or DNP3 protocol, transmission rate, etc.

The individual properties for each of the network nodes can be defined in a further dialog box, e.g. the dedicated telephone number for the connection to a dialup network.

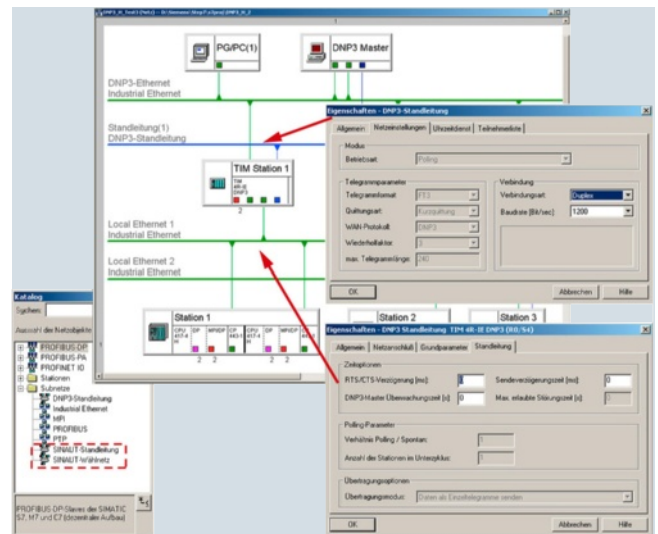

If necessary, the Properties dialog box for a TIM module can be opened in NetPro with the same property options as in HW Config.



## Industrial Remote Communication TeleControl Professional for the control center

### SINAUT engineering software

#### Function (continued)

##### SINAUT ST7 configuration software

The SINAUT ST7 configuration software is an independent configuration tool for the telecontrol system that can comprise ST1, ST7 or DNP3 modules; it includes:

- Connection configuration
- Station management
- SINAUT ST1 configuration overview

First, the "Connection configuration" tool is used to define the SINAUT stations (ST7 CPU, DNP3, ST7cc, ST7sc or ST1 device) between which a connection is required. For this purpose, the tool displays a list of all connections possible in the right-hand side of a two-section window. The tool has generated the list automatically using the network configured with NetPro (see WAN Manager for SINAUT systems). The user moves the connections actually required from the right-hand to the left-hand window using the pop-up menu.

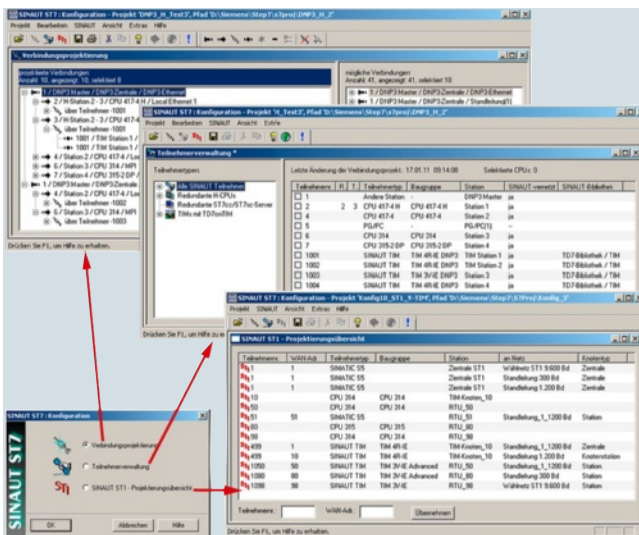

One of the features provided by the "Station management" tool is a list of all SINAUT devices. If necessary, station-specific modifications can be made, e.g. the SINAUT station numbers can be changed for the individual devices, or message texts can be configured to be sent as text messages. The station management tool also handles configuring of the data frames to be sent and received if frame generation and evaluation are to be carried out by the TIM (only possible for TIMs with TD7onTIM functionality). The tool generates the system data blocks (SDB) for the CPUs and TIMs from the configuration data. If the SINAUT TD7 software is used for the CPU, the tool also preprocesses the accounting and communication data blocks for the CPUs, which it stores in the CPU block library together with the blocks (FBs, FCs) which are essential to the CPUs for SINAUT communication.

The third tool, "SINAUT ST1 – Configuration overview" is only required for configuring systems which also feature SINAUT ST1 devices. This tool makes adjusting the addresses for SINAUT ST1 much easier.

##### SINAUT ST7 diagnostics and service tool

In addition to the diagnostics functions familiar to users of STEP 7, the SINAUT ST7 diagnostics and service tool also provides access to SINAUT-specific diagnostic information. The service tool can be used, for example, to upload new software to the TIM.

##### **SINAUT TD7 library, blocks for the CPU**

The SINAUT TD7 library is a software package with blocks for the CPU (TD7onCPU), in which TD7onCPU can be used for ST1 and ST7 systems, but not for DNP3 systems. The package has been designed so that it can run both on an S7-400 and on an S7-300 CPU. Only a small number of blocks have been designed specifically for the S7-300 or S7-400 CPU respectively.

In the stations, the SINAUT TD7 software ensures that process data is transmitted between CPU and control console, e.g. ST7cc, and from CPU to CPU in the event of changes. Connection, CPU or control center failures are displayed. A data update for all participating communication partners is performed automatically following debugging or startup of a CPU or of the control desk. A time stamp can be assigned to data message frames if required.

The package essentially comprises:

##### **Basic and auxiliary blocks**

Most of these blocks are always required in the CPU, a small number are optional. The basic blocks handle central tasks such as startup, monitoring of connections and connection partners, general requests, time management, handling communication etc. The auxiliary blocks enter data frames, for example, in the send buffer or fetch them from the receive buffer, handle send and receive jobs for specific connections, or provide information as a result of searches.

##### **Data-point typicals**

These blocks are integrated into the CPU program on the basis of the data types and data volumes to be transmitted. In the event of changes to data, they create message frames or output received process data.

In order to operate correctly, the TD7onCPU package needs a number of data blocks which are generated by the SINAUT engineering software. These are:

##### **Central accounting DB**

This block contains all data required centrally, e.g. accounting data for all communication partners as well as for all connections to be managed.

##### **Communication DBs**

A separate communication DB is created for every connection with a sending and receive mailbox and all data required for controlling and monitoring this connection.

# Industrial Remote Communication

## TeleControl Professional for the control center

### SINAUT engineering software

Technical specifications		Ordering data	Article No.
	<b>SINAUT Engineering Software V5.4</b>		
Operating systems	MS Windows 7 Professional, Ultimate (32-bit) MS Windows 7 Professional, Ultimate (64-bit) MS Windows Server 2008 (32-bit) MS Windows Server 2008 R2 Standard Edition (64-bit) MS Windows XP SP3 MS Windows Server 2003 R2 SP2	<b>SINAUT Engineering Software V5.4</b> On CD-ROM, comprising <ul style="list-style-type: none"> <li>• SINAUT Engineering Software V5.3 for the programming device</li> <li>• SINAUT TD7 block library</li> <li>• Electronic manual in German and English</li> </ul>	<b>6NH7997-0CA54-0AA0</b>
STEP 7 versions	STEP 7 V5.5 incl. SP2/SP3	<b>SINAUT Engineering Software V5.4: Upgrade from V5.0, V5.1, V5.2 or V5.3</b> For adding functional expansions; the functional expansions are for transferring larger data quantities of 1 KB and SMS functionality in GPRS mode	<b>6NH7997-0CA54-0GA0</b>
		<b>SINAUT ST7 Engineering Software V5.0 Edition 09/2009 (Upgrade)</b> for STEP 7 V5.4 SP4, for owners of older versions of SINAUT ST7 engineering software	<b>6NH7997-0CA50-0GA0</b>

## Industrial Remote Communication

### TeleControl Professional for the control center

#### SINAUT ST7cc, Add-on for WinCC

##### Overview

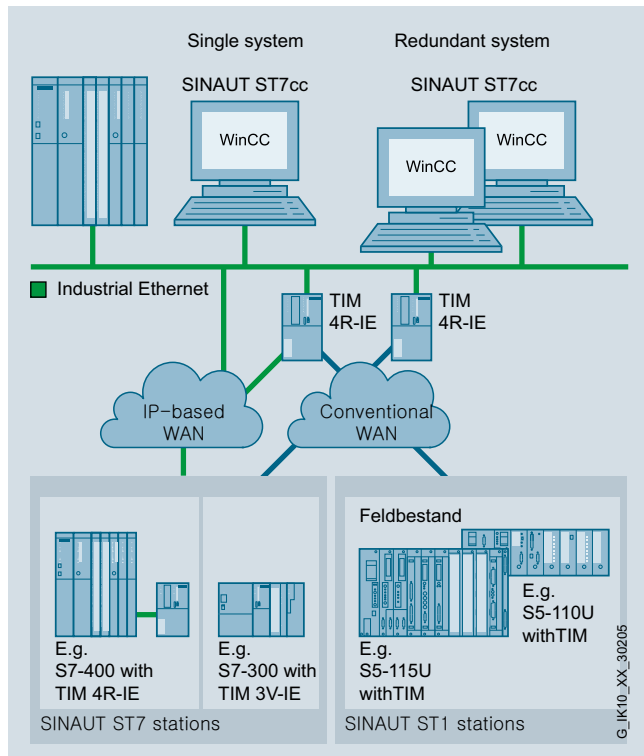

SINAUT ST7cc control center system (single or redundant) with connected ST7 and ST1 stations

Based on SIMATIC WinCC, SINAUT ST7cc is the ideal control center system for both SINAUT ST7 and SINAUT ST1. It has been developed specifically for event-driven and time-stamped data transmission on the SINAUT telecontrol system.

A fault-tolerant ST7cc control center can be set up in conjunction with the WinCC redundancy package.

SINAUT ST7cc additionally assumes the function of a telecontrol center. There is therefore no need for a separate SIMATIC S7-CPU for this function.

##### Benefits



- Interfacing of SIMATIC S7 substations to SIMATIC WinCC via conventional and IP-based telecommunications network
- Entry of messages, analog and count values in WinCC archive using the event times supplied by the substations
- Protection of investments in existing SINAUT ST1 systems, as ST1 stations can be connected
- Saving of time and reduction of costs through simple configuration without requiring detailed knowledge of SINAUT

##### Application

Based on SIMATIC WinCC, SINAUT ST7cc is the ideal control center system for both SINAUT ST7 and SINAUT ST1.

It has been developed specifically for event-driven and time-stamped data transmission on the telecontrol system. It avoids the possible loss of data inherent during cyclic polling in WinCC. It also ensures the use of the correct event times supplied by the substations for all messages and archive entries. The process image integrated into ST7cc contains all process data along with the status of all SINAUT stations in the network, and makes this data available directly to WinCC for high-speed process image visualization.

ST7ccConfig provides the user with an integrated configuring tool based on the data telegrams configured in the SINAUT ST7 or ST1 terminals. The WinCC tags are configured automatically and updated consistently to reflect any changes.

The additional use of the WinCC add-on ACRON is recommended for archives, protocols and reports in accordance with ATV Notice H260 or Hirhammer.

The Alarm Control Center software package is useful for alerting service personnel via text message, fax, e-mail or voice mail and is also available as a WinCC add-on.

A fault-tolerant ST7cc control center can be set up in conjunction with the WinCC redundancy package.



### Design

SINAUT ST7cc is installed on a Windows PC. WinCC can also run on the same PC. However, client/server configurations are also possible, in which the ST7cc is located on the WinCC server.

The following software packages and licenses are required for an ST7cc control center that is configured as a single-channel or redundant system with WinCC. A license for the WinCC complete package is required. A runtime package may be sufficient if no configurations are required on the end computer. The WinCC redundancy package incl. license is also required for the redundant ST7cc.

The table below lists the software packages required for the ST7cc non-redundant/redundant system in detail.

ST7cc non-redundant system		ST7cc redundant system	
Num-ber	Software package	Num-ber	Software package
1	WinCC complete package <sup>1)</sup>	1	WinCC complete package <sup>1)</sup>
–	–	1	WinCC runtime package
–	–	1	WinCC redundancy package (with 2 licenses)
1	SIMATIC NET SOFTNET for IE license for CP software	2	SIMATIC NET SOFTNET for IE license for CP software
–	–	1	ST7cc redundancy package (with 2 licenses)
1	SW ST7cc S (with license for 6 stations)	2	SW ST7cc S (with license for 6 stations)
	or		or
	SW ST7cc M (with license for 12 stations)		SW ST7cc M (with license for 12 stations)
	or		or
	SW ST7cc L (with license for > 12 stations)		SW ST7cc L (with license for > 12 stations)

<sup>1)</sup> A runtime package may be sufficient if no configurations are required on the end computer.

One or several SINAUT ST7 TIM communications processors are connected to the ST7cc PC depending on the TIM type used either via the MPI bus or via Ethernet. Both ST7 and ST1 terminals can be connected to the TIMs, only ST7 terminals to the TIMs on the Ethernet.

#### Provision of current time of day:

- Time synchronization for TIMs connected via MPI to the ST7cc PC is only possible using a TIM equipped with a DCF77 receiver. This is then responsible for central synchronization of the ST7cc PC and all terminals.
- Time synchronization for TIMs connected via Ethernet to the ST7cc PC is via ST7cc.

Outside the reception area of the DCF77 real-time transmitter the use of a GPS receiver is recommended. This determines the local time from the satellite-based global positioning system (GPS).

### Function

#### Functioning as a remote control center with convenient diagnostic functions

- Direct connection of SINAUT ST7 TIMs over MPI and Ethernet to ST7cc. A separate series-connected S7-300 or S7-400 controller is not required as a central remote control center.
- Provision of the most important status information for each SINAUT ST7 or ST1 station with visualization in WinCC using supplied station typicals (display typicals and faceplates).
- Control possibilities for the SINAUT stations over these faceplates.
- Tagging the process values from stations with an interrupted connection to ST7cc.
- General scanning of affected stations following the end of a transmission fault for updating the process image in ST7cc.
- For diagnostic purposes: Selective activation of recording of the message traffic for individual or all SINAUT stations. Message frame visualization and evaluation is performed in the same manner as by the TIM message frame monitor.
- Time synchronization by ST7cc for the TIMs that are connected to the ST7cc PC over Ethernet.

#### Preprocessing of process data

Preprocessing can be configured for binary values, analog values, and count values. They take into account the event time points and tag derived alarms and archive entries with correct time stamps.

- **Binary values**
  - Entry of current binary values into the assigned WinCC tags taking into account the time stamps supplied by SINAUT ST7 or ST1.
- **Analog values** (current and average values)
  - Floating-point numbers, integer values
  - Linear raw value conversion (raw value → physical value)
  - Entry of analog values (with or without linear raw value adaptation) in the associated WinCC tags
  - Entry of analog values (with or without linear raw value adaptation) into the WinCC archive taking into account the time stamps supplied by SINAUT ST7 or ST1.
- **Count values**
  - Overflow handling in the case of absolute counters.
  - Count value conversion using factors
  - Generation of correct interval times
  - Entry of currently accumulating interval quantities in the assigned WinCC tags.
  - Entry of complete interval quantities into the WinCC archive taking into account the time stamps supplied by SINAUT ST7 or ST1.
- **Setpoints**
  - Floating-point numbers, integer values
  - Linear raw value conversion (physical value → raw value) if required.

#### Simple, integrated configuring

Configuration of the overall system with ST7ccConfig is very user friendly. A separate WinCC configuration for tag management, archive and alarm system is limited to a few preparatory measures, such as the creation of archives and, in the case of WinCC, the definition of alarm classes and types.

# Industrial Remote Communication

## TeleControl Professional for the control center

### SINAUT ST7cc, Add-on for WinCC

#### Technical specifications

SINAUT ST7cc V3.1		SINAUT ST7cc V3.1	
Operating systems	Windows XP SP3; Windows Server 2003 SP2; Windows 7 SP1 (32-bit/64-bit); Windows Server 2008 SP2 (32-bit); Windows Server 2008 R2 SP1 (64-bit)	Configuration	ST7cc Config-Tool V3.1 SINAUT Engineering software
WinCC versions	SIMATIC WinCC 6.2 SP3; SIMATIC WinCC 7.0 SP2; SIMATIC WinCC 7.0 SP3 and SIMATIC WinCC V7.2 (V3.1 + SP1 or higher)	Quantity framework	Small license Medium license Large license
VMware	ESXi V5.0 (V3.1 + SP1 or higher)	<ul style="list-style-type: none"> <li>• ST7cc</li> <li>• SINAUT system</li> </ul>	
		<ul style="list-style-type: none"> <li>• 6 SINAUT terminals</li> <li>• 12 SINAUT terminals</li> <li>• for more than 12 SINAUT terminals</li> </ul>	

#### Ordering data

##### SINAUT ST7cc

Software for connecting SINAUT stations to WinCC;  
Single license for 1 installation of the runtime software;  
configuration software and electronic manual on CD-ROM,  
2 languages (German, English);  
operating systems:  
Windows XP SP3,  
Windows Server 2003 SP2,  
Windows 7 SP1 (32-bit/64-bit),  
Windows Server 2008 SP2 (32-bit),  
Windows Server 2008 R2 SP1  
(64-bit);  
license key on USB flash drive;  
German/English

##### Standard licenses

**S (Small), M (Medium), L (Large)**

##### ST7cc V3.1 S

Small license  
for max. 6 SINAUT stations

6NH7997-7CA31-0AA1

##### ST7cc V3.1 M

Medium license  
for max. 12 SINAUT stations

6NH7997-7CA31-0AA2

##### ST7cc V3.1 L

Large license  
for more than 12 SINAUT stations

6NH7997-7CA31-0AA3

##### ST7cc V3.1 RED

Redundancy license  
for ST7cc (contains 2 licenses),  
two single ST7cc S, M or L licenses  
are also required

6NH7997-8CA31-0AA0

##### PowerPacks for upgrading the license to M or L

##### ST7cc V3.1 SM PowerPack

License upgrade  
from ST7cc S to ST7cc M  
(from 6 to 12 stations)

6NH7997-7AA31-0AD2

##### ST7cc V3.1 SL PowerPack

License upgrade  
from ST7cc S to ST7cc L  
(from 6 to more than 12 stations)

6NH7997-7AA31-0AD3

##### ST7cc V3.1 ML PowerPack

License upgrade  
from ST7cc M to ST7cc L  
(from 12 to more than 12 stations)

6NH7997-7AA31-0AE3

##### Upgrade packages

##### ST7cc V3.1

**Upgrade from V3.0 to V3.1**  
Upgrade of all licenses V3.0

6NH7997-7CA31-0GA1

##### ST7cc V3.1 RED

**upgrade from V3.0 to V3.1**  
Upgrade of the redundancy license  
V3.0

6NH7997-8CA31-0GA0

##### ST7cc V3.1 S

**upgrade from V2.4 ... V2.7 to V3.1**  
for S license holders

6NH7997-7CA31-2GA1

##### ST7cc V3.1 M

**upgrade from V2.4 ... V2.7 to V3.1**  
for M or SM license holders

6NH7997-7CA31-2GA2

##### ST7cc V3.1 L

**upgrade from V2.4 ... V2.7 to V3.1**  
for L, SL or ML license holders

6NH7997-7CA31-2GA3

##### ST7cc V3.1 RED upgrade

**from V2.4 ... V2.7 to V3.1**  
Upgrade of the redundancy  
licenses V2.4 ... V2.7

6NH7997-8CA31-2GA0

##### Accessories

##### TIM 3V-IE

##### communications module

With an RS 232 interface  
for SINAUT communication via a  
conventional WAN or an IP-based  
network (WAN or LAN)

6NH7800-3BA00

##### TIM 3V-IE Advanced

##### communications module

With an RS 232 interface and  
an RJ45 interface for SINAUT  
communication via a conventional  
WAN and an IP-based network  
(WAN or LAN)

6NH7800-3CA00

##### TIM 4R-IE

##### communications module

With two combined RS 232/RS 485  
interfaces for SINAUT communica-  
tion via conventional WANs and  
two RJ45 interfaces for SINAUT  
communication via IP-based net-  
works (WAN or LAN)

6NH7800-4BA00

### Overview

WinCC/TeleControl for WinCC V7.0 SP2 supports connection to outlying stations (Remote Terminal Units = RTUs) via telecontrol protocols.

### Benefits

WinCC/TeleControl for WinCC V7.0 SP2 cannot only integrate newly configured RTUs, it can also integrate units which already exist in outlying areas by means of DNP3 or IEC 870-5-101/104 drivers.

For communication with the outstations, WinCC/TeleControl for WinCC V7.0 SP2 uses the SINAUT ST7 and DNP3 protocols (both via serial and TCP/IP communication connections) as well as IEC 870-5-101 (serial) and IEC 870-5-104 (Ethernet TCP/IP).

The serial RTU link is possible via the following components, which can be connected directly via WinCC (single station or server):

- SINAUT TIM communication modules (SINAUT ST7 telecontrol protocol)
- TCP/IP serial converter (telecontrol protocols DNP3, Modbus (not released for WinCC TC), IEC 870-5-101)

Equipment from MOXA or Lantronix, for example, can be used as TCP/IP serial converters.

By means of Ethernet TCP/IP, the RTUs can be connected directly or via TCP/IP WAN routers to the SIMATIC WinCC system bus (SINAUT ST7, DNP3, IEC 870-5-104 telecontrol protocols). When using the SINAUT ST7 telecontrol protocol, the SINAUT TIM communication module can be used in addition to the TCP/IP WAN router or as an alternative.

### Application

Telecontrol communication over the wide area network is largely determined by the communication infrastructure which already exists. Various transmission media such as dedicated line, analog or digital telephone networks, wireless networks (GSM or private), DSL or GPRS can also be combined with each other.

#### **SINAUT ST7 telecontrol protocol**

Detailed information for implementing telecontrol applications with the SINAUT ST 7 telecontrol protocol via the Industry Mall.

#### **IEC 870-5-101/-104 telecontrol protocols**

Detailed information for implementing telecontrol applications with the IEC 870-5-101/-104 telecontrol protocols via the Industry Mall.

#### **DNP3 telecontrol protocol**

WinCC/TeleControl for WinCC V7.0 SP2 also supports the DNP3 telecontrol protocol. Widely distributed outstations (RTUs) can be controlled and monitored with the DNP3 telecontrol protocol via serial or Ethernet TCP/IP communication links by means of the telecontrol center in SIMATIC WinCC. The control center integrated with SIMATIC WinCC TeleControl into the SCADA system is the master during telecontrol communication. The slaves are represented by the outstations. SIMATIC S7-300/S7-300F and S7-400/S7-400F/S7-400H/S7-400FH controllers as well as third-party RTUs can be used as outstations.

Further hardware and software components round off the range of products:

- TIM communication modules
- TCP/IP converters – serial and MD modem modules
- GSM/GPRS components
- TCP/IP routers and switches
- SCALANCE S612 and S613 security modules
- Dedicated-line accessories
- Cables
- Engineering package for configuration of DNP3 data objects, stations, networks and connections as well as for diagnostics

In order to implement telecontrol networks, basic topologies including point-to-point, multi-point, star and ring can be configured using classic or TCP/IP-based media. These can be combined flexibly independent from existing infrastructure.

Classic WAN media:

- Dedicated line via modem, e.g. SINAUT MD2
- Private wireless networks
- Analog telephone network
- Digital ISDN network
- Mobile radio network GSM

TCP/IP-based WAN media:

- Ethernet networks, e.g. SCALANCE X with fiber-optic cables
- Industrial Wireless LAN with SCALANCE W
- Public networks and the Internet using DSL and/or GPRS

## Industrial Remote Communication

### TeleControl Professional for the control center

#### WinCC/TeleControl

#### Function

##### Special characteristics of DNP3 communication

- Change-driven data transmission
  - Change-driven transmission of process data between RTU and control center
  - Signaling of RTU, control center or connection failure
  - Automatic data updating for all communication partners involved following troubleshooting and following the startup of the RTU or control center
- Chronological processing of process data
  - Time tagging of all data frames at the place of origin allows process data to be archived by the process control system in the correct chronological order
  - The time of the DNP3 stations in the WAN can be synchronized via SIMATIC WinCC (including summertime/wintertime switchover)
- Local data storage
  - The TIM communication module can temporarily store (for several hours or even days) message frames should the connection or the communication partner fail
  - Intermediate storage of message frames of lower priority in the case of priority-controlled data transmission (with dial-up networks or quantity-dependent data transmission costs)

##### Operating modes

The DNP3 telecontrol protocol supports the following operating modes:

- Polling
- Polling with time slot procedure
- Multi-master polling with time slot procedure
- Spontaneous mode in dial-up networks
- Spontaneous mode in the TCP/IP-based WAN

#### Integration

Integration of WinCC/TeleControl for WinCC V7.0 SP2 into the WinCC SCADA system offers particular advantages for the water and waste water sectors, as well as oil and gas sectors, especially in the case of the following types of plant:

- Freshwater treatment and distribution
- Wastewater treatment plants
- Oil and gas pipelines and water pipes
- Oil and gas drilling fields and the associated treatment plants

In these types of plant, remote outstations such as pumping stations, valve stations or automated stations for wellheads must be integrated.

Through the support of communication protocols for RTUs such as SINAUT ST7, WinCC/TeleControl for WinCC V7.0 SP2 supports the following advanced communication concepts:

- Reduction in the transferred data volume by means of event-controlled communication mechanisms for alarm and measured value information.
- Time-synchronization of RTUs and correct time stamping of all data in the RTU.
- Tolerance of lower bandwidth, high latency or lack of reliability of communication lines
- Prevention of data loss due to communications failure through data backup in the RTU
- Support of communication media with serial interface (dedicated lines, dial-up connections over analog telephone lines and ISDN lines), various radio devices (standard, spread spectrum modulation), microwave and GSM
- Support for TCP/IP-based WANs (Wide Area Networks) such as DSL, GPRS or Ethernet radio networks
- Support for redundant communication connections
- Expanded communication diagnostics functions for RTU communication links
- Remote programming of RTUs
- Support for different communication topologies – Point-to-point, multidrop (multistation mode) and hierarchic network structures
- High quality server redundancy scheme without data loss in the case of server failure

Through the support of communication protocols for RTUs such as IEC 60870-5 and DNP3, SIMATIC TeleControl for WinCC V7.0 SP2 supports the following advanced communication concepts:

- Reduction in the transferred data volume by means of event-controlled communication mechanisms for alarm and measured value information.
- Time synchronization of RTUs and correct time stamping of all data in the RTU.
- Tolerance of lower bandwidth, high latency or lack of reliability of communication lines
- Prevention of data loss due to communications failure through data backup in the RTU (not all non-Siemens RTUs support this)
- Support of communication media with serial interface (dedicated lines, dial-up connections over analog telephone lines and ISDN lines), various radio devices (standard, spread spectrum modulation), microwave and GSM
- Support for TCP/IP-based WANs (Wide Area Networks) such as DSL, GPRS or Ethernet radio networks
- Support for redundant communication connections
- Expanded communication diagnostics functions for RTU communication links
- Remote programming of RTUs
- Support for different communication topologies – Point-to-point, multidrop (multistation mode) and hierarchic network structures
- High quality server redundancy scheme without data loss in the case of server failure

### Integration (continued)

#### Outstations/remote terminal units

WinCC/TeleControl for WinCC V7.0 SP2 supports the following preferred outstations for local distributed automation:

- Controller integrated into ET 200S (IEC 870-5-101/104 telecontrol protocols); for cost-sensitive applications, up to approx. 30 I/O signals or approx. 200 data points
- S7-300/S7-300F controller (SINAUT ST7, DNP3, IEC 870-5-101/104 telecontrol protocols); for extremely flexible configuration, up to 100 I/O signals or approx. 2 000 data points
- S7-400/S7-400F controller (SINAUT ST7, DNP3, IEC 870-5-101/104 telecontrol protocols); up to 500 I/O signals or approx. 5 000 data points
- S7-400/S7-400F redundant controller (IEC 870-5-101/104 and DNP3 telecontrol protocols); up to 500 I/O signals or approx. 5 000 data points
- Third-party station with the IEC 870-5-101/104 and DNP3 telecontrol protocols (depending on type of station)

The following table provides an overview of the current options for connecting to these outstations:

Spectrum of outstations and integration versions							
Telecontrol protocol	SINAUT ST 7		DNP3		IEC 870-5-01	IEC 870-5-04	
Type of communication	Serial	Ethernet TCP/IP	Serial	Ethernet TCP/IP	Serial	Ethernet TCP/IP	
Interface	TIM 4R-IE	TCP/IP WAN router or/and TIM 4R-IE	TCP/IP serial converter	TCP/IP WAN router	TCP/IP serial converter	TCP/IP WAN router	
RTU/interface	ET 200S with integr. CPU (corresponding to S7-314)	-	-	-	IM 151-7 CPU or IM 151-8 PN/DP CPU as well as 1 SI module + SIPLUS RIC library	IM 151-8 PN/DP CPU + SIPLUS RIC library	
	S7-300/S7-300F	TIM 3V-IE	TIM 3V-IE	TIM 3V-IE DNP3	TIM 3V-IE DNP3	CP 341 + SIPLUS RIC library	CP 343 + IEC on S7 or integr. PN interface + SIPLUS RIC library
	S7-400/S7-400F	TIM 4R-IE	TIM 4R-IE	TIM 4R-IE DNP3	TIM 4R-IE DNP3	CP 441 + SIPLUS RIC library	CP 443 + SIPLUS RIC library or integr. PN interface + SIPLUS RIC library
	S7-400H/S7-400FH	-	-	TIM 4R-IE DNP3	TIM 4R-IE DNP3	ET 200M + 2 x CP 341 + SIPLUS RIC library	CP 443 + SIPLUS RIC library
	Third-party station	-	-	Depends on type of station	Depends on type of station	Depends on type of station	
Dial-up lines	•	-	•	-	-	-	
Dedicated line and radio networks	•	•	•	•	•	•	
Master/slave	•	•	•	•	•	•	
Peer-to-peer	•	•	-	-	•	•	
Mesh networks	•	•	•	•	•	•	
Time tagging in RTU	•	•	•	•	•	•	
RTU time synchronization	•	•	•	•	•	•	
Data buffering in RTU	•	•	•	•	• <sup>1)</sup>	• <sup>1)</sup>	
Routing with SIMATIC PDM	•	•	-	-	-	•	
International standard	-	-	•	•	•	•	

<sup>1)</sup> Data buffering is limited to two SIMATIC S7 data blocks. Depending on the SIMATIC CPU, this corresponds to approx. 800 to 3200 buffered frames.

# Industrial Remote Communication

## TeleControl Professional for the control center

### WinCC/TeleControl

Ordering data	Article No.	Article No.	
<b>SIMATIC TeleControl 7.0 SP2 for WinCC Basic Engineering</b> Software package with SIMATIC TeleControl for WinCC 7.0 SP2 Engineering Software, 2 languages (English, German), executable with Windows XP Professional/Server 2003, Floating License for one user; electronic documentation on CD/DVD, 2 languages (English, German) Type of delivery: License key memory stick, Certificate of License incl. terms and conditions, SIMATIC WinCC Data Medium Package V7.0 + SP2 and CD "WinCC TeleControl Option V7.0 + SP2"	<b>6DL5000-7AA07-0XA5</b>	<b>SIMATIC TeleControl 7.0 SP2 for Server Runtime (unlimited stations)</b> Software package with SIMATIC TeleControl for WinCC 7.0 SP2 Runtime Software, 2 languages (English, German), executable with Windows Server 2003, Single License for one user; electronic documentation on CD/DVD, 2 languages (English, German) Type of delivery: License key memory stick, Certificate of License incl. Terms and Conditions, SIMATIC WinCC Data Medium Package V7.0 + SP2 and CD "WinCC TeleControl Option V7.0 + SP2"	<b>6DL5002-7AF07-0XA0</b>
<b>SIMATIC TeleControl 7.0 SP2 for Server Runtime (6 stations)</b> Software package with SIMATIC TeleControl for WinCC 7.0 SP2 Runtime Software, 2 languages (English, German), executable with Windows Server 2003, Single License for one user; electronic documentation on CD/DVD, 2 languages (English, German) Type of delivery: License key memory stick, Certificate of License incl. terms and conditions, SIMATIC WinCC Data Medium Package V7.0 + SP2 and CD "WinCC TeleControl Option V7.0 + SP2"	<b>6DL5002-7AA07-0XA0</b>	<b>Driver software for telecontrol protocols TeleControl SINAUT Driver</b> Runtime license for one WinCC Single Station or one WinCC server, Single License for 1 installation Requirement: Software SIMATIC TeleControl 7.0 SP2 for WinCC Server Runtime (6, 12, 256 stations) Type of delivery: License key memory stick, Certificate of License incl. terms and conditions	<b>6DL5101-8AX00-0XB0</b>
<b>SIMATIC TeleControl 7.0 SP2 for Server Runtime (12 stations)</b> Software package with SIMATIC TeleControl for WinCC 7.0 SP2 Runtime software, 2 languages (English, German), executable with Windows Server 2003, single license for one user; electronic documentation on CD/DVD, 2 languages (English, German) Type of delivery: License key memory stick, Certificate of License incl. terms and conditions, SIMATIC WinCC Data Medium Package V7.0 + SP2 and CD "WinCC TeleControl Option V7.0 + SP2"	<b>6DL5002-7AB07-0XA0</b>	<b>TeleControl DNP3 Driver</b> Runtime license for one WinCC Single Station or one WinCC server, single license for 1 installation Requirement: Software SIMATIC TeleControl 7.0 SP2 for WinCC Server Runtime (6, 12, 256 stations) Type of delivery: License key memory stick, Certificate of License incl. terms and conditions	<b>6DL5101-8EX00-0XB0</b>
<b>SIMATIC TeleControl 7.0 SP2 for Server Runtime (256 stations)</b> Software package with SIMATIC TeleControl for WinCC 7.0 SP2 Runtime software, 2 languages (English, German), executable with Windows Server 2003, single license for one user; electronic documentation on CD/DVD, 2 languages (English, German) Type of delivery: License key memory stick, Certificate of License incl. terms and conditions, SIMATIC WinCC Data Medium Package V7.0 + SP2 and CD "WinCC TeleControl Option V7.0 + SP2"	<b>6DL5002-7AE07-0XA0</b>	<b>TeleControl IEC 870-5-101/-104 Driver</b> Runtime license for one WinCC Single Station or one WinCC server, single license for 1 installation Requirement: Software SIMATIC TeleControl 7.0 SP2 for WinCC Server Runtime (6, 12, 256 stations) Type of delivery: License key memory stick, Certificate of License incl. terms and conditions	<b>6DL5101-8CX00-0XB0</b>

### More information

For an overview of the complete performance spectrum on the Internet, visit:

Service & Support:

[http://www.siemens.com/automation/csi\\_en\\_WW/service\(international\)](http://www.siemens.com/automation/csi_en_WW/service(international))

Technical Support (hotline) for Automation & Drives:

[http://www.siemens.com/automation/csi\\_en\\_WW/support\\_request\(international\)](http://www.siemens.com/automation/csi_en_WW/support_request(international))

### Overview

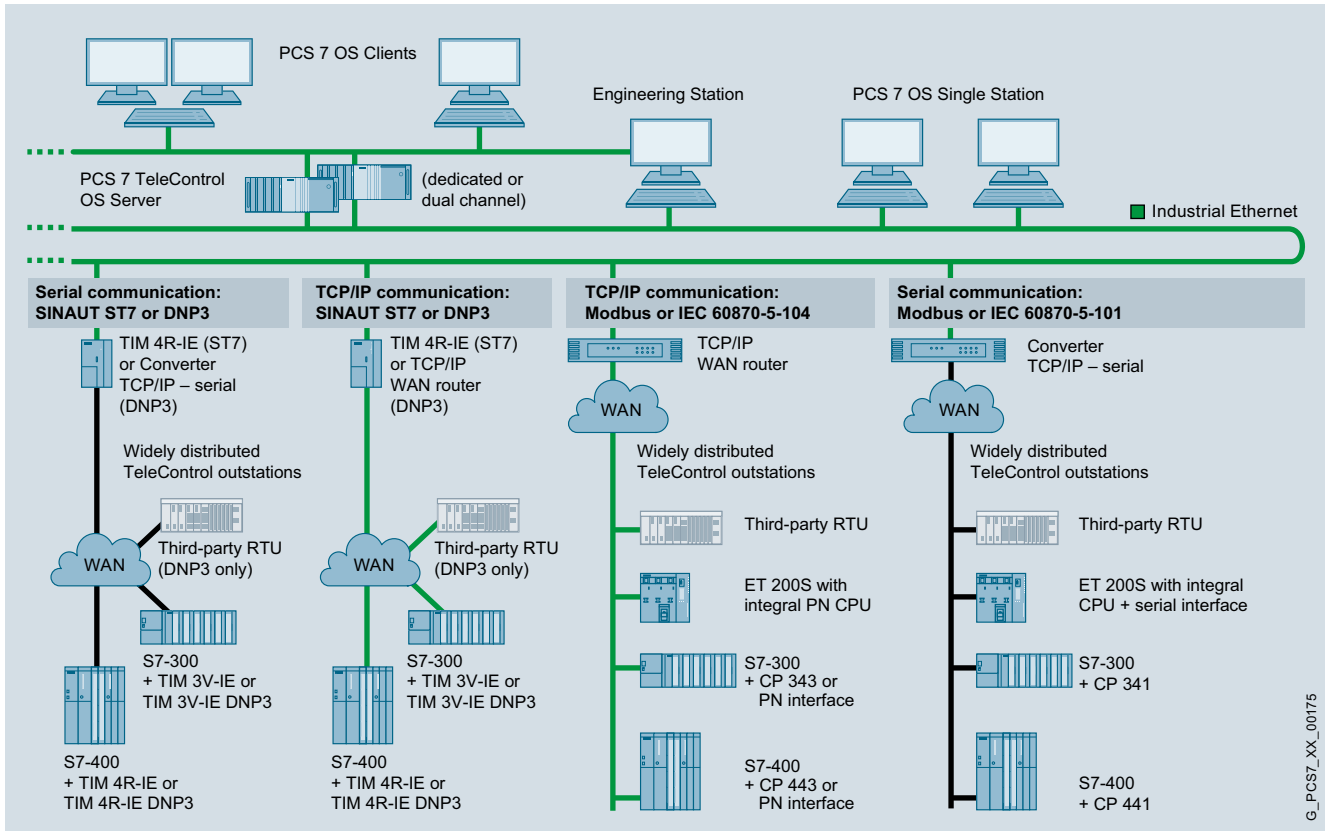

Integration and communication options with SIMATIC PCS 7 TeleControl

Plants are often scattered over very large grounds in the energy and transportation industries, and especially in the water & wastewater and oil & gas industries. In such cases it is necessary to integrate outstations for monitoring and controlling highly remote plant units (usually with a small or medium degree of automation) into the control system of the complete plant. This is carried out by means of telecontrol protocols over a WAN (Wide Area Network).

Conventional automation solutions for telecontrol systems use process control systems for the more complex central areas of the plant, and simpler Remote Terminal Units (RTUs) for the outstations, and then combine these separately configured plant units in a host network control system.

### Direct integration of the telecontrol center

However, it is far more efficient if the telecontrol center for the RTUs is directly integrated into the process control system. The network control system as the superimposed integration level can then be omitted.

The SIMATIC PCS 7 TeleControl products are suitable for integration of the telecontrol center into the process control and engineering of the SIMATIC PCS 7 process control system. They support the RTU linking in various ways (see graphic "Integration and communication options with SIMATIC PCS 7 TeleControl" and table "Integratable remote stations – current range, communication options and features").





As far as the scope and performance of the automation functions are concerned, the requirements of the widely distributed plant sections are usually in the bottom to mid range, which means you can use automation stations of reduced dimensions for the outstations. SIMATIC PCS 7 TeleControl particularly supports the following outstations for distributed automation on site:

## Industrial Remote Communication

### TeleControl Professional for the control center

#### PCS 7 TeleControl

#### Overview (continued)

RTU type <sup>1)</sup>		RTU category	Possible telecontrol protocols
	Controller integrated in SIMATIC ET 200S	<b>Small with 30 ... 200 I/Os<sup>2)</sup></b> For small applications	<ul style="list-style-type: none"> <li>• Modbus RTU</li> <li>• IEC 60870-5-101</li> <li>• IEC 60870-5-104</li> </ul>
	SIMATIC S7-300/S7-300F controller	<b>Medium with 100 ... 2 000 I/Os<sup>2)</sup></b> For medium sized applications	<ul style="list-style-type: none"> <li>• SINAUT ST7</li> <li>• DNP3</li> <li>• Modbus RTU</li> <li>• IEC 60870-5-101</li> <li>• IEC 60870-5-104</li> </ul>
	SIMATIC S7-400/S7-400F controller	<b>Large with 500 ... 5 000 I/Os<sup>2)</sup></b> For larger applications requiring higher performance	<ul style="list-style-type: none"> <li>• SINAUT ST7</li> <li>• DNP3</li> <li>• Modbus RTU</li> <li>• IEC 60870-5-101</li> <li>• IEC 60870-5-104</li> </ul>
	SIMATIC S7-400H/S7-400FH controller		<ul style="list-style-type: none"> <li>• DNP3</li> <li>• IEC 60870-5-101</li> <li>• IEC 60870-5-104</li> </ul>

<sup>1)</sup> Also in version "SIPLUS extreme", e.g. for environments with temperatures from -25 °C to +70 °C, condensation or medial load

<sup>2)</sup> Dependent on CPU size, protocol type, and application

For more information about telecontrol protocols, economic RTU bundles, possible operating modes, and special remote configurations, see:

- Catalog ST PCS 7 AO, Add-ons for the SIMATIC PCS 7 Process Control System, section Industry-specific applications, Telecontrol, Telecontrol - SIPLUS RIC (telecontrol protocol and IEC 60870-5-101/104 bundles as well as Modbus RTU)
- Catalog IK PI, Industrial Communication SIMATIC NET, Industrial Remote Communication, TeleControl Professional for substations (substations for ST7 protocol and substations for DNP3 protocol)

#### Note:

SIMATIC PCS 7 TeleControl V8.0 is supplied with the current service pack. SIMATIC PCS 7 TeleControl V8.0+SP2 can be operated in combination with the OS engineering software and OS runtime software SIMATIC PCS 7 V8.0+SP1. The SIMATIC PCS 7 software must be ordered separately from Catalog ST PCS 7.



### Benefits

- SIMATIC PCS 7 TeleControl cannot only integrate newly configured RTUs into SIMATIC PCS 7, but also migrate units which already exist in outdoor areas.
- As a result of its high level of integration, automation based on SIMATIC PCS 7 TeleControl offers decisive advantages compared to previous automation solutions with telecontrol engineering.
  - The uniform SIMATIC PCS 7 software platform allows high efficiency during operation, and results in low costs for training, configuration and servicing.
  - The homogenous GUI for local and remote processes simplifies operation and simultaneously reduces the risk of an operator error.
- The Data Base Automation (DBA) software efficiently supports engineering and takes into account the conformity with SIMATIC PCS 7.
  - DBA considerably facilitates project-specific adaptation of the system and importing of existing configurations in the course of migration.
  - Extensions can be added during plant operation.

### Application

Remote control and monitoring of distributed stations, as well as data recording and transmission, with the following focal points:

- Water industry
  - Well, pumping and slide valve stations in water supply networks and irrigation plants
  - Pumping and slide valve stations in water and wastewater pipelines
  - Storm-water tanks and siphon stations in wastewater networks
  - Storage units (elevated tanks)
- Oil and gas industries
  - Compressor, pressure reduction, transfer, block valve, and metering stations in gas networks
  - Pumping and slide valve stations in oil pipelines
  - Automation on the wellhead of gas and oil wells
  - Stations for the injection of water or CO<sub>2</sub> in gas or oil fields
- Energy management, environmental protection, and transportation
  - Equipment for power generation and distribution
  - District heating
  - Traffic control systems
  - Tunnels
  - Railway stations
  - Lighthouses
  - Environmental monitoring equipment
  - Weather stations

### Design

The telecontrol center for the outstations (RTU) is integrated into the process control of the SIMATIC PCS 7 process control system in the form of an operator station in single station or server design (also redundant as option). No additional automation system for conditioning and connecting telecontrol-specific data need be planned in the SIMATIC PCS 7 system. With large quantity frameworks, a PCS 7 TeleControl operator station (single station/server) is preferably responsible only for the telecontrol mode (dedicated). With small quantity frameworks, a server or a single station can also control SIMATIC PCS 7 automation systems in central plant areas in addition to the RTUs (dual-channel mode).

To enable engineering of the PCS 7 TeleControl operator station (single station/server), the functions of the engineering station of the SIMATIC PCS 7 process control system are expanded by DBA technology (Data Base Automation) and the SIMATIC PCS 7 TeleControl block library.

For communication with the RTUs, SIMATIC PCS 7 TeleControl uses the telecontrol protocols SINAUT ST7, DNP3 and Modbus RTU (via serial as well as TCP/IP communication connections) and also IEC 60870-5-101 (serial) and IEC 60870-5-104 (Ethernet TCP/IP).

With serial RTU interfacing, the telecontrol connection can be implemented cost-effectively at the control center end (PCS 7 TeleControl OS as single station or server) using the following components:

- SINAUT TIM communication modules (SINAUT ST7 telecontrol protocol)
- TCP/IP-to-serial converter  
e.g. devices from the companies MOXA or Lantronix (telecontrol protocols DNP3, Modbus RTU, IEC 60870-5)

Remote stations can be connected either directly via Ethernet TCP/IP or via TCP/IP WAN routers to the SIMATIC PCS 7 plant bus (telecontrol protocols SINAUT ST7, DNP3, Modbus RTU, IEC 60870-5-104). When using the SINAUT ST7 telecontrol protocol, the SINAUT TIM communication module can be used in addition to the TCP/IP WAN router or as an alternative.

## Industrial Remote Communication

### TeleControl Professional for the control center

#### PCS 7 TeleControl

#### Design (continued)

The table "Integrable outstations" shows the current connection possibilities depending on the type of RTU and type of communication.

Outstations for integration (RTU) Current range, communication options and features									
Telecontrol protocol		SINAUT S7		Modbus RTU		DNP3		IEC 60870-5-101 IEC 60870-5-104	
Type of communication		Serial	Ethernet TCP/IP	Serial	Ethernet TCP/IP	Serial	Ethernet TCP/IP	Serial	Ethernet TCP/IP
Interface on the PCS 7 TeleControl OS		TIM 4R-IE	TCP/IP WAN router or/and TIM 4R-IE	TCP/IP serial converter	TCP/IP WAN router	TCP/IP serial converter	TCP/IP WAN router	TCP/IP serial converter	TCP/IP WAN router
RTU/ interface	ET 200S with integrated CPU (corresponds to S7-314)	–	–	IM 151-7 CPU or IM 151-8 PN/DP CPU as well as 1 SI Modbus module	IM 151-8 PN/DP CPU + S7 OpenModbus software/TCP PN-CPU	–	–	IM 151-7 CPU or IM 151-8 PN/DP CPU as well as 1 SI module + SIPLUS RIC library	IM 151-8 PN/DP CPU + SIPLUS RIC library
	S7-300/ S7-300F	TIM 3V-IE	TIM 3V-IE	CP 341	CP 343 + SW library	TIM 3V-IE DNP3	TIM 3V-IE DNP3	CP 341 + SIPLUS RIC library	CP 343 + SIPLUS RIC library or integrated PN interface + SIPLUS RIC library
	S7-400/ S7-400F	TIM 4R-IE	TIM 4R-IE	CP 441	CP 443 + SW library	TIM 4R-IE DNP3	TIM 4R-IE DNP3	CP 441 + SIPLUS RIC library	CP 443 + SIPLUS RIC library or integrated PN interface + SIPLUS RIC library
	S7-400H/ S7-400FH	–	–	–	–	TIM 4R-IE DNP3	TIM 4R-IE DNP3	ET 200M + 2 x CP 341 + SIPLUS RIC library	CP 443 + SIPLUS RIC library or integrated PN interface + SIPLUS RIC library
	Third-party station	–	–	Depends on type of station		Depends on type of station		Depends on type of station	
Dialup lines		•	–	–	–	–	–	–	–
Dedicated lines and radio networks		•	•	•	•	•	•	•	•
Master/slave		•	•	•	•	•	•	•	•
Peer-to-peer		•	•	–	–	–	–	•	•
Mesh networks		•	•	–	–	•	•	•	•
Time tagging in RTU		•	•	–	–	•	•	•	•
RTU time synchronization		•	•	–	–	•	•	•	•
Data buffering in RTU		•	•	–	–	•	•	•	•
S7 routing		•	•	–	–	–	•	–	•
International standard		–	–	• (many versions)	• (many versions)	•	•	•	•

The telecontrol protocols used by SIMATIC PCS 7 TeleControl for remote communication are matched to the conditions of the widely distributed communication infrastructure.

### Design (continued)

The WAN transmission media suitable for communication between the RTUs and the telecontrol center are diverse, e.g.

- Private networks
  - Wireless
  - Dedicated line
  - WLAN
- Public networks
  - GPRS
  - EGPRS
  - UMTS
  - DSL

Based on the four basic topological forms (point-to-point, multi-point, star and ring), differently structured telecontrol networks can be implemented with these media versions, e.g. star over wireless, dedicated line or DSL. Through a combination of several basic topologies of the same or different media versions, it is also possible to design more complex network topologies, even with redundant communication paths. Optimum adaptation to the local conditions and the infrastructure which may already exist is possible in this manner.

### Migration of existing telecontrol systems

#### SINAUT ST1 stations based on SIMATIC S5

In the course of migration of existing plants, RTUs based on SIMATIC S5 can also be integrated via SIMATIC PCS 7 TeleControl into the process control system. In the process, the ST1 telecontrol protocol is converted into the ST7 protocol in the central TIM communication module.

#### Units with Modbus RTU communication

Existing plant sections that have a Modbus infrastructure, even those outdoors, can be integrated into SIMATIC PCS 7 using SIMATIC PCS 7 TeleControl. These sections can be integrated into SIMATIC PCS 7 using the Modbus RTU protocol via serial lines or TCP/IP connections.

Whereas RTUs with Modbus TCP/IP interface can be integrated directly, third-party RTUs require special interface converters for telecontrol communication.

#### Third-party stations with telecontrol protocols

In addition to the Modbus RTU telecontrol protocol, the DNP3 (serial and TCP/IP), IEC 60870-5-101 (serial) and IEC 60870-5-104 (TCP/IP) telecontrol protocols also support the control center interfacing of third-party RTUs in the course of migration. A prerequisite is that the RTU supports the corresponding protocol and that the required interface converters are available.

#### Third-party stations with OPC

Third-party RTUs for which an OPC server exists can be integrated into the process control with the PCS 7 TeleControl operator system using additional engineering services on the basis of the DBA technology. SIMATIC PCS 7 TeleControl then supports data exchange between the operator system (OPC client) and the RTU (OPC server) per OPC DA.

#### SINAUT LSX systems

Existing SINAUT LSX systems can also be migrated with SIMATIC PCS 7 TeleControl. The SIMATIC S7 controllers with the EDC telecontrol protocol (Event Driven Communication) installed in the SINAUT LSX system are integrated into SIMATIC PCS 7 TeleControl with PCS 7 TeleControl S7 EDC drivers (for ordering data, refer to the following catalog section PCS 7 TeleControl operator system). Because the SINAUT LSX system can coexist at all levels next to the new system architecture as long as necessary, step-by-step modernization is possible without short-lived intermediate solutions.

### Mode of operation

With SIMATIC PCS 7 TeleControl, the outstations can be integrated into SIMATIC PCS 7 so that the operator notices no difference between central or remote automation with regard to the operating philosophy and alarm response.

The OS clients of the client/server multi-user system are able to display data from RTUs and SIMATIC PCS 7 automation systems (AS) – which they receive from a server with dual-channel functionality or from two separate servers - together in one process image. Display is primarily on faceplates for process objects such as motors, valves etc., but also by means of trend curves and messages.

If the PCS 7 TeleControl OS server is of redundant design, the redundant pair of PCS 7 TeleControl OS servers matches all internally generated information, e.g. alarm states and results of calculations.

The communication mode between the control center and RTU depends on the type of WAN, the configuration of the telecontrol communication, and the support by the telecontrol protocol. The operating modes available with the SINAUT ST7 telecontrol protocol are described, for example, in the section "Industrial Remote Communication", "TeleControl Professional, Introduction" of Catalog IK PI ("Industrial Communication SIMATIC NET").

### Function

Conditioning and display of data on the PCS 7 TeleControl OS (single stations/servers) are carried out by SIMATIC PCS 7 TeleControl blocks present in a library. These blocks support operator prompting in conformance with SIMATIC PCS 7 using symbols and faceplates, and also the hierarchy of the SIMATIC PCS 7 alarms.

In addition to blocks for processing of process data, the library also contains blocks for diagnostics and control of communication. If necessary, the supplied basic library can be extended using the DBA Type Editor by new script-based block types specific to the project.

Engineering can be automated efficiently and in conformance with SIMATIC PCS 7 using the DBA technology. DBA supports plant expansion during ongoing operation, and facilitates project-specific adaptation of the system as well as importing of existing configurations in the course of migration.

When linking RTUs by means of the SINAUT ST7, DNP3, IEC 60870-5-101 or IEC 60870-5-104 telecontrol protocol, the raw data in the remote stations is provided with a time tag and transmitted to the PCS 7 TeleControl OS (server/single station) acting as control center. Adaptation, further processing and archiving are carried out there. This procedure is appropriate for the event-based principle of operation of the telecontrol protocol as well as the subsequent chronological processing of data which was buffered in the remote station.

The time and date of the remote stations connected per SINAUT ST7, DNP3, IEC 60870-5-101 or IEC 60870-5-104 can be synchronized by the PCS 7 TeleControl OS (time master). Switchover between daylight-saving time and standard time is also taken into account.

In order to comply with guidelines, statutory directives and standards it may be necessary to provide special proof, e.g. proof of conformity with the ATV M260 guideline for sewage treatment plants. For this we recommend the ACRON software package equipped with even more functionality for long-term archiving and logging. ACRON is an add-on product in the Catalog ST PCS 7 AO (Add-ons for SIMATIC PCS 7).

### More information

Additional information is available on the Internet at:

<http://www.siemens.com/simatic-pcs7/telecontrol>

## Industrial Remote Communication

### TeleControl Professional for the control center

#### PCS 7 TeleControl Engineering Station

##### Overview

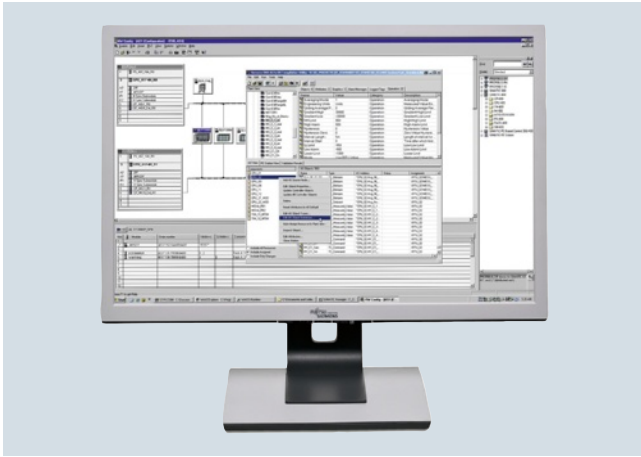

The PCS 7 TeleControl OS Engineering software package is used to configure a SIMATIC PCS 7 industrial workstation of single station or server design as a SIMATIC PCS 7 TeleControl engineering station.

##### Design

###### PCS 7 TeleControl OS Engineering

The software product PCS 7 TeleControl OS Engineering contains the OS engineering package PCS 7 TeleControl OS DBA and the associated engineering license.

Ordering data for the SIMATIC PCS 7 Engineering Software and for further SIMATIC PCS 7 software components for the PCS 7 TeleControl engineering station can be found in the Catalog ST PCS 7, section "Engineering system", "ES software".

SIMATIC PCS 7 Industrial Workstations suitable as basic hardware for a SIMATIC PCS 7 TeleControl engineering station can be found in Catalog ST PCS 7, section "Industrial Workstation/PC".

###### PCS 7 TeleControl OS DBA

PCS 7 TeleControl OS DBA is an OS engineering package for expansion of the SIMATIC PCS 7 Engineering Software, comprising the OS Data Base Automation (DBA) software and a library with OS symbols, OS faceplates, and OS diagnostics displays for remote stations (RTUs) of a telecontrol system.

Using the DBA type editor it is possible to assign the frequently unstructured variables of an RTU once to a block type and to display the tag structured on the operator station via the block's faceplate (OS faceplate). Each block type contains at least one faceplate and one symbol.

The DBA automatically generates the OS runtime database with the display hierarchy, required tags, interrupts, alarm messages, and alarm priorities, as well as the specific faceplates and block symbols. The display hierarchy is the basis for navigation between the process displays, for alarm management, and for implementation of safety measures. PCS 7 TeleControl OS DBA automatically positions the type-specific block symbols, for example, measured value, counter value, motor or gate valve, in the OS process pictures. These values are linked to the corresponding function blocks and faceplates using the database. Manual configuration is mainly limited to the design and positioning of the static graphic elements, for example, tubes or tanks.

The PCS 7 TeleControl OS symbols, faceplates and diagnostics displays created in conformance with SIMATIC PCS 7 take into account the specific features of telecontrol applications. This is demonstrated, for example, by the example of the counter block which offers versatile conditioning options for information on transported or processed quantities and volumes.

###### Definition of new user blocks

New user blocks can also be defined using the DBA type editor, and are handled during database generation like the blocks from the basic library.

In addition to arrangement of information in a variable structure, these user blocks can also calculate derived values using Visual Basic scripts in the server. This results in numerous possibilities for extending the functionality and for adapting the system to individual customer requirements.

Type-specific OS faceplates and OS symbols for the user blocks can be created using the standard tools for SIMATIC PCS 7 OS engineering (Graphics Designer and Faceplate Designer).

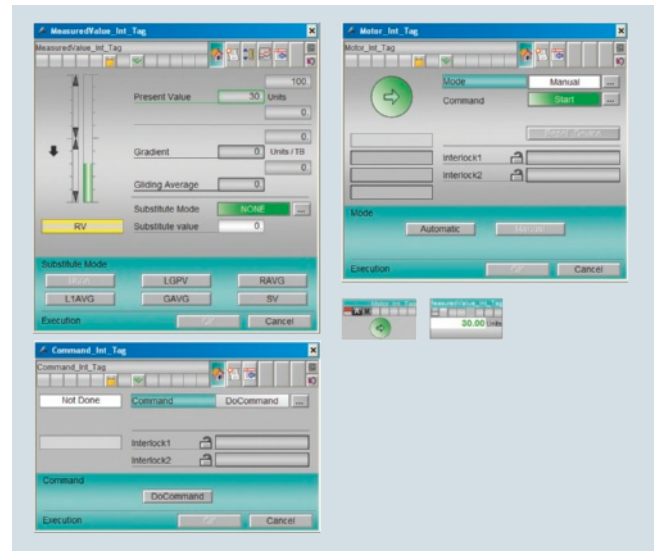

Faceplates from the SIMATIC PCS 7 TeleControl library

###### Upgrade

Existing SIMATIC PCS 7 TeleControl OS Engineering Software V7.1 can be upgraded from V7.1 to V8.0 (incl. service pack) using the SIMATIC PCS 7 TeleControl Upgrade Package. This SIMATIC PCS 7 TeleControl Upgrade Package is suitable for upgrading SIMATIC PCS 7 TeleControl OS Runtime Software V7.1. The SIMATIC PCS 7 ES and OS Software V7.1 combined in certain software products can be upgraded separately to V8.0 (incl. service pack) using the upgrade packages in Catalog ST PCS 7, sections "Upgrades for engineering system" and "Upgrades for operator system".

###### Engineering of Remote Terminal Units (RTUs) based on S7-300

Using the technology blocks of the SIMATIC PCS 7 Industry Library (sublibrary "Industry Library for S7"), Remote Terminal Units (RTUs) based on S7-300 can also be configured in CFC in APL style system compatibility. For information about the SIMATIC PCS 7 Industry Library and ordering data, refer to the Chapter "Technology libraries".

# Industrial Remote Communication

## TeleControl Professional for the control center

### PCS 7 TeleControl Engineering Station

Ordering data	Article No.		Article No.
<p><i>Engineering software</i></p> <p><b>PCS 7 TeleControl OS Engineering V8.0</b> To expand a SIMATIC PCS 7 Engineering Station (unlimited POs) for PCS 7 TeleControl; software package without SIMATIC PCS 7 Engineering Software</p> <p>Engineering software, 2 languages (English, German), software class A, runs on Windows XP Professional 32-bit, Windows 7 Ultimate 32/64-bit, Windows Server 2003 R2 Standard 32-bit or Windows Server 2008 R2 Standard 64-bit, floating license for 1 user</p> <p>Electronic documentation on DVD, 2 languages (English, German)</p> <p>Delivery form package (without SIMATIC PCS 7 Software Media Package):</p> <ul style="list-style-type: none"> <li>• License key USB stick, certificate of license</li> <li>• DVD "PCS 7 TeleControl"</li> </ul>	<p><b>6ES7658-7JX08-0YA5</b></p>	<p><i>Upgrade Package</i></p> <p><b>SIMATIC PCS 7 TeleControl Upgrade Package V7.1 to V8.0</b> Software package without SIMATIC PCS 7 ES/OS software</p> <p>2 languages (English, German), software class A, runs with Windows XP Professional 32-bit, Windows 7 Ultimate 32/64-bit, Windows Server 2003 R2 Standard 32-bit or Windows Server 2008 R2 Standard 64-bit; single license for 1 installation</p> <p><u>Note:</u> SIMATIC PCS 7 ES and OS Software V7.1 included in certain software packages must be upgraded to V8.0 (incl. service pack) using separate upgrade packages.</p> <p>Delivery form package (without SIMATIC PCS 7 Software Media Package):</p> <ul style="list-style-type: none"> <li>• License key USB stick, certificate of license</li> <li>• DVD "PCS 7 TeleControl" and product information</li> </ul>	<p><b>6ES7652-5GX08-0YE0</b></p>

## Industrial Remote Communication

### TeleControl Professional for the control center

#### PCS 7 TeleControl Operator System

#### Overview

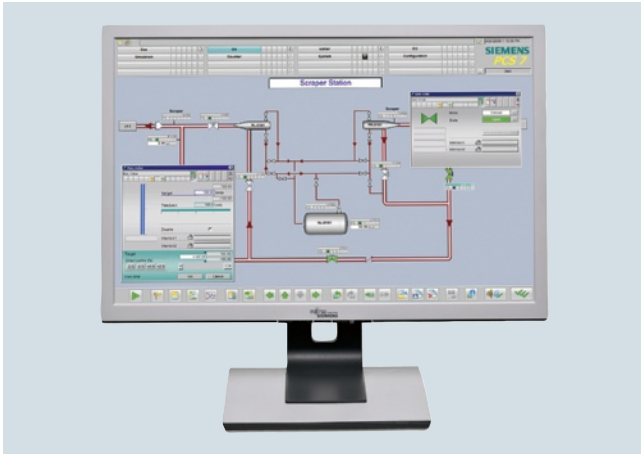

Uniform process control for central and remote units

The PCS 7 TeleControl OS software packages offered for OS runtime mode are tailored to the architecture of the SIMATIC PCS 7 operator system. They support single-user systems (single stations) as well as multi-user systems with up to 12 servers/redundant pairs of servers and up to 32 clients.

#### Design

PCS 7 TeleControl OS servers and PCS 7 TeleControl OS single stations can integrate both local SIMATIC PCS 7 automation systems and widely distributed outstations (RTUs) of a telecontrol system into the process control.

Depending on the configuration of a PCS 7 TeleControl operator system as single station or client/server combination (single or redundant), the following software components are required:

Software required	SIMATIC PCS 7 architecture		
	OS single station	Client server	
		Client	Server not redundant    Server redundant
PCS 7 OS Software Single Station V8.0 (incl. SP) see section "OS software" in the Chapter "Operator system"	•	–	–
PCS 7 OS Software Server V8.0 (incl. SP) see section "OS software" in the Chapter "Operator system"	–	–	•
PCS 7 OS Software Server Redundancy V8.0 (incl. SP) see section "OS software" in the Chapter "Operator system"	–	–	•
PCS 7 OS Software Client V8.0 (incl. SP) see section "OS software" in the Chapter "Operator system"	–	•	–
PCS 7 TeleControl OS Runtime V8.0 (incl. SP)	•	–	• (2 licenses)
PCS 7 TeleControl Driver (alternative)	SINAUT	•	• (2 licenses)
	DNP3	•	• (2 licenses)
	IEC 60870-5-101/-104	•	• (2 licenses)
	Modbus RTU	•	• (2 licenses)
	S7 EDC	•	• (2 licenses)
		–	•

Ordering data for SIMATIC PCS 7 OS Runtime licenses for expanding the OS Runtime POs (single station/server) and additional SIMATIC PCS 7 OS software components for PCS 7 TeleControl Operator Systems can be found in Catalog ST PCS 7, Chapter "Operator system", section "OS software".

SIMATIC PCS 7 Industrial Workstations suitable as basic hardware for configuration of an operator station as PCS 7 TeleControl OS single station, PCS 7 TeleControl OS server or PCS 7 TeleControl OS client can be found in Catalog ST PCS 7, section "Industrial Workstation/PC".

#### **PCS 7 TeleControl OS software for single station, server and redundant server**

The software product PCS 7 TeleControl OS Runtime contains the PCS 7 TeleControl OS software including the object library with the PCS 7 TeleControl OS faceplates and symbols as well as the Runtime license for operation on an OS single station or OS server.

An additional PCS 7 TeleControl Driver license is required for each telecontrol protocol used (SINAUT, DNP3, IEC 60870-5-101/-104, Modbus RTU, S7 EDC) per PCS 7

TeleControl OS single station and per PCS 7 TeleControl OS server.

The SIMATIC PCS 7 OS Software must be ordered separately. You can find the SIMATIC PCS 7 OS software for OS single station and OS server in section "Operator system", "OS software", and the SIMATIC PCS 7 OS software for a redundant pair of OS servers (including RS 232 cable, 10 m) in Catalog ST PCS 7, section "Operator system", "OS redundancy".

#### **Upgrade**

Existing SIMATIC PCS 7 TeleControl OS Runtime Software V7.1 can be upgraded from V7.1 to V8.0 (incl. service pack) using the SIMATIC PCS 7 TeleControl Upgrade Package. This is also suitable for upgrading the SIMATIC PCS 7 TeleControl OS Engineering Software V7.1. The SIMATIC PCS 7 ES and OS Software V7.1 combined in certain software products must be upgraded separately to V8.0 (incl. service pack) using the upgrade packages in Catalog ST PCS 7, sections "Upgrades for engineering system" and "Upgrades for operator system".

# Industrial Remote Communication

## TeleControl Professional for the control center

### PCS 7 TeleControl Operator System

Ordering data	Article No.	Article No.
<i>Runtime software</i>		
<p><b>PCS 7 TeleControl OS Runtime V8.0</b> To expand a SIMATIC PCS 7 OS (server/single station) for PCS 7 TeleControl</p> <p>Software package without SIMATIC PCS 7 OS software</p> <p>Runtime software, 2 languages (English, German), software class A, runs on Windows XP Professional 32-bit, Windows 7 Ultimate 32/64-bit, Windows Server 2003 R2 Standard 32-bit or Windows Server 2008 R2 Standard 64-bit; single license for 1 installation</p> <p>Electronic documentation on DVD, 2 languages (English, German)</p> <p>Delivery form package (without SIMATIC PCS 7 Software Media Package):</p> <ul style="list-style-type: none"> <li>• License key USB stick, certificate of license</li> <li>• DVD "PCS 7 TeleControl"</li> </ul>	6ES7658-7KX08-0YA0	
<i>Telecontrol protocol driver (continued)</i>		
		<p><b>PCS 7 TeleControl Modbus RTU Driver</b> Runtime software, license for OS single station or OS server, single license for 1 installation</p> <p>Requirement: Software PCS 7 TeleControl OS Runtime V8.0</p> <p>Delivery form package (without SIMATIC PCS 7 Software Media Package) License key USB stick, certificate of license</p>
		<p><b>PCS 7 TeleControl S7 EDC Driver</b> Runtime software, license for OS single station or OS server, single license for 1 installation</p> <p>Requirement: Software PCS 7 TeleControl OS Runtime V8.0</p> <p>Delivery form package (without SIMATIC PCS 7 Software Media Package) License key USB stick, certificate of license</p>
<i>Telecontrol protocol driver</i>		
<p><b>PCS 7 TeleControl SINAUT Driver</b> Runtime software, license for OS single station or OS server, single license for 1 installation</p> <p>Requirement: Software PCS 7 TeleControl OS Runtime V8.0</p> <p>Delivery form package (without SIMATIC PCS 7 Software Media Package) License key USB stick, certificate of license</p>	6DL5101-8AX00-0XB0	
<p><b>PCS 7 TeleControl DNP3 driver</b> Runtime software, license for OS single station or OS server, single license for 1 installation</p> <p>Requirement: Software PCS 7 TeleControl OS Runtime V8.0</p> <p>Delivery form package (without SIMATIC PCS 7 Software Media Package) License key USB stick, certificate of license</p>	6DL5101-8EX00-0XB0	
<p><b>PCS 7 TeleControl IEC 60870-5-101/-104 Driver</b> Runtime software, license for OS single station or OS server, single license for 1 installation</p> <p>Requirement: Software PCS 7 TeleControl OS Runtime V8.0</p> <p>Delivery form package (without SIMATIC PCS 7 Software Media Package) License key USB stick, certificate of license</p>	6DL5101-8CX00-0XB0	
		<p><i>Upgrade Package</i></p> <p><b>SIMATIC PCS 7 TeleControl Upgrade Package V7.1 to V8.0</b> Software package without SIMATIC PCS 7 ES/OS software</p> <p>2 languages (English, German), software class A, runs with Windows XP Professional 32-bit, Windows 7 Ultimate 32/64-bit, Windows Server 2003 R2 Standard 32-bit or Windows Server 2008 R2 Standard 64-bit; single license for 1 installation</p> <p>Note: SIMATIC PCS 7 ES and OS Software V7.1 included in certain software packages must be upgraded to V8.0 (incl. service pack) using separate upgrade packages.</p> <p>Delivery form package (without SIMATIC PCS 7 Software Media Package):</p> <ul style="list-style-type: none"> <li>• License key USB stick, certificate of license</li> <li>• DVD "PCS 7 TeleControl" and product information</li> </ul>
		6ES7652-5GX08-0YE0

## Industrial Remote Communication

### TeleControl Professional for the control center

#### SINAUT ST7sc SCADA Connect Software

##### Overview

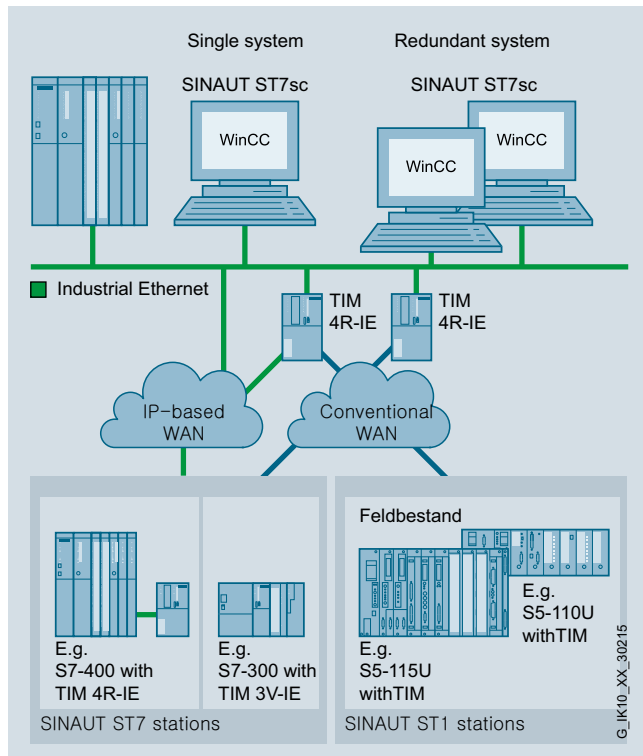

SINAUT ST7sc control center system (non-redundant or redundant) with connected ST7 and ST1 terminals

- The SCADA Connect Software SINAUT ST7sc permits the connection of telecontrol substations with ST7 and ST1 protocol to control center systems that can operate as OPC clients, e.g. iFIX from Intellution, InTouch from Wonderware, Micro SCADA from ABB.
- SINAUT ST7sc is also suitable for data exchange with other applications via OPC, e.g. with the Office application Excel.
- The OPC data can be exchanged either synchronously or asynchronously (change-controlled)
- The "Item Buffering" function prevents the loss of data on failure of the OPC client or if SINAUT terminals supply data at a faster rate than can be transferred via the OPC interface.
- System availability can be increased by connecting two ST7sc systems working in parallel to a redundant client system.
- SINAUT ST7sc additionally assumes the function of a telecontrol center. There is therefore no need for a separate SIMATIC S7-CPU for this function.

##### Benefits



- Connection of SINAUT stations to HMI, SCADA and Office applications via OPC
- The "Item Buffering" procedure ensures seamless archiving
- Time and cost savings through simple configuration without requiring detailed knowledge of SINAUT

##### Application



The TeleControl system allows substations to be networked with a control center via WAN (**W**ide **A**rea **N**etwork) or Industrial Ethernet. This control center can also be a SIMATIC terminal or a PC-based control center, for example, WinCC with the SINAUT ST7cc add-on.

SINAUT ST7sc offers suppliers of other control center systems the option of connecting to substations with SINAUT ST7 without having to integrate a SINAUT interface. Communication is over OPC: As an OPC server, SINAUT ST7sc forms the interface between the telecontrol system and the third-party control system connected as an OPC client.

The OPC interface is also suitable for data exchange with other applications, for example, the Microsoft Office application Excel.

##### Design

SINAUT ST7s is installed on a Windows PC. The OPC server function supports connection of one or more client applications. These clients are either connected over a suitable communication medium, e.g. Industrial Ethernet, with the server or they are installed on the same PC as SINAUT ST7sc.

Connection of one or more telecontrol substations to the ST7sc PC is carried out either via the MPI bus or Industrial Ethernet, depending on the TIM communication module used.

##### Provision of current time of day:

- For TIMs, that are connected over MPI to the ST7sc PC, time synchronization is only possible through a DCF77 receiver equipped with a TIM. This provides central time synchronization for the ST7sc PC and all other stations.
- For TIMs that are connected over Industrial Ethernet to the ST7sc PC, time synchronization is performed over ST7sc.

Outside the reception area of the DCF77 real-time transmitter the use of a GPS receiver is recommended. This determines the local time from the satellite-based global positioning system (GPS).



### Function

In the case of a change, the telecontrol substation detects the process data and transfers it over the relevant WAN to SINAUT ST7sc. The received SINAUT messages are decoded here and stored in the ST7sc variable list as configured. An OPC client can read these received data from the ST7sc variable list via the OPC server interface "Data Access". This is performed either synchronously or asynchronously.

In the reverse direction, the OPC client can write data that is to be sent to a station (e.g. commands, set points, parameters) to the ST7sc variable list via the OPC server interface. These are converted to SINAUT data frames and sent via the WAN to the telecontrol substation specified by means of configuration.

A special feature of the telecontrol system is that process data are protected against loss. If the connection from the substation to the control room fails, for example, the local substation will save all the data changes that occur during the downtime complete with time stamps. This ensures that connection downtimes of several hours or even several days can be bridged without loss of data. So that the data saved in the substations will also arrive at the OPC client safely later, ST7sc contains the "item buffering" procedure, which helps to avoid data loss on the way to the OPC client:

- When the OPC "data access" interface that represents a process image is updated by the substations faster than the client can read it;
- When the OPC client is not available for a shorter or longer time or when the OPC communication path fails.

ST7sc normally only creates one "memory cell" per item in which the last status or value of the item is retained, but when the item buffering procedure is selected, one buffer is created per item in which all changes to the affected item are saved consecutively complete with time stamps. Saving is performed until the individual changes can be transferred to the OPC client.

The item buffering procedure requires an HMI application that can process time-stamped data even when the time stamp is several days old, e.g. following a long connection failure.

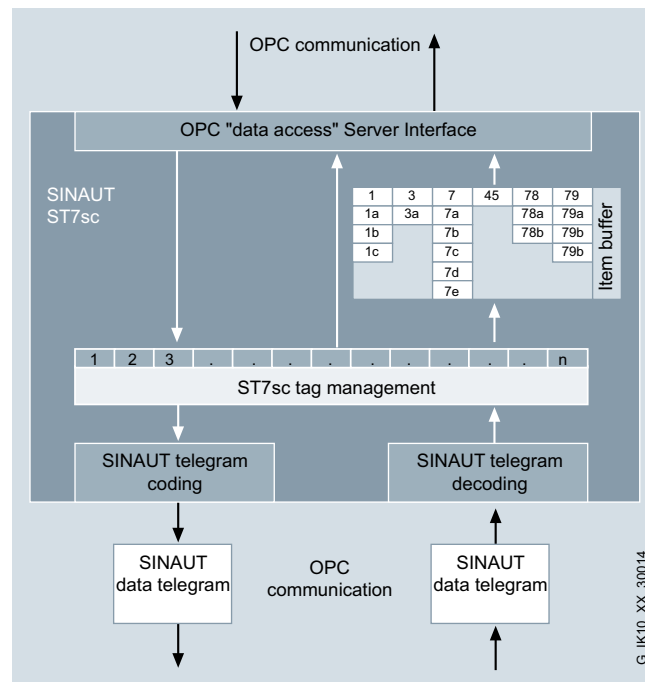

System configuration with SINAUT ST7sc

### Redundant application

SINAUT ST7sc supports connection to a redundant client system. Two ST7sc systems must be used in this case. The data received from the stations are transferred by them in parallel and mutually independently to both clients and data are received from the clients that must be sent to the substations.

The redundancy mechanisms are located in this case on the client side:

- The client ensures that the data transferred in parallel is evaluated and compared correctly;
- The client transfers data to be sent to the substation once only to one of the two ST7sc, so that transmission is not duplicated.

### Configuration

The ST7sc is configured using the ST7sc Config tool that is included in the scope of supply of the ST7sc software CD.

The documentation for the ST7sc and the Config tool is also located on this CD.

# Industrial Remote Communication

## TeleControl Professional for the control center

### SINAUT ST7sc SCADA Connect Software

#### Technical specifications

SINAUT ST7sc V2.1		SINAUT ST7sc V2.1	
Operating systems	Windows XP SP3; Windows Server SP3; Windows 7 SP1 (32-bit/64-bit); Windows Server 2008 SP2 (32-bit) Windows Server 2008 R2 SP1 (64-bit)	Configuration	ST7sc Config-Tool V2.1 SINAUT Engineering Software
VMware	ESXi V5.1	Quantity framework	Small license Medium license Large license
		<ul style="list-style-type: none"> <li>• 6 SINAUT terminals</li> <li>• 12 SINAUT terminals</li> <li>• for more than 12 SINAUT terminals</li> </ul>	

#### Ordering data

##### SINAUT ST7sc

Software for connecting SINAUT stations to HMI, SCADA and Office applications via OPC; single license for 1 installation of the runtime software; configuration software and electronic manual on CD-ROM; operating systems: Windows XP SP3, Windows Server 2003 SP2, Windows 7 SP1 (32-bit/64-bit), Windows Server 2008 SP2 (32-bit), Windows Server 2008 R2 SP1 (64-bit); license key on USB flash drive; German/English;

##### Standard licenses S (Small), M (Medium), L (Large)

Article No.	Article No.
<b>SINAUT ST7sc V2.1 S</b> Small license for max. 6 SINAUT stations	<b>6NH7997-5CA21-0AA1</b>
<b>SINAUT ST7sc V2.1 M</b> Medium license for max. 12 SINAUT stations	<b>6NH7997-5CA21-0AA2</b>
<b>SINAUT ST7sc V2.1 L</b> Large license for more than 12 SINAUT stations	<b>6NH7997-5CA21-0AA3</b>

##### PowerPacks for upgrading the license to M or L

<b>SINAUT ST7sc V2.1 SM PowerPack;</b> License upgrade from ST7sc S to ST7sc M (from 6 to 12 stations)	<b>6NH7997-5AA21-0AD2</b>
<b>SINAUT ST7sc V2.1 SL PowerPack;</b> License upgrade from ST7sc S to ST7sc L (from 6 to more than 12 stations)	<b>6NH7997-5AA21-0AD3</b>
<b>SINAUT ST7sc V2.1 ML PowerPack;</b> License upgrade from ST7sc M to ST7sc L (from 12 to more than 12 stations)	<b>6NH7997-5AA21-0AE3</b>

##### Upgrade packages

<b>ST7sc V2.1 U upgrade from V2.0 to V2.1</b> Upgrade of all licenses V2.0	<b>6NH7997-5CA21-0GA1</b>
<b>ST7sc V2.1 S upgrade from V1.0 ... V1.2 to V2.1</b> for S license holders	<b>6NH7997-5CA21-2GA1</b>
<b>ST7sc V2.1 M upgrade from V1.0 ... V1.2 to V2.1</b> for M or SM license holders	<b>6NH7997-5CA21-2GA2</b>
<b>ST7sc V2.1 L upgrade from V1.0 ... V1.2 to V2.1</b> for L, SL or ML license holders	<b>6NH7997-5CA21-2GA3</b>

##### Accessories

<b>TIM 3V-IE communications module</b> With an RS 232 interface for SINAUT communication via a conventional WAN or an IP-based network (WAN or LAN)	<b>6NH7800-3BA00</b>
<b>TIM 3V-IE Advanced communications module</b> With an RS 232 interface and an RJ45 interface for SINAUT communication via a conventional WAN and an IP-based network (WAN or LAN)	<b>6NH7800-3CA00</b>
<b>TIM 4R-IE communications module</b> With two combined RS 232/RS 485 interfaces for SINAUT communication via conventional WANs and two RJ45 interfaces for SINAUT communication via IP-based networks (WAN or LAN)	<b>6NH7800-4BA00</b>

### Overview

#### Design principle of a telecontrol system and plants with SIMATIC

Telecontrol involves the connection of distant process stations to one or more central control systems. A telecontrol system can be subdivided into the following components

- Control center
- Substations
- Communication network

Various different public or private networks can be used for communication for the purposes of monitoring and control. The event-driven or cyclic exchange of the process data takes place via special telecontrol protocols such as SINAUT ST7, DNP3.

#### Substations







With SIMATIC, Siemens offers a wide range of components for the different application areas for establishing telecontrol substations – Remote Terminal Units (RTUs).

The hardware basis is a PLC, in each case supplemented for the telecontrol function with special hardware and software components, e.g. TIM communication modules. All the local functions supported by the respective PLC for the connection of I/O via bus systems, connection of HMI or sensors, etc., are also available without restriction in the RTU configuration.

The individual solutions differ in the

- Performance class (number of required IO signals and controller performance)
- Support for the telecontrol protocols

The following table provides an overview of the different types of substations on offer with the essential features.

		Telecontrol protocols						Private networks			Public networks			
		TeleControl Basic	SINAUT ST7	DNP3	IEC 60870-5-104	IEC 60870-5-101	SINAUT ST1	Wireless	Dedicated line	WLAN	GPRS	EGPRS	UMTS	DSL
	ET 200S	-	-	-	•	•	-	•	•	•	•	•	•	•
	S7-1200	•	-	•	•	-	-	• <sup>2)</sup>	-	• <sup>2)</sup>	•	• <sup>1)</sup>	• <sup>1)</sup>	• <sup>1)</sup>
	S7-200	•	-	-	-	-	-	-	-	-	•	-	-	-
	S7-300	•	•	•	•	•	•	•	•	•	•	•	•	•
	S7-400	-	•	•	•	•	•	•	•	•	•	•	•	•
	S7-400FH	-	-	•	•	-	-	•	•	•	•	•	•	•
	WinAC RTX	-	-	-	•	-	-	•	•	•	•	•	•	•

• suitable      - not suitable      1) via external IP-Router      2) via Industrial Ethernet

G\_IK10\_XX\_30293

Classification of the different TeleControl substations (RTU types)

## Industrial Remote Communication

### TeleControl Professional for the stations

#### Introduction

#### Overview (continued)

##### **TIM communications modules**

The hardware component for the telecontrol wireless station of a telecontrol substation is the TIM (**T**elecontrol **I**nterface **M**odule) communication module. It is used by the S7 CPU or control center PC for data exchange via the relevant telecontrol network, optionally with the SINAUT ST7, SINAUT ST1 or DNP3 protocol.

Different protocols cannot be combined in one communication network. However, communication networks with different protocols can always be combined in one project if they are connected to the central control center via separate interfaces.

#### Function

Each WAN interface of a TIM can be operated with the function "Station", "Node terminal" or "Control center" (exception: the function "Node terminal" is not available on the TIM 3V-IE, TIM 3V-IE DNP3, TIM 4R-IE DNP3, and the function "Control center" is not available on the TIM 3V-IE DNP3 and TIM 4R-IE DNP3). This enables the construction of the type of hierarchical communication structures required in classic WANs.

On IP-based networks, in which each partner has equal priority, this classification can be dismissed. The transmission via GPRS, however, represents an exception, as without special GPRS provider contracts, direct communication from GPRS station to GPRS station is not possible. This can be solved by "rerouting" through a control center TIM, as in a classic WAN with cross-traffic on a dedicated leased line or wireless. In this case, the interfaces of the participating TIMs are to be set to the function "Control center" or "Station" in an IP-based network as well so that the correct path from "Station" to "Station" will be found automatically through the "Control center".

The TIM independently processes the data traffic via the network connected in each case and it does this according to the store-and-forward principle. For this purpose, the module has its own processor and a RAM for buffering data messages (depending on the type of TIM, between 10 000 and 56 000 message frames). The saving of the messages prevents a loss of data if the communication link is faulty or the partner fails. It also helps to reduce connection charges in dialup networks. If the optional backup battery is used for the TIM 4R-IE or TIM 4R-IE DNP3, stored data frames are not lost even if the 24 V supply voltage fails.

Reading and writing data that the TIM is to send or receive for a CPU can also be done with:

- **TD7onCPU**, the SINAUT TD7 software for the CPU, applicable to S7-300- and S7-400-CPU as well as C7 compact control systems:  
The SINAUT program in the CPU, configured with modules from the SINAUT TD7 library, acquires the process data to be transferred, checks it for changes and transfers the changes to the TIM for transmission over the WAN. Messages received without faults by the TIM via the WAN are forwarded to the local CPU. A block that has been integrated there for evaluating the specific message frame ensures that the received information is output to the outputs or data areas configured in the block.  
This block library cannot be used in conjunction with TIM 3V-IE DNP3 or TIM 4R-IE DNP3.
- **TD7onTIM**, the SINAUT TD7 software integrated in the TIM (not present in the case of the TIM 4R / TIM 4RD), can be used with S7-300 CPUs and C7 compact control systems:  
The TD7onTIM program configured by the user reads the process data to be transferred directly from the memory areas of the CPU inserted into the S7-300 rack (inputs, bit memories, DBs), checks them for changes and then transfers the changes to the send buffer of the TIM for transmission over the WAN. Data from message frames received without fault by the TIM via the WAN are directly written by the TIM into the configured memory areas of the CPU.

If required, the data acquired by "TD7onCPU" or "TD7onTIM" can be tagged with a time stamp and the "normal" or "high" priority identification for transmission over a chargeable network, e.g. dial-up or GPRS. "TD7onTIM" also allows extremely important data to be identified with the "Interrupt" priority. These have priority over all other message frames saved in the send buffer, i.e. they are transmitted before the others.

If the local SINAUT station is a control center PC, operator inputs are recorded by the PC program in accordance with the data message frame configuration, and transferred with the configured destination address to the TIM. Messages received without faults by the TIM via the WAN are forwarded to the control center PC. Evaluation of the relevant frame is handled by the control system software.

The TIM first saves the data to be sent in its RAM buffer. The subsequent response of the TIM on sending this data is explained in the two following sections.

### Function (continued)

#### Communication via a classic WAN

The response of the TIM on sending the data depends on the WAN type and the TIM function that is set on the WAN interface:

- Dedicated line, wireless network;  
if the interface is operated in the function "station" or "node terminal", the TIM waits to be polled by the control center before it transfers the stored data message frames. If there are no message frames available, polling is simply acknowledged.  
If operated as a "control center", the TIM sends one of the message frames saved in the buffer following each completed poll + response (standard setting). If a larger number of message frames is to be sent between two polls, this can be specified when the TIM is configured.
- Dial-up network;  
in "station" or "node terminal" mode, the TIM will initially not be active in the case of data with "normal" priority. In the case of data of "high" or "interrupt" priority, the TIM will immediately try to establish a link to the addressed partner in order to transfer the data. If data of "normal" priority are also available in the TIM buffer at this time, these will also be transferred. Data of "interrupt" priority will always be transferred first. The data of "high" and "normal" priority will subsequently be transferred in accordance with the FIFO principle, i.e. regardless of their respective priority.  
If the interface is set to the "control center" function, the TIM will always try regardless of priority to establish a link to the addressed partner and to transfer the data.

The SINAUT ST7/ST1 protocol can be used for all WAN types and TIM functions. The DNP3 protocol only allows use of dedicated lines and wireless networks in the function "Station". The operating mode used depends on the type of WAN:

- Data exchange via dedicated line and wireless network usually takes place in "Polling" mode. In wireless networks with SINAUT ST7 protocol, the operating mode "Polling with time slot method" can be selected if required.
- On dial-up networks (only with SINAUT ST7/ST1 protocol), data exchange always takes place in "Spontaneous" mode.

#### Communication via an IP-based network

For transmission via an IP-based network, a permanent S7 connection via which the partners exchange the data packages is established in each case between two TIMs or between one TIM and the control system.

#### PG communication

PG communication allows all S7 stations connected to the LAN, e.g. Industrial Ethernet, to be remotely programmed. With the aid of S7 routing it is possible to use programming device communication across networks.

Cross-network PG communication functions with the SINAUT ST7 protocol for all classic and IP-based WANs. Remote programming and remote diagnosis of the stations connected to the WAN (CPUs and TIMs) is therefore possible.

In IP-based DNP3 networks, PG communication does not take place via the protocol itself, but via a separate PG connection (TCP/IP connection).

#### Diagnostics & service

The "SINAUT Diagnostics & Service Tool" provides comprehensive diagnostic functions and tools for commissioning and troubleshooting, e.g.:

- Operating status of the TIM
- Module status of the TIM
- General diagnostic information
- Diagnostics buffer of the TIM
- Status of the connections to local and remote communication partners (CPUs, TIMs, control systems)
- TIM frame monitor for recording the frame traffic
- Disabling and enabling stations in the dedicated line or wireless network, e.g. during commissioning

TIM modules with Ethernet interface also offer the following:

- Status and fill level of the send buffer, for each communication partner separately
- Diagnostic information regarding TD7onTIM

#### Configuration

The "SINAUT ES" configuration software is used for configuring the TIM. Modules from the "SINAUT TD7 module library" must be used for configuring the SINAUT program in the CPU (TD7onCPU). Both software packages are part of the SINAUT ES engineering software. The SINAUT ST7 configuration software requires that STEP 7 V5.5 with SP2, or higher, is installed.

The configuration data – like the interface functionality, protocol, addresses of the communication participants, the telephone numbers of the partner in the dial-up network, etc. – that are required in each case can be saved in the Flash EPROM on every TIM or, in the case of the TIM 4R-IE or TIM 4R-IE DNP3, also on the optional plug-in C-PLUG. On all TIMs with Ethernet interface, the configuration data can also be stored on the memory card (MMC) of the CPU when installing in an S7-300 rack or in a C7 control system. The TIM can be replaced without the need for a programming device if the configuration data is saved in the CPU or in the C-PLUG.

#### Approvals

All TIM communication modules have the approvals CE, FM, ATEX, cUL508 (= UL508, CSA22.2) and cUL HazLoc. The TIM 3V-IE and TIM 4R-IE modules are also available in a SIPLUS version for the extended temperature range (-25 ... +70 °C).

## Industrial Remote Communication

### TeleControl Professional Stations for ST7 protocol

#### Introduction

#### Overview

##### Substations for ST7 protocol

The TIM communication module is housed in an S7-300 enclosure and is available in different versions:

##### TIM 3V-IE/TIM 3V-IE Advanced



The TIM 3V-IE is a SINAUT communications module for the SIMATIC S7-300. It has an RS232 interface to which a matching external modem can be connected for data transfer via a conventional WAN. It additionally possesses an RJ45 interface, which permits communication over IP-based networks. In the case of the TIM 3V-IE, SINAUT communication can be processed alternately via one of the two interfaces, while in the TIM 3V-IE Advanced both interfaces can be operated simultaneously.

##### TIM 4R-IE



The TIM 4R-IE has two RS232/RS485 interfaces for data transmission via conventional WANs and additionally two RJ45 interfaces for connection to IP-based networks (WAN or LAN).

This TIM can be used as communication processor in a SIMATIC S7-300, but it is especially suitable as telecontrol module for a SIMATIC S7-400 or control center PC (SINAUT ST7cc or ST7sc). It is then connected without S7-300 CPU as a stand-alone device via one of the two Ethernet interfaces to the S7-400 or the PC.

The four transmission paths can all be different and operated independently of one another, but also in any redundant combination.

#### Design

##### Configuration examples

The figure below shows a simple S7-300 station equipped with a TIM 3V-IE. The S7-300 can be connected via the RS232 interface of the TIM to a conventional WAN (e.g. dedicated line or dialup network), and via the RJ45 interface to an IP-based network, e.g. GPRS. If the S7-300 were equipped with a TIM 3V-IE Advanced, the two interfaces could be used simultaneously for SINAUT communication.

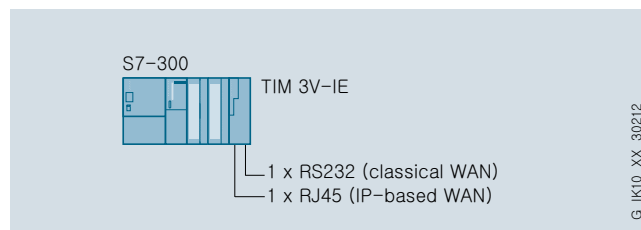

S7-300 with TIM 3V-IE

In the case of an S7-400, both a TIM 4R and a TIM 4R-IE can be used for data communication. In both cases the TIM is used as an independent device, i.e. without S7-300 CPU. The TIM 4R is connected to the S7-400 via MPI, while the TIM 4R-IE is connected via one of the two Ethernet interfaces of this module. The figures below illustrate the two alternatives.

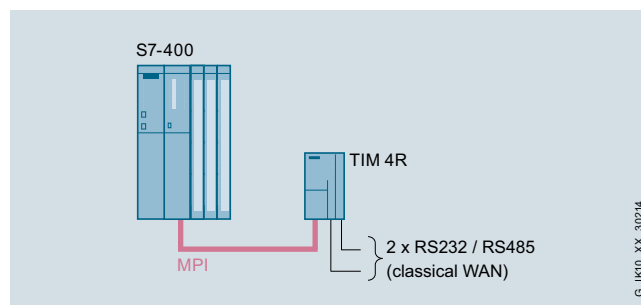

S7-400 with TIM 4R connected via MPI

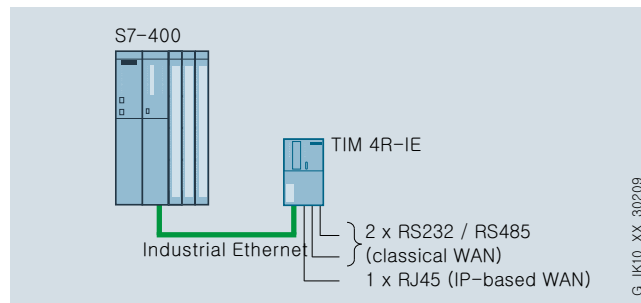

S7-400 with TIM 4R-IE connected via Industrial Ethernet

#### Design (continued)

In the case of the TIM 4R, two conventional WANs can be connected by means of the two combined RS232/RS485 interfaces. The TIM 4R-IE has an additional connection for an IP-based network.

As on an S7-400, the control center PC (e.g. SINAUT ST7cc or ST7sc) is interfaced with the SINAUT telecontrol network via one or more TIM 4 modules. The two figures below show the alternatives with TIM 4R or TIM 4R-IE.

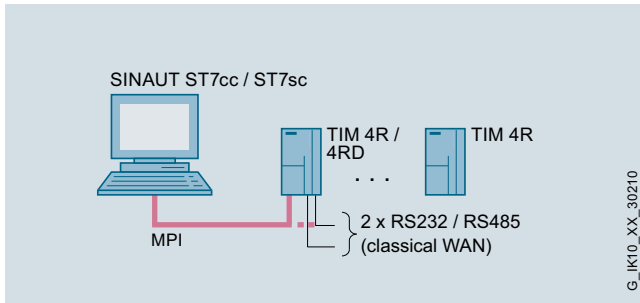

SINAUT ST7cc/ST7sc with one or more TIM 4R's on the MPI bus

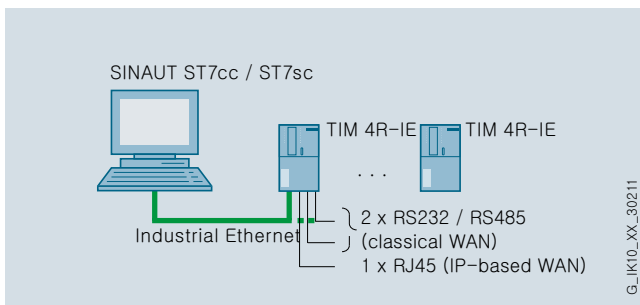

SINAUT ST7cc/ST7sc with one or more TIM 4R-IE's on the Industrial Ethernet

The synchronization of the TIM 4R-IE module clocks connected via Ethernet is performed by the control center PC (ST7cc or ST7sc). These TIMs then supply their SINAUT stations in turn.

If stations are connected by means of an IP-based network, the connection to the control center PC (ST7cc or ST7sc) may also be made directly, i.e. without any TIM 4R-IE on the PC. The SINAUT stations in this directly connected IP-based network are synchronized via the control center PC.

In the case of more complex IP-based networks, and above all when using a redundant control center, the use of a control center TIM 4R-IE is recommended, since this permits improved monitoring of network behavior and optimization of the connection resources of the PC.

## Industrial Remote Communication

### TeleControl Professional Stations for ST7 protocol

#### TIM 3V-IE for WAN and Ethernet

#### Overview



- SINAUT communications module TIM for SIMATIC S7-300 for use in a wide area network (WAN)
- IP communication via secure VPN (virtual private network) using the Internet
- Wireless communication via GPRS router, GPRS modem, or radio devices
- Wired communication via Ethernet, DSL, dialup modems or dedicated line modem
- Complete migration of existing wireless, dedicated line and dial-up technology to IP-based network
- Message frame memory for complete recording of data
- Simple configuration and operation without specialist IT knowledge

#### Benefits

**get** Designed for Industry

- Flexible option for connection to any IP-based or conventional WAN
- Economical station design and low connection costs due to GPRS connection with the MD720-3 and utilizing the S7-CPU 312 and 312C
- No additional mobile phone service for fixed IP addresses or contracts for private GPRS networks with bidirectional data traffic are necessary, as the VPN is integrated in the ST7 system. No more expensive and complex VPN configuration by IT specialists.
- Saving of traveling costs due to cost-effective remote programming, diagnostics, control and monitoring via the Internet
- Reduction in time and costs thanks to quick and user-friendly configuration of connections and data to be transferred with the SINAUT configuring software and block library
- Reliable storage of important data. Storage of data message frames (max. 16 000) including time stamp on TIM if the communication path is faulty or a partner has failed and to reduce connection costs for the dial-up network.
- Protection of investment for existing SINAUT ST1 systems through the integration of the SIMATIC S7-300

#### Application

- Low-cost automation of water/wastewater networks with both complex and simple structures
- Control and monitoring of energy distribution systems and supply stations, such as oil, gas or district heating networks
- Preventive maintenance (condition monitoring) of globally distributed systems
- Monitoring of logistics and traffic control systems
- Connection of plants with basic or high-level security and availability requirements
- Use in hybrid networks with dialup, wireless, Ethernet or Internet communication

#### Design

The TIM 3V-IE offers all the advantages of the SIMATIC S7-300 design:

- Compact design
- 9-pin Sub-D connector with an RS232 interface for connection to a conventional WAN via an appropriate modem
- RJ45 socket for connection to Industrial Ethernet or an IP-based network; industry-standard design with additional sleeve for connecting the IE FC RJ45 Plug 180
- 2-pin plug-in terminal strip for connection of the 24 V DC external supply voltage
- Front LEDs for indicating the module status and the communication
- Simple installation; the TIM 3V-IE is mounted on the rail of the S7-300 and connected to the adjacent modules by means of the bus connectors supplied with the TIM. No slot rules apply.
- Can be operated in the expansion rack (ER) in conjunction with the IM 360/361
- Can be operated without a fan
- A battery backup or memory module are not required



#### Function

- The TIM 3V-IE enables a SIMATIC S7-300 to exchange data with other SINAUT ST7 or ST1 stations via any SINAUT network. The important SINAUT property - saving data complete with a time stamp on the TIM in the event of an interrupted link or failure of the partner - is then available not only for conventional WANs, but also for IP-based networks. Important events, alarms, etc. are not lost and the integrity of information in control center system archives is assured.
- The TIM 3V-IE module is particularly suitable for configuring low-cost stations, but also allows a simple S7-300 control center to be implemented. The module cannot be used in a SINAUT node station or combined with other TIMs in a control center.
- The SINAUT TD7 software for the CPU (TD7onCPU) is now integrated in the TIM 3V-IE (TD7onTIM). This enables the smallest S7 CPUs 312 and 312C to be used, because in the most favorable situation, no CPU RAM is required any more for SINAUT. (This does not apply to communication with SINAUT ST1 partners or the transmission of text messages; in these cases, the SINAUT TD7 software must be used for the CPU (TD7onCPU).) One TIM 3V-IE can be used per S7-300 and one of the two interfaces (RS232 or RJ45) can be used for SINAUT communication (not both simultaneously). PG communication is possible at any time over the Ethernet interface.
- Message frame memory for up to 16 000 data message frames
- Up to eight S7 connections via IP-based networks

Controllable communication modules:

- Control of the GSM/GPRS modems MD720-3 in GSM or GPRS mode. In GPRS mode, simple 128-bit encryption via the MD720-3 (MSC-VPN tunnel protocol).
- Operation via SIMATIC NET Ethernet components with high IPsec security standard (e.g. GPRS router or SCALANCE S)
- Use of SCALANCE fiber-optic switches for spanning long distances
- Wireless transmission via IWLAN with SCALANCE W over medium distances
- Dedicated line modem MD2 for point-to-point, point-to-multi-point or line connections
- Wireless devices from various manufacturers, also for private mobile radio using the time slot method
- Analog dial-up modem MD3 for the analog telephone network or point-to-point dedicated lines

#### Integration

##### Connection to IP-based networks

In addition to the RS232 interface, the TIM 3V-IE also has an RJ45 socket. This is suitable for the connection of IP-based networks (WAN or LAN). Depending on the application, various types of data communication equipment can be connected such as:

- SCALANCE X switches for Twisted Pair cable or fiber-optic cables
- SCALANCE W (IWLAN) and Ethernet radio devices from various manufacturers
- SCALANCE M communication via mobile wireless networks
- GPRS/GSM modem MD720-3 for GPRS communication over mobile wireless networks
- Broadband systems such as OTN and PCM30

##### Configuration examples in IP-based networks

###### Connection via switches, e.g. SCALANCE X

Simple network structures can be built up in this manner, or complex ones that comprise a combination of star, line and ring structures. At the control desk (e.g. ST7cc) the use of a TIM 4R-IE is not necessary, i.e. the connection is made directly to the Ethernet interface of the PC.

###### Wireless with Ethernet

When wired Ethernet communication is not possible, a wireless network can be installed using commercially available Ethernet wireless modems or with IWLAN. In order to decouple the networks, the connection in the control center can be made via a TIM 4R-IE, as in the example, or directly to the Ethernet interface of the PC.

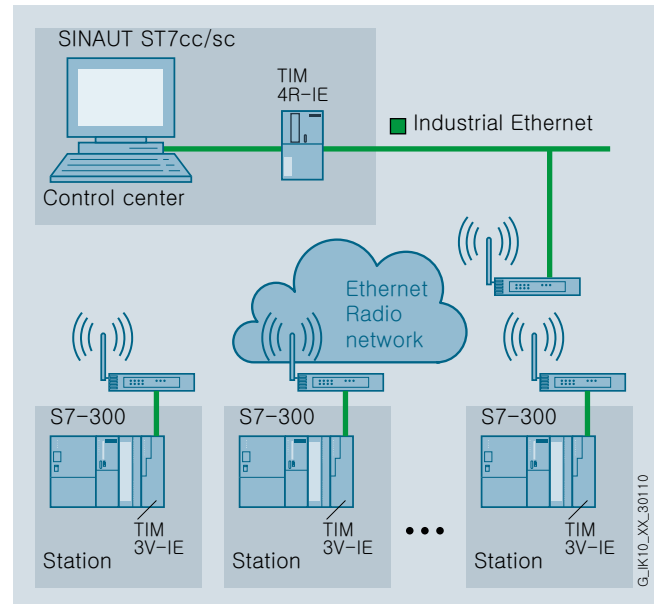

# Industrial Remote Communication

## TeleControl Professional Stations for ST7 protocol

### TIM 3V-IE for WAN and Ethernet

#### Integration (continued)

##### Transmission over DSL

The continuously falling flat rates for DSL connections make this medium an interesting alternative to a leased line or also a telephone connection. DSL routers must be used in the station and control center, preferably routers in combination with SCALANCE S (VPN), in order to establish secure connections using VPN tunnels. A permanent IP address is recommended for DSL connection of the control center, the IP addresses of the stations can be dynamically assigned.

In order to decouple the networks, the connection in the control center can be made via a TIM 4R-IE or directly to the Ethernet interface of the PC.

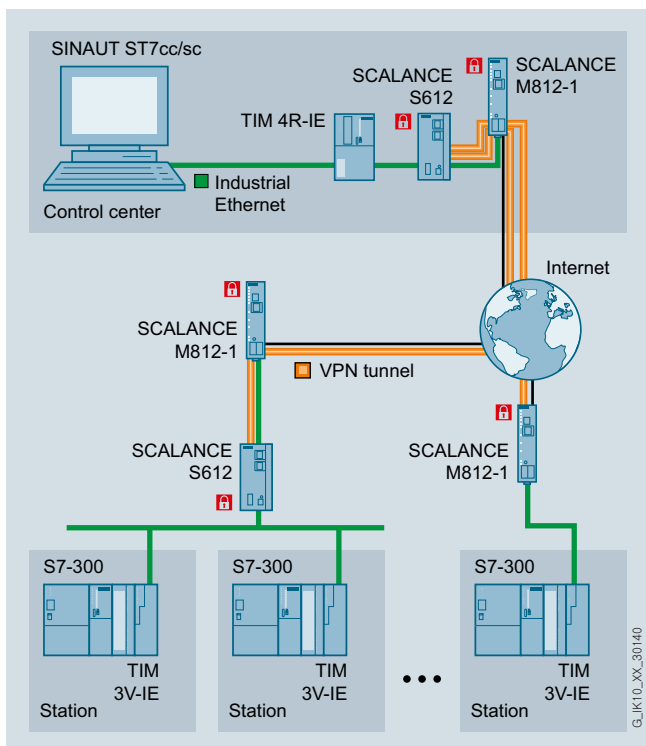

##### Transmission over the GPRS mobile wireless service and the Internet

Continuous coverage of GPRS in many countries as well as inexpensive volume tariffs allow wireless connection of stations to the control desk without the need to create a separate radio network for this purpose. The stations can be either stationary or mobile.

The wireless connection is constantly online and therefore has the same properties as a dedicated line: Data changes can be transferred immediately and station or connection failures are detected at an early stage.

##### GPRS with simple stations:

A TIM 3V-IE is used in the stations together with the GSM/GPRS modem MD720-3 or a TIM3V-IE Advanced with DSL router. The simple VPN protocol MSC of the MD720-3 permits communication via GPRS access and Internet and via routers with NAT or NAPT conversion. The MSC tunnel connections correspond to dedicated lines that are permanently maintained with extremely low volumes of data. When using the MSC tunnel, a TIM 4R-IE must be used as a header station at which the tunnels end. The parameter setting of the MSC connection is performed in the SINAUT ST7 configuration software.

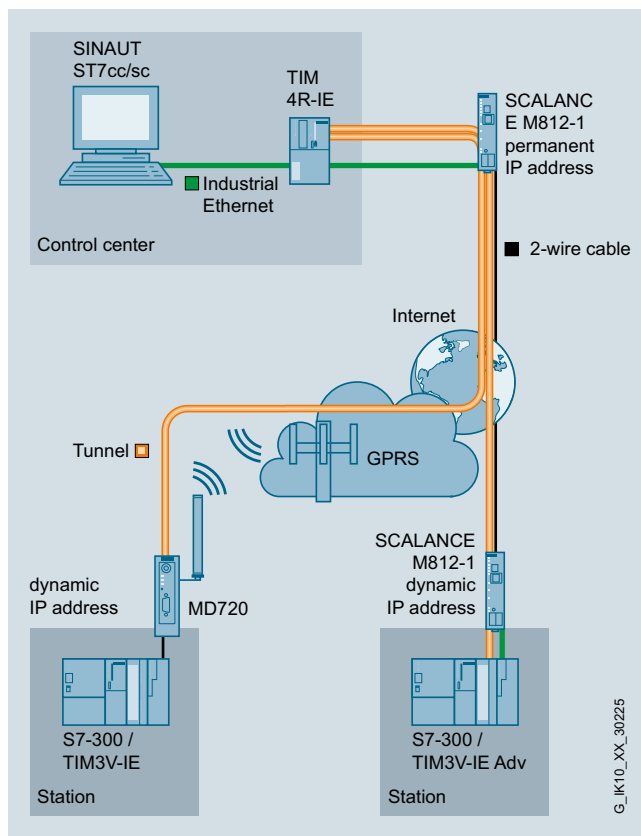

### Integration (continued)

#### GPRS/UMTS with complex stations and enhanced security:

The EGPRS router SCALANCE M874-2, which is a combination of high-speed GPRS VPN router with enhanced data security (IPsec protocol) and firewall, is used in networked stations. In the stations, other devices connected via Industrial Ethernet to the SCALANCE M874-2 for diagnosis and parameterization can be accessed from the control center.

For higher data rates, in place of the GPRS router SCALANCE M874-2, the UMTS router SCALANCE M874-3 can be implemented for use of the UMTS mobile wireless network.

The control desk PC must be constantly accessible from the GPRS network. It must therefore be directly connected to the GPRS provider using a dedicated line or permanently to the Internet, e.g. by means of DSL. A SCALANCE S612 or S623 Security Module performs the firewall function at the control center and represents the remote stations for the VPN connections of the GPRS stations. The VPN is configured with the SIMATIC NET "Security Configuration Tool" and requires no special IT knowledge.

The IP address of the control center should preferably be permanent; those of the stations can be dynamically assigned.

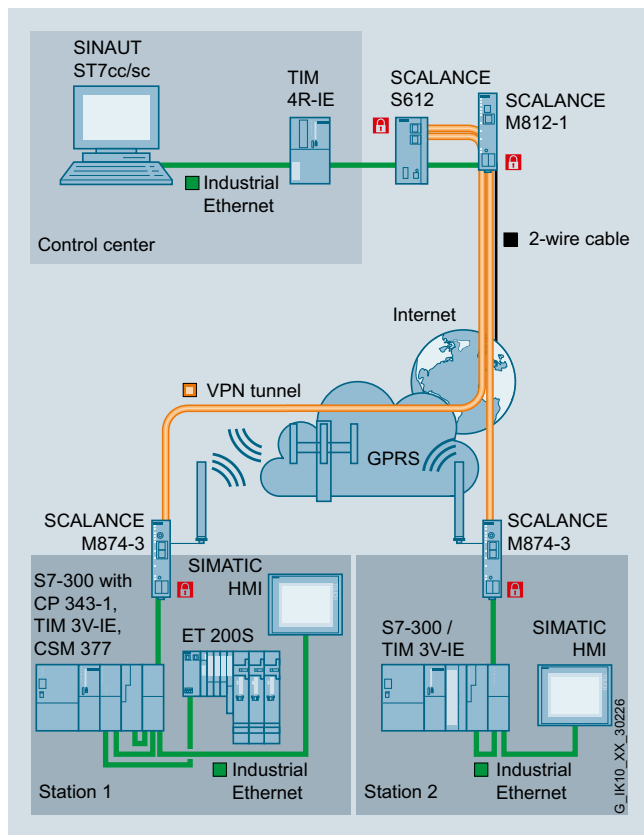

Secure data transmission with SCALANCE M industrial routers, SCALANCE S security modules and Internet

#### Connection to a conventional WAN

Connection to a conventional WAN is via the floating RS232 interface of the TIM 3V-IE module, via which various modems or data communication equipment can be connected, depending on the application, such as:

- Dedicated line modem MD2 for point-to-point, point-to-multi-point or line connections
- Wireless devices from various manufacturers, also for private mobile radio using the time slot method
- Analog dial-up modem MD3 for the analog telephone network or point-to-point dedicated lines
- GSM modem MD720-3 for access to the mobile radio network via dial-up lines

#### Configuration examples in the conventional WAN

##### Use of the TIM 3V-IE in the mobile radio network (GSM)

The GSM modem MD720-3 is used for this purpose. At the control desk (ST7cc or ST7sc), it is connected through a TIM 4 module (e.g. TIM 4R-IE) that is connected to the PC via the Industrial Ethernet. The connections between the GSM modems are set up via GSM dial-up lines.

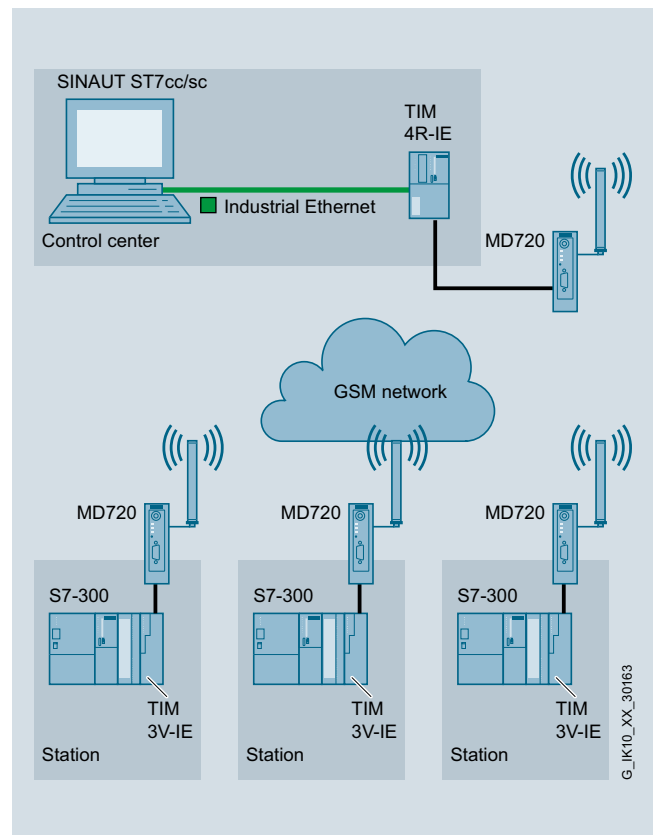

Use of the TIM 3V-IE in the mobile radio network (GSM) with MD720 MODEM

## Industrial Remote Communication

### TeleControl Professional

### Stations for ST7 protocol

#### TIM 3V-IE for WAN and Ethernet

#### Technical specifications (continued)

##### Use of the TIM 3V-IE in a private radio network

The radio network must be installed in accordance with the radio equipment that is approved in the relevant country (radio equipment is not included in the SINAUT product range). At the control desk (ST7cc or ST7sc), it is connected through a TIM 4 module (e.g. TIM 4R) that is connected to the PC via MPI. If a radio network is set up with time slot procedure, the TIM 4RD with DCF77 radio clock receiver must be used at the control desk.

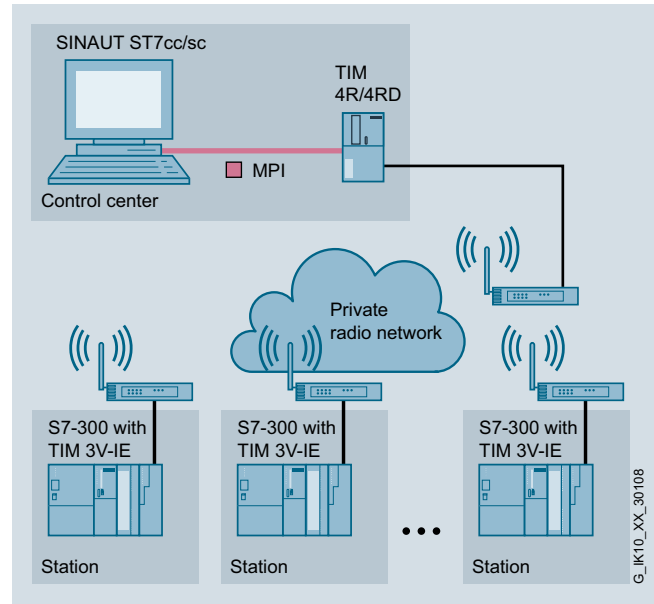

#### Technical specifications

Article No.	6NH7800-3BA00
Product-type designation	TIM 3V-IE
<b>Transmission rate</b>	
• for Industrial Ethernet	10 ... 100 Mbit/s
• in accordance with RS 232	50 ... 38 400 bit/s
<b>Interfaces</b>	
Number of interfaces according to Industrial Ethernet	1
Number of electrical connections	
• for external data transmission in accordance with RS 232	1
• for power supply	1
Design of electrical connection	
• the Industrial Ethernet Interface	RJ45 port
• at interface 1 for external data transmission	9-pin D-sub male connector (RS232)
• at interface 2 for external data transmission	-
• for power supply	2-pin, pluggable terminal strip
design of the removable storage C-PLUG	No
<b>Supply voltage, current consumption, power loss</b>	
Type of supply voltage	DC
Supply voltage	24 V
• minimum	20.4 V
• maximum	28.8 V
Consumed current	
• from backplane bus at 24 V for DC maximum	0.2 A
• from external supply voltage at 24 V with DC maximum	0.2 A
Resistive loss	5.8 W

Article No.	6NH7800-3BA00
Product-type designation	TIM 3V-IE
Product expansion optional backup battery	No
Type of battery	-
Backup current	
• typical	-
• maximum	-
<b>Permitted ambient conditions</b>	
Ambient temperature	
• during operating	0 ... 60 °C
• during storage	-40 ... +70 °C
• during transport	-40 ... +70 °C
Relative humidity at 25 °C without condensation during operating maximum	95 %
Protection class IP	IP20
<b>Design, dimensions and weight</b>	
Module format	Compact module S7-300 single width
Width	40 mm
Height	125 mm
Depth	120 mm
Net weight	0.25 kg
<b>Product properties, functions, components general</b>	
Number of modules note	Number of TIMs per S7-300: 1
Cable length	
• with RS 232 interface maximum	6 m
• with RS 485 interface maximum	-

### Technical specifications (continued)

Article No.	6NH7800-3BA00	Article No.	6NH7800-3BA00
Product-type designation	TIM 3V-IE	Product-type designation	TIM 3V-IE
<b>Performance data</b>		<b>Performance data</b>	
<u>Performance data S7 communication</u>		<u>Performance data S7 communication</u>	
Number of possible connections for S7 communication		Operating mode for scanning of data transmission	
• maximum	8	• with dedicated line/radio link	Polling, polling with time slot procedure
• with PG connections maximum	2	- with SINAUT ST1 protocol	
• with OP connections maximum	8	- with SINAUT ST7 protocol	Polling, polling with time slot procedure, multi-master polling with time slot procedure
• note	-		
Service		• with dial-up network	spontaneous
• SINAUT ST7 through S7 communication	Yes	- with SINAUT ST1 protocol	spontaneous
• PG-/OP-communication	Yes	- with SINAUT ST7 protocol	
<u>Performance data multi-protocol mode</u>		Hamming distance	
Number of active connections with multiprotocol mode	12	• for SINAUT ST1 protocol	4
<u>Performance data telecontrol</u>		• for SINAUT ST7 protocol	4
Suitability for use		<b>Product functions management, configuration</b>	
• node station	No	Configuration software	
• substation	Yes	• required	SINAUT ST7 ES
• control center	No	• for CPU configuring required SINAUT TD7 block library for CPU	Yes
• note	RS232 and Industrial Ethernet cannot be used simultaneously	• for PG configuring required SINAUT ST7 configuration software for PG	Yes
Protocol is supported		Storage location of TIM configuration data	On the TIM
• TCP/IP	Yes	<b>Product functions security Virtual Private Network</b>	
• DNP3	No	Suitability for installation Virtual Private Network	Yes
• SINAUT ST1 protocol	Yes	Product function	
• SINAUT ST7 protocol	Yes	• password protection for VPN	Yes
Product function data buffering if connection is aborted	Yes	• MSC client via GPRS modem with MSC capability	Yes
• note	16 000 data messages	Protocol is supported MSC protocol	No
Storage capacity		Number of possible connections	
• of user memory of S7 CPU		• as MSC client with VPN connection	1
- for TD7onCPU mode data blocks on CPU required	20 Kibyte	• as MSC server with VPN connection	0
- for TD7onTIM mode data blocks on TIM required	0 Kibyte	Protocol with Virtual Private Network MSC is supported	-
• note	TD7onCPU: at least 20 KB, actual requirement determined by data volume and functional scope TD7onTIM: 0 bytes in most favorable case	Key length for MSC with Virtual Private Network	128 bit
Product property retentive message frame memory	No	Type of authentication with Virtual Private Network PSK	Yes
Transmission format		Operating mode Virtual Private Network note	VPN operation as MSC client with MSC protocol and password protection only possible in conjunction with GPRS modem with MSC capability
• for SINAUT ST1 protocol with polling 11 bit	Yes	<b>Product functions Time</b>	
• for SINAUT ST1 protocol with spontaneous 10 bit or 11 bit	Yes	Product component	-
• for SINAUT ST7 protocol with multi-master polling 10 bit	Yes	Hardware real-time clock	-
• for SINAUT ST7 protocol with polling or spontaneous 10 bit or 11 bit	Yes	Product property battery-backed hardware real-time clock	-
		Accuracy of hardware real-time clock per day maximum	-

# Industrial Remote Communication

## TeleControl Professional

### Stations for ST7 protocol

#### TIM 3V-IE for WAN and Ethernet

Ordering data	Article No.		Article No.
<b>TIM 3V-IE communications module</b> With an RS 232 interface for SINAUT communication via a conventional WAN or an IP-based network (WAN or LAN)	<b>6NH7800-3BA00</b>		
<b>SINAUT Engineering Software V5.4</b> On CD-ROM, comprising <ul style="list-style-type: none"> <li>• SINAUT Engineering Software V5.4 for the PG</li> <li>• SINAUT TD7 block library</li> <li>• Electronic manual in German and English</li> </ul>	<b>6NH7997-0CA54-0AA0</b>	<b>IE FC Stripping Tool</b> Preadjusted stripping tool for fast stripping of the Industrial Ethernet FC cables	<b>6GK1901-1GA00</b>
<b>Accessories</b> <b>IE FC TP Standard Cable GP 2 x 2 (Type A)</b> 4-core, shielded TP installation cable for connection to IE FC Outlet RJ45/IE FC RJ45 Plug; PROFINET-compatible; with UL approval; sold by the meter; max. length 1 000 m, minimum order quantity 20 m	<b>6XV1840-2AH10</b>	<b>Connecting cable</b> For connecting a TIM (RS 232) with a SINAUT ST7 MD2, MD3 or MD4 (RS 232) modem; cable length 1.5 m	<b>6NH7701-4AL</b>
<b>IE FC RJ45 Plug 180</b> RJ45 plug-in connector for Industrial Ethernet with a rugged metal housing and integrated insulation displacement contacts for connecting Industrial Ethernet FC installation cables; with 180° cable outlet; for network components and CPs/CPU's with Industrial Ethernet interface <ul style="list-style-type: none"> <li>• 1 pack = 1 unit</li> <li>• 1 pack = 10 units</li> <li>• 1 pack = 50 units</li> </ul>	<b>6GK1901-1BB10-2AA0</b> <b>6GK1901-1BB10-2AB0</b> <b>6GK1901-1BB10-2AE0</b>	<b>Connecting cable</b> For connecting a TIM (RS 232) with the GSM modem MD720-3; also suitable for third-party modems or radio equipment with standard RS 232 interface; cable length 2.5 m	<b>6NH7701-5AN</b>
		<b>Connecting cable</b> with one end open for connecting a TIM (RS 232) to a third-party modem or radio unit (RS 232); cable length 2.5 m	<b>6NH7701-4BN</b>
		<b>Connecting cable</b> For connecting two TIM modules via their RS 232 interface without modems ("null modem"); cable length 6 m	<b>6NH7701-0AR</b>

## Overview



- SINAUT communications module TIM for SIMATIC S7-300 for use in wide area network (WAN) as station, node station, and control center
- IP communication via secure VPN (virtual private network) using the Internet
- Wireless communication via GPRS router, GPRS modem or radio devices
- Wired communication via Ethernet, DSL, dialup modems or dedicated line modem
- Complete migration of existing wireless, dedicated line and dial-up technology to IP-based network
- Message frame memory for complete recording of data and support of redundant communication paths
- Simple configuration and operation without specialist IT knowledge

## Benefits



- Flexible option for connection to any conventional or IP-based WAN
- Low-cost station setup by means of direct connection to DSL router or GPRS via MD720-3 modem and use of the S7-CPU's 312 and 312C, because the SINAUT TD7 CPU software is integrated in the TIM 3V-IE Advanced. (This does not apply to communication with SINAUT ST1 partners and to the transmission of text messages; in this case the SINAUT TD7 software for the CPU (TD7onCPU) must be used, i.e. this software can still be used together with the TIM 3V-IE Advanced.)
- No additional mobile phone service for fixed IP addresses or contracts for private GPRS networks with bidirectional data traffic are necessary, as the VPN is integrated in the ST7 system. No more expensive and complex VPN configuration by IT specialists.
- Saving of traveling and maintenance costs due to cost-effective remote programming, diagnostics, control and monitoring via the Internet

- Reduction in time and costs thanks to quick and user-friendly configuration of connections and data to be transferred with the SINAUT configuring software and block library
- High availability of the connections thanks to possible redundant design of the communication paths (parallel operation of WAN networks supported on RJ45 and RS232 interface of the TIM 3V-IE Advanced)
- Reliable storage of important data. Storage of data message frames (max. 32 000) including time stamp on TIM if the communication path is faulty or a partner has failed and to reduce connection costs for the dial-up network.
- Protection of investment for existing SINAUT ST1 systems through the integration of the SIMATIC S7-300

## Application

- Low-cost automation of water/wastewater networks with both complex and simple structures
- Control and monitoring of energy distribution systems and supply stations, such as oil, gas or district heating networks
- Preventive maintenance (condition monitoring) of globally distributed systems
- Monitoring of logistics and traffic control systems
- Connection of plants with basic or high-level security and availability requirements
- Use in hybrid networks with dialup, wireless, Ethernet or Internet communication

## Design

The TIM 3V-IE Advanced offers all the advantages of the SIMATIC S7-300 design:

- Compact construction; single standard width of the SIMATIC S7-300 SM modules
- 9-pin Sub-D connector with an RS232 interface for connection to a conventional WAN via an appropriate modem
- RJ-45 socket for connection to Industrial Ethernet; or an IP-based network; industrial design with additional sleeve for inserting the IE FC RJ45 Plug 180
- 2-pin plug-in terminal strip for connection of the 24 VDC external supply voltage
- Front LEDs for indicating the module status and the communication
- Easy to mount; the TIM 3V-IE Advanced is mounted on the S7-300 mounting rail and connected to adjacent modules by means of the bus connectors. No slot rules apply.
- Can be operated in the expansion rack (ER) in conjunction with the IM 360/361
- Can be operated without a fan
- A battery backup or memory module are not required

## Industrial Remote Communication

### TeleControl Professional Stations for ST7 protocol

#### TIM 3V-IE Advanced

##### Function

- The TIM 3V-IE Advanced enables one or more SIMATIC S7-300 or control center PCs (e.g. SINAUT ST7cc or ST7sc) to exchange data with other SINAUT ST7 or ST1 stations via any one or two SINAUT networks. The two networks can also be operated in redundant combination. The important SINAUT property - saving data complete with a time stamp on the TIM in the event of an interrupted link or failure of the partner - is then available not only for conventional WANs, but also for IP-based networks. Important events, alarms, etc. are not lost and the integrity of information in control center system archives is assured.
- For setting up more complex control centers or node stations, several TIM 3V-IE Advanced modules can be used for each S7-300. A combination with additional TIM 3 and TIM 4 versions in the same rack is possible here.
- SINAUT ST7 and thus also the TIM 3V-IE Advanced are designed for data transmission via the widest range of WANs or combinations of WANs. Mixed networks comprising classical SINAUT WAN networks (dedicated line, wireless, dial-up network) and IP-based networks (fiber optic, DSL, GPRS, Internet etc.) can be configured uniformly using SINAUT, which saves both time and money.
- For communication via the Internet, the integrated MSC-VPN tunnel protocol for direct access to DSL routers can be used (MSC client). For communication via GPRS, either the router SCALANCE M874-2 can be connected to the IE interface (VPN IPsec) or the GSM/GPRS modem MD720-3 (MSC-VPN) to the RS232 interface.
- PG communication is possible parallel to data communication at any time
- Several TIM 3V-IE Advanced can be used per S7-300
- Message frame memory for up to 32 000 data message frames
- Up to twenty S7 connections via IP-based networks

##### Controllable communication modules:

- Control of the GSM/GPRS modems MD720-3 in GSM or GPRS mode. In the GPRS mode simple 128-bit encryption via the MD720-3 (MSC-VPN tunnel protocol)
- Operation via SIMATIC NET Ethernet components with high IPsec security standard (e.g. GPRS router or SCALANCE S)
- Direct operation on a DSL router by means of MSC tunnel protocol
- Use of SCALANCE fiber-optic switches for spanning long distances
- Wireless transmission via IWLAN with SCALANCE W over medium distances
- Dedicated line modem MD2 for point-to-point, point-to-multi-point or line connections
- Wireless devices from various manufacturers, also for private mobile radio using the time slot method
- Analog dial-up modem MD3 for the analog telephone network or point-to-point dedicated lines
- ISDN modem MD4 for connecting to the ISDN network

##### Integration

###### Connection to IP-based networks

In addition to the RS232 interface, the TIM 3V-IE Advanced also has an RJ45 socket. This is suitable for the connection of IP-based networks (WAN or LAN). Depending on the application, various types of data communication equipment can be connected such as:

- SCALANCE X switches for Twisted Pair cable or fiber-optic cables
- SCALANCE W (IWLAN) and Ethernet radio devices from various manufacturers
- EDGE router SCALANCE M874-2 for GPRS communication and EGPRS (Edge) over mobile wireless networks
- SCALANCE M for communication via mobile wireless networks
- GPRS/GSM modem MD720-3 for GPRS communication over mobile wireless networks
- DSL router and SCALANCE S for VPN (IPsec)
- DSL router directly by means of MSC-VPN tunnel protocol integrated in the TIM
- Broadband systems such as OTN and PCM30

###### Configuration examples with TIM 3V-IE Advanced

###### Use as a station

The TIM 3V-IE Advanced can be used as a station like a TIM 3V-IE. In addition, transmission is possible via the direct connection of the TIM to a DSL router (MSC tunnel).

Use the MSC tunnel protocol (MSC client) integrated in the TIM 3V-IE Advanced to operate a connection via Industrial Ethernet and a DSL router to a TIM 4R-IE that terminates the MSC tunnel protocol.

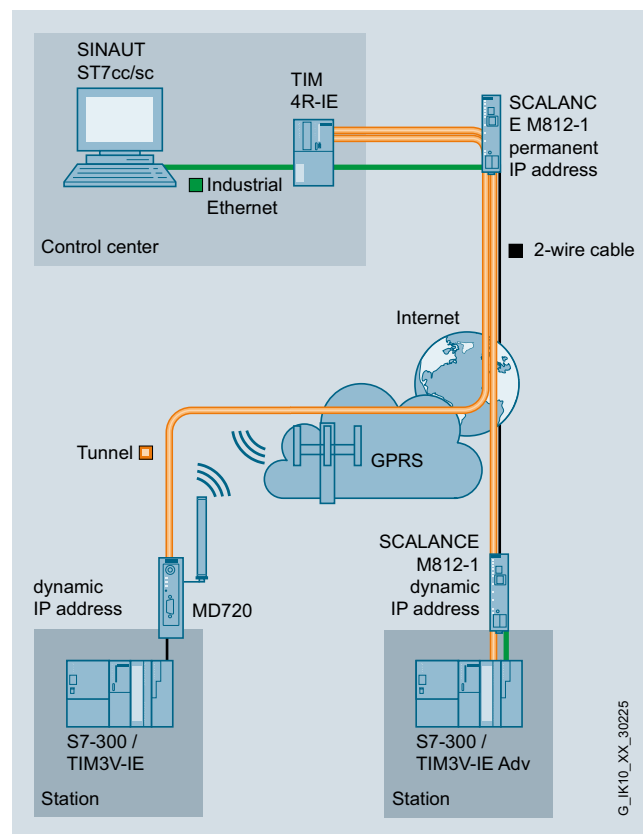

G\_IK10\_XX\_30225



**Integration** (continued)

Use in a node station

When used in a node station, TIM 3V-IE Advanced can, for example, exchange data over its RS232 interface over a radio network with the lower-level stations. It is then connected to the control desk over the RJ45 interface, e.g. over a fiber-optic cable, that is connected through SCALANCE X switches. In this configuration, data can be exchanged between each of the SINAUT stations regardless of which network they are situated in.

In this case, in order to disconnect the networks, the connection in the control center can be made via a TIM 4R-IE or, as in the example, directly to the Ethernet interface of the PC.

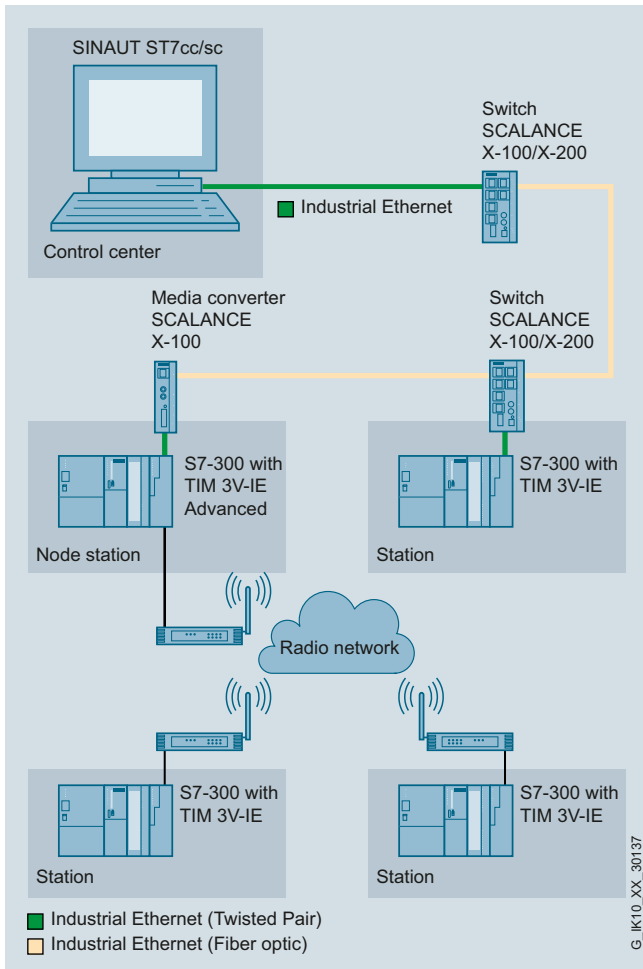

Redundant transmission paths

Using TIM 3V-IE Advanced, a station can be connected to the control desk over redundant paths. The TIM 3V-IE Advanced is used for this purpose both in the station and in the control center. The example includes a combination of fiber-optic cables and radio paths as redundant paths. The two TIMs coordinate data transmission: It takes place normally over the main path and only if it fails over the standby path. When the main path is restored, changeover back to this path is performed automatically.

The TIM 3V-IE Advanced in the control center has access to the MPI interface of the S7-300-CPU via the backplane bus, by which the TIM communicates with the control desk PC (e.g. ST7cc). Note that only certain types of CPU can be considered for this application.

A TIM 4R-IE can be used in the control center as a replacement for the TIM 3V-IE Advanced. Without a S7-300-CPU, this TIM is connected to the control desk PC via one of the two Ethernet ports.

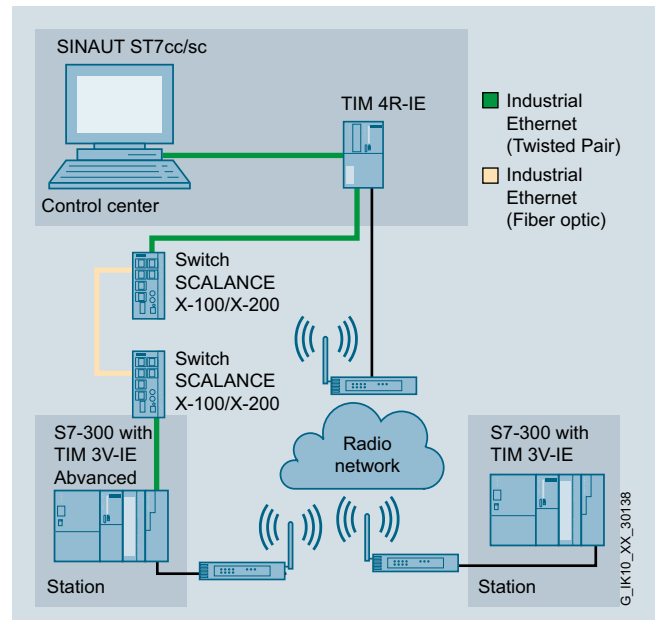

Note:

Use of the MPI port of the local CPU is possible with the following types of CPU: all versions of the CPUs 312, 312C, 313C, 314 and 314C, the CPUs 315-2 DP and 315F-2 DP.

## Industrial Remote Communication

### TeleControl Professional Stations for ST7 protocol

#### TIM 3V-IE Advanced

#### Integration (continued)

##### Use in a control center

The TIM 3V-IE Advanced is also suitable for configuring a control center that comprises more than one TIM. In the following example, the TIM 3V-IE Advanced is combined with a TIM 4R-IE. Both TIMs are connected via the MPI with the CPU inserted in the rack. Both TIMs process data communication with the stations in their own networks and route the data via Industrial Ethernet to the PC.

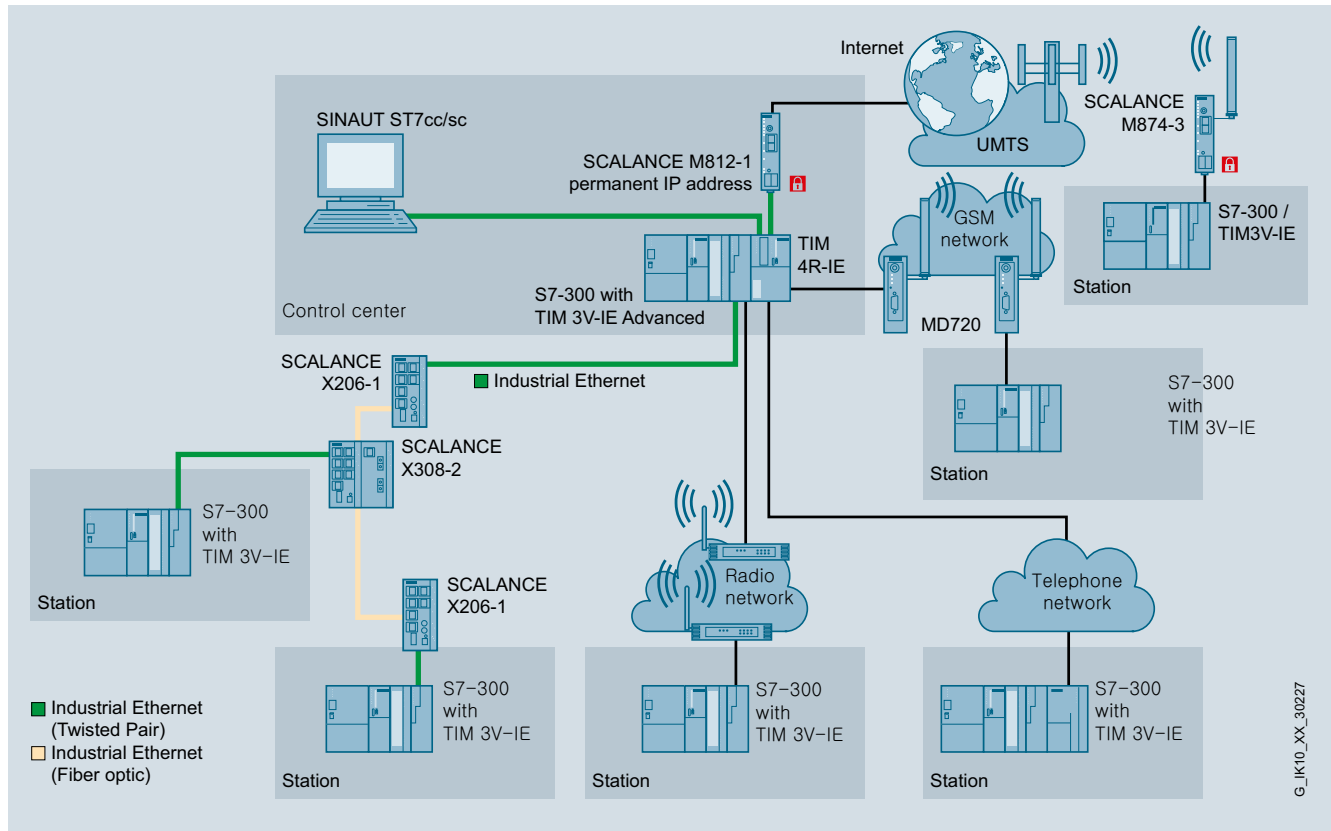

#### Connection to a conventional WAN

Connection to a conventional WAN is via the floating RS232 interface of the TIM 3V-IE Advanced module, via which various modems or data communication equipment can be connected, depending on the application. The RS232 interface can then be operated parallel to the Industrial Ethernet interface.

### Technical specifications

Article No.	6NH7800-3CA00
Product-type designation	TIM 3V-IE Advanced
<b>Transmission rate</b>	
Transfer rate	
• for Industrial Ethernet	10 ... 100 Mbit/s
• in accordance with RS 232	50 ... 38 400 bit/s
<b>Interfaces</b>	
Number of interfaces according to Industrial Ethernet	1
Number of electrical connections	
• for external data transmission in accordance with RS 232	1
• for power supply	1
Design of electrical connection	
• the Industrial Ethernet Interface	RJ45 port
• at interface 1 for external data transmission	9-pin D-sub male connector (RS232)
• at interface 2	-
• for external data transmission	
• for power supply	2-pin, pluggable terminal strip
design of the removable storage C-PLUG	No
<b>Supply voltage, current consumption, power loss</b>	
Type of supply voltage	DC
Supply voltage	24 V
• minimum	20.4 V
• maximum	28.8 V
Consumed current	
• from backplane bus at 24 V for DC maximum	0.2 A
• from external supply voltage at 24 V with DC maximum	0.2 A
Resistive loss	5.8 W
Product expansion optional backup battery	No
Type of battery	-
Backup current	
• typical	-
• maximum	-
<b>Permitted ambient conditions</b>	
Ambient temperature	
• during operating	0 ... 60 °C
• during storage	-40 ... +70 °C
• during transport	-40 ... +70 °C
Relative humidity at 25 °C without condensation during operating maximum	95 %
Protection class IP	IP20
<b>Design, dimensions and weight</b>	
Module format	Compact module S7-300 single width
Width	40 mm
Height	125 mm
Depth	120 mm
Net weight	0.25 kg

Article No.	6NH7800-3CA00
Product-type designation	TIM 3V-IE Advanced
<b>Product properties, functions, components general</b>	
Number of modules note	Number of TIMs per S7-300: multiple, number depends on the connection resources of the S7-300 CPU
Cable length	
• with RS 232 interface maximum	6 m
• with RS 485 interface maximum	-
<b>Performance data</b>	
<u>Performance data S7 communication</u>	
Number of possible connections for S7 communication	
• maximum	24
• with PG connections maximum	4
• with OP connections maximum	20
• note	-
Service	
• SINAUT ST7 through S7 communication	Yes
• PG-/OP-communication	Yes
<u>Performance data multi-protocol mode</u>	
Number of active connections with multiprotocol mode	24
<u>Performance data telecontrol</u>	
Suitability for use	
• node station	Yes
• substation	Yes
• control center	Yes
• note	
Protocol is supported	
• TCP/IP	Yes
• DNP3	No
• SINAUT ST1 protocol	Yes
• SINAUT ST7 protocol	Yes
Product function data buffering if connection is aborted	Yes
• note	32 000 data messages
Storage capacity	
• of user memory of S7 CPU	
- for TD7onCPU mode data blocks on CPU required	20 Kibyte
- for TD7onTIM mode data blocks on TIM required	0 Kibyte
• note	TD7onCPU: at least 20 KB, actual requirement determined by data volume and functional scope TD7onTIM: 0 bytes in most favorable case
Product property retentive message frame memory	No

# Industrial Remote Communication

## TeleControl Professional

### Stations for ST7 protocol

#### TIM 3V-IE Advanced

#### Technical specifications (continued)

Article No.	6NH7800-3CA00	Article No.	6NH7800-3CA00
Product-type designation	TIM 3V-IE Advanced	Product-type designation	TIM 3V-IE Advanced
Transmission format		<b>Product functions security</b>	
• for SINAUT ST1 protocol with polling 11 bit	Yes	<b>Virtual Private Network</b>	
• for SINAUT ST1 protocol with spontaneous 10 bit or 11 bit	Yes	Suitability for installation Virtual Private Network	Yes
• for SINAUT ST7 protocol with multi-master polling 10 bit	Yes	Product function	
• for SINAUT ST7 protocol with polling or spontaneous 10 bit or 11 bit	Yes	• password protection for VPN	Yes
Operating mode for scanning of data transmission		• MSC client via GPRS modem with MSC capability	Yes
• with dedicated line/radio link		Protocol is supported MSC protocol	Yes
- with SINAUT ST1 protocol	Polling, polling with time slot procedure	Number of possible connections	
- with SINAUT ST7 protocol	Polling, polling with time slot procedure, multi-master polling with time slot procedure	• as MSC client with VPN connection	1
• with dial-up network		• as MSC server with VPN connection	0
- with SINAUT ST1 protocol	spontaneous	Protocol with Virtual Private Network MSC is supported	TCP/IP
- with SINAUT ST7 protocol	spontaneous	Key length for MSC with Virtual Private Network	128 bit
Hamming distance		Type of authentication with Virtual Private Network PSK	Yes
• for SINAUT ST1 protocol	4	Operating mode Virtual Private Network note	-
• for SINAUT ST7 protocol	4	<b>Product functions Time</b>	
<b>Product functions management, configuration</b>		Product component	-
Configuration software		Hardware real-time clock	-
• required		Product property battery-backed hardware real-time clock	-
• for CPU configuring required SINAUT TD7 block library for CPU	Yes	Accuracy of hardware real-time clock per day maximum	-
• for PG configuring required SINAUT ST7 configuration software for PG	Yes		
Storage location of TIM configuration data	On the TIM		

Ordering data	Article No.		Article No.
<b>TIM 3V-IE Advanced communications module</b> With an RS 232 interface and an RJ45 interface for SINAUT communication via a conventional WAN and an IP-based network (WAN or LAN)	<b>6NH7800-3CA00</b>		
<b>SINAUT Engineering Software V5.4</b> On CD-ROM, comprising <ul style="list-style-type: none"> <li>• SINAUT ST7 Engineering Software V5.4 for the PG</li> <li>• SINAUT TD7 block library</li> <li>• Electronic manual in German and English</li> </ul>	<b>6NH7997-0CA54-0AA0</b>		
<b>Accessories</b>			
<b>IE FC TP Standard Cable GP 2 x 2 (Type A)</b> 4-core, shielded TP installation cable for connection to IE FC Outlet RJ45/IE FC RJ45 Plug; PROFINET-compatible; with UL approval; sold by the meter; max. length 1 000 m, minimum order quantity 20 m	<b>6XV1840-2AH10</b>		
<b>IE FC RJ45 Plug 180</b> RJ45 plug-in connector for Industrial Ethernet with a rugged metal housing and integrated insulation displacement contacts for connecting Industrial Ethernet FC installation cables; with 180° cable outlet; for network components and CPs/CPU with Industrial Ethernet interface <ul style="list-style-type: none"> <li>• 1 pack = 1 unit</li> <li>• 1 pack = 10 units</li> <li>• 1 pack = 50 units</li> </ul>	<b>6GK1901-1BB10-2AA0</b> <b>6GK1901-1BB10-2AB0</b> <b>6GK1901-1BB10-2AE0</b>		
		<b>IE FC Stripping Tool</b> Preadjusted stripping tool for fast stripping of the Industrial Ethernet FC cables	<b>6GK1901-1GA00</b>
		<b>Connecting cable</b> For connecting a TIM (RS 232) with a SINAUT ST7 MD2, MD3 or MD4 (RS 232) modem; cable length 1.5 m	<b>6NH7701-4AL</b>
		<b>Connecting cable</b> For connecting a TIM (RS 232) with the GSM modem MD720-3; also suitable for third-party modems or radio equipment with standard RS 232 interface; cable length 2.5 m	<b>6NH7701-5AN</b>
		<b>Connecting cable</b> with one end open for connecting a TIM (RS 232) to a third-party modem or radio unit (RS 232); cable length 2.5 m	<b>6NH7701-4BN</b>
		<b>Connecting cable</b> For connecting two TIM modules via their RS 232 interface without modems ("null modem"); cable length 6 m	<b>6NH7701-0AR</b>

## Industrial Remote Communication

### TeleControl Professional Stations for ST7 protocol

#### TIM 4R-IE for WAN and Ethernet

#### Overview



- SINAUT communications module TIM with four interfaces for SIMATIC S7-300 or as self-contained unit for the S7-400 for use in the wide area network (WAN)
- For universal use in a SINAUT station, node station and control center
- Internet communication via integrated MSC-VPN tunnel with direct connection to DSL router or operation via IPsec VPN with additional SIMATIC NET components
- Wireless communication via GPRS router, GPRS modem, or radio devices
- Wired communication via Ethernet, DSL, dialup modems or dedicated line modem
- Complete migration of existing wireless, dedicated line and dial-up technology to IP-based network
- Message frame memory for complete recording of data and support of redundant communication paths
- Simple configuration and operation without specialist IT knowledge

#### Benefits

**get** Designed for Industry

- Protection of investment by combining existing conventional networks with IP-based networks by means of flexible options for connection of up to four SINAUT networks
- Low-cost construction of the control center by direct connection as independent device to a DSL router, made possible by the integrated MSC-VPN protocol
- No additional mobile phone service for fixed IP addresses or contracts for private GPRS networks with bidirectional data traffic are necessary, as the VPN is integrated in the ST7 system. No more expensive and complex VPN configuration by IT specialists.
- High availability of the connections due to possible redundant design of the communication paths
- Reliable storage of important data. Storage of data message frames (approx. 56 000) including time stamp on TIM in the case of communication path malfunction or power failure
- Saving of time and money through fast and user-friendly configuration of the connections, as well as through remote programming and diagnostics (PG routing) parallel to the SINAUT data transmission via the WAN or Internet connection
- Easy maintenance through replacement of modules without PG

#### Application

- Use as self-contained central station for the low-cost automation of water/wastewater networks with both complex and simple structures
- Control and monitoring of energy distribution systems and supply stations, such as oil, gas or district heating networks
- Preventive maintenance (condition monitoring) of globally distributed systems
- Monitoring of logistics and traffic control systems
- Connection of plants with basic or high-level security and availability requirements
- Use in hybrid networks with dialup, wireless, Ethernet or Internet communication

#### Design

The TIM 4R-IE offers all the advantages of the SIMATIC S7-300 design:

- Compact construction; double standard width of SIMATIC S7-300 SM modules
- Two 9-pin Sub-D connectors with a combined RS 232/RS 485 interface for connection to a conventional WAN via an appropriate modem
- Two RJ45 sockets for connecting to Industrial Ethernet or a IP-based network; designed for industry with additional fixing collars for connecting the IE FC RJ45 Plug 180
- 2-pin plug-in terminal strip for connection of the 24 VDC external supply voltage
- Front LEDs for indicating the module status and the communication
- Easy to mount; the TIM is mounted to an S7-300-mounting rail; if integrated as a CP into an S7-300 it is connected to adjacent modules by means of the bus connector supplied with the TIM. No slot rules apply. As a standalone device, it is linked via one of its Ethernet interfaces with one or more S7-400 CPUs or with one or more control center PCs.
- Can be operated in the expansion rack (ER) in conjunction with the IM 360/361
- Can be operated without a fan
- A battery backup or memory module can be fitted as an option

#### Function

The TIM 4R-IE can be used as a standalone device, i.e. it is fully functional even without S7-300-CPU. In this stand-alone mode, the TIM is especially suitable as a SINAUT communications processor for the control desk PC (e.g. SINAUT ST7cc or ST7sc) or for a SIMATIC S7-400. The TIM is connected to the PC or S7-400 via one of its two Ethernet interfaces. If the control desk is redundantly designed or if an S7-400 is additionally available there as a higher-level controller, then the TIM performs the SINAUT communication with the stations for all these devices connected to the local Ethernet.

The TIM 4R-IE can also be built into a SIMATIC S7-300 as a CP, e.g. if these devices require redundant transmission paths there or function as node stations at which more than two networks must be merged.

All the devices mentioned can exchange data with other SINAUT ST7 or ST1 partners with the aid of the TIM 4R-IE and specifically via as many as four SINAUT networks that can also be operated in any redundant combination.

The important SINAUT property - saving data complete with a time stamp on the TIM in the event of an interrupted link or failure of the partner - is then available not only for conventional WANs, but also for IP-based networks. Important events, alarms, etc. are not lost and the integrity of information in control center system archives is assured. Additional security is offered by the optional backup battery of the TIM 4R-IE which prevents the loss of saved data message frames if the 24 V supply fails.

For setting up more complex control centers or node stations, several TIM 4R-IE modules can be used. Combinations with TIM 3V-IE Advanced and TIM 3 and other TIM 4 versions are also possible.

As a communication module for the control desk PC, the TIM reduces the number of S7 connections that the PC would otherwise have to maintain when directly linked to the stations via an IP-based network, to just one (1) connection. In addition, the TIM then separates the local Ethernet from the IP-based network to the stations. Only SINAUT and PG communication with the stations is allowed through. This prevents unnecessary traffic in the WAN which is often not broadband.

A TIM 4R-IE that is used at a redundant control desk reduces the data volume in a WAN and thus it reduces the costs for networks with volume tariffs, e.g. GPRS. If stations were connected directly to the redundant control desk (without central TIM 4R-IE), they would send each frame twice in order to send data to both control desk PCs. In the case of a control center TIM 4R-IE, the stations only send their message frames once. The doubling of the message frames for supplying both PCs is then performed by the control center TIM 4R-IE.

For data transmission via conventional WANs, the TIM 4R-IE has other, special properties that predetermine its use as a "control center" TIM.

SINAUT ST7 and thus also the TIM 4R-IE are designed for data transmission via the widest range of WANs or combinations of WANs. Mixed networks comprising classical SINAUT WAN networks (dedicated line, wireless, dial-up network) and IP-based networks (fiber optic, DSL, GPRS, Internet etc.) can be configured uniformly using SINAUT, which saves both time and money.

For communication via the Internet, the integrated MSC-VPN tunnel protocol for direct access to DSL routers can be used. The TIM 4R-IE can operate here as an MSC server or MSC client. For communication via GPRS, either the router SCALANCE M874-2 can be connected to the Industrial Ethernet interface (VPN IPsec) or the GSM/GPRS modem MD720-3 (MSC-VPN) to the RS232 interface.

- The TIM4R-IE has four interfaces for simple and redundant transmission paths:
  - Two combined RS232/RS485 interfaces for connection to standard WANs such as dedicated line, wireless or dial-up network
  - Two RJ45 interfaces for connection to IP-based networks (WAN or LAN) such as fiber-optics, DSL, GPRS, etc.
- Compact, double-width module that can be used in a wide variety of situations:
  - The TIM handles the SINAUT communication for one or more S7-400 controllers or control desk PCs (SINAUT ST7cc or ST7sc) as a stand-alone device (stand-alone without S7-300 CPU); the connection in this case is via Ethernet interfaces of the TIM
  - As a communications processor (CP) in an S7-300
- The two RJ45 interfaces can be configured either as an MSC-VPN server in the central office or as MSC-VPN client in a station. At the RS232 interface, an MD720-3 can be operated in GPRS mode as MSC-VPN client.
- The four transmission paths can all be different and operated independently of one another, but also in any redundant combination.
- Flexible creation of redundant transmission paths via two conventional WANs, via two IP-based networks or a combination of WAN + IP-based network.
- When installed as a CP in an S7-300, the following communication is also possible via the backplane bus:
  - With the CPU
  - Via the MPI of this CPU with other CPUs and control desk PCs (ST7cc, ST7sc) connected over the MPI bus.
  - With other TIMs in this rack
- Message frame memory for up to 56 000 data message frames
- Optional backup battery for backup of the stored data message frames and the hardware clock if the power fails
- Up to 62 S7 connections or 128 MSC-VPN tunnel connections (as control center) via IP-based networks and MPI (for S7-300-CPU)
- The SINAUT TD7 software for the CPU (TD7onCPU) is integrated in the TIM (TD7onTIM); implemented with installation as CP in a S7-300
- Module replacement possible without PG
  - In stand-alone mode using the optional C-PLUG
  - When installed as a CP in an S7-300 over the memory card of the CPU
- PG communication is possible parallel to data communication at any time
- Several TIM 4R-IE can be used per S7-300, also together with one or more TIM 3V-IE Advanced
- Up to 128 S7 connections via IP-based networks (in MSC tunnel mode)

## Industrial Remote Communication

### TeleControl Professional Stations for ST7 protocol

#### TIM 4R-IE for WAN and Ethernet

##### Function (continued)

###### Controllable communication modules:

- Control of the GSM/GPRS modems MD720-3 in the GSM or GPRS mode. In GPRS mode, simple 128-bit encryption via the MD720-3 (MSC-VPN tunnel protocol).
- Operation via SIMATIC NET Ethernet components with high IPsec security standard (e.g. GPRS router or SCALANCE S)
- Direct operation on a DSL router by means of MSC tunnel protocol
- Use of SCALANCE fiber-optic switches for spanning long distances
- Wireless transmission via IWLAN with SCALANCE W over medium distances
- Dedicated line modem MD2 for point-to-point, point-to-multi-point or line connections
- Wireless devices from various manufacturers, also for private mobile radio using the time slot method
- Analog dial-up modem MD3 for the analog telephone network or point-to-point dedicated lines

###### Special properties as "control center" TIM

For data transmission via conventional WANs, the TIM 4R-IE has other, special properties that predetermine its use as a "control center" TIM:

- In a dialup network the message "Failure of local node" can be switched off. If the control desk PC fails or is temporarily shut down, the control center TIM 4R-IE will not send any failure message to the stations in the dialup network and therefore saves transmission costs.
- One especially useful feature during commissioning is the possibility that SINAUT stations can be switched on and off on the control center TIM 4R-IE. This applies not only for stations that are connected via dedicated line/radio, but also for stations in the dial-up network. The last status set for each station is permanently stored on the TIM and is therefore not lost if the power fails or the TIM is restarted.
- For GPRS, dedicated lines and mobile networks, the message "Node faulty" can be suppressed on the TIM 4R-IE for a programmable period of time. A station failure is then no longer indicated after x unanswered calls (polls), but only when a recognized fault still exists after expiry of the programmed time. This enables the number of failure messages to be reduced in poor-quality networks and it also minimizes the additional message frame traffic that must be processed after each station is restored.

###### Optional C-PLUG

The most frequent application for the TIM 4R-IE will be its use as a communication module for the control desk PC or for an S7-400. The TIM then operates in standalone mode, i.e. without S7-300 CPU. The option of saving the TIM configuration data on the MMC card of the CPU, in order to exchange the TIM without a PG in the event of a fault, no longer applies. The saving of configuration data on the C-PLUG, which can be optionally equipped, solves this problem. This means that, even in standalone mode, a replacement of the TIM is possible without PG.

##### Integration

###### Connection to IP-based networks

In addition to the two combined RS 232/RS 485 interfaces, the TIM 4R-IE also has two RJ45 sockets. These are suitable for the connection of IP-based networks (WAN or LAN). Depending on the application, various types of data communication equipment can be connected such as:

- SCALANCE X switches for Twisted Pair cable or fiber-optic cables
- SCALANCE W (IWLAN) and Ethernet radio devices from various manufacturers
- SCALANCE M for communication via mobile wireless networks
- EGPRS router SCALANCE M874-2 for GPRS communication and EGPRS (Edge) over mobile wireless networks
- SCALANCE S for VPN (IPsec)
- GPRS/GSM modem MD720-3 for GPRS communication via GSM mobile telephone networks using MSC-VPN tunnel protocol
- Directly on a DSL router by means of the MSC-VPN tunnel protocol integrated in the TIM
- Broadband systems such as OTN, PCM30

###### Connection to a conventional WAN

For the connection to a conventional WAN the TIM 4R-IE provides two floating RS 232/RS 485 interfaces, to which various data communication devices can be connected, depending on the application, such as:

- Dedicated line modem MD2 for point-to-point, point-to-multi-point or line connections
- Wireless devices from various manufacturers, also for private mobile radio using the time slot method
- Analog dial-up modem MD3 for the analog telephone network or point-to-point dedicated lines
- GPRS/GSM modem MD720-3 for access to the mobile telephone network



**Integration** (continued)

**Configuration examples using TIM 4R-IE**

Use in a node station

In a node station with a SIMATIC S7-400 the TIM 4R-IE is connected to the S7-400 via one of its two Ethernet interfaces and can, for example, exchange data by radio with the subordinate stations via an RS232/RS485 interface. It is then connected to the control center via the second Ethernet interface, e.g. via a fiber-optic cable that is connected through SCALANCE X switches and media converters.

In this configuration, data can be exchanged between all of the SINAUT stations regardless of which network they are situated in.

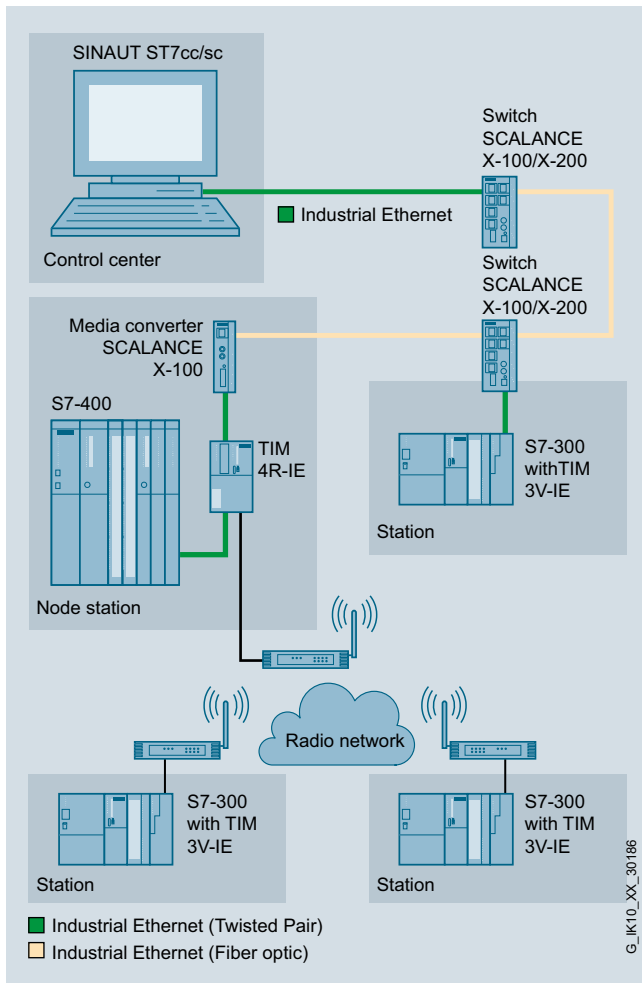

Use in a node station

Redundant transmission paths

Using TIM 4R-IE, a station can be connected to the control center over redundant paths. The TIM 4R-IE is used for this purpose both in the station and in the control center. The example shows as redundant paths a combination of leased line and radio, i.e. two conventional WANs, for which the TIM 4R-IE offers corresponding connections (2 x RS232/RS485). The two TIMs coordinate the data transmission. It takes place normally over the main path and only if it fails over the standby path. When the main path is restored, changeover back to this path is performed automatically.

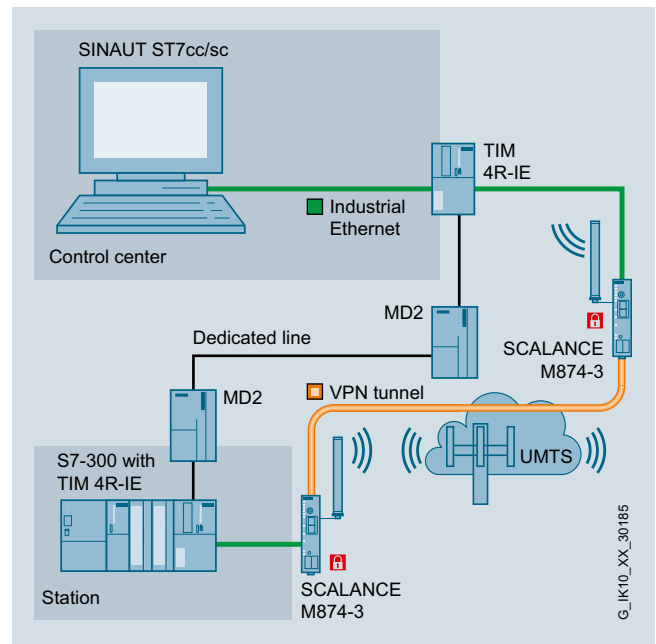

Redundant transmission paths

## Industrial Remote Communication

### TeleControl Professional Stations for ST7 protocol

#### TIM 4R-IE for WAN and Ethernet

##### Integration (continued)

###### Use in a control center

The TIM 4R-IE is also suitable for use in a control center, either alone or in combination with other TIMs. The following example shows a TIM 4R-IE that is connected via one of its two Ethernet interfaces with the control center PC (e.g. ST7cc). An S7-400 is also connected to the Industrial Ethernet and this must also exchange data with the SINAUT stations. SINAUT stations are connected by means of GPRS using MSC-VPN via the second Ethernet port of the TIM, while a wireless network and point-to-point leased line network are connected via the two RS232/RS485 ports. For the point-to-point connection, the port of the TIM is set to RS485. It is then possible to operate up to 30 SINAUT leased line modems on this port; the example shows MD2 modems.

If the stations in this network have to be provided with the date and time, the control center PC assumes the function of the clock-time master. Via the Ethernet connection, the TIM 4R-IE is regularly synchronized by the PC and it then takes over the synchronization of the connected stations.

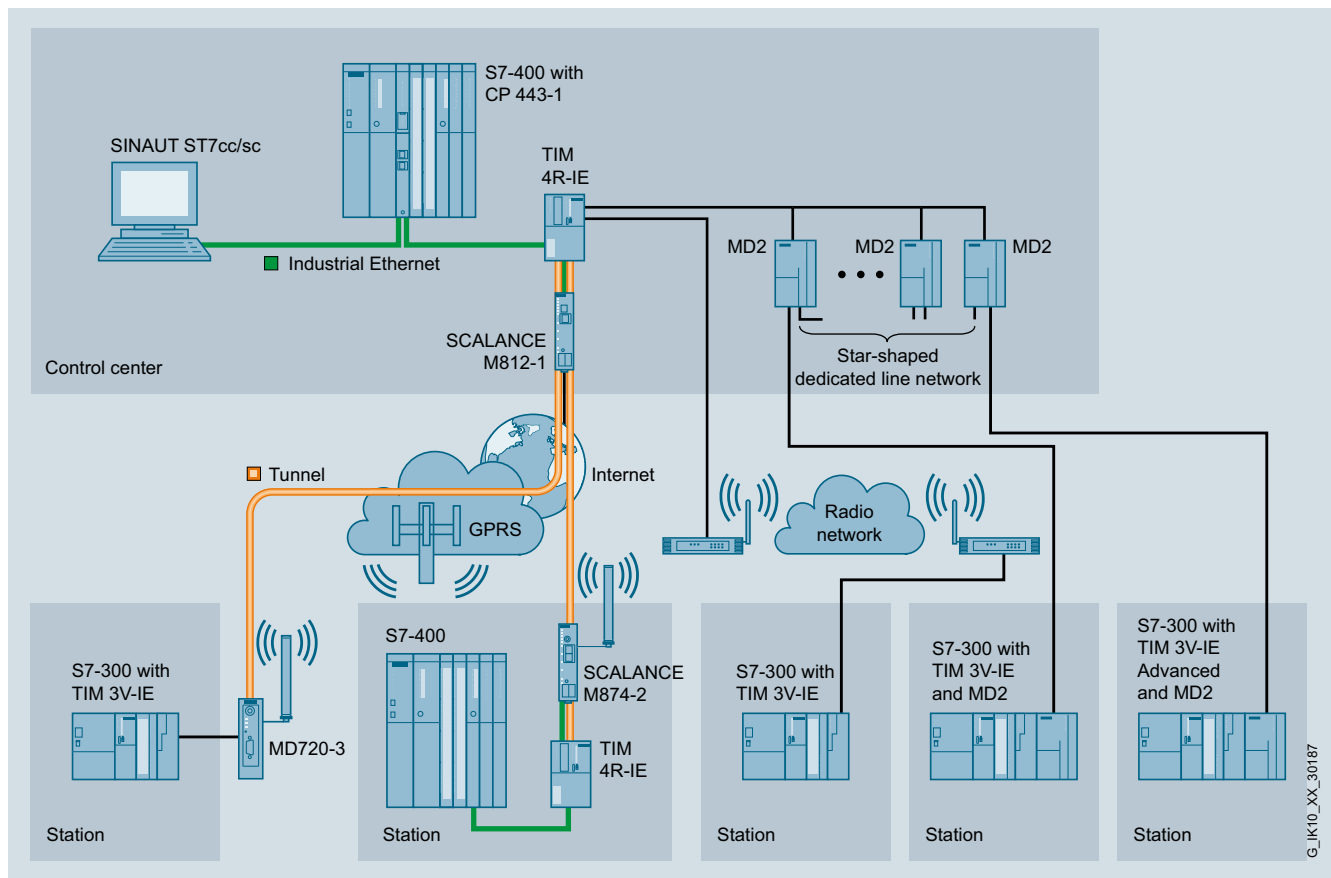

Use of TIM 4R-IE in a control center

### Technical specifications

Article No.	6NH7800-4BA00	Article No.	6NH7800-4BA00
Product-type designation	TIM 4R-IE	Product-type designation	TIM 4R-IE
<b>Transmission rate</b>		<b>Product properties, functions, components general</b>	
Transfer rate		Number of modules note	Number of TIM 4R-IE per S7-300/S7-400: multiple, number depends on the connection resources of the CPU
• for Industrial Ethernet	10 ... 100 Mbit/s		
• in accordance with RS 232	50 ... 38 400 bit/s		
<b>Interfaces</b>		Cable length	
Number of interfaces according to Industrial Ethernet	2	• with RS 232 interface maximum	6 m
Number of electrical connections		• with RS 485 interface maximum	30 m
• for external data transmission in accordance with RS 232	2	<b>Performance data</b>	
• for power supply	1	<u>Performance data S7 communication</u>	
Design of electrical connection		Number of possible connections for S7 communication	
• the Industrial Ethernet Interface	RJ45 port	• maximum	64
• at interface 1	9-pin D-sub connector, RS232 switchable to RS485	• with PG connections maximum	2
• at interface 2	9-pin D-sub connector, RS232 switchable to RS485	• with OP connections maximum	62
• for external data transmission		• note	-
• for power supply	2-pin, pluggable terminal strip	Service	
design of the removable storage C-PLUG	Yes	• SINAUT ST7 through S7 communication	Yes
<b>Supply voltage, current consumption, power loss</b>		• PG-/OP-communication	Yes
Type of supply voltage	DC	<u>Performance data multi-protocol mode</u>	
Supply voltage	24 V	Number of active connections with multiprotocol mode	128
• minimum	20.4 V	<u>Performance data telecontrol</u>	
• maximum	28.8 V	Suitability for use	
Consumed current		• node station	Yes
• from backplane bus at 24 V for DC maximum	0.2 A	• substation	Yes
• from external supply voltage at 24 V with DC maximum	0.17 A	• control center	Yes
Resistive loss	4.6 W	• note	-
Product expansion optional backup battery	Yes	Protocol is supported	Yes
Type of battery	Lithium AA / 3.6 V / 2.3 Ah	• TCP/IP	
Backup current		• DNP3	No
• typical	100 µA	• SINAUT ST1 protocol	Yes
• maximum	160 µA	• SINAUT ST7 protocol	Yes
<b>Permitted ambient conditions</b>		Product function data buffering if connection is aborted	Yes
Ambient temperature		• note	56 000 data messages
• during operating	0 ... 60 °C	Storage capacity	
• during storage	-40 ... +70 °C	• of user memory of S7 CPU	
• during transport	-40 ... +70 °C	- for TD7onCPU mode data blocks on CPU required	20 Kibyte
Relative humidity at 25 °C without condensation during operating maximum	95 %	- for TD7onTIM mode data blocks on TIM required	0 Kibyte
Protection class IP	IP20	• note	TD7onCPU: at least 20 KB, actual requirement determined by data volume and functional scope TD7onTIM: 0 bytes in most favorable case
<b>Design, dimensions and weight</b>		Product property retentive message frame memory	Yes
Module format	Compact module S7-300 double width	Transmission format	
Width	80 mm	• for SINAUT ST1 protocol with polling 11 bit	Yes
Height	125 mm	• for SINAUT ST1 protocol with spontaneous 10 bit or 11 bit	Yes
Depth	120 mm	• for SINAUT ST7 protocol with multi-master polling 10 bit	Yes
Net weight	0.4 kg	• for SINAUT ST7 protocol with polling or spontaneous 10 bit or 11 bit	Yes

# Industrial Remote Communication

## TeleControl Professional

### Stations for ST7 protocol

#### TIM 4R-IE for WAN and Ethernet

#### Technical specifications (continued)

Article No.	6NH7800-4BA00	Article No.	6NH7800-4BA00
Product-type designation	TIM 4R-IE	Product-type designation	TIM 4R-IE
Operating mode for scanning of data transmission		<b>Product functions security</b>	
<ul style="list-style-type: none"> <li>with dedicated line/radio link               <ul style="list-style-type: none"> <li>with SINAUT ST1 protocol</li> <li>with SINAUT ST7 protocol</li> </ul> </li> <li>with dial-up network               <ul style="list-style-type: none"> <li>with SINAUT ST1 protocol</li> <li>with SINAUT ST7 protocol</li> </ul> </li> </ul>	Polling, polling with time slot procedure Polling, polling with time slot procedure, multi-master polling with time slot procedure  spontaneous spontaneous	<b>Virtual Private Network</b>	
Hamming distance		Suitability for installation Virtual Private Network	Yes
<ul style="list-style-type: none"> <li>for SINAUT ST1 protocol</li> <li>for SINAUT ST7 protocol</li> </ul>	4 4	Product function	
<b>Product functions management, configuration</b>		<ul style="list-style-type: none"> <li>password protection for VPN</li> <li>MSC client via GPRS modem with MSC capability</li> </ul>	Yes Yes
Configuration software		Protocol is supported MSC protocol	Yes
<ul style="list-style-type: none"> <li>required</li> <li>for CPU configuring required SINAUT TD7 block library for CPU</li> <li>for PG configuring required SINAUT ST7 configuration software for PG</li> </ul>	Yes Yes	Number of possible connections	
Storage location of TIM configuration data	On internal TIM flash memory, or on TIM in optional C-PLUG, or on MMC of the S7-300 CPU if TIM installed in S7-300 controller	<ul style="list-style-type: none"> <li>as MSC client with VPN connection</li> <li>as MSC server with VPN connection</li> </ul>	1 128
		Protocol with Virtual Private Network MSC is supported	TCP/IP
		Key length for MSC with Virtual Private Network	128 bit
		Type of authentication with Virtual Private Network PSK	Yes
		Operating mode Virtual Private Network note	-
		<b>Product functions Time</b>	
		Product component Hardware real-time clock	Yes
		Product property battery-backed hardware real-time clock	Yes
		Accuracy of hardware real-time clock per day maximum	4 s

#### Ordering data

<b>TIM 4R-IE communications module</b> With two combined RS 232/RS 485 interfaces for SINAUT communication via conventional WANs and two RJ45 interfaces for SINAUT communication via IP-based networks (WAN or LAN)	<b>6NH7800-4BA00</b>	<b>IE FC Stripping Tool</b> Preadjusted stripping tool for fast stripping of the Industrial Ethernet FC cables	<b>6GK1901-1GA00</b>
<b>SINAUT Engineering Software V5.4</b> On CD-ROM, comprising <ul style="list-style-type: none"> <li>• SINAUT ST7 Engineering Software V5.4 for the PG</li> <li>• SINAUT TD7 block library</li> <li>• Electronic manual in German and English</li> </ul>	<b>6NH7997-0CA54-0AA0</b>	<b>Connecting cable</b> For connecting a TIM (RS 232) with a SINAUT ST7 MD2, MD3 or MD4 (RS 232) modem; cable length 1.5 m	<b>6NH7701-4AL</b>
<b>Accessories</b> <b>Backup battery</b> 3.6 V/2.3 Ah for TIM 4R-IE	<b>6ES7971-0BA00</b>	<b>Connecting cable</b> For connecting a TIM (RS 485) with a SINAUT ST7 MD2, MD3 or MD4 (RS 485) modem; cable length 1.5 m	<b>6NH7701-4DL</b>
<b>IE FC TP Standard Cable GP 2 x 2 (Type A)</b> 4-core, shielded TP installation cable for connection to IE FC Outlet RJ45/IE FC RJ45 Plug; PROFINET-compatible; with UL approval; sold by the meter; max. length 1 000 m, minimum order quantity 20 m	<b>6XV1840-2AH10</b>	<b>Connecting cable</b> For connecting a TIM (RS 232) with the GSM modem MD720-3; also suitable for third-party modems or radio equipment with standard RS 232 interface; cable length 2.5 m	<b>6NH7701-5AN</b>
<b>IE FC RJ45 Plug 180</b> RJ45 plug-in connector for Industrial Ethernet with a rugged metal housing and integrated insulation displacement contacts for connecting Industrial Ethernet FC installation cables; with 180° cable outlet; for network components and CPs/CPUs with Industrial Ethernet interface <ul style="list-style-type: none"> <li>• 1 pack = 1 unit</li> <li>• 1 pack = 10 units</li> <li>• 1 pack = 50 units</li> </ul>	<b>6GK1901-1BB10-2AA0</b> <b>6GK1901-1BB10-2AB0</b> <b>6GK1901-1BB10-2AE0</b>	<b>Connecting cable</b> with one end open for connecting a TIM (RS 232) to a third-party modem or radio unit (RS 232); cable length 2.5 m	<b>6NH7701-4BN</b>
		<b>Connecting cable</b> For connecting two TIM modules via their RS 232 interface without modems ("null modem"); cable length 6 m	<b>6NH7701-0AR</b>
		<b>SITOP compact 24 V/0.6 A</b> 1-phase power supply with wide-range input 85 ... 264 V AC/110 ... 300 V DC, stabilized output voltage 24 V, rated output current value 0.6 A, slim design	<b>6EP1331-5BA00</b>

## Industrial Remote Communication

### TeleControl Professional Stations for DNP3 protocol

#### Introduction

#### Overview

DNP3 (**D**istributed **N**etwork **P**rotocol) is a standardized, manufacturer-independent telecontrol protocol.

To implement a telecontrol system with DNP3 protocol, substations (RTU) can be set up based on SIMATIC. The CP 1243-1 DNP3 for SIMATIC S7-1200 and the Telecontrol Interface Modules (TIM) for SIMATIC S7-300/400 are offered for this.

#### Telecontrol communications processors

##### CP 1243-1 DNP3



The CP 1243-1 DNP3 (DNP3 protocol) is an Industrial Remote Communication module for the telecontrol substation with SIMATIC S7-1200. It has an RJ45 interface, which allows communication over IP-based networks.

#### The TIM telecontrol communications module

##### TIM 3V-IE DNP3



The TIM 3V-IE DNP3 (DNP3 protocol) is a SINAUT communications module for the telecontrol substation with SIMATIC S7-300 and, as a station module, can be directly connected via the Ethernet to a PC as a DNP3 control center. It has an RS 232 interface to which a suitable external leased-line, radio or analog dialup modem can be connected. It additionally possesses an RJ45 interface, which permits communication over IP-based networks. On the TIM 3V-IE DNP3, both interfaces can be operated simultaneously, e.g. to implement path redundancy to a DNP3 control center.

##### TIM 4R-IE DNP3



The TIM 4R-IE DNP3 (DNP3 protocol) has two RS 232/RS 485 interfaces for data transmission via conventional WANs (copper dedicated line, analog dialup modems, wireless) and two additional RJ45 interfaces for connection to IP-based networks (WAN or LAN).

This TIM can be used as a communication processor in a SIMATIC S7-300, but it is especially suitable as a telecontrol module for a SIMATIC S7-400 or SIMATIC S7-400H. In this case it is connected to the S7-CPU as stand-alone device via one of its two Ethernet interfaces. The module can be configured as a station, node or master module. As a station module, it can be directly connected to a PC over Ethernet as a DNP3 control center.

The four transmission paths can all be different and operated independently of one another, but also in any redundant combination.

## Design

### Configuration examples

S7-1200 substations can be connected to a DNP3-capable control center using CP 1243-1 DNP3 over the Industrial Ethernet interface and an external router, e.g. SCALANCE M via a WAN network.

S7-300 or S7-400 substations can be connected to a WAN via the isolated serial interfaces of the TIM DNP3 modules, and specifically via different data communication devices depending on the application:

- Dedicated line modems for point-to-point, point-to-multipoint or line connections
- Fiber-optic cable modules (via RS485 converters)
- Wireless devices from various manufacturers

S7-1200, S7-300 or S7-400 substations can be connected to Ethernet, i.e. to IP-based networks (LAN, IWLAN, DSL, GPRS, etc.) via the RJ45 interfaces of the DNP3 modules.

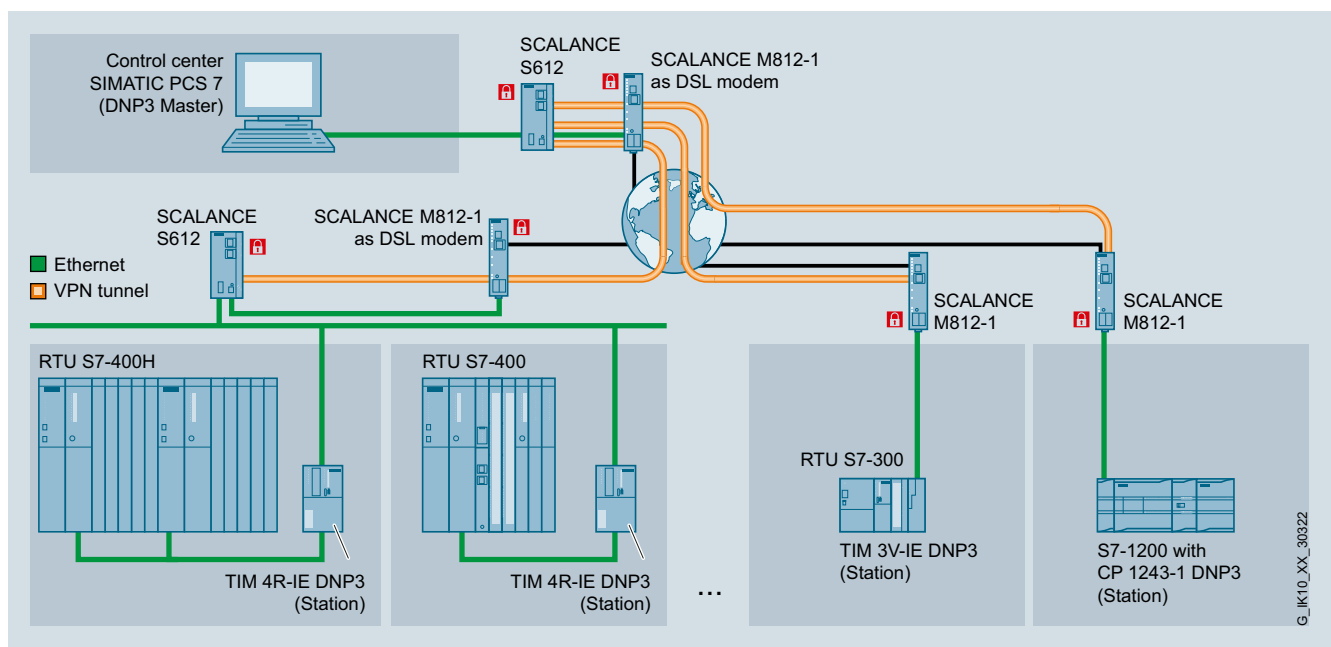

CP 1243-1 DNP3 with PCS 7 control center

## Industrial Remote Communication

### TeleControl Professional Stations for DNP3 protocol

#### CP 1243-1 DNP3

#### Overview



The CP 1243-1 DNP3 communications processor is used to connect a SIMATIC S7-1200 to a control center system via the DNP3 protocol and has the following characteristics:

- Support for the established DNP3 telecontrol protocol for standardized linking of the SIMATIC S7-1200 to WinCC, PCS 7, or other commercially available control center systems
- Data transfer of measured values, control variables, or alarms optimized for telecontrol systems
- Automatic sending of alert emails
- Clearly laid out LED signaling for fast and easy diagnostics
- Compact industrial enclosure in S7-1200 design for mounting on a standard mounting rail
- Fast commissioning thanks to easy configuration using STEP 7
- Data buffering of up to 64 000 values ensures a secure database even with temporary connection failures

#### Benefits



- **Data security**  
The CP 1243-1 DNP3 has a large buffer for several thousand data values. Downtimes in the transmission link can then be bridged.
- **Fully automatic time stamp**  
To enable subsequent and correct archiving of process data in the control system, all data frames are assigned with a time stamp at their place of origin.
- **Fast and flexible data communication**  
Operators are therefore quickly provided with alarms, statuses and values from the process, and they can influence process control by entering commands or setpoints at any time.
- **Simple and low-cost engineering**  
The cyclic or event-controller transfer of measurements, setpoints or alarms can be implemented in only a few operations and without programming effort.
- **Remote diagnostics**  
Saving of traveling and maintenance costs due to cost-effective remote programming, diagnostics, control and monitoring via the Internet

#### Application

- Plants in water, wastewater or environmental sectors:
  - Irrigation systems
  - Drinking water supply
- Monitoring of power networks for consumption metering and cost control
  - District heating networks
  - Wind farms
- Plants in the oil and gas sector
  - Oilfield water injection
  - Pipelines

By using the CP 1243-1 DNP3, the S7-1200 can be used as a remote terminal unit (substation) in telecontrol applications. Typical uses include the collection of measured values in geographically widely distributed outdoor areas (level measurement for water tanks) or centralized opening and closing of valves (oil/gas transport in pipelines).

#### Design

The CP 1243-1 DNP3 offers all the advantages of the S7-1200 design:

- Rugged, compact plastic enclosure
- Easily accessible connection and diagnostics elements, protected by front flaps
- Simple mounting on the mounting rail of the S7-1200

The CP 1243-1 DNP3 is plugged into the left-hand system bus interface of the S7-1200. Power is supplied directly via the S7-1200. No additional wiring is necessary. Any required modems or routers are connected via the Ethernet interface on the underside of the module.



## Function

The CP 1243-1 DNP3 is a communication module for the S7-1200. The module allows the S7-1200 to be connected as a remote station to a DNP3-based control center in just a few steps.

### **Completely configurable application through "data point configuration"**

The introduction of the "data point configuration" in STEP 7 dispenses with all programming effort for transfer of data to the control center.

The data of the CPU relevant to the control center is selected via user-friendly "item browsing" in STEP 7. In a clearly-arranged menu, the data transfer parameters are then assigned to the data points selected in this way. The cyclic or event-controller transfer of measurements, setpoints or alarms can thus be implemented in only a few operations and without programming effort.

### **Data backup**

Data losses are prevented by the data buffering mechanisms integrated in the product.

In the event of a connection failure, up to 64 000 time-stamped values are buffered. When the connection returns, the buffered values are automatically transferred to the control center in the right order.

### **E-mail alerting**

Alert e-mails can be configured for timely provision of stations' states to service or maintenance personnel. If previously defined events (such as threshold violation) should occur, application-specific information is sent automatically by e-mail.

### **Diagnostics**

The CP 1243-1 DNP3 offers comprehensive diagnostic options for a quick and informative analysis of the station status. Elementary diagnostic information about the connection to the control center is signaled directly via LEDs at the CP.

Using STEP 7, comprehensive information can be retrieved, such as connection history, buffer status, and the transferred measured values.

### **DNP3 protocol**

Communication with the control center is based on the established standard of DNP3 specification 2 (2007/2009).

Thanks to support of the object and data transfer mechanisms defined in the specification, compatibility with PCS 7, WinCC (with applicable telecontrol packages), and all other control center systems available on the market is warranted.

The security mechanisms already defined in the DNP3 standard for secure data transfer through trunk networks are fully supported.

### **Remote maintenance**

For remote access from the control center to the substation, the CP provides a remote maintenance port in parallel with process operation. This ensures access for monitoring and program changes.

### **Interfaces**

The CP 1243-1 DNP3 has an Ethernet interface to connect to the control center. The S7-1200 can be connected via an existing network or via other media by using additional routers (e.g. SCALANCE M for mobile wireless communication).

### **Power supply**

Extra wiring for the CP power supply is not required. Power is supplied directly via the backplane bus of the S7-1200.

# Industrial Remote Communication

## TeleControl Professional Stations for DNP3 protocol

### CP 1243-1 DNP3

#### Integration

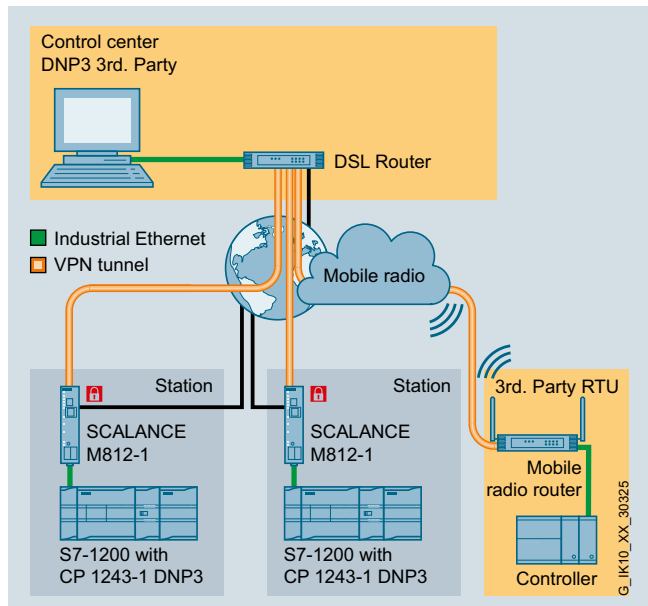

CP 1243-1 DNP3 with 3rd-party control center

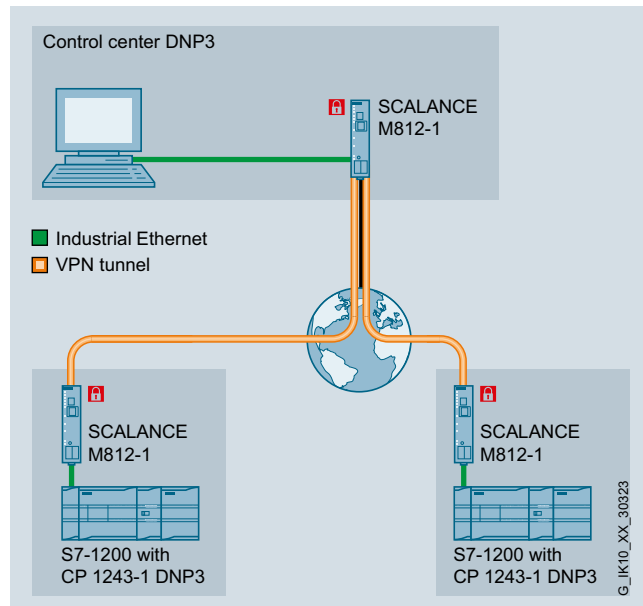

CP 1243-1 DNP3: Integration in existing telecontrol systems

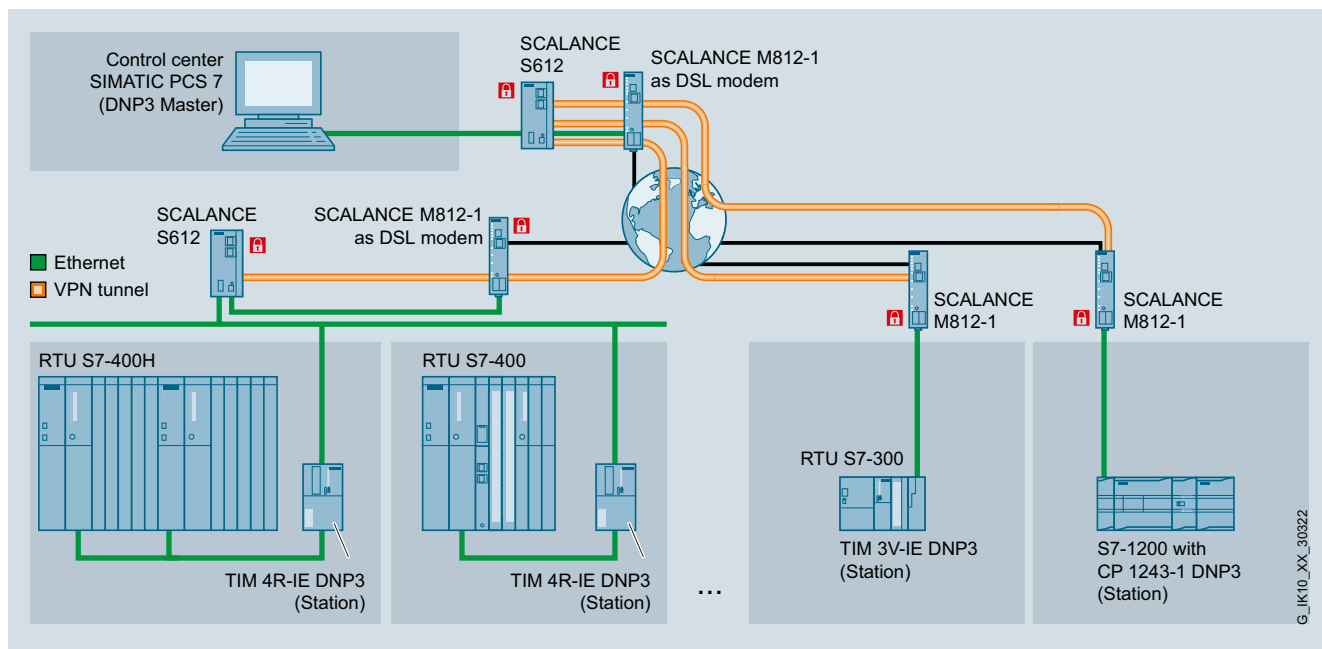

CP 1243-1 DNP3 with PCS 7 control center

7

#### Technical specifications

Article No.	6GK7243-1JX30-0XE0
Product-type designation	CP 1243-1 DNP3
<b>Transmission rate</b>	
Transfer rate at the interface 1	10 ... 100 Mbit/s
<b>Interfaces</b>	
Number of electrical connections at interface 1 in accordance with Industrial Ethernet	1
Design of electrical connection at interface 1 in accordance with Industrial Ethernet	RJ45 port
<b>Supply voltage, current consumption, power loss</b>	
Type of supply voltage	DC
Supply voltage 1 from backplane bus	5 V
Consumed current from backplane bus at 5 V for DC Typical	0.25 A
Resistive loss	1.25 W
<b>Permitted ambient conditions</b>	
Ambient temperature	
• for vertical installation during operating phase	-20 ... +60 °C
• for horizontal installation during operating phase	-20 ... +70 °C
• during storage	-40 ... +70 °C
• during transport	-40 ... +70 °C
Relative humidity at 25 °C without condensation during operating maximum	95 %
Protection class IP	IP20
<b>Design, dimensions and weight</b>	
Module format	Compact module S7-1200 single width
Width	30 mm
Height	110 mm
Depth	75 mm
Net weight	0.122 kg
Mounting type	
• 35 mm DIN rail mounting	Yes
• wall mounting	Yes
<b>Product properties, functions, components general</b>	
Number of modules	
• per CPU maximum	3

Article No.	6GK7243-1JX30-0XE0
Product-type designation	CP 1243-1 DNP3
<b>Performance data</b>	
<u>Performance data S7 communication</u>	
Number of possible connections for S7 communication note	like CPU
<u>Performance data telecontrol</u>	
Suitability for use	
• node station	No
• substation	Yes
• control center	No
• note	-
Connection to the control center	control center with DNP3 function
• note	Connection to Scada system using DNP3 services supported
• by means of a permanent connection	-
• by means of demand-oriented connection	-
Protocol is supported	
• DNP3	Yes
• IEC 60870-5	No
Product function data buffering if connection is aborted	Yes
• note	64 000 values
Number of data points per station maximum	200
<u>Performance data Teleservice</u>	
Diagnostic function online diagnostics with SIMATIC STEP 7	Yes
Product function	
• program download with SIMATIC STEP 7	Yes
• remote firmware update	Yes
<b>Product functions management, configuration</b>	
Configuration software required	
<b>Product functions Time</b>	
Protocol is supported NTP	No

#### Ordering data

##### CP 1243-1 DNP3 communications processor

Communications processor for connecting SIMATIC S7-1200 to a control center via the DNP3 protocol

#### Article No.

**6GK7243-1JX30-0XE0**

#### More information

##### Technical requirements/compatibility

An S7-1200 CPU with firmware version 3 is required for operating the CP 1243-1 DNP3.

The CP 1243-1 DNP3 is configured using STEP 7 V12 SP1 and higher.

To connect to PCS 7/WinCC control center systems, the relevant telecontrol packages to support the DNP3 protocol are required.

## Industrial Remote Communication

### TeleControl Professional Stations for DNP3 protocol

#### TIM 3V-IE DNP3

#### Overview



In a station for the S7-CPU, the new communication module TIM 3V-IE DNP3 V3.0 (**TeleControl Interface Module**) handles the data exchange with the assigned master system SIMATIC PCS 7 TeleControl V8.0 using the open DNP3 protocol. In addition, the V3.0 module now also supports master and node functionality.

- With the S7-300 housing, the module can be fully integrated into the S7-300 system
- The module has an RS 232 interface for the connection of an external modem for data transmission via a conventional WAN or the connection of a Modbus RTU slave to an S7-300 system
- The RJ45 port is used for data transmission via IP-based networks

#### Benefits

**get** Designed for Industry

- Flexible option for connection to any conventional or IP-based WAN
- Connection to DNP3 master systems from third-party vendors is possible by using the open protocol DNP3
- Saving of traveling and maintenance costs due to cost-effective remote programming, diagnostics, control and monitoring via the Internet
- Reduction in time and costs thanks to quick and user-friendly configuration of connections and data to be transferred with the SINAUT configuration software and block library
- Reliable back-up of important data: Storage of the DNP3 data points (max. 64 000 in the case of a master), including time stamp on the TIM if the communication path is faulty or a partner has failed

#### Application

- Low-cost automation of water/wastewater networks with both complex and simple structures
- Control and monitoring of energy distribution systems and supply stations, such as oil, gas or district heating networks
- Preventive maintenance (condition monitoring) of globally distributed systems
- Connection of plants with basic or high-level security and availability requirements
- Use in hybrid networks with dial-up, wireless, Ethernet or Internet communications

#### Design

The TIM 3V-IE DNP3 offers all the advantages of the SIMATIC S7-300 design:

- Compact design with S7-300 format
- 9-pin sub-D connectors with an RS232 interface for connection to a conventional WAN via an appropriate modem
- RJ45 socket for connection to Industrial Ethernet or an IP-based network; industrial design with additional retaining collar, for connecting the IE FC RJ45 Plug 180
- 2-pin plug-in terminal strip for connection of the 24 V DC external supply voltage
- Front-panel LEDs for indicating the module status and the communication
- Easy installation; the TIM 3V-IE DNP3 is mounted on the DIN rail of the S7-300 and connected to adjacent modules by means of the bus connector supplied with the TIM. No slot rules apply.
- Can be operated in the expansion rack (ER) in conjunction with the IM 360/361 interface modules
- Can be operated without a fan
- No backup battery or memory module is required

#### Function

- Data is transmitted using the open DNP3 protocol
- Media redundancy by using physically separated connection paths without data loss at switchover
- Extensive diagnostics functions including the option of logging the sent and received message frames
- Time-of-day synchronization with the assigned DNP3 master system is possible
- Remote programming in the case of IP-based networks
- Modbus RTU Master

#### Function (continued)

Also available with the new Version 3.0

- DNP3 Master
- DNP3 nodes; the module operates simultaneously as master and slave and, as a data concentrator, links the RTUs with the control center
- Peer-to-peer communication in the Ethernet-based network between the TIM modules used as DNP3 slave
- Setting of DNP3 event classes (Class 1, Class 2 and Class 3)
- Routing between TIM modules
- Support of analog dialup modems (PSTN dialup)

The TIM 3V-IE DNP3 communications module has its own processor and a RAM for buffering up to 64 000 data points. This prevents any loss of data in the event of a fault on the communication link or the failure of a communication partner.

#### Diagnostics

The SINAUT diagnostics and service tool of the SINAUT ST7 Engineering Software V5.4 provides comprehensive diagnostic functions, including:

- Operating status of the TIM module
- Module status of the TIM module
- General diagnostic information
- Diagnostic buffer of the TIM module
- Status of the connections to remote communication partners
- Status and level of the transmit buffer
- TIM frame monitor for recording the frame traffic

#### Configuration

The SINAUT ST7 engineering software V5.4 is used for configuring the TIM 3V-IE DNP3 module. Parameters are assigned with the aid of the SINAUT configuration software in STEP 7 HW Config and STEP 7 Netpro.

#### Integration

By means of a floating RS232 interface, the TIM 3V-IE DNP3 module is connected to a WAN, and specifically via various data communication devices depending on the application:

- Dedicated line modems for point-to-point, point-to-multipoint or line connections
- Analog dialup modems (V3.0 or higher)
- Fiber-optic cable modules (via RS485 converters)
- Wireless devices from various manufacturers

In addition, it is possible to connect a Modbus RTU slave to the S7-300 system via the TIM 3V-IE DNP3.

Via the RJ45 interface, the TIM 3V-IE DNP3 module can be connected to the Ethernet, i.e. to IP-based networks (LAN, IWLAN, DSL, GPRS, UMTS, etc.).

#### Configuration examples in conventional and IP-based WAN

##### Use in a station with transmission via a dedicated line network

The connection to the master station is via the MD2 modem, which sets up the connection via a dedicated line.

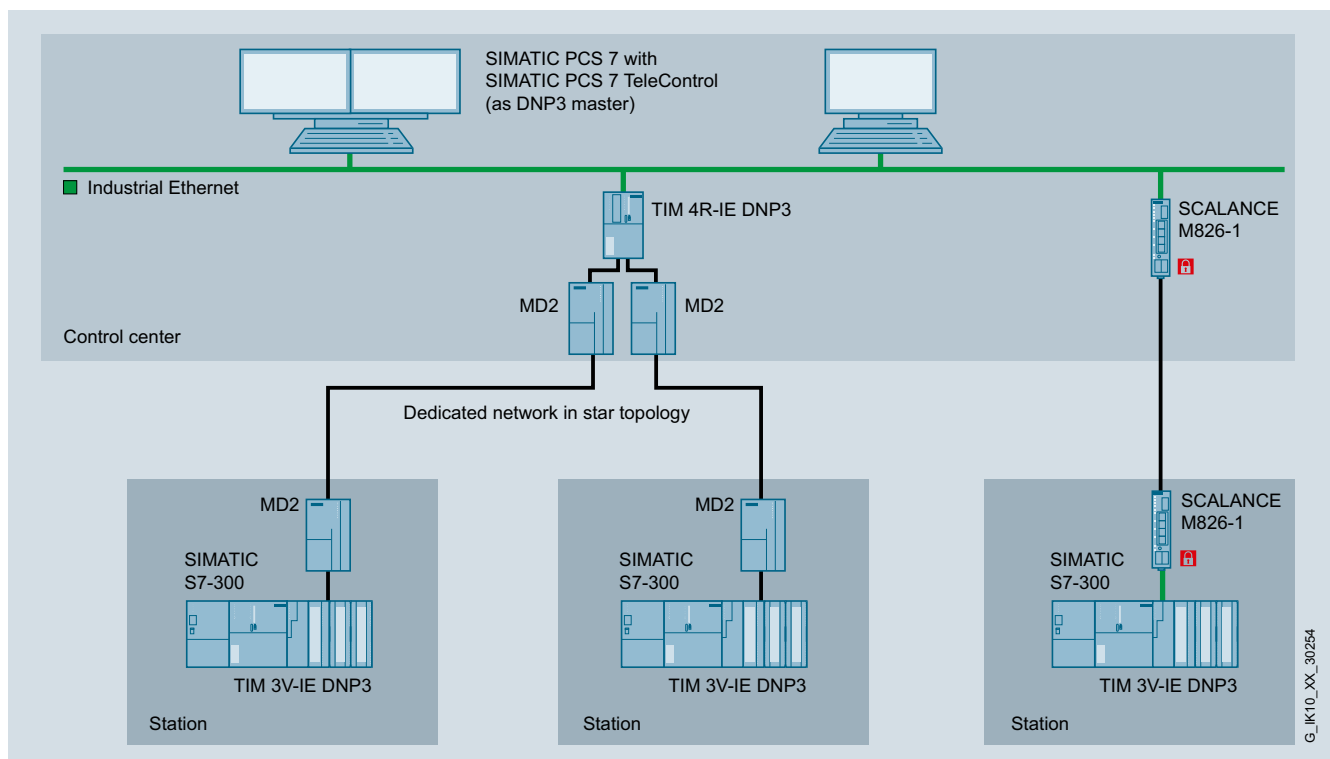

## Industrial Remote Communication

### TeleControl Professional Stations for DNP3 protocol

#### TIM 3V-IE DNP3

##### Integration (continued)

###### Use in a station with transmission via Internet

The stations are connected by means of an Internet connection. In this case, DSL routers must be used in the station and control center – preferably in combination with SCALANCE S in order to establish secure connections using VPN tunnels.

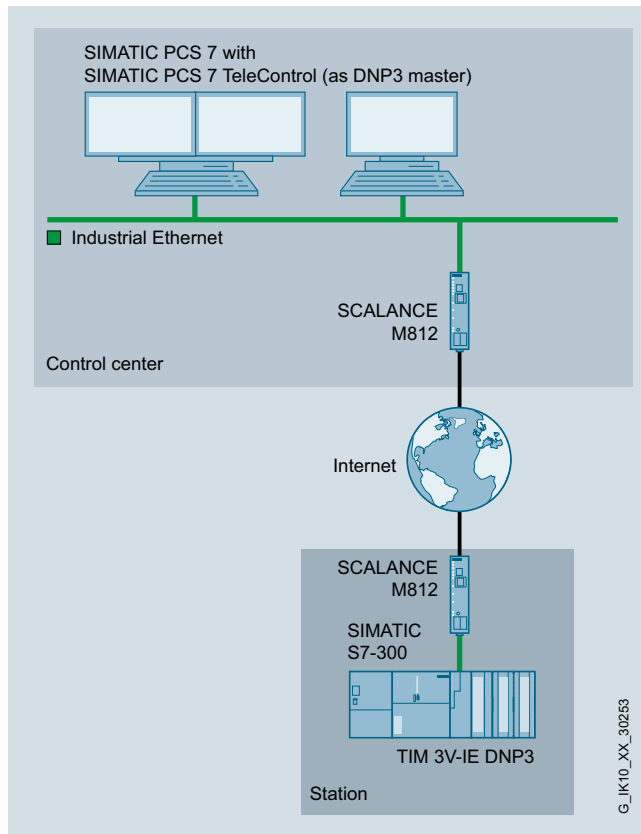

###### Use in a station with transmission over the GSM mobile telephone service GPRS or UMTS

The stations are connected via the GSM mobile telephone service GPRS. In this case the GPRS router SCALANCE M874-2 is used in the station and a SCALANCE S security module is used in the control center. This ensures that the VPN connections to the GPRS stations are set up.

For higher data rates, in place of the GPRS router SCALANCE M874-2, the UMTS router SCALANCE M874-3 can be implemented for use of the UMTS mobile wireless network.

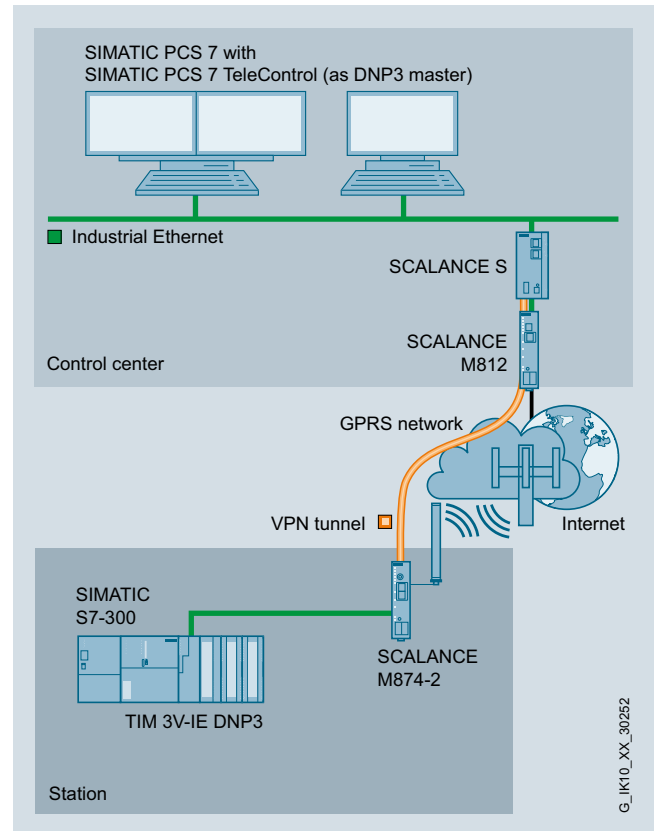

#### Technical specifications

Article No.	6NH7803-3BA00-0AA0
Product-type designation	TIM 3V-IE DNP3
<b>Transmission rate</b>	
Transfer rate	
• for Industrial Ethernet	10 ... 100 Mbit/s
• in accordance with RS 232	9 600 ... 38 400 bit/s
<b>Interfaces</b>	
Number of interfaces according to Industrial Ethernet	1
Number of electrical connections	
• for external data transmission in accordance with RS 232	1
• for power supply	1
Design of electrical connection	
• the Industrial Ethernet Interface	RJ45 port
• at interface 1 for external data transmission	9-pin Sub-D connector (RS232)
• at interface 2 for external data transmission	-
• for power supply	2-pin, plug-in terminal strip
design of the removable storage C-PLUG	No
<b>Supply voltage, current consumption, power loss</b>	
Type of supply voltage	DC
Supply voltage	24 V
• minimum	20.4 V
• maximum	28.8 V
Consumed current	
• from backplane bus at 24 V for DC maximum	0.2 A
• from external supply voltage at 24 V with DC maximum	0.2 A
Resistive loss	5.8 W
Product expansion optional backup battery	No
Type of battery	-
Backup current	
• typical	-
• maximum	-
<b>Permitted ambient conditions</b>	
Ambient temperature	
• during operating	0 ... 60 °C
• during storage	-40 ... +70 °C
• during transport	-40 ... +70 °C
Relative humidity at 25 °C without condensation during operating maximum	95 %
Protection class IP	IP20
<b>Design, dimensions and weight</b>	
Module format	Compact module S7-300 single width
Width	40 mm
Height	125 mm
Depth	120 mm
Net weight	0.25 kg

Article No.	6NH7803-3BA00-0AA0
Product-type designation	TIM 3V-IE DNP3
<b>Product properties, functions, components general</b>	
Number of modules note	Number of TIMs per S7-300: 1
Cable length	
• with RS 232 interface maximum	6 m
• with RS 485 interface maximum	-
<b>Performance data</b>	
<u>Performance data S7 communication</u>	
Number of possible connections for S7 communication	
• maximum	3
• with PG connections maximum	2
• with OP connections maximum	1
• note	only via LAN
Service	
• SINAUT ST7 through S7 communication	-
• PG-/OP-communication	Yes
<u>Performance data multi-protocol mode</u>	
Number of active connections with multiprotocol mode	-
<u>Performance data telecontrol</u>	
Suitability for use	
• node station	Yes
• substation	Yes
• control center	Yes
• note	-
Protocol is supported	
• TCP/IP	Yes
• DNP3	Yes
• SINAUT ST1 protocol	No
• SINAUT ST7 protocol	No
Number of DNP3 masters	
• with Ethernet maximum	8
• with RS 232 interface maximum	1
Product function data buffering if connection is aborted	Yes
• note	64 000 data points with one master
<b>Product functions management, configuration</b>	
Configuration software required	SINAUT ST7 ES
Storage location of TIM configuration data	On the CPU or TIM

# Industrial Remote Communication

## TeleControl Professional

### Stations for DNP3 protocol

#### TIM 3V-IE DNP3

#### Ordering data

##### TIM 3V-IE DNP3 communications module

With an RS232 interface for SINAUT communication via a conventional WAN and an IP-based network (WAN or LAN)

##### SINAUT Engineering Software V5.4

On CD-ROM, comprising

- SINAUT ST7 Engineering Software V5.4 for the PG
- SINAUT TD7 block library
- Electronic manual in German and English

#### Accessories

##### IE FC TP Standard Cable GP 2 x 2 (Type A)

4-core, shielded TP installation cable for connection to IE FC Outlet RJ45/IE FC RJ45 Plug; PROFINET-compatible; with UL approval; sold by the meter; max. length 1 000 m, minimum order quantity 20 m

##### IE FC RJ45 Plug 180

RJ45 plug-in connector for Industrial Ethernet with a rugged metal housing and integrated insulation displacement contacts for connecting Industrial Ethernet FC installation cables; with 180° cable outlet; for network components and CPs/CPUs with Industrial Ethernet interface

- 1 pack = 1 unit
- 1 pack = 10 units
- 1 pack = 50 units

#### Article No.

6NH7803-3BA00-0AA0

6NH7997-0CA54-0AA0

6XV1840-2AH10

6GK1901-1BB10-2AA0

6GK1901-1BB10-2AB0

6GK1901-1BB10-2AE0

#### Article No.

##### IE FC Stripping Tool

Preadjusted stripping tool for fast stripping of the Industrial Ethernet FC cables

##### Connecting cable

For connecting a TIM (RS 232) with a SINAUT ST7 MD2, MD3 or MD4 (RS 232) modem; cable length 1.5 m

##### Connecting cable

For connecting a TIM (RS 232) with the GSM modem MD720-3; also suitable for third-party modems or radio equipment with standard RS 232 interface; cable length 2.5 m

##### Connecting cable

with one end open for connecting a TIM (RS 232) to a third-party modem or radio unit (RS 232); cable length 2.5 m

##### Connecting cable

For connecting two TIM modules via their RS 232 interface without modems ("null modem"); cable length 6 m

6GK1901-1GA00

6NH7701-4AL

6NH7701-5AN

6NH7701-4BN

6NH7701-0AR



## Overview



In a station for the S7-CPU, the communication module TIM 4R-IE DNP3 (**T**ele**C**ontrol **I**nterface **M**odule) handles the data exchange with the assigned SIMATIC PCS7 TeleControl V8.0 master system using the open DNP3 protocol. In addition, the V3.0 module now also supports master and node functionality.

- With the double-width S7-300 housing, the module can be fully integrated into the S7-300 system
- Can be connected as a stand-alone module to a SIMATIC S7-400 and SIMATIC S7-400 H System
- Two RS 232/RS 485 interfaces support connection of an external modem for data transmission via a conventional WAN or of a Modbus RTU slave to an S7-300 system
- The module has two RJ45 interfaces for data transmission via IP-based networks
- By using physically separate connection paths, the module permits media redundancy without loss of data during the switchover

## Benefits

get **Designed for Industry**

- High plant availability by means of end-to-end redundancy
- Connection to DNP3 master systems from third-party vendors is possible by using the open protocol DNP3
- Saving of traveling and maintenance costs due to cost-effective remote programming, diagnostics, control and monitoring via the Internet
- Reduction in time and costs thanks to quick and user-friendly configuration of connections and data to be transferred with the SINAUT configuration software and block library
- Reliable back-up of important data; Storage of the DNP3 data points (max. 200 000 in the case of a master), including time stamp on the TIM if the communication path is faulty or a partner has failed

## Application

- Low-cost automation of water/wastewater networks with both complex and simple structures
- Control and monitoring of energy distribution systems and supply stations, such as oil, gas or district heating networks
- Preventive maintenance (condition monitoring) of globally distributed systems
- Connection of plants with basic or high-level security and availability requirements
- Use in hybrid networks with wireless, Ethernet or Internet communications

## Design

The TIM 4R-IE DNP3 offers all the advantages of the SIMATIC S7-300 design:

- Compact design with double-width S7-300 format
- Two 9-pin sub-D connectors with a combined RS232/RS485 interface for connection to a conventional WAN via an appropriate modem
- Two RJ45 sockets for connection to Industrial Ethernet or an IP-based network; industrial design with additional retaining collar, for connecting the IE FC RJ45 Plug 180
- 2-pin plug-in terminal strip for connection of the 24 V DC external supply voltage
- Front-panel LEDs for indicating the module status and the communication
- Easy installation; the TIM 4R-IE DNP3 is mounted on the DIN rail of the S7-300 and connected to adjacent modules by means of the bus connector supplied with the TIM. No slot rules apply. For connection of an S7-400 station, it is linked as a stand-alone device via one of its Ethernet ports with one or more S7-400 CPUs.
- Can be operated in the expansion rack (ER) in conjunction with the IM 360/361 interface modules
- Can be operated without a fan
- A backup battery and a memory module (C-PLUG) can be installed as options

## Industrial Remote Communication

### TeleControl Professional

### Stations for DNP3 protocol

#### TIM 4R-IE DNP3

##### Function

- Data is transmitted using the open DNP3 protocol
- Media redundancy by the use of physically separated connection paths without the loss of data when switching over
- Extensive diagnostics functions including the option of logging the sent and received message frames
- Time-of-day synchronization with the assigned DNP3 master system is possible
- Remote programming in the case of IP-based networks
- Option for connecting a SIMATIC S7-400 and SIMATIC S7-400 H system
- Modbus RTU Master connected to a serial port

Also available with the new Version 3.0

- DNP3 Master
- DNP3 nodes; the module operates simultaneously as master and slave and, as a data concentrator, links the RTUs with the control center
- Peer-to-peer communication in the Ethernet-based network between the TIM modules used as DNP3 slaves
- Setting of DNP3 event classes (Class 1, Class 2 and Class 3)
- Routing between TIM modules
- Support of analog dialup modems (PSTN dialup)

The communications module TIM 4R-IE DNP3 has its own processor and a RAM for buffering up to 200 000 data points. This prevents any loss of data in the event of a fault on the communication link or the failure of a communication partner.

##### Diagnostics

The SINAUT diagnostics and service tool of the SINAUT ST7 Engineering Software V5.4 provides comprehensive diagnostic functions, including:

- Operating status of the TIM module
- Module status of the TIM module
- General diagnostic information
- Diagnostic buffer of the TIM module
- Status of the connections to remote communication partners (e.g. SIMATIC PCS7 TeleControl V7.1 SP2)
- Status and level of the transmit buffer
- TIM frame monitor for recording the frame traffic

##### Configuration

The SINAUT configuration software V5.4 is used for configuring the TIM 4R-IE DNP3 module. Parameters are assigned with the aid of the SINAUT configuration software in STEP 7 HW Config and STEP 7 Netpro.

##### Integration

The TIM 4R-IE DNP3 module is connected to a WAN via two floating RS232/RS485 interfaces, and specifically via various data communication devices depending on the application:

- Dedicated line modems for point-to-point, point-to-multipoint or line connections
- Analog dialup modems (V3.0 or higher)
- Fiber-optic cable modules (via RS485 converters)
- Wireless devices from various manufacturers

In addition, it is possible to connect a Modbus RTU slave to the S7-300 system via the TIM 4R-IE DNP3.

Via two RJ45 interfaces, the TIM 4R-IE DNP3 module can be connected to the Ethernet, i.e. to IP-based networks (LAN, IWLAN, DSL, GPRS, UMTS, etc.).

#### Integration (continued)

#### Configuration examples in conventional and IP-based WAN

Use in a station with transmission via a dedicated line network

The connection to the master station is via the MD2 modem, which sets up the connection via a dedicated line.

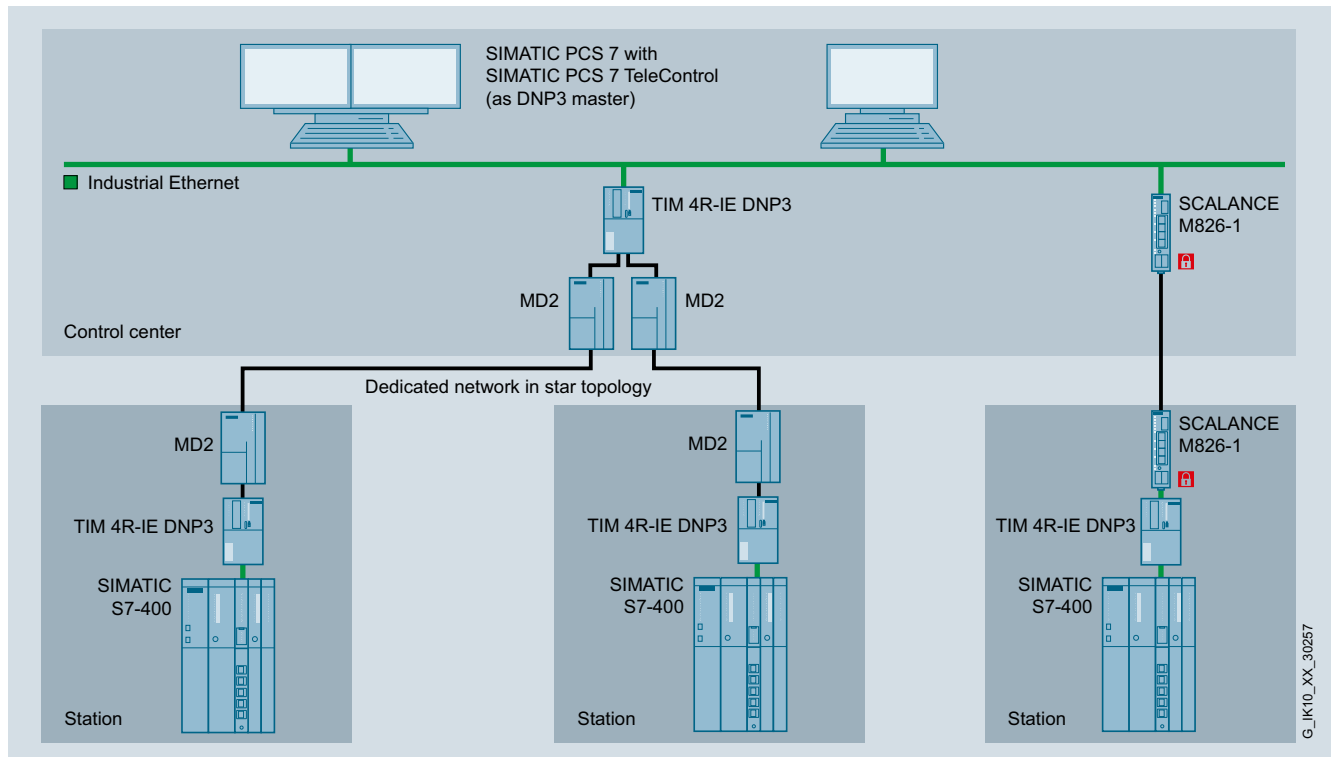

## Industrial Remote Communication

### TeleControl Professional Stations for DNP3 protocol

#### TIM 4R-IE DNP3

##### Integration (continued)

###### Use in a station with transmission via Internet

The stations are connected by means of an Internet connection. In this case, DSL routers must be used in the station and control center – preferably in combination with SCALANCE S in order to establish secure connections using VPN tunnels.

###### Use in a station with transmission over the GSM mobile telephone service GPRS or UMTS

The stations are connected via the GSM mobile telephone service GPRS. In this case the GPRS router MD741-1 is used in the station and a SCALANCE S security module is used in the control center which ensures that the VPN connections are set up with the GPRS stations.

For higher data rates, in place of the GPRS router MD741-1, the UMTS Router SCALANCE M875 can be implemented for use of the UMTS mobile radio network.

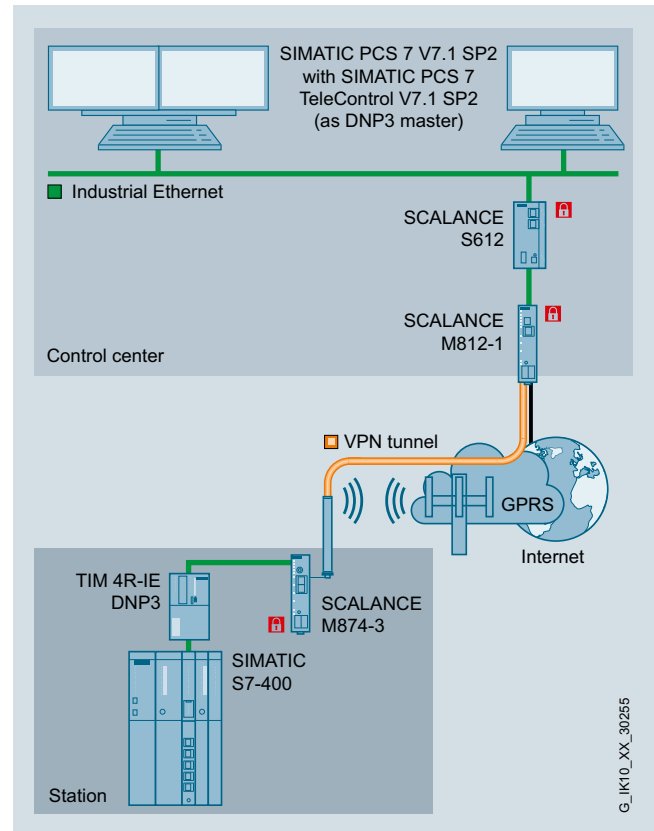
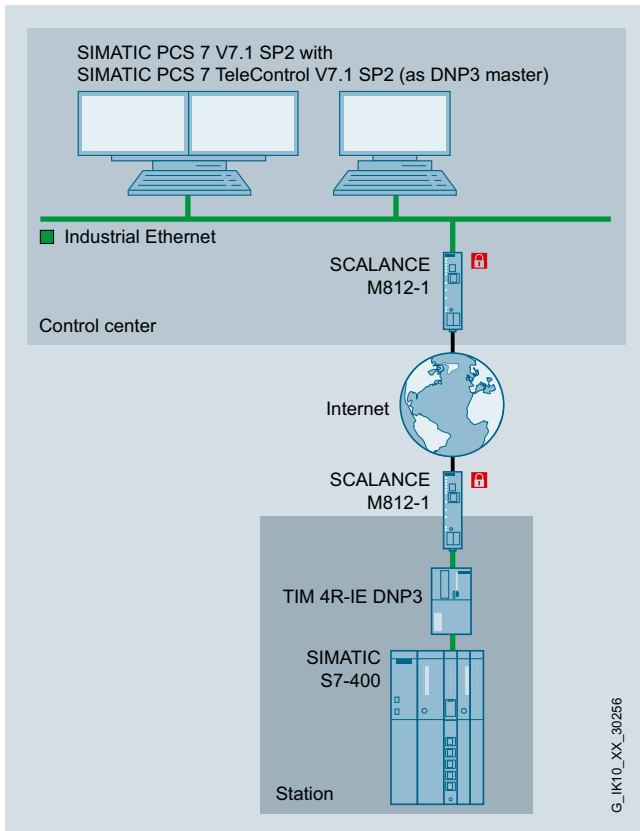

#### Integration (continued)

##### Use in a station with path redundancy

The connection of the stations with a TIM 4R-IE DNP3 enables redundant connection paths to be set up. On the failure of the active connection (e.g. the Internet connection) a switch is made to the second connection path (e.g. WAN).

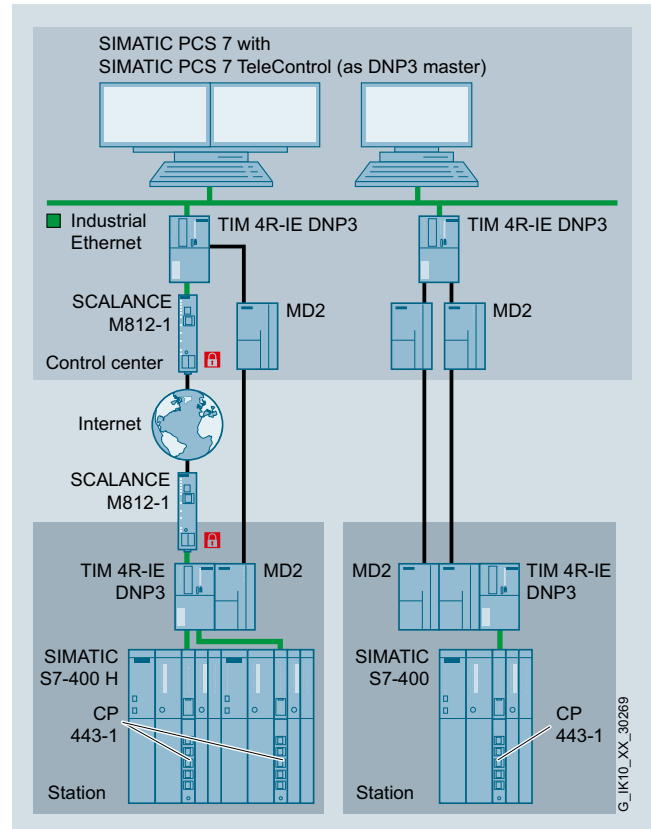

# Industrial Remote Communication

## TeleControl Professional

### Stations for DNP3 protocol

#### TIM 4R-IE DNP3

#### Technical specifications

Article No.	6NH7803-4BA00-0AA0
Product-type designation	TIM 4R-IE DNP3
<b>Transmission rate</b>	
Transfer rate	
• for Industrial Ethernet	10 ... 100 Mbit/s
• in accordance with RS 232	9 600 ... 115 200 bit/s
<b>Interfaces</b>	
Number of interfaces according to Industrial Ethernet	2
Number of electrical connections	
• for external data transmission in accordance with RS 232	2
• for power supply	1
Design of electrical connection	
• the Industrial Ethernet Interface	RJ45 port
• at interface 1	9-pin Sub-D connector, RS232 switchable to RS485
• for external data transmission	
• at interface 2	9-pin Sub-D connector, RS232 switchable to RS485
• for external data transmission	
• for power supply	2-pin, plug-in terminal strip
design of the removable storage C-PLUG	Yes
<b>Supply voltage, current consumption, power loss</b>	
Type of supply voltage	DC
Supply voltage	24 V
• minimum	20.4 V
• maximum	28.8 V
Consumed current	
• from backplane bus at 24 V for DC maximum	0.2 A
• from external supply voltage at 24 V with DC maximum	0.17 A
Resistive loss	4.6 W
Product expansion optional backup battery	Yes
Type of battery	Lithium AA / 3.6 V / 2.3 Ah
Backup current	
• typical	100 µA
• maximum	160 µA
<b>Permitted ambient conditions</b>	
Ambient temperature	
• during operating	0 ... 60 °C
• during storage	-40 ... +70 °C
• during transport	-40 ... +70 °C
Relative humidity at 25 °C without condensation during operating maximum	95 %
Protection class IP	IP20
<b>Design, dimensions and weight</b>	
Module format	Compact module S7-300 double width
Width	80 mm
Height	125 mm
Depth	120 mm
Net weight	0.4 kg

Article No.	6NH7803-4BA00-0AA0
Product-type designation	TIM 4R-IE DNP3
<b>Product properties, functions, components general</b>	
Number of modules note	Number of TIMs per S7-300 / S7-400: 1
Cable length	
• with RS 232 interface maximum	6 m
• with RS 485 interface maximum	30 m
<b>Performance data</b>	
<u>Performance data S7 communication</u>	
Number of possible connections for S7 communication	
• maximum	5
• with PG connections maximum	2
• with OP connections maximum	1
Number of possible connections for S7 communication note	only via LAN
Service	
• SINAUT ST7 through S7 communication	-
• PG-/OP-communication	Yes
<u>Performance data telecontrol</u>	
Acceptability for application	
• node station	Yes
• substation	Yes
• control center	Yes
Suitability for use note	-
Protocol is supported	
• TCP/IP	Yes
• DNP3	Yes
• SINAUT ST1 protocol	No
• SINAUT ST7 protocol	No
Number of DNP3 masters	
• with Ethernet maximum	8
• with RS 232 interface maximum	1
Product function data buffering if connection is aborted	Yes
• note	200 000 data points with one master
<b>Product functions management, configuration</b>	
Configuration software required	
Storage location of TIM configuration data	On the CPU or TIM
<b>Product functions Time</b>	
Product component	Yes
Hardware real-time clock	Yes
Product property battery-backed hardware real-time clock	Yes
Accuracy of hardware real-time clock per day maximum	4 s

Ordering data	Article No.	Article No.
<b>TIM 4R-IE DNP3 communications module</b> With two combined RS 232/RS 485 interfaces for SINAUT communication via conventional WANs and two RJ45 interfaces for SINAUT communication via IP-based networks (WAN or LAN)	<b>6NH7803-4BA00-0AA0</b>	<b>IE FC Stripping Tool</b> Preadjusted stripping tool for fast stripping of the Industrial Ethernet FC cables
<b>SINAUT Engineering Software V5.4</b> On CD-ROM, comprising <ul style="list-style-type: none"> <li>• SINAUT ST7 Engineering Software V5.4 for the PG</li> <li>• SINAUT TD7 block library</li> <li>• Electronic manual in German and English</li> </ul>	<b>6NH7997-0CA54-0AA0</b>	<b>Connecting cable</b> For connecting a TIM (RS 232) with a SINAUT ST7 MD2, MD3 or MD4 (RS 232) modem; cable length 1.5 m
<b>Accessories</b> <b>Backup battery</b> 3.6 V/2.3 Ah for TIM 4R-IE DNP3	<b>6ES7971-0BA00</b>	<b>Connecting cable</b> For connecting a TIM (RS 485) with a SINAUT ST7 MD2, MD3 or MD4 (RS485) modem; cable length 1.5 m
<b>IE FC TP Standard Cable GP 2 x 2 (Type A)</b> 4-core, shielded TP installation cable for connection to IE FC Outlet RJ45/IE FC RJ45 Plug; PROFINET-compatible; with UL approval; sold by the meter; max. length 1 000 m, minimum order quantity 20 m	<b>6XV1840-2AH10</b>	<b>Connecting cable</b> For connecting a TIM (RS 232) with the GSM modem MD720-3; also suitable for third-party modems or radio equipment with standard RS 232 interface; cable length 2.5 m
<b>IE FC RJ45 Plug 180</b> RJ45 plug-in connector for Industrial Ethernet with a rugged metal housing and integrated insulation displacement contacts for connecting Industrial Ethernet FC installation cables; with 180° cable outlet; for network components and CPs/CPU with Industrial Ethernet interface <ul style="list-style-type: none"> <li>• 1 pack = 1 unit</li> <li>• 1 pack = 10 units</li> <li>• 1 pack = 50 units</li> </ul>	<b>6GK1901-1BB10-2AA0</b> <b>6GK1901-1BB10-2AB0</b> <b>6GK1901-1BB10-2AE0</b>	<b>Connecting cable</b> with one end open for connecting a TIM (RS 232) to a third-party modem or radio unit (RS 232); cable length 2.5 m
		<b>Connecting cable</b> For connecting two TIM modules via their RS 232 interface without modems ("null modem"); cable length 6 m
		<b>SITOP compact 24 V/0.6 A</b> 1-phase power supply with wide-range input 85 to 264 V AC/110 to 300 V DC, stabilized output voltage 24 V, rated output current value 0.6 A, slim design
		<b>6EP1331-5BA00</b>

## Industrial Remote Communication

### TeleControl Professional Stations for IEC protocol

#### Introduction

#### Overview

IEC 60870-5-101, IEC 60870-5-103 and IEC 60870-5-104 are standardized vendor-independent protocols.

For implementing an RTU (**R**emote **T**elecontrol **U**nit) with IEC 60870-5 on the basis of SIMATIC, the CP 1243-1 IEC for SIMATIC S7-1200 and the SIPLUS RIC software bundle are offered.

#### **Telecontrol communications processors**

##### CP 1243-1 IEC



The CP 1243-1 IEC (IEC 60870-5-104 protocol) is an Industrial Remote Communication module for telecontrol substations with SIMATIC S7-1200. It has an RJ45 interface, which allows communication over IP-based networks.

##### SIPLUS RIC



With SIPLUS RIC, the IEC protocols can be parameterized with SIMATIC Manager without the need for additional installations.

As a result, SIMATIC controllers can also communicate with non-Siemens products.

The SIPLUS RIC bundles usually comprise:

- CPU
- Interface/communication module (if necessary)
- Memory card
- CD with library and registration code.

SIPLUS RIC products require additional material to establish telecommunication links, e.g. TCP/IP converters – serial, dedicated line modems, media converters, SCALANCE M industrial routers, SCALANCE S security modules, SCALANCE X Ethernet network components, cables etc.



### Overview (continued)

#### Configuration examples

In order to implement telecontrol networks, basic topologies including point-to-point, multi-point, star and ring can be configured using classic or TCP/IP-based media. These can be combined flexibly independent from existing infrastructure.

#### Classic WAN media (IEC 870-5-101 telecontrol protocol)

- Dedicated line via modem, e.g. SINAUT MD2
- Dedicated line over fiber-optic cables
- Private wireless networks

#### TCP/IP-based WAN media (IEC 870-5-104 telecontrol protocol)

- Ethernet networks, e.g. SCALANCE X with fiber-optic cables
- Industrial Wireless LAN with SCALANCE W
- Public networks and internet using SCALANCE M industrial routers
- Satellite communication, e.g. with Inmarsat

S7-1200 substations can be connected to an IEC-capable control center using CP 1243-1 IEC over the Industrial Ethernet interface and an external router, e.g. SCALANCE M via a WAN network.

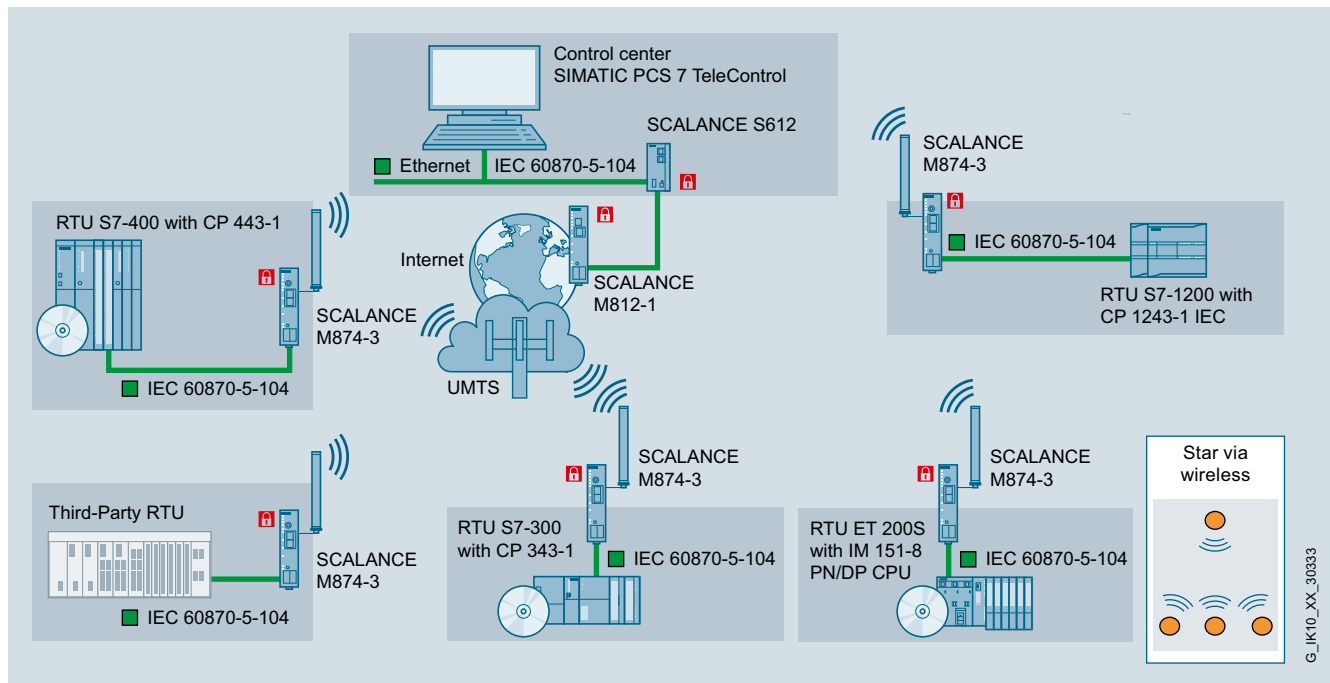

IEC 870-5-104 – example of TCP/IP-based WAN with GPRS radio network (star topology)

## Industrial Remote Communication

### TeleControl Professional Stations for IEC protocol

#### CP 1243-1 IEC

#### Overview



The CP 1243-1 IEC communications processor is used to connect a SIMATIC S7-1200 to a control center system via the IEC 60870 protocol and has the following characteristics:

- Support for the established communication standard in accordance with IEC 60870-5-104 for standardized linking of the SIMATIC S7-1200 to WinCC, PCS 7, or other commercially available control center systems
- Data transfer of measured values, control variables, or alarms optimized for telecontrol systems
- Automatic sending of alert emails
- Clearly laid out LED signaling for fast and easy diagnostics
- Compact industrial enclosure in S7-1200 design for mounting on a standard mounting rail
- Fast commissioning thanks to easy configuration using STEP 7
- Data buffering of up to 64 000 values ensures a secure database even with temporary connection failures

#### Benefits

**get** Designed for Industry

- **Data security**  
The CP 1243-1 IEC has a large buffer for several thousand data values. Downtimes in the transmission link can then be bridged.
- **Fully automatic time stamp**  
To enable subsequent and correct archiving of process data in the control system, all data frames are assigned with a time stamp at their place of origin.
- **Fast and flexible data communication**  
Operators are therefore quickly provided with alarms, statuses and values from the process, and they can influence process control by entering commands or setpoints at any time.
- **Simple and low-cost engineering**  
The cyclic or event-controller transfer of measurements, setpoints or alarms can be implemented in only a few operations and without programming effort.
- **Remote diagnostics**  
Saving of traveling and maintenance costs due to cost-effective remote programming, diagnostics, control and monitoring via the Internet

#### Application

By using the CP 1243-1 IEC, the S7-1200 can be used as a remote terminal unit (substation) in telecontrol applications. Typical uses include the collection of measured values in geographically widely distributed outdoor areas (level measurement for water tanks) or centralized opening and closing of valves (oil/gas transport in pipelines).

- Plants in water, wastewater or environmental sectors:
  - Irrigation systems
  - Drinking water supply
- Monitoring of power networks for consumption metering and cost control
  - District heating networks
  - Wind farms
- Plants in the oil and gas sector
  - Oilfield water injection
  - Pipelines
- Traffic control systems
- Building monitoring
- Weather stations
- Wind energy and photovoltaic plants
- Environmental monitoring equipment
- Intelligent billboards

#### Design

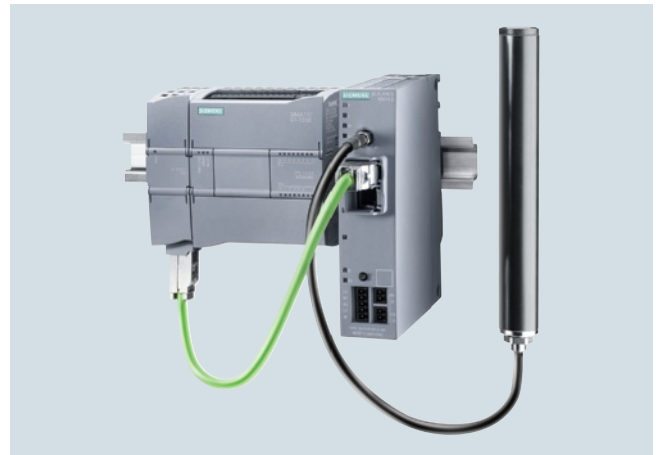

The CP 1243-1 IEC offers all the advantages of the S7-1200 design:

- Rugged, compact plastic enclosure
- Easily accessible connection and diagnostics elements, protected by front flaps
- Simple mounting on the mounting rail of the S7-1200

The CP 1243-1 IEC is plugged into the left-hand system bus interface of the S7-1200. Power is supplied directly via the S7-1200. No additional wiring is necessary. Any required modems or routers are connected via the Ethernet interface on the underside of the module.

## Function

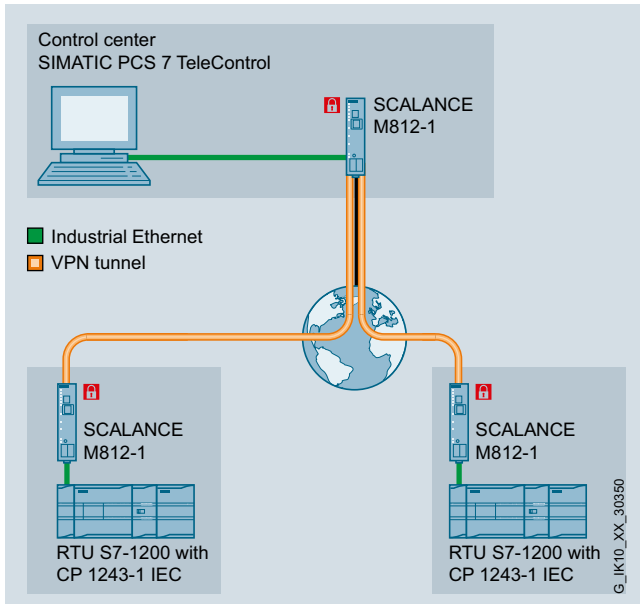

Linking of S7-1200 to PCS 7 via DSL-based IEC connection.

### Completely configurable application through "data point configuration"

The introduction of the "data point configuration" in STEP 7 dispenses with all programming effort for transfer of data to the control center.

The data of the CPU relevant to the control center is selected via user-friendly "item browsing" in STEP 7. In a clearly-arranged menu, the data transfer parameters are then assigned to the data points selected in this way. The cyclic or event-controller transfer of measurements, setpoints or alarms can thus be implemented in only a few operations and without programming effort.

### Data backup

Data losses are prevented by the data buffering mechanisms integrated in the product.

In the event of a connection failure, up to 64 000 time-stamped values are buffered. When the connection returns, the buffered values are automatically transferred to the control center in the right order.

### E-mail alerting

Alert e-mails can be configured for timely provision of stations' states to service or maintenance personnel. If previously defined events (such as threshold violation) should occur, application-specific information is sent automatically by e-mail.

### Diagnostics

The CP 1243-1 IEC offers comprehensive diagnostic options for a quick and informative analysis of the station status. Elementary diagnostic information about the connection to the control center is signaled directly via LEDs at the CP.

Using STEP 7, comprehensive information can be retrieved, such as connection history, buffer status, and the transferred measured values.

### IEC 60870 standard

Communication with the control center is based on the established communication standard in accordance with IEC 60870-5-104. This ensures that telecontrol and instrumentation and control devices and systems from Siemens or other vendors can communicate with each other without any fundamental adaptation developments. The degrees of freedom of the standard allow different vendor-specific profiles (e.g. the frame types and functions used). The profiles can be coordinated with each other with the help of an interoperability list. This standard has become widely used, especially in European and Asian areas. The IEC 60870-5-104 telecontrol protocol is also suitable as a field or station bus. Use as a station bus also enables direct communication between the individual devices.

### Remote maintenance

For remote access from the control center to the substation, the CP provides a remote maintenance port in parallel with process operation. This ensures access for monitoring and program changes.

### Interfaces

The CP 1243-1 IEC has an Ethernet interface for connection to the control center. The S7-1200 can be connected directly via an existing network or via other media by using additional routers (e.g. SCALANCE M for mobile wireless communication).

### Power supply

Extra wiring for the CP power supply is not required. Power is supplied directly via the backplane bus of the S7-1200.

# Industrial Remote Communication

## TeleControl Professional

### Stations for IEC protocol

#### CP 1243-1 IEC

#### Technical specifications

<b>Article No.</b>	<b>6GK7243-1PX30-0XE0</b>
<b>Product-type designation</b>	<b>CP 1243-1 IEC</b>
<b>Transmission rate</b>	
Transfer rate	
• at the interface 1	10 ... 100 Mbit/s
<b>Interfaces</b>	
Number of electrical connections	
• at interface 1 in accordance with Industrial Ethernet	1
Design of electrical connection	
• at interface 1 in accordance with Industrial Ethernet	RJ45 port
<b>Supply voltage, current consumption, power loss</b>	
Type of supply voltage	DC
Supply voltage 1 from backplane bus	5 V
Resistive loss	1.25 W
<b>Permitted ambient conditions</b>	
Ambient temperature	
• for vertical installation during operating phase	-20 ... +60 °C
• for horizontal installation during operating phase	-20 ... +70 °C
• during storage	-40 ... +70 °C
• during transport	-40 ... +70 °C
• Comment	-
Relative humidity at 25 °C without condensation during operating maximum	95 %
Protection class IP	IP20
<b>Design, dimensions and weight</b>	
Module format	Compact module S7-1200 single width
Width	30 mm
Height	110 mm
Depth	75 mm
Net weight	0.122 kg
<b>Product properties, functions, components general</b>	
Number of modules	
• per CPU maximum	3

<b>Article No.</b>	<b>6GK7243-1PX30-0XE0</b>
<b>Product-type designation</b>	<b>CP 1243-1 IEC</b>
<b>Performance data</b>	
<u>Performance data S7 communication</u>	
Number of possible connections for S7 communication	
• note	like CPU
<u>Performance data telecontrol</u>	
Suitability for use	
• node station	No
• substation	Yes
• control center	No
• note	-
Connection to the control center	
• note	
• by means of a permanent connection	supported
Protocol is supported	
• DNP3	No
• IEC 60870-5	Yes
Product function data buffering if connection is aborted	Yes
• note	64 000 values
Number of data points per station maximum	200
<u>Performance data Teleservice</u>	
Diagnostic function online diagnostics with SIMATIC STEP 7	Yes
Product function	
• program download with SIMATIC STEP 7	Yes
• remote firmware update	Yes, CPU V4 or higher
<b>Product functions management, configuration</b>	
Configuration software required	STEP 7 V13 (TIA Portal) and higher
<b>Product functions Time</b>	
Protocol is supported NTP	No

Ordering data	Article No.		Article No.
<b>CP 1243-1 IEC communications processor</b> Communications processor for connecting SIMATIC S7-1200 to a control center via the IEC 60870-5-104 protocol	<b>6GK7243-1PX30-0XE0</b>		
<b>Accessories</b> <b>Compact Switch Module CSM 1277</b> Unmanaged switch for connecting a SIMATIC S7-1200 and up to three further nodes to Industrial Ethernet with 10/100 Mbit/s; 4 x RJ45 ports; external 24 V DC power supply, diagnostics LEDs, S7-1200 module including electronic manual on CD-ROM	<b>6GK7277-1AA10-0AA0</b>		
<b>IE FC RJ45 plugs</b> RJ45 plug connector for Industrial Ethernet with a rugged metal housing and integrated insulation displacement contacts for connecting Industrial Ethernet FC installation cables; with 180° cable outlet; for network components and CPs/CPUs with Industrial Ethernet interface <ul style="list-style-type: none"> <li>• 1 pack = 1 unit</li> <li>• 1 pack = 10 units</li> <li>• 1 pack = 50 units</li> </ul>	<b>6GK1901-1BB10-2AA0</b> <b>6GK1901-1BB10-2AB0</b> <b>6GK1901-1BB10-2AE0</b>		
<b>IE FC TP Standard Cable GP 2 x 2 (Type A)</b> 4-core, shielded TP installation cable for connection to IE FC Outlet RJ45/IE F RJ45 Plug; PROFINET-compatible; with UL approval; sold by the meter; max. length 1 000 m, minimum order quantity 20 m	<b>6XV1840-2AH10</b>		
		<b>Accessories (continued)</b> <b>IE FC stripping tool</b> Preadjusted stripping tool for fast stripping of Industrial Ethernet FC cables	<b>6GK1901-1GA00</b>
		<b>STEP 7 Basic Engineering Software V13 (TIA Portal)</b> <i>Target system:</i> SIMATIC S7-1200, S7-1500, S7-300, S7-400, WinAC <i>Requirement:</i> Windows 7 Professional (64-bit), Windows 7 Enterprise (64-bit), Windows 7 Ultimate SP1 (64-bit), Windows 8.1 (64-bit), Windows 8.1 Professional (64-bit), Windows 8.1 Enterprise (64-bit), Windows Server 2008 R2 StdE (full installation), Windows Server 2012 StdE (full installation) <i>Form of delivery:</i> German, English, Chinese, Italian, French, Spanish <ul style="list-style-type: none"> <li>• STEP 7 Basic V13, Floating License</li> <li>• STEP 7 Basic V13, Trial License</li> <li>• Upgrade STEP 7 Basic V12 to STEP 7 Professional Basic V13, Floating License</li> </ul>	<b>6ES7822-0AA03-0YA5</b> <b>6ES7822-0AA03-0YA7</b> <b>6ES7822-0AA03-0YE5</b>
		<b>Software Update Service</b> For a period of 12 months and for a fixed price, the customer is automatically provided with all upgrades and service packs for each installed software package. The contract is automatically extended by a further year unless canceled at least 12 weeks prior to expiration. Requires the current software version. <ul style="list-style-type: none"> <li>• STEP 7 Basic V1x, Software Update Service Standard 1 year;</li> <li>• STEP 7 Basic V1x, Software Update Service Compact, 1 year;</li> </ul>	<b>6ES7822-0AA00-0YL0</b> <b>6ES7822-0AA00-0YMO</b>

## More information

### Technical requirements/compatibility

An S7-1200 CPU with firmware version 3 is required for operating the CP 1243-1 IEC.

The CP 1243-1 IEC is configured using TIA Portal STEP 7 V13.

To connect to PCS 7/WinCC control center systems, the relevant telecontrol packages to support the IEC standard are required.

# Industrial Remote Communication

## Teleservice

### Introduction

### Overview



#### **Teleservice (remote diagnostics and remote maintenance)**

Teleservice is data exchange with physically remote technical plants (machines, plants, computers, etc.) for the purpose of error detection, diagnostics, maintenance, repair, or optimization.

Machines and plants are increasingly operated in places which are far away from the supplier's premises. Despite this, plant builders must offer services to deal with faults or for preventive maintenance. During the warranty period in particular this can result in high costs. Teleservice helps to reduce this risk significantly.

There is a variety of possible applications for Teleservice. Plants can be diagnosed, values set and data transmitted from anywhere in the world via a telephone cable. Teleservice also enables the SIMATIC controllers to send text messages per SMS or e-mail, making a significant contribution to saving travel and personnel costs in service work.

#### **Teleservice via IP-based networks**

Optimum remote maintenance is based on reliable, permanently available, secured and economical data connections.

Depending on the application, SIMATIC NET provides the appropriate solution:

- For continuous connections or simultaneous access to several plants, a solution using the SCALANCE S and SCALANCE M security and communication components is recommended, both on the service and the plant side.
- For flexible access for remote maintenance from any Internet connection - whether in the office, home office or hotel room - SOFTNET Security Client is the right software solution for establishing a secure connection to the plants.
- For plants without a wired network connection, the SCALANCE M wireless router establishes remote maintenance access to the SCALANCE S in the service center.

In all cases, the communication is reliably protected by authentication and encryption via a VPN tunnel (**V**irtual **P**rivate **N**etwork) in order to rule out the possibility of attacks from outside.

#### **Siemens Remote Services**

The service concept of "Siemens Remote Services" provides a powerful, secure platform for remote access to machines and plants. The inclusion of "shared experts" ensures effective support, not only from Siemens but also from the company's own specialists.

### Overview

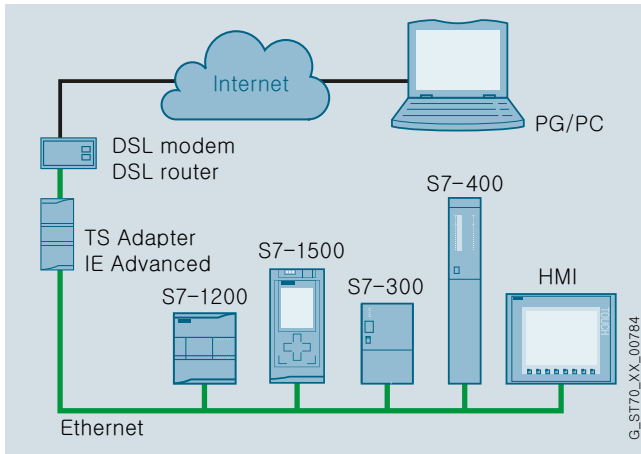

Teleservice with TS Adapter IE Advanced with WAN

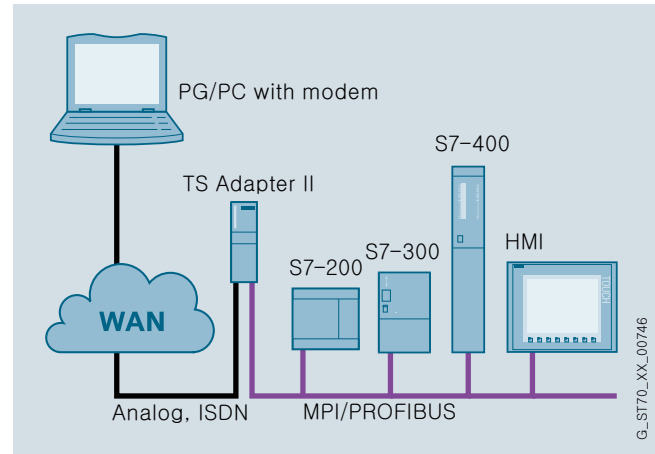

Teleservice with TS Adapter II

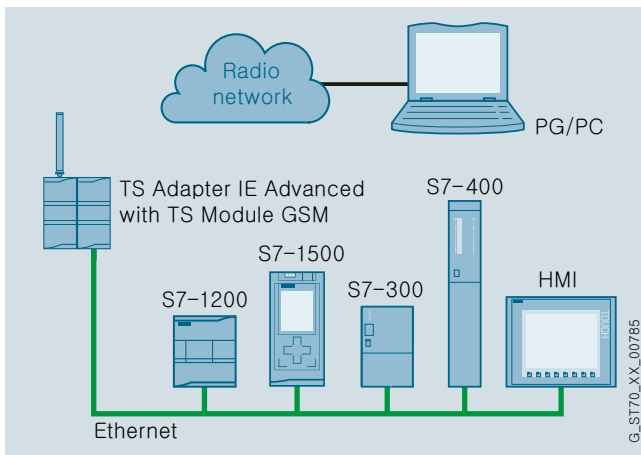

Teleservice with TS Adapter IE Advanced

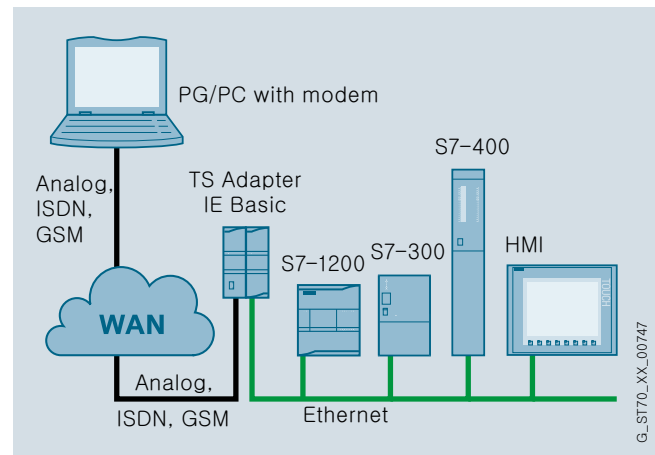

Teleservice with TS Adapter IE Basic

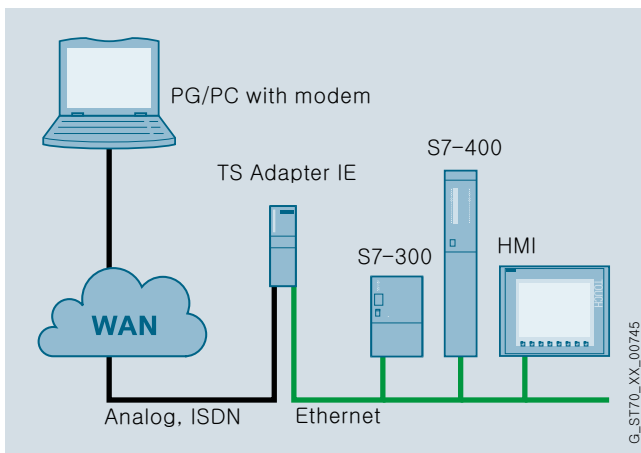

Teleservice with TS Adapter IE

- For performing remote maintenance:  
A programming device/PC with an engineering tool such as STEP 7, or the TIA Portal can access automation components (e.g. S7 CPUs) which are connected to the appropriate adapters over Industrial Ethernet or PROFIBUS.
- Comprising the TeleService software and various adapters:
  - TS Adapter II for connection to PPI, MPI or PROFIBUS DP
  - TS Adapter IE, TS Adapter IE Basic or TS Adapter IE Advanced for connection to Industrial Ethernet
- Additional functions with TS Adapter II:
  - Establishing a connection from/to remote plants, e.g. for calling up process data from an automation system (PG-to-AS remote coupling).
  - Exchanging data between plants (AS-to-AS remote coupling):  
Exchange of process data between two SIMATIC automation systems.
  - Sending a **text message**:  
Sending a text message from a SIMATIC automation system via a GSM wireless modem.

## Industrial Remote Communication

### SIMATIC Teleservice

#### TeleService

##### Overview (continued)

- Additional functions with TS Adapter IE:
  - Remote operation of HMI devices:
    - Access to the HMI device via an Internet browser installed on the adapter
  - Sending e-mails:
    - Establishing a modem link to a dial-up server (e.g. to an Internet service provider): A SIMATIC CPU can send e-mails over an e-mail server that can be accessed in this manner.
  - Standard routing:
    - A modem link can be established to an Internet service provider for accessing data on the Internet.
- Additional functions with TS Adapter IE Advanced:
  - Remote connection via the Internet

##### Application

With TeleService, remote servicing of SIMATIC S7 automation systems or HMI devices is possible using the programming device or PC over a fixed line/wireless network or via the Internet (TS Adapter IE Advanced). With the help of TeleService, the connection to the automation components is extended over the telephone network to the programming device or PC. The functions to be performed, such as programming, are completed using the same tools and functionality as if the job was being done locally. The user has access to the familiar functions of STEP 7 and the engineering tools, comparable to a local connection.

TeleService increases the effective availability of plants and machines. Access through TeleService means that technical services (e.g. maintenance, updating, and troubleshooting) can be performed cost-effectively from a central service center.

Apart from teleservice, a remote link to a programming device or PC can be established program-controlled using a function block call. This link allows process data to be exchanged between an S7 CPU and the programming device or PC with support from PRODAVE.

##### Design

Different components are required depending on the TeleService function or TS Adapter.

###### For remote maintenance:

- TeleService engineering software (not required when using the TIA Portal)
- A programming device/PC-side modem (TS Adapter II, TS Adapter IE or TS Adapter IE Basic)
- Internet access on the programming device/PC side (TS Adapter IE Advanced)
- A TS Adapter, line-side

###### Required in addition to the components for remote maintenance in the case of PG/PLC remote coupling:

- PRODAVE V5.0 and higher for PG/PC:
  - Toolbox for process data traffic between SIMATIC S7/C7 and the PC for autonomous processing of data traffic
- "PG\_DIAL" function block (included in TeleService software package) for the PLC
- A TS Adapter II, line-side

###### Required in addition to the components for remote maintenance in the case of PLC/PLC remote coupling:

- TS Adapter for the second PLC
- "AS\_DIAL" function block (included in TeleService software package) for the PLCs
- A TS Adapter II, line-side

###### For sending SMSes:

- Engineering Software TeleService Version 5.2 and higher
- GSM wireless modem on line side, Hayes-compatible
- TS Adapter II, line-side
- Modem cable for connecting the TS Adapter and modem (included in TS Adapter II package)

###### For sending e-mails:

- Engineering Software TeleService Version 6.1 and higher or TIA portal
- TS Adapter IE, TS Adapter IE Basic or TS Adapter IE Advanced, line-side
- Internet service provider and an e-mail server that can be accessed there

###### For remote control of HMI devices:

- PG/PC with browser – e.g. Internet Explorer – and the Sm@rtViewer
- TS Adapter IE, TS Adapter IE Basic or TS Adapter IE Advanced, line-side
- SIMATIC HMI device with an installed Runtime option of WinCC flexible /Sm@rtService or /Sm@rtAccess. For further information on WinCC flexible and the Sm@rt options, see <http://www.siemens.com/simatic-wincc-flexible>



**Design** (continued)

**TS Adapter II**

Main features of TS Adapter II:

- Single-width standard S7-300 housing
- Mounted onto DIN or S7-profile rail, therefore no time-consuming cabinet installation required using a mounting plate
- Integral modem, either analog or ISDN as required
- USB interface for parameterization. This interface can also be used locally as a programming interface for the connected devices
- Serial RS232 interface for connecting external modems (e.g. wireless modem)
- Firmware with update capability
- Power supply over MPI or over external 24 V power supply
- Connection of an external modem, e.g. a GSM wireless modem, over serial interface
- Can be connected to:
  - MPI
  - PROFIBUS DP up to 12 Mbit/s (previously 1.5 Mbit/s)
  - PPI

Scope of delivery:

The following components are supplied with the TS Adapter II:

- DVD with driver
- TeleService software V6.1 (Can be used for 14 days). For further operation, a license is required)
- MPI cable, 0.8 m, for connecting the adapter to the MPI/DP interface
- Standard telephone cable, 3 m, with RJ12 connectors (only for TS Adapter II modem)
- Standard telephone cable, 3 m, with RJ45 connectors (only for ISDN TS Adapter II)
- TAE6N plug (only for TS Adapter II modem)

When using the TS Adapter II modem outside Germany, a standard national telephone plug can be snapped onto the RJ12 connector. A TAE6N connector is supplied for Germany. In some countries, telephone sockets with RJ12 sockets are available, in which case telephone cables can be used without the need for a telephone plug.

For operation, TeleService Software Version 6.0 is required.

**TS Adapter IE**

Main features of TS Adapter IE:

- Single-width standard S7-300 housing
- Mounting on DIN or S7 rail
- Integral modem, either analog or ISDN as required
- Firmware with update capability
- Power supply over external 24 V power supply
- Serial interface for connection of an external modem, e.g. a GSM wireless modem
- An RJ45 Ethernet interface (10/100 Mbit/s)
- Industry-compatible in accordance with SIMATIC standard

Parameterization:

The TS Adapter IE can be parameterized locally or over a remote link. TeleService software V6.1 or an Internet browser is used for this purpose.

The firewall is parameterized easily by selecting and deselecting the appropriate services with a click of the mouse button. In "expert mode", the adapter can also be parameterized like a standard router.

Security:

Only dial-in access is possible: The service engineer dials into the adapter using a supplied telephone number. Authentication is performed by means of a user log-in with a password and Challenge Handshake Authentication Protocol (CHAP). Up to 8 user accounts can be created with different log-ins and passwords.

As an option, e.g. for security reasons or to save telephone charges, the TS Adapter IE will interrupt the connection following correct authentication and call the user back on the telephone number stored in the TS Adapter IE.

The implemented firewall protects the plant from unauthorized access over the Internet. By default, the firewall only permits S7 communication. The required services, e.g. Sm@rt-Access, Sm@rt-Service or PCAnywhere, can be individually enabled during parameterization. For sending e-mails, it is necessary to enable the SMTP protocol and to set the parameters for outgoing calls. It is also possible to block all incoming data packets during connection to the Internet.

Scope of delivery:

The following components are supplied with the TS Adapter IE:

- CD with drivers and TeleService V 6.1 software (can be used for 2 weeks without a license) including standard software for sending e-mails from S7 CPUs
- Standard telephone cable, 3 m, with RJ12 connectors (only for TS Adapter IE modem)
- Standard telephone cable, 3 m, with RJ45 connectors (only for ISDN TS Adapter IE)
- TAE6N plug (only for TS Adapter IE modem)

When using the analog TS Adapter IE outside Germany, a standard country-specific telephone plug can be snapped onto the RJ12 connector. A TAE6N connector is supplied for Germany. In some countries, telephone sockets with RJ12 sockets are available, in which case telephone cables can be used without the need for a telephone plug.

## Industrial Remote Communication

### SIMATIC Teleservice

#### TeleService

#### Design (continued)

##### **TS Adapter IE Basic**

The TS Adapter IE Basic in SIMATIC S7-1200 design is optimized for operation with SIMATIC S7-1200. It can also be used with S7-300 and S7-400. The adapter has a modular design and comprises the following:

- Basic unit TS Adapter IE Basic
- TS module
  - TS module modem:
    - Contains an analog modem for the connection to the analog telephone network
  - TS module ISDN:
    - Contains a terminal adapter for the connection to the ISDN network
  - TS module RS232:
    - With RS232 interface for connecting an external modem
  - TS module GSM:
    - Contains a wireless modem for connecting to the GSM/GPRS network

Only the combination of a basic unit TS Adapter IE Basic and a TS module forms a complete functional unit (total unit). Basic unit and TS module are connected via a connector and assembled together.

The functions of the TS Adapter are implemented in the basic unit. The basic unit has an Ethernet interface for connecting to PGs, PCs, or automation system. The basic unit is supplied with 24 V DC and grounded via a socket board.

The TS modules form the electrical interface to the telephone network. They are supplied with electricity from the basic unit through the shared connector.

TS Adapter IE Basic (basic unit) and the TS module can be installed differently:

- Installing on the S7-300 standard rail. This requires an optionally available standard sectional rail adapter
- Installation on a standard rail
- Wall mounting
- Enclosure mounting

##### Product package

The following are supplied with the basic unit TS Adapter IE Basic:

- DVD "SIMATIC TeleService Edition" with software and documentation
- Support collar for Ethernet plug

##### **TS Adapter IE Advanced**

The TS Adapter IE Advanced makes it possible to access via the Internet all plant automation components, such as S7-CPU's, which are connected to Industrial Ethernet. To facilitate this a TIA Portal Version V12 SP1 or higher is required which runs on a programming device/PC under Windows 7 or Windows Server 2008.

TS Adapter IE Advanced connection types:

- Direct connection to programming device/PC:
  - The TS Adapter IE Advanced can be parameterized with direct connection to the programming device/PC via Ethernet (LAN)
- Connection to the GSM network (GPRS):
  - For connection to the GSM network, the TS Adapter IE Advanced must be operated together with the TS module GSM
- Connection to the Internet via DSL:
  - For connection to the Internet, a DSL router must be operated at the WAN port of the TS Adapter IE Advanced
- Connection to the company network:
  - Connection to the company network takes place directly at the WAN port of the TS Adapter IE Advanced

The TS Adapter IE Advanced has the following technical features:

- Standard S7-1200 housing, with 55 mm width
- Direct connection to system network (Industrial Ethernet); 2 ports (LAN)
- Connection to public grid; 1 port (WAN)
- 24 V DC connection
- Plug-in TS modules

##### Types of installation

There are three alternative methods for mounting the TS Adapter IE Advanced:

- On the standard rails of the S7-300 with mounting rail adapters that can be ordered separately
- On a standard DIN rail
- Wall mounting

##### Product package

- TS Adapter IE Advanced
- CD "TS Adapter IE Advanced" with documentation, open-source components and default certification

**Function**

TeleService is stand-alone software and does not require the installation of other software products such as STEP 7.

When using the TIA Portal, the TeleService software is not required because the functions are already a component part of the TIA Portal.

The following functions are available for remote maintenance with TeleService:

- Support for the TS Adapter II, TS Adapter IE and TS Adapter IE Basic
- Parameterization of the modem:  
On the PG/PC side, parameterization using Windows tools is supported. On the line side, the TS Adapter (with default settings) performs parameterization
- Electronic telephone book:  
To support the administration of plants (e.g. telephone number, location)
- Multi-level access protection:  
Prevents unauthorized connection build-up to a plant by means of a password and/or callback telephone number (callback function)
- Callback function:  
The plant calls the service center back automatically following a TeleService call
- Routing of the PG functionality:  
Routing over TeleService is supported in the same manner as for a local connection. S7/M7 CPUs and CP modules with routing capability are required for this purpose
- Import/export of the TS Adapter parameters:  
The parameters can be saved in a file (\*.tap) on the PG/PC and reloaded
- Authorization via the Automation License Manager
- Runs under Windows XP Professional, Windows Vista and Windows 7

TS Adapter II; TS Adapter IE and TS Adapter IE Basic provide additional functions

TS Adapter II:

- Establishing a connection from/to remote plants, e.g. for calling up process data from an automation system (PG-to-AS remote coupling)
- Exchange of data between plants (AS-to-AS remote link)
- Exchange of process data between two SIMATIC automation systems
- Sending a text message
- Sending a text message from a SIMATIC automation system via a GSM wireless modem

TS Adapter IE:

- Remote control of HMI devices:  
The TS Adapter IE in combination with a browser installed on the PG/PC (e.g. Internet Explorer) and the Sm@rtViewer supports access over the telephone network to a SIMATIC HMI device with an installed Runtime option of WinCC flexible /Sm@rtService or /Sm@rtAccess. The HMI device or machine/plant can then be remotely controlled from the PG/PC.
- Sending e-mails:  
The function block AS\_MAIL (included in the scope of supply of the adapter or TeleService V6.1) can be used to send e-mails directly from a SIMATIC CPU over the TS Adapter IE. The TS Adapter IE builds up an outgoing modem connection to a dial-up server for this purpose, e.g. to an Internet service provider, and sends the e-mails via an e-mail server that can be accessed there. If the provider offers the service for converting e-mails to text messages, text messages can also be sent in this manner.
- Standard routing:  
The TS Adapter IE allows a modem link to be established to an Internet service provider for accessing data on the Internet over this link. While the link is established, telephone dial-up and therefore remote maintenance and remote control is not possible.

TS Adapter IE Basic (in conjunction with a TS module)

- Remote maintenance over the telephone network:  
The TS Adapter IE Basic enables an application running on the PG/PC, such as STEP 7, to access Industrial Ethernet-connected S7 and C7 automation components over the phone network. For this, the TS Adapter IE Basic requires the following:
  - A connection to the automation components via Industrial Ethernet, and
  - A modem connection to the PG/PC
- Sending e-mails:  
With the AS\_MAIL function block, you can send e-mails from a SIMATIC CPU via the TS Adapter IE Basic. To do this, the TS Adapter IE Basic establishes an outgoing modem connection to a dial-up server, such as an Internet Service Provider (ISP), and sends the e-mails via a mail server accessible there.

To establish a remote connection through the telephone network you will alternatively need:

- TIA Portal V11.0 (contains all the necessary TeleService functions)
- TeleService V6.1 or
- Windows dial-up network

## Industrial Remote Communication

### SIMATIC Teleservice

#### TeleService

##### TS Adapter IE Advanced

###### Functionality:

- Remote maintenance via a VPN connection
- Parameterization via an integrated web interface
- Enabling and disabling of connections, time-triggered if required
- User management with freely-definable password rules
- Logging of security events, exportable
- Own hardware clock, battery back-up, NTP client
- Configurable package filter
- Port forwarding routing
- NAT, SNMP
- Sending e-mails (via FBs on a SIMATIC CPU)
- Export and import of parameters
- Firmware update

###### Security:

The TS Adapter IE Advanced provides a high level of security, supported by hardware. System access is only possible via an encrypted VPN connection. Authentication is ensured by certificates.

The user management function enables user accounts with differing access rights to be set up. The firewall can be configured to filter data streams so they exactly fit customer requirements.

###### Advantages/customer benefits:

- High security standard due to VPN, certificates, hardware-generated random numbers and adherence to strict Siemens security guidelines
- Made-to-measure solutions for remote maintenance in the automation environment
- Transparent routing via web proxies ensures use directly from the company LAN (service side) to the system, with no release or configuration by IT administrators
- Only the TIA Portal is required to build up the VPN connection (VPN client)
  - SFTP (Windows 7 service) behaves like HTTPS access from the browser and is thus transparent in the infrastructure
  - Direct online connection from the TIA Portal at the press of a button (telephone book function: management of multiple teleservice adapters possible)
- Can be used as router or following a default router
- Integrated DCP proxy (support for life-list function as local, and use of topology editor via remote access)

###### Sending e-mails

The TS Adapter IE Advanced (gateway function) can be used to send e-mails from a SIMATIC-CPU in the system network (LAN) to a communication partner in the public grid (WAN).

The following blocks are available depending on the CPU used:

- TMAIL\_C for S7-1500
- TM\_MAIL for S7-1200 (for firmware versions V2.x and V3.x of a CPU from the S7-1200 series)
- AS\_MAIL for S7-300/400

#### Technical specifications

TS Adapter II	
Dimensions (W x H x D) in mm	125 x 110 x 40
Weight, approx.	250 g
Interfaces	
• to S7/C7	RS 485 (up to 12 Mbit/s)
• to the PC	USB 1.1 (12 Mbit/s)
• to an external modem	RS 232 (up to 115 kbaud)
• to the analog telephone network	RJ12
• to the ISDN telephone network	RJ45
Supply voltage, external or via MPI interface	24 V DC
Current consumption	60 mA (typ.) / 120 mA (max.)
Switch-on current, max.	0.7 A; 8 µs
Degree of protection	IP20
Temperature	
• Operation	± 0 °C to +60 °C
• Storage/transport	-40 °C to +70 °C

TS Adapter IE	
Dimensions (W x H x D) in mm	125 x 110 x 40
Weight, approx.	approx. 370 g
Interfaces	
• Ethernet	RJ45 (10/100 Mbit/s)
• to an external modem	RS 232 (up to 115 kbaud)
• to the analog telephone network	RJ12
• to the ISDN telephone network	RJ45
Supply voltage, external or via MPI interface	24 V DC
Current consumption of the TSA-IE ISDN	typ. 170 mA / max. 230 mA
Current consumption of the modem TSA IE	typ. 180 mA / max. 240 mA
Switch-on current, max.	0.7 A; 8 µs
Degree of protection	IP20
Temperature	
• Operation	± 0 °C to +60 °C
• Storage/transport	-40 °C to +70 °C

## Technical specifications (continued)

TS Adapter IE Basic (basic unit)	
Dimensions (W x H x D) in mm	30 x 100 x 75
Weight, approx.	100 g
Interfaces	
• Ethernet	RJ45 (10/100 Mbit/s)
• To the TS module	Proprietary (can only be used for TS modules)
Supply voltage, external	24 V DC
Current consumption	
• With TS module modem	Typ. 50 mA, max. 80 mA
• with TS module ISDN	Typ. 50 mA, max. 80 mA
• with TS module RS232	Typ. 40 mA, max. 60 mA
• with TS module GSM	Typ. 100 mA, max. 180 mA
Switch-on current, max.	240 mA
Degree of protection	IP20
Temperature	
• Operation	±0 °C to +60 °C (horizontal installation) ±0 °C to +40 °C (vertical installation)
• Storage	40 °C to +70 °C
TS module modem	
Dimensions (W x H x D) in mm, approximately	30 x 100 x 75
Weight, approx.	98 g
ITU transmission standards	• V.21, V.22, V.22bis, V.23, V.32, V.32bis, V.34, V.34x, K56flex, V.90, V.92
Other features	• Error correction and data compression • a/b interface • Hayes (AT) command set • All data formats • Dial procedures: dual-tone multiple-frequency (DTMF), pulse dialing
TS module ISDN	
Dimensions (W x H x D) in mm	30 x 100 x 75
Weight, approx.	92 g
Reports	
• D channel protocols	DSS1 (Euro-ISDN), 1TR6
• B channel protocols	V.110 (9 600 bit/s, 19 200 bit/s, 38 400 bit/s) V.120 (64 Kbit/s) X.75 (64 Kbit/s)
Other features	• Multiple subscriber number (MSN) • AT command interpreter
TS module RS232	
Dimensions (W x H x D) in mm	30 x 100 x 75
Weight, approx.	100 g
Operating mode	Full duplex, asynchronous
Signals	TXD, RXD, DSR, CTS, RTS, DTR, DCD
Data transmission rate	2 400 ... 115 200 bit/s
Message frame	8 data bits (LSB first), no parity bit, 1 stop bit
Rule	according to RS232 standard
Connector	D-sub 9-pin, male (PC COMx)
TS module GSM	
Dimensions (W x H x D) in mm	30 x 100 x 75
Weight, approx.	118 g
Transmission rate	
• GPRS Multislot Class 10	
- Up to 2 uplinks	13.4 Kbit/s ... 27 Kbit/s upload gross
- Up to 4 downlinks	40 Kbit/s ... 54 Kbit/s download gross
Interfaces	
• SIM interface	3 V/1.8 V
• Antenna connection	1 x SMA antenna socket (50 Ohm)
Frequency ranges	Quad band: 850, 900, 1 800, 1 900 MHz
Transmitted output power	2 W at 850 MHz, 900 MHz 1 W at 1 800 MHz, 1 900 MHz
TS Adapter IE Advanced	
General information	
<u>Engineering with</u>	
STEP 7 TIA Portal can be configured/integrated as of version	V12 SP1
<u>Installation</u>	
Rail mounting possible	Yes
Wall/direct mounting possible	Yes
<u>Supply voltage</u>	
24 V DC	Yes
Permissible range	+19.2 V ... +28.8 V
<u>Input current</u>	
Current consumption, typ.	100 mA
Current consumption, max.	200 mA; incl. TS module GSM
Switch-on current, max.	4.3 A
Activation time, max.	3.1 ms
<u>Power loss</u>	
Power loss, typ.	2.4 W
Interfaces	
<u>Industrial Ethernet</u>	
Industrial Ethernet interface	3x Ethernet (RJ45), 100 Mbit
Interrupts/diagnostics/status information	
Diagnostics display LED	RUN LED, ERROR LED, MAINT LED, LINK LED, ONLINE LED, VPN LED, RX/TX LED
Insulation	
Insulation tested at	707 V DC (type test)
Dimensions	
W x H x D	55 x 117 x 75 mm
Weight	
Weight, approx.	225 g

# Industrial Remote Communication

## SIMATIC Teleservice

### TeleService

#### Ordering data

##### TeleService, Version 6.1

###### Task:

Remote maintenance by means of wired or radio network

###### Target system:

SIMATIC S7-200, SIMATIC S7-300, SIMATIC S7-400, SIMATIC C7

###### Requirement:

TS Adapter (STEP 7 not required)

###### Delivery package:

on CD, German, English, French, Spanish, Italian; with electronic documentation

Floating License

**6ES7842-0CE00-0YE0**

Floating License Upgrade (from each previous version)

**6ES7842-0CE00-0YE4**

Software Update Service (requires current software version) <sup>1)</sup>

**6ES7842-0CA01-0YX2**

##### TS Adapter II modem

**6ES7972-0CB35-0XA0**

with MPI connection and RS 232; 9-pin, male

##### TS Adapter II ISDN

**6ES7972-0CC35-0XA0**

with MPI connection and RS 232; 9-pin, male

##### TS Adapter IE modem

**6ES7972-0EM00-0XA0**

with Ethernet connection RJ45 (10/100 Mbit/s) and RS 232; 9-pin, male

##### TS Adapter IE ISDN

**6ES7972-0ED00-0XA0**

with Ethernet connection RJ45 (10/100 Mbit/s) and RS 232; 9-pin, male

##### USB cable

**6ES7901-0AE00-0XA0**

for parameterizing the TS Adapter II, it can also be used for programming the connected devices. 5 m long

<sup>1)</sup> For more information on the software update service, see Catalog ST 70.

#### Article No.

#### Article No.

##### TS Adapter IE Basic

**6ES7972-0EB00-0XA0**

Basic unit

##### TS module modem

**6ES7972-0MM00-0XA0**

##### TS module ISDN

**6ES7972-0MD00-0XA0**

##### TS module RS 232

**6ES7972-0MS00-0XA0**

##### TS module GSM

**6GK7972-0MG00-0XA0**

##### TS Adapter IE Advanced

**6ES7972-0EA00-0XA0**

for accessing automation components via the Internet (GSM, DLS, WAN)

##### S7 mounting rail adapter

**6ES7972-0SE00-7AA0**

for mounting the TS Adapter IE Basic on S7-300 mounting rail, width 60 mm

##### SIMATIC Manual Collection

**6ES7998-8XC01-8YE0**

Electronic manuals on DVD, multilingual: LOGO!, SIMADYN, SIMATIC bus components, SIMATIC C7, SIMATIC distributed I/O, SIMATIC HMI, SIMATIC Sensors, SIMATIC NET, SIMATIC PC Based Automation, SIMATIC PCS 7, SIMATIC PG/PC, SIMATIC S7, SIMATIC Software, SIMATIC TDC

##### SIMATIC Manual Collection update service for 1 year

**6ES7998-8XC01-8YE2**

Current "Manual Collection" DVD and the three subsequent updates

### Overview

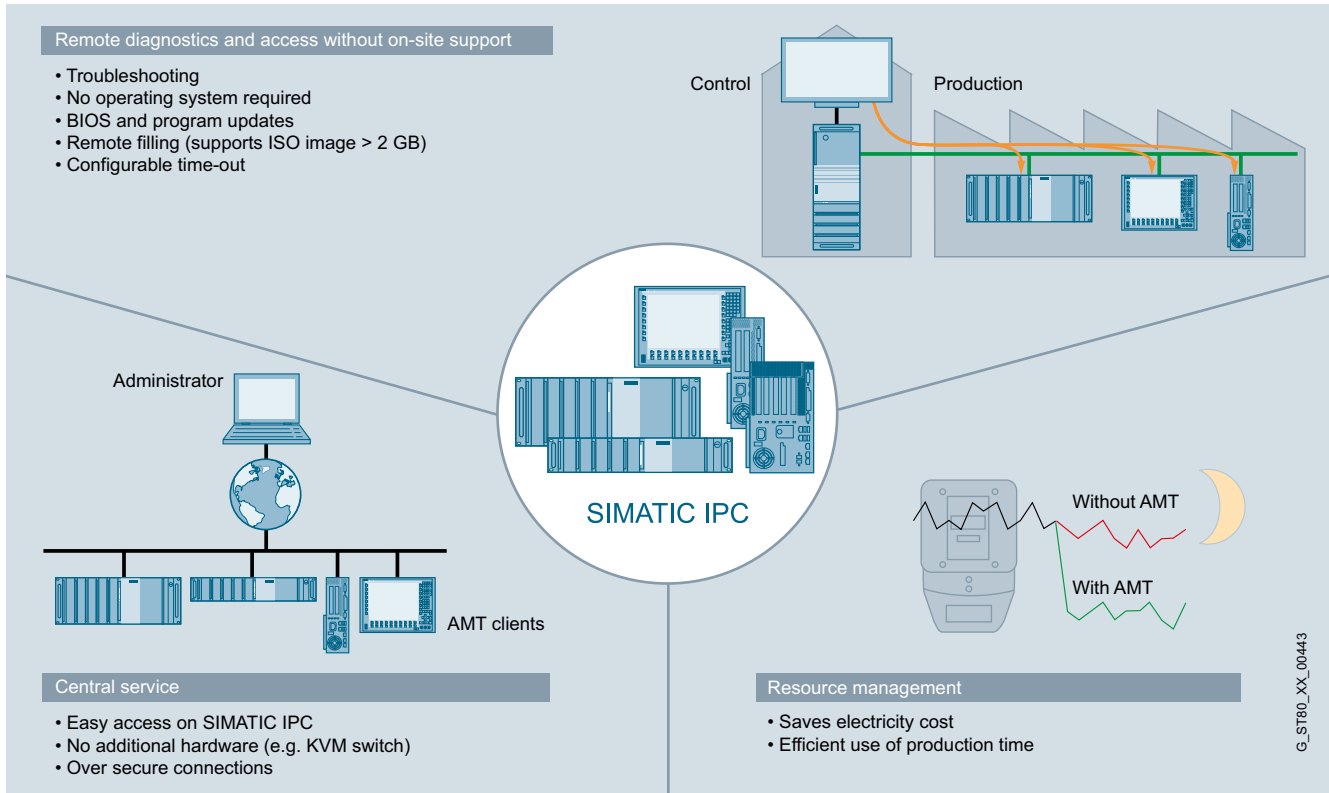

### **SIMATIC IPC Remote Manager**

Efficient remote maintenance and management of SIMATIC IPCs.

With the SIMATIC IPC Remote Manager you can use functions of the Intel active management technology (Intel AMT) for SIMATIC IPCs. Intel AMT is used for remote management of PCs.

Intel AMT offers a range of functions, such as:

- Remote reboot
- IDE redirection
- Keyboard video mouse redirection
- Power on / off / reset, and
- An integrated Web server.

<http://support.automation.siemens.com/WW/view/en/56230140>

# Industrial Remote Communication

## IPC Remote Manager

### SIMATIC IPC Remote Manager

#### Benefits

##### Central service

- Simple remote access to AMT clients
- Without additional hardware
- Via secure connections

##### Remote diagnostics and access without on-site presence

- Troubleshooting
- BIOS and program updates

##### Resource management

- Saving of electricity costs
- Efficient use of production time

#### Function

##### **SIMATIC IPC Remote Management**

##### Keyboard Video Mouse Redirection (KVM)

This can be used to divert the keyboard video mouse signal of a remote computer to or from an IT computer via a remote connection so that an administrator can access and operate the computer without additional hardware.

##### Remote Power Control

This allows SIMATIC IPCs with Intel AMT functions to be switched off and on via remote access, e.g. for maintenance purposes. If the operating system of the AMT computer is no longer operable, you can thus still perform a reset or restart. With this function, even the electricity costs of a company can be reduced e.g. by specifically shutting down computers left running by employees at night or at the weekend

##### Disk Redirection (IDE-R)

The AMT client can read data from an ISO image existing on the admin computer and start programs, e.g. to carry out BIOS and software updates.

##### Remote reboot

This can be used to reboot the PC by remote access from the hard disk, CD or a network drive, e.g. following a program update.

##### Web server

In addition, the Web server integrated in the AMT computer can be accessed using a Web browser (e.g. Internet Explorer). Here you can scan hardware and system information, and actions such as power on / off / reset can be performed.

#### **System requirements**

Hardware requirements for SIMATIC IPC Remote Manager:

- All SIMATIC PCs of the "B" generation
- All SIMATIC IPCs of the "C" generation
- SIMATIC Field PG M2 / M3 / M4

Operating system requirements for SIMATIC IPC Remote Manager:

- Microsoft Windows XP Professional SP3
- Microsoft Windows Vista Ultimate SP2
- Microsoft Windows Embedded Standard 2009
- Microsoft Windows Embedded Standard 2007
- Microsoft Windows 7 Ultimate
- Microsoft Windows 2003 R2 Server Edition
- Microsoft Windows 2008 Server Edition

#### **Operating instructions / restrictions:**

SIMATIC	Device	AMT client	Admin computer
<b>Rack PC</b>	IPC647C	Processors: Intel Core i5 or Core i7 BIOS version: V15.01.05 and later	<ul style="list-style-type: none"> <li>• With any operating system and Web browser</li> <li>• With Windows operating systems and SIMATIC IPC Remote Manager</li> </ul>
	IPC847C		
	IPC547C	No	
<b>Box PC</b>	IPC627C	Processors: Core i7 BIOS version: V15.02.05 and later	
	IPC827C		
<b>Panel PC</b>	HMI IPC677C	Processors: Core i7 BIOS version: V15.02.05 and later	
	HMI IPC577C	No	
	HMI IPC477C	No	
<b>Microbox PC</b>	IPC427C	No	
<b>Field PG</b>	Field PG M2/M3	No	

- The SIMATIC IPC Remote Manager is offered exclusively with English menus.
- AMT functions are only integrated in the Intel Core i5 and Core i7 processors of the SIMATIC IPC847C, IPC627C, IPC647C, IPC827C and HMI IPC677C devices. With a Core i3 CPU, iAMT is not possible. A Field PG does not have integral AMT functionality either.

#### Ordering data

#### Article No.

##### **SIMATIC IPC Remote Manager V1.2**

Software tool for remote maintenance and management of SIMATIC IPC, incl. manual on CD-ROM (English, German), single license

**6ES7648-6EA01-2YA0**



### Overview

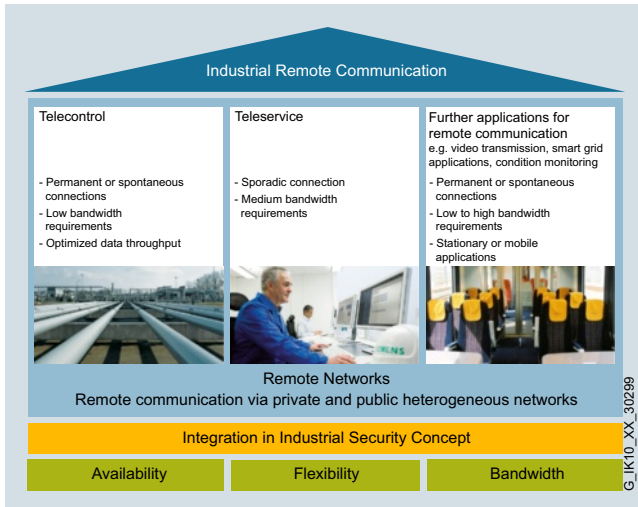

### Connected in many ways via remote networks

Remote networks are public or private communication infrastructures for covering wide areas or long distances, for example mobile radio or fixed telephone networks. The extensive Siemens remote networks portfolio offers connection to both conventional and IP-based infrastructures.

Remote communication via private and public networks continually results in new opportunities in the public and industrial communication environment due to increasing bandwidths, higher availability and decreasing costs.

The new product spectrum of SCALANCE M provides the right network component for every application. SCALANCE M can be used universally in the fields of telecontrol, teleservice and any other application for industrial remote communication. The connection to remote networks is made via public communications infrastructures such as DSL and mobile radio. The components are optimized for industrial use and integrated into the TIA environment. Thanks to the integrated encryption and access protection mechanisms, the devices make a crucial contribution to security in data communication. Groundbreaking security concepts (firewall, VPN) for the use of public and, in some cases, open infrastructures, such as the internet, protect the communication systems against unauthorized access from outside. In order to achieve a high level of process availability, the transmission networks can be redundantly structured.

Even for private leased lines or dialup networks, Siemens offers the right solution!

In order to achieve extensive networks, the connection via remote networks can be supplemented with further network components from the SIMATIC NET product portfolio – for example, with the fiber optic cable versions of the SCALANCE X industrial Ethernet switches or the SCALANCE W industrial wireless LAN components.

Security is the most important thing when constructing remote networks. Together with Security Integrated components, such as SCALANCE S, the remote access to IP-based networks can be protected with firewalls and VPN tunnels and saved from any risks.

## Industrial Remote Communication

### Remote Networks

#### IP-based modems and routers

#### SCALANCE M874 mobile wireless router

#### Overview



The SCALANCE M874-3 is a mobile wireless router for cost-effectively and securely connecting Ethernet-based subnets and programmable controllers via the 3rd generation mobile wireless network (UMTS) and it supports HSPA+ (High Speed Packet Access). Thus, it allows high transfer rates of up to 14.4 Mbit/s in the downlink and up to 5.76 Mbit/s in the uplink (depending on the infrastructure of the mobile wireless provider).

The SCALANCE M874-2 is a mobile wireless router for cost-effectively and securely connecting Ethernet-based subnets and programmable controllers via the 2nd generation mobile wireless network (GSM) and it supports GPRS (General Packet Radio Service) and EDGE (Enhanced Data Rates for GSM Evolution).

The security of access and communication is ensured by the security functions of the integrated firewall and by VPN tunnels (end-to-end connection encryption through IPsec tunneling).

#### Product versions

##### SCALANCE M874-3:

- Penta-band UMTS with the frequency bands 800/850/1 700/1 900/2 100 MHz
- Quad-band GSM with the frequency bands 850/900/1 800/1 900 MHz
- Without UMTS network, automatic switchover to 2nd generation mobile radio data services, eGPRS or GPRS mode
- Support for UMTS with HSPA+ (downlink: 14.4 Mbit/s, uplink: 5.76 Mbit/s)

##### SCALANCE M874-2:

- Quad-band GSM with the frequency bands 850/900/1 800/1 900 MHz

#### Benefits

get **Designed for Industry**

- High security standards by means of a firewall (stateful packet inspection) and VPN connections (IP-Sec) as an integral component of the Industrial Security concept
- Low investment and operating costs for operator control and monitoring of remotely connected substations
- Reduction in traveling costs and personnel costs due to remote programming and diagnostics via mobile wireless networks
- Improved manageability thanks to mechanical integration due to the design (module format) with S7-1500 / ET200MP
- Wide application area thanks to large bandwidth, high performance and speed
- Application-dependent use of mobile wireless services (2nd and 3rd generation)
- Worldwide application

#### Application

The SCALANCE M874 can be used in industrial and semi-industrial applications:

- Worldwide remote programming and servicing, e.g. using STEP 7 via mobile wireless
- Worldwide flexible plant access for servicing and diagnostics purposes
- Connection of static and mobile stations for controlling and monitoring such things as:
  - Water/wastewater treatment plants
  - Oil and gas supplies
  - District heating networks
  - Power distribution
  - Pumping stations
  - Transportation systems
- Worldwide condition monitoring, e.g. for
  - Wind energy and photovoltaic plants
- Can be used worldwide due to:
  - UMTS: Penta-band technology
  - GSM: Quad-band technology

#### Note:

Country-specific approvals must be observed.

Due to the integral security functions, the SCALANCE M874 mobile wireless router enables protected connection of distributed automation cells to a control center via the mobile wireless network, and it can be used within the scope of the Siemens Remote Service. This comprehensive service allows companies to task Siemens with the monitoring, control and maintenance of distant plants and machines via remote access.

#### Design

- The rugged plastic enclosure supports the following mounting methods:
  - S7-1500 mounting rail
  - S7-300 mounting rail
- Standard rail mounting
- Wall mounting
- 2 x RJ45 interface with 10/100 Mbit/s for Industrial Ethernet
- Diagnostics LEDs for modem status, field strength, connection control, and DI/DO channels
- SET button
- 5-pin screw terminal for redundant connection to the 24 V DC power supply
- 2-pin screw terminal for a digital input
- 2-pin screw terminal for a digital output
- 1 x SMA antenna connection for an UMTS/GSM antenna

#### Function

- Automatic setup and holding of IP-based online connection to the Internet
- Merging of distributed, IP-based networks via mobile radio networks
- Bi-directional IP-based data communication with a telecontrol center, e.g. ST7cc or ST7sc, WinCC or PCS 7
- Integrated security functions with firewall (stateful inspection)
- Integrated IPsec VPN tunnel encryption
- Data exchange between telecontrol stations (slave-slave communication) via a TIM communication module in the service center
- Secure data communication with the SINAUT ST7 stations, also over mobile radio provider networks which do not provide public and fixed IP addresses for the modem
- Automatic and user-defined sending of text messages
- Configuration data can be saved by means of the C-PLUG storage medium (not included in the scope of delivery)

#### Configuration

- User-friendly configuration of all network and firewall parameters of the router using the Web browser
  - CLI (Command Line Interface) available soon
  - Integration in TIA Portal available soon

#### Security

- Router for data transmission via public networks with NAT functionality (NAT Traversal, NAT, 1:1-NAT)
- Standardized VPN termination of the control center via SCALANCE S
  - By means of IPsec protocol
  - OpenVPN available soon
- Firewall for protection against unauthorized access; the dynamic packet filter checks data packets based on the source and target address (stateful inspection)

#### Diagnostics / maintenance

- Connection buildup status and status of an existing connection via front LED display

#### Preconditions for using the SCALANCE M874 mobile radio router

- SIM card from a mobile network operator with UMTS support or alternatively, a SIM card from a mobile wireless operator with GSM support

## Industrial Remote Communication

### Remote Networks

#### IP-based modems and routers

#### SCALANCE M874 mobile wireless router

#### Integration

##### **Application example:** **SCALANCE M874 for remote maintenance with VPN tunnel**

Classical applications such as remote programming, parameterization and diagnosis, but also monitoring of machines and plants installed worldwide can be performed securely via a VPN from a service center that is connected over the Internet. Access to any IP-based devices, especially IP-based programmable

controllers, which are downstream of the SCALANCE M874 in the local network.

Multimedia applications like video streaming can be implemented thanks to the increased bandwidth in the uplink.

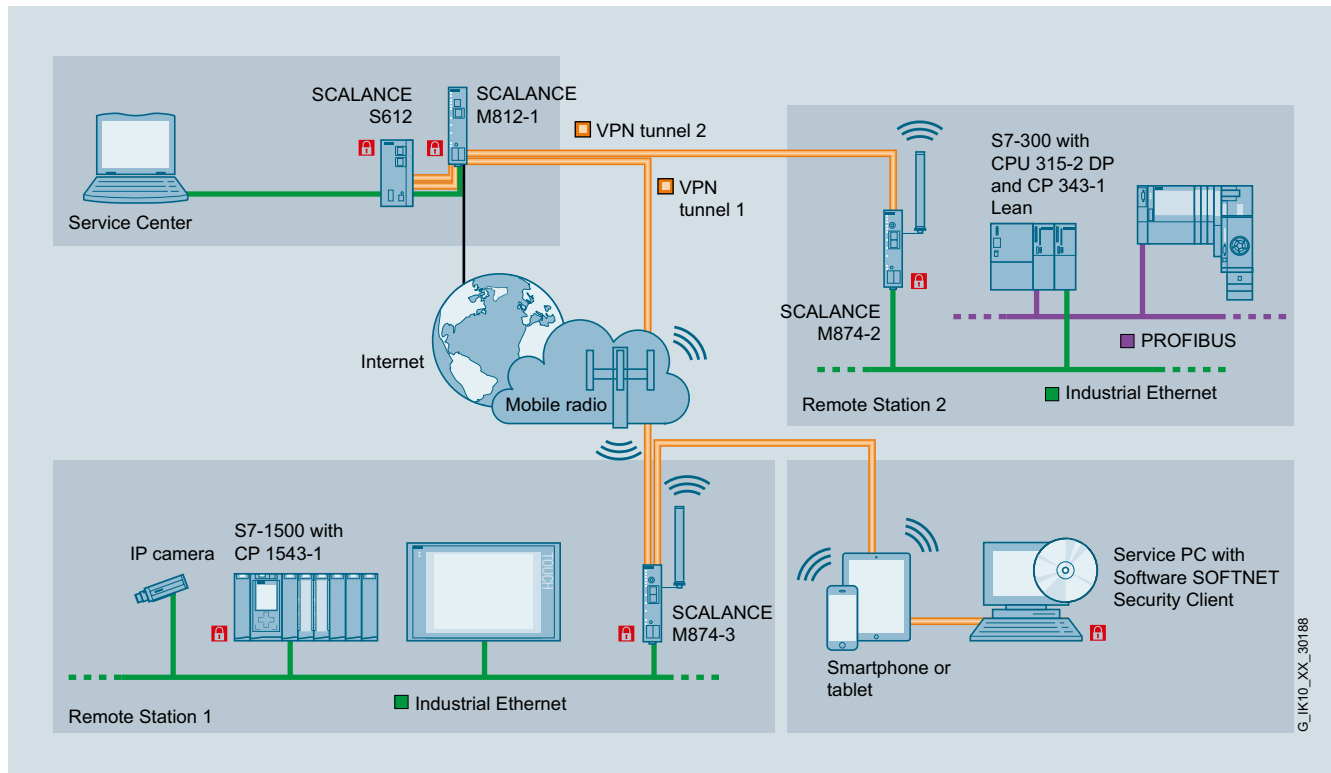

Typical remote access scenario via a secure UMTS-based Internet connection

G\_IK10\_XX\_30188

**Integration** (continued)

**Application example: SINAUT ST7 with SCALANCE M874**

The diagram below shows an S7-300 station with TIM 3V-IE and SCALANCE M874-2 connected to the control center (SINAUT ST7cc or ST7sc) via UMTS and Internet. Behind the SCALANCE S module, a TIM 4R-IE is installed. For the control center, this module performs the SINAUT communication with the stations connected via the Internet as well as with the

stations that are connected to the TIM 4R-IE via two other networks. Cross traffic between individual stations in the various networks is routed via the TIM 4R-IE.

It is possible to forward fault messages from the plant to service personnel by text message, fax or e-mail.

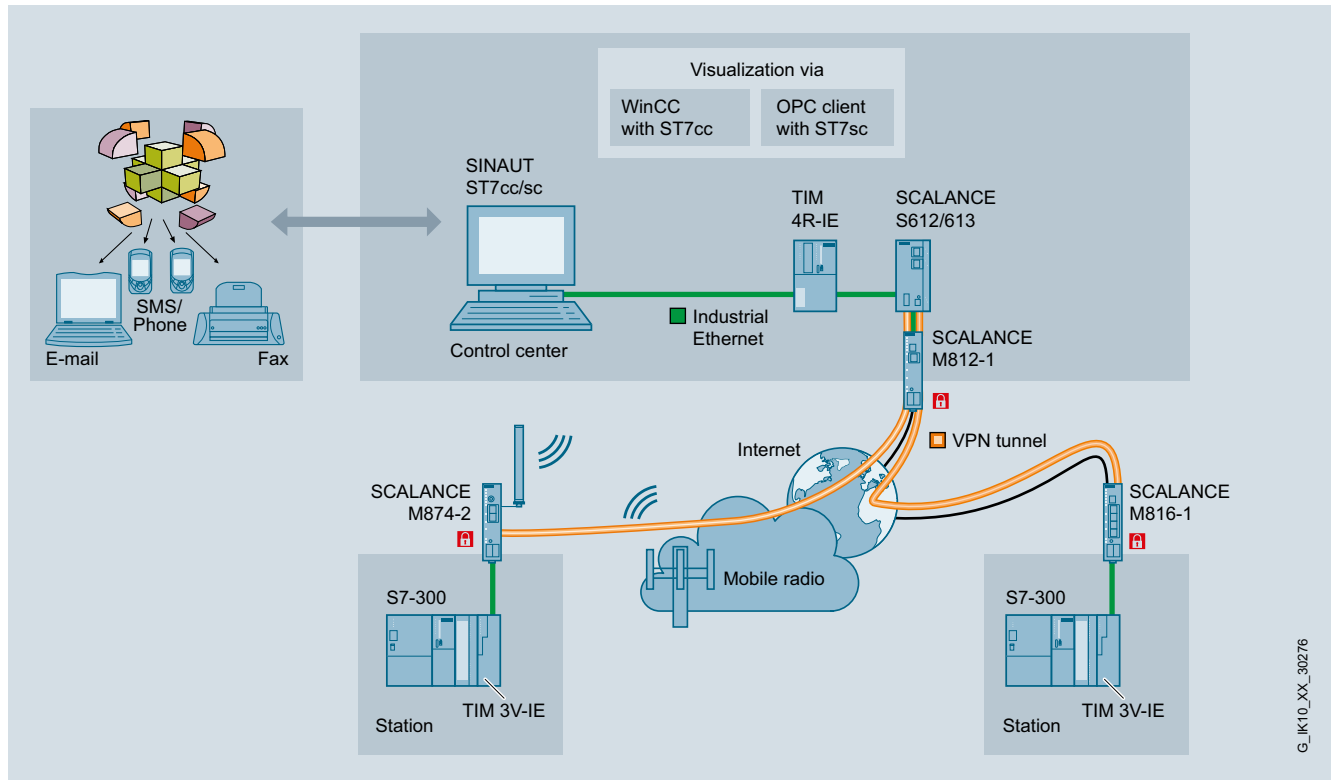

Secure telecontrol with SINAUT ST7 over IP-based networks

# Industrial Remote Communication

## Remote Networks

### IP-based modems and routers

#### SCALANCE M874 mobile wireless router

#### Integration (continued)

#### Secure VPN communication with SIMATIC NET components

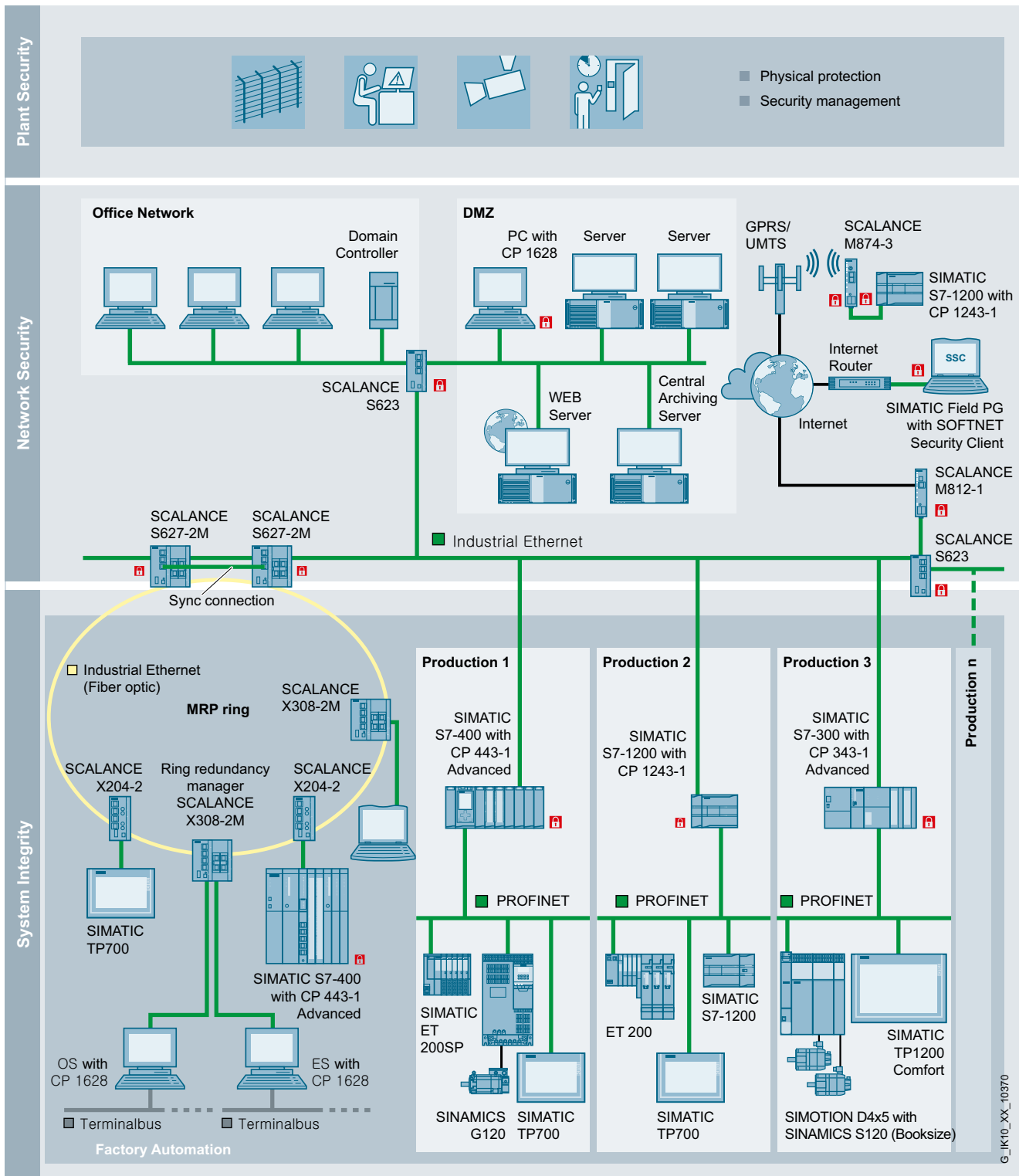

Secure VPN communication using Security Integrated components

7

G\_IK10\_XX\_10370

### Technical specifications

Article No.	6GK5874-2AA00-2AA2	6GK5874-3AA00-2AA2
Product-type designation	SCALANCE M874-2 2.5G	SCALANCE M874-3 3G
Transfer rate		
• 1 for Industrial Ethernet	10 Mbit/s	10 Mbit/s
• 2 for Industrial Ethernet	100 Mbit/s	100 Mbit/s
• for GSM transmission	-	-
• with GPRS transmission		
- with downlink maximum	85.6 kbit/s	85.6 kbit/s
- with uplink maximum	85.6 kbit/s	85.6 kbit/s
• with eGPRS transmission		
- with downlink maximum	236.8 kbit/s	236.8 kbit/s
- with uplink maximum	236.8 kbit/s	236.8 kbit/s
• with UMTS transmission		
- with downlink maximum	-	14.4 Mbit/s
- with uplink maximum	-	5.76 Mbit/s
<b>Interfaces</b>		
Number of electrical connections		
• for internal network	2	2
• for external network	1	1
• for power supply	2	2
Design of the electrical connection		
• for internal network	RJ45 port (10/100 Mbit/s, TP, autocrossover)	RJ45 port (10/100 Mbit/s, TP, autocrossover)
• for external network	SMA antenna socket (50 ohms)	SMA antenna socket (50 ohms)
• for power supply	Terminal strip	Terminal strip
<b>Signal-Inputs/outputs</b>		
Number of electrical connections		
• for digital input signals	1	1
• for digital output signals	1	1
Design of electrical connection		
• for digital input signals	Terminal block	Terminal block
• for digital output signals	Terminal block	Terminal block
<b>WAN connection</b>		
Type of mobile wireless network is supported GSM	Yes	Yes
Type of mobile wireless service is supported		
• GPRS	Yes	Yes
• eGPRS	Yes	Yes
Type of mobile wireless network is supported UMTS	No	Yes
Type of mobile service is supported HSPA+	-	Yes
Operating frequency for GSM transmission		
• 850 MHz	Yes	Yes
• 900 MHz	Yes	Yes
• 1800 MHz	Yes	Yes
• 1900 MHz	Yes	Yes
Operating frequency for UMTS transmission		
• 800 MHz	-	Yes
• 850 MHz	-	Yes
• 900 MHz	-	No
• 1700 MHz	-	Yes
• 1900 MHz	-	Yes
• 2100 MHz	-	Yes
<b>Supply voltage, current consumption, power loss</b>		
Type of supply voltage	DC	DC
Supply voltage	24 V	24 V
Supply voltage		
• minimum	10.8 V	10.8 V
• maximum	28.8 V	28.8 V

# Industrial Remote Communication

## Remote Networks

### IP-based modems and routers

#### SCALANCE M874 mobile wireless router

#### Technical specifications (continued)

Article No.	6GK5874-2AA00-2AA2	6GK5874-3AA00-2AA2
Product-type designation	SCALANCE M874-2 2.5G	SCALANCE M874-3 3G
<b>Permitted ambient conditions</b>		
Ambient temperature		
• during operating	-20 ... +60 °C	-20 ... +60 °C
• during storage	-40 ... +85 °C	-40 ... +85 °C
Relative humidity at 25 °C during operating maximum	95 %	95 %
Protection class IP	IP20	IP20
<b>Design, dimensions and weight</b>		
Design	compact	compact
Depth	127 mm	127 mm
Height	147 mm	147 mm
Width	35 mm	35 mm
Mounting type		
• 35 mm DIN rail mounting	Yes	Yes
• S7-300 rail mounting	Yes	Yes
• S7-1500 rail mounting	Yes	Yes
<b>Product properties, functions, components general</b>		
Product function		
• DynDNS client	Yes	Yes
• no-ip.com client	Yes	Yes
<b>Product functions management, configuration</b>		
Product function		
• CLI	No	No
• web-based management	Yes	Yes
• MIB support	Yes	Yes
• TRAPs via email	Yes	Yes
Protocol is supported		
• Telnet	No	No
• HTTP	Yes	Yes
• HTTPS	Yes	Yes
Type of configuration	Web-based management	Web-based management
<b>Product functions Diagnosis</b>		
Product function		
• Statistics Packet Size	No	No
• Statistics packet type	No	No
• Error statistics	No	No
• SysLog	Yes	Yes
• Packet Filter Log	Yes	Yes
<b>Product functions DHCP</b>		
Product function		
• DHCP client	Yes	Yes
• DHCP server - internal network	Yes	Yes
<b>Product functions Routing</b>		
Router function		
• NAT (IP masquerading)	Yes	Yes
• Port Forwarding	Yes	Yes
• NAT traversal	Yes	Yes
• 1:1 NAT	Yes	Yes
• DNS cache	Yes	Yes



**Technical specifications** (continued)

Article No.	6GK5874-2AA00-2AA2	6GK5874-3AA00-2AA2
Product-type designation	SCALANCE M874-2 2.5G	SCALANCE M874-3 3G
<b>Product functions Security</b>		
Design of the firewall	Stateful inspection	Stateful inspection
Product function		
• Password protection	Yes	Yes
• packet filter	Yes	Yes
• Broadcast/Multicast/Unicast Limiter	No	No
• broadcast blocking	No	No
Suitability for installation	Yes	Yes
Virtual Private Network		
Product function with VPN connection	-	-
Number of possible connections for VPN connection	20	20
Type of authentication with Virtual Private Network PSK	Yes	Yes
Protocol is supported IPsec tunnel and transport mode	Yes	Yes
Key length		
• with IPsec DES with Virtual Private Network	56 bit	56 bit
• 1 with IPsec AES with Virtual Private Network	128 bit	128 bit
• 2 with IPsec AES with Virtual Private Network	192 bit	192 bit
• 3 with IPsec AES with Virtual Private Network	256 bit	256 bit
Type of Internet key exchange with Virtual Private Network main mode	Yes	Yes
Key length with IPsec 3DES with Virtual Private Network	168 bit	168 bit
Type of Internet key exchange with Virtual Private Network quick mode	Yes	Yes
Type of packet authentication with Virtual Private Network	MD5, SHA-1	MD5, SHA-1
IETF profile with Virtual Private Network X.509v3 certificate	Yes	Yes
<b>Product functions Time</b>		
Protocol is supported		
• NTP	Yes	Yes
• SNTP	Yes	Yes
<b>Standards, specifications, approvals</b>		
Verification of suitability	-	-
• CE mark	Yes	Yes
• Railway application in accordance with EN 50155	No	No

# Industrial Remote Communication

## Remote Networks

### IP-based modems and routers

#### SCALANCE M874 mobile wireless router

##### Ordering data

##### Article No.

###### SCALANCE M874 mobile wireless router

Mobile wireless router for wireless IP communication from Industrial Ethernet-based subnets and programmable controllers via UMTS or GSM mobile networks; with integrated firewall and VPN with IPsec;  
2 x RJ45 ports,  
1 x antenna connection  
• **SCALANCE M874-3** <sup>1)</sup>  
• **SCALANCE M874-2** <sup>1)</sup>

**6GK5874-3AA00-2AA2**  
**6GK5874-2AA00-2AA2**

###### Accessories

###### IE FC RJ45 Plug 180

RJ45 plug connector for Industrial Ethernet with a rugged metal enclosure and integrated insulation displacement contacts for connecting Industrial Ethernet FC installation cables; with 180° cable outlet; for network components and CPs/CPU's with Industrial Ethernet interface

- 1 pack = 1 unit
- 1 pack = 10 units
- 1 pack = 50 units

**6GK1901-1BB10-2AA0**  
**6GK1901-1BB10-2AB0**  
**6GK1901-1BB10-2AE0**

###### ANT794-4MR antenna

Omnidirectional antenna for GSM (2G), UMTS (3G) and LTE (4G) networks; weather-resistant for indoor and outdoor use; 5 m cable with fixed connection to antenna; SMA connector; including mounting bracket, screws, wall plugs

**6NH9860-1AA00**

###### C-PLUG

Swap medium for simple replacement of devices in the event of a fault; for storing configuration or application data; can be used for SIMATIC NET products with C-PLUG slot

**6GK1900-0AB00**

###### IE TP Cord RJ45/RJ45

TP cable 4 x 2 with 2 RJ45 connectors

- 0.5 m
- 1 m
- 2 m
- 6 m
- 10 m

**6XV1870-3QE50**  
**6XV1870-3QH10**  
**6XV1870-3QH20**  
**6XV1870-3QH60**  
**6XV1870-3QN10**

<sup>1)</sup> Please note national approvals under <http://www.siemens.com/mobilenetwork-approvals>

##### Note:

Order data for further security products with firewall and VPN functionality can be found under Industrial Security

##### More information

You will find more information on the topic of Industrial Security on the Internet at:  
[www.siemens.com/industrialsecurity](http://www.siemens.com/industrialsecurity)

#### Overview



- Router for wireless IP communication between Industrial Ethernet-based programmable controllers via mobile radio networks of the 3rd generation (UMTS) and the 2nd generation (GSM)
- High data transfer rate thanks to HSDPA
- Integrated security functions with firewall
- Use as VPN end point (IPsec)

#### Benefits



- Low investment and operating costs for operator control and monitoring of wirelessly connected telecontrol substations
- Reduced travel costs and telephone charges thanks to remote programming and remote diagnosis via UMTS
- High level of security thanks to an integrated firewall and VPN with IPsec
- Utilization of existing UMTS/GSM infrastructure of the mobile radio providers
- Worldwide application

#### Application

- Can be used in industrial and semi-industrial applications due to its design and electrical properties
- Remote programming and maintenance worldwide, e.g. with STEP 7 via the high-speed UMTS interface
- Linking of mobile stations, with central monitoring and control
- Energy-saving concepts in distributed systems, e.g. through status-dependent speed control of pumps in remote stations
- Control and monitoring of
  - Sewage treatment plants, water treatment
  - Oil and gas supplies
  - District heating networks
  - Power distribution
  - Pumping stations
  - Transportation systems
  - Buildings
  - Wind energy and photovoltaic plants
- Connection of telecontrol substations (e.g. SINAUT ST7) to control center via UMTS
- Video transmission e.g. from moving vehicles such as buses and trains
- Can be used worldwide due to:
  - UMTS: Penta-band technology
  - GSM: Quad-band technology

#### Note:

Country-specific approvals must be observed.

Due to the integral security functions, the SCALANCE M875 UMTS router enables protected connection of distributed automation cells to a control center via the mobile wireless network, and it can be used within the scope of the Siemens Remote Service. This comprehensive service allows companies to task Siemens with the monitoring, control and maintenance of distant plants and machines via remote access.

#### Design

- Rugged plastic enclosure for standard rail mounting
- 2 x RJ45 interface with 10/100 Mbit/s for Industrial Ethernet
- Diagnostic LEDs for modem status, field strength, connection control, and DI/DO channels
- SET service button
- 4-pin screw terminal for connection to the 24 V DC power supply
- 4-pin screw terminal for one digital input and one digital output
- 2 x SMA antenna connection for up to two UMTS/GSM antennas for improved reception bandwidth on mobile objects thanks to antenna diversity
- Type approval as vehicle component in accordance with Directive 72/245/EEC in Version 2009/19/EC
- Type approval for use on rolling stock in accordance with EN 50155

## Industrial Remote Communication

### Remote Networks

#### IP-based modems and routers

##### SCALANCE M875 mobile wireless router

#### Function

- Pentaband UMTS with the frequency bands 800/850/1 700/1 900/2 100 MHz
- Quad-band GSM with the frequency bands 850/900/1 800/1 900 MHz
- Support for UMTS with HSDPA+ (downlink: 14.4 Mbit/s, uplink: 5.76 Mbit/s)
- Without UMTS network, automatic switchover to 2nd generation mobile radio data services, eGPRS or GPRS mode
- Automatic setup and holding of IP-based online connection to the Internet
- Merging of distributed, IP-based networks via UMTS/GSM mobile radio networks
- Bi-directional IP-based data communication with the telecontrol center, e.g. ST7cc or ST7sc, WinCC or PCS 7
- Integrated security functions with firewall (stateful inspection)
- Integrated IPsec VPN tunnel encryption
- Data exchange between telecontrol stations (slave-slave communication) via a TIM communication module in the service center
- Secure data communication with the SINAUT ST7 stations, also over mobile radio provider networks which do not provide public and fixed IP addresses for the modem
- Automatic and user-defined sending of text messages

#### Configuration

- User-friendly configuration of all network and firewall parameters of the router using the web browser

#### Security

- Router for data transmission via public networks with NAT functionality (NAT Traversal, NAT, 1:1-NAT)
- Suitable VPN termination of the control center via SCALANCE S
- Firewall for protection against unauthorized access; the dynamic packet filter checks data packets based on the source and target address (stateful inspection) and blocks undesirable data traffic (anti-spoofing)

#### Diagnostics / maintenance

- Status of connection buildup and of an existing connection via front LED display and web browser

#### Preconditions for using the SCALANCE M875 UMTS router

- SIM card from a UMTS network operator with HSDPA support, or alternatively a SIM card from a GSM network operator with eGPRS or GPRS support

## Integration

### Application example: SCALANCE M875 for remote maintenance with VPN tunnel

Classical applications such as remote programming, parameterization and diagnosis, but also monitoring of machines and plants installed worldwide can be performed securely via a VPN from a service center that is connected over the Internet. Access to any IP-based devices, especially IP-based programmable controllers, which are downstream of the SCALANCE M875 in the local network.

Multimedia applications like video streaming can be implemented thanks to the increased bandwidth in the uplink.

### Application example, broadband data transmission in vehicles with SCALANCE M875

The UMTS router SCALANCE M875, with its high down-link and uplink capacity, supports numerous data services with large bandwidth requirements via mobile wireless to and from vehicles. To increase the connection quality during motion, SCALANCE M875 is equipped with antenna diversity. Sensitive data can be transmitted in a secure VPN tunnel if required.

Video transmission in real time from the passenger cell is used to increase passenger safety (video surveillance). The video data from all vehicles is sent to a control center for monitoring and further processing.

In addition, applications such as data interfacing for ticket machines, infotainment services and internet on board, or proactive monitoring of vehicle engineering (telemetry) are also possible.

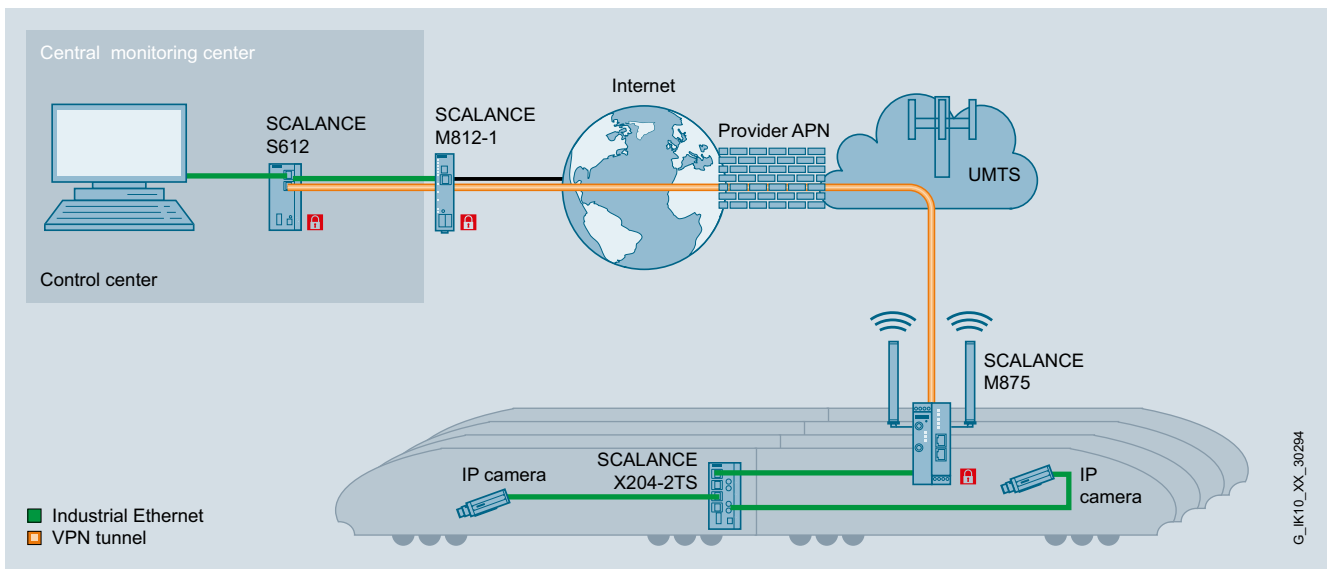

Broadband video data transmission over UMTS, protected via VPN, to increase passenger safety

# Industrial Remote Communication

## Remote Networks

### IP-based modems and routers

#### SCALANCE M875 mobile wireless router

#### Technical specifications

Article No.	6GK5875-0AA10-1AA2	6GK5875-0AA10-1CA2
Product-type designation	SCALANCE M875 UMTS ROUTER	SCALANCE M875 UMTS-ROUTER (J)
<b>Transmission rate</b>		
Transmission rate		
• 1 for Industrial Ethernet	10 Mbit/s	10 Mbit/s
• 2 for Industrial Ethernet	100 Mbit/s	100 Mbit/s
• for GSM transmission	9 600 bit/s	9 600 bit/s
• with GPRS transmission		
- with downlink maximum	85.6 kbit/s	85.6 kbit/s
- with uplink maximum	42.8 kbit/s	42.8 kbit/s
• with eGPRS transmission		
- with downlink maximum	236.8 kbit/s	236.8 kbit/s
- with uplink maximum	118 kbit/s	118 kbit/s
• with UMTS transmission		
- with downlink maximum	14.4 Mbit/s	14.4 Mbit/s
- with uplink maximum	5.76 Mbit/s	5.76 Mbit/s
• for EV-DO transmission		
- downlink maximum	-	-
- uplink maximum	-	-
<b>Interfaces</b>		
Number of electrical connections		
• for internal network	2	2
• for external network	2	2
• for power supply	1	1
Design of the electrical connection		
• for internal network	RJ45 port (10/100 Mbit/s, TP, autocrossover)	RJ45 port (10/100 Mbit/s, TP, autocrossover)
• for external network	SMA antenna socket (50 ohms)	SMA antenna socket (50 ohms)
• for power supply	Terminal strip	Terminal strip
<b>Signal-Inputs/outputs</b>		
Number of electrical connections		
• for digital input signals	1	1
• for digital output signals	1	1
Design of electrical connection		
• for digital input signals	Terminal strip	Terminal strip
• for digital output signals	Terminal strip	Terminal strip
<b>WAN connection</b>		
Type of mobile wireless network is supported GSM	Yes	Yes
Type of mobile wireless service is supported		
• GPRS	Yes	Yes
• eGPRS	Yes	Yes
Type of mobile wireless network is supported UMTS	Yes	Yes
Type of mobile wireless service is supported		
• HSDPA	-	-
• HSUPA	-	-
• HSPA+	Yes	Yes
• CDMA	-	-
• EV-DO	-	-
<b>Operating frequency</b>		
• for GSM transmission		
- 850 MHz	Yes	Yes
- 900 MHz	Yes	Yes
- 1800 MHz	Yes	Yes
- 1900 MHz	Yes	Yes
• for UMTS transmission		
- 800 MHz	Yes	Yes
- 850 MHz	Yes	Yes
- 900 MHz	No	Yes
- 1700 MHz	Yes	No
- 1900 MHz	Yes	Yes
- 2100 MHz	Yes	Yes

**Technical specifications** (continued)

Article No.	6GK5875-0AA10-1AA2	6GK5875-0AA10-1CA2
Product-type designation	SCALANCE M875 UMTS ROUTER	SCALANCE M875 UMTS-ROUTER (J)
<b>Supply voltage, current consumption, power loss</b>		
Type of supply voltage	DC	DC
Supply voltage		
• minimum	12 V	12 V
• maximum	30 V	30 V
Consumed current maximum	450 mA	450 mA
Active power loss typical	4 W	4 W
<b>Permitted ambient conditions</b>		
Ambient temperature		
• during operating	-40 ... +75 °C	-40 ... +75 °C
• during storage	-40 ... +85 °C	-40 ... +85 °C
Relative humidity at 25 °C during operating maximum	95 %	95 %
Protection class IP	IP20	IP20
<b>Design, dimensions and weight</b>		
Design	compact	compact
Depth	114 mm	114 mm
Height	99 mm	99 mm
Width	45 mm	45 mm
Net weight	280 g	280 g
Mounting type 35 mm DIN rail mounting	Yes	Yes
<b>Product properties, functions, components general</b>		
Product function		
• DynDNS client	Yes	Yes
• no-ip.com client	-	-
<b>Product functions management, configuration</b>		
Product function		
• CLI	No	No
• web-based management	Yes	Yes
• MIB support	No	No
• TRAPs via email	No	No
Protocol is supported		
• Telnet	No	No
• HTTP	No	No
• HTTPS	Yes	Yes
Type of configuration	Web-based management	Web-based management
<b>Product functions Diagnosis</b>		
Product function		
• Statistics Packet Size	No	No
• Statistics packet type	No	No
• Error statistics	No	No
• SysLog	Yes	Yes
• Packet Filter Log	Yes	Yes
<b>Product functions DHCP</b>		
Product function		
• DHCP client	Yes	Yes
• DHCP server - internal network	Yes	Yes
<b>Product functions Routing</b>		
Router function		
• NAT (IP masquerading)	Yes	Yes
• Port Forwarding	Yes	Yes
• NAT traversal	Yes	Yes
• 1:1 NAT	Yes	Yes
• DNS cache	Yes	Yes

# Industrial Remote Communication

## Remote Networks

### IP-based modems and routers

#### SCALANCE M875 mobile wireless router

#### Technical specifications (continued)

Article No.	6GK5875-0AA10-1AA2	6GK5875-0AA10-1CA2
Product-type designation	SCALANCE M875 UMTS ROUTER	SCALANCE M875 UMTS-ROUTER (J)
<b>Product functions Security</b>		
Design of the firewall	Stateful inspection	Stateful inspection
Product function		
• Password protection	Yes	Yes
• packet filter	Yes	Yes
• Broadcast/Multicast/Unicast Limiter	No	No
• broadcast blocking	No	No
Suitability for installation	Yes	Yes
Virtual Private Network		
Product function with VPN connection	-	-
Number of possible connections for VPN connection	10	10
Number of network stations for internal network with VPN connection maximum	-	-
Type of authentication with Virtual Private Network PSK	Yes	Yes
Protocol is supported IPsec tunnel and transport mode	Yes	Yes
Key length		
• with IPsec DES with Virtual Private Network	56 bit	56 bit
• 1 with IPsec AES with Virtual Private Network	128 bit	128 bit
• 2 with IPsec AES with Virtual Private Network	192 bit	192 bit
• 3 with IPsec AES with Virtual Private Network	256 bit	256 bit
Type of Internet key exchange with Virtual Private Network main mode	Yes	Yes
Key length with IPsec 3DES with Virtual Private Network	168 bit	168 bit
Type of Internet key exchange with Virtual Private Network quick mode	Yes	Yes
Type of packet authentication with Virtual Private Network	MD5, SHA-1	MD5, SHA-1
IETF profile with Virtual Private Network X.509v3 certificate	Yes	Yes
<b>Product functions Time</b>		
Protocol is supported		
• NTP	Yes	Yes
• SNTP	-	-
<b>Standards, specifications, approvals</b>		
Standard		
• for EMC	-	-
• for EMC from FM	-	-
• for hazardous zone	-	-
• for safety of CSA and UL	Yes	-
• for hazardous area of CSA and UL	-	-
• for emitted interference	EN55022 Class A	EN55022 Class A
• for interference immunity	EN 61000-6-2	EN 61000-6-2
Verification of suitability	EN 61000-6-2	EN 61000-6-2
• CE mark	Yes	-
• C-Tick	-	-
• E1 approval	Yes	-
• e1 approval	Yes	-
• Railway application in accordance with EN 50155	Yes	-



**Ordering data****Article No.****SCALANCE M875 mobile radio router**

Mobile radio router for wireless IP communication from Industrial Ethernet-based programmable controllers via UMTS/GSM mobile radio networks; EGPRS Multislot Class 12; with integrated firewall and VPN with IPsec; 2 x RJ45 ports, 2 x antenna connections

- **SCALANCE M875** <sup>1)</sup>
- **SCALANCE M875** <sup>1)</sup> for Japan

**6GK5875-0AA10-1AA2**  
**6GK5875-0AA10-1CA2**

**Accessories****IE FC RJ45 Plug 180**

RJ45 plug connector for Industrial Ethernet with a rugged metal enclosure and integrated insulation displacement contacts for connecting Industrial Ethernet FC installation cables; with 180° cable outlet; for network components and CPs/CPU's with Industrial Ethernet interface

- 1 pack = 1 unit
- 1 pack = 10 units
- 1 pack = 50 units

**6GK1901-1BB10-2AA0**  
**6GK1901-1BB10-2AB0**  
**6GK1901-1BB10-2AE0**

**ANT794-4MR antenna****6NH9860-1AA00**

Omnidirectional antenna for GSM (2G), UMTS (3G) and LTE (4G) networks; weather-resistant for indoor and outdoor use; 5 m cable with fixed connection to antenna; SMA connector; including mounting bracket, screws, wall plugs

**IE TP Cord RJ45/RJ45**

TP cable 4 x 2 with 2 RJ45 connectors

- 0.5 m
- 1 m
- 2 m
- 6 m
- 10 m

**6XV1870-3QE50**  
**6XV1870-3QH10**  
**6XV1870-3QH20**  
**6XV1870-3QH60**  
**6XV1870-3QN10**

<sup>1)</sup> Please note national approvals under <http://www.siemens.com/mobilenetwork-approvals>

**Note:**

Order data for further security products with firewall and VPN functionality can be found under Industrial Security

**More information**

You will find more information on the topic of Industrial Security on the Internet at:  
[www.siemens.com/industrialsecurity](http://www.siemens.com/industrialsecurity)

## Industrial Remote Communication

### Remote Networks

#### IP-based modems and routers

#### SCALANCE M812-1 and SCALANCE M816-1 ADSL routers

##### Overview



The SCALANCE M812-1 and M816-1 are DSL routers for low-cost and secure connection of Ethernet-based subnets and programmable controllers to wired telephone or DSL networks and support ADSL2+ (Asynchronous Digital Subscriber Line). This allows the devices to have high downlink data rates of up to 25 Mbit/s and uplink data rates of up to 3.5 Mbit/s.

The security of access and communication is ensured by the security functions of the integrated firewall and by VPN tunnels (end-to-end connection encryption through IPsec tunneling).

##### Product versions

###### SCALANCE M812-1:

- 1 x RJ45 interface with 10/100 Mbit/s for Industrial Ethernet
- Router functionality can be activated as required (PPPoE pass through); modem functionality as default value

###### SCALANCE M816-1:

- 4 x RJ45 interfaces with 10/100 Mbit/s for Industrial Ethernet
- Configuration data can be saved by means of the C-PLUG storage medium (not included in the scope of delivery)

##### Benefits



- High security standards by means of a firewall (stateful packet inspection) and VPN connections (IP-Sec) as an integral component of the Industrial Security concept
- Low investment and operating costs for operator control and monitoring of remotely connected substations
- Reduction in traveling costs and personnel costs due to remote programming and diagnostics via wired telephone or DSL networks
- Easy to use with existing infrastructure
- Improved manageability thanks to mechanical integration due to the design (module format) with S7-1500 / ET 200MP
- Wide application area thanks to large bandwidth, high performance and speed
- Worldwide application

##### Application

The SCALANCE M812-1 and M816-1 are suitable for industrial and semi-industrial applications:

- Worldwide remote programming and servicing, e.g. using STEP 7 via mobile wireless
- Worldwide flexible plant access for servicing and diagnostics purposes
- Connection of static stations for controlling and monitoring such things as
  - Water/wastewater treatment plants
  - Oil and gas supplies
  - District heating networks
  - Power distribution
  - Pumping stations
  - Transportation systems
- Worldwide condition monitoring, e.g. for
  - Wind energy and photovoltaic plants

##### Note:

Due to the integral security functions, the SCALANCE M812-1 and M816-1 DSL routers enable a protected connection of distributed automation cells to a control center via wired telephone or DSL networks and it can be used within the scope of the Siemens Remote Service. This comprehensive service allows companies to task Siemens with the monitoring, control and maintenance of distant plants and machines via remote access.

##### Design

- Available as Annex A (DSL over POTS) and Annex B (DSL over ISDN) version
- The rugged plastic enclosure supports the following mounting methods:
  - S7-1500 mounting rail
  - S7-300 mounting rail
  - DIN rail mounting
  - Wall mounting
- 1 x or 4 x RJ45 interfaces with 10/100 Mbit/s for Industrial Ethernet
- Diagnostic LEDs for modem status, connection control, and DI/DO channels
- SET button
- 5-pin screw terminal for redundant connection to the 24 V DC power supply
- 2-pin screw terminal for a digital input
- 2-pin screw terminal for a digital output
- 1 x RJ45 connection for ADSL2+

#### Function

- Automatic setup and holding of IP-based online connection to the Internet
- Merging of distributed, IP-based networks via wired telephone or DSL networks
- Bi-directional IP-based data communication with a telecontrol center, e.g. ST7cc or ST7sc, WinCC or PCS 7
- Integrated security functions with firewall (stateful inspection)
- Integrated IPsec VPN tunnel encryption
- Data exchange between telecontrol stations (slave-slave communication) via a TIM communication module in the service center
- Secure data communication with the SINAUT ST7 stations

#### Configuration

- User-friendly configuration of all network and firewall parameters of the router using the web browser
  - CLI (Command Line Interface) available soon
  - Integration in TIA Portal available soon

#### Security

- Router for data transmission via public networks with NAT functionality (NAT Traversal, NAT, 1:1-NAT)
- VPN termination
  - By means of IPsec protocol
  - OpenVPN available soon
- Firewall for protection against unauthorized access; the dynamic packet filter checks data packets based on the source and target address (Stateful Inspection)

#### Diagnostics / maintenance

- Connection buildup status and status of an existing connection via front LED display

#### Preconditions for using the SCALANCE M812-1 and 816-1 DSL routers

- Contract with a DSL provider with ADSL/ADSL2/ADSL2+ support
- Clarification in advance with the DSL provider about Annex A and Annex B support is required

#### Integration

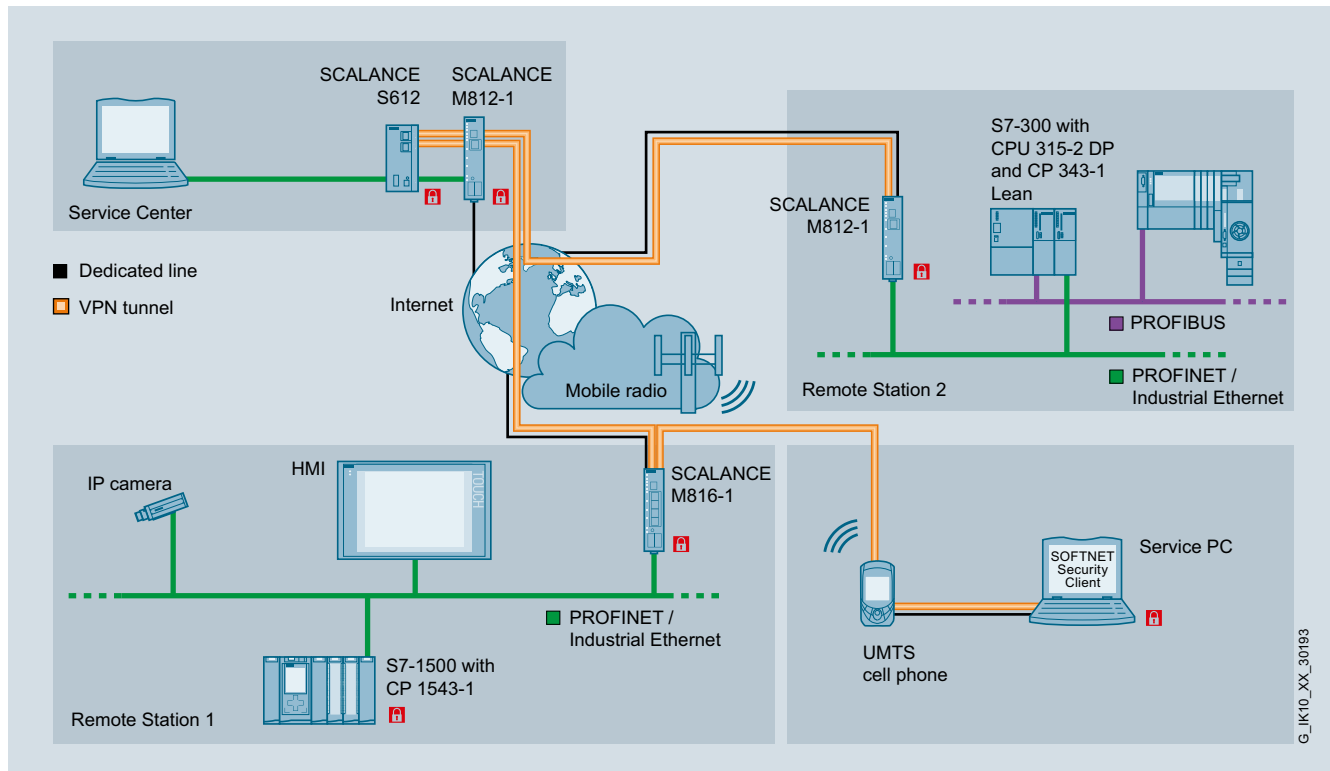

# Industrial Remote Communication

## Remote Networks

### IP-based modems and routers

#### SCALANCE M812-1 and SCALANCE M816-1 ADSL routers

#### Technical specifications

Article No.	6GK5812-1AA00-2AA2	6GK5812-1BA00-2AA2	6GK5816-1AA00-2AA2	6GK5816-1BA00-2AA2
Product-type designation	SCALANCE M812-1 ADSL2+ (Annex A)	SCALANCE M812-1 ADSL2+ (Annex B)	SCALANCE M816-1 ADSL2+ (Annex A)	SCALANCE M816-1 ADSL2+ (Annex B)
<b>Transmission rate</b>				
Transmission rate				
• 1 for Industrial Ethernet	10 Mbit/s	10 Mbit/s	10 Mbit/s	10 Mbit/s
• 2 for Industrial Ethernet	100 Mbit/s	100 Mbit/s	100 Mbit/s	100 Mbit/s
• for ADSL2+ transmission				
- downlink maximum	25 Mbit/s	25 Mbit/s	25 Mbit/s	25 Mbit/s
- uplink maximum	1.4 Mbit/s	1.4 Mbit/s	1.4 Mbit/s	1.4 Mbit/s
• for SHSDL transmission maximum	-	-	-	-
<b>Interfaces</b>				
Number of electrical connections				
• for internal network	1	1	4	4
• for external network	1	1	1	1
Design of the electrical connection				
• for internal network	RJ45 port (10/100 Mbit/s, TP, autocrossover)	RJ45 port (10/100 Mbit/s, TP, autocrossover)	RJ45 port (10/100 Mbit/s, TP, autocrossover)	RJ45 port (10/100 Mbit/s, TP, autocrossover)
• for external network	RJ45 port	RJ45 port	RJ45 port	RJ45 port
<b>Signal-Inputs/outputs</b>				
Number of electrical connections				
• for digital input signals	1	1	1	1
• for digital output signals	1	1	1	1
Design of electrical connection				
• for digital input signals	Terminal block	Terminal block	Terminal block	Terminal block
• for digital output signals	Terminal block	Terminal block	Terminal block	Terminal block
<b>WAN connection</b>				
Type of WAN connection is supported				
• ADSL	Yes	Yes	Yes	Yes
• ADSL2	Yes	Yes	Yes	Yes
• ADSL2+	Yes	Yes	Yes	Yes
Operating mode for ADSL2/ADSL2+ is supported				
• Annex A	Yes	No	Yes	No
• Annex I	Yes	Yes	Yes	Yes
• Annex L	Yes	Yes	Yes	Yes
• Annex B	No	Yes	No	Yes
• Annex J	Yes	Yes	Yes	Yes
• Annex M	Yes	Yes	Yes	Yes
Type of WAN connection is supported SHSDL	-	-	-	-
<b>Supply voltage, current consumption, power loss</b>				
Type of supply voltage	DC	DC	DC	DC
Supply voltage	24 V	24 V	24 V	24 V
Supply voltage				
• minimum	10.8 V	10.8 V	10.8 V	10.8 V
• maximum	28.8 V	28.8 V	28.8 V	28.8 V
Consumed current maximum	-	-	-	-
Active power loss maximum	8 W	8 W	8 W	8 W

#### Technical specifications (continued)

Article No.	6GK5812-1AA00-2AA2	6GK5812-1BA00-2AA2	6GK5816-1AA00-2AA2	6GK5816-1BA00-2AA2
Product-type designation	SCALANCE M812-1 ADLSL2+ (Annex A)	SCALANCE M812-1 ADLSL2+ (Annex B)	SCALANCE M816-1 ADLSL2+ (Annex A)	SCALANCE M816-1 ADLSL2+ (Annex B)
<b>Permitted ambient conditions</b>				
Ambient temperature				
• during operating	0 ... 60 °C	0 ... 60 °C	0 ... 60 °C	0 ... 60 °C
• during storage	-40 ... +70 °C	-40 ... +70 °C	-40 ... +70 °C	-40 ... +70 °C
Relative humidity at 25 °C during operating maximum	95 %	95 %	95 %	95 %
Protection class IP	IP20	IP20	IP20	IP20
<b>Design, dimensions and weight</b>				
Design	compact	compact	compact	compact
Depth	127 mm	127 mm	127 mm	127 mm
Height	147 mm	147 mm	147 mm	147 mm
Width	35 mm	35 mm	35 mm	35 mm
Net weight	400 g	400 g	400 g	400 g
Mounting type				
• 35 mm DIN rail mounting	Yes	Yes	Yes	Yes
• S7-300 rail mounting	Yes	Yes	Yes	Yes
• S7-1500 rail mounting	Yes	Yes	Yes	Yes
• wall mounting	Yes	Yes	Yes	Yes
Mounting type	-	-	-	-
<b>Product properties, functions, components general</b>				
Product function				
• DynDNS client	Yes	Yes	Yes	Yes
• no-ip.com client	Yes	Yes	Yes	Yes
<b>Product functions management, configuration</b>				
Product function				
• CLI	No	No	No	No
• web-based management	Yes	Yes	Yes	Yes
• MIB support	Yes	Yes	Yes	Yes
• TRAPs via email	Yes	Yes	Yes	Yes
Protocol is supported				
• Telnet	No	No	No	No
• HTTP	Yes	Yes	Yes	Yes
• HTTPS	Yes	Yes	Yes	Yes
Type of configuration	Web-based management	Web-based management	Web-based management	Web-based management
<b>Product functions Diagnosis</b>				
Product function				
• Statistics Packet Size	No	No	No	No
• Statistics packet type	No	No	No	No
• Error statistics	No	No	No	No
• SysLog	Yes	Yes	Yes	Yes
• Packet Filter Log	Yes	Yes	Yes	Yes
<b>Product functions DHCP</b>				
Product function				
• DHCP client	Yes	Yes	Yes	Yes
• DHCP server - internal network	Yes	Yes	Yes	Yes
<b>Product functions Routing</b>				
Router function				
• NAT (IP masquerading)	Yes	Yes	Yes	Yes
• Port Forwarding	Yes	Yes	Yes	Yes
• NAT traversal	Yes	Yes	Yes	Yes
• 1:1 NAT	Yes	Yes	Yes	Yes
• DNS cache	Yes	Yes	Yes	Yes

# Industrial Remote Communication

## Remote Networks

### IP-based modems and routers

#### SCALANCE M812-1 and SCALANCE M816-1 ADSL routers

#### Technical specifications (continued)

Article No.	6GK5812-1AA00-2AA2	6GK5812-1BA00-2AA2	6GK5816-1AA00-2AA2	6GK5816-1BA00-2AA2
Product-type designation	SCALANCE M812-1 ADLSL2+ (Annex A)	SCALANCE M812-1 ADLSL2+ (Annex B)	SCALANCE M816-1 ADLSL2+ (Annex A)	SCALANCE M816-1 ADLSL2+ (Annex B)
<b>Product functions Security</b>				
Design of the firewall	Stateful inspection	Stateful inspection	Stateful inspection	Stateful inspection
Product function				
• Password protection	Yes	Yes	Yes	Yes
• packet filter	Yes	Yes	Yes	Yes
• Broadcast/Multicast/Unicast Limiter	No	No	No	No
• broadcast blocking	No	No	No	No
Suitability for installation Virtual Private Network	Yes	Yes	Yes	Yes
Product function with VPN connection	-	-	-	-
Number of possible connections for VPN connection	20	20	20	20
Number of network stations for internal network with VPN connection maximum	-	-	-	-
Type of authentication with Virtual Private Network PSK	Yes	Yes	Yes	Yes
Protocol is supported IPsec tunnel and transport mode	Yes	Yes	Yes	Yes
Key length				
• with IPsec DES with Virtual Private Network	56 bit	56 bit	56 bit	56 bit
• 1 with IPsec AES with Virtual Private Network	128 bit	128 bit	128 bit	128 bit
• 2 with IPsec AES with Virtual Private Network	192 bit	192 bit	192 bit	192 bit
• 3 with IPsec AES with Virtual Private Network	256 bit	256 bit	256 bit	256 bit
Type of Internet key exchange with Virtual Private Network main mode	Yes	Yes	Yes	Yes
Key length with IPsec 3DES with Virtual Private Network	168 bit	168 bit	168 bit	168 bit
Type of Internet key exchange with Virtual Private Network quick mode	Yes	Yes	Yes	Yes
Type of packet authentication with Virtual Private Network	MD5, SHA-1	MD5, SHA-1	MD5, SHA-1	MD5, SHA-1
IETF profile with Virtual Private Network X.509v3 certificate	Yes	Yes	Yes	Yes
<b>Product functions Time</b>				
Protocol is supported				
• NTP	Yes	Yes	Yes	Yes
• SNTP	Yes	Yes	Yes	Yes
<b>Standards, specifications, approvals</b>				
Standard				
• for EMC	-	-	-	-
• for EMC from FM	-	-	-	-
• for hazardous zone	-	-	-	-
• for safety of CSA and UL	-	-	-	-
• for hazardous area of CSA and UL	-	-	-	-
• for emitted interference	-	-	-	-
• for interference immunity	-	-	-	-
Verification of suitability				
• CE mark	Yes	Yes	Yes	Yes
• C-Tick	-	-	-	-
• E1 approval	-	-	-	-
• e1 approval	-	-	-	-
• Railway application in accordance with EN 50155	-	-	-	-

Ordering data	Article No.	More information
<p><b>SCALANCE M81x-1 DSL router</b></p> <p>DSL router for wired IP communication from Industrial Ethernet-based subnets and programmable controllers via telephone or DSL networks; with integrated firewall and VPN with IPsec; 1 x or 4 x RJ45 ports for Industrial Ethernet, 1 x RJ45 port for DSL</p> <ul style="list-style-type: none"> <li>• <b>SCALANCE M812-1 (Annex A)</b></li> <li>• <b>SCALANCE M812-1 (Annex B)</b></li> <li>• <b>SCALANCE M816-1 (Annex A)</b></li> <li>• <b>SCALANCE M816-1 (Annex B)</b></li> </ul>	<p><b>6GK5812-1AA00-2AA2</b></p> <p><b>6GK5812-1BA00-2AA2</b></p> <p><b>6GK5816-1AA00-2AA2</b></p> <p><b>6GK5816-1BA00-2AA2</b></p>	<p>You will find more information on the topic of Industrial Security on the Internet at: <a href="http://www.siemens.com/industrialsecurity">www.siemens.com/industrialsecurity</a></p>
<p><b>Accessories</b></p> <p><b>IE FC RJ45 Plug 180</b></p> <p>RJ45 plug connector for Industrial Ethernet with a rugged metal enclosure and integrated insulation displacement contacts for connecting Industrial Ethernet FC installation cables; with 180° cable outlet; for network components and CPs/CPU's with Industrial Ethernet interface</p> <ul style="list-style-type: none"> <li>• 1 pack = 1 unit</li> <li>• 1 pack = 10 units</li> <li>• 1 pack = 50 units</li> </ul>	<p><b>6GK1901-1BB10-2AA0</b></p> <p><b>6GK1901-1BB10-2AB0</b></p> <p><b>6GK1901-1BB10-2AE0</b></p>	
<p><b>C-PLUG</b></p> <p>Swap medium for simple replacement of devices in the event of a fault; for storing configuration data; can be used in SIMATIC NET products with PLUG compartment</p>	<p><b>6GK1900-0AB00</b></p>	
<p><b>IE TP Cord RJ45/RJ45</b></p> <p>TP cable 4 x 2 with 2 RJ45 connectors</p> <ul style="list-style-type: none"> <li>• 0.5 m</li> <li>• 1 m</li> <li>• 2 m</li> <li>• 6 m</li> <li>• 10 m</li> </ul>	<p><b>6XV1870-3QE50</b></p> <p><b>6XV1870-3QH10</b></p> <p><b>6XV1870-3QH20</b></p> <p><b>6XV1870-3QH60</b></p> <p><b>6XV1870-3QN10</b></p>	

**Note:**

Order data for further security products with firewall and VPN functionality can be found under Industrial Security

## Industrial Remote Communication

### Remote Networks

#### IP-based modems and routers

##### SCALANCE M826-2 SHDSL router

### Overview



The SCALANCE M826-2 is an SHDSL modem for low-cost, secure connection of Ethernet-based subnets and programmable controllers via existing two-wire or stranded cables and supports the ITU-T standard G.991.2 as well as SHDSL.biz (single-pair high-speed digital subscriber line). This gives the device high symmetrical data rates of up to 15.3 Mbit/s per wire pair.

The security of access and communication is ensured by the security functions of the integrated firewall and by VPN tunnels (end-to-end connection encryption through IPsec tunneling).

### Benefits

- High security standards by means of a firewall (Stateful Packet Inspection) and VPN connections (IP-Sec) as an integral component of the Industrial Security concept
- Low investment and operating costs for operator control and monitoring of remotely connected substations
- Protection of investments: Continued use of existing cable infrastructure for Ethernet transfer up to a distance of at least 10 km
- Simple and low-cost migration from classical remote communication to IP-based remote communication
- Alternative use instead of optical communication for Ethernet transfer over long distances using two-wire lines
- Improved manageability thanks to mechanical integration due to the design (module format) with S7-1500 / ET200MP
- Wide application area thanks to large bandwidth, high performance and speed
- Worldwide application

### Application

The SCALANCE M826-2 can be used in industrial and semi-industrial applications:

- Remote programming and servicing, e.g. using STEP 7 via two-wire lines
- Connection of static stations for controlling and monitoring such things as
  - Water/wastewater treatment plants
  - Oil and gas supplies
  - District heating networks
  - Power distribution
  - Pumping stations
  - Transportation systems

### Design

- The rugged plastic enclosure supports the following mounting methods:
  - S7-1500 mounting rail
  - S7-300 mounting rail
- DIN rail mounting
  - Wall mounting
- 4 x RJ45 interfaces with 10/100 Mbit/s for Industrial Ethernet
- Diagnostic LEDs for modem status, connection control, and DI/DO channels
- SET button
- 5-pole screw terminal for redundant connection to the 24 V DC power supply
- 2-pole screw terminal for a digital input
- 2-pole screw terminal for a digital output
- 2 x 2-pole screw terminal for connecting to one twin wire each for SHDSL communication

### Function

- Automatic setup and maintaining of IP-based connection via two-wire lines
- Merging of distributed, IP-based networks via two or multi-wire line infrastructure
- Bi-directional IP-based data communication with a telecontrol center, e.g. ST7cc or ST7sc, WinCC or PCS 7
- Integrated security functions with firewall (Stateful Inspection)
- Integrated IPsec VPN tunnel encryption
- Data exchange between telecontrol stations (slave-slave communication) via a TIM communication module in the service center
- Secure data communication with the SINAUT ST7 stations

get **Designed for Industry**



#### Function (continued)

##### Data rates depending on the distance

- The resulting data rate depends on the following parameters
  - The length of a two-wire line
  - The cross-section of the two-wire line
  - Age and quality of the two-wire line used

Distance [km]	Bandwidth [Mbit/s] (copper core pair with a diameter of 0.6 mm <sup>2</sup> )	Bandwidth [Mbit/s] (copper core pair with a diameter of 1.4 mm <sup>2</sup> )
0.2	13.3	14.0
0.5	11.8	13.2
1	9.24	11.6
2.5	4.47	7.92
5	1.33	4.18
7.5	0.40	2.21
10	0.124	1.20

##### Supported topologies

- Point-to-point connection
- Aggregation of two twin wires as a virtual connection with double data rate
- Setup of line topologies

##### Configuration

- User-friendly configuration of all network and firewall parameters of the router using the web browser
  - CLI (Command Line Interface) available soon
  - Integration in TIA Portal available soon

##### Security

- Router for data transmission via private two-wire line infrastructures with NAT functionality (NAT Traversal, NAT, 1:1-NAT)
- Standardized VPN termination of the control center
  - By means of IPsec protocol
  - OpenVPN available soon
- Firewall for protection against unauthorized access; the dynamic packet filter checks data packets based on the source and target address (Stateful Inspection)

##### Diagnostics / maintenance

- Connection buildup status and status of an existing connection via front LED display

#### Integration

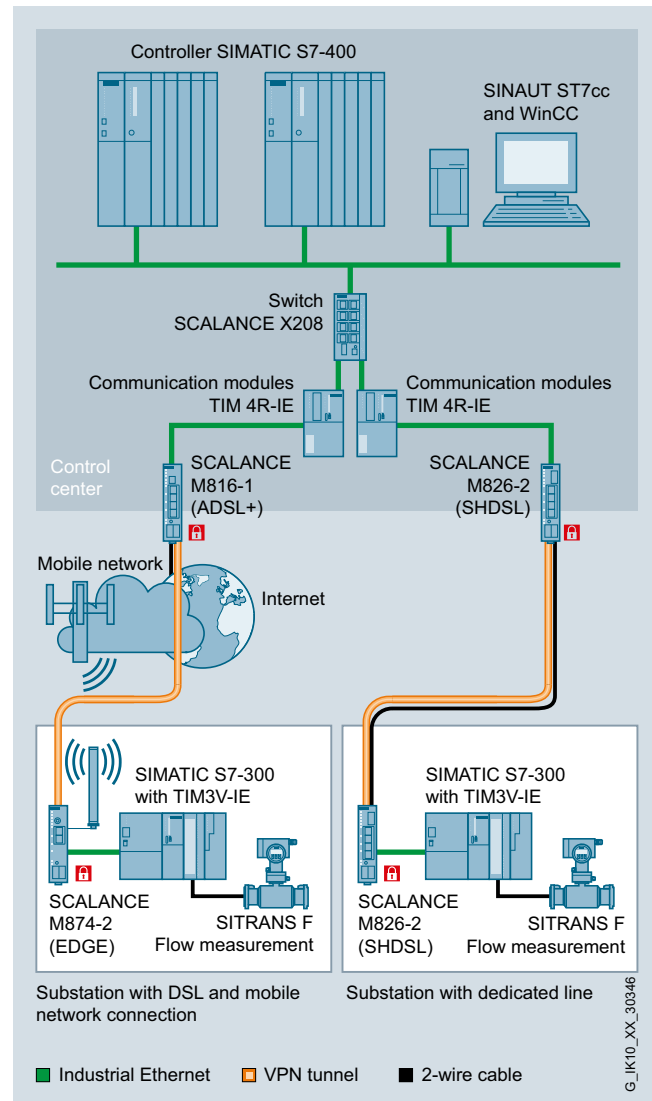

Connecting telecontrol substations to the telecontrol center using SCALANCE M routers

#### Application example for SCALANCE M826-2

The application examples given here show a typical telecontrol application with Telecontrol Professional, consisting of a telecontrol center with ST7cc/ST7sc. The following example shows a TIM 4R-IE that is connected via one of its two Ethernet interfaces with the control center PC (e.g. ST7cc). SINAUT stations are connected over the second Ethernet port using the SCALANCE M826-2 over SHDSL two-wire lines.

It is possible to operate up to 30 SINAUT dedicated line modems on this port. If the stations in this network have to be provided with the date and time, the control center PC assumes the function of the clock-time master. Via the Ethernet connection, the TIM 4R-IE is regularly synchronized by the PC and it then takes over the synchronization of the connected stations.

# Industrial Remote Communication

## Remote Networks

### IP-based modems and routers

#### SCALANCE M826-2 SHDSL router

#### Technical specifications

Article No.	6GK5826-2AB00-2AB2
Product-type designation	SCALANCE M826-2 SHDSL
<b>Transmission rate</b>	
Transfer rate	
• 1 for Industrial Ethernet	10 Mbit/s
• 2 for Industrial Ethernet	100 Mbit/s
Transmission rate for SHDSL transmission maximum	15.3 Mbit/s
<b>Interfaces</b>	
Number of electrical connections	
• for internal network	4
• for external network	2
Design of the electrical connection	
• for internal network	RJ45 port (10/100 Mbit/s, TP, autocrossover)
• for external network	Terminal strip
<b>Signal-Inputs/outputs</b>	
Number of electrical connections	
• for digital input signals	1
• for digital output signals	1
Design of electrical connection	
• for digital input signals	Terminal block
• for digital output signals	Terminal block
<b>WAN connection</b>	
Type of WAN connection is supported SHSDL	Yes
<b>Supply voltage, current consumption, power loss</b>	
Type of supply voltage	DC
Supply voltage	24 V
Supply voltage	
• minimum	10.8 V
• maximum	28.8 V
Consumed current maximum	-
Active power loss maximum	8 W
<b>Permitted ambient conditions</b>	
Relative humidity at 25 °C during operating maximum	95 %
Protection class IP	IP 20

Article No.	6GK5826-2AB00-2AB2
Product-type designation	SCALANCE M826-2 SHDSL
<b>Design, dimensions and weight</b>	
Design	compact
Depth	127 mm
Height	147 mm
Width	35 mm
Net weight	-
Mounting type	
• 35 mm DIN rail mounting	Yes
• S7-300 rail mounting	Yes
• S7-1500 rail mounting	Yes
• wall mounting	Yes
<b>Product properties, functions, components general</b>	
Product function	
• DynDNS client	Yes
• no-ip.com client	Yes
<b>Product functions management, configuration</b>	
Product function	
• CLI	No
• web-based management	Yes
• MIB support	Yes
• TRAPs via email	Yes
Protocol is supported	
• Telnet	No
• HTTP	Yes
• HTTPS	Yes
Type of configuration	Web-based management
<b>Product functions Diagnosis</b>	
Product function	
• Statistics Packet Size	No
• Statistics packet type	No
• Error statistics	No
• SysLog	Yes
• Packet Filter Log	Yes
<b>Product functions DHCP</b>	
Product function	
• DHCP client	Yes
• DHCP server - internal network	Yes
<b>Product functions Routing</b>	
Router function	
• NAT (IP masquerading)	Yes
• Port Forwarding	Yes
• NAT traversal	Yes
• 1:1 NAT	Yes
• DNS cache	Yes

#### Technical specifications (continued)

Article No.	6GK5826-2AB00-2AB2
<b>Product-type designation</b>	<b>SCALANCE M826-2 SHDSL</b>
<b>Product functions Security</b>	
Design of the firewall	Stateful inspection
Product function	
• Password protection	Yes
• packet filter	Yes
• Broadcast/Multicast/Unicast Limiter	No
• broadcast blocking	No
Suitability for installation	Yes
Virtual Private Network	
Product function with VPN connection	Yes
Number of possible connections for VPN connection	20
Number of network stations for internal network with VPN connection maximum	-
Type of authentication with Virtual Private Network PSK	Yes
Protocol is supported IPsec tunnel and transport mode	Yes
Key length	
• with IPsec DES with Virtual Private Network	56 bit
• 1 with IPsec AES with Virtual Private Network	128 bit
• 2 with IPsec AES with Virtual Private Network	192 bit
• 3 with IPsec AES with Virtual Private Network	256 bit
Type of Internet key exchange with Virtual Private Network main mode	Yes
Key length with IPsec 3DES with Virtual Private Network	168 bit
Type of Internet key exchange with Virtual Private Network quick mode	Yes
Type of packet authentication with Virtual Private Network	MD5, SHA-1
IETF profile with Virtual Private Network X.509v3 certificate	Yes
<b>Product functions Time</b>	
Protocol is supported	
• NTP	Yes
• SNTP	Yes
<b>Standards, specifications, approvals</b>	
Verification of suitability	
• CE mark	Yes

#### Ordering data

#### Article No.

##### SCALANCE M826-2 DSL router

DSL router for wired IP communication from Industrial Ethernet-based subnets and programmable controllers via telephone or DSL networks; with integrated firewall and VPN with IPsec; 1 x or 4 x RJ45 ports for Industrial Ethernet; 1 x RJ45 port for DSL

- SCALANCE M826-2 (Annex A)

**6GK5826-2AB00-2AB2**

##### Accessories

##### IE FC RJ45 Plug 180

RJ45 plug connector for Industrial Ethernet with a rugged metal enclosure and integrated insulation displacement contacts for connecting Industrial Ethernet FC installation cables; with 180° cable outlet; for network components and CPs/CPU's with Industrial Ethernet interface

- 1 pack = 1 unit
- 1 pack = 10 units
- 1 pack = 50 units

**6GK1901-1BB10-2AA0**  
**6GK1901-1BB10-2AB0**  
**6GK1901-1BB10-2AE0**

##### C-PLUG

Swap medium for simple replacement of devices in the event of a fault; for storing configuration data; can be used in SIMATIC NET products with PLUG compartment

**6GK1 900-0AB00**

##### IE TP Cord RJ45/RJ45

TP cable 4 x 2 with 2 RJ45 connectors

- 0.5 m
- 1 m
- 2 m
- 6 m
- 10 m

**6XV1870-3QE50**  
**6XV1870-3QH10**  
**6XV1870-3QH20**  
**6XV1870-3QH60**  
**6XV1870-3QN10**

##### Note:

Order data for further security products with firewall and VPN functionality can be found under Industrial Security

#### More information

You will find more information on the topic of Industrial Security on the Internet at:

<http://www.siemens.com/industrialsecurity>

To assist in selecting the right products for Industrial Wireless Communication, the SIMATIC NET Selection Tool is available at: <http://www.siemens.com/snst>

## Industrial Remote Communication

### Remote Networks

#### Modems for the conventional telephone network

##### Overview



SINAUT MD3 modem

Modems are used for wired transmission of signals and data between individual stations and the control center of a tele-control system. Siemens offers appropriate modems for both dedicated lines and dial-up networks.

Like the TIM modules, these are accommodated in an S7-300 enclosure:

- **MD2;**  
dedicated-line modem for multi-point connection, can be tapped, can also be used as a repeater, max. 19 200 bps
- **MD3;**  
modem for the analog telephone network, max. 33 600 bps; can also be used as a dedicated-line modem for a point-to-point connection, max. 33 600 bps in voice band

These modems can be connected to the serial modem interface of a TIM module.

The modems are supplied together with the WAN connecting cable required in each case. Connecting cables for connecting the modems to a TIM must be ordered separately.

##### Benefits

get **Designed for Industry**

- Diverse application options for use in dedicated-line networks or for conventional telephone networks (analog, ISDN, GSM)
- Matched to the telecontrol system by means of the design of the SIMATIC S7-300
- Electrical isolation between power supply and WAN interface

##### Application

The modems can be used in other applications as dedicated-line modems or dial-up modems independently of the SINAUT ST7 system.

Due to the design and the electrical properties, the modems are suited above all for applications in the industrial sector.

##### Design

All three modem types are identically designed and offer all the advantages of the SIMATIC S7-300 design:

- Compact construction; double standard width of SIMATIC S7-300 SM modules
- RJ12 socket for connecting the modem to the WAN (leased line or dialup network)
- 9-pin Sub-D connector with an RS232 interface for connection to the serial interface of a communication module, e.g. TIM
- 9-pin Sub-D socket with an RS 485 interface for connection to the serial interface of a communication module, e.g. TIM
- 4-pin plug-in terminal strip for connection of the 24 V DC external supply voltage
- Front-panel LEDs indicating TXD, RXD, DTR, RTS/ONL, CTS/RI and DCD
- Simple installation; on a mounting rail of the S7-300, or on a 35 mm standard rail
- The SINAUT ST7 modems can be operated without a fan

#### Design (continued)

#### Configuration examples

An MDx modem is connected to a TIM by means of a standard connecting cable of type 7701. The modem is mounted on a separate S7-300 mounting rail or on a 35 mm standard mounting rail (an appropriate adapter is available).

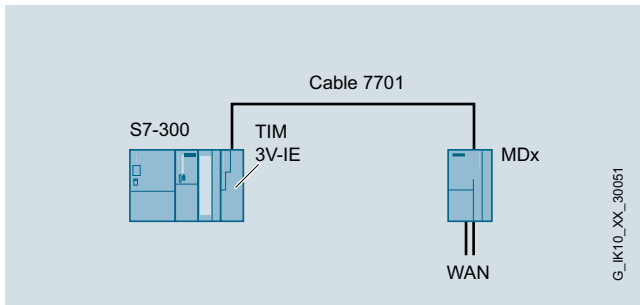

In the following configuration, the modem is accommodated to the far right in the rack. The TIM is connected to the adjacent module by means of a bus connector. There is no bus connector between TIM and modem. This means that no S7 modules may be used immediately to the right of the modem.

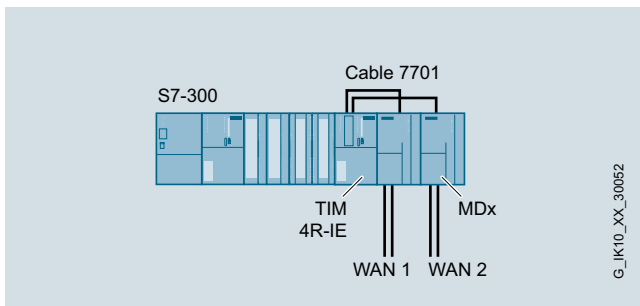

In an S7-400 with TIM 4R-IE the TIM and modem are mounted together on a separate S7-300 mounting rail. The TIM is connected to the CPU by means of one of its Ethernet interfaces. The TIM and MDx modem are connected by means of a standard connecting cable of type 7701.

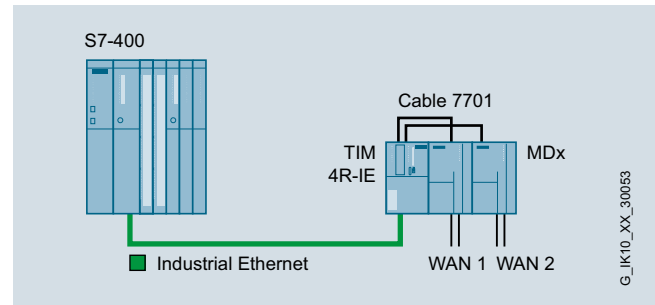

The following configuration shows the connection of a point-to-point dedicated line network to a TIM 4R-IE, which is used as a control center TIM, for example on the control center PC (e.g. SINAUT ST7cc or ST7sc). Each cable belonging to the point-to-point network is terminated with a modem in the control center. All these modems are connected by means of their RS485 interface to the RS232/RS485 interface of the TIM 4R-IE.

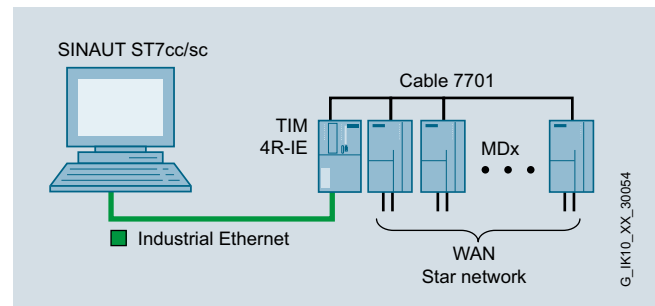

## Industrial Remote Communication

### Remote Networks

#### Modems for the conventional telephone network

#### MD2 dedicated line modem

#### Overview



- Frequency-modulated (FSK) dedicated line modem;
- Half-duplex data transfer over 2-wire dedicated line, duplex data transfer over 4-wire dedicated line
- Thanks to the modem's relaying ability, lines with several connected stations can also be implemented. The MD2 can also be used as repeater on 2-wire and 4-wire dedicated lines.
- Private or leased telephone lines can be used as dedicated lines. The MD2 is also suitable for connection to a radio device with modem input.

#### Benefits



- RS 232 and RS 485 interface
- Isolation between voltage supply and RS 232/RS 485 interface
- 4 different transmission rates to select
- Supports tandem stations
- Integrated double transformer for the connection of two 2-wire lines
- Integrated repeater function for multiplication of range
- Suitable for connection to a wireless device with modem input

#### Application

The MD2 modem can be used as a dedicated-line modem independently of the SINAUT ST7 system. Due to its design and the electrical properties, the MD2 is especially suited for use in the industrial sector.

Examples of use outside the SINAUT ST7 system:

- Extension of Profibus and MPI links; see FAQ 23671172 (for PB) or 23671640 (for MPI)
- As leased line modem for S7-200; see Micro Automation Set MAS 17

The MD2 enables distances of up to 33 km (at 1 200 bit/s), 27 km (at 2 400 bit/s) and up to 11 km (at 9 600 and 19 200 bit/s) to be spanned without amplifiers/repeaters (guide values for uncoiled communication cable of type 2 x 2 x 0.8 J-Y(St)Y). By interconnecting two MD2 modems to a repeater, the specified distances can be extended several times.

The MD2 modem permits the construction of network structures in the "point-to-point", "star" or "linear" configurations, as well as combinations of these basic structures. If the modem is used in the control center, a small star network comprising two 2-wire cables can be connected at the modem output. By connecting several MD2s (max. 32) by means of their RS 485 interfaces, the star network can be expanded to a multiple of 2 x 2-wire.

For the arrangement of an MD2 along a line, the modem output can be switched to high impedance. This reduces the insertion loss to a minimum and thus only marginally reduces the maximal bridgeable distance. The very short transmitter make-times ensure a prompt execution of the data traffic with the "polling" used in the dedicated line network.

Apart from private dedicated lines, the MD2 can also be connected to Telekom leased lines. Corresponding approval exists. In the case of exclusively analog leased lines, the transmission rates 1 200 and 2 400 bit/s are possible, whereas for analog/digital-converted leased lines the speed is usually limited to 1 200 bit/s for technical reasons.

The MD2 is also ideal for data transmission via a walkie-talkie with modem input. In order to switch the walkie-talkie on and off via its PTT input, a floating optical relay is integrated in the MD2 modem that is linked with the RTS signal of the RS 232 interface. The two connections of the optical relay are available on the RJ12 socket.

As walkie-talkies usually only transmit voice signals in the 300 to 3 000 Hz frequency range, the transmission rate with the MD2 modem is limited here to 1 200 bit/s. For 2 400 bit/s, the frequency range would have to exceed 3 300 Hz.

#### Design

The MD2 modem offers all the advantages of the SIMATIC S7-300 design:

- Compact construction; double standard width of SIMATIC S7-300 SM modules
- RJ12 socket for connecting the modem to the dedicated line
- 9-pin Sub-D connector with an RS 232 interface for connecting the modem to the RS 232/RS 485 interface of the TIM
- 9-pin Sub-D connector with an RS485 interface for connecting the modem to the RS232/RS485 interface of the TIM
- 4-pin plug-in terminal strip for connection of the 24 V DC external supply voltage
- Front-panel LEDs indicating TXD, RXD, DTR, RTS/ONL, CTS/RI and DCD
- Easy installation; the modem is mounted on an S7-300 mounting rail; alternatively, it can be mounted on a 35 mm standard rail using the adapter 6NH7760-OAA0, available separately.
- The modem can be operated without a fan.

#### Integration

Various ways in which the MD2 modem can be connected to a TIM or other MD2 modems, as well as to the dedicated line (via an LTOP overvoltage protection module), are illustrated below.

##### Connection of an MD2 to a TIM via the RS 232 interface

One MD2 modem can be connected to a TIM via the RS232 interface. This technique can be used to set up "point-to-point" and "line" network configurations as well as a small star network (only with TIM 4) with only two 2-wire lines.

##### Connection of several MD2s to a TIM via the RS 485 interface

Several MD2 modems can be connected to a TIM 4 via the RS 485 interface. This type of interconnection is used if a number of dedicated lines have to be combined on a single WAN port on the TIM, i.e. if a star topology is connected, as illustrated schematically below.

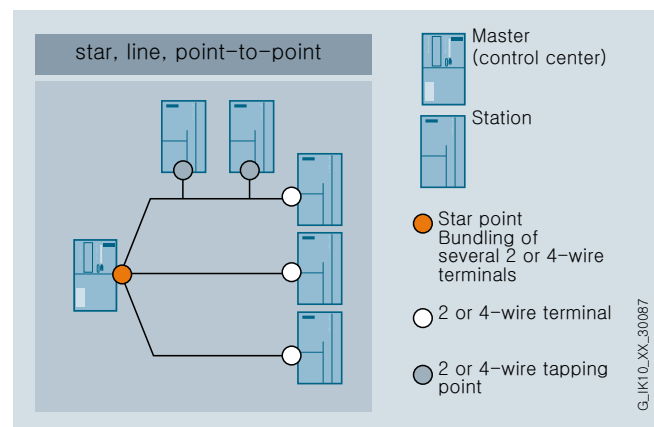

##### Calculating the maximum range (in km) based on transmission rate and wire diameter

The table below can be used to calculate approximate values for the maximum distance in km which can be covered by the MD2 modem, depending on transmission rate and wire diameter.

The values in the table are guide values for non-coil-loaded message lines type 2 x 2 x A J-Y(St)Y (A = core diameter in mm).

A level reserve of 4 dB was applied when calculating the maximum ranges. This should ensure that even in the event of deviations in cable characteristics, which experience has shown to be possible during operation, the level will always be sufficient to ensure fault-free data transmission.

# Industrial Remote Communication

## Remote Networks

### Modems for the conventional telephone network

#### MD2 dedicated line modem

#### Integration (continued)

Transfer rate (bps)	Maximum range (km)			
	Transmission level -6 dB <sup>1)</sup>		Transmission level 0 dB <sup>1)</sup>	
	With LTOP	Without LTOP	With LTOP	Without LTOP
<i>Core diameter 0.6 mm</i>				
1 200	21.7 – AST x 0.6	22 – AST x 0.3	25.7 – AST x 0.6	26 – AST x 0.3
2 400	17.6 – AST x 0.4	17.8 – AST x 0.2	20.8 – AST x 0.4	21 – AST x 0.2
9 600 / 19 200	7.2 – AST x 0.6	7.6 – AST x 0.1	8.6 – AST x 0.6	9 – AST x 0.1
<i>Core diameter 0.8 mm</i>				
1 200	28.3 – AST x 0.7	28.6 – AST x 0.4	33.5 – AST x 0.7	33.9 – AST x 0.4
2 400	23.2 – AST x 0.5	23.5 – AST x 0.2	27.5 – AST x 0.5	27.8 – AST x 0.2
9 600 / 19 200	9.6 – AST x 0.7	10.3 – AST x 0.1	11.5 – AST x 0.7	12.1 – AST x 0.1
<i>Core diameter 0.9 mm</i>				
1 200	36.2 – AST x 0.9	36.6 – AST x 0.5	42.8 – AST x 0.9	43.3 – AST x 0.5
2 400	29.6 – AST x 0.6	30 – AST x 0.2	35 – AST x 0.6	35.4 – AST x 0.2
9 600 / 19 200	11.9 – AST x 0.9	12.6 – AST x 0.1	14.2 – AST x 0.9	15 – AST x 0.1
<i>Core diameter 1.2 mm</i>				
1 200	50.1 – AST x 1.3	50.7 – AST x 0.7	59.3 – AST x 1.3	60 – AST x 0.7
2 400	43.4 – AST x 0.8	44 – AST x 0.3	51.4 – AST x 0.8	52 – AST x 0.3
9 600 / 19 200	17.2 – AST x 1.3	18.3 – AST x 0.2	20.5 – AST x 1.3	21.6 – AST x 0.2
<i>Core diameter 1.4 mm</i>				
1 200	59.2 – AST x 1.5	60 – AST x 0.8	70.1 – AST x 1.5	70.9 – AST x 0.8
2 400	54.3 – AST x 1	55 – AST x 0.4	64.3 – AST x 1	65 – AST x 0.4
9 600 / 19 200	20.6 – AST x 1.5	22 – AST x 0.2	24.6 – AST x 1.5	26 – AST x 0.2

AST = number of tandem stations

<sup>1)</sup> Not possible on leased telephone lines. Set transmission level to -9 dB.



# Industrial Remote Communication

## Remote Networks

### Modems for the conventional telephone network

#### MD2 dedicated line modem

#### Technical specifications

Article No.	6NH7810-0AA20
Product-type designation	MD 2 dedicated line modem
Interfaces	<ul style="list-style-type: none"> <li>• Connection for dedicated line: 1 x RJ12</li> <li>• RS232 connection for data terminal equipment: 1 x 9-pin Sub-D connector</li> <li>• RS485 connection for data terminal equipment: 1 x 9-pin Sub-D socket</li> <li>• Connection for supply voltage: 1 x 4-pin terminal block</li> </ul>
Voltage supply	24 V DC
Current consumption	100 mA
Power loss	2.4 W
Permissible ambient conditions	<ul style="list-style-type: none"> <li>• Operating temperature: 0 °C ... +60 °C</li> <li>• Transport/storage temperature: -40 °C ... +70 °C</li> <li>• Relative humidity: max. 95 % at +25 °C</li> </ul>
Design	<ul style="list-style-type: none"> <li>• Module format: Compact module S7-300, double width</li> <li>• Dimensions (W x H x D) in mm: 80 x 125 x 120</li> <li>• Weight: approx. 300 g</li> </ul>
Degree of protection	IP20
Transmission path	2-wire, 2 x 2-wire or 4-wire, twisted pair cable, non-coil-loaded or lightly coil-loaded
Modulation method	Phase-continuous binary frequency modulation (FSK)
Data transmission rates via the dedicated line	1 200 bit/s 2 400 bit/s 9 600 bit/s (not for leased telephone lines) 19 200 bit/s (not for leased telephone lines)

Article No.	6NH7810-0AA20
Product-type designation	MD 2 dedicated line modem
Operating mode	<ul style="list-style-type: none"> <li>• 2-wire or 2 x 2-wire: Half-duplex</li> <li>• 4-wire: Duplex or half-duplex</li> </ul>
Transmission level can be set to	0 dB -6 dB -9 dB (for leased telephone lines) -15 dB
Receiving level	0 ... -43 dB
Adjustable terminating resistor	<ul style="list-style-type: none"> <li>• for 1200 and 2400 bit/s: 600 ohms</li> <li>• for 9600 and 19200 bit/s: 150 ohms</li> <li>• for tapping point: &gt; 6 kOhms</li> </ul>
Clear to send	<ul style="list-style-type: none"> <li>• at 1200 bit/s: after 7 ms</li> <li>• at 2400 bit/s: after 4 ms</li> <li>• at 9600 and 19200 bit/s: after 0.5 ms</li> </ul>
Minimum/maximum scanning frequency	<ul style="list-style-type: none"> <li>• at 1200 bit/s: 1 300 Hz/2 100 Hz</li> <li>• at 2400 bit/s: 2 400 Hz/3 300 Hz</li> <li>• at 9600 and 19200 bit/s: 20 800 Hz/33 600 Hz</li> </ul>
Asynchronous character format	10 or 11 bit
Floating opto-relay output	<ul style="list-style-type: none"> <li>• Max. supply voltage: 60 V AC/DC</li> <li>• Max. perm. continuous current: 400 mA</li> <li>• Max. <math>R_{on}</math>: 3 ohms</li> </ul>
Impulse strength	$U_{1,2/50}$ acc. to DIN VDE 0804 between power supply circuit and <ul style="list-style-type: none"> <li>• Power supply circuit and FSK trunk line circuits: 2.5 kV</li> <li>• Power supply circuit and opto-relay output: 2.5 kV</li> </ul>
Compatible with SINAUT modems	<ul style="list-style-type: none"> <li>• MD100: at 1 200 bit/s</li> <li>• MD124: at 1 200, 2 400 and 19 200 bit/s</li> </ul>
Approvals	EU approval CE 0682 X

#### Ordering data

MD2 dedicated line modem	Article No.
For multi-point connection, supports tandem stations, can also be used as a repeater, max. 19 200 bit/s; incl. WAN connecting cable (RJ12/RJ12) for connecting the modem with an LTOP overvoltage protection module	<b>6NH7810-0AA20</b>
Connecting cable	Article No.
For connecting a TIM with one of the SINAUT ST7 MD2, MD3 modems Cable length 1.5 m	
<ul style="list-style-type: none"> <li>• RS 232</li> <li>• RS 485 (not for TIM 3V-IE)</li> </ul>	<b>6NH7701-4AL</b> <b>6NH7701-4DL</b>

#### Accessories

Connecting cable	Article No.
For connecting two MD2 modems (RS 232) in order to create a repeater; cable length 0.3 m	<b>6NH7701-1CB</b>
Line transformer with overvoltage protection	Article No.
<ul style="list-style-type: none"> <li>• LTOP1 for 2-wire terminal</li> <li>• LTOP2 for 4-wire terminal, 2 x 2-wire terminal or 2-wire tandem station</li> </ul>	<b>6NH9821-0BC11</b> <b>6NH9821-0BC12</b>
Adapters	Article No.
For mounting the MD2 modem on a 35 mm standard mounting rail	<b>6NH7760-0AA</b>
SITOP compact 24 V/0.6 A	Article No.
1-phase power supply with wide-range input 85 ... 264 V AC/110 ... 300 V DC, stabilized output voltage 24 V, rated output current value 0.6 A, slim design	<b>6EP1331-5BA00</b>

## Industrial Remote Communication

### Remote Networks

### Modems for the conventional telephone network

#### MD3 telephone modem

##### Overview



- Dial-up modem for data transfer using the analog telephone network
- It can also be used as a dedicated line modem. Duplex data transfer is thus possible in the voice band over 2-wire dedicated lines.
- Private or leased telephone lines can be used as dedicated lines.

##### Benefits

**get** Designed for Industry

- RS 232 and RS 485 interface
- Isolation between voltage supply and RS 232/RS 485 interface
- Transmission rate on the telephone network and dedicated line max. 33 600 bit/s

##### Application

The MD3 modem can be used as a telephone modem or dedicated-line modem independently of the SINAUT ST7 system. Due to its design and electrical properties, the MD3 is especially suited for use in the industrial sector.

##### Telephone modem

When used as a telephone modem, it enables connections to be set up with other MD3 or compatible modems, e.g. with the MD125 and MDM2425B DX modems that were used with the SINAUT ST1 system.

##### Dedicated-line modem:

Apart from private dedicated lines, the MD3 can also be connected to Telekom leased lines. Corresponding approval exists. There are no restrictions in terms of the possible transmission rates either with exclusively analog leased lines or with analog/digital converted leased lines.

When used as a dedicated-line modem on private lines, the MD3 enables distances of up to 34 km (at 300 bit/s), 28 km (at 1 200 to 19 200 bit/s) and up to 19 km (at 33 600 bit/s) to be spanned without amplifiers/repeaters (guide values for uncoiled communication cable of type 2 x 2 x 0.8 J-Y(St)Y).

When connected to Telekom leased lines, any distance can be spanned. Depending on the quality of the leased line in each case, the leased line provider guarantees sufficient reception signal level at both end points. The line qualities M1020 and M1025 are recommended.

Used as a dedicated-line modem, the MD3 enables networks to be constructed in "point-to-point" or "star" configurations. If the modem is used in the central office, the star network can be expanded to as many as 32 point-to-point connections by linking several MD3 modems via their RS485 interface.

##### Design

The MD3 modem offers all the advantages of the SIMATIC S7-300 design:

- Compact construction; double standard width of SIMATIC S7-300 SM modules
- RJ12 socket for connecting the modem via the supplied connecting cable to the telephone jack or the dedicated line
- 9-pin Sub-D connector with an RS 232 interface for connecting the modem to the RS 232/RS 485 interface of the TIM
- 9-pin Sub-D connector with an RS 485 interface for connecting the modem to the RS 232/RS 485 interface of the TIM
- 4-pin plug-in terminal strip for connection of the 24 V DC external supply voltage
- Front-panel LEDs indicating TXD, RXD, DTR, RTS/ONL, CTS/RI and DCD
- Easy installation; the modem is mounted on an S7-300 mounting rail; alternatively, it can be mounted on a 35 mm standard rail using the adapter 6NH7760-0AA, available separately.
- The modem can be operated without a fan.

#### Integration

The diagrams below illustrate how the MD3 modem and the TIM module can be connected to the telephone outlet and which configurations are possible when the modem is used as a dedicated-line modem.

#### Telephone modem: Connection of the MD3 with a TIM and TAE6 telephone outlet

The diagram below illustrates how the MD3 modem, when operating in dial-up mode and using the standard connecting cable specified (the connecting cable is part of the scope of supply of the MD3), is connected to a TIM (via RS232) as well as to the telephone outlet (TAE6N socket). A telephone can be connected to the same telephone outlet in parallel with the modem (via the TAE6F socket).

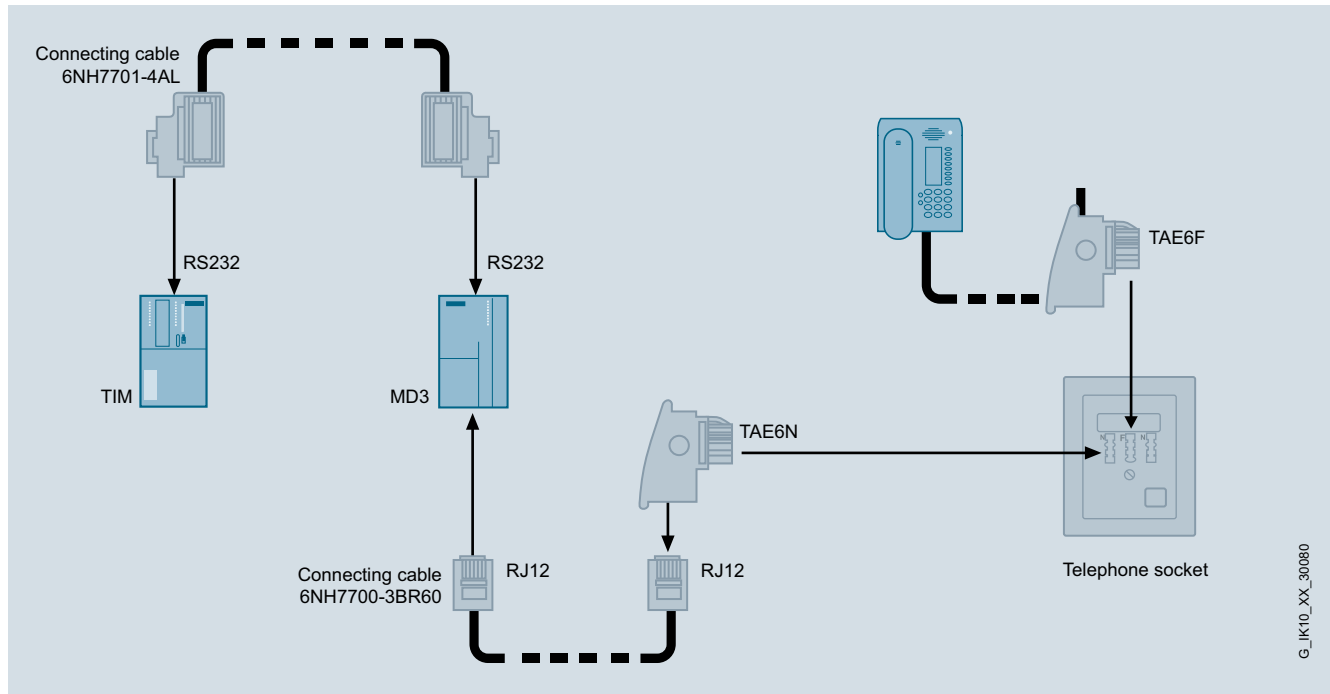

Connection of a MD3 with a TIM and TAE6 telephone outlet

#### Dedicated-line modem: Connection of an MD3 to a TIM via the RS 232 interface

One MD3 modem can be connected to a TIM via the RS 232 interface. This technique can be used to set up a "point-to-point" network configuration.

#### Dedicated-line modem: Connection of several MD3 to a TIM via the RS 485 interface

Several MD3 modems can be connected to a TIM via the RS 485 interface. This type of interconnection is used if several dedicated lines have to be combined on a single WAN port on the TIM, i.e. if a point-to-point network is connected.

#### Dedicated-line modem: Maximum range (in km) of the MD3 modem

The table below can be used to calculate approximate values for the maximum distance in km which can be covered by the MD3 modem, depending on transfer rate. The values in the table are guide values for non-coil-loaded message lines type 2 x 2 x 0.8 J-Y(St)Y.

A level reserve of 4 dB was applied when calculating the maximum ranges. This should ensure that even in the event of deviations in cable characteristics, which experience has shown to be possible during operation, the level will always be sufficient to ensure fault-free data transmission.

Transfer rate (bps)	Maximum range (km)			
	Transmission level -15 dB		Transmission level -10 dB	
	With LTOP	Without LTOP	With LTOP	Without LTOP
With terminating resistor Z = Zr				
300	29	30	34	35
1 200 to 19 200	23	24	28	29
33 600	14	15	19	20

# Industrial Remote Communication

## Remote Networks

### Modems for the conventional telephone network

#### MD3 telephone modem

#### Technical specifications

Article No.	6NH7810-0AA30
Product-type designation	MD3 telephone modem
Interfaces	
• Connection for telephone network or dedicated line	1 x RJ12
• RS 232 connection for data terminal equipment	1 x 9-pin Sub-D connector
• RS 485 connection for data terminal equipment	1 x 9-pin Sub-D socket
• Connection for supply voltage	1 x 4-pin terminal block
Voltage supply	24 V DC
Current consumption	
• from 24 V DC	200 mA
Power loss	4.8 W
Permissible ambient conditions	
• Operating temperature	0 °C ... +60 °C
• Transport/storage temperature	-40 °C ... +70 °C
• Relative humidity	max. 95 % at +25 °C
Design	
• Module format	Compact module S7-300, double width
• Dimensions (W x H x D) in mm	80 x 125 x 120
• Weight	approx. 300 g
Degree of protection	IP20
Transmission path	Analog dial-up telephone network Dedicated line, 2-wire twisted pair cable, non-coil-loaded
Available ITU transmission standards in analog telephone network	
• V.22	1 200 bit/s, duplex
• V.22 up to	2 400 bit/s, duplex
• V.32 up to	4 800 bit/s, duplex
• V.32 up to	9 600 bit/s, duplex
• V.32 up to	14 400 bit/s, duplex
• V.34 up to	19 200 bit/s, duplex
• V.34 up to	33 600 bit/s, duplex
Error correction	V.42 and MNP4
Data compression	V.42bis and MNP5
Modem control	AT commands V.25bis commands

Article No.	6NH7810-0AA30
Product-type designation	MD3 telephone modem
Telephone charge pulse filter can be set to:	12 kHz 16 kHz
Dial-up procedure	Voice frequency dialing Pulse dialing
Loop current component	Available; can be connected and disconnected
Loudspeaker	Available; can be connected and disconnected
Line matching	600 ohms Zr (frequency-dependent)
Transmission level can be set to	-10 dB -15 dB
Asynchronous character format	10 or 11 bits
Standard dedicated-line profiles	300 bit/s (direct) 1 200 bit/s (direct) 2 400 bit/s (direct) 9 600 bit/s (direct) 19 200 bit/s (direct) 19 200 bit/s (buffered) 33 600 bit/s (buffered)
Compatible with SINAUT modems (as telephone modem)	
• MD125	
- V.22	1 200 bit/s, duplex
- V.22 up to	2 400 bit/s, duplex
• MDM2425B DX	
- V.22 up to	2 400 bit/s, duplex
• MD3 (HW version < 4)	
- V.22	1 200 bit/s, duplex
- V.22 up to	2 400 bit/s, duplex
- V.32 up to	4 800 bit/s, duplex
- V.32 up to	9 600 bit/s, duplex
- V.32 up to	14 400 bit/s, duplex
Approvals	Europe U.S.A. Canada
Recommended line quality on leased telephone lines	M1020 M1025

#### Ordering data

**MD3 telephone modem**  
For the analog telephone network, max. 33 600 bit/s; can also be used as a dedicated-line modem for a point-to-point connection, max. 33 600 bit/s in voice band; incl. WAN connecting cable (RJ12 -RJ12/TAE6) with snap-on TAE6N connector for connecting the modem to a telephone outlet (TAE6N or RJ12) or an LTOP overvoltage protection module (for dedicated-line operation)

**Article No.**  
**6NH7810-0AA30**

#### Accessories

##### Connecting cable

For connecting a TIM with one of the SINAUT ST7 MD2, MD3 modems  
Cable length 1.5 m

- RS 232
- RS 485 (not for TIM 3V-IE)

**6NH7701-4AL**  
**6NH7701-4DL**

##### Line transformer with overvoltage protection (for dedicated line only)

- **LTOP1**  
for 2-wire terminal

**6NH9821-0BC11**

##### Adapters

For mounting the MD3 modem on a 35 mm standard mounting rail

**6NH7760-0AA**

##### SITOP compact 24 V/0.6 A

1-phase power supply with wide-range input  
85 ... 264 V AC/110 ... 300 V DC, stabilized output voltage 24 V, rated output current value 0.6 A, slim design

**6EP1331-5BA00**



## Industrial Remote Communication

### Accessories for remote networks

#### LTOP overvoltage protection

##### Function

The combination of arresters and limiters supplemented by the line transformer is more effective than galvanically-coupled protection concepts.

Leakage voltages place considerable strain on protective components in the OPM, slowly destroying them beyond repair. We therefore recommend that OPMs are replaced approximately once a year. In areas affected by frequent thunderstorms, this should be reduced to approximately every 6 months as a precautionary measure.

##### Integration

If necessary, several LTOP enclosures can be interconnected.

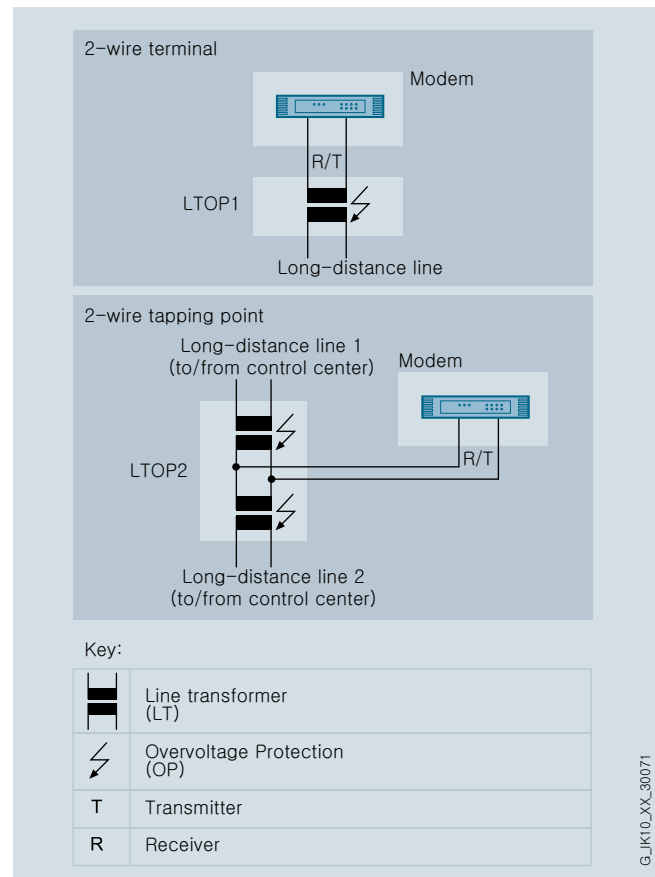

Configuration examples with LTOP

### Technical specifications

<b>Article No.</b>	<b>6NH9821-0BC11/6NH9821-0BC12</b>			
<b>Product-type designation</b>	<b>LTOP overvoltage protection</b>			
Transmission paths	Private non-coil-loaded or coil-loaded trunk lines			
Transmission ratio	1 : 1; ± 5% (e.g. 600/600 ohms in voice band)			
Transfer range	300 Hz ... 35 kHz			
Frequency-dependent attenuation	Attenuation [dB]	Frequency [Hz]	Transmission rate [bps]	
	0.2	1 300 ... 3 300	MD2 1 200 2 400	MD3 all
	1.0	20 800 ... 30 600	9 600 19 200	
Insulation resistance	> 2 000 MOhms			
Test voltage	4 kV, 50 Hz, 10 sec			
Impulse withstand voltage	6 kV/2 J acc. to EN 60 099-1			
Rated discharge current $i_{sn}$ (8/20 $\mu$ s)	5 kA			
Output voltage limit at $i_{sn}$	approx. 15 V			
Trunk line connection	Screw terminals Cross-section 0.2 – 4 mm <sup>2</sup> with rigid cores Cross-section 0.2 – 2.5 mm <sup>2</sup> with flexible cores			
Modem connection	Screw terminals (wire cross-section see trunk line connection) or RJ12 socket for Western connector			
Installation location	As near as possible to where the cable enters the building			
Perm. ambient conditions	<ul style="list-style-type: none"> <li>• Operating temperature 0 °C ... +60 °C</li> <li>• Transport/storage temperature -40 °C ... +70 °C</li> <li>• Relative humidity Max. 95% at +25 °C</li> </ul>			
Construction	<ul style="list-style-type: none"> <li>• Dimensions (W x H x D) in mm 90 x 75 x 110 mm</li> <li>• Weight <ul style="list-style-type: none"> <li>- LTOP1 300 g</li> <li>- LTOP2 320 g</li> <li>- OPM 10 g</li> </ul> </li> </ul>			
Degree of protection	IP20			
Installation	DIN rail TS35 (35 mm; EN 50 022)			

### Ordering data

#### Article No.

#### LTOP 1 overvoltage protection

**6NH9821-0BC11**

Single line transformer, with one OPM overvoltage protection module for use at the start or end of a 2-wire line

#### LTOP 2 overvoltage protection

**6NH9821-0BC12**

2-way line transformer with two overvoltage protection modules (OPM) for use at the beginning or at the end of a 4-wire cable or at a 2-wire grading point.

#### Accessories

#### OPM

**6NH9821-0BB00**

Overvoltage protection module for LTOP1 and LTOP2, plug-in (pack of 4)

## Industrial Remote Communication

### Accessories for remote networks

#### ANT794-4MR 2G / 3G / 4G antenna

##### Overview



- Omnidirectional antenna for use in GSM/GPRS/UMTS/LTE networks
- Remote antenna for indoors/outdoors
- Suitable for quad band
- Complete with cable and mounting bracket for direct connection to SINAUT GPRS modems

##### Benefits

**get** Designed for Industry

- Weatherproof design allows installation outside buildings to improve the field strength
- Quad band technology permits international use

##### Application

- For use in GSM/GPRS/UMTS/LTE networks
- For indoors/outdoors (IP65 degree of protection)
- Operating temperature -40 °C to 70°C

##### Design

- Radiator accommodated in a plastic tube for protection
- RF cable with fixed connection to antenna
- Fixed and rugged vertical installation outside control cabinet

##### Technical specifications

<b>Article No.</b>	<b>6NH9860-1AA00</b>
<b>Product-type designation</b>	<b>ANT794-4MR antenna</b>
<b>Wireless frequencies</b>	
Type of mobile wireless network is supported	
• GSM	Yes
• UMTS	Yes
• LTE	Yes
Operating frequency	
• 800 MHz (LTE)	Yes
• 850 MHz	Yes
• 900 MHz	Yes
• 1 800 MHz	Yes
• 1 900 MHz	Yes
• 2 200 MHz	Yes
• 2 600 MHz (LTE)	Yes
<b>Electrical data</b>	
Radiation characteristic	omnidirectional
Antenna gain	0 dB
Standing wave ratio VSWR maximum	2
Number of electrical connections of antenna	1
Design of electrical connection of antenna	SMA connector
Front-to-back ratio	-
Transmit power maximum	20 W
<b>Permitted ambient conditions</b>	
Ambient temperature during operating	-40 ... +70 °C
Protection class IP	IP65
<b>Design, dimensions and weight</b>	
Width	24 mm
Height	193 mm
Depth	24 mm
Diameter	24 mm
Net weight	310 g
Type of mounting	
Cable length of antenna cable	5 m
<b>Product properties, functions, components general</b>	
Material of outer shell	Hard PVC, UV-resistant



### Ordering data

### Article No.

#### GSM/GPRS antenna

#### ANT794-4MR antenna

Omnidirectional antenna for GSM (2G), UMTS (3G) and LTE (4G) networks; weather-resistant for indoor and outdoor use; 5 m cable with fixed connection to antenna; SMA connector; including mounting bracket, screws, wall plugs

6NH9860-1AA00

### Dimensional drawings

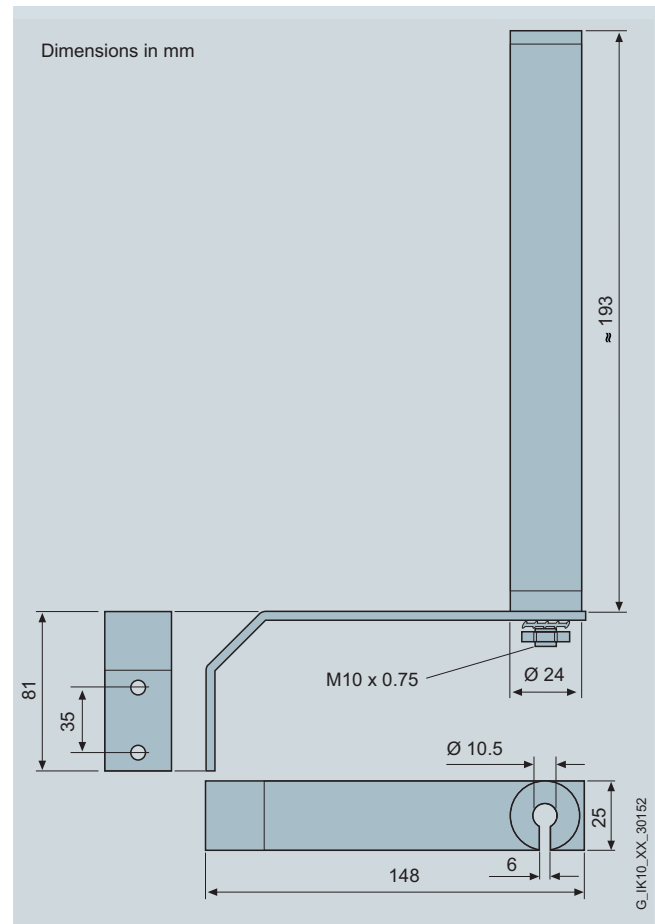

### More information

#### Selection tools:

To assist in selecting the right Industrial Wireless Communication, the SIMATIC NET Selection Tool is available at:

SIMATIC NET Selection Tool:

- Online version:  
<http://www.siemens.com/snst>
- Offline version  
<http://www.siemens.com/snst-download>

#### Wireless approvals:

Current approvals can be found on the Internet at:  
<http://www.siemens.com/mobilenetwork-approvals>

## Industrial Remote Communication

### Accessories for remote networks

#### ANT794-3M GSM/GPRS antenna

##### Overview

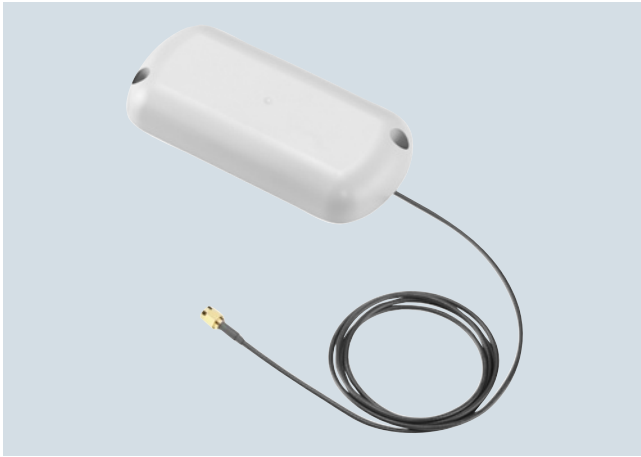

- Flat panel antenna for mobile telephony for GSM 900/1 800/1 900
- Suitable for exterior and interior installation
- Electrically independent installation
- Ready for connection with cable for GSM/GPRS modems with SMA connection

##### Benefits

**get** Designed for Industry

- Durable mounting in plastic switching boxes
- Installation without specialist knowledge of high frequency
- Universal in use, also on grounded or non-grounded metal surfaces without adversely affecting the radiation properties

##### Application

- For use in GSM/GPRS networks
- Indoors and outdoors (IP64 degree of protection)
- Operating temperature -40 °C to +70 °C
- For installation in plastic control boxes

##### Design

- Emitters accommodated in protective plastic housing
- Installation using screws or adhesive pad

##### Technical specifications

<b>Article No.</b>	<b>6NH9870-1AA00</b>
<b>Product-type designation</b>	<b>ANT794-3M antenna</b>
<b>Wireless frequencies</b>	
Type of mobile wireless network is supported	
• GSM	Yes
• UMTS	No
Operating frequency	
• 850 MHz	No
• 900 MHz	Yes
• 1 800 MHz	Yes
• 1 900 MHz	Yes
• 2 200 MHz	No
<b>Electrical data</b>	
Radiation characteristic	directional
Antenna gain	0 dB
Standing wave ratio VSWR maximum	1.5
Number of electrical connections of antenna	1
Design of electrical connection of antenna	SMA connector
Front-to-back ratio	-
Transmit power maximum	10 W
<b>Permitted ambient conditions</b>	
Ambient temperature during operating	-40 ... +75 °C
Protection class IP	IP64
<b>Design, dimensions and weight</b>	
Width	70.5 mm
Height	20.5 mm
Depth	146.5 mm
Diameter	-
Net weight	130 g
Mounting type	screw fixing
Cable length of antenna cable	1.2 m
<b>Product properties, functions, components general</b>	
Material of outer shell	ABS Polylac PA-765, light gray (RAL 7035)

### Ordering data

### Article No.

#### GSM/GPRS antenna

#### ANT794-3M antenna

Flat panel antenna for GSM (2G) networks, for triband with 900/1 800/1 900 MHz; weather-resistant for indoor/outdoor use, 1.2 m cable with fixed connection to antenna; SMA connector, incl. assembly adhesive tape

6NH9870-1AA00

### Dimensional drawings

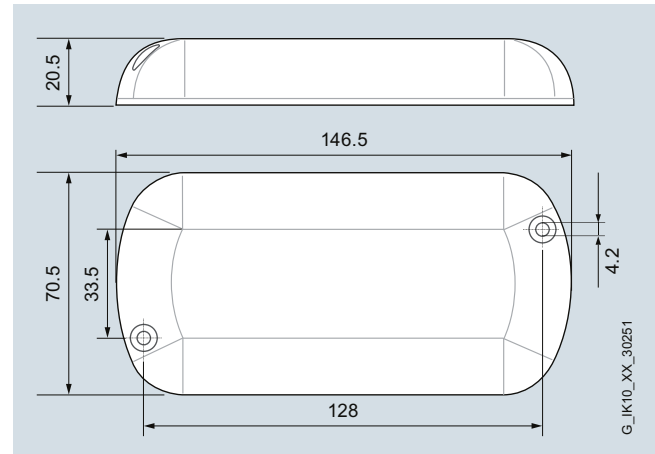

### More information

#### Selection tools:

To assist in selecting the right Industrial Wireless Communication, the SIMATIC NET Selection Tool is available at:

SIMATIC NET Selection Tool:

- Online version:  
<http://www.siemens.com/snst>
- Offline version:  
<http://www.siemens.com/snst-download>

#### Radio approvals

Current approvals can be found on the Internet at:  
<http://www.siemens.com/mobilenetwork-approvals>

## Industrial Remote Communication

### Accessories for remote networks

#### PPI modem cable

##### Overview

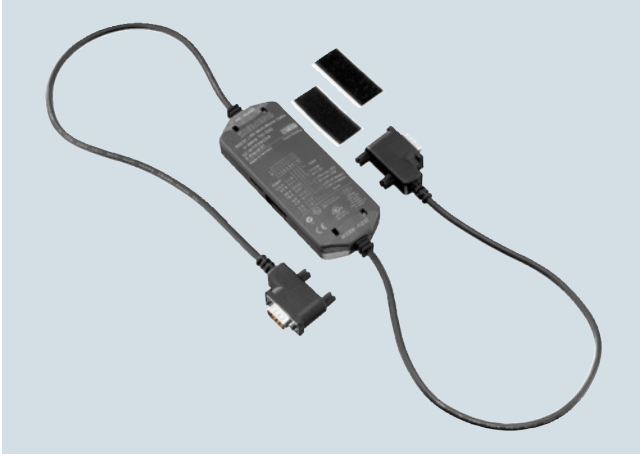

- Intelligent RS 232/PPI multimaster cable for connecting modems with RS 232 interface to SIMATIC S7-200 (RS 485)

##### Benefits

- get** Designed for Industry
- Matching cable length for control cabinet assembly
  - No RS 232 adapter (gender changer) required for modem connection
  - Simple fixing of cable in control cabinet using Velcro fastener

##### Application

The intelligent RS 232/PPI multimaster cable can be used for the connection between modems and the S7-200. It is then possible to connect modems such as the GSM modem MD720-3 with RS 232 interface to the PPI interface of the S7-200 without using a gender changer. As a result of the short cable lengths and the industrial Velcro fasteners, the PPI modem cable is suitable for use in control cabinets.

##### Design

- 24 V DC power supply via the RS 485 interface of the SIMATIC S7-200
- Three LEDs for status display:
  - Tx, green: RS 232 send
  - Rx, green: RS 232 receive
  - PPI, green: RS 485 send

##### Function

###### PPI mode:

- Signal conversion from RS 232 to RS 485
- Control of token in a multimaster PPI network (PPI master)
- Supports 10-bit modem protocol via RS 232, and DPT and PPI protocols via RS 485

###### Freeport mode:

- Signal conversion from RS 232 to RS 485
- Switchover between local and remote modes
- Configuration in local mode using DIP switches
- Configuration in remote mode using terminal program (e.g. MS Hyper Terminal)
- Supports AT modem commands and PIN for Siemens modems

##### Technical specifications

<b>Article No.</b>	<b>6NH9701-0AD</b>
<b>Product-type designation</b>	<b>PPI modem cable</b>
Acceptability for application	For connecting modems (MD720-3) to S7-200
Cable length	1.1 m
<b>Mechanical data</b>	
Net weight	0.3 kg

##### Ordering data

##### Article No.

**PPI modem cable**  
For connecting modems with RS 232 interface to SIMATIC S7-200

**6NH9701-0AD**

### Overview

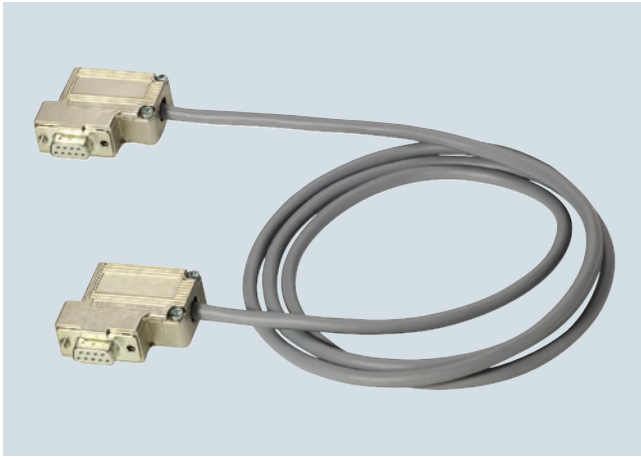

There is a series of standard connecting cables for connecting the SINAUT components to one another or to the respective WAN. Some of these cables are already supplied as a permanent item along with the hardware components and are listed in the ordering data of these components as spare parts.

### Technical specifications

Article No.	6NH7701-4AL	6NH7701-4DL	6NH7701-1CB	6NH7701-5AN
<b>Product-type designation</b>	<b>Connecting cable SINAUT ST7, CC 701-4A</b>	<b>Connecting cable SINAUT ST7, CC 701-4D</b>	<b>Connecting cable SINAUT ST7, CC 701-1C</b>	<b>Connecting cable SINAUT ST7, CC 701-5A</b>
<b>Acceptability for application</b>	For connecting a TIM to a SINAUT ST7 modem (MD2, MD3, MD4) over an RS232 interface	For connecting a TIM to a SINAUT ST7 modem (MD2, MD3, MD4) over an RS485/2 interface	For connecting two MD2 modems over an RS232 interface to create a repeater	For connecting a TIM to the GSM Modem MC45T or MD720 via the RS232 interface
<b>Cable length</b>	1.5 m	1.5 m	0.3 m	2.5 m
<b>Mechanical data</b>				
Net weight	-	-	-	-

Article No.	6NH7701-4BN	6NH7701-0AR
<b>Product-type designation</b>	<b>Connecting cable SINAUT ST7, CC 701-4B</b>	<b>Connecting cable SINAUT ST7, CC 701-0A</b>
<b>Acceptability for application</b>	For connecting a TIM with a third-party modem or radio unit over an RS232 interface, one free end	For connecting two TIM modules via an RS232 interface without modems
<b>Cable length</b>	2.5 m	6 m
<b>Mechanical data</b>		
Net weight	-	-

## Industrial Remote Communication

### Accessories for remote networks

#### Connecting cables

Ordering data	Article No.	Ordering data	Article No.
<b>Connecting cable</b> For connecting a TIM with a SINAUT ST7 MD2, MD3 or MD4 modem; cable length 1.5 m <ul style="list-style-type: none"> <li>• RS 232 Also suitable for interfacing the modems listed with a SIMATIC point-to-point CP such as the CP340, CP341 or CP441 with RS 232 interface</li> <li>• RS 485</li> </ul>	<b>6NH7701-4AL</b>	<b>Connecting cable</b> For connecting a TIM (RS 232) with the GSM modem MD720-3; also suitable for third-party modems or radio equipment with standard RS 232 interface; cable length 2.5 m	<b>6NH7701-5AN</b>
	<b>6NH7701-4DL</b>	<b>Connecting cable open at one end</b> For connecting a TIM (RS 232) with a third-party modem or radio unit (RS 232); cable length 2.5 m	<b>6NH7701-4BN</b>
<b>Connecting cable</b> For connecting two MD2 modems (RS 232) in order to create a repeater; cable length 0.3 m	<b>6NH7701-1CB</b>	<b>Test cable</b> Connecting cable for connecting two TIMs via their RS 232 interface without modems ("null modem"); cable length 6 m	<b>6NH7701-0AR</b>



<b>8/2</b>	<b>Security Integrated</b>
8/2	Introduction
8/8	SCALANCE S
8/19	SCALANCE M
8/20	CP 1243-1 and CP 1543-1
8/21	CP 343-1 Advanced and CP 443-1 Advanced
8/23	CP 1628
8/24	SOFTNET Security Client
8/27	Industrial Security Services

# Industrial Security

## Security Integrated

### Introduction

#### Overview

##### Industrial security

###### *That is why industrial security is so important*

As the use of Ethernet connections all the way down to the field level increases, the associated security issues are becoming a more urgent topic for industry. After all, open communication and increased networking of production systems involve not only huge opportunities, but also high risks. To provide an

industrial plant with comprehensive security protection against attacks, the appropriate measures must be taken. Siemens can support you here in selectively implementing these measures – within the scope of an integrated range for Industrial Security.

###### Threat overview

No.	Threat	Explanation
1	Unauthorized use of remote maintenance access	Maintenance access provides deliberate openings to the outside in the ICS network <sup>1)</sup> . However, they are often inadequately protected.
2	Online attacks via office/enterprise networks	In general, office IT equipment is connected with the Internet in many ways. Usually, there are also network connections from the office network to the ICS network, allowing attackers to use this route.
3	Attacks against standard components used in the ICS network	Standard IT components (commercial off-the-shelf, COTS) such as operating systems, application servers, or databases generally contain flaws and weak points which can be exploited by attackers. If these standard components are also used in the ICS network, this increases the risk of a successful attack on the ICS systems.
4	(D)DoS attacks	(Distributed) denial of service attacks can be used to disrupt network connections and required resources and cause systems to crash, e.g. to disrupt the functionality of an ICS.
5	Human error and sabotage	Deliberate actions – regardless of whether by internal or external agents – are a massive threat for all security goals. In addition, negligence and human error are a great danger, especially when it comes to protecting confidentiality and availability.
6	Introduction of harmful code via removable media and external hardware	The use of removable media and mobile IT components of external employees always presents a great risk of malware infections. The importance of this aspect was demonstrated by Stuxnet, for example.
7	Reading and writing messages in the ICS network	Because most control components presently communicate via plain-text protocols, and are thus unprotected, it is often possible to read and insert commands without great difficulty.
8	Unauthorized access to resources	In particular, insiders or follow-up attacks after intrusion from the outside have an easy time if authentication and authorization for services and components in the process network are non-existent or insecure.
9	Attacks on network components	Network components can be manipulated by attackers, for example to carry out man-in-the-middle attacks or to make sniffing easier.
10	Technical faults and acts of God	Failures are always possible as a result of extreme environmental influences or technical defects – the risk and the potential for damage can only be minimized here.

<sup>1)</sup> Industrial Control Systems (ICS)

Source: BSI-A-CS 004 | Version 1.00 dated April 12, 2012; page 2 of 2

###### Note:

The list of threats came about as a result of close cooperation between BSI and business representatives. With its BSI analyses, the Federal Office for Information Security (BSI) publishes statistics and reports on current topics in cyber security.

Please send comments and notes to: [cs-info@bsi.bund.de](mailto:cs-info@bsi.bund.de)



## Overview (continued)

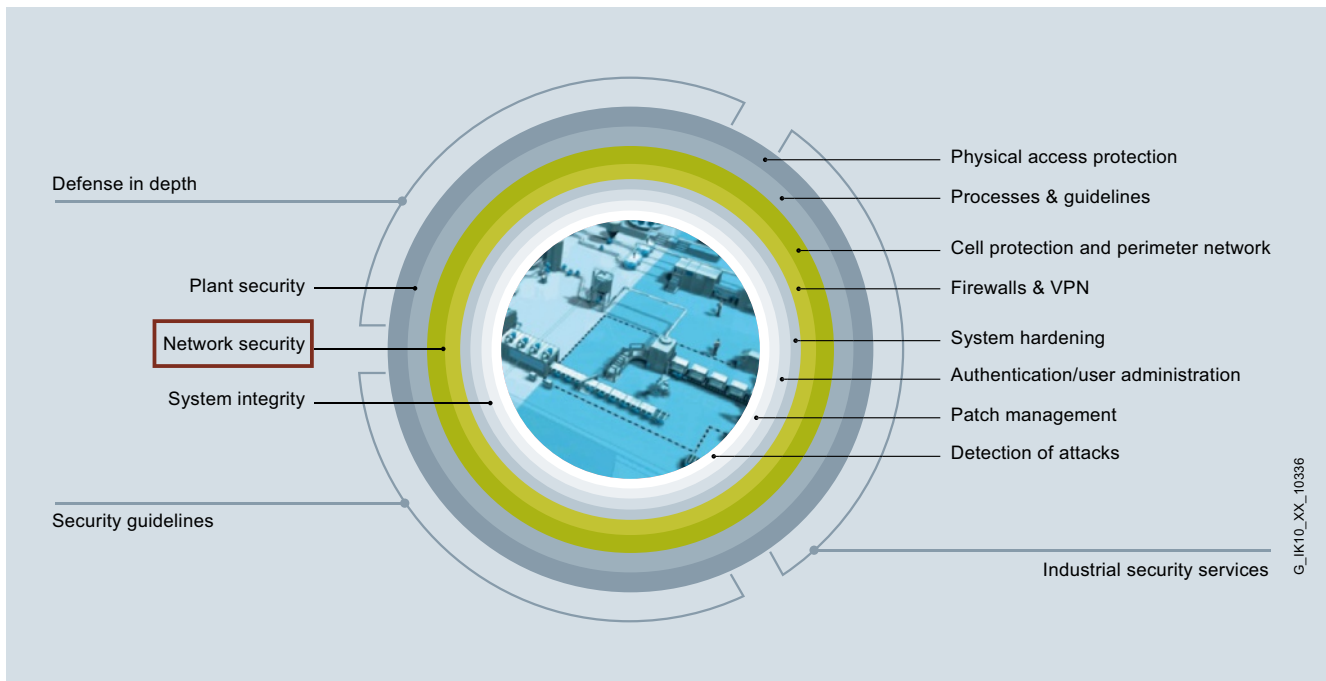

Network security as a central component of the Siemens Industrial Security concept

### Siemens Industrial Security – continuous protection for your plant

An optimum industrial security solution can only be implemented if new approaches are taken because they must be continuously adapted to new threats. There is no such thing as absolute security. To ensure a comprehensive and permanent solution, we provide in-depth advice, partner-like cooperation, and constant further development of our security measures and products.

#### All-round, but also in-depth protection

With Defense in Depth, Siemens provides a multi-level concept that offers your plant both all-round and in-depth protection. The concept is based on the components, plant security, network security, and system integrity, as recommended by ISA 99 / IEC 62443 – the leading standard for security in industrial automation. While conventional plant security defends the plant against physical attacks, network protection and protection of system integrity protect against cyber attacks and unauthorized access by operators or external persons.

### Factors for success: Network security

Network security means protecting automation networks from unauthorized access. This includes the monitoring of all interfaces such as the interfaces between office and plant networks or the remote maintenance access to the Internet, which can be accomplished by means of firewalls and, if applicable, by establishing a DMZ (demilitarized zone = secure, protected zone). The DMZ is used to provide data for other networks, without granting direct access to the automation network. The secure segmenting of the plant network into individually protected automation cells minimizes risks and increases security. Cell division and device assignment are based on communication and protection requirements. Data transmission is encrypted by means of a VPN and is thus protected from data espionage and manipulation. The communication stations are securely authenticated. The cell protection concept can be implemented and communication can be secured using "Security Integrated" components such as SCALANCE S Security Modules, SCALANCE M wireless routers, or Security CPs for SIMATIC.

#### Initial risk assessment and information on the Internet

You want to know now how good the security of your industrial plant is? We can provide you with detailed information about the special security issues in your industry. Use the opportunity to contact our consulting team about any open issues. Our experts will gladly prepare a security concept that is adapted to the needs of your production plant or process infrastructure. You can download the additional "Operational Guidelines" with many recommendations for protecting your production plant from our Internet site.

# Industrial Security

## Security Integrated

### Introduction

### Overview (continued)

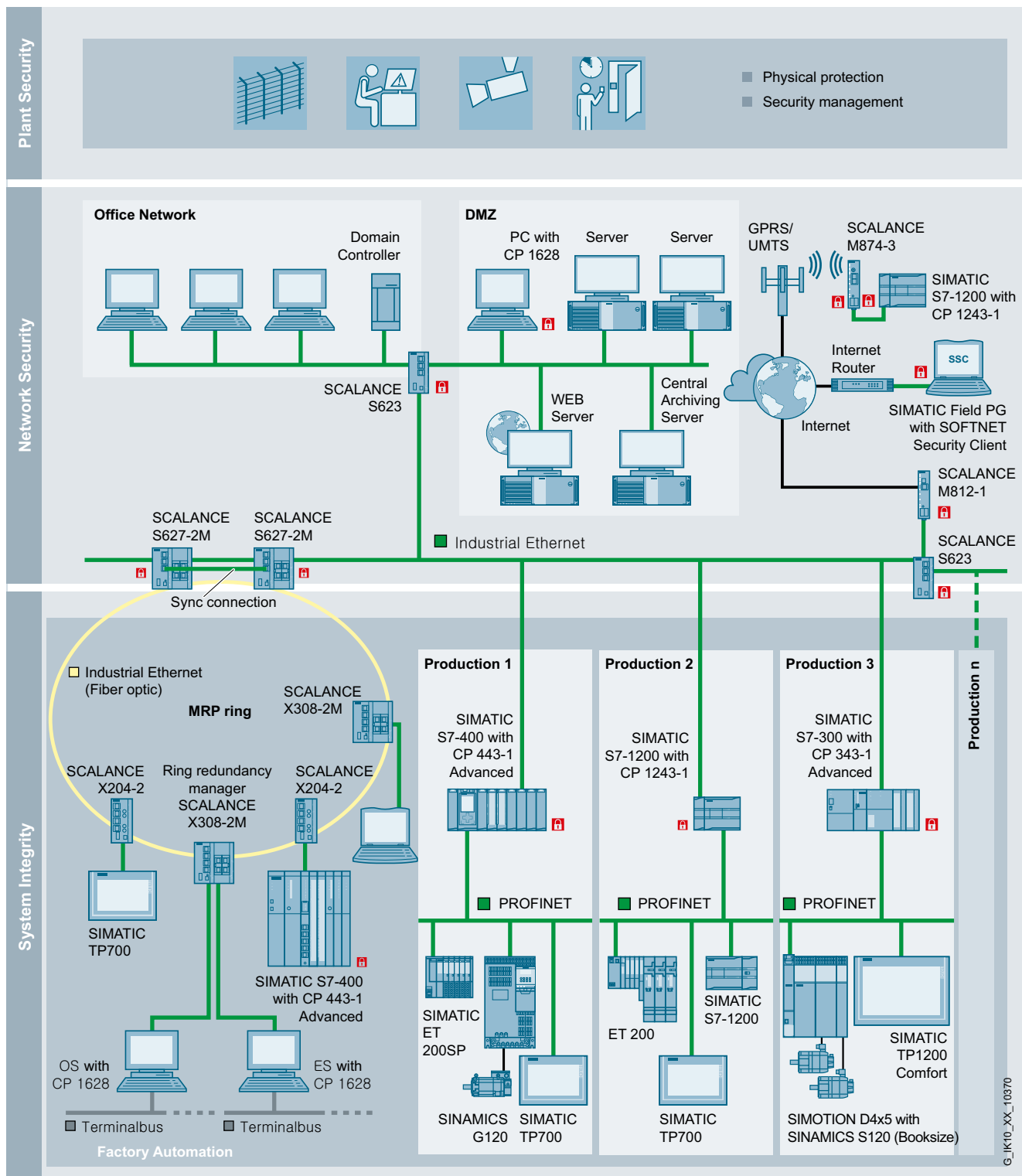

Secure communication, network access protection and network segmentation with Security Integrated products

8

G\_IK10\_XX\_10370

**Overview** (continued)**Security Integrated****Cell protection concept**

Industrial communication is a key factor for corporate success – as long as the network is protected. As your partner, Siemens provides its customers with Security Integrated components, which not only have communication functions but also include special security functions such as firewall and VPN functionality, in order to implement the cell protection concept. With the cell protection concept, a plant network is subdivided into protected automation cells within which all devices are able to communicate with each other securely. The individual cells are connected to the plant network protected by a VPN and firewall. Cell protection reduces the susceptibility to failure of the entire production plant and thus increases its availability. Security Integrated products such as SCALANCE S, SCALANCE M and SIMATIC S7/PC communications processors can be used for implementation.

The following Security Integrated products are available:

**SIMATIC S7-1200 / S7-1500:**

- Protection of the controller by access protection (authentication) via the **S7-1200/S7-1500 CPU:**
  - Know-how protection
  - Manipulation protection
  - Copy protection
  - Graded security concept for HMI connection
- Expandable access protection (firewall and VPN) for S7-1200/S7-1500 with Security **CP 1243-1/CP 1543-1** by means of
  - Integrated firewall (monitoring of the data flow)
  - Protection against data manipulation and espionage by means of a VPN

**SIMATIC S7-300 and S7-400**

- Protection of controllers by **CP 343-1 Advanced** and **CP 443-1 Advanced** communications processors, which contain both firewall and VPN (virtual private network) functionality.

**SCALANCE S security modules**

SCALANCE S modules protect industrial networks and automation systems by means of security-related segmentation (cell protection) with a firewall against authorized access and protect data transmission with VPN against manipulation and espionage.

**SCALANCE M router****Mobile radio router**

SCALANCE M industrial router for secure access to plants via mobile radio, e.g. GPRS or UMTS, with integral security functions – firewall for protection against unauthorized access and VPN for protection of the data transmission.

**DSL routers**

The SCALANCE M DSL routers are ADSL routers (M812-1 and M816-1) for the secure connection of Ethernet-based subnets and automation devices to hard-wired DSL networks or SHDSL routers (M826) for connection via existing wire-pairs or multi-wire cables. They have integral security functions – firewall for protection against unauthorized access and VPN for protection of the data transmission.

**Industrial PCs**

- Via the **CP 1628** communications processor, the industrial PCs are protected by firewall and VPN – for secure communication without special operating system settings. This means that computers equipped with the module can be connected to protected cells.

**Software**

- The **SOFTNET Security Client** software enables VPN access via the Internet or a company intranet to automation cells or PCs protected by SCALANCE S or another security component with VPN functionality.

	SCALANCE S family	SCALANCE M family	CP 343-1 Adv CP 443-1 Adv	S7-1200 CPU <sup>1)</sup> S7-1500 CPU	CP 1243-1 <sup>1)</sup> CP 1543-1	CP 1628	SOFTNET Security Client
Configurable copy protection				•			
Access protection (authentication)				•			
Extended access protection (Firewall)	•	•	•		•	•	
Virtual Private Network with IPSec	•	•	•		•	•	•
Manipulation protection (communication, configuration)	•	•	•	•	•	•	•

• applies

<sup>1)</sup> from CPU firmware V4.0  
from STEP 7 Professional V13 (TIA Portal)

G\_IK10\_XX\_10347

Security Integrated products for industrial use with special security functions to improve the standard of security

# Industrial Security

## Security Integrated

### Introduction

#### Ordering data

##### Security Integrated devices

#### SCALANCE S Industrial Security Modules

For protecting programmable controllers and automation networks and for securing industrial communication; Security Modules protect network segments against unauthorized access by means of Stateful Inspection Firewall; connection of more than 10/100/1 000 Mbit/s ports; configuring tool and electronic manual on CD ROM; English, German, French, Italian, Spanish;

#### SCALANCE S602

6GK5602-0BA10-2AA3

#### SCALANCE S612

up to 128 VPN tunnels simultaneously

6GK5612-0BA10-2AA3

#### SCALANCE S623

up to 128 VPN tunnels simultaneously; additional RJ45 DMZ port

6GK5623-0BA10-2AA3

#### SCALANCE S627-2M

up to 128 VPN tunnels simultaneously; additional RJ45 DMZ port; two additional slots for one 2-port media module each

6GK5627-2BA10-2AA3

#### SOFTNET Security Client V4 HF1

6GK1704-1VW04-0AA0

Software for designing secure IP-based VPN connections from a programming device/PC to network segments which are secured by SCALANCE S, SCALANCE M, CP 343-1 Advanced, CP 443-1 Advanced, or CP 1628; Single License for 1 installation, runtime software (German/English), configuration tool (German/English), and electronic manual on CD-ROM (German/English/French/Spanish/Italian) for Windows 7 Professional, Ultimate, Windows XP Professional (32-bit) + SP3

##### SCALANCE M industrial modems and routers

#### SCALANCE M874 mobile radio router

Mobile radio router for wireless IP communication from Industrial Ethernet-based subnets and programmable controllers via UMTS or GSM mobile radio networks; with integrated firewall and VPN with IPsec; 2 x RJ45 ports, 1 x antenna connection

- SCALANCE M874-3<sup>1)</sup>
- SCALANCE M874-2<sup>1)</sup>

6GK5874-3AA00-2AA2  
6GK5874-2AA00-2AA2

#### SCALANCE M875 UMTS Router

UMTS router for wireless IP communication from Industrial Ethernet-based programmable controllers via UMTS/GSM mobile radio networks; EGPRS Multislot Class 12; with integrated firewall and VPN with IPsec; 2 x RJ45 ports, 2 x antenna connections

- SCALANCE M875<sup>1)</sup>
- SCALANCE M875<sup>1)</sup> for Japan

6GK5875-0AA10-1AA2  
6GK5875-0AA10-1CA2

#### SCALANCE M81x-1 ADSL router

DSL router for wired IP communication from Industrial Ethernet-based subnets and programmable controllers via telephone or DSL networks; with integrated firewall and VPN with IPsec; 1 x or 4 x RJ45 ports for Industrial Ethernet; 1 x RJ45 port for DSL

- SCALANCE M812-1 (Annex A)
- SCALANCE M812-1 (Annex B)
- SCALANCE M816-1 (Annex A)
- SCALANCE M816-1 (Annex B)

6GK5812-1AA00-2AA2  
6GK5812-1BA00-2AA2  
6GK5816-1AA00-2AA2  
6GK5816-1BA00-2AA2

#### SCALANCE M826-2 SHDSL router

DSL router for wired IP communication from Industrial Ethernet-based subnets and programmable controllers via telephone or DSL networks; with integrated firewall and VPN with IPsec; 1 x or 4 x RJ45 ports for Industrial Ethernet; 1 x RJ45 port for DSL

- SCALANCE M826-2 (Annex A)

6GK5826-2AB00-2AB2

Ordering data	Article No.	Article No.	
<b>Communications processors for SIMATIC S7</b>		<b>Communications processors for PG/PC/IPC</b>	
<b>CP 1243-1 communication processor;</b> for connection of SIMATIC S7-1200 to Industrial Ethernet via TCP/IP, ISO and UDP, Telecontrol Server Basic and security functions Stateful Inspection Firewall and VPN; 1 x RJ45 interface with 10/100 Mbit/s	<b>6GK7243-1BX30-0XE0</b>	<b>CP 1628 communications processor;</b> PCI Express x1 card for connection to Industrial Ethernet (10/100/1 000 Mbit/s), with 2-port switch (RJ45) and integrated security (firewall, VPN) via HARDNET-IE S7 and S7-REDCONNECT. For operating system support, see SIMATIC NET Software	<b>6GK1162-8AA00</b>
<b>CP 1543-1 communication processor;</b> for connection of SIMATIC S7-1500 to Industrial Ethernet via TCP/IP, ISO and UDP and security functions Stateful Inspection Firewall and VPN; 1 x RJ45 interface with 10/100/1 000 Mbit/s;	<b>6GK7543-1AX00-0XE0</b>	<b>Accessories</b>	
<b>CP 343-1 Advanced communications processor;</b> For connection of SIMATIC S7-300 to Industrial Ethernet over ISO and TCP/IP; PROFINET IO Controller or PROFINET IO Device, MRP, integrated 2-port switch ERTEC; S7 communication, open communication (SEND/RECEIVE), FETCH/WRITE, with and without RFC1006, multicast, DHCP, CPU clock synchronization via SIMATIC procedure and NTP, diagnostics, SNMP, access protection through IP access list, initialization over LAN 10/100 Mbit/s; as well as IT communication (web, e-mail, FTP); PROFINET CBA; security (firewall/VPN); PROFInergy; with electronic manual on DVD	<b>6GK7343-1GX31-0XE0</b>	<b>IE FC TP Standard Cable GP 2 x 2 (Type A)</b> 4-core, shielded TP installation cable for connecting to IE FC RJ45 outlet / IE FC RJ45 plug; PROFINET-compliant; with UL approval; sold by the meter; max. length 1 000 m, minimum order 20 m	<b>6XV1840-2AH10</b>
<b>CP 443-1 Advanced communications processor;</b> For the connection of SIMATIC S7-400 to Industrial Ethernet; PROFINET IO Controller with RT and IRT, MRP, PROFINET CBA, TCP/IP, ISO and UDP; S7 communication, open communication (SEND/RECEIVE) with FETCH/WRITE, with and without RFC1006, diagnostics expansions, multicast, clock synchronization with SIMATIC mode or NTP, access protection by IP access list, FTP client/server, HTTP server, HTML diagnostics, SNMP, DHCP, e-mail, data storage on C-PLUG; PROFINET connector: 4xRJ45 (10/100 Mbit/s) via switch; Gigabit connector: 1xRJ45 (10/100/1 000 Mbit/s); with integrated stateful inspection firewall and VPN appliance	<b>6GK7443-1GX30-0XE0</b>	<b>IE FC RJ45 Plug 180</b> RJ45 plug-in connector for Industrial Ethernet with a rugged metal enclosure and integrated insulation displacement contacts for connecting Industrial Ethernet FC installation cables; with 180° cable outlet; for network components and CPs/CPUs with Industrial Ethernet interface <ul style="list-style-type: none"><li>• 1 pack = 1 unit</li><li>• 1 pack = 10 units</li><li>• 1 pack = 50 units</li></ul>	<b>6GK1901-1BB10-2AA0</b> <b>6GK1901-1BB10-2AB0</b> <b>6GK1901-1BB10-2AE0</b>
		<b>IE FC stripping tool</b> Preadjusted stripping tool for fast stripping of Industrial Ethernet FC cables	<b>6GK1901-1GA00</b>
		<b>SITOP compact 24 V/ 0.6 A</b> 1-phase power supply with wide-range input 85 – 264 V AC/110 – 300 V DC, stabilized output voltage 24 V, rated output current value 0.6 A, slim design	<b>6EP1331-5BA00</b>
		<b>C-PLUG</b> Swap medium for simple replacement of devices in the event of a fault; for storing configuration or application data; can be used for SIMATIC NET products with C-PLUG slot	<b>6GK1900-0AB00</b>

<sup>1)</sup> Please note national approvals under <http://www.siemens.com/wireless-approvals>

**Note:**

Check the current country list: <http://support.automation.siemens.com/WW/view/en/66627157>

## Industrial Security

### Security Integrated

#### SCALANCE S

#### Overview



- Security modules for the protection of automation networks and security during data exchange between automation systems.
- Checking and filtering of data traffic by integrated firewall and thus:
  - Protection against operator mistakes
  - Prevention of unauthorized access
  - Prevention of faults and communications overload
- Authentication of the communication partners and encryption of the transmitted data with VPN and thus protection of communication against espionage and manipulation.
- Rugged, industry-compatible design of the devices
- Easy and clear configuration:  
Using the Security Configuration Tool (SCT), all SIMATIC NET security products can be configured and diagnosed from a central position.
- No changes or adaptations necessary in the existing network topology, applications or network stations since SCALANCE S can also be used as a bridge and not just as a router.
- Securing of communication is independent of the protocol (e.g. PROFINET or other Ethernet-based fieldbus solutions)
- Secure remote access via the Internet possible without restrictions and with any providers
- Increased availability is possible by means of redundant protection of automation cells or ring topologies

#### Product versions:

##### SCALANCE S602;

- Uses the stateful inspection firewall to protect network segments against unauthorized access.
- "Ghost mode" for protection of individual, even alternating, devices by dynamically taking over the IP address.
- Connection via 10/100/1 000 Mbit/s ports.

##### SCALANCE S612;

- Uses the stateful inspection firewall to protect network segments against unauthorized access.
- Up to 128 VPN tunnels can be operated simultaneously.
- Connection via 10/100/1 000 Mbit/s ports.

##### SCALANCE S623;

- Uses the stateful inspection firewall to protect network segments against unauthorized access.
- Up to 128 VPN tunnels can be operated simultaneously.
- Connection via 10/100/1 000 Mbit/s ports.
- Additional RJ45 DMZ port (DMZ: "demilitarized zone") for secure connection from, for example, remote maintenance modems, laptops, or an additional network. This yellow port protected by firewalls from the red and green ports and can also terminate VPNs.
- Redundant protection of automation cells by means of router and firewall redundancy and stand-by linking of the redundant device via the yellow port.

##### SCALANCE S627-2M;

- Uses the stateful inspection firewall to protect network segments against unauthorized access.
- Up to 128 VPN tunnels can be operated simultaneously.
- Connection via 10/100/1 000 Mbit/s ports.
- Additional RJ45 DMZ port (DMZ: "demilitarized zone") for secure connection from, for example, remote maintenance modems, laptops, or an additional network. This yellow port protected by firewalls from the red and green ports and can also terminate VPNs.
- Redundant protection of automation cells by means of router and firewall redundancy and stand-by mode of the redundant device; status matching of the firewall by means of a synchronization cable between the yellow ports.
- Two additional slots for one 2-port media module each (see SCALANCE X-300) for direct integration in ring structures and FO networks with two additional switched red or green ports per module.
- Bridging of longer cable runs or use of existing 2-wire cables (e.g. PROFIBUS) by deploying MM992-2VD media modules (variable distance).

## Benefits

**Designed for Industry**

- Protection of industrial automation networks against unauthorized access and setup of a DMZ (protected zone) possible for data exchange with other networks without having to grant direct access to the production network.
- Through implementation of the cell protection concept:
  - Protection of any Ethernet-based programmable controllers and automation systems which do not have their own security functions
  - Protecting several devices simultaneously
  - Reduction in risk by means of network segmenting (by generating secure communication islands)
  - Securing of communication to and from the automation cells is possible
- User-specific firewall rules can be used to assign specific access privileges to users and not just to devices.
- System-wide network diagnostics thanks to integration into IT infrastructures and network management systems by means of SNMP
- Securing of remote access via the Internet. Using PPPoE and DynDNS, dynamic IP addresses can also be applied.
- Problem-free integration into existing networks without reconfiguring terminal nodes or setting up new IP subnetworks
- Module replacement without the need for a programming device, using the C-PLUG swap media for backing up the configuration data
- Direct integration in ring structures and FO networks is possible (SCALANCE S627-2M)

## Application

The security modules of the SCALANCE S range can be used to protect all devices of an Ethernet network against unauthorized access. In addition, SCALANCE S612 or SCALANCE S623 also protect the data transmission between devices or network segments (e.g. automation cells) against data manipulation and espionage; they can also be used for secure remote access over the Internet.

The security modules can be operated not only in bridge mode but also in router mode, and can thus also be used direct at IP subnetwork borders.

Secure remote access over the Internet or GPRS/UMTS is possible with the SCALANCE M875 GPRS/UMTS router.

SCALANCE S is optimized for use in automation and industrial environments, and meets the specific requirements of automation systems, such as easy upgrades of existing systems, simple installation and minimal downtimes in the event of a fault.

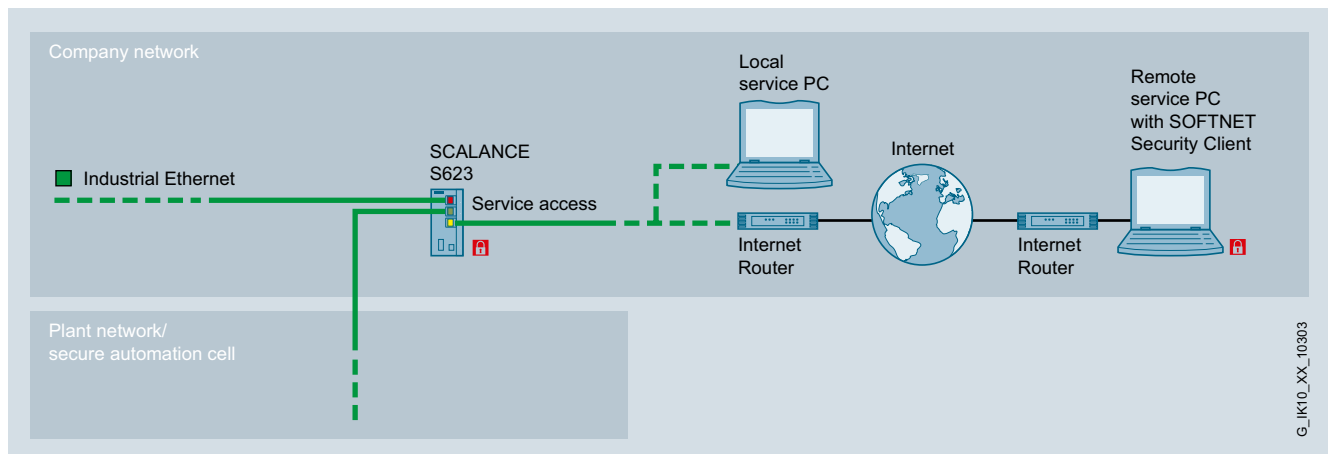

Connection of a local or remote service PC (by means of Internet access) via the DMZ port of the SCALANCE S623

#### Design

##### SCALANCE S602

- Checking of data traffic and protection against unauthorized access by means of stateful inspection firewall.
- Simple and fast configuration of the firewall through global firewall rules and symbolic names for IP addresses.
- Specific access privileges for users in accordance with user-specific firewall rules.
- 10/100/1 000 Mbit/s ports for the connection and operation of SCALANCE S in Gigabit networks as well
- In addition to bridge mode, can also be operated in router mode and can therefore also be used directly at IP subnet limits
- Address translation
  - NAT (Network Address Translation) permits the use of private IP addresses in the internal network in that public IP addresses are converted to private ones
  - NAT (Network Address and Port Translation) permits the use of private IP addresses in the internal network in that frames are converted to private IP addresses depending on the communications port used
- Internal network nodes can receive their IP addresses from the integral DHCP server
- Log files can also be evaluated by the Syslog server
- Enhanced integration in IT infrastructures and network management systems by means of SNMP
- Protection of individual, even alternating, devices by dynamically taking over the IP address (ghost mode)

##### SCALANCE S612

As SCALANCE S602; additionally:

- Encryption of data transmission with VPN (IPSec)
  - Protection against espionage
  - Protection against unauthorized manipulation
- Secure remote access over the Internet, e.g. in conjunction with the SOFTNET Security Client and the SCALANCE M UMTS router (with IPSec VPN function)

##### SCALANCE S623

As SCALANCE S612; additionally:

- DMZ port with which a protected zone (DMZ = demilitarized) can be set up between two networks. The DMZ is used to provide data for other networks without granting direct access to the automation network, thus increasing security. The DMZ port can also be used to protect remote maintenance access, where, for example, only access to lower-level automation cells is possible and no access to the plant network is required.
- Secure, redundant connection of automation cells through router and firewall redundancy

##### SCALANCE S627-2M

As SCALANCE S623; additionally:

- Two media module slots for two additional switched red or green ports each.
  - Direct integration in line or ring topologies is possible
  - Integration into redundant rings (MRP, HRP) is possible
  - Secure, redundant connection of automation cells or rings
  - Direct integration in FO networks is possible through the use of FO media modules
  - Bridging of longer cable runs or use of existing 2-wire cables (e.g. PROFIBUS) by deploying the MM992-2VD media modules (variable distance).

#### Function

##### Security functions

###### VPN (Virtual Private Network)

(only for SCALANCE S612, S623 and SCALANCE S627-2M); for reliable authentication (identification) of the network stations, for encrypting data and checking data integrity.

- Authentication;
  - All incoming data traffic is monitored and checked. As IP addresses can be falsified (IP spoofing), checking the IP address (of the client access) is not sufficient. In addition, Client PCs may have changing IP addresses. For this reason the authentication is performed by means of tried and tested VPN mechanisms.
- Data encryption;
  - Secure encryption is necessary in order to protect data communication from espionage and unauthorized manipulation. This means that the data traffic remains incomprehensible to any eavesdropper in the network. The SCALANCE Security Module establishes VPN tunnels to other Security Modules for this purpose.

###### The firewall

can be used as an alternative or to supplement VPN with flexible access control.

The firewall filters data packets and disables or enables communication links in accordance with the filter list and stateful inspection. Both incoming and outgoing communication can be filtered, either according to IP and MAC addresses as well as communication protocols (ports) or user-specific.

- Logging;
  - access data are saved by the Security Module in a log file. Detection of how, when and by whom it has been accessed is as important as detecting access attempts, to ensure that appropriate preventative measures can be taken.

##### Configuration

Configuration is carried out using the Security Configuration Tool (SCT). Therefore all SIMATIC NET security products can be configured and diagnosed from a central position. All the configuration data can be saved on the optional C-PLUG swap media (not included in scope of supply) so that the Security Module can be replaced quickly in the event of a fault and without the need of a programming device.



Function (continued)

Configuration

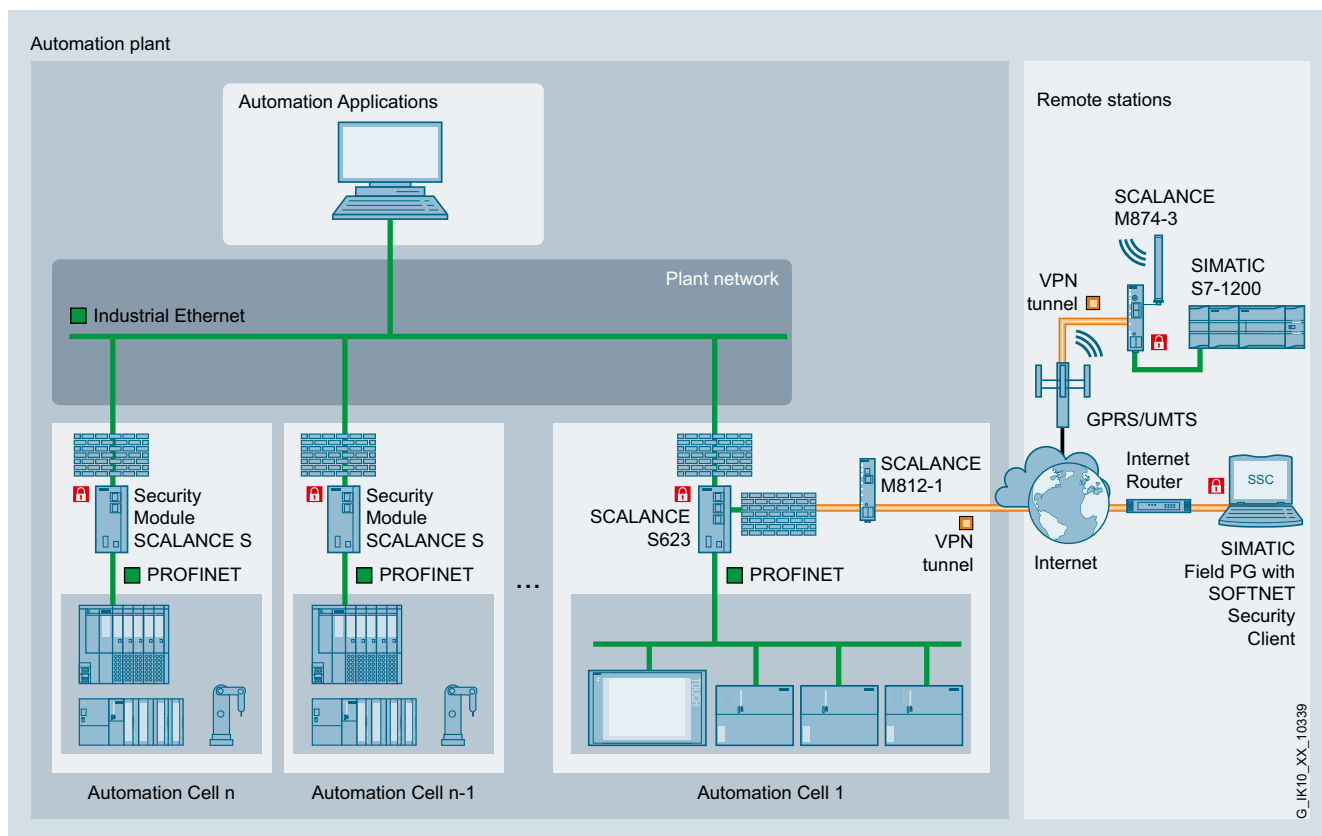

Secure remote access without direct connection to the automation network with SCALANCE S623

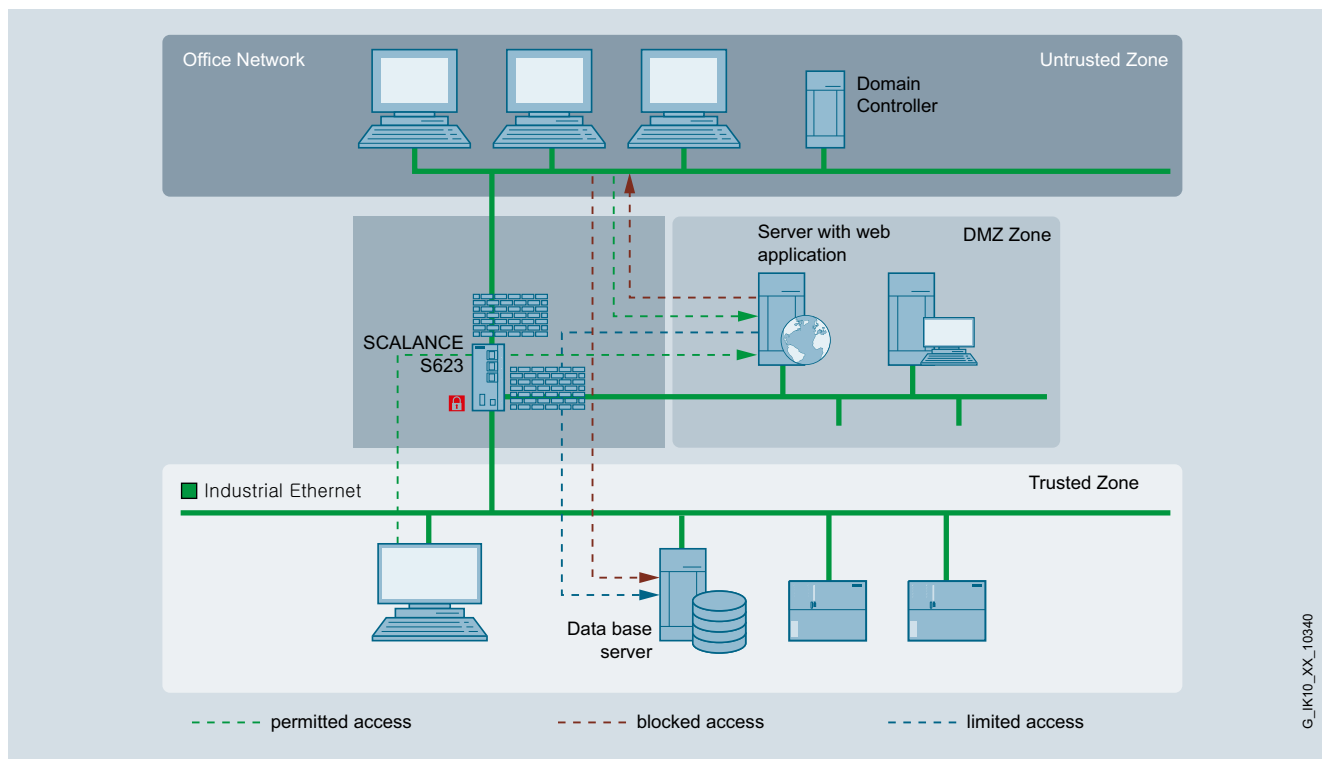

Demilitarized zone (DMZ) for remote maintenance or access to data server with SCALANCE S623

# Industrial Security Security Integrated

## SCALANCE S

### Function (continued)

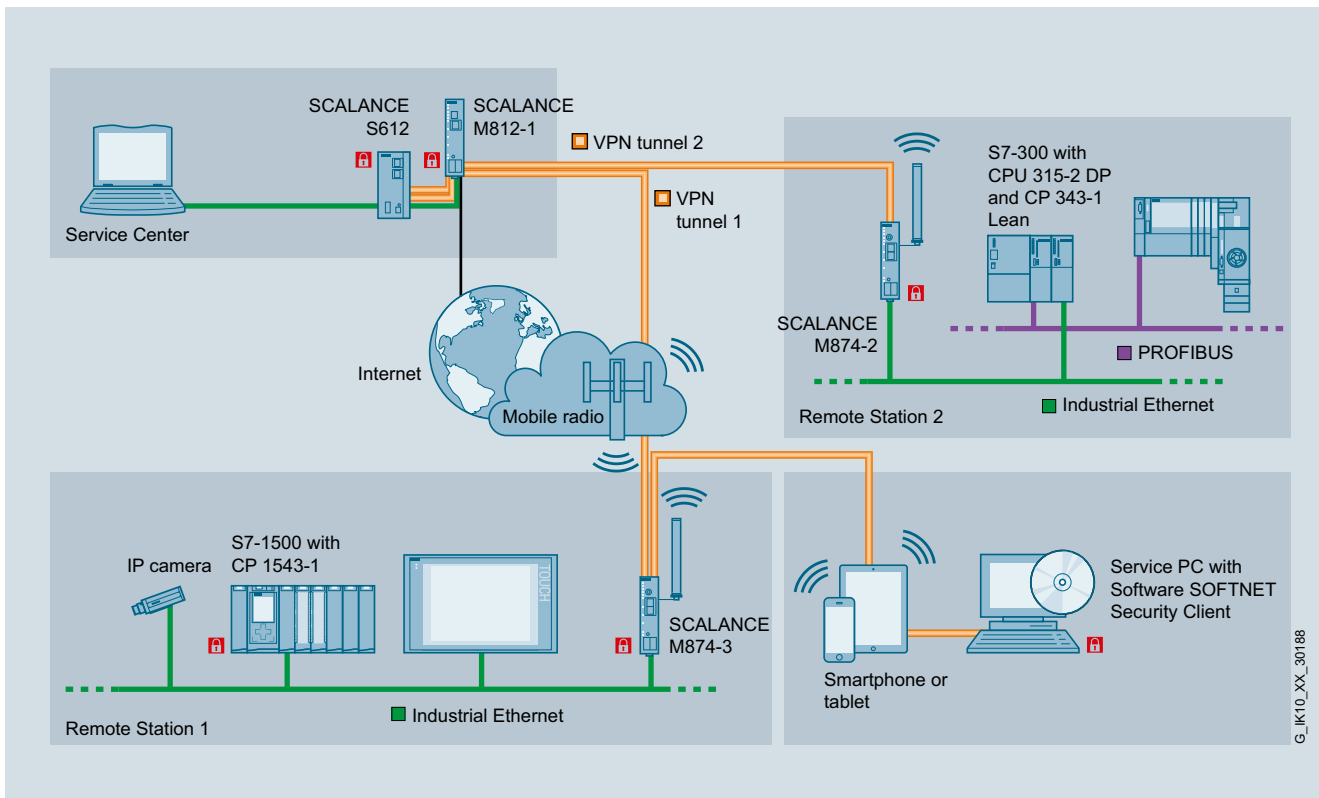

G\_IK10\_XX\_30188

Secure remote access over Internet with SCALANCE S and SCALANCE M

8

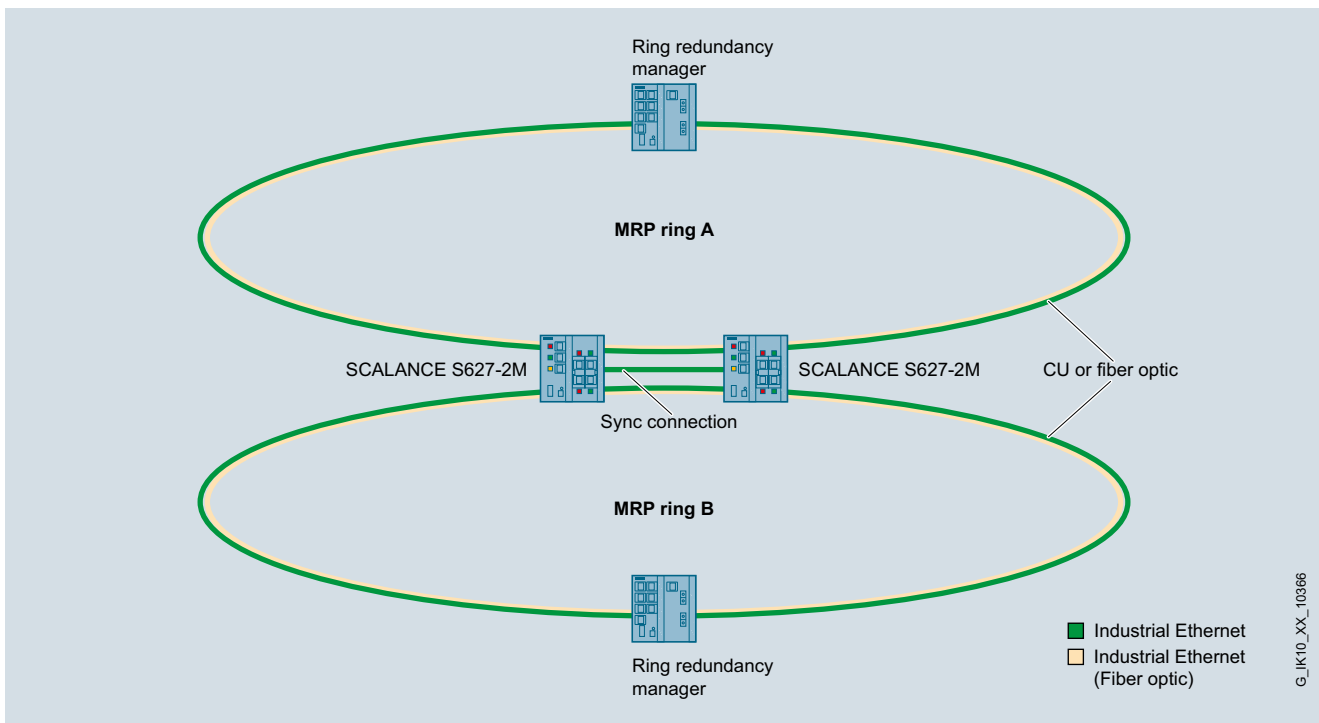

G\_IK10\_XX\_10366

Secure, redundant connection between two MRP rings with SCALANCE S627-2M

Function (continued)

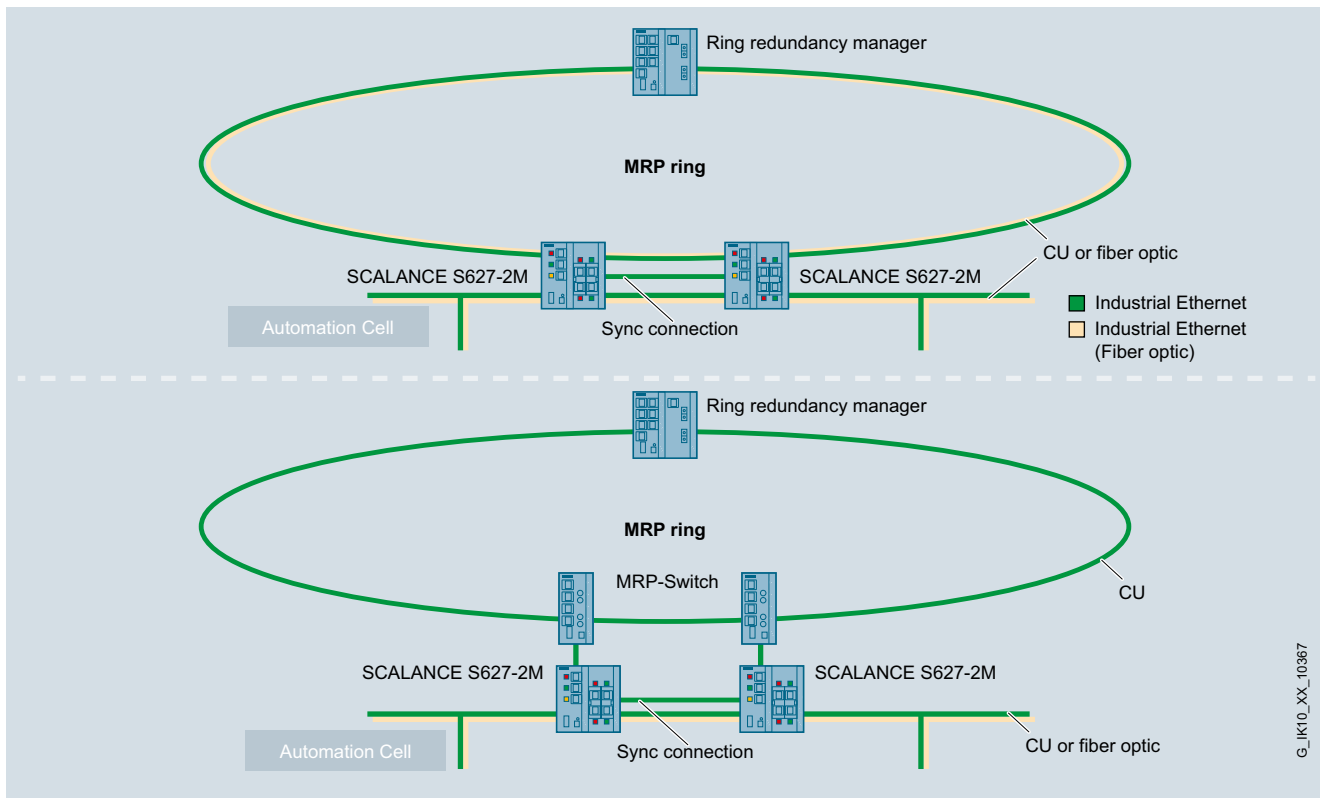

Secure, redundant connection of an automation cell to a redundant ring with SCALANCE S627-2M

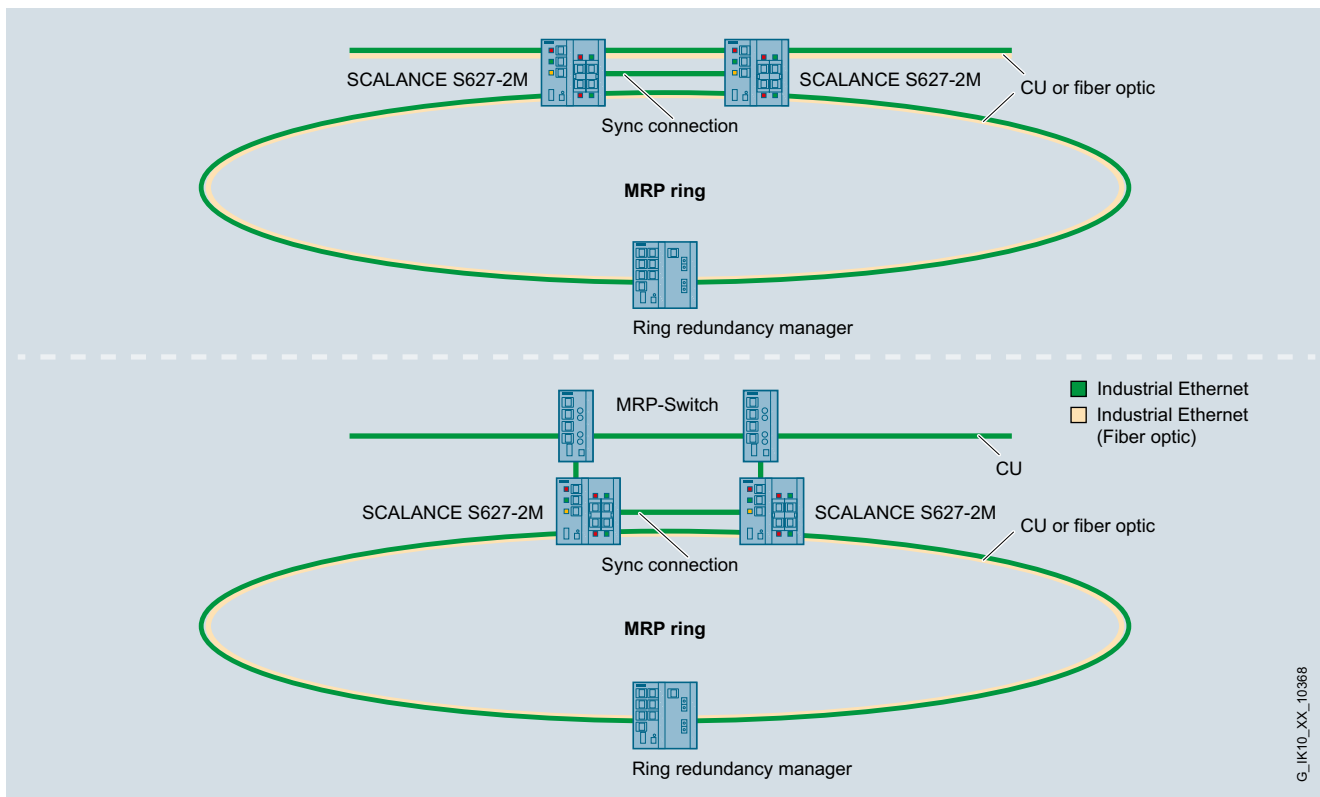

Secure, redundant connection of a redundant ring to a plant network with SCALANCE S627-2M

# Industrial Security

## Security Integrated

### SCALANCE S

#### Technical specifications

Article No.	6GK5602-0BA10-2AA3	6GK5612-0BA10-2AA3	6GK5623-0BA10-2AA3
Product-type designation	SCALANCE S602	SCALANCE S612	SCALANCE S623
<b>Transmission rate</b>			
Transfer rate 1	10 Mbit/s	10 Mbit/s	10 Mbit/s
Transfer rate 2	100 Mbit/s	100 Mbit/s	100 Mbit/s
Transfer rate 3	1 000 Mbit/s	1 000 Mbit/s	1 000 Mbit/s
<b>Interfaces</b>			
Number of electrical/optical connections for network components or terminal equipment maximum	2	2	3
Number of electrical connections			
• for internal network	1	1	1
• for external network	1	1	1
• for DMZ	0	0	1
• for signaling contact	1	1	1
• for power supply	1	1	1
• for redundant power supply	1	1	1
Design of the electrical connection			
• for internal network	RJ45 port	RJ45 port	RJ45 port
• for external network	RJ45 port	RJ45 port	RJ45 port
• for DMZ	-	-	RJ45 port
• for signaling contact	2-pole terminal block	2-pole terminal block	2-pole terminal block
• for power supply	4-pole terminal block	4-pole terminal block	4-pole terminal block
Design of the removable storage C-PLUG	Yes	Yes	Yes
<b>Signal-Inputs/outputs</b>			
Operating voltage of signaling contacts at DC rated value	24 V	24 V	24 V
Operating current of signaling contacts at DC maximum	0.1 A	0.1 A	0.1 A
<b>Supply voltage, current consumption, power loss</b>			
Type of supply voltage	DC	DC	DC
Supply voltage external	24 V	24 V	24 V
• minimum	19.2 V	19.2 V	19.2 V
• maximum	28.8 V	28.8 V	28.8 V
Consumed current maximum	0.5 A	0.5 A	0.6 A
Product component fusing at power supply input	Yes	Yes	Yes
Type of fusing at input for supply voltage	Non-replaceable melting fuse (F 3 A / 32 V)	Non-replaceable melting fuse (F 3 A / 32 V)	Non-replaceable melting fuse (F 3 A / 32 V)
Active power loss at 24V for DC typical	6.72 W	6.72 W	6.96 W
<b>Permitted ambient conditions</b>			
Ambient temperature			
• during operating	-40 ... +60 °C	-40 ... +60 °C	-40 ... +60 °C
• during storage	-40 ... +80 °C	-40 ... +80 °C	-40 ... +80 °C
• during transport	-40 ... +80 °C	-40 ... +80 °C	-40 ... +80 °C
Relative humidity at 25 °C without condensation during operating maximum	95 %	95 %	95 %
Protection class IP	IP20	IP20	IP20

## Technical specifications (continued)

Article No.	6GK5602-0BA10-2AA3	6GK5612-0BA10-2AA3	6GK5623-0BA10-2AA3
Product-type designation	SCALANCE S602	SCALANCE S612	SCALANCE S623
<b>Design, dimensions and weight</b>			
Design	compact	compact	compact
Width	60 mm	60 mm	60 mm
Height	125 mm	125 mm	125 mm
Depth	124 mm	124 mm	124 mm
Net weight	0.8 kg	0.8 kg	0.81 kg
Mounting type			
• 35 mm DIN rail mounting	Yes	Yes	Yes
• S7-300 rail mounting	Yes	Yes	Yes
• wall mounting	Yes	Yes	Yes
Mounting type	Screw mounting on horizontal and vertical surfaces	Screw mounting on horizontal and vertical surfaces	Screw mounting on horizontal and vertical surfaces
<b>Product properties, functions, components general</b>			
Product function DynDNS client	Yes	Yes	Yes
Protocol is supported PPPoE	Yes	Yes	Yes
<b>Product functions management, configuration</b>			
Product function symbolic names for IP addresses	Yes	Yes	Yes
Protocol is supported			
• SNMP v1	Yes	Yes	Yes
• SNMP v3	Yes	Yes	Yes
Type of configuration	SCT: Security Configuration Tool (included in scope of delivery)	SCT: Security Configuration Tool (included in scope of delivery)	SCT: Security Configuration Tool (included in scope of delivery)
<b>Product functions Diagnosis</b>			
Product function			
• SysLog	Yes	Yes	Yes
• Packet Filter Log	Yes	Yes	Yes
• Audit Log	Yes	Yes	Yes
• System Log	Yes	Yes	Yes
<b>Product functions DHCP</b>			
Product function DHCP server - internal network	Yes	Yes	Yes
<b>Product functions Routing</b>			
Product function static IP routing	Yes	Yes	Yes
<b>Product functions Security</b>			
Design of the firewall	Stateful inspection	Stateful inspection	Stateful inspection
Product function with VPN connection	-	IPSec	IPSec
Type of encryption algorithms with VPN connection	-	AES-256, AES-192, AES-128, 3DES-168, DES-56	AES-256, AES-192, AES-128, 3DES-168, DES-56
Type of authentication procedure with VPN connection	-	Preshared key (PSK), X.509v3 certificates	Preshared key (PSK), X.509v3 certificates
Type of hashing algorithms with VPN connection	-	MD5, SHA-1	MD5, SHA-1
Number of possible connections for VPN connection	0	128	128
Number of network stations			
• maximum	0	128	128
• note	-	Limitation only applies in bridge mode. No limitation in routing mode	Limitation only applies in bridge mode. No limitation in routing mode
Product function			
• Password protection	Yes	Yes	Yes
• bandwidth limiting	Yes	Yes	Yes
• NAT/NAPT	Yes	Yes	Yes

# Industrial Security

## Security Integrated

### SCALANCE S

#### Technical specifications (continued)

Article No.	6GK5602-0BA10-2AA3	6GK5612-0BA10-2AA3	6GK5623-0BA10-2AA3
Product-type designation	SCALANCE S602	SCALANCE S612	SCALANCE S623
<b>Product functions Time</b>			
Product function pass on time synchronization	Yes	Yes	Yes
Protocol is supported NTP	Yes	Yes	Yes
Product component Hardware real-time clock	Yes	Yes	Yes
Product property battery-backed hardware real-time clock	Yes	Yes	Yes
<b>Standards, specifications, approvals</b>			
Standard			
• for EMC from FM	FM 3611	FM 3611	FM 3611
• for hazardous zone	EN 60079-0: 2006, EN60079-15: 2005, II 3 G Ex nA IIT..., KEMA 07 ATEX 0145 X	EN 60079-0: 2006, EN60079-15: 2005, II 3 G Ex nA IIT..., KEMA 07 ATEX 0145 X	EN 60079-0: 2006, EN60079-15: 2005, II 3 G Ex nA IIT..., KEMA 07 ATEX 0145 X
• for security of CSA and UL	UL 60950 / CSA C22.2 No. 60950-00, UL 508 / CSA C22.2 No. 142	UL 60950 / CSA C22.2 No. 60950-00, UL 508 / CSA C22.2 No. 142	UL 60950 / CSA C22.2 No. 60950-00, UL 508 / CSA C22.2 No. 142
• for emitted interference	EN 61000-6-4 : 2007	EN 61000-6-4 : 2007	EN 61000-6-4 : 2007
• for interference immunity	EN 61000-6-2 : 2005	EN 61000-6-2 : 2005	EN 61000-6-2 : 2005
Verification of suitability	AS/NZS 2064 (Class A), EN 61000-6-2, EN 61000-6-4, marine classification pending	AS/NZS 2064 (Class A), EN 61000-6-2, EN 61000-6-4, marine classification pending	AS/NZS 2064 (Class A), EN 61000-6-2, EN 61000-6-4, marine classification pending
• CE mark	Yes	Yes	Yes
• C-Tick	Yes	Yes	Yes
Marine classification association			
• American Bureau of Shipping Europe Ltd. (ABS)	No	No	No
• Bureau Veritas (BV)	No	No	No
• Det Norske Veritas (DNV)	No	No	No
• Germanische Lloyd (GL)	No	No	No
• Lloyds Register of Shipping (LRS)	No	No	No
• Nippon Kaiji Kyokai (NK)	No	No	No
• Polski Rejestr Statkow (PRS)	No	No	No
<b>Accessories</b>			
Product expansion optional C-PLUG	Yes	Yes	Yes

Article No.	6GK5627-2BA10-2AA3
Product-type designation	SCALANCE S627-2M
<b>Transmission rate</b>	
Transfer rate 1	10 Mbit/s
Transfer rate 2	100 Mbit/s
Transfer rate 3	1 000 Mbit/s
<b>Interfaces</b>	
Number of electrical/optical connections for network components or terminal equipment maximum	7
Number of electrical connections	
• for internal network	3
• for external network	3
• for DMZ	1
• for signaling contact	1
• for power supply	1
• for redundant power supply	1
Design of the electrical connection	
• for internal network	
• for external network	
• for DMZ	RJ45 port
• for signaling contact	2-pole terminal block
• for power supply	4-pole terminal block
Design of the removable storage C-PLUG	Yes

Article No.	6GK5627-2BA10-2AA3
Product-type designation	SCALANCE S627-2M
<b>Signal-Inputs/outputs</b>	
Operating voltage of signaling contacts at DC rated value	24 V
Operating current of signaling contacts at DC maximum	0.1 A
<b>Supply voltage, current consumption, power loss</b>	
Type of supply voltage	DC
Supply voltage external	24 V
• minimum	19.2 V
• maximum	28.8 V
Consumed current maximum	0.7 A
Product component fusing at power supply input	Yes
Type of fusing at input for supply voltage	Non-replaceable melting fuse (F 3 A / 32 V)
Active power loss at 24V for DC typical	12 W

## Technical specifications (continued)

Article No.	6GK5627-2BA10-2AA3	Article No.	6GK5627-2BA10-2AA3
Product-type designation	SCALANCE S627-2M	Product-type designation	SCALANCE S627-2M
<b>Permitted ambient conditions</b>		<b>Product functions Security</b>	
Ambient temperature		Design of the firewall	Stateful inspection
• during operating	-40 ... +60 °C	Product function with VPN connection	IPSec
• during storage	-40 ... +70 °C	Type of encryption algorithms with VPN connection	AES-256, AES-192, AES-128, 3DES-168, DES-56
• during transport	-40 ... +70 °C	Type of authentication procedure with VPN connection	Preshared key (PSK), X.509v3 certificates
Relative humidity at 25 °C without condensation during operating maximum	95 %	Type of hashing algorithms with VPN connection	MD5, SHA-1
Protection class IP	IP20	Number of possible connections for VPN connection	128
<b>Design, dimensions and weight</b>		Number of network stations for internal network with VPN connection	
Design	Compact	• maximum	128
Width	120 mm	• note	Limitation only applies in bridge mode. No limitation in routing mode
Height	125 mm	Product function	
Depth	124 mm	• Password protection	Yes
Net weight	1.3 kg	• bandwidth limiting	Yes
Mounting type		• NAT/NAPT	Yes
• 35 mm DIN rail mounting	Yes	<b>Product functions Time</b>	
• S7-300 rail mounting	Yes	Product function pass on time synchronization	Yes
• wall mounting	Yes	Protocol is supported NTP	Yes
Mounting type	Screw mounting on horizontal and vertical surfaces	Product component Hardware real-time clock	Yes
<b>Product properties, functions, components general</b>		Product property battery-backed hardware real-time clock	Yes
Product function DynDNS client	Yes	<b>Standards, specifications, approvals</b>	
Protocol is supported PPPoE	Yes	Standard	
<b>Product functions management, configuration</b>		• for EMC from FM	FM 3611
Product function symbolic names for IP addresses	Yes	• for hazardous zone	EN 60079-0: 2006, EN60079-15: 2005, II 3 G Ex nA IIT..., KEMA 07 ATEX 0145 X
Protocol is supported		• for security of CSA and UL	UL 60950 / CSA C22.2 No. 60950-00, UL 508 / CSA C22.2 No. 142
• SNMP v1	Yes	• for emitted interference	EN 61000-6-4 : 2007
• SNMP v3	Yes	• for interference immunity	EN 61000-6-2 : 2005
Type of configuration	SCT: Security Configuration Tool (included in scope of delivery)	Verification of suitability	AS/NZS 2064 (Class A), EN 61000-6-2, EN 61000-6-4, marine classification pending
<b>Product functions Diagnosis</b>		• CE mark	Yes
Product function		• C-Tick	Yes
• SysLog	Yes	Marine classification association	
• Packet Filter Log	Yes	• American Bureau of Shipping Europe Ltd. (ABS)	No
• Audit Log	Yes	• Bureau Veritas (BV)	No
• System Log	Yes	• Det Norske Veritas (DNV)	No
<b>Product functions DHCP</b>		• Germanische Lloyd (GL)	No
Product function DHCP server - internal network	Yes	• Lloyds Register of Shipping (LRS)	No
<b>Product functions Routing</b>		• Nippon Kaiji Kyokai (NK)	No
Product function static IP routing	Yes	• Polski Rejestr Statkow (PRS)	No
		<b>Accessories</b>	
		Product expansion optional C-PLUG	Yes

# Industrial Security

## Security Integrated

### SCALANCE S

#### Ordering data

##### SCALANCE S

##### industrial security modules

For protecting programmable controllers and automation networks and for securing industrial communication; Security Modules protect network segments against unauthorized access by means of stateful inspection firewall; connection of more than 10/100/1 000 Mbit/s ports; configuring tool and electronic manual on CD ROM; English, German, French, Italian, Spanish;

##### SCALANCE S602

**6GK5602-0BA10-2AA3**

##### SCALANCE S612

up to 128 VPN tunnels simultaneously

**6GK5612-0BA10-2AA3**

##### SCALANCE S623

up to 128 VPN tunnels simultaneously; additional RJ45 DMZ port

**6GK5623-0BA10-2AA3**

##### SCALANCE S627-2M

up to 128 VPN tunnels simultaneously; additional RJ45 DMZ port; two additional slots for one 2-port media module each

**6GK5627-2BA10-2AA3**

#### Accessories

##### IE FC TP Standard Cable GP 2 x 2 (Type A)

4-core, shielded TP installation cable for connecting to IE FC RJ45 outlet / IE FC RJ45 plug; PROFINET-compliant; with UL approval; sold by the meter; max. length 1 000 m, minimum order 20 m

**6XV1840-2AH10**

##### IE FC RJ45 Plug 180

RJ45 plug-in connector for Industrial Ethernet with a rugged metal enclosure and integrated insulation displacement contacts for connecting Industrial Ethernet FC installation cables; with 180° cable outlet; for network components and CPs/CPUs with Industrial Ethernet interface

- 1 pack = 1 unit
- 1 pack = 10 units
- 1 pack = 50 units

**6GK1901-1BB10-2AA0**

**6GK1901-1BB10-2AB0**

**6GK1901-1BB10-2AE0**

##### IE FC stripping tool

Preadjusted stripping tool for fast stripping of Industrial Ethernet FC cables

**6GK1901-1GA00**

##### SITOP compact 24 V/ 0.6 A

1-phase power supply with wide-range input 85 – 264 V AC/110 – 300 V DC, stabilized output voltage 24 V, rated output current value 0.6 A, slim design

**6EP1331-5BA00**

##### C-PLUG

Swap medium for simple replacement of devices in the event of a fault; for storing configuration or application data; can be used for SIMATIC NET products with C-PLUG slot

**6GK1900-0AB00**

#### SOFTNET Security Client

Software for designing secure IP-based VPN connections from a programming device/PC to network segments which are secured by SCALANCE S; single license for 1 installation, runtime software (German/English), configuring tool (German/English) and electronic manual on CD-ROM (German/English/French/Spanish/Italian)

##### SOFTNET Security Client Edition 2008

For 32-bit Windows, XP Professional + SP1, SP2, SP3

**6GK1704-1VW02-0AA0**

##### SOFTNET Security Client V3

For 32-bit Windows 7 Professional, Ultimate, Windows XP Professional + SP3

**6GK1704-1VW03-0AA0**

##### SOFTNET Security Client V4

For 32/64-bit Windows 7 Professional/Ultimate

**6GK1704-1VW04-0AA0**

#### Note:

Check the current country list:

<http://support.automation.siemens.com/WW/view/en/66627157>

#### More information

You will find more information on the topic of Industrial Security on the Internet at:

<http://www.siemens.com/industrialsecurity>



## Overview



The **SCALANCE M874-3** is a mobile wireless router for cost-effectively and securely connecting Ethernet-based subnets and programmable controllers via the 3rd generation mobile wireless network (UMTS) and it supports HSPA+ (High Speed Packet Access). Thus, it allows high transfer rates of up to 14.4 Mbit/s in the downlink and up to 5.76 Mbit/s in the uplink (depending on the infrastructure of the mobile wireless provider).

The **SCALANCE M874-2** is a mobile wireless router for cost-effectively and securely connecting Ethernet-based subnets and programmable controllers via the 2nd generation mobile wireless network (GSM) and it supports GPRS (General Packet Radio Service) and EDGE (Enhanced Data Rates for GSM Evolution).

The security of access and communication is ensured by the security functions of the integrated firewall and by VPN tunnels (end-to-end connection encryption through IPsec tunneling).

**SCALANCE M875** is a UMTS router for wireless IP communication between Industrial Ethernet-based programmable controllers via mobile radio networks of the 3<sup>rd</sup> generation (UMTS) and the 2<sup>nd</sup> generation (GSM)

- High data transfer rate thanks to HSDPA
- Integrated security functions with firewall
- Use as VPN end point (IPsec)
- Approved for railway applications



**SCALANCE M812-1** and **SCALANCE M816-1** are DSL routers for the low-cost and secure connection of Ethernet-based subnets and automation devices to wired telephone or DSL networks that support ADSL2+ (Asynchronous Digital Subscriber Line). This allows the devices to have high downlink data rates of up to 25 Mbit/s and uplink data rates of up to 3.5 Mbit/s. The security of access and communication is ensured by the security functions of the integrated firewall and by VPN tunnels (end-to-end connection encryption through IPsec tunneling).

The **SCALANCE M826-2** is an SHDSL modem for low-cost, secure connection of Ethernet-based subnets and programmable controllers via existing two-wire or stranded cables and supports the ITU-T standard G.991.2 as well as SHDSL.biz (single-pair high-speed digital subscriber line). This gives the device high symmetrical data rates of up to 15.3 Mbit/s per wire pair.

The security of access and communication is ensured by the security functions of the integrated firewall and by VPN tunnels (end-to-end connection encryption through IPsec tunneling).

Note:

Further information on SCALANCE M can be found in Chapter 7, Industrial Remote Communication, under "Remote networks/ IP-based modems and routers".



## Industrial Security

### Security Integrated

#### CP 1243-1 and CP 1543-1

#### Overview



#### CP 1243-1

The CP 1243-1 communication processor securely connects the SIMATIC S7-1200 controller to Ethernet networks. With its integrated security functions of firewall (Stateful Inspection) and VPN protocol (IPSec), the communications processor protects S7-1200 stations and lower-level networks against unauthorized access, and protects the data transmission against manipulation and espionage by means of encryption. Furthermore, the CP can be used for integrating the S7-1200 station into the TeleControl Server Basic control center software via IP-based remote networks.



#### CP 1543-1

The SIMATIC CP 1543-1 communications processor securely connects the new SIMATIC S7-1500 controller to Industrial Ethernet networks. With its integrated security functions of firewall (Stateful Inspection), VPN protocol (IPSec) and protocols for data encryption such as FTPS and SNMPv3, the communications processor protects S7-1500 stations and lower-level networks against unauthorized access, as well as protecting data transmission against manipulation and espionage by means of encryption.

#### Note:

Further information on CP 1243-1 and CP 1543-1 can be found Chapter 2, PROFINET/Industrial Ethernet, under "System connection for SIMATIC S7/communication for SIMATIC S7-1500".

8

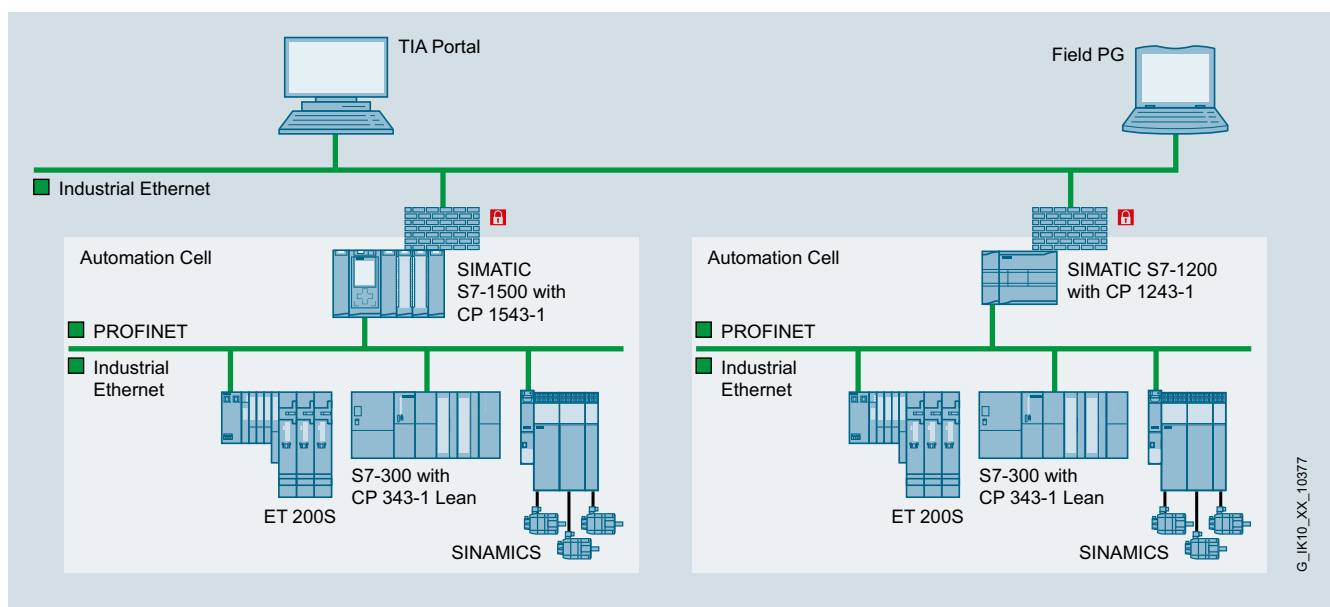

Segmentation of networks and protection of the S7-1500 with CP 1543-1 or S7-1200 with CP 1243-1

G\_IK10\_XX\_10377

**Overview**

**CP 343-1 Advanced**

Communications processor for connecting the SIMATIC S7-300/ SINUMERIK 840D powerline to Industrial Ethernet networks, also as PROFINET IO controller and IO device.

The CP supports:

- PG/OP communication
- S7 communication
- Open communication (SEND/RECEIVE)
- PROFINET communication
- IT communication
- Security functionality, firewall and VPN

**CP 443-1 Advanced**

Communications processor for connecting a SIMATIC S7-400 to Industrial Ethernet networks, also as PROFINET IO controller or in SIMATIC H systems.

The CP supports:

- PG/OP communication
- S7 communication
- Open communication (SEND/RECEIVE)
- PROFINET communication
- IT communication
- Security functionality, firewall and VPN

Note:

Further information on the CP 343-1 Advanced and CP 443-1 Advanced can be found in Chapter 2, PROFINET/Industrial Ethernet, under "System connection for SIMATIC S7 communication for SIMATIC S7-300 or S7-400".

Alongside the familiar communication functions (integrated switch and Layer 3 routing functionality) the CP 343-1 Advanced and CP 443-1 Advanced Industrial Ethernet communications processors also contain the "Security Integrated" function Stateful Inspection Firewall and a VPN gateway to protect the controller and lower-level networks against security risks.

# Industrial Security Security Integrated

## CP 343-1 Advanced and CP 443-1 Advanced

### Overview (continued)

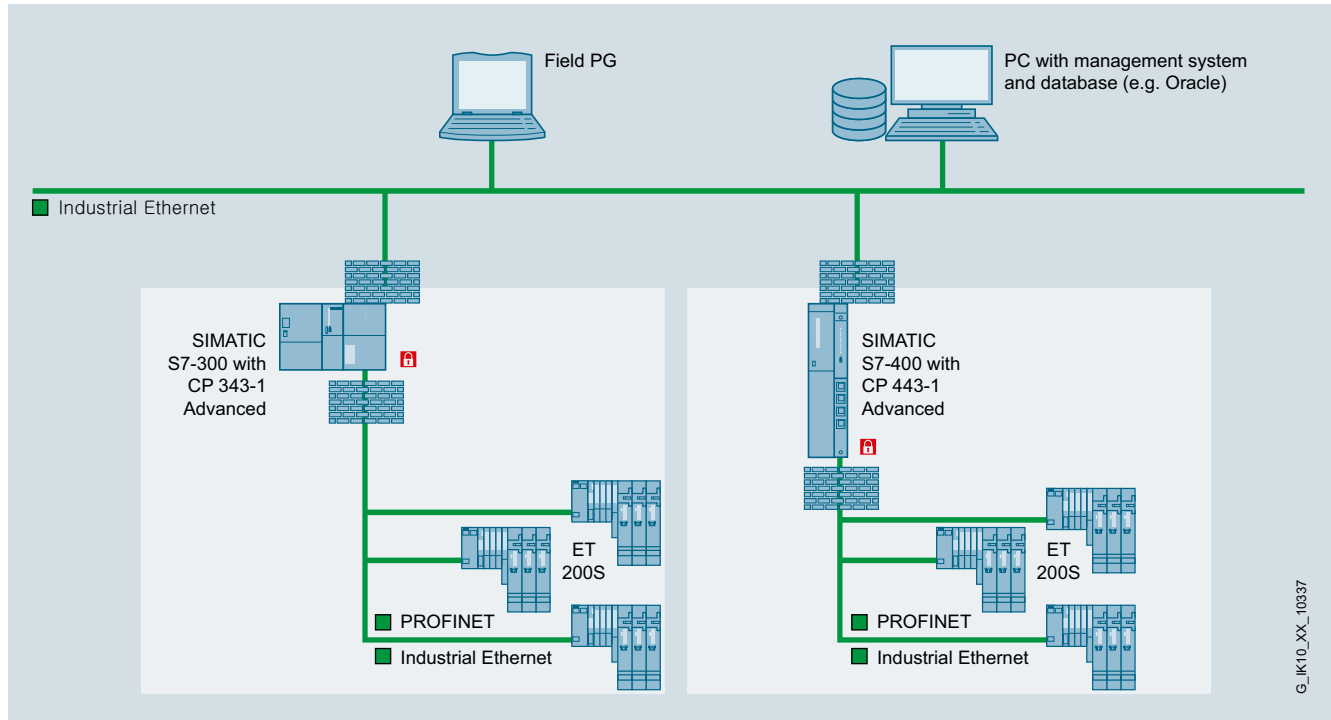

Segmentation of networks and protection of the S7-300 or S7-400 controllers with CP 343-1 Advanced or CP 443-1 Advanced

## Overview

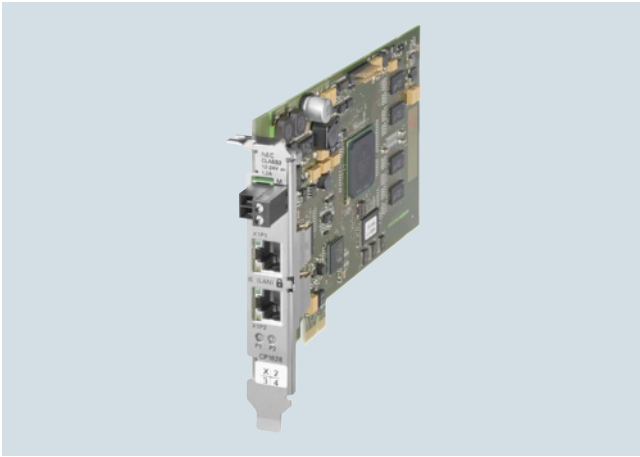

- PCI Express card (PCIe x1) with its own microprocessor and integrated 2-port switch (2 x RJ45 connection, 10/100/1 000 Mbit/s) for the connection of a PG/PC to Industrial Ethernet
- Integrated security mechanisms (e.g. Firewall, VPN)
- ISO and TCP/IP transport protocol on board
- Communications services via
  - Open IE communication (TCP/IP and UDP)
  - ISO transport protocol
  - PG/OP communication
  - S7 communication
  - Open communication (SEND/RECEIVE)
- Integration into network management systems through the support of SNMP (V1/V3)

Note:

Further information on the CP 1628 can be found in Chapter 2, PROFINET/Industrial Ethernet, under "System connection for PG/PC/IPC/communication for PC-based systems".

Industrial PCs are protected by firewall and VPN via the CP 1628 Industrial Ethernet communications processor – for secure communication without special operating system settings. This means that computers equipped with the module can be connected to protected cells. The CP 1628 makes it possible to connect SIMATIC PG/PC and PCs with PCI Express slots to Industrial Ethernet (10/100/1 000 Mbit/s).

Additional field devices can be flexibly connected to Industrial Ethernet via the integrated switch. Along with the automation functions familiar from CP 1623, the communications processor also contains "Security Integrated", i.e. a Stateful Inspection Firewall and a VPN gateway to protect the PG/PC system against security risks.

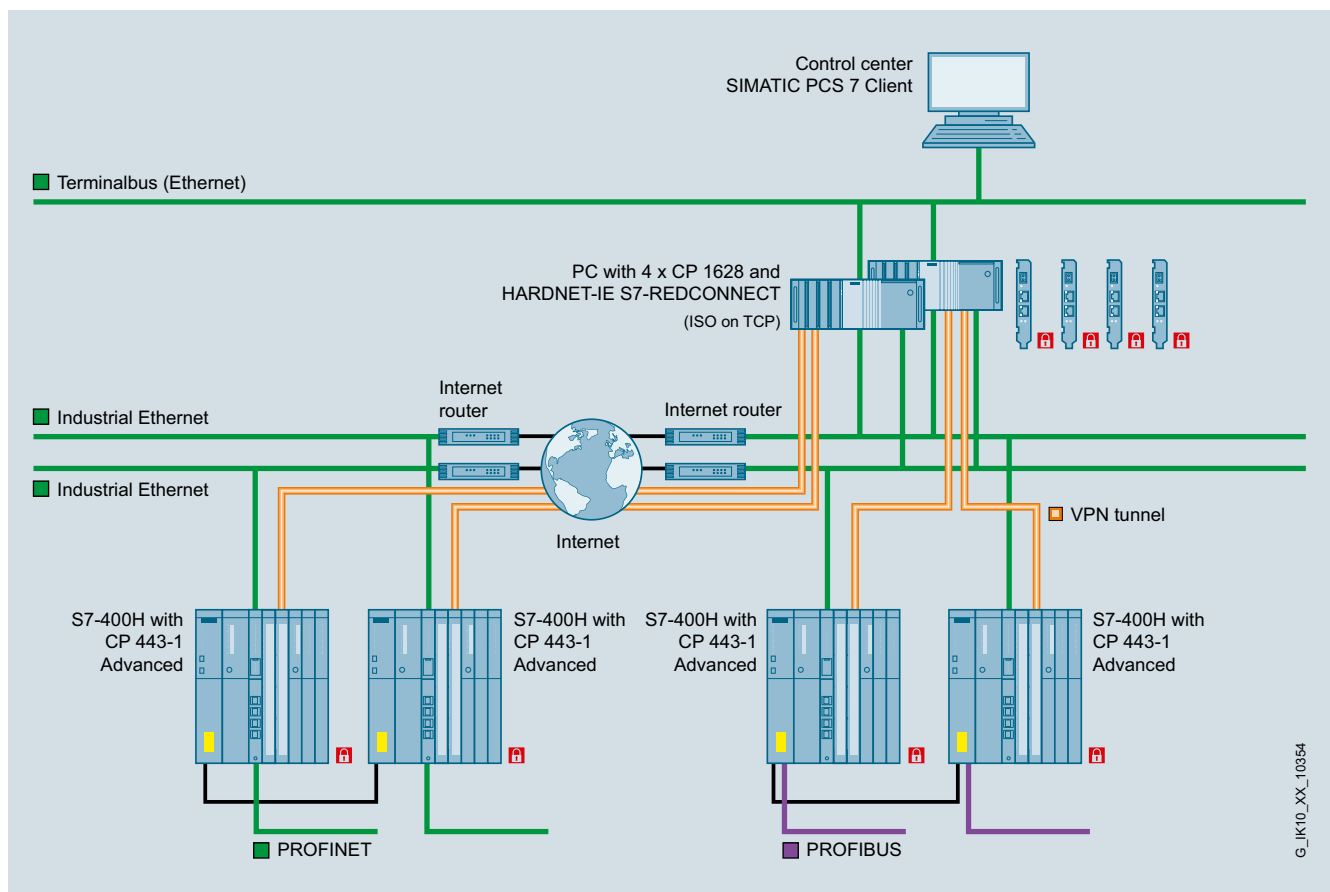

Secure redundant connection to CP 1628 and CP 443-1 Advanced

## Industrial Security

### Security Integrated

#### SOFTNET Security Client

##### Overview

- The SOFTNET Security Client is a component of the Industrial Security concept for protecting programmable controllers and for security during data exchange between automation systems.
- It is a VPN client for programming devices, PCs and notebooks in industrial environments and supports secure client access via LAN or even WAN (e.g. for remote maintenance via the Internet) to automation systems protected by Security Integrated devices with VPN functionality
- Data transmission is protected against operator error, eavesdropping/espionage and manipulation; communication can only take place between authenticated and authorized devices
- Use of field-proven IPsec mechanisms for setting up and operating VPNs.

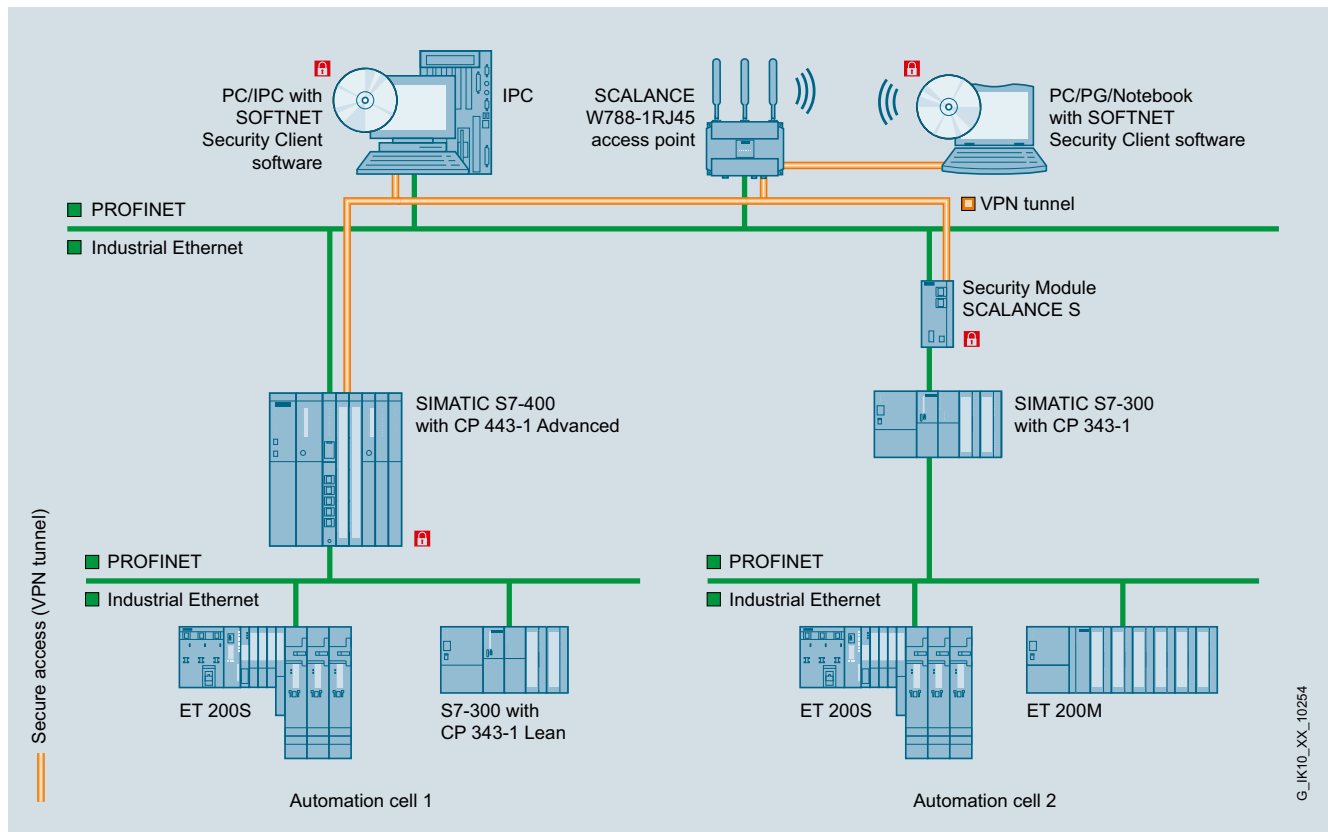

Secure access to automation cells protected by Security Integrated devices with VPN functionality with the SOFTNET Security Client

##### Benefits

- Avoidance of system disruptions through exclusive access to programmable controllers or complete automation cells using approved programming devices or notebooks
- High flexibility when used on mobile PCs as no hardware is required for securing the communication
- Uniform configuration and integrated security concept for automation engineering with SCALANCE S, the security S7-CPs (CP 1243-1, CP 1543-1, CP 343-1 Adv., CP 443-1 Adv.), the PC-CP 1628, the CP 1543-1, the CP 1243-1 and the SOFTNET Security Client without special IT know-how
- Protection of data transmission against espionage and manipulation based on certified standards
- Considerable savings when used as a remote maintenance solution together with SCALANCE S and SCALANCE M compared to expensive service callouts

##### Application

The security modules of the SCALANCE S family are provided specially for use in automation, yet connect seamlessly with the security structures of the office and IT world. They provide security and meet the specific requirements of automation technology, such as simple upgrades of existing systems, simple installation and minimum downtimes if a fault occurs.

Depending on the particular security needs, various different security measures can be combined. The SOFTNET Security Client allows programming devices, PCs, and notebooks access to devices with IPsec VPN functionality (e.g. SCALANCE S, SCALANCE M, CP 1243-1, CP 1543-1, CP 343-1/CP 443-1 Advanced, CP 1628), protected network stations or automation systems.

**Function****Authentication**

Since IP addresses can be falsified (IP spoofing), checking the IP address (of the client access) is not sufficient for reliable authentication. In addition to this, Client PCs may have changing IP addresses. For this reason, the authentication is performed using tried and tested VPN mechanisms.

**Data encryption**

Secure encryption is necessary to protect data traffic from espionage and manipulation. This means that the data traffic remains incomprehensible to any eavesdropper in the network. To achieve this, the SOFTNET Security Client establishes connections on IPsec based VPN tunnels to other SCALANCE S, SCALANCE M, the S7 Security CPs or the PC-CP 1628.

**Performance data**

System requirements (please note the descriptions under "Ordering data"):

Windows 7 Professional or Ultimate 32/64-bit  
Windows XP Professional (32-bit) + SP3

**Configuration**

Using the associated configuration tool it is possible to create and manage security rules even without special security knowledge. In the simplest case, only the SCALANCE S modules or SOFTNET Security Clients that will communicate with each other are created and configured. As soon as SOFTNET Security Client knows the programmable controllers to be accessed, communication can be established.

**Ordering data****SOFTNET Security Client V4 HF1****6GK1704-1VW04-0AA0**

Software for designing secure IP-based VPN connections from a programming device/PC to network segments which are secured by SCALANCE S, SCALANCE M, CP 1243-1, CP 1543-1, CP 343-1 Advanced, CP 443-1 Advanced, CP 1628, CP 1543-1 or CP 1243-1; single license for 1 installation, runtime software (German/English), configuration tool (German/English), and electronic manual on CD-ROM (German/English/French/Spanish/Italian) for Windows 7 Professional, Ultimate, Windows XP Professional (32 bit) + SP3

**SCALANCE S Industrial Security Modules**

For protection of programmable controllers and automation networks, and for securing of industrial communication; configuration tool and electronic manual on CD-ROM  
German, English, French, Italian, Spanish

**SCALANCE S612****6GK5612-0BA10-2AA3**

Up to 128 VPN tunnels simultaneously

**SCALANCE S623****6GK5623-0BA10-2AA3**

up to 128 VPN tunnels simultaneously;  
additional RJ45 DMZ port

**SCALANCE S627-2M****6GK5627-2BA10-2AA3**

up to 128 VPN tunnels simultaneously;  
additional RJ45 DMZ port;  
two additional slots for one 2-port media module each

**SCALANCE M industrial modems and routers****SCALANCE M874 mobile radio router**

Mobile radio router for wireless IP communication from Industrial Ethernet-based subnets and programmable controllers via UMTS or GSM mobile radio networks; with integrated firewall and VPN with IPsec;  
2 x RJ45 ports,  
1 x antenna connection  
• **SCALANCE M874-3**<sup>1)</sup>  
• **SCALANCE M874-2**<sup>1)</sup>

**6GK5874-3AA00-2AA2**  
**6GK5874-2AA00-2AA2****SCALANCE M875 UMTS router**

UMTS router for wireless IP communication from Industrial Ethernet-based programmable controllers via UMTS/GSM mobile radio networks;  
EGPRS Multislot Class 12; with integrated firewall and VPN with IPsec;  
2 x RJ45 ports,  
2 x antenna connections  
• **SCALANCE M875**<sup>1)</sup>  
• **SCALANCE M875**<sup>1)</sup>  
for Japan

**6GK5875-0AA10-1AA2**  
**6GK5875-0AA10-1CA2**

# Industrial Security

## Security Integrated

### SOFTNET Security Client

#### Ordering data

#### Article No.

#### Article No.

##### *SCALANCE M industrial modems and routers (continued)*

#### SCALANCE M81x-1 ADSL router

DSL router for wired IP communication from Industrial Ethernet-based subnets and programmable controllers via telephone or DSL networks; with integrated firewall and VPN with IPsec;  
1 x or 4 x RJ45 ports for Industrial Ethernet;  
1 x RJ45 port for DSL

- **SCALANCE M812-1 (Annex A)** **6GK5812-1AA00-2AA2**
- **SCALANCE M812-1 (Annex B)** **6GK5812-1BA00-2AA2**
- **SCALANCE M816-1 (Annex A)** **6GK5816-1AA00-2AA2**
- **SCALANCE M816-1 (Annex B)** **6GK5816-1BA00-2AA2**

#### SCALANCE M826-2 SHDSL router

DSL router for wired IP communication from Industrial Ethernet-based subnets and programmable controllers via telephone or DSL networks; with integrated firewall and VPN with IPsec;  
1 x or 4 x RJ45 ports for Industrial Ethernet;  
1 x RJ45 port for DSL

- **SCALANCE M826-2 (Annex A)** **6GK5826-2AB00-2AB2**

##### *Communications processors for SIMATIC S7*

#### CP 1243-1

**communication processor;** for connection of SIMATIC S7-1200 to Industrial Ethernet via TCP/IP, ISO and UDP, Telecontrol Server Basic and security functions Stateful Inspection Firewall and VPN;  
1 x RJ45 interface with 10/100 Mbit/s

**6GK7243-1BX30-0XE0**

#### CP 1543-1

**communication processor;** for connection of SIMATIC S7-1500 to Industrial Ethernet via TCP/IP, ISO and UDP and security functions Stateful Inspection Firewall and VPN; 1 x RJ45 interface with 10/100/1 000 Mbit/s;

**6GK7543-1AX00-0XE0**

#### CP 343-1 Advanced

#### communications processor;

For connection of SIMATIC S7-300 to Industrial Ethernet over ISO and TCP/IP;  
PROFINET IO Controller or PROFINET IO Device, MRP, integrated 2-port switch ERTEC; S7 communication, open communication (SEND/RECEIVE), FETCH/WRITE, with and without RFC1006, multicast, DHCP, CPU clock synchronization via SIMATIC procedure and NTP, diagnostics, SNMP, access protection through IP access list, initialization over LAN 10/100 Mbit/s; as well as IT communication (web, e-mail, FTP); PROFINET CBA; security (firewall/VPN); PROFlenergy; with electronic manual on DVD

**6GK7343-1GX31-0XE0**

##### *Communications processors for SIMATIC S7 (continued)*

#### CP 443-1 Advanced communications processor;

For the connection of SIMATIC S7-400 to Industrial Ethernet;  
PROFINET IO Controller with RT and IRT, MRP, PROFINET CBA, TCP/IP, ISO and UDP;  
S7 communication, open communication (SEND/RECEIVE) with FETCH/WRITE, with and without RFC1006, diagnostics expansions, multicast, clock synchronization with SIMATIC mode or NTP, access protection by IP access list, FTP client/server, HTTP server, HTML diagnostics, SNMP, DHCP, e-mail, data storage on C-PLUG; PROFINET connector:  
4xRJ45 (10/100 Mbit/s) via switch;  
Gigabit connector:  
1xRJ45 (10/100/1 000 Mbit/s); with integrated stateful inspection firewall and VPN appliance

**6GK7443-1GX30-0XE0**

##### *Communications processors for PG/PC/IPC*

#### CP 1628

#### communications processor;

PCI Express x1 card for connection to Industrial Ethernet (10/100/1 000 Mbit/s), with 2-port switch (RJ45) and integrated security (firewall, VPN) via HARDNET-IE S7 and S7-REDCONNECT.  
For operating system support, see SIMATIC NET Software

**6GK1162-8AA00**

##### *Accessories*

#### IE FC RJ45 Plug 180

RJ45 plug connector for Industrial Ethernet with a rugged metal enclosure and integrated insulation displacement contacts for connecting Industrial Ethernet FC installation cables; with 180° cable outlet; for network components and CPs/CPUs with Industrial Ethernet interface

- 1 pack = 1 unit
- 1 pack = 10 units
- 1 pack = 50 units

**6GK1901-1BB10-2AA0**  
**6GK1901-1BB10-2AB0**  
**6GK1901-1BB10-2AE0**

#### ANT794-4MR antenna

Omnidirectional antenna for GSM (2G) and UMTS (3G) networks; weather-resistant for indoor and outdoor use;  
5 m cable with fixed connection to antenna;  
SMA connector; including mounting bracket, screws, wall plugs

**6NH9860-1AA00**

#### Note:

Check the current country list:

<http://support.automation.siemens.com/WWW/view/en/66627157>



## Overview

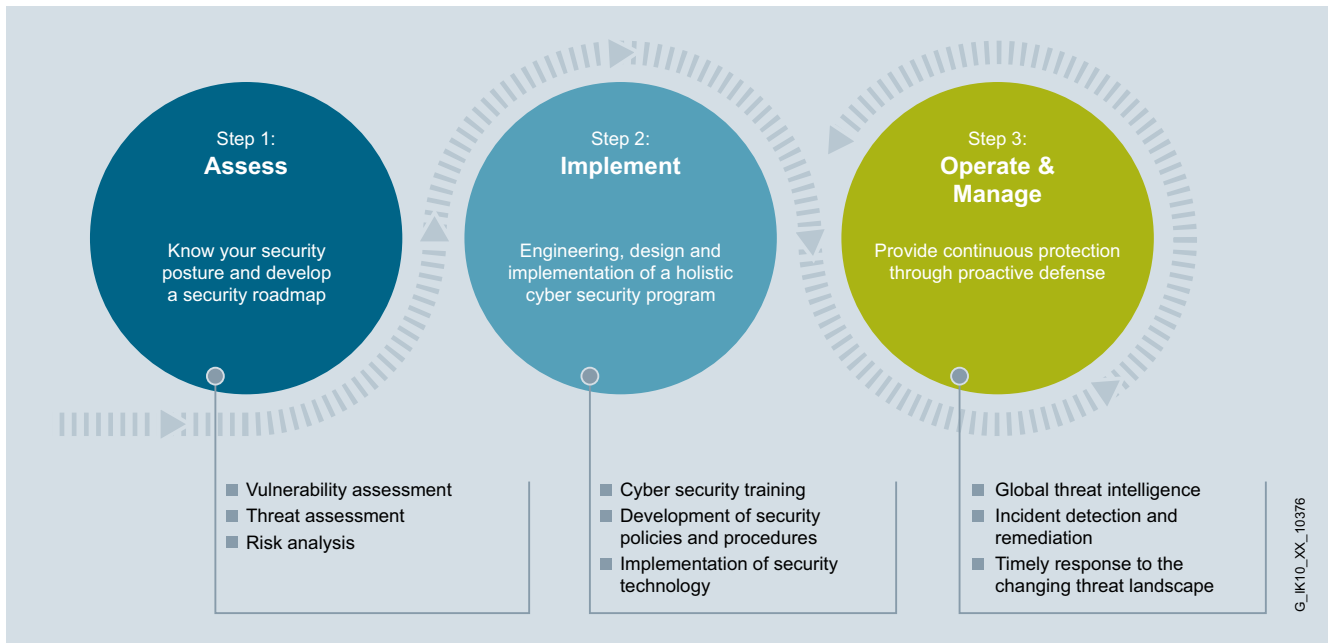

The merge of data systems in the production and office environments has made many processes faster and easier, while the use of the same data processing programs creates synergies. These developments, however, have also increased the security risk.

Today it is no longer just the office environment that is under threat from viruses, trojans and hackers - production plants are also at risk of malfunctions and data loss. Many weak spots in security are not obvious at first glance. For this reason, it is advisable to check existing plants in regard to security and to optimize them in order to maintain a higher level of plant availability. To enhance the security of a plant against cyber attacks, a multi-level service concept for Industrial Security is available from Siemens Industry.

The first step involves "assessment" – the initial examination of the existing plant. This identifies weak spots or deviations from standards. The result of this examination is a detailed report about the actual status of the plant with a description of the weak points and an assessment of the risks. The report also contains suggested actions for improving the level of security.

In the second "implementation" stage - the measures defined in the assessment are implemented, i.e.:

- **Training:**  
Personnel are given specific training so that they understand what IT and infrastructure security means in the industrial environment.
- **Process improvement:**  
Security-relevant regulations and guidelines relating to the existing plant requirements are drawn up and implemented.
- **Security technologies:**  
Protective measures are implemented for hardware and software, as well as in the plant network; in addition, long-term protection through monitoring is available.

The measures defined and implemented in the first two phases are continuously developed in the third phase of "**operation and management**", i.e. monitoring the security status of the plant, checking the security level, redefining and optimizing actions, as well as regular reports and functions such as updates, backup and restore. Even if changes are made to the plant network, the software environment or the administration of access rights for users and administrators, services increase the security level so that the corresponding data remains in the plant and attackers are given minimal opportunities to compromise the plant. The phases of implementation, operation and management are tailored precisely to meet the existing needs.

## Industrial Security

### Security Integrated

#### Industrial Security Services

##### Benefits

###### **Customer benefits**

- Determination of the security level and, based on this, drawing up a plan of action for reducing the risks
- Specific training for building up technical knowledge
- Increasing plant security through tailored processes and specifications
- Implementation of a comprehensive security solution for protecting the automation system
- Connection to a Managed Service Center for continuous monitoring of the security status of the plant
- Continuous monitoring of the security status of the plant
- Detection of incidents and adaptation of the environment to the threat
- Keeping the system up to date (pattern, patches, signatures).

##### Ordering data

##### Article No.

<b>Security assessment for complete plants</b>	<b>9AS1411-1AA11-1AA1</b>
<b>Risk and Vulnerability Assessment</b>	On request
<b>Customized analyses, projects and advice</b>	On request

##### More information

Further information can be found at:  
[www.siemens.com/industrialsecurity](http://www.siemens.com/industrialsecurity)



<b>9/2</b>	<b>Abbreviations, Explanations</b>
<b>9/16</b>	<b>Siemens Industry Training</b>
9/17	Course overview
<b>9/18</b>	<b>Standards and approbations</b>
9/18	CE marking
9/19	Quality management Certificates
<b>9/20</b>	<b>Partner at Industry Automation and Drive Technologies</b>
9/21	Siemens Solution Partner Automation
<b>9/22</b>	<b>Siemens Automation Cooperates with Education</b>
9/22	Applicable practical know-how
<b>9/24</b>	<b>Online Services</b>
9/24	Information and Ordering in the Internet and on DVD
9/25	Information and Download Center Social Media, Mobile Media
<b>9/26</b>	<b>Industry Services</b>
9/26	Your machines and plant can do more – with Industry Services
9/27	Industry Services for the entire life cycle
<b>9/31</b>	<b>Safety of electronic devices</b>
<b>9/32</b>	<b>Software Licenses</b>
<b>9/34</b>	<b>Conditions of sale and delivery</b>

## Appendix

### Abbreviations, Explanations

Term	Meaning	Explanation
<b>1</b>		
<b>10 Gigabit Ethernet</b>	—	Standard for 10 Gbit/s data transfer using fiber-optic and copper cables
<b>1000BaseT</b>	—	Gigabit Ethernet; standard for 1 000 Mbit/s data transfer on copper cables
<b>100BaseFX</b>	—	Fast Ethernet Standard for data transmission on glass fiber-optic cables
<b>100BaseT</b>	—	Fast Ethernet Standard
<b>10Base2</b>	—	Standard for the transmission of 10 Mbit/s Ethernet on thin coaxial cables; segment length: 185 m
<b>10Base5</b>	—	Standard for the transmission of 10 Mbit/s Ethernet on coaxial cables (yellow cable); segment length: 500 m
<b>10BaseFL</b>	—	Standard for the transmission of 10 Mbit/s Ethernet on glass fiber-optic cables (fiber link)
<b>10BaseT</b>	—	Standard for the transmission of 10 Mbit/s Ethernet on twisted-pair cables
<b>2, 3, 4</b>		
<b>2G</b>	—	Second-generation mobile radio standard (see also GSM/GPRS) as digital successor to analog mobile radio systems
<b>2.5G</b>	—	Extension of the second-generation mobile radio standard for higher bit rates (see also EGPRS)
<b>3G</b>	—	Third-generation mobile radio standard (see also UMTS) with significantly higher data transmission rates and global availability
<b>4G</b>	—	Fourth-generation mobile radio standard (see also LTE) as successor to 3G/UMTS with high data transmission rate
<b>A</b>		
<b>Access point</b>	—	Access Points enable wireless LANs to be connected to wired Ethernet networks. The device also enables the range of individual wireless LAN components to be extended.
<b>ACL</b>	Access Control List	List with MAC addresses that are authorized to access the radio network
<b>Actuator</b>	—	Actuator
<b>Ad-hoc network</b>	—	Radio network between two WLAN clients or terminals (e.g. laptops) (point-to-point)
<b>AES</b>	Advanced Encryption Standard	Powerful encryption mechanism in radio networks for protection against eavesdropping and unauthorized access
<b>ALI</b>	Application Layer Interface	Interface to application layer; this forms the interface between an application process and the standardized interface of the application layer and vice versa.
<b>Antenna diversity</b>	—	Procedure in which a radio receiver is equipped with two antennas and can choose the better of two received signals
<b>Antenna gain</b>	—	Improvement (passive!) of the antenna due to suitable design in comparison with an isotropic radiator
<b>AP</b>	Automation Protocol	Automation Protocol Layers 5 through 7 of the ISO reference model
<b>ASIC</b>	Application Specific Integrated Circuit	Application-specific IC
<b>AS-Interface</b>	Actuator-sensor interface	Cable for direct connection of simple binary sensors and actuators (transmission of small quantities of information)
<b>ATEX</b>	—	Approval for explosion-proof areas
<b>ATM</b>	Asynchronous Transfer Mode	Method by which the data traffic is transmitted in smaller packets of fixed length and by means of asynchronous time division multiplexing
<b>AUI</b>	Attachment Unit Interface	Interface compliant with IEEE 802.3
<b>Autocrossover</b>	—	Function that enables automatic crossover of send and receive cables at twisted pair interfaces.

## Abbreviations, Explanations

Term	Meaning	Explanation
<b>A</b>		
<b>Autonegotiation</b>	—	Configuration protocol for Ethernet. Before initiating the actual data transmission, network devices automatically negotiate a transmission mode (1000 Mbit/s, 100 Mbit/s or 10 Mbit/s, full duplex or half duplex).
<b>Autosensing</b>	—	Ability of a device to detect the data rate automatically (10 Mbit/s or 100 Mbit/s or 1 000 Mbit/s) and to then send or receive at this rate.
<b>AWG</b>	American Wire Gauge	US standard. Also known as Brown and Sharp (B&S) Wire Gauge. It specifies the diameter of copper conductors.
<b>B</b>		
<b>BERO</b>	Contactless proximity limit switch with feedback oscillator	Proximity switch
<b>BFOC</b>	Bayonet Fiber Optic Connector	Standardized connector for glass fiber-optic cables with a bayonet-lock; also referred to as "ST" (see ST connector)
<b>Broadcast</b>	Circular call in a computer network	Message, with which data packets are transmitted from one point to all stations in a network
<b>bursts</b>	—	Momentarily increased network loading due to a data surge or alarm avalanche
<b>C</b>		
<b>CBA</b>	Component Based Automation	Supports modularization in mechanical and plant engineering through the plant-wide, graphical grouping of distributed applications. Component based Automation based on the PROFINET standard of the PNO.
<b>CC</b>	Central controller	—
<b>CD</b>	Compact disc	—
<b>CSD</b>	<b>Circuit Switched Data</b>	Data transmission over a GSM dialup connection
<b>CHAP</b>	Challenge Handshake Authentication Protocol	Authentication protocol
<b>Channel Bonding</b>	—	Two channels are used simultaneously with the help of channel bonding. Gross transmission rates of up to 450 Mbit/s can be achieved in conjunction with the MIMO technology in accordance with IEEE 802.11n.
<b>CLI</b>	Command Line Interface	Alphanumeric command interface for parameterization and diagnosis over a serial interface or TELNET
<b>CLIP</b>	Calling Line Identification Presentation	Transmission of the caller's telephone number (CLIP) is a performance feature for incoming calls and can only be activated or deactivated for these
<b>Client/server communication</b>	Principle of connection setup	The network node that sets up a connection is termed the "client". A "server" on the other hand is the node to which a connection is set up.
<b>CM</b>	Communications Metallic	UL approval for copper cables for use in buildings in accordance with Section 800-53(d) of NEC. Flames do not spread upward from cable out of the cable tray in the Vertical Tray Flame Test in UL 1685, "Vertical-Tray Fire-Propagation and Smoke Release Test for Electrical and Optical-Fiber Cables".
	Communication Module	Module for communications tasks used in an automation system as a CPU interface expansion
<b>CMG</b>	—	UL Approval of a copper cable for laying in cable harnesses (general purpose)
<b>CMIP</b>	Common Management Information Protocol	—
<b>CMIS</b>	Common Management Information Service	—
<b>CMP</b>	Plenum cable (copper)	UL Approval of a copper cable for laying without additional protection in the space above dropped ceilings or below raised floors
<b>CMR</b>	Riser cable (copper)	UL Approval of a copper cable for laying between the floors of a building

## Appendix

### Abbreviations, Explanations

Term	Meaning	Explanation
<b>C</b>		
<b>CMX</b>	—	Cable for use in buildings in a cable duct or non-flammable tube. The unprotected lines or cables must not exceed 3 m in length. CMX type cable may bear the title "Outdoor". This cable meets all the conditions of the VW-1 Flame Test Requirements as defined in UL 1581.
<b>CoL</b>	Certificate of License	Certificate accompanying a software product which documents the legal ownership of a software license.
<b>Collision domain</b>	—	In order to ensure the function of the Carrier Sense Multiple Access / Collision Detection (CSMA/CD) procedure, the delay of a data package from one station to the other is limited. Depending on the transmission rate, this delay gives a physically limited expansion of the network, known as the collision domain. For 10 Mbit/s Ethernet this is 4 520 m, and for Fast Ethernet 412 m. Several collision domains can be connected with each other via bridges/switches. Full duplex permits expansions beyond a collision domain.
<b>COM/DCOM</b>	Component Object Model / Distributed Component Object Model	COM is a fundamental object model. It allows an object to make its functionality available to other components. DCOM is an extension of COM for communication over a network.
<b>CP</b>	Communication Processor	Interface module for communication tasks
<b>CPU</b>	Central Processing Unit	e.g. for SIMATIC S5/S7
<b>CSD</b>	Circuit Switched Data	Modem operation
<b>CSMA/CD</b>	Carrier Sense Multiple Access/Collision Detection	Collision access procedure for Industrial Ethernet bus systems as per IEEE 802.3
<b>D</b>		
<b>DA</b>	Destination Address	—
<b>dB<sub>i</sub></b>	—	Unit of measurement of antenna gain compared to an isotropic omnidirectional antenna
<b>DCP</b>	Discovery and Configuration Protocol	Defines the allocation of the IP parameters with vendor-specific configuration/programming tools or in the plant-wide engineering, e.g. in the PROFINET interconnection editor
<b>DDE</b>	Dynamic Data Exchange	Windows interface
<b>DDL</b>	Direct Data Link	—
<b>DDL<sub>M</sub></b>	Direct Data Link Mapper	—
<b>Deterministic features</b>	—	Predictable data traffic and defined response times
<b>DHCP</b>	Dynamic Host Configuration Protocol	De-facto standard for assigning dynamic IP addresses
<b>Diversity</b>	—	Radio receiver with two antennas for selecting the best signal
<b>DLL</b>	Dynamic Link Library	A collection of functions available to two or more programs, but which are loaded only once into the memory (Windows/Windows NT Feature).
<b>DLPI</b>	Data Link Protocol Interface	—
<b>DNP3</b>	Distributed Network Protocol	Communications standard for telecontrol systems; it is used as general transmission protocol between control station and sub-station
<b>Domain services</b>	—	An application service group which contains services for downloading/uploading of logically related memory areas.
<b>DP</b>	Distributed I/O	Input or output modules that are used by the CPU on a distributed basis. The PLC and the distributed I/O can be connected over the PROFIBUS DP bus system.
<b>DPRAM</b>	Dual Port Random Access Memory	—
<b>DSSS</b>	Direct Sequence Spread Spectrum	Spread spectrum transmission procedure (IEEE 802.11b)

## Abbreviations, Explanations

Term	Meaning	Explanation
<b>D</b>		
<b>DV</b>	Data processing	Previously also referred to as Electronic Data Processing (EDP)
<b>DVD</b>	Digital Versatile Disc	Digital optical storage medium
<b>E</b>		
<b>EEMS</b>	Extended electromechanical interface	—
<b>EGPRS</b>	Enhanced GPRS	Method of increasing the data rate in GSM mobile networks by introducing an additional modulation procedure (2.5G)
<b>EIRP</b>	Equivalent isotropic radiated power	The transmit power that must be fed to an isotropic radiator in order that it effectively emits the same performance as another antenna in a specific direction. An isotropic radiator is a theoretical antenna that radiates evenly in all directions (isotropically) and is assumed to be infinitely small.
<b>EMC</b>	Electromagnetic compatibility	—
<b>ER</b>	Extension rack	Expansion component for SIMATIC
<b>ERP</b>	Enterprise Resource Planning	Term for systems and software solutions which coordinate the business process and help with planning, e.g. SAP R3, Peoplesoft, BAAN.
<b>ERTEC</b>	Enhanced Real-Time Ethernet Controller	The Industrial Ethernet ASIC is a high-performance Ethernet controller, optimized for PROFINET with integral switch functionality and processor
<b>ESD</b>	Electro static discharge	Electric strength
<b>EU</b>	Extension unit	—
<b>Ex</b>	Intrinsically safe protective measure to DIN EN 50020	Appropriately marked modules may also be used within hazardous areas. (Regulations must be observed!)
<b>F</b>		
<b>FB</b>	Function block	—
<b>FC</b>	FastConnect	Fast connection system for Ethernet and PROFIBUS cables and connectors
<b>FC</b>	Function Call	Sequence of functions
<b>FDDI</b>	Fiber Distributed Data Interface	High-speed network standardized by ANSI for data transmission over a range of up to 100 km with a bit rate of 100 Mbit/s. Twin fiber-optic cables in opposite directions serve as the transmission medium.
<b>FDL</b>	Fieldbus Data Link	Layer 2 with PROFIBUS; it comprises the field bus link control (FLC) and medium access control (MAC).
<b>FDX</b>	Full duplex	Capability of a device for sending and receiving data at the same time. In the case of full duplex, collision detection is deactivated. A full duplex capable device is able to buffer data packets.
<b>FE</b>	Fast Ethernet	Compared with 10 Mbps Ethernet, frames at 100 Mbps are transported much faster and therefore occupy the bus for a very short time.
<b>FHSS</b>	Frequency Hopping Spread Spectrum	Transmission procedure used, for example, in Bluetooth.
<b>Filtering</b>	—	A switch filters data traffic depending on the source and destination addresses in a data packet. An incoming data packet is routed by the switch to the port to which the data terminal with the appropriate destination address is connected.
<b>FIFO principle</b>	"First in, first out" principle	Data is transmitted in telecontrol systems regardless of the respective priority
<b>FIM</b>	Field Interface Module	—
<b>Firewall</b>	—	Software or hardware component that allows or prevents data access to a PC or between interconnected networks according to given security restrictions
<b>FM</b>	—	US certificate for the installation of devices in hazardous locations (Factory Mutual Research)

## Appendix

### Abbreviations, Explanations

Term	Meaning	Explanation
<b>F</b>		
<b>FMS</b>	Fieldbus Message Specification	Upper sublayer of Layer 7 with PROFIBUS; it encompasses the functions: protocol machine, generation of PDUs, coding/decoding and interpretation of the protocol data unit.
<b>FO</b>	fiber-optic	Fiber-optic cable
<b>FO cable</b>	Fiber-optic cable	Flexible optical medium/fiber made of glass or plastic in which light can be conducted in a controlled manner
<b>Forced Roaming</b>	—	Automatic roaming if the cable connection to the access points is broken
<b>FRNC</b>	Flame Retardant Non Corrosive	Flame-retardant, halogen-free cladding material for a cable
<b>Full duplex</b>	—	Capability of a device for sending and receiving data at the same time. In the case of full duplex, collision detection is deactivated.
<b>Functional grounding</b>	—	Function for internal ground monitoring used for protection against hazardous touch voltages
<b>G</b>		
<b>Gateway</b>	—	Intelligent connection between a local network and an external network with a completely different structure
<b>GHz</b>	Gigahertz	Unit of frequency, e.g. 2.4 GHz
<b>Gigabit Ethernet</b>	—	Gigabit Ethernet (1 Gbit/s) is faster than Fast Ethernet by a factor of 10, occupying the bus for only one tenth of the time.
<b>GMRP</b>	GARP (Generic Attribute Registration Protocol) Multicast Registration Protocol	GMRP enables switches to control the forwarding of multicast messages. A host logs in or out for a multicast address. Accordingly, the managing switch forwards corresponding multicasts to the host or not. This constrains the flooding of multicasts and reduces the network load.
<b>GP</b>	General Purpose	UL listing (safety standard) for network cables is especially necessary for the American and Canadian markets. The requirements for the appropriate approvals depend on where the cable is routed within the building. This applies to all cables which have to be routed from a machine to a remote control cabinet and are positioned on cable racks secured on the building.
<b>GPRS</b>	General Packet Radio Service	A packet of networking mobile communications services based on GSM channels. GPRS enables fast communication at high transmission speeds and is chiefly of interest for mobile Internet access.
<b>GPS</b>	Global Positioning System	Satellite-supported system for determining the position of a GPS receiver. A GPS receiver can be localized precisely anywhere in the world using three of the total of 24 satellites. GPS receivers are typically built into navigation systems.
<b>GSD</b>	General Station Description	A GSD contains an XML-based description of the properties of IO devices such as communications parameters as well as number, type, configuration data, parameter and diagnostics information of modules
<b>GSM</b>	Global System for Mobile Communication	Global standard for mobile communication
<b>GVRP</b>	Generic VLAN Registration Protocol	—
<b>H</b>		
<b>HARDNET</b>	—	Software based on communications modules with internal microprocessor
<b>HART</b>	Highway Addressable Remote Transducer	Protocol for bus-addressed field devices; it is not a fieldbus, but a version of the digital field communication that contains many of the functionalities of fieldbuses
<b>HCS</b>	—	Trademark of Spectran Specialty Optics
<b>H-communication</b>	Fault-tolerant communication	Fault-tolerant, redundant communication with SIMATIC S7-H systems
<b>HDX</b>	Half Duplex	A device can either receive or send data at a given time.
<b>HMI</b>	Human Machine Interface	Operator control and process monitoring products/systems at Siemens



## Abbreviations, Explanations

Term	Meaning	Explanation
<b>H</b>		
<b>HRP</b>	High Speed Redundancy Protocol	For use in high-availability plant networks, high-speed redundancy in the ring can be implemented. The reconfiguration time for 50 switches in the ring is up to 300 ms
<b>HTB</b>	Data handling block	HTB are standard function blocks that allow data transfer between boards outfitted with page frame addresses.
<b>HTML</b>	Hypertext Markup Language	Descriptive language for WWW (World Wide Web) pages
<b>HTTP</b>	Hypertext Transfer Protocol	Transmission protocol for Web pages on the Internet
<b>Hub</b>	—	Active network component with repeater functional scope, synonym for star coupler
<b>I</b>		
<b>ICMP</b>	Internet Control Message Protocol	Additional protocol on the Internet layer, alongside the Internet Protocol (IP); this is used to exchange error and information messages in IP, TCP, and UDP protocols. ICMP packets are always sent as IP datagrams. This serves to inform hosts of more favorable routes to a destination, provide information about routing problems, and break off connections due to problems in the data network. The ping and traceroute commands are based on ICMP. ICMP messages are divided into two classes: error messages and information messages.
<b>IE</b>	Industrial Ethernet	Cell network according to the international IEEE 802.3 (Ethernet) standard, designed for the industrial environment
<b>IEC</b>	International Electrotechnical Commission	Authority that oversees standardization in electrical engineering
<b>IEEE</b>	Institute of Electrical and Electronics Engineers	—
<b>IEEE 802</b>	Institute of Electrical and Electronics Engineers	LAN/WAN Standards Committee
<b>IEEE 802.11</b>	Institute of Electrical and Electronics Engineers	Standard for radio networks (originally in the 2.4 GHz band with transmission rates up to 2 Mbit/s)
<b>IEEE 802.11a</b>	Institute of Electrical and Electronics Engineers	Standard for radio networks in the 5 GHz range with data rates up to 54 Mbit/s.
<b>IEEE 802.11b</b>	Institute of Electrical and Electronics Engineers	Standard for radio networks in the 2.4 GHz range with data rates up to 11 Mbit/s.
<b>IEEE 802.11g</b>	Institute of Electrical and Electronics Engineers	Standard for radio networks in the 2.4 GHz range with data rates up to 54 Mbit/s. Backward compatible with IEEE 802.11b.
<b>IEEE 802.11i</b>	Institute of Electrical and Electronics Engineers	Expanded safety architecture for the 802.11 standard, valid for IEEE 802.11a/b/g; includes TKIP and AES
<b>IEEE 802.11n</b>	Institute of Electrical and Electronics Engineers	The IEEE 802.11n standard uses the MIMO (Multiple In, Multiple Out) technique for data transmission. The expansion of transmission channels from 20 MHz to 40 MHz and the use of three antennas increases the gross data rate to 450 Mbit/s.
<b>IEEE 802.3</b>	Institute of Electrical and Electronics Engineers	Ethernet working group
<b>IEEE 802.3af</b>	Institute of Electrical and Electronics Engineers	Standard that defines the transmission of power and data over one cable (see Power-over-Ethernet)
<b>IEEE 802.3u</b>	Institute of Electrical and Electronics Engineers	Fast Ethernet working group
<b>IGMP</b>	Internet Group Management Protocol	Protocol for load limiting when using multicast-based protocols, e.g. for video monitoring
<b>IM</b>	Interface modules	Interface
<b>INA</b>	Intel Network Architecture	—
<b>Intrinsically safe</b>	—	Ex protection measure according to DIN

## Appendix

### Abbreviations, Explanations

Term	Meaning	Explanation
<b>I</b>		
<b>I/O</b>	Input/Output	—
<b>IO Controller</b>	—	Controller for PROFINET IO in which the automation program executes
<b>IO Device</b>	—	Distributed field device that is assigned to an IO controller
<b>IO supervisor</b>	—	PG/PC with commissioning and diagnostics functions for PROFINET IO
<b>IP</b>	Internetwork Protocol	On its own, the IP protocol is without connections and invalid. The most important information is the unique IP address. The blocks of data are sent to the destination computer independently. IP does not negotiate anything with the destination computer. An end-to-end error check is not performed. Frames can arrive in a different order from the order they were sent in. TCP is responsible for rearranging them in the correct sequence.
<b>IP Alive</b>	—	Monitoring function for IP connections
<b>iPCF</b>	Industrial Point Co-ordination Function	Functional expansion of the IEEE 802.11 standard for applications with a requirement for real-time and deterministics (predictable response times). This facilitates rapid roaming of moving stations from one radio cell to the next and supports secure, wireless PROFINET IO communication with the SIMATIC Mobile Panel 277F IWLAN.
<b>iPCF-MC</b>	iPCF Management Channel	A further development of iPCF; this mode should be used if IWLAN stations that also support iPCF-MC move freely about in the coverage area (especially when using omni-directional antennas) and are to exchange data deterministically.
<b>IPX</b>	—	Protocols of ISO layers 1–4
<b>IP20</b>	—	Device protection class; protection against contact with the fingers and against penetration by solid foreign bodies with diameters in excess of 12 mm; no particular protection against water
<b>IP30</b>	—	Device protection class; protection against contact with tools, wires etc. with diameters in excess of 2.5 mm and against penetration by solid foreign bodies with diameters in excess of 2.5 mm; no particular protection against water
<b>IP65</b>	—	Device protection class; complete protection against contact and against ingress of dust; protection against splash water from all directions
<b>iREF</b>	Industrial Range Extension Function	With this function it is possible to cover a longer distance or a broader range with a single access point, which reduces the number of channels and access points that are used.
<b>IRT</b>	Isochronous real time	Deterministic and isochronous real-time communication for PROFINET for the particularly stringent demands, for example, of motion control applications. Clock rates of less than 1 ms can be achieved by using corresponding hardware.
<b>ISA</b>	Industry Standard Architecture	—
<b>ISDN</b>	Integrated Services Digital Network	Digital network that integrates services
<b>ISM-Band</b>	Industrial, Scientific and Medical-Band	Frequency band for license-free use
<b>ISO</b>	International Organization for Standardization	International Standards Organization
<b>ISP</b>	Internet Service Provider	Internet services provider
<b>IT</b>	Information Technology	Acquisition, conditioning, transmission, distribution, utilization and processing of information
<b>ITC</b>	Instrumentation Tray Cable	Approval for IE FC TP standard cable
<b>ITP (Category 5)</b>	Industrial Twisted Pair	Highly efficient, shielded, twisted pair cable for universal applications (international cabling standard ISO/IEC 11801 and EN 50173)
<b>IWLAN</b>	Industrial Wireless LAN	Industry standard WLAN conforming to IEEE 802.11 standard

## Abbreviations, Explanations

Term	Meaning	Explanation
<b>J</b>		
<b>JVM</b>	Java Virtual Machine	Java is a cross-platform, object-oriented programming language similar to C++. The Java Compiler, however, does not generate native machine code, but a byte code that has to be interpreted. This is done with the aid of the "Java Virtual Machine".
<b>K</b>		
<b>KNX</b>	Konnex (EN 50090, ANSI EIA 776)	Universal bus system for all house and building systems; KNX was developed by the Konnex Association based on EIB (European Installation Bus).
<b>L</b>		
<b>LAN</b>	Local Area Network	Local area network
<b>Layer 3 Routing</b>	—	Function for communication between various IP subnetworks on the basis of Layer 3. Also referred to as IP routing.
<b>LED</b>	Light Emitting Diode	Light emitting diode
<b>Link Aggregation</b>	—	Procedure for bundling several physical interfaces into one logical channel. Used for increasing the data throughput between two Ethernet switches. Implementations can also link servers and other systems by means of link aggregation.
<b>Link Check</b>	—	Cyclic monitoring of a radio link
<b>Link Class</b>	—	In the link class, the quality of a complete connection (link) is described, from the active component to the data terminal (patch cable, patch field, installation cable, connection socket, connecting cable). This link must comply with the values specified in the standard for structured cabling ISO/IEC 1180. Contrary to this is the specification according to "categories" where only product requirements are defined, e.g. category 5 cable.
<b>LLC</b>	Logical Link Control	Standardized network protocol
<b>LLDP</b>	Link Layer Discovery Protocol	This is a multi-vendor protocol for topology support on the link layer which enables a device connected to an Ethernet to advertise its identity and properties to other devices. This information is stored in the management information base (MIB) and collected using the simple network management protocol (SNMP).
<b>LLI</b>	Lower Layer Interface	Part of layer 7 with PROFIBUS, in which layer 7 services are mapped onto layer 2 services
<b>Load decoupling</b>	—	Due to filtering, a switch ensures that local data traffic remains local. Local network loading of a segment is decoupled from the remainder of the network.
<b>M</b>		
<b>MAC</b>	Media Access Control	Bus access control
<b>MAN</b>	Metropolitan Area Network	Data network with the geographical range of a town
<b>MAP</b>	Manufacturing Automation Protocol	International standard for automation protocols
<b>Media redundancy</b>	—	Redundancy in the network infrastructure (cable and active components such as OLM or OSM/ORM)
<b>MIB</b>	Management Information Base	A file for generating device profiles; it enables other SNMP-enabled devices, for example, to be integrated into the OPC configuration through loading of MIBs in accordance with the SMI V1 and SMI V2 standard from STEP 7 V5.4
<b>MIMO</b>	Multiple Input, Multiple Output	Multiple path propagation in accordance with the international standard IEEE 802.11n. This allows the devices to use several antennas in parallel in order to achieve a higher transmission rate and reduce susceptibility to faults in environments with a high number of reflections.
<b>MMS</b>	Manufacturing Message Specification	User interface of MAP
<b>Monoprotocol</b>	—	Data can only be transferred through one protocol
<b>MPI</b>	Multi Point Interface	Multipoint-capable interface for SIMATIC S7
<b>MRP</b>	Media Redundancy Protocol	The Medium Redundancy Protocol (MRP) is based on a ring topology and guarantees reconfiguration times of 200 ms

## Appendix

### Abbreviations, Explanations

Term	Meaning	Explanation
<b>M</b>		
<b>MRPD</b>	Media Redundancy for Planned Duplication	Standard for radio networks (originally in the 2.4 GHz band with transmission rates up to 2 Mbit/s)
<b>Multicast</b>	—	Multicast or Group calling in telecommunications signifies Message transmission from one point to a group (also termed Multipoint connection). The advantage of multicasting is that messages can be sent simultaneously to several stations or to a closed user group, without multiplying the bandwidth at the transmitting end by the number of recipients.
<b>Multiple path propagation</b>	—	Reflections of a radio wave off different objects in a room. This causes the radio wave to arrive at the receiver with variations of intensity and delay
<b>Multiplex function</b>	—	Multiplex function (with OP communication) increases the number of OPs that can be connected to a SIMATIC S7-300
<b>Multi-protocol</b>	—	Data can be transferred through one or two protocols
<b>N</b>		
<b>NAT</b>	Network Address Translation	Translation of private IP addresses into public addresses
<b>NC</b>	Numerical Control	Numerical control (machine tools)
<b>NCM</b>	Network and Communication Management	Tool for configuring communication connections, also a component of STEP 7
<b>NDIS</b>	Network Driver Interface Specification	Microsoft and 3Com interface
<b>NEC</b>	National Electrical Code	UL directive for the laying of cables in buildings
<b>NIC</b>	Network Interface Card	Line connection
<b>N-measurement</b>	—	Device installation measurement for subdivisions of the electrical installation
<b>NTP</b>	Network Time Protocol	Standardized protocol for synchronization of clocks in Computer systems over Communication networks
<b>O</b>		
<b>OFDM</b>	Orthogonal Frequency Division Multiplex	Modulation procedure for IEEE 802.11a/g
<b>OFN</b>	Optical Fiber Non-conductive	UL approval for fiber optic cables for use in buildings in accordance with Section 800-53(d) of NEC. Flames do not spread upward from cable out of the cable tray in the Vertical Tray Flame Test in UL 1685, "Vertical-Tray Fire-Propagation and Smoke Release Test for Electrical and Optical-Fiber Cables".
<b>OFNG</b>		UL Approval of a fiber optic cable for laying in cable harnesses (general purpose)
<b>OFNP</b>	Plenum cable (FOC)	UL Approval of a fiber optic cable for laying without additional protection in the space above dropped ceilings or below raised floors
<b>OFNR</b>	Riser cable (FOC)	UL Approval of a fiber optic cable for laying between the floors of a building
<b>OLE</b>	Object Linking and Embedding	Central architecture principle in Windows for the generation and editing of documents that contain objects generated by different applications
<b>OLM</b>	Optical link module	Network component for PROFIBUS
<b>Omnidirectional</b>	—	Antenna that radiates evenly through 360 degrees in both horizontal and vertical planes
<b>OP</b>	Operator Panel	—
<b>OPC</b>	Openness, Productivity, Collaboration	Standard interface for access to process data
<b>OPC DA</b>	OPC Data Access	Standard for Ethernet-based access to data of measurement and control devices, for the location of OPC servers and the simple browsing in the name spaces of the OPC servers on the basis on client/server communication
<b>OPC UA</b>	OPC Unified Architecture	OPC UA is the further development of the standard interface OPC and provides additional functions such as security and redundancy.
<b>OSPF</b>	Open Shortest Path First	Dynamic routing

## Abbreviations, Explanations

Term	Meaning	Explanation
<b>P</b>		
<b>PA</b>	Process Automation	Protocol profile, based on PROFIBUS DP with intrinsically safe transmission system to IEC 61158-2
<b>PAN</b>	Personal Area Network	Comparable with an ad-hoc network, for networking individual small devices a short distance from each other.
<b>PAP</b>	Password Authentication Protocol	Password authentication protocol
<b>PAT</b>	Port Address Translation	Translation of private ports into public addresses
<b>PCF</b>	Polymer clad fiber	Plastic-enclosed glass fiber
<b>PCI</b>	Peripheral Component Interconnect Express	Backplane bus in personal computers
<b>PCIe</b>	Peripheral Component Interconnect Express	Backplane bus in PC with, for example, a higher data transmission rate than the predecessor PCI
<b>PCMCIA</b>	Personal Computer, Memory Card, International Association	Standard for PC plug-in cards (credit card size). PCMCIA cards (Personal Computer Memory Card International Association) are used mainly input/output operations (e.g. modem) or memory expansions.
<b>PCS 7</b>	—	Siemens process control system
<b>PDU</b>	Protocol Data Unit	Protocol data unit
<b>PG</b>	Programming device	—
<b>PI</b>	Program instance	Communication object
<b>PLC</b>	Programmable logic controller	Device for open and closed loop control tasks
<b>PN</b>	PROFINET	Industrial Ethernet standard defined by the PNO
<b>PNO</b>	PROFIBUS Nutzerorganisation e.V.	Organization for PROFIBUS users and providers
<b>PoE</b>	Power over Ethernet	Transmission of power and data on a single cable
<b>POF</b>	Polymer optic fiber	Fiber optic cable made of light-conducting plastic
<b>Polling</b>	—	Addressed transmission call in centrally-oriented data networks polling mode. The poll is the command to a specific station to send messages. In this way the poll sequences control the data flow.
<b>POP</b>	Point of Presence	Dial-in node for an Internet service provider
<b>PP</b>	Push Button Panels	—
<b>PPM</b>	Parts per million	—
<b>PPTP</b>	Point-to-Point Tunneling Protocol	—
<b>Process or field communication</b>	—	Process or field communication is used for linking actuators/sensors to a CPU.
<b>PROFIBUS</b>	Process Field Bus	International fieldbus standard according to IEC 61158/61784
<b>PROFIBUS DP</b>	PROFIBUS DP for distributed I/O	Protocol profile according to IEC 61158/61784 for process or field communication for fast, cyclic data exchange with field devices
<b>PROFIBUS PA</b>	PROFIBUS for process automation	Protocol profile, based on PROFIBUS DP with intrinsically safe transmission system to IEC 61158-2.
<b>PROFIdrive</b>	—	PROFIBUS protocol profile, based on PROFIBUS DP, driven engineering profile (version 3, clock synchronization)
<b>PROFIenergy</b>	—	Protocol profile that provides functions and mechanisms for PROFINET field devices that support energy-efficient production
<b>Profile</b>	—	Definition of options and parameters as a supplement to the standard, e.g. PROFIBUS profiles
<b>PROFINET</b>	—	Industrial Ethernet standard defined by the PNO
<b>PROFINET device with proxy functionality</b>	—	A PROFINET device that takes on the role of the master with regard to PROFIBUS devices. This makes it possible to link PROFIBUS slaves into the PROFINET communication. If the device has a local (internal) PROFIBUS, it has the role of DP master with regard to the local DP slaves.

## Appendix

### Abbreviations, Explanations

Term	Meaning	Explanation
<b>P</b>		
<b>PROFIsafe</b>	—	Protocol profile in accordance with IEC 61508 that permits standard and safety-related communication on a bus. Communication between fail-safe controllers and fail-safe I/O is handled by PROFIsafe.
<b>Protocol</b>	—	Procedural regulation for data transmission. This regulation specifies both the message formats and the data flow during data transmission
<b>Proxy</b>	—	Representative object in the object model that maps the PROFINET view onto a field device or a group of field devices. The proxy on the PROFINET is the representative for one or more PROFIBUS devices
<b>PST</b>	Primary Setup Tool	Software tool for assigning IP addresses
<b>PUR</b>	Polyurethane	—
<b>R</b>		
<b>RADIUS</b>	Remote Authentication Dial-In User Service	Access control by means of servers
<b>RAM</b>	Random Access Memory	Random access memory
<b>Rapid Spanning Tree Protocol</b>	Configuration protocol specified in the IEEE-802.1w standard	The rapid spanning tree protocol is a further development of the spanning tree protocol (STP). It is used to avoid redundant network paths (loops) in the LAN, specifically when using switches; the reconfiguration time ranges from 2-3 seconds.
<b>RBC</b>	Remote Base Controller	—
<b>RegTP</b>	—	Regulation authority for telecommunications in Germany
<b>Remote diagnostics and remote maintenance (teleservice)</b>	—	Teleservice is data exchange with physically remote technical plants (machines, plants, computers, etc.) for the purpose of error detection, diagnostics, maintenance, repair, or optimization.
<b>Requirement specification</b>	Automation Protocol	Layers 5 through 7 of the ISO reference model
<b>RIPv1/2</b>	Routing Information Protocol	—
<b>RJ45</b>	Symmetrical connector for data cables	This is also known as a western connector or a western plug. This is a widely used plug connector in telephone and ISDN technology which is used in LAN installations in the office environment.
<b>RM</b>	Redundancy manager	Function for monitoring the network; the RM detects the failure of a transmission link in the ring or of a switch and activates the standby link
<b>RMON</b>	Remote Monitoring	Network administration function, e.g. collection of statistics information
<b>Roaming</b>	—	Free movement of wireless LAN stations across the cell boundaries of an access point. The station can switch from one radio cell to the next without any noticeable interruption
<b>R-SMA</b>	—	Reverse-SMA, connector for antennas in IWLAN
<b>RSTP</b>	Rapid Spanning Tree Protocol	The rapid spanning tree protocol is a further development of the spanning tree protocol (STP). The spanning tree protocol (STP) is used for avoiding redundant network paths (loops) in the LAN, specifically in switched environments; the reconfiguration time is in the range of 2-3 seconds.
<b>RT</b>	Real-time	Real-time communication in PROFINET
<b>S</b>		
<b>SA</b>	Source Address	Part of the IP header; contains the source address of the IP packet; 32 bits wide
<b>SAP</b>	Service Access Point	Service access point: an interface allowing the user to access services of the lower layer
<b>SC connection technology</b>	—	Standardized connection for glass fiber optic cables
<b>SC RJ connection technology</b>	—	Standardized connection for fiber optic conductors, e.g. for POF and PCF fiber optic cable

## Abbreviations, Explanations

Term	Meaning	Explanation
<b>S</b>		
<b>SCALANCE</b>	Scalable Performance	Name of the SIMATIC NET product generation for active Industrial Ethernet network infrastructure components
<b>SDA service</b>	Send Data with Acknowledge (open Layer 2 access)	Sending of acknowledged Layer 2 services
<b>SDN</b>	Send Data with No Acknowledge (open Layer 2 access)	Sending of unacknowledged Layer 2 services (broadcast, multicast)
<b>SFB</b>	System Function Block	A System Function Block (SFB) is a function block that is integrated in the S7 CPU. Because SFBs are part of the operating system, they are not loaded as part of the program. SFBs are blocks with a "memory". Instance data blocks must also be generated for SFBs and loaded as part of the program into the CPU
<b>SFC</b>	System function calls	Calls that are integrated into the operating system of the CPU, e.g. time functions or block transfer
<b>SFM</b>	System error signaling concept of SIMATIC	—
<b>SFP</b>	Small Form-factor Pluggable (coll. mini-GBIC)	Small standardized modules for network connections. SFPs are modular optical or electrical transceivers that are constructed as cable connectors in an SFP slot for extremely fast Ethernet. Network devices can therefore be easily changed to other media and the transceivers can be quickly replaced in the event of an error.
<b>Shared LAN</b>	—	All components in a shared LAN share the nominal data transmission rate. Shared LANs are constructed with repeaters/hubs.
<b>Signal delay</b>	—	Time that a data packet takes to travel through the network
<b>SINEMA Server</b>	SIMATIC Network Manager Engineering	Web-based network monitoring software
<b>Slot Time</b>	—	Time elapsing between transmission of a call and reception of an answer or acknowledgment
<b>SM</b>	Signal module	Input and output modules for SIMATIC
<b>SMTP</b>	Simple Mail Transfer Protocol	Transmission protocol for e-mail
<b>SNMP</b>	Simple Network Management Protocol	Standardized protocol for the transport of network management information
<b>SNTP</b>	Simple Network Time Protocol	Standardized protocol for synchronization of clocks in Computer systems over Communication networks
<b>Socket interface</b>	Standard communication for Industrial Ethernet	This facilitates data communication with computers through TCP/IP. On this interface, which is widespread in the PC and UNIX world, users can freely program their own protocols. The SEND/RECEIVE blocks are used as access to TCP/IP in SIMATIC S7.
<b>SOFTNET</b>	—	Software based on simple communications modules
<b>SP</b>	Service packs	Data that can easily be downloaded free of charge from the Internet.
<b>Spanning Tree Protocol</b>	Bridge configuration protocol specified in the IEEE-802.1d standard	The Spanning Tree Protocol is used to eliminate loops in any meshed networks. The reconfiguration time is in the region of 30 s.
<b>SPC</b>	Siemens PROFIBUS Controller	—
<b>SSID</b>	Service Set Identifier	Identification of a wireless network based on the IEEE 802.11 standard
<b>S/STP</b>	Screened Shielded Twisted Pair	In this cable construction the individual twisted pairs are wrapped in a foil shield. The two individually shielded pairs of conductors are then wrapped together in a braided copper shield.
<b>Standby function</b>	—	Function for redundant coupling network segments, such as for the coupling of redundant ring structures
<b>ST connector</b>	Straight-tip connector	Standardized connector for glass fiber-optic cables with bayonet lock (ST is a registered trademark of AT&T); see BFOC

## Appendix

### Abbreviations, Explanations

Term	Meaning	Explanation
<b>S</b>		
<b>STP</b>	Spanning Tree Protocol (IEEE 802.1d Standard)	The Spanning Tree Protocol is used to eliminate loops in any meshed networks. The reconfiguration time is in the region of 30 s.
<b>Switching</b>	—	Establishing several links between the ports simultaneously. These links are established dynamically and temporarily in accordance with the data traffic.
<b>SWR</b>	Standing Wave Ratio	Ratio between the energy radiated by an antenna and the energy that the antenna reflects to the radio module
<b>S<sub>0</sub> interface</b>	—	Basic interface for ISDN for connecting data terminals
<b>S7 routing</b>	—	PG/OP communication via different networks
<b>T</b>		
<b>TCP/IP</b>	Transport Control Protocol/Internet Protocol	De-facto standard; Protocol for worldwide communication with the Ethernet.
<b>Telecontrol</b>	—	The connection of distant process stations to one or more central control systems. Various different public or private networks can be used for communication for the purposes of monitoring and control. Event-driven or cyclic exchange of process data is performed with special telecontrol protocols and enables the operating personnel to manage the overall process effectively.
<b>Teleservice (remote diagnostics and remote maintenance)</b>	—	Teleservice is data exchange with physically remote technical plants (machines, plants, computers, etc.) for the purpose of error detection, diagnostics, maintenance, repair, or optimization.
<b>TD</b>	Text Display	—
<b>TF</b>	Technological functions	Application layer 7 for Industrial Ethernet (includes user services)
<b>TFTP</b>	Trivial File Transfer Protocol	Standard for data transmission
<b>Thin Client</b>	—	The principle of thin client/server computing is based on the fundamental physical separation of data.
<b>TIA</b>	Totally Integrated Automation	Fully integrated and company-wide system for automation from Siemens for company-wide configuration/programming, data management and communication.
<b>TKIP</b>	Temporal Key Integrity Protocol	Procedure for changing the keys in the WLAN
<b>Token</b>	—	The bit pattern with control function in token ring and token bus LANs; it is often the same as a send authorization
<b>Token Passing</b>	—	A collision-free access method, the send authorization (token) circulates between nodes which form a logical ring
<b>Topology</b>	Configuration of cables between the various nodes	The major forms of topology are: <ul style="list-style-type: none"> <li>• Linear</li> <li>• Tree</li> <li>• Ring</li> <li>• Star</li> </ul> Combinations of all basic types are possible.
<b>TP</b>	Touch panel	—
<b>TPC</b>	Transmission power control	Automatic regulation of the transmit power in the 5 GHz band
<b>Trap</b>	—	When specific events occur, such as link up or link down, alarms with corresponding error messages can be transmitted by network components on the Ethernet. In SNMP these alarms are called "traps".
<b>Triaxial cable</b>	—	The SIMATIC NET 727-0 bus cable is based on the coaxial cable specified in the 10Base5 standard (IEEE 802.3) – but strengthened with a thick aluminum outer sheath for industrial use.
<b>Twisted-pair</b>	Data cable with twisted pairs of conductors	The twist in the wire pairs provides good transmission properties and prevents electromagnetic interference. Twisted-pair cables are available in different qualities for different transfer rates



## Abbreviations, Explanations

Term	Meaning	Explanation
<b>U</b>		
<b>UDP</b>	User Datagram Protocol	Connectionless data transmission, i.e. datagram service that does not guarantee secure transmission. Users must take their own measures to ensure secure transmission. Data is transmitted as a data block. Transmission of data without RFC 1006 is thus possible.
<b>UL</b>	Underwriters Laboratories	Certification for the US market
<b>UMTS</b>	Universal Mobile Telecommunications System	Standard for third-generation (3G) mobile voice, audio, image, video, and data communication with a transmission rate of several Mbit/s
<b>USB</b>	Universal Serial Bus	Standard for the connection of I/O devices. USB (Universal Serial Bus) supports relatively high data transmission rates and can be used to connect several devices to a single computer.
<b>V</b>		
<b>Variable Services</b>	—	Application service group; it provides services for processing variables
<b>VLAN</b>	Local Area Network	Virtual LAN within a physical network. A widely used technical implementation of VLANs is partly defined in the IEEE 802.1Q standard.
<b>VNS</b>	Virtual Network Services	Centralized security mechanism for each user group that protects the data securely against unauthorized access and manipulation.
<b>VPN</b>	Virtual Private Network	Technology/network type for the secure transport of confidential data over potentially insecure IP networks, e.g. Internet
<b>VRRP</b>	Virtual Router Redundancy Protocol	Procedure for improving the availability of important gateways in local networks by means of redundant routers.
<b>W</b>		
<b>WAN</b>	Wide Area Network	Network that, in contrast to a LAN or MAN, can spread across countries or continents
<b>WDS</b>	Wireless Distribution System	Communication between two WLAN access points
<b>WECA</b>	Wireless Ethernet Compatibility Alliance	Alliance of wireless LAN product vendors who guarantee the compatibility of their products by means of testing.
<b>WEP</b>	Wired Equivalent Privacy	Encryption method for WLANs
<b>Wi-Fi seal</b>	Wireless Fidelity	Seal of the WECA identifying compatible and tested products .
<b>WinCC</b>	—	Open process visualization system for the operator control and process monitoring of SIMATIC HMI.
<b>WirelessHART</b>	—	Wireless HART communication to fieldbuses in the process industry. The HART Communication Foundation (HCF) specified WirelessHART and published it as a component of the HART Standard V7.1. The radio transmission is based on the wireless communications standard IEEE 802.15.4.
<b>Wireless LAN</b>	—	Wireless network
<b>Workflow</b>	—	Workflow systems are used when structuring and controlling workflows.
<b>WPA</b>	Wi-Fi Protected Access	Encryption mechanism in radio networks for protection against eavesdropping and unauthorized access
<b>WS</b>	Workstation	—
<b>WWW</b>	World Wide Web	Multimedia service on the Internet. Distributed hypertext information system on client/server architecture through HTTP protocol
<b>X</b>		
<b>XML</b>	Extensible Markup Language	Definition of a structured data description
<b>XMP</b>	X/Open Management Protocol	—
<b>XTI</b>	UNIX Transport Layer Interface	Layer 4 transport layer, standardized under UNIX
<b>X.25</b>	—	Interface between terminal and data transmission equipment for terminals which operate in packet mode in public data networks and are transported through dedicated lines

## Appendix

### Siemens Industry Training

#### Faster and more applicable know-how: Hands-on training from the manufacturer

Siemens Industry Training provides you with comprehensive support in solving your tasks.

Training by the market leader in the industry enables you to make independent decisions with confidence. Especially where the optimum and efficient use of products and plants are concerned. You can eliminate deficiencies in existing plants, and exclude expensive faulty planning right from the beginning.



First-class know-how directly pays for itself: In shorter startup times, high-quality end products, faster troubleshooting and reduced downtimes. In other words, increased profits and lower costs.

#### Achieve more with Siemens Industry Training

- Shorter times for startup, maintenance and servicing
- Optimized production operations
- Reliable configuration and startup
- Minimization of plant downtimes
- Flexible plant adaptation to market requirements
- Compliance with quality standards in production
- Increased employee satisfaction and motivation
- Shorter familiarization times following changes in technology and staff

#### Contact

Visit our site on the Internet at:

[www.siemens.com/sitrain](http://www.siemens.com/sitrain)

or let us advise you personally.

#### Siemens Industry Training Customer Support Germany:

Phone: +49 911 895-7575

Fax: +49 911 895-7576

E-Mail: [info@sitrain.com](mailto:info@sitrain.com)

#### Highlights Siemens Industry Training

##### Top trainers

Our trainers are skilled teachers with direct practical experience. Course developers have close contact with product development, and directly pass on their knowledge to the trainers.

##### Practical experience

The practical experience of our trainers enables them to teach theory effectively. But since theory can be pretty drab, we attach great importance to practical exercises which can comprise up to half of the course time. You can therefore immediately implement your new knowledge in practice. We train you on state-of-the-art methodically/didactically designed training equipment. This training approach will give you all the confidence you need.

##### Wide variety

With a total of about 300 local attendance courses, we train the complete range of Siemens Industry products as well as interaction of the products in systems.

##### Tailor-made training

We are only a short distance away. You can find us at more than 50 locations in Germany, and in 62 countries worldwide. You wish to have individual training instead of one of our 300 courses? Our solution: We will provide a program tailored exactly to your personal requirements. Training can be carried out in our Training Centers or at your company.

##### The right mixture: Blended learning

"Blended learning" is a combination of various training media and sequences. For example, a local attendance course in a Training Center can be optimally supplemented by a teach-yourself program as preparation or follow-up. Additional effect: Reduced traveling costs and periods of absence.



### Training program for SIMATIC NET

The SIMATIC NET trainings provide your employees the necessary overview and detailed skills for industrial communication. In addition to planning and configuration with SIMATIC NET, the use, programming, commissioning and servicing of the products are included in the training.

More information on course contents, dates and prices is available on the Internet at:

[www.siemens.com/sitrain](http://www.siemens.com/sitrain)

Title	Target group	Duration	Short title
	Commissioning engineers, configuration engineers		
	Programmers		Service personnel
	Project managers, project team members		Operators, users
	Decision makers, sales personnel		Maintenance personnel

### SIMATIC NET Industrial Communication

Industrial Ethernet									
Industrial Ethernet System Course			✓	✓	✓	✓	✓	3 days	IK-IESYS
Security in Industrial Ethernet Networks	✓	✓						2 days	IK-IESECWS
Industrial Ethernet by Siemens			✓	✓	✓		✓	WBT	WT-IESI
PROFINET									
PROFINET System Course			✓	✓	✓	✓	✓	3 days	IK-PNSYS
Certified PROFINET Network Installer			✓	✓	✓		✓	2 days	IK-PNOCPNI
Certified PROFINET Network Engineer			✓	✓	✓		✓	2 days	IK-PNOCPNE
PROFINET			✓	✓	✓		✓	WBT	WT-PROFIN
Industrial Wireless Communication									
Industrial Wireless LAN System Course			✓	✓	✓		✓	2 days	IK-IWLANSYS
PROFIBUS									
PROFIBUS System Course			✓	✓	✓		✓	3 days	IK-PBSYS
PROFIBUS			✓	✓	✓	✓	✓	WBT	WT-PROFI
AS-Interface									
Actuator Sensor-Interface System Course	✓	✓	✓	✓	✓		✓	3 days	IK-ASISYS
SINAUT ST7									
Engineering SINAUT ST7			✓	✓	✓		✓	5 days	IK-SINAUT

## Appendix

### Standards and approbations

#### CE marking

##### Overview

In as far as the electronic products described in this Catalog are subject to requirements and protection goals stipulated in EG guidelines, the relevant EG conformity declarations for the competent authorities are held available at:

##### **SIMATIC:**

Siemens AG  
Industry Sector  
IA AS EWA  
Postfach 1963  
D-92209 Amberg  
GERMANY

##### **SIMATIC NET:**

SIEMENS AG  
Industry Sector  
IA SC CI  
Postfach 4848  
D-90327 Nürnberg  
GERMANY

##### **SIMATIC HMI:**

SIEMENS AG  
Industry Sector  
IA AS SM ID  
Postfach 4848  
D-90327 Nürnberg  
GERMANY

SIMATIC NET products are designed for operation in industrial environments:

Noise emissions:  
EN 61000-6-4: 2007 + A1:2011  
Noise immunity:  
EN 61000-6-2: 2005

Selected modules comply with stringent requirements with regard to emitted interference and are therefore allowed to be used in an industrial as well as in a domestic environment:

Noise emissions:  
EN 61000-6-3: 2007 + A1:2011  
Noise immunity:  
EN 61000-6-2: 2005

Please take details regarding the fulfillment of specific European standards (EN) from the technical documents (manuals) associated with the product. Prerequisite for the fulfillment of the aforementioned protection goals is strict observance of the installation guidelines described in the manuals during the installation and operation of the products.

The installation guidelines described in the manuals and the important notes concerning installation in cabinets and the use of shielded cables must be complied with when installing and operating the products described in this catalog.

##### Notes for machine manufacturers

The SIMATIC automation system is not a machine in the sense of the EC Machinery Directive. For SIMATIC therefore no Declaration of Conformity in terms of the EC Machinery – Directive 89/392/EEC or 2006/42/EC (new edition, applicable from end of 2009) may be issued.

The EC Machinery Directive regulates the requirements for a machine or sub-unit of a machine. Machine in this context is defined as an entity of connected parts or devices (see also EN 292-1, Para. 3.1).

SIMATIC is part of the electrical equipment of a machine and must therefore be included in the assessment of the machine as a whole.

As an electrical resource, SIMATIC is subject to the low-voltage directive that, like the machine directive, also covers all hazards as a "total safety directive".

The EN 60204-1 standard (Safety of machines, general requirements – for the electrical equipment of machines) applies for the electrical equipment of machines.

The following table should help you when drawing up your declaration of conformity and shows which criteria apply to SIMATIC in accordance with EN 60204-1:2006/A1:2009.

You can obtain – further information from the enclosed declaration of conformity in accordance with the low-voltage and EMC directive (with the list of standards complied with).

EN 60204-1	Topic/criterion	Notes
Paragraph 4	General requirements	The requirements are met when the equipment is assembled/ installed in accordance with the installation guidelines. Please note the relevant information in the manuals
Paragraph 11.2	Digital input/output interfaces	The requirements are met
Paragraph 12.3	Programmable equipment	The requirements are met when the equipment is installed in lockable cabinets to protect against alteration of the memory contents by unauthorized persons.
Paragraph 20.4	Voltage tests	The requirements are met

#### Certificates, authorizations, approbations, declarations of conformity

An overview of the certificates available for SIMATIC NET products (CE, UL, CSA, FM, shipping authorizations) and classification figures (MTBF) can be found in the Internet at:

[www.siemens.com/simatic-net](http://www.siemens.com/simatic-net)



Other certificates for SIMATIC products can be found in the Internet at:

SIMATIC

[www.siemens.com/simatic/certificates](http://www.siemens.com/simatic/certificates)

Industrial Controls

<http://www.siemens.com/industrial-controls/support>

The lists are continuously updated. The data for products which has not yet been included in the overview is continuously collected and prepared for the subsequent edition.

You can find certificates, approbations, verification certificates or characteristic curves under:  
Support\Infomaterial\Certificates

#### Quality management

The quality management system of the Industry Sector, Industry Automation division, complies with the international standard EN ISO 9001.

The products and systems described in this catalog are sold under application of a quality management system certified by DQS and TÜV (German Technical Inspectorate) in accordance with ISO 9001.

The certificates are recognized in all EQ Net countries.

#### DQS Registered Certificate Nos.:

Siemens AG  
Industry Sector  
Industrial Automation

- Industrial Automation Systems  
Reg.-No.: 001323 QM08
- Sensors and Communication  
Reg.-No.: 000656 QM08
- Control Components and Systems Engineering  
Reg.-No.: 001108 QM08

#### Drive Technologies

Motion Control Systems  
Reg.-No.: 001258 QM08

## Appendix

### Partner at Industry

#### Overview



At Siemens Industry we are resolutely pursuing the same goal: long-term improvement of your competitive ability. We are committed to this goal. Thanks to our commitment, we continue to set new standards in automation and drive technology. In all industries – worldwide.

At your service locally, around the globe for consulting, sales, training, service, support, spare parts ... on the entire Industry Automation and Drive Technologies range.

Your personal contact can be found in our Contacts Database at: [www.siemens.com/automation/partner](http://www.siemens.com/automation/partner)

You start by selecting a

- Product group,
- Country,
- City,
- Service.

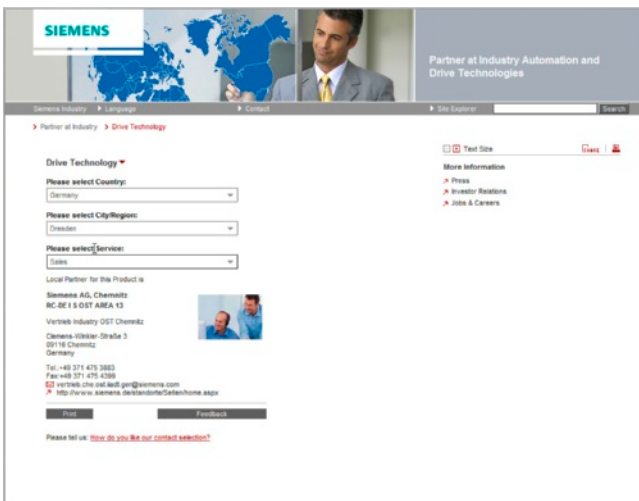
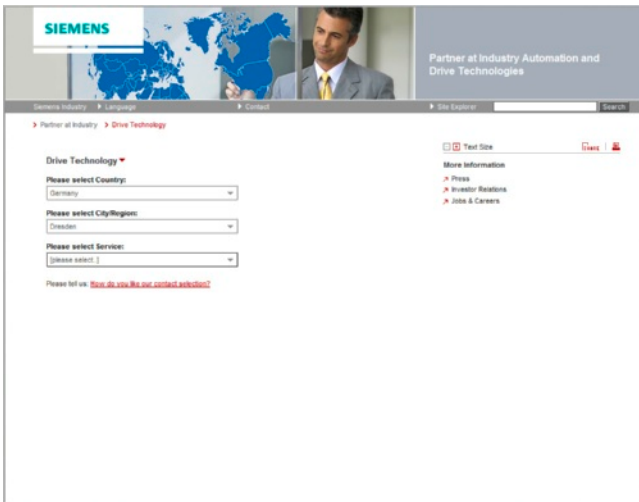

## Overview

## Siemens Solution Partner Automation Drives

Solution Partner: Highest quality - guaranteed

The products and systems from Siemens Industry Automation and Drive Technologies offer the ideal platform for all automation applications.

Under the name of Siemens Solution Partner Automation Drives, selected system integrators around the world act as uniformly qualified solution providers for the Siemens range of products and services in the fields of automation and drives. Day after day, they utilize their qualified product and system know-how as well as their excellent industry expertise to your advantage – for all requirements.

The partner emblem is the guarantee and indicator of proven quality. The basis for this are defined quality features that identify Solution Partners as reliable and competent solution providers:

- Solution quality  
Always a good result with tried and tested solutions expertise.
- Expert quality  
Certified technical competence ensures maximum efficiency.
- Project quality  
With proven project experience straight to the target.
- Portfolio quality  
Comprehensive portfolio for state-of-the-art solutions from a single source.

## Solution Partner Finder

 The screenshot shows the Siemens Solution Partner Finder website. At the top, there is a banner image of two hands shaking in a firm grip, with the Siemens logo on the left and the text 'Partner Finder' on the right. Below the banner, there are navigation links for 'Partner Finder', 'Language', and 'Contact'. The main content area is titled 'Partner Finder' and contains introductory text: 'You are looking for a qualified partner for your specific tasks? The Partner Finder will guide you quickly and reliably to the ideal partner.' It then asks two questions: 'What is more important to you, the ability to deliver or the reliable delivery of products? Do you need special modifications or certain services?' and 'Are you looking for a partner who is a specialist in providing solutions and with excellent know-ledge of the industry, one who implements tailored and future-proof automation and drive solutions?'. Below these questions are two radio buttons: 'Approved Partner' and 'Solution Partner', with 'Solution Partner' selected. There are also links for 'Partner search: Find your ideal partner', 'Reference search: Check out the solution expertise yourself', and 'Industry events: Information about events'. At the bottom, there is a search form with tabs for 'Partner search', 'Reference search', and 'Industry events'. The search form includes dropdown menus for Technology, Industry, Service, Country, and Region/State, a search word input field, and a Zip code input field. A 'Find' button is located at the bottom right of the search form. A note on the right side of the search form states: 'Note: Please note that the search criteria entered are linked with and.'

The Siemens Solution Partner Program helps you to find the optimum partner for your specific requirements.

Support is provided by the Solution Partner Finder, a comprehensive online platform that showcases the profiles of all our solution partners. You can convince yourself of the competence of the respective Solution Partner by means of the references provided. Various search criteria are available for this purpose.

Once you have located a partner, you are only one small step away from contacting them.

Find the right partner here for your specific task and convince yourself of the solution competence provided:

[www.siemens.com/automation/partnerfinder](http://www.siemens.com/automation/partnerfinder)

Additional information on the Siemens Solution Partner Program is available online at:

[www.siemens.com/solutionpartner](http://www.siemens.com/solutionpartner)

## Appendix

### Siemens Automation Cooperates with Education

#### Applicable practical know-how

#### Comprehensive teaching support for educational institutions

Cooperates  
with Education

Automation

SIEMENS

#### Siemens Automation Cooperates with Education (SCE)

offers a global system for sustained support of technical skills. SCE supports educational institutions in their teaching assignment in the industrial automation sector and offers added value in the form of partnerships, technical expertise, and know-how. As the technological leader, our comprehensive range of services can support you in the knowledge transfer for Industry 4.0.

#### Our services at a glance

- Training curriculums for your lessons
- Trainer packages for hands-on learning
- Courses convey up-to-date, specialist knowledge
- Support for your projects/textbooks
- Complete didactic solutions from our partners
- Personal contact for individual support

#### Training curriculums for your lessons



Use our profound industrial know-how for practice-oriented and individual design of your course. We offer you more than 100 didactically prepared training curriculums on the topics of automation and drives technology free of charge. These materials are perfectly matched to your curricula and syllabuses, and optimally suited for use with our trainer packages. This takes into account all aspects of a modern industrial solution: installation, configuration, programming, and commissioning. All documents, including projects, can be individually matched to your specific requirements.

Particular highlights:

- With the new SIMATIC PCS 7 curriculums and trainer packages, you can pass on basic, practice-oriented PCS 7 knowledge at universities within about 60 hours (= 1 semester), using plant simulation.

- The new TIA Portal training materials for SIMATIC S7-1200 are available in English, German, French, Italian, Spanish and Chinese for download.

[www.siemens.com/sce/documents](http://www.siemens.com/sce/documents)

#### Trainer packages for hands-on learning



Our SCE trainer packages offer a specific combination of original industrial packages which are perfectly matched to your requirements and can be conveniently used in your course. These price reduced bundles available exclusively to schools include innovative and flexible hardware and software packages. SCE can currently offer more than 90 SCE trainer packages including related equipment. These cover both the factory and process automation sectors. You can use them to impart the complete course contents on industrial automation at a very low cost.

Trainer packages are available for:

- Introduction to automation technology with LOGO! logic module and SIMATIC S7-1200 compact controller
- PLC engineering with SIMATIC S7 hardware and STEP 7 software (S7-300, S7-1500 and TIA Portal)
- Operator control and monitoring with SIMATIC HMI
- Industrial networking over bus systems with SIMATIC NET (PROFINET, PROFIBUS, IO-Link)
- Sensor systems with VISION, RFID and SIWAREX
- Process automation with SIMATIC PCS 7
- Power Monitoring Devices SENTRON PAC 4200
- Motor Management SIMOCODE
- Networked drive and motion technologies with SINAMICS/SIMOTION
- CNC programming with SinuTrain

#### Important ordering notes:

Only the following institutions are authorized to obtain trainer packages: vocational schools, Colleges and Universities, in-house vocational training departments, non commercial research institutions and non commercial training departments.

To purchase a trainer package, you require a specific end-use certificate, which you can obtain from your regional sales office.

[www.siemens.com/sce/tp](http://www.siemens.com/sce/tp)



**Comprehensive teaching support for educational institutions** (continued)**Courses convey up-to-date specialist knowledge**

Profit from our excellent know-how as the leader in industrial technologies. We offer you specific courses for automation and drive technology worldwide. These support you in the practice-oriented transferring of product and system know-how, are in conformance with curriculums, and derived from the training fields. Compact technical courses especially for use at universities are also available.

Our range of courses comprises a wide variety of training modules based on the principle of Totally Integrated Automation (TIA). The focus is on the same subject areas as with the SCE trainer packages.

Every PLC and drive course is oriented on state-of-the-art technology. Your graduates can thus be prepared optimally for their future professional life.

In some countries we are offering classes based on our training curriculums. Please inquire with your SCE contact partner.

[www.siemens.com/sce/contact](http://www.siemens.com/sce/contact)

**Support for your projects/textbooks**

Automation and drive technology is characterized by continuous and rapid developments. Service and Support therefore play an important role.

We can provide you with consulting for selected projects and support from your personal SCE contact as well as our web based and regional Customer Support.

As a particular service, SCE supports technical authors with our know-how as well as with intensive technical consulting. Siemens library of special textbooks covering the industrial automation sector provides an additional resource for you and your students. These can be found at the SCE web site.

[www.siemens.com/sce/contact](http://www.siemens.com/sce/contact)  
[www.siemens.com/sce/books](http://www.siemens.com/sce/books)

**Complete didactic solutions**

Our partners for learning systems offer a wide range of training systems and solutions for use in your courses or laboratory.

These models have been designed based on our trainer packages and thus save you the time and cost of self-construction of individual components. The Partner systems provide you with simple and effective help in the fulfillment of your teaching assignment.

[www.siemens.com/sce/partner](http://www.siemens.com/sce/partner)

**Contact for individual support**

You can find your personal SCE contact on our Internet site. Your local SCE Promoter will answer all your questions concerning the complete SCE offering, and provide you with timely and competent information about innovations. When you encounter challenges, you can profit from our global team of excellence.

If a direct SCE contact is not listed for your country, please contact your local Siemens office.

[www.siemens.com/sce/contact](http://www.siemens.com/sce/contact)

**SCE Support Finder for your Internet request**

You are an educator and need support on the topic of industry automation? Send us your request:

[www.siemens.com/sce/supportfinder](http://www.siemens.com/sce/supportfinder)

Scan the QR  
code for further  
information  
(SCE homepage)



## Appendix

### Online Services

#### Information and Ordering in the Internet and on DVD

##### Siemens Industry Automation and Drive Technologies in the WWW

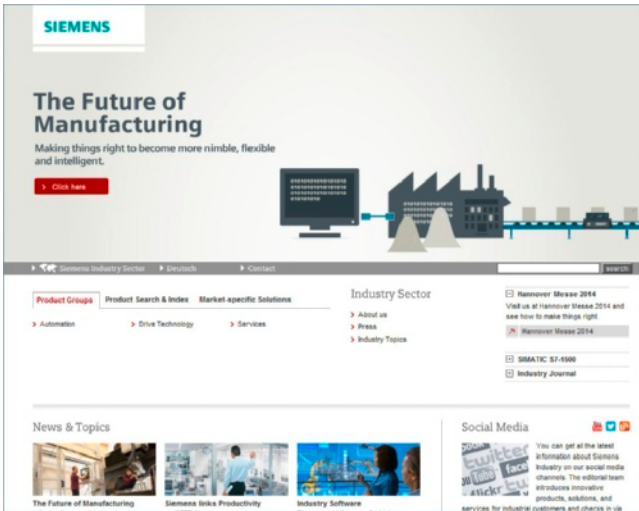

A detailed knowledge of the range of products and services available is essential when planning and configuring automation systems. It goes without saying that this information must always be fully up-to-date.

Siemens Industry Automation and Drive Technologies has therefore built up a comprehensive range of information in the World Wide Web, which offers quick and easy access to all data required.

Under the address

[www.siemens.com/industry](http://www.siemens.com/industry)

you will find everything you need to know about products, systems and services.

##### Product Selection Using the Interactive Catalog CA 01 of Industry



Detailed information together with convenient interactive functions:

The interactive catalog CA 01 covers more than 80 000 products and thus provides a full summary of the Siemens Industry Automation and Drive Technologies product base.

Here you will find everything that you need to solve tasks in the fields of automation, switchgear, installation and drives. All information is linked into a user interface which is easy to work with and intuitive.

After selecting the product of your choice you can order at the press of a button, by fax or by online link.

Information on the interactive catalog CA 01 can be found in the Internet under

[www.siemens.com/automation/ca01](http://www.siemens.com/automation/ca01)

or on DVD.

##### Easy Shopping with the Industry Mall

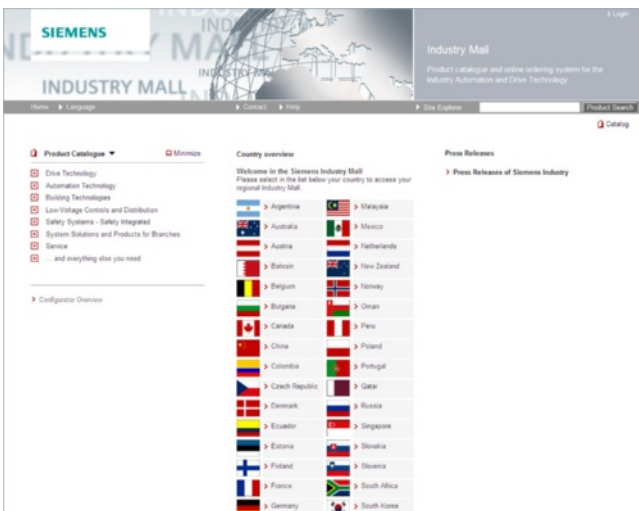

The Industry Mall is the electronic ordering platform of Siemens AG on the Internet. Here you have online access to a huge range of products presented in an informative and attractive way.

Data transfer via EDIFACT allows the whole procedure from selection through ordering to tracking and tracing of the order to be carried out. Availability checks, customer-specific discounts and preparation of quotes are also possible.

Numerous additional functions are available to support you.

For example, powerful search functions make it easy to select the required products. Configurators enable you to configure complex product and system components quickly and easily. CAx data types are also provided here.

Please visit the Industry Mall on the Internet under:

[www.siemens.com/industrymall](http://www.siemens.com/industrymall)

#### Downloading Catalogs

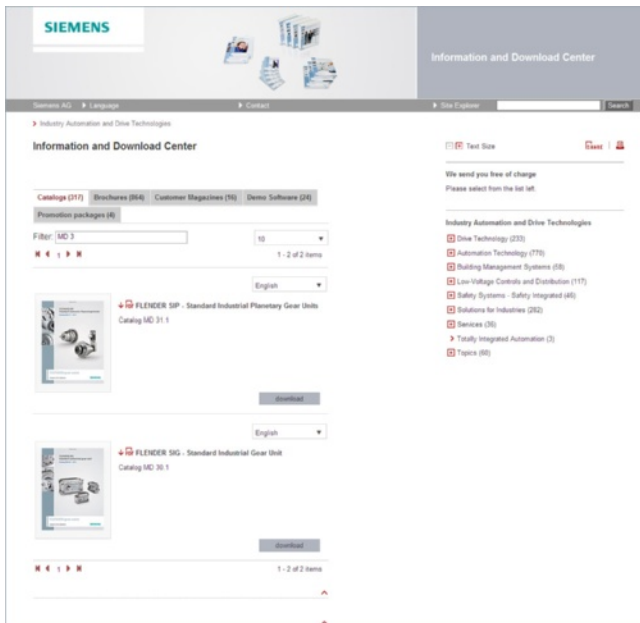

In addition to numerous other useful documents, you can also find the catalogs listed on the back inside cover of this catalog in the Information and Download Center. Without having to register, you can download these catalogs in PDF format or increasingly as digital page-turning e-books.

The filter dialog box above the first catalog displayed makes it possible to carry out targeted searches. If you enter "MD 3" for example, you will find both the MD 30.1 and MD 31.1 catalogs. If you enter "ST 70" both the ST 70 catalog and the associated news or add-ons are displayed.

Visit us on the web at:

[www.siemens.com/industry/infocenter](http://www.siemens.com/industry/infocenter)

#### Social Media

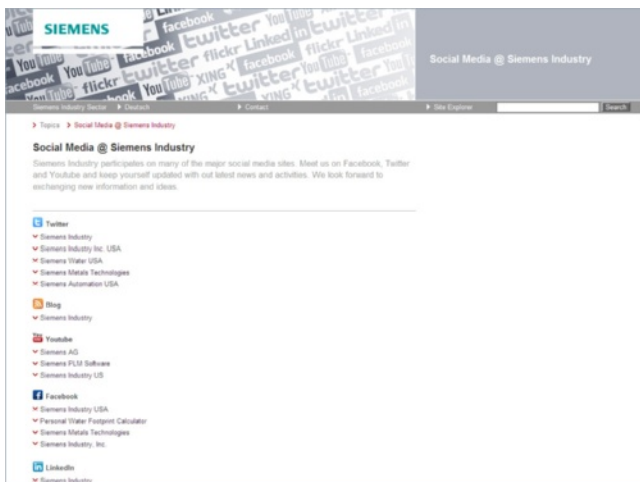

Connect with Siemens through social media: visit our social networking sites for a wealth of useful information, demos on products and services, the opportunity to provide feedback, to exchange information and ideas with customers and other Siemens employees, and much, much more. Stay in the know and follow us on the ever-expanding global network of social media.

Connect with Siemens Industry at our central access point:

[www.siemens.com/industry/socialmedia](http://www.siemens.com/industry/socialmedia)

Or via our product pages at:

[www.siemens.com/automation](http://www.siemens.com/automation)

or

[www.siemens.com/drives](http://www.siemens.com/drives)

To find out more about Siemens' current social media activities visit us at:

[www.siemens.com/socialmedia](http://www.siemens.com/socialmedia)

#### Mobile Media

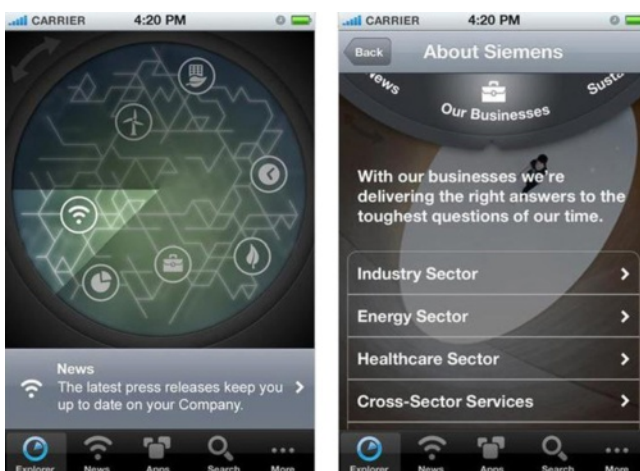

Discover the world of Siemens.

We are also constantly expanding our offering of cross-platform apps for smartphones and tablets. You will find the current Siemens apps at the app store (iOS) or at Google Play (Android).

The Siemens app, for example, tells you all about the history, latest developments and future plans of the company – with informative pictures, fascinating reports and the most recent press releases.

## Appendix Industry Services

Your machines and plant can do more – with Industry Services.



Whether it is production or process industry - in view of rising cost pressure, growing energy costs, and increasingly stringent environmental regulations, services for industry are a crucial competitive factor in manufacturing as well as in process industries.

All over the world Siemens supports its customers with product, system, and application-related services throughout the entire life cycle of a plant. Right from the earliest stages of planning, engineering, and building, all the way to operation and modernization. These services enable customers to benefit from the Siemens experts' unique technological and product knowledge and industry expertise.

Thus downtimes are reduced and the utilization of resources is optimized. The bottom line: increased plant productivity, flexibility, and efficiency, plus reduced overall costs.

Discover all advantages of our service portfolio:  
[www.siemens.com/industry-services](http://www.siemens.com/industry-services)

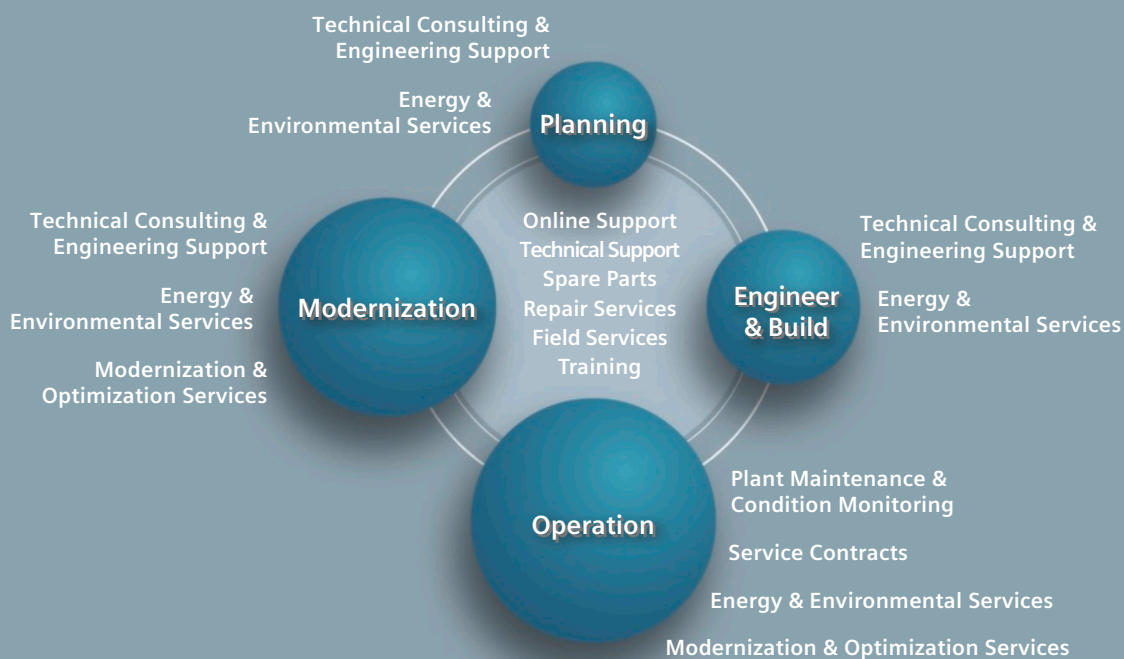

G\_DA65\_EN\_00270

Siemens supports its clients with technology based Services across a plants entire life cycle.

#### Online Support

Online support is a comprehensive information system for all questions relating to products, systems, and solutions that Siemens has developed for industry over time. With more than 300,000 documents, examples and tools, it offers users of automation and drive technology a way to quickly find up-to-date information. The 24-hour service enables direct, central access to detailed product information as well as numerous solution examples for programming, configuration and application.

The content, in six languages, is increasingly multimediated – and now also available as a mobile app. Online support's "Technical Forum" offers users the opportunity to share information with each other. The "Support Request" option can be used to contact Siemens' technical support experts. The latest content, software updates, and news via newsletters and Twitter ensure that industry users are always up to date.



[www.siemens.com/industry/onlinesupport](http://www.siemens.com/industry/onlinesupport)

#### Online Support App



Using the Online Support app, you can access over 300,000 documents covering all Siemens industrial products - anywhere, any time. Regardless of whether you need help implementing your project, fault-finding, expanding your system or are planning a new machine.

You have access to FAQs, manuals, certificates, characteristics curves, application examples, product notices (e.g. announcements of new products) and information on successor products in the event that a product is discontinued.

Just scan the product code printed on the product directly using the camera of your mobile device to immediately see all technical information available on this product at a glance. The graphical CAx information (3D model, circuit diagrams or EPLAN macros) is also displayed. You can forward this information to your workplace using the e-mail function.

The search function retrieves product information and articles and supports you with a personalized suggestion list. You can find your favorite pages – articles you need frequently – under "mySupport". You also receive selected news on new functions, important articles or events in the News section.

Scan the QR code for information on our Online Support app.



The app is available free of charge from the Apple App Store (iOS) or from Google Play (Android).

[www.siemens.com/industry/onlinesupportapp](http://www.siemens.com/industry/onlinesupportapp)

#### Technical Support

The ability to quickly analyze system and error messages and take appropriate action are key factors in ensuring that plants run safely and efficiently. Questions can arise at any time and in any industry, whether it's an individual product or a complete automation solution. Siemens technical support offers individual technical assistance in matters related to functionality, how to operate, applications, and fault clearance in industrial products and systems – at any time and globally, over the phone, by e-mail, or via remote access. Experienced experts from Siemens answer incoming questions promptly. Depending on the requirements, they first consult specialists in the areas of development, on-site services, and sales. Technical support is also available for discontinued products that are no longer available. Using the support request number, any inquiry can be clearly identified and systematically tracked.

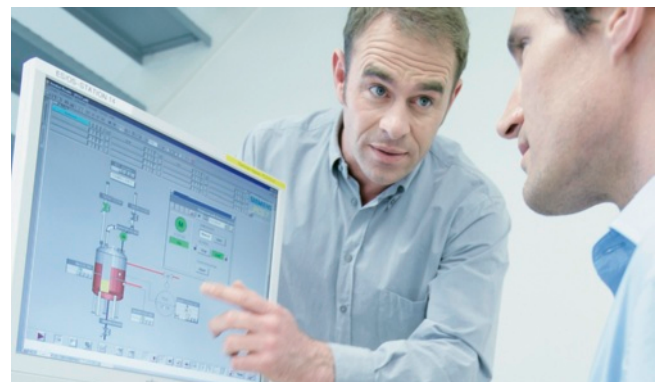

## Appendix

### Industry Services

#### Industry Services for the entire life cycle

##### **Spare Parts**

Drive and automation systems must be available at all times. Even a single missing spare part can bring the entire plant to a standstill – and result in substantial financial losses for the operator. The spare parts services from Siemens protects against such losses – with the aid of quickly available, original spare parts that ensure smooth interaction with all other system components. Spare parts are kept on hand for up to ten years; defective parts can be returned. For many products and solutions, individual spare parts packages ensure a preventive stock of spare parts on-site. The spare parts services is available around the world and around the clock. Optimum supply chain logistics ensure that replacement components reach their destination as quickly as possible. Siemens' logistics experts take care of planning and management as well as procurement, transportation, customs handling, warehousing, and complete order management for spare parts.



##### **Repair Services**

Reliable electrical and electronic equipment is crucial for operating continuous processes. That is why it is essential that motors and converters always undergo highly specialized repair and maintenance. Siemens offers complete customer and repair services – on site and in repair centers – as well as technical emergency services worldwide. The repair services include all measures necessary to quickly restore the functionality of defective units. In addition, services such as spare parts logistics, spare parts storage and rapid manufacturing are available to plant operators in all verticals. With a global network of certified repair shops operated by Siemens as well as third parties, Siemens handles the maintenance and overhaul of motors, converters, and other devices as an authorized service partner.



##### **Field Services**

It's a top priority in all industries: the availability of plants and equipment. Siemens offers specialized maintenance services such as inspection and upkeep as well as rapid fault clearance in industrial plants – worldwide, continuously, and even with emergency services as needed. The services include startup as well as maintenance and fault clearance during operation. The startup service includes checking the installation, function tests, parameterization, integration tests for machines and plants, trial operation, final acceptance, and employee training. All services, including remote maintenance of drives, are also available as elements of customized service contracts.



#### **Training**

Increasingly, up-to-date knowledge is becoming a determining factor in success. One of the key resources of any company is well-trained staff that can make the right decision at the right moment and take full advantage of the potential. With SITRAIN – Training for Industry, Siemens offers comprehensive advanced training programs. The technical training courses convey expertise and practical knowledge directly from the manufacturer. SITRAIN covers Siemens' entire product and system portfolio in the field of automation and drives. Together with the customer, Siemens determines the company's individual training needs and then develops an advanced training program tailored to the desired requirements. Additional services guarantee that the knowledge of all Siemens partners and their employees is always up-to-date.



#### **Technical Consulting & Engineering Support**

The efficiency of plants and processes leads to sustainable economic success. Individual services from Siemens help save substantial time and money while also guaranteeing maximum safety. Technical consulting covers the selection of products and systems for efficient industrial plants. The services include planning, consulting, and conceptual design as well as product training, application support, and configuration verification – in all phases of a plant's lifecycle and in all questions related to product safety. Engineering support offers competent assistance throughout the entire project, from developing a precise structure for startup to product-specific preparation for implementation as well as support services in areas such as prototype development, testing and acceptance.



#### **Energy & Environmental Services**

Efficient energy use and resource conservation – these top sustainability concerns pay off – both for the environment and for companies. Siemens offers integrated solutions that unlock all technical and organizational potential for successful environmental management. Customized consulting services are aimed at sustainably lowering the cost of energy and environmental protection and thus increasing plant efficiency and availability. The experts provide support in the conceptual design and implementation of systematic solutions in energy and environmental management, enabling maximum energy efficiency and optimized water consumption throughout the entire company. Improved data transparency makes it possible to identify savings potential, reduce emissions, optimize production processes, and thereby noticeably cut costs.



## Appendix

### Industry Services

#### Industry Services for the entire life cycle

##### **Modernization & Optimization Services**

High machine availability, expanded functionality and selective energy savings – in all industries, these are decisive factors for increasing productivity and lowering costs. Whether a company wants to modernize individual machines, optimize drive systems, or upgrade entire plants, Siemens' experts support the projects from planning to commissioning.

Expert consulting and project management with solution responsibility lead to security and make it possible to specifically identify savings potential in production. This secures investments over the long term and increases economic efficiency in operation.



##### **Plant Maintenance & Condition Monitoring**

Modern industrial plants are complex and highly automated. They must operate efficiently in order to ensure the company's competitive strength. In addition, the steadily increasing networking of machines and plants require consistent security concepts. Maintenance and status monitoring as well as the implementation of integrated security concepts by Siemens' experts support optimum plant use and avoid downtime. The services include maintenance management as well as consulting on maintenance concepts, including the complete handling and execution of the necessary measures. Complete solutions also cover remote services, including analysis, remote diagnosis, and remote monitoring. These are based on the Siemens Remote Services platform with certified IT security.



##### **Service Contracts**

Making maintenance costs calculable, reducing interfaces, speeding up response times, and unburdening the company's resources – the reduced downtimes that these measures achieve increase the productivity of a plant. Service contracts from Siemens make maintenance and repairs more cost-effective and efficient. The service packages include local and remote maintenance for a system or product group in automation and drive technology. Whether you need extended service periods, defined response times, or special maintenance intervals, the services are compiled individually and according to need. They can be adjusted flexibly at any time and used independently of each other. The expertise of Siemens' specialists and the capabilities of remote maintenance thus ensure reliable and fast maintenance processes throughout a plant's entire lifecycle.





## Overview

The information listed here is mainly of a fundamental nature and applies regardless of the type and vendor of the electronic control system.

### Reliability

The reliability of devices and components is being driven as high as possible by employing extensive and cost-effective measures in development and production.

This includes

- Selection of high-quality components;
- Worst-case design calculation of all circuits;
- Systematic and computer-controlled testing of all subcontracted components;
- Burn-in of all large-scale integrated circuits (e.g. processors, memories etc.);
- Measures to prevent static charging when working at or with MOS circuits;
- Visual checks at various stages of production;
- In-circuit testing of all modules, i.e. computer-aided testing of all components and their interaction in the circuit;
- Hot endurance run at high ambient temperature over several days;
- Meticulous computer-controlled final testing;
- Statistical evaluation of all returns for immediate introduction of remedial actions.

These measures are regarded a basic measures in safety engineering. They prevent or keep control of the majority of potential faults.

### Risks

Wherever faults are liable to cause injury to persons or damage to property it is necessary to introduce measures aimed in particular at the safety of the plant and, therefore, of the control system. Special, plan-specific directives exist for these applications and need to be taken into account when configuring the control system.

In the case of safety-relevant electronic control systems the measures needing to be taken to prevent or keep control of faults are aimed at the risk presented by the plant. In such a case the basic measures listed above are no longer sufficient above a certain level of hazard potential. Additional measures have to be implemented and certified (e.g. dual-channel arrangements, tests, checksums etc.) for the control system.

## Division into a safe and a non-safe zone

In practically all plants there are parts which perform safety-related functions (e.g. emergency stop pushbuttons, mesh guards, two-hand controls). In order not to have to consider the complete control system in terms of safety engineering it is customary to divide the control system into a **safe** and a **non-safe** zone. No special requirements are imposed on the safety of the control system in the non-safe zone because there would be no impact on the safety of the plant if the electronics failed in this case. In the safe zone, on the other hand, you are only allowed to use control systems and/or circuits which satisfy the directives in question.

The following zonal divisions are customary in practice:

- Control systems with little safety engineering, e.g. machine control systems.
- Control systems with balanced zones, e.g. chemical plants, aerial ropeways.
- Control systems with mainly safety engineering, e.g. incineration plants.

### Important

Even if a maximum of design-based safety is achieved in the configuration of an electronic control systems – e.g. through multi-edge configuration – it is still essential to closely follow the instructions in the operating manuals as otherwise wrong actions may suspend precautions for preventing potential faults or may create additional sources of danger.

## Appendix

### Software Licenses

#### Overview

##### Software types

Software requiring a license is categorized into types. The following software types have been defined:

- Engineering software
- Runtime software

##### Engineering software

This includes all software products for creating (engineering) user software, e.g. for configuring, programming, parameterizing, testing, commissioning or servicing.

Data generated with engineering software and executable programs can be duplicated for your own use or for use by third parties free-of-charge.

##### Runtime software

This includes all software products required for plant/machine operation, e.g. operating system, basic system, system expansions, drivers, etc.

The duplication of the runtime software and executable programs created with the runtime software for your own use or for use by third-parties is subject to a charge.

You can find information about license fees according to use in the ordering data (e.g. in the catalog). Examples of categories of use include per CPU, per installation, per channel, per instance, per axis, per control loop, per variable, etc.

Information about extended rights of use for parameterization/configuration tools supplied as integral components of the scope of delivery can be found in the readme file supplied with the relevant product(s).

##### License types

Siemens Industry Automation & Drive Technologies offers various types of software license:

- Floating license
- Single license
- Rental license
- Rental floating license
- Trial license
- Demo license
- Demo floating license

##### Floating license

The software may be installed for internal use on any number of devices by the licensee. Only the concurrent user is licensed. The concurrent user is the person using the program. Use begins when the software is started. A license is required for each concurrent user.

##### Single license

Unlike the floating license, a single license permits only one installation of the software per license.

The type of use licensed is specified in the ordering data and in the Certificate of License (CoL). Types of use include for example per instance, per axis, per channel, etc.

One single license is required for each type of use defined.

##### Rental license

A rental license supports the "sporadic use" of engineering software. Once the license key has been installed, the software can be used for a specific period of time (the operating hours do not have to be consecutive).

One license is required for each installation of the software.

##### Rental floating license

The rental floating license corresponds to the rental license, except that a license is not required for each installation of the software. Rather, one license is required per object (for example, user or device).

##### Trial license

A trial license supports "short-term use" of the software in a non-productive context, e.g. for testing and evaluation purposes. It can be transferred to another license.

##### Demo license

The demo license support the "sporadic use" of engineering software in a non-productive context, for example, use for testing and evaluation purposes. It can be transferred to another license. After the installation of the license key, the software can be operated for a specific period of time, whereby usage can be interrupted as often as required.

One license is required per installation of the software.

##### Demo floating license

The demo floating license corresponds to the demo license, except that a license is not required for each installation of the software. Rather, one license is required per object (for example, user or device).

##### Certificate of license (CoL)

The CoL is the licensee's proof that the use of the software has been licensed by Siemens. A CoL is required for every type of use and must be kept in a safe place.

##### Downgrading

The licensee is permitted to use the software or an earlier version/release of the software, provided that the licensee owns such a version/release and its use is technically feasible.

##### Delivery versions

Software is constantly being updated. The following delivery versions

- PowerPack
- Upgrade

can be used to access updates.

Existing bug fixes are supplied with the ServicePack version.

##### PowerPack

PowerPacks can be used to upgrade to more powerful software. The licensee receives a new license agreement and CoL (Certificate of License) with the PowerPack. This CoL, together with the CoL for the original product, proves that the new software is licensed.

A separate PowerPack must be purchased for each original license of the software to be replaced.

**Overview****Upgrade**

An upgrade permits the use of a new version of the software on the condition that a license for a previous version of the product is already held.

The licensee receives a new license agreement and CoL with the upgrade. This CoL, together with the CoL for the previous product, proves that the new version is licensed. A separate upgrade must be purchased for each original license of the software to be upgraded.

**ServicePack**

ServicePacks are used to debug existing products. ServicePacks may be duplicated for use as prescribed according to the number of existing original licenses.

**License key**

Siemens Industry Automation & Drive Technologies supplies software products with and without license keys.

The license key serves as an electronic license stamp and is also the "switch" for activating the software (floating license, rental license, etc.).

The complete installation of software products requiring license keys includes the program to be licensed (the software) and the license key (which represents the license).

**Software Update Service**

The SIMATIC NET Software Update Service includes automatic delivery of the relevant updates of the SIMATIC NET PC software DVD, which is available following the signing of the contract.

The CD contains SIMATIC NET software for Industrial Ethernet, PROFINET, OPC server and PROFIBUS, so that your software is always up to date.

The following boundary conditions apply:

- The customer must already have a current software version, so an update/upgrade may be required beforehand.
- The update service is valid for one year following the date specified in the order.
- It shall be extended automatically for a further year, provided that it is not cancelled 3 months in advance by the customer or by the responsible Siemens partner.

When the contract is extended, the customer will be invoiced for the cost of a further year.

You can download explanations concerning license conditions from [www.siemens.com/automation/salesmaterial-as/catalog/en/terms\\_of\\_trade\\_en.pdf](http://www.siemens.com/automation/salesmaterial-as/catalog/en/terms_of_trade_en.pdf)

## Appendix

### Conditions of sale and delivery

#### 1. General Provisions

By using this catalog you can acquire hardware and software products described therein from Siemens AG subject to the following Terms and Conditions of Sale and Delivery (hereinafter referred to as "T&C"). Please note that the scope, the quality and the conditions for supplies and services, including software products, by any Siemens entity having a registered office outside Germany, shall be subject exclusively to the General Terms and Conditions of the respective Siemens entity. The following T&C apply exclusively for orders placed with Siemens Aktiengesellschaft, Germany.

##### 1.1 For customers with a seat or registered office in Germany

For customers with a seat or registered office in Germany, the following applies subordinate to the T&C:

- the "General Terms of Payment"<sup>1)</sup> and,
- for software products, the "General License Conditions for Software Products for Automation and Drives for Customers with a Seat or Registered Office in Germany"<sup>1)</sup> and,
- for other supplies and services, the "General Conditions for the Supply of Products and Services of the Electrical and Electronics Industry"<sup>1)</sup>.

##### 1.2 For customers with a seat or registered office outside Germany

For customers with a seat or registered office outside Germany, the following applies subordinate to the T&C:

- the "General Terms of Payment"<sup>1)</sup> and,
- for software products, the "General License Conditions for Software Products for Automation and Drives for Customers with a Seat or Registered Office outside of Germany"<sup>1)</sup> and
- for other supplies and/or services, the "General Conditions for Supplies of Siemens Industry for Customers with a Seat or Registered Office outside of Germany"<sup>1)</sup>.

#### 2. Prices

The prices are in € (Euro) ex point of delivery, exclusive of packaging.

The sales tax (value added tax) is not included in the prices. It shall be charged separately at the respective rate according to the applicable statutory legal regulations.

Prices are subject to change without prior notice. We will charge the prices valid at the time of delivery.

To compensate for variations in the price of raw materials (e.g. silver, copper, aluminum, lead, gold, dysprosium and neodym), surcharges are calculated on a daily basis using the so-called metal factor for products containing these raw materials. A surcharge for the respective raw material is calculated as a supplement to the price of a product if the basic official price of the raw material in question is exceeded.

The metal factor of a product indicates the basic official price (for those raw materials concerned) as of which the surcharges on the price of the product are applied, and with what method of calculation.

An exact explanation of the metal factor can be downloaded at: [www.siemens.com/automation/salesmaterial-as/catalog/en/terms\\_of\\_trade\\_en.pdf](http://www.siemens.com/automation/salesmaterial-as/catalog/en/terms_of_trade_en.pdf)

To calculate the surcharge (except in the cases of dysprosium and neodym), the official price from the day prior to that on which the order was received or the release order was effected is used.

To calculate the surcharge applicable to dysprosium and neodym ("rare earths"), the corresponding three-month basic average price in the quarter prior to that in which the order was received or the release order was effected is used with a one-month buffer (details on the calculation can be found in the explanation of the metal factor).

#### 3. Additional Terms and Conditions

The dimensions are in mm. In Germany, according to the German law on units in measuring technology, data in inches apply only to devices for export.

Illustrations are not binding.

Insofar as there are no remarks on the individual pages of this catalog - especially with regard to data, dimensions and weights given - these are subject to change without prior notice.

#### 4. Export regulations

We shall not be obligated to fulfill any agreement if such fulfillment is prevented by any impediments arising out of national or international foreign trade or customs requirements or any embargoes and/or other sanctions.

Export of goods listed in this catalog may be subject to licensing requirements. We will indicate in the delivery details whether licenses are required under German, European and US export lists. Goods labeled with "AL" not equal to "N" are subject to European or German export authorization when being exported out of the EU. Goods labeled with "ECCN" not equal to "N" are subject to US re-export authorization.

The export indications can be viewed in advance in the description of the respective goods on the Industry Mall, our online catalog system. Only the export labels "AL" and "ECCN" indicated on order confirmations, delivery notes and invoices are authoritative.

Even without a label, or with label "AL:N" or "ECCN:N", authorization may be required i .a. due to the final disposition and intended use of goods.

If you transfer goods (hardware and/or software and/or technology as well as corresponding documentation, regardless of the mode of provision) delivered by us or works and services (including all kinds of technical support) performed by us to a third party worldwide, you must comply with all applicable national and international (re-)export control regulations.

If required for the purpose of conducting export control checks, you (upon request by us) shall promptly provide us with all information pertaining to the particular end customer, final disposition and intended use of goods delivered by us respectively works and services provided by us, as well as to any export control restrictions existing in this relation.

The products listed in this catalog may be subject to European/German and/or US export regulations. Any export requiring approval is therefore subject to authorization by the relevant authorities.

Errors excepted and subject to change without prior notice.

1) The text of the Terms and Conditions of Siemens AG can be downloaded at [www.siemens.com/automation/salesmaterial-as/catalog/en/terms\\_of\\_trade\\_en.pdf](http://www.siemens.com/automation/salesmaterial-as/catalog/en/terms_of_trade_en.pdf)

Further information can be obtained from our branch offices listed at [www.siemens.com/automation/partner](http://www.siemens.com/automation/partner)**System Solutions for Industry  
Interactive Catalog on DVD**

Catalog

Products for Automation and Drives, Low-Voltage Power Distribution and Electrical Installation Technology **CA 01****Building Control**

GAMMA Building Control ET G1

**Drive Systems**

SINAMICS G130 Drive Converter Chassis Units	D 11
SINAMICS G150 Drive Converter Cabinet Units	
SINAMICS GM150, SINAMICS SM150 Medium-Voltage Converters	D 12
SINAMICS PERFECT HARMONY GH180 Medium-Voltage Air-Cooled Drives Germany Edition	D 15.1
SINAMICS G180 Converters – Compact Units, Cabinet Systems, Cabinet Units Air-Cooled and Liquid-Cooled	D 18.1
SINAMICS S120 Chassis Format Units and Cabinet Modules	D 21.3
SINAMICS S150 Converter Cabinet Units	
SINAMICS DCM DC Converter, Control Module	D 23.1
SINAMICS DCM Cabinet	D 23.2
SINAMICS and Motors for Single-Axis Drives	D 31
SINAMICS G120P and SINAMICS G120P Cabinet pump, fan, compressor converters	D 35
Three-Phase Induction Motors SIMOTICS HV, SIMOTICS TN	D 84.1
• Series H-compact	
• Series H-compact PLUS	
Asynchronous Motors Standardline	D 86.1
Synchronous Motors with Permanent-Magnet Technology, HT-direct	D 86.2
DC Motors	DA 12
SIMOREG DC MASTER 6RA70 Digital Chassis Converters	DA 21.1
SIMOREG K 6RA22 Analog Chassis Converters	DA 21.2
<i>Digital: SIMOREG DC MASTER 6RM70 Digital Converter Cabinet Units</i>	DA 22
SIMOVERT PM Modular Converter Systems	DA 45
SIEMOSYN Motors	DA 48
MICROMASTER 420/430/440 Inverters	DA 51.2
MICROMASTER 411/COMBIMASTER 411	DA 51.3
SIMODRIVE 611 universal and POSMO	DA 65.4

*Note: Additional catalogs on SIMODRIVE or SINAMICS drive systems and SIMOTICS motors with SINUMERIK and SIMOTION can be found under Motion Control*

Low-Voltage Three-Phase-Motors

SIMOTICS Low-Voltage Motors	D 81.1
SIMOTICS FD Flexible Duty Motors	D 81.8
LOHER Low-Voltage Motors	D 83.1
MOTOX Geared Motors	D 87.1
SIMOGEAR Geared Motors	MD 50.1
SIMOGEAR Gearboxes with adapter	MD 50.11

Mechanical Driving Machines

FLENDER Standard Couplings	MD 10.1
FLENDER High Performance Couplings	MD 10.2
FLENDER SIG Standard industrial gear unit	MD 30.1
FLENDER SIP Standard industrial planetary gear units	MD 31.1

**Process Instrumentation and Analytics**

Field Instruments for Process Automation	FI 01
<i>Digital: SIPART Controllers and Software</i>	MP 31
Products for Weighing Technology	WT 10
<i>Digital: Process Analytical Instruments</i>	PA 01
<i>Digital: Process Analytics, Components for the System Integration</i>	PA 11

*Digital: These catalogs are only available as a PDF.*

**Low-Voltage Power Distribution and  
Electrical Installation Technology**

Catalog

SENTRON · SIVACON · ALPHA Protection, Switching, Measuring and Monitoring Devices, Switchboards and Distribution Systems	LV 10
Standards-Compliant Components for Photovoltaic Plants	LV 11
3WT Air Circuit Breakers up to 4000 A	LV 35
3VT Molded Case Circuit Breakers up to 1600 A	LV 36
<i>Digital: SIVACON System Cubicles, System Lighting and System Air-Conditioning</i>	LV 50
<i>Digital: ALPHA Distribution Systems</i>	LV 51
ALPHA FIX Terminal Blocks	LV 52
SIVACON S4 Power Distribution Boards	LV 56
<i>Digital: SIVACON 8PS Busbar Trunking Systems</i>	LV 70
<i>Digital: DELTA Switches and Socket Outlets</i>	ET D1

**Motion Control**

SINUMERIK & SIMODRIVE Automation Systems for Machine Tools	NC 60
SINUMERIK & SINAMICS Equipment for Machine Tools	NC 61
SINUMERIK 840D sl Type 1B Equipment for Machine Tools	NC 62
SINUMERIK 808 Equipment for Machine Tools	NC 81.1
SINUMERIK 828 Equipment for Machine Tools	NC 82
SIMOTION, SINAMICS S120 & SIMOTICS Equipment for Production Machines	PM 21
Drive and Control Components for Cranes	CR 1

**Power Supply**

Power supply SITOP	KT 10.1
--------------------	---------

**Safety Integrated**

Safety Technology for Factory Automation	SI 10
--	-------

**SIMATIC HMI/PC-based Automation**

Human Machine Interface Systems/ PC-based Automation	ST 80/ ST PC
---	-----------------

**SIMATIC Ident**

Industrial Identification Systems	ID 10
-----------------------------------	-------

**SIMATIC Industrial Automation Systems**

Products for Totally Integrated Automation	ST 70
SIMATIC PCS 7 Process Control System System components	ST PCS 7
SIMATIC PCS 7 Process Control System Technology components	ST PCS 7 T
Add-ons for the SIMATIC PCS 7 Process Control System	ST PCS 7 AO

**SIMATIC NET**

Industrial Communication	IK PI
--------------------------	-------

**SIRIUS Industrial Controls**

SIRIUS Industrial Controls	IC 10
----------------------------	-------

**Information and Download Center**

Digital versions of the catalogs are available on the Internet at: [www.siemens.com/industry/infocenter](http://www.siemens.com/industry/infocenter)  
There you'll find additional catalogs in other languages.  
Please note the section "Downloading catalogs" on page "Online services" in the appendix of this catalog.

## Security information

Siemens provides products and solutions with industrial security functions that support the secure operation of plants, solutions, machines, equipment and/or networks. They are important components in a holistic industrial security concept. With this in mind, Siemens' products and solutions undergo continuous development. Siemens recommends strongly that you regularly check for product updates.

For the secure operation of Siemens products and solutions, it is necessary to take suitable preventive action (e.g. cell protection concept) and integrate each component into a holistic, state-of-the-art industrial security concept. Third-party products that may be in use should also be considered. For more information about industrial security, visit <http://www.siemens.com/industrialsecurity>.

To stay informed about product updates as they occur, sign up for a product-specific newsletter. For more information, visit <http://support.automation.siemens.com>.

Siemens AG  
Industry Sector  
Industry Automation Division  
Sensors and Communication  
Postfach 48 48  
90026 NÜRNBERG  
GERMANY

Subject to change without prior notice  
PDF (E86060-K6710-A101-B8-7600)  
Online version  
DR.PN.SC.14.XXKG.95.11  
KG 0814 1946 En  
Produced in Germany  
© Siemens AG 2014

The information provided in this catalog contains merely general descriptions or characteristics of performance which in case of actual use do not always apply as described or which may change as a result of further development of the products. An obligation to provide the respective characteristics shall only exist if expressly agreed in the terms of contract. Availability and technical specifications are subject to change without notice.  
All product designations may be trademarks or product names of Siemens AG or supplier companies whose use by third parties for their own purposes could violate the rights of the owners.